



This is a digital copy of a book that was preserved for generations on library shelves before it was carefully scanned by Google as part of a project to make the world's books discoverable online.

It has survived long enough for the copyright to expire and the book to enter the public domain. A public domain book is one that was never subject to copyright or whose legal copyright term has expired. Whether a book is in the public domain may vary country to country. Public domain books are our gateways to the past, representing a wealth of history, culture and knowledge that's often difficult to discover.

Marks, notations and other marginalia present in the original volume will appear in this file - a reminder of this book's long journey from the publisher to a library and finally to you.

Usage guidelines

Google is proud to partner with libraries to digitize public domain materials and make them widely accessible. Public domain books belong to the public and we are merely their custodians. Nevertheless, this work is expensive, so in order to keep providing this resource, we have taken steps to prevent abuse by commercial parties, including placing technical restrictions on automated querying.

We also ask that you:

- + *Make non-commercial use of the files* We designed Google Book Search for use by individuals, and we request that you use these files for personal, non-commercial purposes.
- + *Refrain from automated querying* Do not send automated queries of any sort to Google's system: If you are conducting research on machine translation, optical character recognition or other areas where access to a large amount of text is helpful, please contact us. We encourage the use of public domain materials for these purposes and may be able to help.
- + *Maintain attribution* The Google "watermark" you see on each file is essential for informing people about this project and helping them find additional materials through Google Book Search. Please do not remove it.
- + *Keep it legal* Whatever your use, remember that you are responsible for ensuring that what you are doing is legal. Do not assume that just because we believe a book is in the public domain for users in the United States, that the work is also in the public domain for users in other countries. Whether a book is still in copyright varies from country to country, and we can't offer guidance on whether any specific use of any specific book is allowed. Please do not assume that a book's appearance in Google Book Search means it can be used in any manner anywhere in the world. Copyright infringement liability can be quite severe.

About Google Book Search

Google's mission is to organize the world's information and to make it universally accessible and useful. Google Book Search helps readers discover the world's books while helping authors and publishers reach new audiences. You can search through the full text of this book on the web at <http://books.google.com/>

PROPERTY
OF
STATE HISTORICAL SOCIETY
OF WISCONSIN.

Purchased 1871

Transferred to the
LIBRARY OF THE
UNIVERSITY OF WISCONSIN

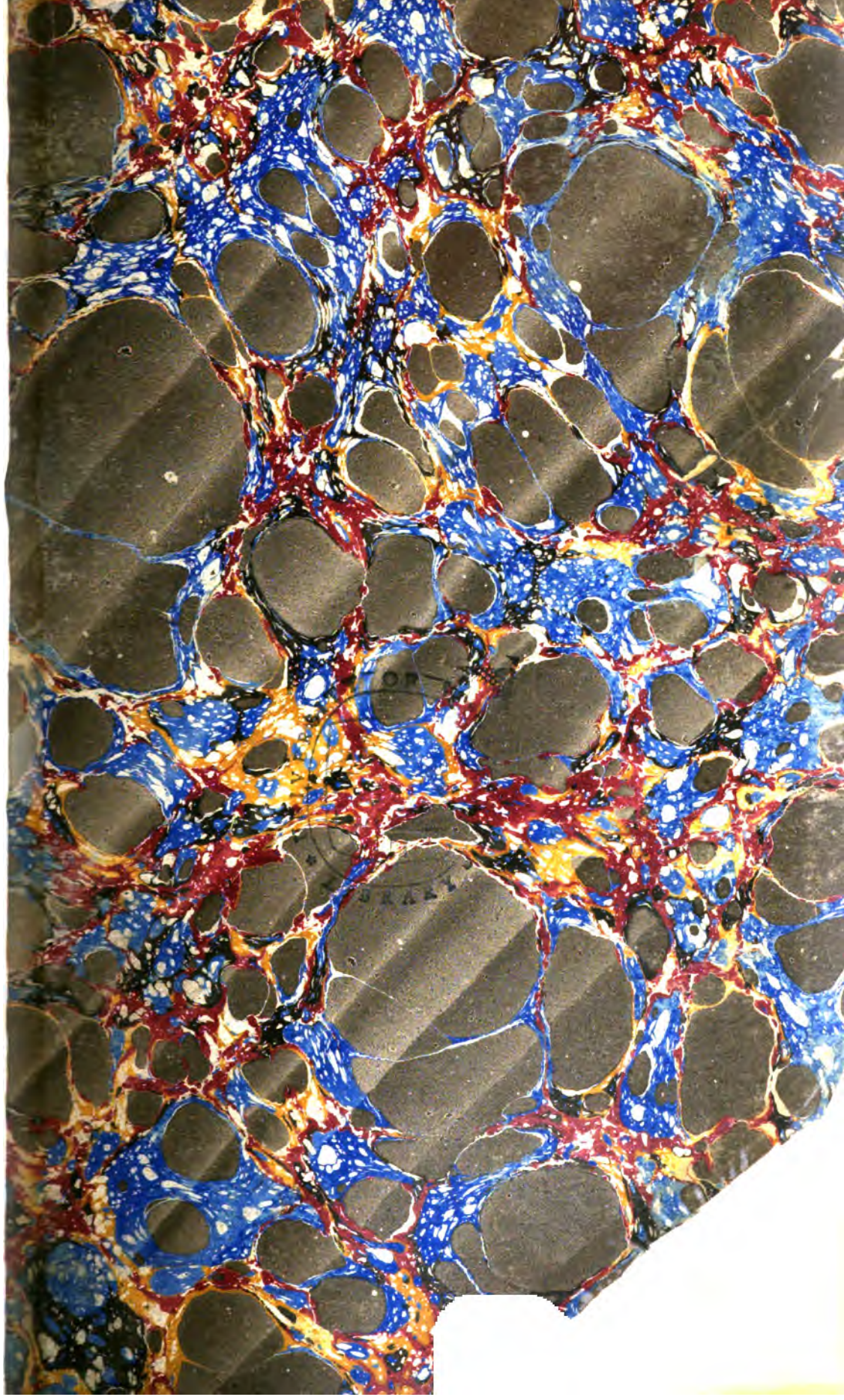



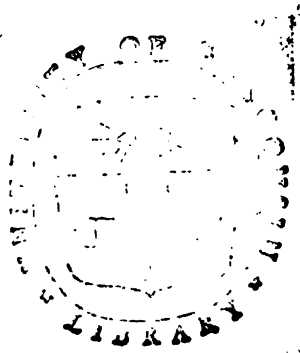

CHAMBERS'S
ENCYCLOPÆDIA



CHAMBERS'S
ENCYCLOPÆDIA

A DICTIONARY

OF UNIVERSAL KNOWLEDGE FOR THE PEOPLE

ILLUSTRATED

WITH MAPS AND NUMEROUS WOOD ENGRAVINGS

VOL. VI

TRANSYLVANIA
JOE W. LIBRARY

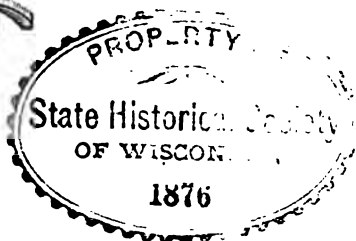

LONDON

W. AND R. CHAMBERS 47 PATERNOSTER ROW

AND HIGH STREET EDINBURGH

1868

WITH SUBSEQUENT CORRECTIONS

All Rights are reserved

LIST OF MAPS FOR VOL VI

THE NETHERLANDS,	PAGE 719
NEW ZEALAND,	741

AE
+ C94
6

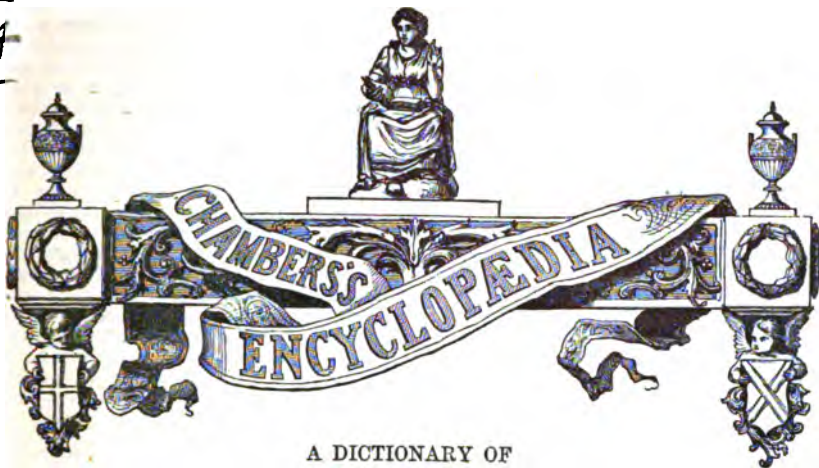

UNIVERSAL KNOWLEDGE FOR THE PEOPLE

LABRADOR—LABRIDÆ.

LABRADO'R (Port. *terra labrador*, 'cultivable land'), the name given by certain Portuguese discoverers to the continental coast of America near Newfoundland; a name as inappropriate as that of Greenland! The name gradually came to be extended from the Strait of Belleisle to Hudson's Strait, being sometimes carried as far westward as the eastern shores of Hudson's Bay. More properly, however, L. embraces only such portions of that vast peninsula as do not fall within the chartered territories of the Hudson's Bay Company (q. v.), by pouring water into Hudson's Strait or Hudson's Bay. In this restricted sense, the country stretches in N. lat. from about 52° to about 60°, and in W. long. from about 55° to upwards of 65°; area, 70,000 square miles; pop. 5000. Of this extensive country the interior is little known; but is understood to be mostly an impenetrable wilderness of swamps and forests. The maritime border, however (although its shores are wild and precipitous, reaching a height of from 400 to 600 feet, and on the north from 1000 to 1500 feet), is not without its value. The sea is here far less subject to fogs than it is in the neighbourhood of Newfoundland, where the warm waters of the Florida Stream meet the cold currents from the north; and as it is constantly supplied from the polar ice, its temperature is remarkably favourable both to the quantity and the quality of its fish. Of the entire population of L., 4000 are Esquimaux, who are settled on the gulfs and creeks of the coast, and who subsist chiefly by fishing. Many European establishments also have sprung up on the coast, some of them, such as the Moravian settlements, blending commercial pursuits with missionary labours. The principal missionary stations are Nain (founded 1771), Okak (1776), Hebron (1830), and Hopenthal (1782). The fisheries employ, in the season, nearly 1000 decked vessels, belonging partly to the British Provinces, principally Newfoundland, and partly to the United States. Besides a few furs and feathers, the exports consist of cod and salmon, with cod-oil

and seal-oil—the annual amount being estimated at fully £600,000 sterling. The climate, like that of North America generally, is subject to great vicissitudes. In summer, the thermometer ranges as high as 85° Fahr.; in winter, the temperature, and that in nearly the same latitudes as the British Isles, falls 30° below the freezing-point. L. is a dependency of the United Kingdom, but it has never had a separate government of its own, being considered sometimes as an appendage of Canada, and sometimes as an appendage of Newfoundland. It is at present believed to be in the latter position.

LA'BRADORITE, or **LABRADOR STONE**, a variety of Felspar (q. v.), common as a constituent of dolerite, greenstone, the gabbro, and hypersthene rocks. It consists of about 53 per cent. of silica, and 29 alumina, with 12 lime, and a little soda and peroxide of iron. It is cut into snuff-boxes and other articles; taking a fine polish, and often exhibiting rich colours, not unfrequently several in the same piece, when the light falls on it in particular directions; the general colour being gray. It was first discovered by the Moravian missionaries in the island of St Paul, on the coast of Labrador. It has been found in meteoric stones.

LA'BRIDÆ, a family of osseous fishes, ranked by Cuvier in the order *Acanthopterygii* (q. v.), by Müller in his new order, *Pharyngognathi* (q. v.). They are divided by Müller into two families, *Cteno-labridæ* and *Cyclo-labridæ*, the former having ctenoid, the latter, cycloid scales; the former comparatively a small, the latter, a very numerous family. They are generally oval or oblong, and more or less compressed, with a single dorsal fin, spinous in front, and the jaws covered by fleshy lips. Their colours are generally brilliant. They abound chiefly in tropical seas, but twelve or thirteen species are found on the British coasts, none of them large, nor esteemed for food. The most valuable of the family is the *Tautog* (q. v.) of North

America. To this family belong the Wrasces and the Parrot-fishes, one of which is the celebrated *Scarus* of the ancients.

LABRUYERE, JEAN DE, a French author of celebrity, particularly noted for his nice and delicate delineations of character. He was born at Dourdan, in Normandy, in 1644 or 1646, was brought to the French court at the recommendation of Bossuet, and became one of the tutors of the Dauphin, whose education Fenelon superintended. He spent the whole remainder of his life at court, in the enjoyment of a pension, and in the most intimate intercourse with the most accomplished men of his time. The work on which his high reputation rests, *Les Caractères de Théophraste, traduits du Grec, avec les Caractères ou les Mœurs de ce Siècle* (Par. 1687), has gone through many editions, some of them annotated, and has been translated into several languages.

LABUA'N, a member of the Malayan Archipelago, lies about thirty miles off the north-west coast of Borneo. It measures ten miles by five, and the latitude and longitude of its centre are 5° 22' N., and 115° 10' E. Small as it is, it is peculiarly valuable. Besides possessing a good harbour, it contains an extensive bed of excellent coal, which is worked by a recently formed company of British capitalists; and having become, in 1846, a British possession, it bids fair, as well from its political connection as from its natural advantages, to be a nucleus of civilisation for the whole of the surrounding islands. Already it has been erected into a see of the Church of England.

LABURNUM [*Cytisus* (q. v.) *Laburnum*], a small tree, a native of the Alps and other mountains of the south of Europe, much planted in shrubberies and pleasure-grounds in Britain, on account of its glossy foliage and its large pendulous racemes of yellow flowers, which are produced in great abundance in May and June. It is often mixed with lilac, and when the latter preponderates, the combination has a fine effect. In favourable circumstances, L. sometimes attains a height of twenty, or even forty feet. It is very hardy, and nowhere flourishes better than in the north of Scotland. It is of rapid growth, yet its wood is hard, fine-grained, and very heavy, of a dark-brown or dark-green colour, and much valued for cabinet-work, inlaying, and turnery, and for making knife-handles, musical instruments, &c. The leaves, bark, &c., and particularly the seeds, are nauseous and poisonous, containing *Cytisine*, an emetic, purgative, and narcotic principle, which is also found in many allied plants. Accidents from L. seeds are not unfrequent to children; but to hares and rabbits, L. is wholesome food, and they are so fond of it, that the safety of other trees in a young plantation may be insured by introducing L. plants in great number, which spring again from the roots when eaten down.—A fine variety of L., called SCOTCH L., by some botanists regarded as a distinct species (*C. Alpinus*), is distinguished by broader leaves and darker yellow flowers, which are produced later in the season than those of the common or *English* laburnum.

LA'BYRINTH (a word of unknown origin, derived by some from *Labaris*, the name of an Egyptian monarch of the twelfth dynasty), the name of some celebrated buildings of antiquity, consisting of many chambers or passages difficult to pass through without a guide, and the name hence applied to a confused mass of constructions. In the hieroglyphics, the word *mera* signifies a 'labyrinth.' The principal labyrinths of antiquity were

the Egyptian, the Cretan, and the Samian. The first, or Egyptian, of which the others seem to have been imitations, was situated at Crocodilopolis, close to the lake *Mœris*, in the vicinity of the present pyramid of Biakhmu. According to the classical authors, it was built by an Egyptian monarch named Petesuchis, Tithoes, Imandes, Ismandes, Maindes, or Mendes. The recent discovery of the remains of this building by Lepsius has, however, shewn that the city was founded by Amenemba I., of the twelfth Egyptian dynasty, about 1800 B.C., and that this monarch was probably buried in it, while the pyramid and south temple were erected by Amenemba III. and IV., whose prænomen resemble the name of Mœris, and their sister, Sebeknefru or Soemiophris, appears to have been the last sovereign of the twelfth dynasty. Great confusion prevails in the ancient authorities as to the object of the building, which contained twelve palaces under one roof, supposed to have been inhabited by the Dodecarchy, or twelve kings who conjointly reigned over Egypt before Psammetichus I.; while, according to other authorities, it was the place of assembly of the governors of the nomes or districts, twelve in number according to Herodotus, sixteen according to Pliny, and twenty-seven according to Strabo. It was built of polished stone, with many chambers and passages, said to be vaulted, having a peristyle court with 3000 chambers, half of which were under the earth, and the others above ground, which formed another story. The upper chambers were decorated with reliefs; the lower were plain, and contained, according to tradition, the bodies of the twelve founders of the building, and the mummies of the sacred crocodiles, conferring on the building the character of a mausoleum, probably conjoined with a temple, that of Sebak, the crocodile-god, and so resembling the Serapeum. Herodotus and Strabo both visited this edifice, which was difficult to pass through without the aid of a guide. It stood in the midst of a great square. Part was constructed of Parian marble—probably rather arragonite—and of Syenitic granite pillars; had a staircase of ninety steps, and columns of porphyry; and the opening of the doors echoed like the reverberation of thunder. For a long time, great doubt prevailed whether any remains of the building existed, and it was supposed to have been overwhelmed by the waters of the lake Mœris; and although P. Lucas and Letronne thought they had discovered the site, its rediscovery is due to Lepsius, who found part of the foundations or lower chambers close to the site of the old Mœris Lake, or modern Birket-el-Keroun. According to Pliny, it was 3600 years old in his days.

The second, or next in renown to the Egyptian, was the labyrinth of Crete, supposed to have been built by Dædalus for the Cretan monarch Minos, in which the Minotaur was imprisoned by his orders. Although represented on the Cretan coins of Cnossus sometimes of a square, and at other times of a circular form, no remains of it were to be found even in times of antiquity, and its existence was supposed to be fabulous. The only mode of finding the way out of it was by means of a hank or skein of linen thread, which gave the clue to the dwelling of the Minotaur. The tradition is supposed to have been based on the existence of certain natural caves or grottoes, perhaps the remains of quarries, and it has been supposed to have existed north-west of the island, near Cnossus, while a kind of natural labyrinth still remains close to Gortyna. The idea is supposed to have been derived from the Egyptian.

The third of the labyrinths of antiquity was the Samian, constructed by Theodorus and artists of

LABYRINTHODON—LAC.

his school, in the age of Polycrates (540 B. C.), supposed to be a work of nature embellished by art, having 160 columns erected by a clever mechanical contrivance.—Other inferior labyrinths existed at Nauplia, at Sipontum in Italy, at Val d'Ispica in Sicily, and elsewhere; and the name of labyrinth was applied to the subterraneous chambers of the tomb of Porsena, supposed to be that now existing as the Poggio Gazella, near Chiusi. Labyrinths called mazes were at one time fashionable in gardening, being imitations, by hedges or borders, of the Cretan; the best known in modern times being the Maze at Hampton Court.

Herodotus, ii. 148; Diodorus, i. 61, 97, iv. 60, 77; Pausanias, i. 27; Strabo, x. 477, xviii. 111; Plutarch, *Thesæus*, 15; Pliny, *N. H.*, xxvi. 19, 3, 83; Isidorus, *Orig.*, xv. 2, 6; Höck, *Creta*, i. 447; Prokesch, *Denta*, i. 806; Duc de Luynes, *Annals*, 1829, 364; Lepsius, *Einleit.*, p. 268.

LABYRINTHODON, a genus of gigantic sauroid batrachians, found in the New Red Sandstone measures of Great Britain and the continent. The remains of several species have been described, but all so fragmentary, that no certain restoration of the genus can yet be made. The head was triangular,

teeth in front. The bases of the teeth were anchored to distinct shallow sockets. Externally, they were marked by a series of longitudinal grooves, which correspond to the inflected folds of the cement. The peculiar and characteristic internal structure of the teeth is very remarkable, and to it these fossils owe their generally accepted generic name of Labyrinthodon (labyrinth-tooth). The few and fragmentary bones of the body of the animal exhibit a combination of batrachian and crocodilian characters, leaning, however, on the whole, more to the first type. The restoration exhibited in the wood-cut is that suggested by Owen; it must be considered as to a large extent imaginary, owing to the imperfect materials for such a work. In the same deposits there have been long noticed the prints of feet, which so much resembled the form of the human hand, that Kaup, their original describer, gave the generic name of Cheirotherium to the great unknown animals which produced them. From the fore being much smaller than the hind foot, he considered that they were the impressions of a marsupial; but this relative difference in the feet exists also in the modern batrachians; and the discovery of the remains of so many huge animals

belonging to this order, in these very strata, the different sizes of which answer to the different footprints, leave little doubt that the cheirotherian footprints were produced by labyrinthodont reptiles.

LAC, in the East Indies, signifies a sum of 100,000 rupees. A lac of *Company's Rupees* is equal to £9270 sterling; a lac of *Sicca Rupees*, which in some places are also in very general use, is equal to £9898 sterling. One hundred lacs, or ten millions of rupees, make a *Crore*.

LAC, the general name under which the various products of the lac insect (*Coccus lacca*) are known. The curious hemipterous insect which yields these valuable contributions to commerce is in many respects like its congener the Cochineal Insect (*Coccus cacti*), but it also differs essentially from it: the males alone, and those only in their last stage of development, have wings, therefore the whole life of the creature is spent almost on the same spot. They live upon the twigs of trees, chiefly species of *Butea*, *Ficus*, and *Croton*, and soon entomb themselves in a mass of matter, which oozes from small punctures made in the twigs of the tree, and which thus furnishes them with both food and shelter. It is said that to each male there are at least 5000 females, and the winged males are at least twice as large as the females. When a colony, consisting of a few adult females and one or two males, find their way to a new branch, they attach themselves to the bark, and having pierced it with holes, through which they draw up the resinous juices upon which they feed, they become fixed or glued by the superfluous excretion, and after a time die, forming by their dead bodies little domes or tents over the myriads of minute eggs which they have laid. In a short time, the eggs burst into life, and the young, which are very minute, eat their way through the dead bodies of their parents, and swarm all over the twig or small young branch of the tree in such countless numbers as to give it the appearance of being covered with a blood-red dust. They soon spread to all parts of the tree where the bark is tender enough to afford them food, and generation after generation dwells upon the same twig until it is enveloped in a coating, often half an inch in thickness, of the resinous exudation, which is very cellular throughout, the cells being the casts of the bodies of the dead females. During their lifetime, they secrete a beautiful purple colouring matter, which does not perish with them, but



Labyrinthodon Paehygnatus.

having a crocodilian appearance both in the shape and in the external sculpturing of the cranial bones, but with well marked structural modifications in the vomer, and in the mode of attachment of the head to the atlas, that stamp it with a batrachian character, conspicuous above the more apparent



Footprint and Rain-drops.

saurian resemblances. The mouth was furnished with a series of remarkable teeth, numerous and small in the lateral rows, and with six great laniary

remains shut up in the cells with the other results of decomposition.

The small twigs, when well covered, are gathered by the natives, and are placed in hot water, which melts the resinous matter, liberates the pieces of wood and the remains of the insects, and also dissolves the colouring matter. This is facilitated by kneading the melted resin whilst in the hot water; it is then taken out and dried, and is afterwards put into strong and very coarse cotton bags, which are held near enough to charcoal fires to melt the resin without burning the bags. By twisting the bags, the melted resin is then forced through the fabric, and received in thin curtain-like films upon strips of wood. This hardens as its surface becomes acted upon by the air, and being broken off in fragments, constitutes the shell-lac of commerce. The best shell-lac is that which is most completely freed from impurities, and approaches most to a light orange brown colour. If the colouring matter has not been well washed out, the resin is often very dark, consequently, we find the following varieties in commerce—orange, garnet, and liver. Much that is squeezed through the bags falls to the ground without touching the sticks placed to catch it; small quantities falling form button-like drops, which constitute the *button-lac*; whilst larger ones, from an inch to two or three inches in diameter, constitute the *plate-lac* of commerce. That known as *stick-lac* is the twigs as they are gathered, but broken short for the convenience of packing.

Below the lac-bearing trees there is always a very considerable quantity of the resin in small particles, which have been detached by the wind shaking and chafing the branches; this also is collected, and constitutes the seed-lac of our merchants.

The water in which the stick-lac is first softened contains, as before mentioned, the colouring matter of the dead insect. This is strained and evaporated until the residue is a purple sediment, which, when sufficiently dried, is cut in small cakes, about two inches square, and stamped with certain trade-marks, indicating its quality. These are then fully dried, and packed for sale as *lac-dye*, of which large quantities are used in the production of scarlet cloth, such as that worn by our soldiers; for this purpose, lac-dye is found very suitable.

The lac insect is a native of Siam, Assam, Burmah, Bengal, and Malabar; the lacs and lac-dye come chiefly from Bombay, Fegu, and Siam. During the last two or three years, the average imports into Britain have amounted to about 610 tons of the lac-dye, and 1120 tons of lac, including the varieties of shell, stick, and seed lac.

As we have no strictly analogous resin from the vegetable kingdom, not even from the lac-bearing trees, it may be assumed that the juices of the trees are somewhat altered by the insects. The best analyses shew that shell-lac contains several peculiar resins. The great value of the lacs is found in their adaptability for the manufacture of varnishes, both in consequence of their easy solubility, and also because of the fine hard coating, susceptible of high polish, which they give when dry. The well-known 'French polish' is little more than shell-lac dissolved in alcohol; and a fine thin varnish made of this material constitutes the lacquer with which brass and other metals are coated, to preserve their polish from atmospheric action.

All the varieties of lac are translucent, and some of the finer kinds, which are in flakes not much thicker than writing-paper, are quite transparent, and all, as before stated, are coloured various shades of brown, from orange to liver. Nevertheless, if a quantity of shell-lac be softened by heat, it may,

by continually drawing it out into lengths, and twisting it, be made not only quite white, but also opaque; in this state it has a beautiful silky lustre; and if melted and mixed with vermilion, or any other colouring matter, it forms some of the fancy kinds of sealing-wax: the more usual kinds are, however, made by merely melting shell-lac with a little turpentine and camphor, and mixing the colouring matter. Shell-lac has the property of being less brittle after the first melting than after subsequent meltings; hence the sealing-wax manufactured in India has always had a high reputation, and hence also the extreme beauty and durability of those Chinese works of art in lac, some of which are very ancient. These are usually chow-chow boxes, tea-basins, or other small objects made in wood or metal, and covered over with a crust of lac, coloured with vermilion, which, whilst soft, is moulded into beautiful patterns. So rare and beautiful are some of these works, that even in China they cost almost fabulous prices.

LACCADIVES (called by the natives *Lakara-Divh*, i.e., the Lakara Islands), a group of islands in the Arabian Sea, discovered by Vasco de Gama in 1499, lie about 150 miles to the west of the Malabar coast of the peninsula of Hindustan. They extend in N. lat. between 10° and 12°, and in E. long. between 72° and 74°, and are 17 in number. Being of coral formation, they are generally low, with deep water immediately round them, and are therefore all the more dangerous to navigators. Pop. 7000; chief productions cocoa, rice, betel-nuts, sweet potatoes, and cattle of a small breed. The inhabitants, who are called *Moplays*, are of Arabian origin, and in religion follow a sort of Moham-medanism. They pay tribute, said to be about £1000 a year, to the district of Cananore, in the presidency of Madras.

LACE, an ornamental fabric of linen, cotton, or silk thread, made either by the hands, somewhat after the manner of embroidery, or with machinery. The manufacture of lace by hand is an operation of exceeding nicety, and requires both skill and patience of no ordinary kind, and the best productions of this fabric surpass all other applications of textile materials in costliness and beauty.

Whether the ancients really had any knowledge of lace-making, excepting gold-lace, which will be mentioned at the end of this article, is not known, nor is it known with any certainty when this art came into practice in Europe; but there is good reason to suppose that *point-lace*, the oldest variety known, was the work of nuns during the latter half of the 14th and the beginning of the 15th centuries. This point-lace is very characteristic, and is truly an art production. The artistic character of the patterns, and the wonderful patience and labour shewn in carrying them out, places them, as female productions, on a parallel with the decorative works in stone, wood, and metal of the monks. They indicate no tiresome efforts to copy natural objects, but masterly conceptions of graceful forms and tasteful combinations. The actual figures of the pattern were cut out of linen, and over these foundation-pieces, as they may be called, the actual lace-work was wrought by the needle, with thread of marvellous fineness, and with such consummate art, that the material of the foundation is quite undiscoverable under the fairy-like web which has been woven over it. These portions of the fabric were then joined together by connecting threads, each of which, like the broader parts, consists of a foundation, and lace-work covering; the former being a mere thread, often of exceedingly fine yarn; the latter being a sort of loop-work like the modern

crochet (fig. 1). The wonderful durability of point-lace is attested by the fact, that it is not uncommon in our most choice collections, although the art is supposed to have been lost about the beginning of the 16th c., when a more easily made, and consequently cheaper style of point-lace, displaced the older and more artistic kind.

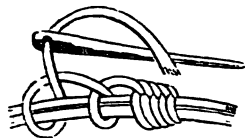

Fig. 1.

The point-lace of the second period, though always very beautiful, was deficient in solidity and in purity of design; moreover, it bears indications of having been copied from patterns, whilst the older kind was evidently the carrying out of artistic thoughts, as they were conceived, in the original material, the worker and the designer being the same person. It was during this period that the pillow was first used, and it is most probable that the use of patterns led to the application of the pillow. First, the lace would be worked on the pattern, to insure correctness, where the worker was merely a copyist; then it would soon become evident that if the pattern were so arranged as to avoid shifting, the facilities of working would be greatly increased; and it has been suggested that the pattern pinned to the pillow, and the threads twisted round the pins, to prevent ravelling when not in use, suggested the net-work which afterwards became a leading feature in the fabric.

The invention of pillow-lace has been claimed by Beckmann, in his quaint way, for one of his countrywomen. He says: 'I will venture to assert that the knitting of lace is a German invention, first known about the middle of the 16th c.; and I shall consider as true, until it be fully contradicted, the account given us that this art was found out before 1561, at St Annaberg, by Barbara, wife of Christopher Uttmann. This woman died in the 61st year of her age, after she had seen sixty-four children and grandchildren; and that she was the inventress of this art is unanimously affirmed by all the annalists of Saxony.' Whether she invented, or merely introduced the art, cannot now be proved, but certain it is, that it soon became settled in Saxony, and spread thence to the Netherlands and France. Even to the present day, we occasionally hear of 'Saxon bone-lace,' a name which was given to indicate the use of bone-pins, before the introduction of the common brass ones.

It will readily be supposed that an art depending so much on individual skill and taste, would be likely to vary exceedingly; nevertheless, all the varieties resolve themselves into few well-marked groups, under three distinct classes. The first class is the *Guipure*, which comprises all the true needle-worked lace, whether ancient or modern; its varieties are—*Rose-point*, in which the figures are in high relief, having a rich embossed appearance; *Venetian-point*, *Portuguese-point*, *Maltese-point*: in all of these the pattern is flatter than in the *Rose-point*, *Point d'Alençon*, and *Brussels-point*. The last two are still made, the modern *Point d'Alençon* quite equalling in beauty and value that made in the middle of the 17th c., when its manufacture was introduced by the celebrated Colbert, chief minister of Louis XIV. The *Point d'Alençon* has very distinctive characteristics. When the pattern is once designed, each portion may be worked by a separate person, and the various figures are then connected by a groundwork of threads, which are so passed from one figure to another as to represent a web of wonderful delicacy and regularity: small spots or other figures are here and there skilfully worked

in where the threads cross each other; these are called *modes*, and not only add much to the strength of the fabric, but greatly increase its richness of effect. In all these varieties, but two kinds of stitches are employed, and these differ chiefly in the greater or less closeness of the threads employed. First, a series of threads are laid down all in one direction, so as to cover the pattern, and then a certain number of these are taken up and covered by loops of the cross-stitches, as in fig. 1, or are more lightly held together, as in fig. 2.

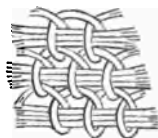

Fig. 2.

The second class is *Pillow-lace*, sometimes called *Cushion* or *Bobbin lace*, from the pillow or cushion being used to work the pattern upon, and the various threads of which the figures are made up, each being wound upon a bobbin, usually of an ornamental character, to distinguish one from the other. The pattern on parchment or paper, being attached to the *pillow* or cushion, pins are stuck in at regular intervals in the lines of the pattern, and the threads of the bobbins are twisted or plaited round them so

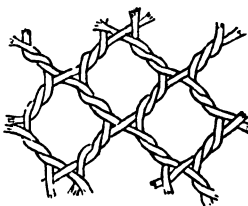

Fig. 3.

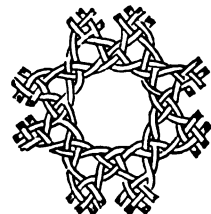

Fig. 4.

as to form the net-work arrangement which is characteristic of this class of lace (figs. 3 and 4), the patterns, or figured portions, being worked out by a crossing of threads, which, although actually plaiting, gives the effect of weaving, as in fig. 5. The varieties of this lace are—*Spanish*, *Grounded Spanish*, *Saxony Brussels*, *Flemish Brussels*, *Mechlin*, *Valenciennes*, *Dutch*, *Lisle*, *Chantilly*, *Silk and Cotton Blonde*, *Limerick*, *Buckinghamshire*, and *Honiton*. The last has of late years become the most beautiful of all the varieties made in Great Britain. The Irish or Limerick lace has also taken a high position.



Fig. 5.

The third class is machine-made lace, which, by its wonderful improvement and rapid development, has worked a complete revolution in the lace-trade, so that the prices formerly obtained for hand-made lace can no longer be commanded, whilst machine lace, of great beauty, has become so cheap and plentiful as to be worn by all classes. It has been mentioned before that the use of the pillow led to the introduction of net as the ground-work for lace figures, and it was to the manufacture of this so-called *bobbin-net* that the machinery was first applied (see *BOBBIN-NET*). The figure in the article referred to indicates very satisfactorily the structure of net. The lace-machine, or *frame*, as it is technically called, is so complicated, that it would be hopeless to convey any really intelligible description of it without a voluminous description of all its parts. One or two points of chief importance may, however, remove any difficulty in understanding its general principles. First, then, as in the loom (see *Loom*), there is a series of warp-threads, placed, however, perpendicularly instead of horizontally, and not so close as in ordinary weaving, the space

between each being sufficiently wide to admit of a shilling passing edgeways between them. Behind these threads, and corresponding to the interspaces, is a row of ingeniously constructed flat bobbins or reels resting in an arrangement called a *comb-bar* or *bolt-bar*. These are so placed, that with the first movement of the machine, each bobbin, which carries its thread with it, passes through two of the parallel and perpendicular threads of the warp, and is lodged in another and similar bolt-bar in front of the warp. But this front bolt bar, besides an advancing and receding motion, has another movement, called *shogging*—from right to left. When it receives a bobbin by its forward motion, it draws back, bringing the bobbin and thread through two of the upright threads; it then *shogs* or moves to one side, and goes forward again, taking the thread through the next two warp-threads, and lodging the bobbin on the back bolt-bar again, one distance beyond its last space; this it recovers by the next movement, and it again passes through the first space, to be again received by the front bolt-bar. By these movements, the bobbin-thread is twisted quite round one upright thread of the warp; another movement then shifts the bobbin, so that it will pass through the next pair of upright threads, and so carry on its work, the warp-threads moving at the same time, unwinding from the lower beam, and being rolled on the upper one. There being twice as many bobbins as there are threads in the warp, each bolt-bar having a set which it exchanges with the other, and all being regulated with great nicety, a width of lace is made in far less time than has been required to write this short description. The various additions to, and variations upon, these operations, which only apply to bobbin-net, for the production of patterns, are so numerous and complicated—each pattern requiring new complications—that it will be useless attempting to describe them; suffice it to say, they all depend upon the variations which can be given to the movements of the flat, disc-like bobbins.

The history of the lace-machine is not very clear; it is said to have been originally invented by a *frame-work* knitter of Nottingham, from studying the lace on his wife's cap; but it has been continually receiving improvements, amongst which those of Heathcote in 1809—the first to work successfully—Morley, in 1811 and 1824, and those of Leaver and Turton, and of Clark and Marl, both in 1811. The manufacture of lace by machinery is chiefly located in Nottingham, whence it is sent to all parts of the world; but we have no means of knowing to what extent, for, with that strange perversity which distinguishes our statistical administration, only *thread-lace* is mentioned in the lists of exports, whilst our vast production of cotton-lace is mixed up with the returns of calico and other fabrics of that material.

Gold-lace and *Silver-lace*, properly speaking, are laces woven, either by the hand or by machinery, from exceedingly fine threads of the metals, or from linen, silk, or cotton threads which are coated with still finer threads of gold or silver; but in this country it is too common to designate as gold or silver lace, not only that which is rightly so-called, but also fringe made of these materials, and also gold and silver embroidery, such as is seen on state robes and trappings, and upon some ecclesiastical dresses, &c. Gold-lace is made in London, but considerable quantities of that used for decorating uniforms and other dresses, &c., in this country, is obtained from Belgium, where it is an important branch of manufacture. France supplies much of the gold and silver thread used, and excels all other countries in its production, in some of the more artistic varieties of gold and silver lace and embroidery. Italy has lately shewn great taste and skill. The works

of Luigi Martini of Milan have in this respect attained great celebrity, and are said to produce about £16,000 worth per annum.

LACE-BARK TREE (*Lagetta lintearia*), a tree of the natural order *Thymeleaceae*, a native of the West Indies. It is a lofty tree, with ovate, entire, smooth leaves, and white flowers. It is remarkable for the tenacity of the fibres of its inner bark, and the readiness with which the inner bark may be separated, after maceration in water, into layers resembling lace. A governor of Jamaica is said to have presented to Charles II. a cravat, frill, and ruffles made of it.

LACE-LEAF. See LATTICE LEAF.

LACÉPÈDE, BERNARD GERMAIN ÉTIENNE DE LAVILLE, COMTE DE, an eminent naturalist and elegant writer, was born of a noble family, 26th December 1756, at Agen. Having early devoted himself to the study of natural history, in which he was greatly encouraged by the friendship of Buffon, he was appointed curator of the Cabinet of Natural History in the Royal Gardens at Paris. This office he held till the Revolution, when he became Professor of Natural History, and also entered upon a political career, in which he rose to be a senator in 1799, a minister of state in 1809, and, after the return of the Bourbons, a peer of France, although he had previously been one of the most zealous adherents of Bonaparte. He died of small-pox at his mansion of Epinay, near St Denis, 6th October 1825. A collective edition of his works was published in 1826. Among them are works on the Natural History of Reptiles, of Fishes, and of the Cetacea, a Work on the Natural History of Man, and one entitled *Les Ages de la Nature*. His work on Fishes (5 vols. 1798—1803) is the greatest of his works, and was long unrivalled in that department of zoology, although it has now been in a great measure superseded. L. was a highly accomplished musician, was the author of a work entitled *La Poétique de la Musique* (2 vols. 1785), and of two romances intended to illustrate social and moral principles. He was an amiable man, extremely kind, delighting in domestic life, and very simple, and almost abstemious, in his habits.

LACERTA and **LACERTIDÆ.** See LIZARD.

LACHAISE, FRANCIS D'AIX DE, a Jesuit, born of a noble family, 25th August 1624, in the castle of Aix, now in the department of Loire, was a provincial of his order, when Louis XIV. selected him for his confessor on the death of Father Ferrier in 1675. His position was one of great difficulty, owing to the different parties of the court, and the strife between Jansenists and Jesuits. In the most important questions of his time, Father L. avoided extreme courses. A zealous Jesuit, and of moderate abilities, he yet sustained among his contemporaries the reputation of a man of mild, simple, honourable character. Madame Maintenon could never forgive him the little zeal with which he opposed the reasons urged against the publication of her marriage with the king; but during the thirty-four years that he filled his office of confessor, he never lost the favour of the king. He was a man of some learning, and fond of antiquarian pursuits. He died 20th January 1709.—Louis XIV. built him a country-house to the west of Paris, the large garden of which was in 1804 converted into a burial-place, and is known as the *Père-la-Chaise*.

LACHES, in English Law, is a word used (from Fr. *lâcher*, to loosen) to denote negligence or undue delay, such as to disentitle a party to a particular remedy, or to relief. In Scotland, the word *mora* is often used to denote undue delay.

LA'CHESIS, a genus of serpents of the Rattlesnake family (*Crotalidae*), but differing from rattlesnakes in having the tail terminated with a spine instead of a rattle, and in having the head covered with scales, and not with plates. The species are all natives of the warm parts of America, where some of them are among the most dreaded of venomous serpents. They are usually seen coiled up, with keen glaring eyes, watching for prey, on which they dart with the swiftness of an arrow, and then coiling themselves up again, wait quietly till the death-struggle of the victim is over. Some of them attain the length of seven feet. They are said to be apt to attack men, even when not attacked or threatened.

LA'CHLAN, a river of East Australia, rises in New South Wales, to the westward of the Blue Mountains, and, after a course of 400 miles, with the characteristics of the Darling (q. v.) on a smaller scale, joins the Murrumbidgee, which itself, a little further down, enters the Murray. The former of these two points of confluence is in lat. 34° 30' S., and long. 144° 10' E.

LACHMANN, KARL, a celebrated German critic and philologist, was born 4th March 1793, at Brunswick, studied at Leipzig and Göttingen, became a professor in the university of Königsberg in 1816, and at Berlin in 1827. He died 13th March 1851. L.'s literary activity was extraordinary. He was equally devoted to classical subjects and to those of old German literature, and illustrated both by a profound and sagacious criticism. Among his most important productions are his editions of the *Nibelungenlied*, the works of Walter von der Vogelweide, Propertius, Catullus, Tibullus, and the New Testament (Berl. 1831; 3d edit. 1846), of which a larger edition, with the Vulgate translation, appeared in 2 vols. (Berl. 1846 and 1850). The design of the last of these works was to restore the Greek text as it existed in the Eastern Church in the 3d and 4th centuries. It is considered, on the whole, the best edition of the Greek Testament that has yet been published.

LA'CHRYMÆ CHRISTI, a muscatel wine of a sweet but piquant taste, and a most agreeable bouquet, which is produced from the grapes of Mount Somma, near Vesuvius. There are two kinds, the white and the red, the first being generally preferred. The demand for this wine being greater than the supply, large quantities of the produce of Pozzuoli, Istria, and Nola are sold under this name. A similar wine is produced in many islands of the Archipelago, as Candia, Cyprus, &c.

LA'CHRYMAL ORGANS, THE, are sufficiently described in the article EYE. There are, however, certain diseases to which they are liable, which require a brief notice.

There may be a deficient secretion of tears, an affection for which the term *Xerophthalmia* has been invented. It may be palliated by keeping the cornea constantly moist with glycerine by means of an eyecup. Or there may be an over-secretion of tears, so that they run down the cheeks. This affection is termed *Epiphora*, and must not be confounded with the *Stillicidium lachrymarum*, or overflow of tears that arises from an obstruction of the channels through which they pass into the nose. It is common in scrofulous children, and should be treated with gentle aperients, such as rhubarb combined with

bicarbonate of soda, and tonics, such as the citrate of iron and quinine.

Obstruction of the nasal duct is generally caused by a thickening of the mucous membrane that lines it, and is a not uncommon affection, especially in scrofulous young persons. There is a feeling of weakness of the eye on the affected side, and tears run down the cheek, while the nostril on that side is unnaturally dry. The lachrymal sac (see fig. 6 in the article EYE) is distended with tears, and forms a small tumour by the side of the root of the nose. On pressing this tumour, tears and mucus can be squeezed backwards through the puncta, or downwards into the nose, if the closure is only partial. This affection often leads to *inflammation of the sac*, or to the formation of a fistulous aperture at the inner corner of the eye, communicating with the lachrymal sac, and known as *Fistula Lachrymalis*. This fistulous aperture is caused by the bursting of an abscess, arising from inflammation of the sac. It is generally surrounded by fungous granulations (popularly known as *provid flesh*), and the adjacent skin is red and thickened from the irritation caused by the flow of tears. In these cases, the sac must be opened by a puncture, and a style (a silver probe about an inch long, with a head like a nail) should be pushed through the duct into the nose. The retention of this instrument causes the duct to dilate, so that the tears flow by its side. The flat head of the style lies on the cheek, and both keeps the instrument in its place and facilitates its occasional removal for the purpose of cleansing. Sometimes it is necessary that the instrument should be worn for life, but in less severe cases the duct remains permanently dilated, and a cure is effected in a few months.

LACO'NIC. The Spartans, or Lacedæmonians (whose country was called Laconia), systematically endeavoured to confine themselves to a sententious brevity in speaking and writing; hence the term *laconic* has been applied to this style.

LACORDAIRE, JEAN-BAPTISTE-HENRI, the most distinguished of the modern pulpit-orators of France, was born at Recey-sur-Orce, in the department Côte-d'or, March 12, 1802. He was educated at Dijon, where he also entered upon his legal studies; and having taken his degree, he transferred himself in 1822 to Paris, where he began to practise as an advocate in 1824, and rose rapidly to distinction. As his principles at this period were deeply tinged with unbelief, it was a matter of universal surprise in the circle of his acquaintance that he suddenly gave up his profession, entered the College of St Sulpice, and in 1827 received holy orders. He soon became distinguished as a preacher, and in the College of Juilly, to which he was attached, he formed the acquaintance of the Abbé Lamennais, with whom he speedily formed a close and intimate alliance, and in conjunction with whom, after the revolution of July, he published the well-known journal, the *Avenir*, an organ at once of the highest church principles and of the most extreme radicalism. The articles published in this journal, and the proceedings which were adopted in asserting the liberty of education, led to a prosecution in the Chamber of Peers in 1831; and when the *Avenir* itself was condemned by Gregory XVI., L. formally submitted, and for a time withdrawing from public affairs, devoted himself to the duties of the pulpit. The brilliancy of his eloquence, and the novel and striking character of his views, excited an interest altogether unprecedented, and attracted unbounded admiration. His courses of sermons at Notre-Dame drew to that immense pile crowds such as had never been seen within the memory of the living generation, and had produced



Figure of Style.

in scrofulous children, and should be treated with gentle aperients, such as rhubarb combined with

an extraordinary sensation even on the non-religious world, when once again L. fixed the wonder of the public by relinquishing the career of distinction which was open to him, and entering the novitiate of the Dominican order in 1840. A short time previously, he had published a memoir on the re-establishment of that order in France, which was followed, after his enrolment in the order, by a Life of its founder, St Dominic; and in 1841 he appeared once again in the pulpit of Notre-Dame, in the well-known habit of a Dominican friar. From this date, he gave much of his time to preaching in various parts of France. In the first election which succeeded the revolution of 1848, he was chosen one of the representatives of Marseille, and took part in some of the debates in the Assembly; but he resigned in the following May, and withdrew entirely from political life. In 1849, and again in 1850 and 1851, he resumed his courses at Notre-Dame, which, together with earlier discourses, have been collected in three volumes, under the title of *Conférences de Notre-Dame de Paris, 1835—1850*. About this time, however, his health began to decline, and he withdrew in 1854 to the convent of Soreze, where he spent the remainder of his life. In 1858, he wrote a series of *Letters to a Young Friend*, which have been much admired; and in 1860, having been elected to the Academy, he delivered what may be called his last address—the customary inaugural discourse, a Memoir of his predecessor, M. de Tocqueville. L. died at Soreze in the following year.

LA'QUER is a varnish prepared for coating metal-work (see LAC), usually polished brass. The formula usually employed is, for gold colour: alcohol, 2 gallons; powdered turmeric, 1 pound, macerate for a week, and then filter with a covered filter, to prevent waste from evaporation; to this add, of the lightest-coloured shell-lac, 12 ounces; gamboge, 4 ounces; gum-sandarach, 3½ pounds. This is put in a warm place until the whole is dissolved, when 1 quart of common turpentine varnish is added. A red lacquer, prepared by substituting 3 pounds of annotta for the turmeric, and 1 pound of dragon's blood for the gamboge, is extensively used.

LACQUERING, the art of coating metal with varnish. The term has also a wider signification, and is made to apply to the process by which some varieties of goods in wood and papier mâché are also coated with layers of varnish, which are polished, and often inlaid with mother-of-pearl, &c. See PAPIER MÂCHÉ. It would appear, from the very fine specimens from Japan in the International Exhibition, that the Japanese excel in the art of producing articles of exquisite thinness and delicacy. The varnish used by the Chinese and Japanese appears to be the same, and is a natural secretion which flows from incisions in the stem of the Varnish-tree (q. v.) Usually, the oriental lacquered work is tastefully ornamented with designs painted in gold, or with inlaid shell-work. The Japanese have carried this art so far as to apply it to their delicately beautiful china, some of which is lacquered and inlaid with mother-of-pearl, forming landscapes and other designs.

LACS D'AMOUR, in Heraldry, a cord of running knots used as an external decoration to surround the arms of widows and unmarried women, the *cordelier*, which differs but slightly from it, being used similarly with the shields of married women.

LACTA'NTIUS, in several MSS. designated LUCIUS CÆLIUS, or CÆLIUS FIRMIANUS L., an eminent Christian author, who flourished in the

early part of the 4th century. He was of Italian descent, but studied at Sicca, in Africa, under the rhetorician Arnobius, and in 301 A. D. settled as a teacher of rhetoric in Nicomedia. He was invited to Gaul by Constantine the Great (312—318 A. D.), to act as tutor to his son Crispus, and is supposed to have died at Treves about 325 or 330. L.'s principal work is his *Divinarum Institutionum*, libri vii., a production both of a polemical and apologetic character. A supposed tendency to Manicheism in his views, and his Chilianism, have marred his reputation for pure orthodoxy. He attacks paganism, and defends Christianity. Among his other writings are treatises *De Ira Dei* and *De Mortibus Persecutorum*. Some elegies have also been ascribed to him, but erroneously. His style is wonderful, if we consider the late age at which he wrote, and has deservedly earned for him the title of the *Christian Cicero*. He was, besides, a man of very considerable learning, but as he appears not to have become a Christian till he was advanced in years, his religious opinions are often very crude and singular. L. was a great favourite during the middle ages. The *editio princeps* of this writer is one of the oldest extant specimens of typography. It was printed at Subiaco in 1465.

LA'CTEALS, THE, or CHYLIFEROUS VESSELS, are the Lymphatic Vessels (q. v.) of the small intestine. They were discovered in 1622 by Aselli (q. v.), and received their name from conveying the milk-like product of digestion, the Chyle (q. v.), during the digestive process, to the

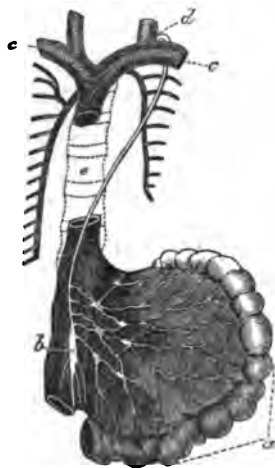

The Lacteals :

a, a portion of small intestine connected by the membranous structure, termed the mesentery, with the spinal column (the white lines seen in the mesentery are the lacteals, and the white patches are the mesenteric glands); b, the receptaculum forming the commencement of the thoracic duct, which enters the circulating system at the junction of c, the subclavian, and d, the jugular vein, on the right side; c, the vertebral column. The large vessel, with a portion removed, lying in front of the vertebral column, is the ascending or inferior vena cava.

Thoracic Duct (q. v.), by which it is transmitted to the blood. These vessels commence, as has been shewn in the article DIGESTION, in the intestinal villi, and passing between the layers of the Mesentery (q. v.), enter the mesenteric glands, and finally unite to form two or three large trunks, which terminate in the thoracic duct.

LACTIC ACID (C₃H₅O₃, HO), in its pure state is a transparent, colourless, or slightly yellow

LACTIC FERMENTATION—LADAKH.

uncrystallisable, syrupy liquid, of specific gravity 1.215. It is devoid of odour, has a sharp, acid taste, and is soluble in all proportions in water, alcohol, and ether.

The best method of obtaining this acid is by dissolving 8 parts of cane-sugar in about 50 parts of water, and then adding 1 part of decaying cheese, and 3 parts of chalk. If this mixture be set aside for two or three weeks at a temperature of about 80°, it becomes filled with a mass of crystals of lactate of lime, which must be purified by re-crystallisation, and treated with about one-third of their weight of sulphuric acid. The residue must be digested in alcohol, which leaves the sulphate of lime, and dissolves the lactic acid, which may be obtained pure on evaporating the solution. The mode in which the acid is produced in this process is described in the article LACTIC FERMENTATION.

Lactic acid is also formed in many other ways; thus, it is a frequent product of the acidification of vegetable substances, and in this way is formed in *sauer-krout*, in malt vinegar, and in the acid fermentation that takes place during the manufacture of wheat-starch. It occurs readily formed in certain plants, and is very largely produced in the animal body. It is found either free or combined, or both, in the gastric juice (although not constantly), in the contents of the small and large intestine, in the chyle (after the use of amylaceous food), in the muscular juice (both of the voluntary and involuntary muscles), in the parenchymatous juices of the spleen, liver, thymus, pancreas, lungs, and brain, and is found as lactate of lime in the urine of the horse. It has been found in certain morbid conditions of the system in the milk, where it is formed from the sugar by the fermenting action of the caseine; in the blood in leucocythæmia, pyæmia, and puerperal fever; in purulent and other transudations; in the urine when there is disturbance of the digestive and respiratory organs, and in rickets and softening of the bones (and almost always after exposure to the air for some time); in the saliva in diabetes; in the sweat in puerperal fever, and in the scales that form upon the skin in lepra.

The lactic acid occurring in the system may be traced to two distinct sources: that which is found in the intestinal canal is merely the product of the decomposition of the starchy matters of the food; but that which exists in the gastric juice (even when only animal food has been taken), in the muscular juice, and in the juices of the various glands, can only be regarded as a product of the regressive metamorphosis or disintegration of the tissues, and how it is formed is not accurately known.

There is no ready test for lactic acid. The best course to pursue is to obtain it, if it is present, as a lactate of lime, which crystallises in beautiful tufts of acicular prisms, or as a lactate of zinc, which crystallises in a very characteristic form in crusts consisting of delicate four-sided prisms.

LACTIC FERMENTATION. Although lactose or sugar-of-milk may, under certain conditions, be made to undergo alcoholic fermentation (as in the preparation of kumiss by the Tartars from mares' milk), it generally yields a very different product, viz., lactic acid, as may be seen in the case of milk turning sour in warm weather. The caseine is usually considered to act as the ferment, but being insoluble in acids, it is thrown down in flakes as soon as the milk becomes sour. In this insoluble form, it exerts little action in converting the lactose ($C_{12}H_{22}O_{11}$) into lactic acid ($C_3H_5O_2, HO$); but if the acid be neutralised by carbonate of soda or by chalk, the curd is redissolved, and the transformation of the sugar into lactic acid is renewed. No evolution of

gas or absorption of oxygen takes place during the conversion of the sugar into the acid.

Not only sugar-of-milk, but cane-sugar, starch, dextrine, and gum pass readily into lactic acid under the influence of caseine or other animal matters undergoing decomposition.

Pasteur considers that a specific ferment, the germs of which exist in the atmosphere, is concerned in the production of the lactic fermentation. During the process recommended in the preceding article for the preparation of lactic acid, a layer of particles of a gray colour is observed on the surface of the sediment. This substance, when examined under the microscope, is seen to consist of little globules or very short articulations, constituting irregular flocculent particles much smaller than those of beer-yeast, and exhibiting a rapid gyratory motion. When washed with a large quantity of water, and then diffused through a solution of sugar, the formation of lactic acid at once commences. Hence it follows that these organic particles, and not the caseine, are the actual agents in the conversion that takes place.

LACTUCARIUM, or **LETTUCE OPIUM**, is the inspissated milky juice of several species of *Lactuca* or Lettuce, and is obtained by incision of the stem. By drying in the air, the juice loses about half its weight of water, the residue being lactucarium. It usually occurs in commerce in small lumps about the size of a pea or small bean; they are of a reddish-brown colour, but are sometimes covered with a grayish efflorescence; and they have a bitter taste, and a smell resembling opium. Lactucarium has been frequently analysed, but chemistry has thrown little light on its composition.

Lactucarium possesses anodyne and sedative properties, and is employed where opium is considered objectionable; as, for instance, when there is morbid excitement of the vascular system; and it is of service in allaying cough in phthisis and other pulmonary diseases. The usual dose is five grains, but it may be safely given in larger doses.

LACUNARS, or **LACUNARIS**, the panels or coffers of ceilings, and also of the soffits of classic cornices. They are much used in the ceilings of porticos and similar classic structures, and are frequently ornamented with pateræ.

LADAKH, otherwise known as **MIDDLE TIBET**, lies between Great Tibet on the E., and Little Tibet on the W., stretching in N. lat. from 32° to 36°, and in E. long. from 76° to 79°. On the S., it is separated from Cashmere by the Himalaya, while on the N., it is divided by the Karakorum Mountains from Chinese Turkestan. It contains about 30,000 square miles, and about 125,000 inhabitants. The country was conquered by Gholab Singh, the ruler of Cashmere, in 1835. It lies chiefly within the basin of the Upper Indus, being little better than a mass of mountains with narrow valleys between them. Notwithstanding its great elevation, which is equally unfavourable to soil and climate, the temperature is sometimes singularly high—a phenomenon attributed partly to the tenuity of the atmosphere, and partly to the absence of moisture. Pretty good crops of wheat, barley, and buckwheat are raised; while the mineral products are sulphur, iron, lead, copper, and gold. The transit-trade is extensive, being carried on mostly by mules and sheep. The inhabitants are very peaceful and industrious; they are excellent farmers, and their woollen manufactures are said to be important. The women are fresh and fair, but rather lax in their morals; among the lower classes, polyandry is common. The population is essentially Mongolian, but has intermixed with the Cashmerians. The language is Tibetan, and in the opinion

of Klaproth the primitive dialect of the aboriginal people inhabiting the region between Hindustan and Tartary. The religion is Lamaism, a form of Buddhism (q. v.). The government is a despotism controlled by the priesthood. The capital city is Le (q. v.).

LADANUM, or **LABDANUM**. See **CINNUS**.

LADIES OF THE BEDCHAMBER. See **LADIES OF THE QUEEN'S HOUSEHOLD**.

LADIES OF THE QUEEN'S HOUSEHOLD, **THE**, consist of the Mistress of the Robes, the Ladies of the Bedchamber, the Bedchamber Women, and the Maids of Honour.

The office of Mistress of the Robes is of considerable antiquity. It is her duty to regulate the rotation and times of attendance of the rest of the Ladies of the Household, who are all subordinate to her. She has the superintendance of all duties connected with the bedchamber—within which the Lord Chamberlain has no authority—and the custody of the robes. On state occasions, she must see that the ceremony of robing the Queen is properly performed. In public ceremonials, she accompanies the Queen in the same carriage, or walks immediately before Her Majesty. The *Ladies of the Bedchamber*, who now number eight, with three extra ladies, and the *Bedchamber Women*, of whom there are eight, besides one resident and two extra, are personal attendants, ministering to the state of Her Majesty. The *Maids of Honour*, of whom there are eight, are immediate attendants on the royal person, and in rotation perform the duty of accompanying the Queen on all occasions. They enjoy by courtesy the title 'Honourable,' when not entitled to it by birth, and are then designated the 'Honourable Miss——' without the Christian name.

LADING, BILL OF. See **BILL OF LADING**.

LADISLAS, VLADISLAS, VLADISLAF, VLADISLAF, different forms of a name frequently occurring in the histories of Poland, Hungary, Bohemia, and Servia.—**VLADISLAS I.** of Poland, surnamed Lokietek (the Short)—one of those princes who appear to be raised up during a period of intestine confusion and disorganisation, for the purpose of shewing how powerful is the influence of one great mind—was ruler of the small province of Cracow, at a time when Poland was subdivided into countless small independencies. **V.** united them in 1319; and the further to increase the stability of the government, he reduced the privileges of the higher nobles, removed the council of prelates and magnates, replacing it by a popular assembly; he greatly improved the administration of justice, and furthered commerce and industry.—**VLADISLAS II.** and **VLADISLAS III.** See **JAGELLONS**.—**VLADISLAS IV.** (1632—1648), while yet a youth, was elected Czar of Russia in 1610, but was prevented by his father, Sigismund, from accepting the crown. He was a wise and politic prince, yet it was under his reign that Sweden, Russia, and Turkey commenced to nibble at the outlying provinces. He strove manfully to remedy the peculiar defects of the Polish constitution, but they were too deeply rooted; and though he sought to end the oppression of the dissidents, and took the part of the Cossacks against those nobles who had deprived them of their rights, so weak was the royal authority, that his support availed them nothing. The Cossacks, maddened by deprivation of their liberties, the imposition of new taxes, and the persecuting zeal of the Roman Catholic clergy, rose in rebellion, annihilated the Polish army, and put themselves under the rule of Russia. At this critical moment, **V.** died.

LADO'GA (**STARALA**, or **OLD LADOGA**), an ancient Russian town, in the government of St Petersburg,

on the left bank of the river Wolkhof. It was the residence (862) of Rurik, the founder of the Russian monarchy, and the walls of a fortress erected by him, and a church of the 11th c., still mark its site. Previously to the accession of Peter I., Old Ladoga was an important strategic point for the defence of Novgorod. Peter I. built the town of Novo, or New Ladoga, near the entrance of the Wolkhof into Lake Ladoga, and now on the site of the old town of Rurik stands the small village of Ouspenskoe.

LADOGA, LAKE, the largest lake of Europe, is situated in the north-west of Russia, between Finland and the governments of Olonetz and Petersburg. It is 120 miles in length, 70 miles in breadth, and 6804 square miles in area. It receives the waters of Lake Onega, Lake Saim, and Lake Ilmen, and its own waters are carried off to the Gulf of Finland by the Neva (q. v.). The depth of Lake L. varies from 12 to 1000 feet, and the navigation is exceedingly dangerous, owing to the shallows, sand-banks, and sunken rocks in which it abounds, and to the gusty winds which are created by its steep and rocky banks. Of the several islands of the lake, the principal are the Valaam and Konevets, with monasteries, which attract numbers of pilgrims. Of the 70 rivers which fall into Lake L., the principal are the Wolkhof, the Sias, and the Svir, each of which is a means of communication between the Neva and the Volga. In order to obviate the difficulty of navigation, canals have been constructed along its south and south-east shores, the principal being the Ladoga Canal (70 feet wide), which unites the mouth of the Wolkhof with the Neva. Other two canals unite the mouths of the Sias and Svir with the Ladoga Canal. This canal-system forms the thoroughfare for a very extensive traffic between the Volga and the Baltic. Communication by water subsists between Lake L. and the White Sea as well as the Caspian.

LADRO'NES, or **THIEVES' ISLANDS**, a group of about 20 islands, the northernmost Australasian group, in lat. 13½°—20¼° N., and long. 145½°—147° E. They are disposed in a row almost due north and south. Their united area is about 1254 square miles. They were discovered by Magellan (in 1521), who gave them the name which they still bear, from the thievish propensity displayed by the natives. They were afterwards called the *Lazarus Islands*; and the Jesuit missionaries, who settled here in 1667, called them the *Mariana Islands*. They are mountainous, well watered and wooded (among the trees are the bread-fruit, the banana, the cocoa-nut), fruitful in rice, maize, cotton, and indigo. European domestic animals are now very common. At the time when they were discovered, the population was reckoned at 100,000, but the present population is only about 5500. The inhabitants, who are docile, religious, kind, and hospitable, resemble in physiognomy those of the Philippine Islands. The islands are very important to the Spaniards, in a commercial point of view. The largest island is Guajan, 90 miles in circumference; on it is the capital, San Ignacio de Aganfia, the seat of the Spanish governor.

LADY, a woman of distinction correlatively to *Lord* (q. v.), used in a more extensive sense in common parlance correlatively to *gentleman*. As a title, it belongs to peeresses, the wives of peers, and of peers by courtesy, the word Lady being in all these cases prefixed to the peerage title. The daughters of dukes, marquises, and earls are by courtesy designated by the title Lady prefixed to their Christian name and surname; a title not lost by marriage with a commoner, when the lady only substitutes her husband's surname for her own, and retains her

precedence. But a peer's daughter marrying a peer, can no longer be designated by her Christian name with *Lady*; she must take her husband's rank and title, even should a loss of precedence be the result, as when the daughter of a duke marries an earl, viscount, or baron. Should her husband, however, be merely a courtesy peer, she may retain her designation by Christian name with *Lady* prefixed, substituting her husband's courtesy title for her surname; this title and precedence being again dropped on her husband's succession to the peerage by his father's death. The daughter-in-law of a duke, marquis, or earl, is generally designated by the title *Lady* prefixed to the Christian name and surname of her husband; but if she be the daughter of a peer of a higher rank than her father-in-law, she may, if she pleases, be designed by *Lady* prefixed to her own Christian name and her husband's surname, and in that case she retains the precedence which she had when unmarried. The wife of a baronet or knight is generally designed by *Lady* prefixed to her husband's surname; the proper legal designation, however, being *Dame*, followed by her Christian name and surname.

LADY CHAPEL, a chapel dedicated to the Virgin Mary ('Our Lady'), and usually, but not always, placed eastwards from the altar when attached to cathedrals. Henry VII.'s Chapel at Westminster is the lady chapel of that cathedral.

LADY OF MERCY, OUR, a Spanish order of knighthood, founded in 1218, by James I. of Aragon, in fulfilment of a vow made to the Virgin during his captivity in France. The object for which the order was instituted was the redemption of Christian captives from among the Moors, each knight at his inauguration vowing that, if necessary for their ransom, he would remain himself a captive in their stead. Within the first six years of the existence of the order, no fewer than 400 captives are said to have been ransomed by its means. On the expulsion of the Moors from Spain, the labours of the knights were transferred to Africa. Their badge is a shield party per fess gules and or, in chief a cross pattée argent, in base four pallets gules for Aragon, the shield crowned with a ducal coronet. The order was extended to ladies in 1261.

LADY OF MONTESA, OUR, an order of knighthood, founded in 1317 by King James II. of Aragon, who, on the abrogation of the order of the Templars, urged Pope Clement V. to allow him to employ all their estates within his territory in founding a new knightly order for the protection of the Christians against the Moors. His request was acceded to by the following pope, John XXII., who granted him for this purpose all the estates of the Templars and of the Knights of St John situated in Valencia. Out of these was founded the new order, which King James named after the town and castle of Montesa, which he assigned as its head-quarters. The order is now conferred merely as a mark of royal favour, though the provisions of its statutes are still nominally observed on new creations. The badge is a red cross edged with gold, the costume a long white woollen mantle, decorated with a cross on the left breast, and tied with very long white cords.

LADYBIRD (*Coccinella*), a genus of coleopterous insects of the section *Trimera*, containing a great number of species very similar to each other. They are very pretty little beetles, well known to every one, generally of a brilliant red or yellow colour, with black, red, white, or yellow spots, the number and distribution of which is one of the characteristic marks of the different species. The form is nearly hemispherical, the under-surface being very flat, the

thorax and head small; the antennæ are short, and terminate in a triangular club; the legs are short. When handled, these insects emit from their joints a yellowish fluid, having a disagreeable smell. They and their larvæ feed chiefly on aphides, in devouring which they are very useful to hop-growers and other agriculturists. They deposit their eggs under the leaves of plants, on which the larvæ are to find their food, and the larvæ run about in pursuit of aphides. *Ladybirds* are sometimes to



Ladybird (*Coccinella ocellata*):
Magnified.

be seen in immense numbers, which, from ignorance of their usefulness, have sometimes been regarded with a kind of superstitious dread. Several species are abundant in Britain, and the largest of these (*C. septem-punctata*) is found over all Europe, and in parts of Asia and Africa. The name *L.* is perhaps a corruption of *Ladybug* (*Lady*, i. e., the Virgin Mary). The German name is *Marienkäfer*.

LADY-DAY, one of the regular quarter-days in England and Ireland, on which rent is generally made payable. It is the 25th of March in each year.

LADY'S FRIEND, a name given to an officer of the House of Commons, who used to take care that a provision was inserted in favour of a wife when the husband applied for an act of parliament to divorce her. The practice is now superseded by the different practice in an ordinary suit in the divorce court.

LADY'S GOWN, a present formerly made in Scotland by a purchaser of an estate to a wife on her renouncing her liferent over her husband's lands.

LADY'S MANTLE (*Alchemilla*), a genus of herbaceous plants, chiefly natives of temperate and cold climates, of the natural order *Rosaceæ*, sub-order *Sanguisorbææ*; having small and numerous flowers, an 8-cleft calyx, no corolla, and the fruit surrounded by the persistent calyx. The name *L. M.* signifying *Mantle of Our Lady*—i. e., of the Virgin Mary, is derived from the form of the leaves.—The COMMON *L. M.* (*A. vulgaris*) is abundant on banks and in pastures throughout Britain. Its root-leaves are large, plaited, many-lobed, and serrated; its flowers in corymbose terminal clusters are usually of a yellowish-green colour.—Still more beautiful is the ALPINE *L. M.* (*A. alpina*), which grows on mountains in Scotland, and has digitate serrated leaves, white and satiny beneath.—A common British plant of very humble growth and unpretending appearance is the FIELD *L. M.*, or PARSLEY PIERT (*A.*—or *Aphanes—arvensis*), found in pastures, an astringent and diuretic, said to be sometimes useful in cases of stone in the bladder, by producing a large secretion of lithic acid.

LADY'S SLIPPER (*Cypripedium*), a genus of plants of the natural order *Orchideæ*, of which one species, *C. Calceolus*, is a native of Britain, being found in a few places in the north of England, and is reckoned one of the most beautiful of the British Orchids. The genus is remarkable for the large inflated lip of the corolla. Several very beautiful species are natives of the colder parts of North America.

LAENNEC, RENÉ THEOPHILE HYACINTHE, a distinguished physician, was born at Quimper, in

Lower Brittany, in 1781, and died there in 1826. He studied medicine in Paris, where he attended the practice of Corvisart, to whom the medical profession is mainly indebted for the introduction of percussion in the investigation of diseases of the chest, although the original discovery is due to Avenbrugger. In 1814, he took the degree of Doctor of Medicine, and in the same year, he became the chief editor of the *Journal de Médecine*. In 1816, he was appointed chief physician to the Hôpital Necker, and it was there that he soon after made the discovery of mediate auscultation, or, in other words, of the use of the Stethoscope (q. v.). In 1819, he published his *Traité de l'Auscultation Médiante*, which has undoubtedly produced a greater effect, in so far as the advance of *diagnosis* is concerned, than any other single book. His treatise had not long appeared, when indications of consumption were discovered in his own chest by means of the art of his own creation, and after a few years of delicate health, during which he continued to practise in Paris, he retired to die in his native province.

LÆTARÉ SUNDAY, called also MID-LENT, is the fourth Sunday of Lent. It is so named from the first word of the Introit of the mass, which is from Isaiah lxvi. 10. From this name the characteristic of the services of the day is joyousness, and the music of the organ, which throughout the rest of Lent is suspended, is on this day resumed. Lætare Sunday is also the day selected by the pope for the blessing of the GOLDEN ROSE (q. v.).

LA FARINÀ, an Italian author and politician, born at Messina in 1815. In the university of Catania, the degree of Doctor of Laws was conferred on him at the age of 19; and in 1837, having taken part in an ineffectual revolutionary movement in Sicily, he sought safety in expatriation. In 1839, he returned to Sicily, was received as a lawyer, and started several political journals, which were all successively suppressed. This led him to remove to Florence, where he published several works, more remarkable for their contents than for the graces of their language. In the rising of 1848, La F. took a prominent part in the movement of Tuscany, where he edited the first democratic and anti-papal journal, the *Alba*. He soon returned to Sicily, and was elected member of the council of war, and member of parliament; and on the deposition of the king by the Sicilians, he was despatched by the provisional government on a mission to Rome, Tuscany, and Turin. On his return to Palermo, he discharged the combined duties of Minister of Public Instruction, of Public Works, and of the Interior. After the capture of Messina by the royal troops, La F. accepted from the king's government the post of Minister of War, a step which incurred the severe censure of the party of liberty, but which only led to his renewed banishment from Sicily. In the war of the south, by which the heroic Garibaldi liberated the kingdom of Naples, La F. reappeared in Sicily; but his unfortunate differences with Garibaldi led to his ultimate expulsion from the island, by order of the dictator. Some of his principal works are—*Souvenirs of Rome and Tuscany*; *Italy* (1 vol.); *Switzerland* (2 vols.); *China* (4 vols.); *History of the Revolution of Sicily in 1848 and 1849* (2 vols.).

LAFAYETTE, MARIE MADELEINE POCHE DE LAVERGNE, COMTESSE DE, born 1633, died 1693, the authoress of a number of novels, excelled by no works of that age in the development of character and true delineation of human nature. Her father, Aymar de Lavergne, was governor of Havre. She received an excellent education, and in 1655

married the Count de Lafayette, after which her house became a resort of the most distinguished literary men of her age, at the same time that it was frequented by the persons of highest rank and fashion in Paris. Her novels, *Zaïde* and *La Princesse de Clèves*, have been frequently reprinted.

LAFAYETTE, MARIE JEAN PAUL ROCH YVES GILBERT MOTIER, MARQUIS DE, descended from an ancient family of Auvergne, was born 6th September 1757, in the castle of Chavagnac, now in the department of Upper Loire. He became a soldier at an early age, and in 1777 went to America, to take part with the colonists in their war of independence. The friendship of Washington exercised a great influence over the development of his mind and the formation of his opinions. The declaration of war between France and Britain gave him an opportunity of aiding the new republic effectually, by returning to France, where he was received with honour by the court, and with enthusiasm by the people. He again repaired to America in 1780, and was intrusted by Congress with the defence of Virginia, where he rendered important services. On a third visit to North America in 1784, after the conclusion of peace, he was received in such a manner that his tour was a continual triumph.

L. had imbibed liberal principles, and now eagerly sought to promote a thorough reform in his native country. He was called to the Assembly of Notables in 1787, and was one of those who most earnestly urged the Assembly of the States. He took part also in the movements which converted the Assembly of the States into the National Assembly in 1789. He took a very active part in the proceedings of the Assembly, and being appointed to the chief command of the armed citizens, laid the foundation of the National Guard, and gave it the tricolor cockade. In these first periods of the Revolution, it seemed as if L. had the destinies of France in his hands. But he found himself unable to control the excitement which sprung up. The extreme republicans soon came to dislike him, because he advocated a constitutional kingdom; and the court-party, especially the queen, did the same—in spite of the services he rendered them—because of his zeal for the new order of things. Along with Bailly, he founded the club of the Feuillants. After the adoption of the constitution of 1790, he retired to his estate of Lagrange, till he received the command of the army of Ardennes, with which he won the first victories at Philippeville, Maubeuge, and Florennes. Nevertheless, the calumnies of the Jacobins rendered him exceedingly unpopular, and he was accused of treason, but acquitted. After several vain efforts to maintain the cause of rational liberty, he left Paris for Flanders, but was taken prisoner by the Austrians, and conveyed to Olmütz, where he remained for about five years, till Bonaparte obtained his liberation in 1797; but he took no part in public affairs during the ascendancy of Bonaparte. He sat in the Chamber of Deputies for the department of Sarthe from 1818 to 1824, and was one of the extreme Left. From 1825 to 1830, he was again a leader of the opposition in the Chamber of Deputies. In 1830, he took an active part in the revolution, and commanded the National Guards. He died 20th May 1834.

LAFAYETTE, a city of Indiana, United States of America, on the east bank, and at the head of navigation of the Wabash River, 63 miles north-west of Indianapolis, on the line of the Wabash and Erie Canal, and at the intersection of four railways. It is a flourishing city, in the midst of a rich prairie-country. Laid out in 1825, it has 15 churches, 2 daily, and 3 weekly newspapers, with

numerous banks, hotels, and manufactories. Pop. in 1860, 9426.

LAFFITTE, JACQUES, a French banker and statesman, born of humble parentage at Bayonne, 24th October 1767, was early employed as a clerk by the rich banker Perregaux in Paris, and succeeded him in business in 1809. He soon rose to great wealth and a European reputation. He was made President of the Chamber of Commerce, and in 1814 governor of the Bank of France. On the return of Napoleon from Elba, Louis XVIII. deposited a large sum in L.'s hands; and after the battle of Waterloo, Napoleon intrusted 5,000,000 francs to him, which he kept safe, although the government made some attempts to lay hold of it. After the second restoration, he became one of the opposition in the Chamber of Deputies, and enjoyed the highest popularity in Paris. When the revolution broke out in 1830, he wrote to the Duke of Orleans, saying, 'You have to make your choice between a crown and a passport.' He freely supplied the money requisite on that occasion. He became one of the first ministry of the new king, and in November 1830 was intrusted with the formation of a cabinet, the conservative character of which caused the loss of his popularity. Meanwhile his banking affairs fell into confusion, and he was obliged to sell all his property to pay his debts. A national subscription preserved him his hôtel in Paris; and being again elected to the Chamber as a deputy for Paris, he became a leader of the opposition. From the ruins of his fortune he founded a new Discount Bank. As the government receded more from the principles of the revolution of 1830, L. became more active in opposition. In 1843, to the great displeasure of the court, he was elected president of the Chamber of Deputies. He died 26th May 1844.

LAFONTAINE, JEAN DE, a French poet, distinguished above all his countrymen as a fabulist, was the son of a Maître des Eaux et Forêts, and was born July 8, 1621, at Château-Thierry, in Champagne. In his early youth, he learned almost nothing, and at the age of 20, he was sent by his father to the Oratory at Rheims, in a state of extreme ignorance. Here, however, he began to exhibit a decided taste for the classics and for poetry. Though selfish and vicious to the last degree, he possessed withal a certain child-like *bonhomie*; it was not grace, or vivacity, or wit, but a certain soft and pleasant amiability of manner, so that he never wanted friends. He successively found protectors in the Duchess de Bouillon, who drew him to Paris; in Madame de Sablière, and in M. and Madame Hervart. He enjoyed the friendship of Molière, Boileau, Racine, and other contemporary celebrities; and even the saintly Fenelon lamented his death in extravagant strains. In 1693, after a dangerous illness, he carried into execution what a French critic characteristically terms his *projet de conversion*, and spent the brief remainder of his life in a kind of artificial penitence, common enough among licentious men and women in those sensual days. He died at Paris, April 13, 1695. His best, which, however, are also his most immoral productions, are *Contes et Nouvelles en Vers* (Paris, 1665; 2d part, 1666; 3d part, 1671), and *Fables Choisies mises en Vers* (also in three parts, of which the first appeared in 1668, and the third in 1693). The editions of the *Fables* have been innumerable. The best edition of L.'s collected works is that of Walckenaër (18 vols. Paris, 1819—1820; improved edition, in 6 vols. 1822—1823).

LAGERSTROMIA, a genus of plants of the

natural order *Lythraceæ*, the type of a sub-order *Lagerstromiææ*, which is distinguished by winged seeds, and in which are to be found some of the noblest trees of tropical forests, whereas the true *Lythreæ* are generally herbaceous. *Lagerstromia Regina* is the JAROOL of India—a magnificent tree, with red wood, which, although soft, is durable under water, and is therefore much used for boat-building.

LA'GOMYS, a genus of rodent quadrupeds, of the family *Leporidae*, much resembling hares or rabbits, but with limbs of more equal length, more perfect clavicles, longer claws, longer head, shorter ears, and no tail. They are interesting from their peculiar instincts, storing up herbage for winter use in heaps or stacks. The ALPINE L., or PIKA of Siberia (*L. alpinus*), the largest of the genus, is scarcely larger than a guinea-pig, yet its stacks are sometimes four or five feet high, by eight feet in diameter, and often afford adventurous sable-hunters the food necessary for their horses. The little animals live in burrows, from the inhabited part of which galleries lead to the stacks. The herbage of which they are composed is of the choicest kind, and dried so as to retain much of its juices, and form the very best of hay.

LAGOON (Lat. *lacuna*, a hollow or pool) is a species of lake formed by the overflowing either of the sea or of rivers, or by the infiltration of water from these; and hence lagoons are sometimes divided into fluvial and marine. They are found only in low-lying lands, such as the coasts of Holland, Italy, the Baltic, and the east coast of South America; are generally shallow, and do not always present the same aspect. In some cases, they are completely dried up in summer; in others, after being once formed, they preserve throughout the whole year the character of stagnant marshy pools; and in others, again, the sea, which re-unites them to itself in winter, is separated from them in summer by a bar of sand or shingle.

LA'GOS, a city and seaport of Portugal, in the province of Algarve, on a wide bay, 23 miles east-north-east from the extremity of Cape St Vincent. The harbour affords protection from north and west winds only, and accommodates only small vessels. A productive tunny-fishery is carried on in the vicinity. Pop. 7800. In the bay of L., Admiral Boscawen obtained a signal victory over the French Toulon fleet, August 18, 1759.

LAGRANGE, JOSEPH LOUIS, COMTE, one of the greatest of mathematicians, was born at Turin in 1736. He was of French extraction, and was the grandson of Descartes. When still a youth, he solved the isoperimetrical problem of Euler, and when scarcely 19 years of age, was appointed Professor of Mathematics in the Artillery School in Turin. Frederick the Great appointed him to be Euler's successor, as director of the Academy at Berlin, in 1759. After Frederick's death, Naples, Sardinia, Tuscany, and France strove for the honour of offering L. a better position. He accepted the offer of France, and took up his quarters in the Louvre in 1787, obtaining a pension of 6000 francs (£238). In 1791, he was chosen a foreign member of the Royal Society of London, and the same year the National Assembly confirmed to him his pension, and he was appointed one of the directors of the Mint. He was in great danger during the Reign of Terror, but escaped, and was afterwards professor in the Normal and Polytechnic Schools. Napoleon made him a member of the Senate, bestowed on him the Grand Cross of the Legion of Honour, the title of Count,

and many other favours. He died 10th April 1813, and was interred in the Pantheon. His principal works are: *Memoirs 'on the Motion of Fluids'* and 'the Propagation of Sound'; another memoir refuted D'Alembert's views regarding the theory of the earth's formation. When only 24 years of age, he published his *New Method*, subsequently known as the *Calculus of Variations*, thus adding a new and powerful weapon to the philosophical armoury. In 1764, his memoir on the 'Libration of the Moon' carried off the first prize at the Academy. It was in this treatise that he shewed the extent and fruitfulness of the principle of 'virtual velocities' which he afterwards so successfully applied to mechanics. Next appeared his works on the solution of 'numerical' and 'algebraic' equations; and in 1787, his *Mécanique Analytique*, a work in which mechanics is reduced to a mere question of calculation. His last important works were, *Calcul des Fonctions Analytiques, Traité des Fonctions*, and *Résolution des Equations Numériques*. L. made many other important investigations in pure and mixed mathematics, and particularly in astronomy—the chief subjects of which are, the problem of Three Bodies, the Long Inequality of Jupiter and Saturn, the moon's Secular Inequality, attraction of ellipsoids, perturbations of Jupiter's satellites, diminution of the ecliptic, variation of the elements of the planetary orbits, &c.

LAGRIMOSO, an Italian term used in Music, meaning weeping, or mournfully; similar to *lamentoso*, which expresses the same, but in a higher degree. The delivery should be heart-stirring, but at the same time free from all mannerisms and embellishments.

LA GUAYRA. See GUAYRA, LA.

LA GUÉRONNIÈRE, LOUIS ETIENNE ARTHUR, VICOMTE DE, a conspicuous French politician of the present day, was born in 1816, of a noble family of Poitiers. He first attracted notice by the articles which he contributed to the *Avenir National* of Limoges, about 1835. Subsequently, he made the acquaintance of Lamartine, whom for many years he regarded both as his political and literary master. Ultimately, he came to a rupture with Lamartine, and became an ardent Bonapartist, and after the *coup d'état* (2d December 1851), the apologist of that audacious deed. In 1853, he entered the Council of State. La G. has retained his connection with the press, and, at least until recently, stood so well in the good graces of the French emperor, that his articles and pamphlets have been considered to possess a semi-official value. The paper he now conducts, *La France*, has attained a high degree of importance in the sphere of political journalism. La G.'s most noted publications of late years have been: *L'Empereur Napoléon III. et l'Angleterre* (1858), *L'Empereur Napoléon III. et l'Italie* (1859), and *Le Pape et le Congrès* (1859).

LAHIJAN, an important trading-town of Persia, in the province of Ghilan, close to the southern shore of the Caspian Sea, thirty miles east-south-east of Reshd. Pop. 7000.

LAHN, an important affluent of the Rhine (q. v.).

LAHORE, the chief city of the Punjab, stands on the left bank of the Ravi, the middle of the five rivers which give name to the country; lat. 31° 36' N., long. 74° 21' E. It is surrounded by a brick wall, formerly twenty-five feet high, and by fortifications seven miles in circuit. In the north-west corner of the city stand the citadel, the great magazine, and military workshops. The streets are narrow and gloomy, the bazaars well furnished, but the houses in general insignificant. Within

the circuit, wells are abundant; the ground is well cultivated, adorned with magnificent gardens, and strewn with numerous ruins of a bygone splendour and prosperity. The present town, which has a population of about 100,000, is said to have possessed under the Moguls 1,000,000 inhabitants. In the 12th c., it was the capital of the dynasty of the Ghaznevides, and subsequently a favourite residence of the successors of Baber. In 1799, Runjeet Singh, the Sikh prince, became ruler of Lahore; but as he chose for his head-quarters, Amritsar, a city about forty miles to the east, L. became much neglected. Since 1849, the epoch of the British conquest of the Punjab, L. has advanced in commerce and wealth. More especially, however, has the change of masters been beneficial to education. A seminary not only for imparting Hindu and Mohammedan literature, but also for communicating, through vernacular languages, European knowledge, has been successfully established. The institution, though it does receive a grant in aid from the supreme government, is yet mainly supported by the rulers and populations of native principalities. Even in 1849, the pupils numbered 541.

LAHR, a manufacturing town of Baden, situated on the Shutter, an affluent of the Rhine, 53 miles south-south-west of Carlsruhe. It stands in a rich and beautiful district, and carries on considerable manufactures of linen and woollen cloth, silk ribbons, leather, and tobacco. Pop. 7000.

LAI'BACH, or LAYBACH, a town of Austria, capital of the crownland of Carniola, is situated in an extensive plain on a river of the same name, fifty miles north-east of Trieste. It contains a lyceum, gymnasium, and other educational institutions, and carries on an extensive transit-trade with Trieste, Fiume, Grätz, &c. Its manufactures of cotton employ 400 hands, and upwards of 200 workmen are employed in the sugar-works. To the south-west of the town is the Laibach Morass, which formerly was frequently covered by the swollen waters of the river. It is upwards of eighty square miles in extent. Within the last thirty years, the half of it has been brought under cultivation, the remainder affords an inexhaustible supply of turf. Pop. 20,100.

This town is famous for the congress of monarchs which met here in 1821. The purpose of this congress was to secure the peace of Italy against Carbonarism, to arrest the then increasing progress of revolution, and to restore in Naples and Sicily the former condition of affairs. The result of it was the passing of a resolution establishing among European nations the right of armed intervention in the affairs of any neighbouring state which may be troubled with factions. In the resolutions of this congress the British minister refused to take part.

LA'IS, the name of one, or, more probably, two Greek courtesans, celebrated for extraordinary beauty. The elder is believed to have been born at Corinth, and flourished during the Peloponnesian War. She was reckoned to possess the most graceful figure of any woman of her time in Greece, but she was capricious, greedy of money, and in her old age became a tippler.—The younger appears to have been born in Sicily, but came to Corinth when still a child. She sat as a model to the painter Apelles, who is said to have recommended her to adopt the profession of a prostitute, in which she obtained a 'bad eminence.' She was stoned to death by some Thessalian women whom she had made jealous. Both of these women had temples erected to their memory.

LA'ITY (from the Gr. *laos*, the common people), the name given in the Roman Catholic Church to

all persons who do not belong to the Clergy (q. v.). The name appears to have originated as early as the 2d c., when the idea grew up that the priesthood formed an intermediate class between Christ and the Christian community. The influence which the laity had at first exercised in the government of the church gradually declined as the power of the hierarchy increased, and although, as late as the end of the 3d c., cases occur in which learned laymen taught publicly with the approval of bishops, still this liberty was ever more and more narrowed, until finally, in 502, a synod, held at Rome under the bishop, Symmachus, forbade laymen to interfere in any way in the affairs of the church. The Protestant Church, in general, maintains on scriptural grounds the common and equal priesthood of all Christians; still, as marking a visible distinction of office, the words continue in very general use, the depth of the distinction implied varying with the 'church' views of those employing them. Some very strict Protestants are careful to say minister and priest, instead of clergy and laity.

LAKE (Lat. *lacus*) is a portion of water surrounded by land. There are (1) some lakes which neither receive nor emit streams; (2) some, fed by springs, emit, but do not receive streams; (3) others, as the Caspian and Aral Seas, receive rivers, but have no visible outlet; but (4) by far the greater number both receive and emit streams. Almost the whole of the lakes coming under the third class are salt or brackish; Lake Tchad, in Central Africa, forming one of the most prominent exceptions.

LAKE OF THE THOUSAND ISLANDS, an expansion of the St Lawrence (q. v.), extends about 40 miles below the north-east end of Lake Ontario. It is well worthy of its name, being said to contain 1700 islets, the largest measuring 10 miles by 6. It separates Upper Canada from the state of New York.

LAKE OF THE WOODS, a body of water famous in the history of the international boundary between the United States and the Hudson's Bay Company's territories, takes its name from the fact of its being studded with wooded islands, and lies 190 miles west-north-west of Lake Superior. At its south-east end, it receives the Rainy River from the Rainy Lake; and at its north-west extremity, it sends forth the Winnipeg on its course to Hudson's Bay. According to the treaty which closed the War of Independence, it was divided by a central line between England and her old colonies. It measures about 300 miles round; and its remotest point is in lat. 49° N., and long. 95° W.

LAKE SCHOOL, the name with which the *Edinburgh Review* dubbed certain poets (Wordsworth, Coleridge, and Southey) who, towards the close of last c., took up their residence in the Lake district of Cumberland and Westmoreland, and who—though widely different from each other in almost every other respect—professed to seek the sources of poetical inspiration in the simplicity of nature, rather than in the works of their predecessors and the fashion of the times. The epithet, however, is not a happy one, and does not help us to a better knowledge of the men.

LAKES, in point of law, belong to the owner of the land which surrounds them; by which is meant not only the water and the use of it, but the soil under the water. Where the land surrounding the lake belongs to different owners, each has *prima facie* the right to use the lake for ordinary purposes, including fishing or boating; but it depends on how the properties were acquired, whether and how far this general rule applies to any particular case.

LAKES, colours prepared by combining animal and vegetable colouring matters with alumina, which has a remarkable property of uniting with and separating these colours from their solutions. Thus, if we take the coloured solution of cochineal, and add to it a solution of alum, the alumina in the alum immediately combines with the colouring matter, and the result is a precipitate which is carmine or Florentine Lake.

Red lake is made in a similar manner from Brazil wood, a little solution of tin being added to heighten the colour, and potash being used to accelerate the precipitation. Lakes of several shades of red and purple are also made from madder-roots, the quantity of potash used determining the proper colour. Two or three yellow lakes are used, the manufacture of which is very similar; they are prepared from yellow berries or from arnotto. Almost every known animal or vegetable colour may be converted into a lake, but those mentioned are the only ones found practically useful. They are chiefly employed by calico-printers and paper-stainers.

LAKSHMI, in Hindu Mythology, the name of the consort of the god Vish'n'u (q. v.), and considered also to be his female or creative energy. According to the mystical doctrine of the worshippers of Vish'n'u, this god produced the three goddesses, Brāhmi, Lakshmi, and Chan'dikā, the first representing his creating, the second, his preserving, and the third, his destroying energy. This view, however, founded on the superiority of Vish'n'u over the two other gods of the Hindu triad—Brāhmi, or Saraswati, being generally looked upon as the energy of Brāhmi, and Chan'dikā, another name of Durgā, as the energy of S'iva—is later than the myth, relating to L., of the epic period; for, according to the latter, L. is the goddess of Fortune and of Beauty, and arose from the Ocean of Milk when it was churned by the gods to procure the beverage of Immortality, and it was only after this wonderful occurrence that she became the wife of Vish'n'u. When she emerged from the agitated milk-sea, one text of the Rāmāyan'a relates, 'she was reposing on a lotos-flower, endowed with transcendent beauty, in the first bloom of youth, her body covered with all kinds of ornaments, and marked with every auspicious sign. . . . Thus originated, and adored by the world, the goddess, who is also called *Padmā* and *S'rī*, betook herself to the bosom of Hari—i. e., Vish'n'u.' A curious festival is celebrated in honour of this divinity on the fifth lunar day of the light half of the month Māgha (February), when she is identified with Saraswati, the consort of Brāhmi, and the goddess of learning. In his treatise on festivals, a great modern authority, Raghunandana, mentions, on the faith of a work called *Samvatsara-sandipa*, that L. is to be worshipped in the forenoon of that day with flowers, perfumes, rice, and water; that due honour is to be paid to inkstand and writing-reed, and no writing to be done. Wilson, in his essay on the *Religious Festivals of the Hindus* (works, vol. ii. p. 188, ff.), adds that, on the morning of the 2d February, 'the whole of the pens and inkstands, and the books, if not too numerous and bulky, are collected, the pens or reeds cleaned, the inkstands scoured, and the books, wrapped up in new cloth, are arranged upon a platform, or a sheet, and strewn over with flowers and blades of young barley, and that no flowers except white are to be offered. After performing the necessary rites. . . . all the members of the family assemble and make their prostrations; the books, the pens, and ink having an entire holiday; and, should any emergency require a written communication on the day dedicated to the divinity of scholarship, it is done with

chalk or charcoal upon a black or white board.' In different parts of India, this festival is celebrated at different seasons, according to the double aspect under which L. is viewed by her worshippers. The festival in the month Māgha seems originally to have been a vernal feast, marking the commencement of the season of spring.

LALANDE, JOSEPH JÉRÔME LEFRANÇOIS DE, an eminent French astronomer, was born at Bourg, 11th July 1732. He devoted himself with such success to mathematics and astronomy, that the French Academy sent him to Berlin in 1751, to determine the moon's parallax, at the same time that Lacaille was sent to the Cape of Good Hope. In 1752, he returned, and was appointed one of the astronomers-royal; and in 1761, succeeded Lemonnier in the professorship of astronomy in the Collège de France. His lectures had a rare attractiveness, and he published several astronomical works of a popular kind, as well as works of profound science. He finally filled the office of Director of the Paris Observatory, and died 4th April 1804. His character was marked by extreme vanity; but no one has ever equalled him as a lecturer on astronomy, and few have contributed more to the general progress of astronomical science. His principal work is his *Traité d'Astronomie* (2 vols. Paris, 1764—a new and augmented edition in 4 vols. Paris, 1771—1781). He also published minor works on astronomy, navigation, &c., and an account of his travels in Italy during 1765 and 1766 (9 vols. Paris, 1786).

LALITA-VISTARA is the name of one of the most celebrated works of Buddhist literature. It contains a narrative of the life and doctrine of the Buddha S'ākyamuni (see BUDDHA), and is considered by the Buddhists as one of their nine chief works, treating of Dharma, or religious law. It is one of the developed Sūtras of the Mahāyāna system. An edition of the Sanscrit text, and an English translation of this work by Bābu Rājendralāl Mitra, is publishing under the auspices of the Asiatic Society of Bengal. A French translation from the Tibetan has been made by Ph. Ed. Foucaux. In Chinese, there are two translations of it. See E. Burnouf, *Introduction à l'Histoire du Bouddhisme Indien* (Paris, 1844); and W. Wassiljew, *Der Buddhismus, seine Dogmen, Geschichte und Literatur* (St Petersburg, 1860).

LA'MA, or LLAMA (*Auchenia lama*), a most useful South American quadruped of the family *Camelidae*. It is doubtful whether it ought to be regarded as a distinct species, or as a mere domesticated variety of the Huanaca (q. v.). It was in general use as a beast of burden on the Peruvian Andes at the time of the Spanish conquest, and was the only beast of burden used by the natives of America before the horse and ass were introduced by Europeans. It is still much used in this capacity on the Andes, the peculiar conformation of its feet (see AUCHENIA) enabling it to walk securely on slopes too rough and steep for any other animal. The working of many of the silver mines of the Andes could scarcely be carried on but for the assistance of lamas. The burden carried by the L. should not exceed 125 pounds. When too heavily loaded, the animal lies down, and refuses to move, nor will either coaxing or severity overcome its resolution. It is generally very patient and docile. Its rate of travelling is about 12 or 15 miles a day. The L. is about three feet in height at the shoulder, has a longish neck, and carries its head elevated. The females are smaller and less strong than the males, which alone are used for carrying burdens. The colour is very various, generally

brown, with shades of yellow or black, frequently speckled, rarely quite white or black. The flesh is spongy, coarse, and not of a very agreeable flavour. The hair or wool is inferior to that of the alpaca, but is used for similar purposes; that of the female is finer than that of the male. The L. has been introduced with the alpaca into Australia; but it is only for steep mountain regions that it seems to be adapted.

LA'MAISM (from the Tibetan *bLama*,* spiritual teacher or lord) is the name of the religion prevailing in Tibet and Mongolia. It is Buddhism (q. v.) corrupted by S'ivaism (q. v.), and by Shamaism (q. v.), or spirit-worship. As ancient Buddhism knows of no worship of God, but merely of an adoration of saints, the latter is also the main feature of Lamaism. The essence of all that is sacred is comprised by this religion under the name of dKon mChhog gSsum (pronounced *Konchogsum*), which consists of the 'three most precious jewels'—viz., 'the Buddha-jewel,' the 'doctrine-jewel,' and 'the priesthood-jewel.' A similar triad is implied by the three Buddhistic formulæ: 'I take my refuge in Buddha; I take my refuge in the law (or doctrine); I take my refuge in the congregation (of the priests),' but it did not obtain the same dogmatic importance in Buddhism as in Lamaism, where it is looked upon as a kind of trinity, representing an essential unity. The first person of this trinity is the Buddha; but he is not the creator, or the origin of the universe; as in Buddhism, he is merely the founder of the doctrine, the highest saint, though endowed with all the qualities of supreme wisdom, power, virtue, and beauty, which raise him beyond the pale of ordinary existence. The second jewel, or the doctrine, is the law or religion—that which is, as it were, the incarnation of the Buddha, his actual existence after he had disappeared in the Nirvāna. The third jewel, or the priesthood, is the congregation of the saints, comprising the whole clergy, the incarnate as well as the non-incarnate representatives of the various Buddhistic saints. The latter comprise the five Dhyāni-Buddhas, or the Buddhas of contemplation, and, besides, all those myriads of Bodhisattwas, Pratyeka-Buddhas, and pious men, who became canonised after their death. It is obvious that among their number a portion only can enjoy practical worship; but the clergy, as the visible representative of these saints, claim and receive due homage at all the religious ceremonies. Inferior in rank to these saints are the gods and spirits, the former chiefly taken from the Pantheon of the S'ivaites. The highest position amongst these is occupied by the four spirit-kings—viz., *Indra* (q. v.), the god of the firmament; *Yama*, the god of death and the infernal regions; *Yamāntaka*, or S'iva, as revenger in his most formidable shape; and *Vaiśravaṇa*, or the god of wealth. The worship of these saints and gods consists chiefly in the reciting of prayers, and sacred texts, and the intonation of hymns, accompanied with a kind of music, which is a chaos of the most unharmonious and deafening sounds of horns, trumpets, and drums of various descriptions. During this worship, which takes place three times a day, the clergy, summoned by the tolling of a little bell, are seated in two or more rows, according to their rank; and on special holidays, the temples and altars are decorated with symbolical figures, while offerings of tea, flour, milk, butter, and others of a similar nature, are made by the worshippers; animal sacrifices or offerings entailing injury to life being forbidden, as in the Buddhistic faith. Lamaism knows especially

* The small letters prefixed to the initials of the Tibetan words in this article are not pronounced.

three great festivals. The *Log gSear*, or the festival of the new year, in February, marks the commencement of the season of spring, or the victory of light and warmth over darkness and cold. The Lamaists, like the Buddhists, celebrate it in commemoration of the victory obtained by the Buddha S'akyamuni, over the six heretic teachers. It lasts fifteen days, and consists of a series of feasts, dances, illuminations, and other manifestations of joy; it is, in short, the Tibetan carnival. The second festival, probably the oldest festival of the Buddhistic Church, is held in commemoration of the conception or incarnation of the Buddha, and marks the commencement of summer. The third is the *water-feast*, in August and September, marking the commencement of autumn. Baptism and confirmation are the two principal sacraments of Lamaism. The former is administered on the third or tenth day after birth; the latter, generally when the child can walk and speak. The marriage ceremony is to Tibetans not a religious, but a civil act; nevertheless, the Lamas know how to turn it to the best advantage, as it is from them that the bridegroom and bride have to learn the auspicious day when it should be performed; nor do they fail to complete the act with prayers and rites, which must be responded to with handsome presents. A similar observation applies to the funeral ceremonies of the Tibetans. Properly speaking, there are none requiring the assistance of the clergy, for Lamaism does not allow the interment of the dead. Persons distinguished by rank, learning, or piety, are burned after their death; but the general mode of disposing of dead bodies in Tibet, as in Mongolia, is that of exposing them in the open air, to be devoured by birds and beasts of prey; yet it is the Lama who must be present at the moment of death, in order to superintend the proper separation of body and soul, to calm the departed spirit, and to enable him to be reborn in a happy existence. He must determine the auspicious day and hour when, and the auspicious place where, the corpse is to be exposed. The most lucrative part of his business, however, is the masses which he has to perform, until the soul is released from Yama, the infernal judge, and ready to re-enter into its new existence; the doctrine of metempsychosis being the same in this religion as in Buddhism.

One of the most interesting features of Lamaism is the organisation of its hierarchy. Its summit is occupied by two Lama popes, the one called *Dalai-lama*, i. e., Ocean-priest, or priest as wide as the ocean—he resides at Potala, near H'lassa—the other bearing the titles of *Tesho-lama*, *Bogdo-lama*, &c., and officially called *Pan-chhen Rin po che*, literally, 'the right reverend great teacher-jewel' (i. e., precious teacher); he resides in the convent at bKra Shiss Lhun po, near gShiss Ka rTse. In theory, both popes have the same rank and authority, in spiritual as well as in temporal matters; but as the Dalai-lama possesses a much larger territory than the other, he is in reality much more powerful. Next in rank are the *Khutuktus*, who may be compared to the Roman Catholic cardinals and archbishops. The third degree is that of the *Khubilghans* or *Hobilghans*—which Mongol name is more frequently given to them than the Tibetan title *Bjang chhub*—a translation of the Sanscrit *Bodhisattwa*. Their number is very great. These three degrees represent the clergy that claims to be the incarnation of the Buddhistic saints. The Dalai-lama and the Pan-chhen were in their former lives the two chief disciples of the great Lamaist reformer bTsong kha pa, who was an incarnation of the *Bodhisattwa Amitabha*, or, as some will have it, of Manjusri and Vajrapani, and who is reputed

to have founded, in 1355 or 1357 of the Christian era, the present system of the Lama hierarchy. The *Khutuktus* were in their prior existences other Buddhistic saints of very great renown; and the *Khubilghans* are those reborn hosts of saintly patrons whom the temples and convents of Lamaism possess in boundless numbers. Up to the end of last century, the clergy of these various classes determined the choice of the children into whose bodies the souls of their departed members had migrated. At present, however, it seems that the emperor of China exercises a paramount influence on the discovery of those transmigrations—or, in other words, on the filling up of clerical posts—and there can be no doubt that his influence is supreme in the case of determining the election of the two highest functionaries of this theocracy. In order to ascertain the re-birth of a departed Lama, various means are relied upon. Sometimes the deceased had, before his death, confidentially mentioned to his friends where and in which family he would re-appear, or his will contained intimations to this effect. In most instances, however, the sacred books and the official astrologers are consulted on the subject; and if the Dalai-lama dies, it is the duty of the Pan-chhen to interpret the traditions and oracles; whereas, if the latter dies, the Dalai-lama renders him the same service. The proclamation of so great an event, however, as the metempsychosis of a Dalai-lama or Pan-chhen is preceded by a close examination of the child that claims to be in possession of the soul of either of these personages. The reborn arch-saint, usually a boy four or five years old, is questioned as to his previous career; books, garments, and other articles, used and not used by the deceased, are placed before him, to point out those which belonged to him in his former life. But however satisfactory his answers be, they do not yet suffice. Various little bells, required at the daily devotions of the Lama, are put before the boy, to select that which he did use when he was the Dalai-lama or Pan-chhen. 'But where is my own favourite bell?' the child exclaims, after having searched in vain; and this question is perfectly justified; for, to test the veracity of the reborn saint, this particular bell had been withheld from him. Now, however, there can be no doubt as to the Dalai-lama or Pan-chhen being bodily before them: the believers fall on their knees, and the Lamas who successfully performed all these frauds join them in announcing the momentous fact.

Besides these three classes of the higher clergy—representing the incarnate existences of departed saints, and chosen, therefore, without regard to merit, amongst the children of privileged families—Lamaism possesses a lower clergy, which, having no claim to incarnate holiness, recruits its ranks on the principle of merit and theological proficiency. It has four orders: the pupil or novice, who enters the order generally in his seventh or ninth year; the assistant priest; the religious mendicant; and the teacher, or abbot. To these may be added two academical or theological degrees, and also two dignities, conferred by the sovereign Lamas on those doctors who have distinguished themselves by extraordinary sanctity or learning. All the members of these orders must make the vow of celibacy, and by far the greatest number of them live in convents. A Lamaist convent, *dGon pa*, consists of a temple, which forms its centre, and of a number of buildings connected with the temple, and appropriated to the meeting-rooms, the library, refectory, dwellings, and other spiritual and worldly wants of the monks. At the head of the convent is a *Khubilghan*, or an abbot, the latter being elected by

the chapter, and appointed by the Dalai-lama, or the provincial Khubilghan. In addition to these orders of monks and convents, Lamaism has likewise its nuns and nunneries.

The Lamaist bible bears the name of *bKa' giur* (pronounced *Kanjur*)—i. e., 'translation of the words,' *scil.*, of the Buddha. It contains not less than 1083 works, which in some editions fill 102 to 108 volumes in folio. It consists of the following sections: 1. *Dulba* (Sanskrit, Vinaya), or discipline; 2. *Sher phjin* (Sans. Prajñāpāramitā), or philosophy and metaphysics; 3. *Phal chen* (Sans. Buddhavata Sangha), or the doctrine of the Buddha, their incarnations, &c.; 4. *dKon br'Tsegs* (Sans. Ratnakūṭā), or the collection of precious things; 5. *mDo saDe* (Sans. Sātra), or the collection of Sātras; 6. *Mjang dass* (Sans. Nirvāna), or the liberation from worldly pains; 7. *rGyud* (Sans. Tantras), or incantations, &c. Besides this mass of works, there is a very voluminous collection, the *bas Tan 'gyur*, or the translation of the doctrine, in 225 vols. in folio; but it does not seem to possess canonical authority.

The oldest history of Lamaism is shrouded in darkness. For its growth and development under the Mongol and Manju dynasties, see the article **TIBET**.—The best work on Lamaism is *Die Lamaische Hierarchie und Kirche, von Karl Friedrich Koeppen* (Berlin, 1859). See also Huc, *Souvenirs d'un Voyage dans la Tartarie, le Tibet et la Chine* (Paris, 1852); and Karl Ritter's *Erdkunde* (vol. iv.).

LAMA'NTIN. See **MANATEE**.

LAMARCK, JEAN BAPTISTE PIERRE ANTOINE DE MONET, CHEVALIER DE, a most distinguished French naturalist, was born of a noble family at Barentin, in Picardy, August 1, 1744. He was intended for the church, but preferred the army. An accidental injury, which placed his life in danger, put a stop to this career, and he became a banker's clerk. His first scientific pursuit was that of meteorology, from which he turned to botany, and attempted to introduce a new system of classification, which he called the Analytical System, but which met with little acceptance. In 1778, he published his *Flore Française* (3 vols.), which was afterwards made the basis of the work of Decandolle. Shortly after, he was appointed botanist to the king, and tutor to the son of Buffon, with whom he visited foreign countries, and inspected their botanical collections. He also contributed many botanical articles to scientific works. After a considerable portion of his life had been spent in the earnest study of botany, L. devoted himself chiefly to zoology, and in 1793 was made professor of the natural history of the lower classes of animals in the *Jardin des Plantes*. He rendered very important services to this branch of science. His greatest work is his *Histoire des Animaux sans Vertèbres* (7 vols. Paris, 1815—1822; 2d edition by Deshayes and Milne-Edwards, Paris, 1835, &c.). In his *Philosophie Zoologique* (2 vols. Paris, 1809), and some other works, he indulged in extremely speculative views, some of which, however, are attracting great attention in the scientific world at the present day. L. was the first (if we except a few obscure words of Buffon towards the close of his life) to set forth the theory of the 'Variation of Species,' which has been recently revived by Darwin. L. died 20th December 1829, after having been for seventeen years blind, in consequence of small-pox.

LA MARMORA, ALFONSO, MARQUIS DE, a Sardinian general and statesman, born 17th November 1804. In 1816 he entered the military academy,

where he received the grade of lieutenant in the artillery, previous to leaving in 1823. He was speedily promoted to be adjutant-major, and directed his special attention to the improvement of regimental gymnastics, riding, and shooting, and to the organisation of normal schools for the benefit of the private soldiers. In 1831, having obtained his captaincy, he set out on a tour of inspection of the great military establishments both of Europe and the East. In 1845, he became major, and for his distinguished conduct in the national war of 1848, was decorated with the medal of valour. The services he then rendered the Sardinian army removed from the mind of Charles Albert a prejudice which his warm advocacy of military reform had aroused in the king. In 1849, he entered the cabinet as Minister of War, and notwithstanding his sincere zeal for useful reforms, a general spirit of censure was evoked by his vigorous efforts to displace from the Sardinian ranks the Italian refugees who had entered the regular army. In 1855, he withdrew from the ministry, to assume the command of the Sardinian troops in the Crimea, and at the close of the war was invested with the Order of the Bath, and the Grand Cross of the Legion of Honour, and re-entered the ministry in his former capacity. He took an active part in the war of 1859, by which Lombardy was acquired by the king of Sardinia, and has been recently appointed military governor of Naples. A rigid disciplinarian and zealous military reformer, La M. belongs, by his political opinions, to the conservative Sardinian party, rather than to that of the party of progress, to whose irregular military combinations he is strongly averse.

LAMARTINE, ALPHONSE, was born at Mâcon, 21st October 1792. In his *Memoirs of my Youth*, he has given us a touching account of the hardships to which his family was subjected during the Reign of Terror. He was educated principally at the college of the Pères de la Foi, at Belly. On leaving college, he spent some time in travelling in Italy. After the fall of Napoleon, he entered the army, which, however, he soon quitted, revisiting Italy in 1818. In 1820, appeared his *Méditations Poétiques*. The success of this work helped to open up for him a diplomatic career. He was appointed *attaché* to the French embassy at Naples, and on his way thither married, at Chambéry, a beautiful and accomplished English lady, Miss Birch, whom he had met the year before in the valleys of Savoy. In 1823 appeared his *Nouvelles Méditations*, and in 1824 he became secretary of the legation at Florence. An unlucky expression which L. had used, descriptive of the Italians, in his *Dernier Chant de Child Harold* (1825), led to a duel between him and Colonel Papé. Though L. was wounded, the result, luckily, was not serious. In 1829 appeared the collection of *Harmonies Poétiques et Religieuses*. In the same year he was elected a member of the French Academy. After the revolution of 1830, having failed to procure a seat in the Chamber of Deputies, he set out in 1832 to travel in the East. The death of his only daughter threw a gloom over this period of his life. Receiving news, when at Jerusalem, of his election by the constituency of Bergues, he returned to Paris. Though he soon became a noted speaker in the Chamber, he still vigorously pursued his literary studies. In 1835, he published an account of his eastern travels. The *History of the Girondins*, which originally came out in journals, was, in 1847, published complete in 8 vols. It had unquestionably much influence in bringing about the great events of the following year. When the Revolution took place in February 1848, L. became a member of the

Provisional Government and Minister of Foreign Affairs, and exercised a great influence over the first movements of the new republic. Ten departments elected him as their representative in the Constituent Assembly; he was also chosen one of the five members of the Executive Commission, and enjoyed for some months an immense popularity; whilst his spirited and patriotic conduct, in crushing the mere anarchic insurrections of the 16th April and 15th May, must be regarded as having prevented great evils. Yet this was one of the principal causes of his downfall; the crowd became enraged, the assembly hostile, and the supreme power passed for a brief period into the hands of Cavaignac (q. v.). Though L. was nominated for the presidency, but few votes were recorded in his favour; and the *coup d'état* of 2d December 1851 sent him back to private life. From that time he gave himself almost wholly to literary pursuits. His *History of the Revolution of 1848* had appeared in 1849. It was followed, in 1851—1852, by his *History of the Restoration of Monarchy in France*; and in 1854, by the *History of Turkey*. He also contributed largely to several journals. L. was altogether one of the most remarkable Frenchmen of his day, and one of the most voluminous writers of his country. His style is picturesque and fascinating, but its effect is often marred by egotism and vanity. He died March 1, 1869.

LAMASOOL, or **LAMB'S-WOOL**, an old English beverage, composed of ale and the pulp of roasted apples, with sugar and spices. The name is from the ancient British *La maes abhal*, the day of apples, because this beverage was drunk at a feast on the apple-gathering in autumn.

LAMB, CHARLES, an English poet and essayist, was born in the Temple, on the 18th February 1775, and received his education at Christ's Hospital, where he had Coleridge for a school-fellow. With Coleridge, Wordsworth, Hunt, Hazlitt, and other distinguished men of his time, he lived in affectionate intimacy. In 1792, he became a clerk in one of the departments of the India House; and in 1825 he was allowed to retire with a pension granted by the directors. His first poems appeared in a small volume, in which venture Coleridge and Lloyd were his partners. In 1801, he published *John Woodrill*, a drama, in which he looks upon man and nature with the eye of an Elizabethan. His *Essays of Elia* were originally published in the *London Magazine*. L. was never married; he lived with an only sister, who was subject to insane fits—in one of which she killed her mother—and for whom he cherished the tenderest affection. He died in London, on the 27th December 1834. Since his death, Mr Justice Talfourd published two volumes of his *Letters*; and these, in 1848, he supplemented by the *Final Memorials*, in which, for the first time, the world became acquainted with the story of his sister.

The poems of L. were never widely read, nor are they yet; his reputation rests entirely upon his criticisms and his *Essays*. The critical remarks appended to his *Specimens of English Dramatic Poems* are of the highest value, while his *Essay on the Genius of Hogarth* is considered by many the finest critical paper in the language. In the qualities of grace, quaintness, and a certain tenderness of humour, 'a smile on the lip, and a tear in the eye,' the *Essays of Elia* are unique; the author is reflected in them with all his whims, his wit, his poetic instinct, his charity, and his odd ways.

LAMBALLE, MARIA THERESA LOUISA OF SAVOY-CARIGNAN, PRINCESS OF, a victim of the French

Revolution, was born at Turin, 8th September 1749, and was the daughter of Prince Louis Victor Amadeus of Orléans. She was very beautiful and amiable, and was married, in 1767, to Louis Alexander Joseph Stanislaus de Bourbon, Prince of Lamballe, who soon after died, a victim of debauchery. The princess became the intimate friend and chosen companion of Marie Antoinette. At the time of the attempted flight of the king and queen, she sought refuge in England, but returned to them in February 1792. After the events of the 10th of August, she received permission to share the captivity of the queen, but was soon separately immured in the prison of La Force, and on 3d September was brought before the tribunal, and commanded to swear that she loved liberty and equality, and hated the king, the queen, and royalty. 'The first oath,' she replied, 'I will swear, but the rest I cannot: my heart rebels against it.' Many of those who stood by were anxious that she should escape, but she did not hear the advices which they addressed to her. 'Let madame go!' said the president; and at this signal of death two men conducted her to the door, where she received a stroke of a sabre on the back of her head, when blood spouted up, and her long hair fell down. On receiving a second stroke, she fell, and the murderers tore her body to pieces, placed her head and heart upon pikes, and brutally paraded them before the windows of the Temple, where the royal family were confined.

LAMBEAU'X, a cross, in Heraldry, is a cross formed in the upper like a cross pattée, but with the lower limb not widened, but terminating in a label of three points, 'having,' according to Sylvanus Morgan, 'a great deal of mystery in relation to the top, whereon the first-born Son of God did suffer, sending out three streams from his hands, feet, and sides.'



LAMBERT, JOHANN HEINRICH, a philosopher and mathematician, was born 29th August 1728, of German parentage, at Mühlhausen, now in the department of Haut-Rhin, France. His talents and application to study having gained him friends, he obtained a good education, and made remarkable progress in mathematics, philosophy, and oriental languages. He obtained a situation as clerk in an office, and gradually rose, till Frederick the Great, in 1764, summoned him to Berlin, and made him a member both of the Council of Architecture and of the Academy of Sciences. He died at Berlin, 25th September 1777, leaving behind him the renown of having been the greatest analyst in mathematics, logic, and metaphysics that the 18th c. had produced. He was the first to lay a scientific basis for the measurement of the intensity of light, in his *Photometria* (Augsb. 1760), and he discovered the theory of the speaking-tube. In philosophy, and particularly in analytical logic, he sought to establish an accurate system by bringing mathematics to bear upon these subjects, in his *Neues Organon, oder Gedanken über die Erforschung und Beziehung des Wahren* (2 vols. Leip. 1764). Of his other works, we may mention his profound *Kosmologische Briefe über die Einrichtung des Weltbaus* (Augsb. 1761), and his correspondence with Kant.

LAMBERT, JOHN, an English parliamentary general, was born at Kirkby-Malhamdale, in Yorkshire, September 7, 1619, and on the outbreak of the Civil War, became a captain under Fairfax. He fought at Marston Moor, at Naseby, in Scotland, and at Worcester, but did not acquire importance

till after the death of the great Protector, when he became the head of the cabal of malcontent officers who overthrew the feeble administration of Richard Cromwell. L. was now looked upon as the leader of the Fifth Monarchy or extreme republican party; suppressed, with considerable vigour, the royalist insurrection in Cheshire, August 1659; and two months afterwards, dismissing the remnant of the Rump Parliament, virtually governed the country along with his officers under the title of the 'Committee of Safety.' For a brief period, his position was considered so important, that Charles II. was advised to make terms with him by marrying his daughter. The counterplot of Monk, however, frustrated all his designs; and on the 22d of April he was taken prisoner by a Colonel Ingoldsby, tried in 1662, and banished to the isle of Guernsey, where he died in 1692.

LAMBETH, a parliamentary borough of England, in the county of Surrey, forms a great part of the south-west quarter of London. It is said to cover an area of 8840 acres, and had, in 1861, a pop. of 294,883. Besides Lambeth Palace, which has been the official residence of the archbishops of Canterbury for several centuries, it contains Astley's Theatre, the site of the once famous Vauxhall Gardens, and the Surrey Zoological Gardens. It returns two members to the House of Commons.

LAMBREQUIN, a word used in Heraldry in three senses: 1. The mantling attached to the helmet, and represented as depending over the shield (see MANTLING); 2. A Wreath (q. v.); 3. The point of a label. See LABEL.

LAMB'S LETTUCE. See CORN SALAD.

LAMEGO, an old town of Portugal, in the province of Beira, is situated amid rocky mountains on an affluent of the Douro, about three miles from that river, and forty-six miles east of Oporto. It contains a Gothic cathedral; and there are ancient remains both Roman and Moorish. Pop. 9500.

LAMELLIBRANCHIATA, a class of acephalous molluscs, all of which have bivalve shells (see BIVALVES), and which respire by gills in the form of vascular plates of membrane attached to the inner surface of the mantle. Oysters, cockles, and mussels are familiar examples. The *adductor* muscle, which closes the shell, is single in some, double in the greater number. More important differences exist in the powers of locomotion possessed by some, and denied to others. Thus, oysters are fixed to one spot by one of the valves of the shell; but most of the L. have the power of moving by swimming, leaping, or burrowing in sand, sometimes in more than one of these ways, being provided for this purpose with a fleshy muscular organ called the *foot*. Some, as mussels, when they have found a suitable place, fix themselves there by a *byssus* (q. v.). The mouth of the L. is jawless and toothless, and all seem to depend for their food on the currents of water continually brought by ciliary action into the mouth. They all seem more or less sensible to light, and numerous small red spots on the edge of the mantle of some are supposed to be eyes. They have organs of hearing, and labial tentacles, which are supposed to exercise the sense of smell.

LAMELLICORNES, a very numerous family of coleopterous insects, of the section *Pentamera*, containing the largest of the beetles, as well as many species remarkable for peculiar conformations of the head and thorax. The three last joints of the

antennæ are flattened into lamellæ, which are sometimes disposed like the leaves of a fan, sometimes like teeth of a comb. Many of the L. feed on decaying animal or vegetable matter, but some on leaves or flowers; the latter are generally of brilliant metallic



Lamellicornis:
Stag-Beetle (*Lucanus cervus*).

colours; the former, black or brown. The larvæ are soft, cylindrical, with six small legs, and the body always curved. Dung-beetles, stag-beetles, cockchafers, &c., belong to this family.

LAMELLIROSTRES, in the system of Cuvier, a large group of web-footed birds (*Palmipedes*), distinguished by a thick bill having tooth-like *lamellæ* at its edges, apparently more for the purpose of straining water from the food than of masticating or comminuting it. The *Anatidæ* and *Mergidæ* (ducks, swans, geese, goosanders and mergansers) constitute the group of Lamelliostres.

LAMENNAIS, FÉLICITÉ ROBERT DE, one of the most celebrated of the politico-religious writers of France during the present century, was born of a family engaged in the shipping-trade at St Malo, June 6, 1782. With the exception of some instruction in Latin, which he received from his elder brother, L. was, owing to the revolutionary troubles, almost entirely self-taught. His early turn of thought was strongly religious, as well as decidedly literary; and resisting all his father's efforts to fix him in commercial life, he pursued a literary career, and in 1807 received an appointment as teacher of mathematics in the college of his native town. His first work, published in the next year, *On the State of the Church in France during the 18th Century*, is written in a strain of high orthodoxy, and directed against the materialistic philosophy of the 18th c., its influence still subsisting in the literature of his own time. A few years later—having meanwhile taken the clerical tonsure—he produced, in conjunction with his brother, a treatise *On the Tradition of the Church on the Institution of Bishops*, which arose out of the conflict of Napoleon with the Holy See as to the affairs of the church in France. During the Hundred Days, he was obliged to flee to England, where he was received by the celebrated Abbé Caron; and on his return to France, he entered the seminary of St Sulpice, where he received priest's orders in 1816. A year afterwards, he published his most celebrated work on the side of orthodoxy, *An Essay on Indifference in Religion*, which is a work of exceeding acuteness, and of great learning and brilliancy. In this work, however, he pushes the claim of authority to such a length, and makes all reasoning resolve itself so completely into authority, that even those who agreed in the conclusion at which he arrived, were not surprised at the recoil by which, this principle

LAMENTATIONS OF JEREMIAH—LÄMMERGEIER.

of authority once abandoned in his after-conflict with the church, his mind rushed into the opposite extreme of utter and unlimited unbelief. The celebrity which this work won for him led to a design on the part of the pope, Leo XII., to promote L. to the cardinalate. This design, however, was afterwards abandoned. L.'s political views, from the first moment of the Restoration, had been liberal. Nevertheless, he joined himself to a powerful and active section of the most distinguished members of the royalist and church party—Chateaubriand, De Bonald, Frayssinous, and others, the organ of which was a journal named the *Conservateur*, and afterwards the *Defenseur*, and the *Drapeau Blanc*; but he rapidly outstripped the views of most of his colleagues. He was fined, in 1824, for a work *On the Relations of Religion and Politics*. After the revolution of 1830, while he adopted in its fullest sense the doctrine of the sovereignty of the people, he continued a zealous adherent of the faith of the church; and, in conjunction with a number of ardent young friends, all of whom have since risen in their various lines to distinction—Montalembert, Lacordaire, Gerbet, and others—he established a journal called *L'Avenir*, the aim of which was to reconcile liberty and religion. The doctrines of this journal on the separation of church and state and on many other popular topics, gave grave offence to the ecclesiastical authorities. They were censured by the pope, Gregory XVI., in 1832; and L., in obedience to the papal sentence, discontinued his journal, and professed his future submission to authority; but from this date his opinions underwent a rapid change, and in a work which he published in the year 1834, and which obtained an immediate and unprecedented popularity in France, *Paroles d'un Croquant*, proclaimed his complete and irreconcilable rupture with the church of which he had long been the champion. The work was immediately condemned at Rome; but it passed in France through innumerable editions, and was translated into all the languages of Europe; and the author's reply to the papal condemnation was in a still more pointedly aggressive work, in 1836, entitled *Affaires de Rome*. With his characteristic impetuosity, he now threw himself into the arms of the opposite party. His successive publications, *The Book of the People* (1837), *The Country and the Government* (1840), *On Religion* (1841), *The Guide of the First Age* (1844), *A Voice from Prison* (1846), were but so many new utterances of the most extreme democratic principles. The revolution in his religious sentiments was equally decisive and complete; he not merely ceased to be a Romanist, but even a believer. In his last illness, he declined all religious ministrations; and at his death, which occurred February 27, 1854, he gave directions that his interment should not be marked by any religious ceremony. He also directed, by his will, that certain papers which he left ready for press should be published without alteration; and on the refusal of his niece to surrender these papers, a suit-at-law was instituted, which terminated in an order for the surrender of the papers, in accordance with the will of the testator. The most elaborate work of L.'s latter period is his *Esquisse d'une Philosophie* (4 vols. 1840—1846).

LAMENTATIONS OF JEREMIAH (*Megillath Echa*; lxx. *Threnoi*), the name given to one of the canonical books of the Old Testament, containing laments over the desolation of the land, the exile of the people, the destruction of the first temple, the fall of the kingdom of Judah, and the writer's own woes. These laments are five in number, and are

closely connected in regard to their subject-matter; but considerable diversity of opinion exists concerning their artistic relation to each other. Some, as De Wette, Ewald, and Keil, have tried to shew that they are really parts of one poem; others, as Eichhorn and Bertholdt, that they were originally quite independent and isolated elegies; while a third party, as Lowth and Davidson, hold that there is a certain pervading harmony of sentiment and idea, indicating, probably, that they were composed by the poet-prophet under the same condition of religious feeling. The structure of the laments is very artificial. Most critics are satisfied, from internal evidence, that the tradition which makes Jeremiah their author is worthy of credence, and that they were all written by him shortly after the destruction of Jerusalem.

LAMINARIA. See TANGLE.

LAMINATION, the arrangement of rocks in thin layers or laminae, the condition of a large proportion of the earth's strata. Shale deposits exhibit this structure very plainly, being frequently easily separable into the thin laminae in which they were originally deposited. Shale is the fine sediment that settles down at the bottom of some tranquil or slightly moving water. The laminae indicate interruption in the supply of the materials, which may have been occasioned by successive tides, by frequent or periodical floods, or by the carrying medium having access to a supply of different material, passing, e. g., from mud to sand, and back again to mud. The laminae of the brick-clay deposits are separated, in many places, by the finest sprinkling of sand, which is almost invisible in the vertical sections. The layers are occasionally obvious, from their being of different shades of colour, often produced by the bleaching of the layers when they were deposited; but frequently the various laminae of a bed are so united, and the bed so homogeneous, that except when the face is exposed to weathering, the laminated structure is not visible. This condition seems to have resulted from the shortness of the interruptions in the deposit not permitting the solidification of any of the layers until all was deposited, when the whole set cohered together as a single bed.

LÄMMAS-DAY, the 1st of August, is one of the cross quarter-days, or half-quarter days, in England. On this day, which is the feast of St Peter ad Vincula, it was customary in early times to make offerings of the first-fruits of the harvest, and hence the feast took the name of *Hlafmass* (Ang.-Sax., loaf-mass or loaf-festival), afterwards corrupted into Lammas. In Scotland, it is the practice with farmers to pay the half year's rent due at Whitsunday on Lammas-day.

LÄMMERGEIER (*Gypaëtos barbatus*), a large bird of prey, also called the BEARDED VULTURE, BEARDED GRIFFIN, and GIER-EAGLE. It is the only known species of its genus, which forms a connecting link between vultures and eagles, although commonly ranked among the *Vulturidae*, to which it approaches most nearly. The full-grown L. is of a shining brownish black on the upper parts, with a white stripe along the shaft of each feather; the head is whitish, with black stripes at the eyes; the neck and under-part of the body are rusty yellow. It is 4 feet high when sitting; nearly 5 feet long; and from 9 to 10 feet in expanse of wing. It is very bold and rapacious, swooping down on hares, lambs, young goats, chamois, &c., and sometimes carrying off children. It lives on animals newly killed, eating carrion only when pressed by necessity. It was once pretty common in the Alps, but is now rare.

It is found also in the Pyrenees, and in the mountains of Asia, South America, and the north of



Lammergeier (*Gypaetos barbatus*).

Africa, and will soar high above the loftiest peaks.

LAMMERMOORS, a range of low hills in Scotland, running in an east-north-east direction for one half of their length on the boundary-line between East Lothian and Berwickshire, the other half lying in the south-eastern corner of the former county, and forming, where it meets the German Ocean, a bold, rocky, and dangerous coast. The L. send off several minor ranges southwards into Berwickshire. The highest summits are Lammer Law (1732 feet) and Spartleton (1534 feet).

LAMORICIÈRE, CHRISTOPHE LÉON LOUIS JUCAULT DE, a French general, was born at Nantes, 5th February 1806, studied at the Ecole Polytechnique, and after the revolution of 1830, went to Algeria as a lieutenant of engineers. In 1833, he became chief of the battalion of Zouaves; in 1835, lieutenant-colonel; and in 1837, colonel. He particularly distinguished himself at the siege of Constantine. In 1843, he was appointed a general of division; in the following year, commander of the Legion of Honour; and in 1845, interim-governor of Algeria. To him belongs the glory of concluding the war in Africa, where he had made no fewer than eighteen campaigns, by forcing Abd-el-Kader to surrender in 1847. On the outbreak of the revolution in February 1848, he nearly lost his life in endeavouring to proclaim the regency of the Duchess of Orleans. In June 1848, he commanded the attack on the barricades, and quelled the anarchic tumults of the Socialists. He was war-minister during the government of General Cavaignac, to whose republican party he afterwards attached himself in the Legislative Chamber; but being a very decided opponent of the schemes of Louis Napoleon, he was arrested on the occasion of the *coup d'état* of 2d December 1851, and at first imprisoned in Ham, but afterwards conveyed out of France and set at liberty. During his exile, which he spent in Germany, Belgium, and England, the great soldier

became *devout*, as his countrymen phrase it; and when the Italian war of independence threatened the safety of the pope, L. proceeded to Rome in 1860, and was appointed by Pius IX. commander of the papal troops. He was, however, compelled to surrender with his whole force to the Sardinian general, Cialdini, at Ancona. He died Sept. 1865.

LAMP-BLACK, the soot produced by burning resin, turpentine, pitch, oil, and other matters, in such a manner that large volumes of smoke are formed and collected in properly arranged receptacles. Lamp-black is the colouring matter of black and slate-coloured paints.

Large quantities of this pigment are made in Germany by burning the refuse resin and fragments of fir and pine trees. The combustion is carried on slowly, and the dense smoke passes up a long flue, at the top of which is a large hood made of coarse woollen cloth. In this hood the carbon is deposited rapidly at the rate of twenty to thirty pounds an hour, which is collected by lowering the cloth hood, and shaking it out. In Great Britain, a similar process is adopted; but large quantities of an inferior kind are also collected from the flues of coke-ovens; and a superior kind, known as *bone-black*, is obtained from the flues of kilns in which bones are calcined for manure. By mixing lamp-black in various proportions with white-lead, every gradation of colour, from jet black up to slate and gray, can be easily produced.

LAMPREY (*Petromyzon*), a genus of cartilaginous fishes, Dermopterous (q. v.), and having a circular mouth formed for sucking (*cyclostomous*). They are of eel-like form, and have no scales. The skeleton is very soft and imperfect. The tongue acts as a piston in the sucking mouth, which is armed with numerous hard teeth, or tooth-like tubercles. There are seven roundish gill-orifices on each side; the German name is *Neun-Augen* (Nine-eyes). Lampreys have the power of drawing in as well as of expelling water through the gill-orifices, and thus respiration is carried on even when they are firmly attached to some object by the sucking mouth. Lampreys often attach themselves very firmly to stones, and seem to rest

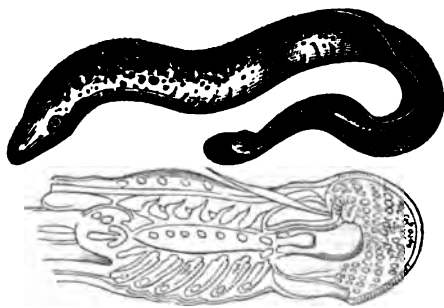

Common Lamprey (*Petromyzon marinus*).

with the body floating in the water; they live by sucking the blood of fishes, the skins of which their teeth readily pierce, and which are unable to shake them off. They eat also any soft animal matter. The species are numerous, and are widely distributed in the seas of different parts of the world. Some of them are periodical visitants of fresh waters, as the COMMON L. (*P. marinus*), found on the shores and in the rivers of most parts of Europe. It sometimes attains a length of more than three feet, and is often two feet long. It ascends rivers in the latter part of spring or beginning of summer, for the

LAMPREY—LAMPS.

purpose of spawning. It was formerly in the highest esteem for the table, and it is an old custom for the city of Gloucester to present a L. pie annually to the sovereign. Worcester is also famous for its L. pies and potted lampreys. In Scotland, a strong prejudice exists against the lamprey.—The L. of North America, although very similar, is said to be a distinct species (*P. Americanus*).—A smaller species, the RIVER L. (*P. fluviatilis*), often called the LAMPREY, is very abundant in some of the rivers of England, at certain seasons of the year. It is seldom more than 15 or 18 inches long, blue above, silvery white beneath. It is used for pies, like the common lamprey.—A little blood thrown into water where lampreys are supposed to be, soon attracts them to the spot. They are caught by baskets and other traps, like eels. They are very tenacious of life, living for days in a damp place, out of the water.

LAMPS are contrivances in which to burn any light-giving material, and so make use of its illuminating power. The most primitive lamps were probably the skulls of animals, in which fat was burned; and certain sea-shells formed admirable lamps for those to whom they were attainable. Even at the present time, occasionally may be seen suspended in the cottages of Zeland, shells of the 'roaring buckie' (*Fusus antiquus*, q. v.), which form, perhaps, the most ancient kind of lamp in existence.

When pottery and metal began to be used, the principle of these natural lamps was for a long time retained, as seen in ancient Egyptian, Greek, and Roman lamps (fig. 1), and in the stone cups and boxes of northern nations. The invention of lamps has been attributed to the Egyptians, but it is far more probable they received it from the older



Fig. 1.

civilisation of India. Herodotus (ii. c. 62) reminds us of the Chinese feast of lanterns, by speaking of the feast of lamps at Saïs, in Egypt. Such lamps as that in fig. 1 were called *lychna* by the Greeks, and *lucerna* by the Romans, and various modifications of the form are frequently found in the ruins of Greek and Roman cities; very considerable numbers have been obtained from the excavations of Tarsus and of Pompeii and Herculaneum. The principle in all is the same. At first, these *lucernæ* were made of unglazed pottery, and only with one wick-hole; but better material and more elaborate forms were introduced, and their light-giving power was increased by their being made to hold several wicks, from two to twelve. The wick used in this lamp was generally made of flax-tow, sometimes, however, of rushes and other vegetable fibres.

Amongst the northern nations of antiquity, lamps were in use, but the difference of climate necessitated a different kind of lamp. The limpid oils of the present day were unknown to our Celtic and Saxon forefathers; besides, the cold winters would have solidified them, and they would not have been drawn up by the wick, if arranged as in the old Roman and Greek *lucernæ*. The solid fat of various animals was their chief illuminating material, except on the sea-coast, where seal and whale oil occasionally helped them. Small open stone pots, afterwards exchanged for metal, were

used, and being partly filled with grease, a wick was thrust down through the middle, and being lighted, consumed the fat as it melted. Stone cups of this kind are occasionally dug up in Scotland and elsewhere: in principle, they are the same as the *padelle*, used in Italian illuminations, and the old grease-pots, which formed the foot-lights of our theatres not many years since, and which may still occasionally be seen in the travelling-shows at country fairs. The Esquimaux form square boxes of soap-stone, and use them in the same way.

No great improvement took place in the construction of lamps until the beginning of the present century. Taste had been shewn in the designs, but the principle remained the same; a wick sucking up oil from the reservoir of the lamp to supply itself during combustion, and nothing more, if we except the improvement effected by the invention of M. Argand in 1784. See ARGAND. In 1803, M. Carcel, another Frenchman, made an excellent improvement on the lamp by applying clock-work, which acts by raising the oil up tubes in connection with the wick, so that the latter is kept continually soaked. If properly managed, this is perhaps the best of all oil-lamps, as it will keep up a well sustained and brilliant light for seven or eight hours, and the light rather increases than otherwise as the lamp burns and becomes warmer, thereby rendering the oil more

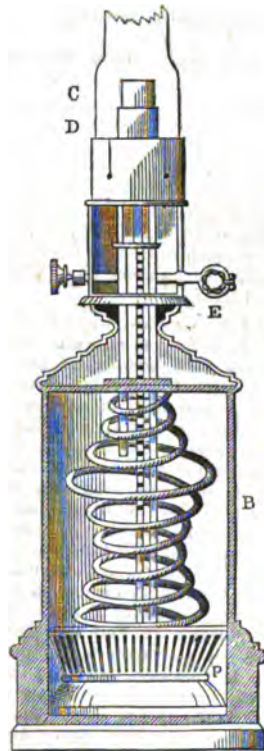

Fig. 2.



Fig. 3.

limpid. But the Carcel lamp has two disadvantages: it is expensive, and is easily disarranged, therefore it has never become common.

The greatest improvement ever effected in oil-lamps was in the so-called French moderator (fig. 2),

which combines the greatest amount of illuminating power with elegance of form, easy management, and general economy. Its body is a cylinder, B, usually about 8 inches in height by 5 inches in diameter, the lower part of which contains the store of oil. On the top of the oil rests a piston, P, which is constantly pressed down by a spiral spring situated between it and the top of the barrel. The piston is represented in the figure as resting on the bottom. Through the piston is inserted a small tube, which passes up to the burner at the top; and the pressure of the spring on the piston causes a constant stream of oil to rise up through this tube and feed the wick, C. What is not consumed, flows over the burner, D, and back into the barrel above the piston. It is above the piston also that fresh oil is introduced. When the piston has reached the bottom, it is wound up again by a rack and pinion, E; and a vacuum being thus formed, the oil above it is forced to the underside through a valve-kind of contrivance round its edge.

It is obvious that in this machine the flow of oil will be greatest when the piston has been newly wound up, and the spring is at its greatest tension. This inequality is regulated, or *moderated*—hence the name of the lamp—by an extremely ingenious contrivance. The tube through which the oil ascends (represented in fig. 3 on an enlarged scale) consists of two parts—a narrower, *b*, fixed to the piston, and rising with it, and a wider, *c*, fixed to the burner, and forming a sheath into which the other ascends. Within the upper tube is placed a rod or wire, G, which descends so as to enter only a short way into the tube *b*, when the latter is drawn down to the full, as represented in the figure. Now, the effect of the rod within the narrow tube at *r* is to retard the passage of the oil; and it is evident that the effect will be greater the further the tube *b* is pushed up, because the narrow part is then made longer. The obstruction thus increases and diminishes with the force of the spring, and the flow of oil is rendered equable.

The use of oil-lamps has been greatly diminished by the rapid extension of gas-works, and by the invention of lamps to burn camphine, which is rectified oil of turpentine, and the various kinds of naphtha petroleum and paraffine oils.

These lamps require to be formed so as to insure perfect combustion of the material, for which purpose the reservoir of fluid is placed much below the flame, and the wick passes into it and sucks it up by capillary attraction. The glass chimney which surrounds the wick is always made very narrow at the bottom and top, with an enlargement round the flame (fig. 4). This figure insures a great indraught of air at the bottom, which keeps the combustion so perfect, that in a well-made lamp the smoke is imperceptible; in addition, there is an arrangement surrounding the wick-tube for admitting air, and bringing it into contact with the flame. These lamps give a most brilliant light; and as they not only have greater illuminating power, but are of cheap construction, and are very economical in other respects, they have come into very extensive use. Much care is required, however, in the selection of the fluid to be burned; some of the newly discovered petroleum and rock-oils are so very inflammable and explosive, that their use is dangerous. That made from the Torbanehill coal is free from danger, and is one of the most brilliant in burning.

LAMP-SHELL (*Terebratula*), a genus of brachiopod molluscs (see BRACHIOPODA), having a delicate

shell, of which one of the valves is larger and more convex than the other, prolonged backwards into a kind of beak, which is pierced by a hole or fissure. Internally, there is a delicate bony framework, of two branches, attached to the dorsal valve, by which the *arms* (see BRACHIOPODA) are supported. This is called the *loop*, and often by shell-collectors the *carriage-spring*. It is well seen in many fossil *Terebratulae*. The recent species are numerous, and very widely distributed from the polar to the tropical seas; the fossil species are extremely numerous.

LAMPYRIS AND LAMPYRIDÆ. See GLOW-WORM.

LANARK, a parliamentary and municipal burgh and market-town of Scotland, in the county of the same name, is situated on an elevation rising from the Clyde, 30 miles south-west of Edinburgh. Its antiquity is attested by the fact, that here, in 978, Kenneth II. assembled a parliament, or meeting of the estates of the realm. Little trade is here carried on; but the town derives some support from the numbers attracted to this district by the beauty of the scenery in the vicinity. L. unites with Hamilton and three other burghs in sending a member to parliament. Pop. (1861) 5384.—About a mile to the south, lies the manufacturing village of New LANARK (pop. 1396), celebrated as the scene of Robert Owen's experiment (1815—1827) for the social improvement of the working-classes.

LANARKSHIRE, or CLYDESDALE, an inland county of Scotland, lies west of the shires of Edinburgh, Linlithgow, and Peebles. Its length is 54 miles, and width 34 miles. Its area is 889 square miles, or 568,867 acres, of which there are under cultivation 321,568 acres. This county is subdivided into upper, middle, and lower wards. The first of these comprises more than one-half of the county, and consists in a great measure of hills and moorish ground; the second contains about 160,000 acres, much of which is unprofitable; the third, which contains the city of Glasgow, is nearly all cultivated, although very little of the soil, unless that bordering on the Clyde, is of first quality. The principal hills are the Lowthers, which rise in Green Hill to the height of 2403 feet; Tintock is 2335 feet high. In the upper ward is the village of Leadhills, which is 1323 feet above sea-level, being the highest inhabited place in Scotland. This county possesses great mineral wealth. There are upwards of 150 collieries, and 13 iron-works, having nearly 90 furnaces in blast. The cotton, flax, silk, and woollen factories (described in the article GLASGOW) are very extensive, and constitute one of the most important sources of wealth in the country. The county is watered principally by the Clyde (q. v.) and its affluents. L. was famous for its orchards as early as the time of the Venerable Bede. They yielded, early in the present century, as much as £8000 yearly, but have latterly fallen off; and the ground is more profitably employed in producing gooseberries, vegetables, &c., for the Glasgow market. The climate of L. is moist, and in many of the lower districts mild and genial, but often cold and boisterous in the high grounds. It is not in general well suited for raising grain-crops; but much of it is excellently adapted for the rearing of stock and for dairy purposes. In 1857, the number of occupants of land was 2931, and the total acreage under rotation was 321,568; of which there were 8363 acres of wheat, averaging 37 bushels 1½ pecks per acre; 2142 barley, 36 bushels 3¼ pecks; 57,041 oats, 36 bushels 3¼ pecks; 11,934 acres turnips, averaging 17 tons 1½ cwts. per acre; and 8253



Fig. 4.

LANCASHIRE—LANCASTER.

acres potatoes, 4 tons 9½ cwts. Of live-stock, the numbers were—horses, 8583; cattle, 59,108; sheep, 174,746; swine, 8906; total stock, 250,443. L. contains 55 parishes. It is amply supplied with railways, and good roads in almost every direction. Besides Glasgow, L. contains the royal burghs of Lanark, which is the county town, and Rutherglen, the towns of Hamilton, Airdrie, &c. L. sends one member to parliament; constituency, 5202. The pop. in 1861 was 631,566.

LANCASHIRE, one of the largest and the most populous counties in England, is bounded on the E. by Yorkshire, and on the W. by the Irish Sea; on the N. by Cumberland and Westmoreland, and on the S. by Cheshire. Area, 1,219,221 statute acres. Pop. 2,429,440. Increase in ten years, from 1851 to 1861, 411,843 souls. Annual value of property, including railways and canals, rated under schedule A, in 1857, £10,458,243; annual value upon which direct taxes were paid in 1857, including property, land, occupiers, and income taxes, £23,321,000. An outlying portion of the county, called Furness, whose greatest length is 25 miles, and greatest breadth 16 miles, is separated from the main portion by Morecambe Bay. The larger division is intersected in the north and east by branches of the hill system which runs southward through the counties of York and Derby, while Furness has on its eastern border the Cumbrian range. Towards the coast on the west the surface is flat, particularly in the larger division, with a curving outline and large stretches of sand, over which in various places the sea seems to be extending its dominion. The chief rivers are the Mersey, Ribble, Lune, Winster, Leven, and Duddon, all of which enter the Irish Sea by estuaries more or less important; Morecambe Bay, being the chief indentation. The climate is moist, but mild, the soil being peaty in the upland districts, but a fertile loam for the most part in the flats. Oats and potatoes are general crops; wheat also grows well in the southern division. Coal is the chief mineral product (the coal-field being estimated at 400 square miles in extent); lead and copper also occur, and iron is plentiful in Furness. The whole surface is covered with a net-work of canals and railways, which connect the principal manufacturing and commercial centres. See **MANCHESTER**, **LIVERPOOL**, **PRESTON**, **BLACKBURN**, &c. L. is famous for its immense cotton manufactures, which employ 315,630 persons almost wholly within the limits of the county. The consumption of cotton in 1860 was 2,392,000 bales of 400 lbs. each, and the value of the product was about £80,000,000, of which about £50,000,000 worth was exported. L. returns five members to parliament for the county, and twenty-two for boroughs within the county. The district of Furness presents many attractions to the tourist. On its north-eastern border stretches the beautiful lake Windermere, westward from which is Eastwaite Water; and further west, Coniston Lake, and the 'Old Man of Coniston,' with a height of 2577 feet. In the peninsula between the rivers Duddon and Leven is Furness Abbey, a noble ruin, the effect of which is enhanced by the picturesque beauty of the scenery in the vicinity. The abbey was founded by Stephen, Earl of Mortagne, or Mortoil, and afterwards king of England in 1127. The church is 237 feet long, the nave 70 feet broad. In the township of Whalley, in the east of L., is a very old church, and in the churchyard are three crosses, apparently of Saxon origin. In the vicinity are the ruins of an abbey of about the same age as Furness. A few miles from Whalley is the Roman Catholic college of Stonyhurst. The educational endowments of L. amount to upwards of £40,000

per annum, nearly £12,000 of which belongs to grammar-schools.

LANCASTER, a municipal and parliamentary borough and seaport of England, capital of Lancashire, is picturesquely situated on an eminence on the left bank of the Lune, near the mouth of that river, and 230 miles north-north-west of London. The ancient castle, which overlooks the town, is now used as a county jail and court-house. The houses are built of the freestone quarried in the vicinity, and though the streets are narrow, the town is neat and well built. The Lune is here crossed by a bridge of five arches, and by an aqueduct carrying the Lancaster Canal across the river. The town contains numerous scientific, benevolent, and educational institutions. There is some trade in coal and limestone. The chief manufactures are furniture, cotton, silk, table-baize, American leather, cloth, and cast-iron work. L. returns two members to the House of Commons. In 1862, 2423 vessels, of 302,583 tons, entered and cleared the port. Pop. (1861) of parliamentary borough, 16,005.

LANCASTER, a city of Pennsylvania, United States of America, 68 miles (by rail) west of Philadelphia, on the Pennsylvania Central Railway. The Conestoga river, made navigable by dams and locks, runs through the city, and supplies it with coal and lumber. It has a large court-house and prison, a theatre, 20 churches, Franklin and Marshall College, high-school, 1 daily and 6 weekly papers, 3 cotton factories, iron foundries, &c. It is particularly celebrated for the manufacture of rifles. Pop. (1860) 17,603.

LANCASTER, DUCHY OF. L. is a duchy and county palatine (see **PALATINE**) of England, created by royal charter, in which respect it differs from Durham and Chester. Edward III., on the death of Henry, Duke of Lancaster, conferred the duchy on John of Gaunt and his heirs for ever. During the Wars of the Roses, Henry IV. and Edward IV. both endeavoured so to settle the duchy that it should descend to the heirs of their body apart from the crown, and continue with them in the event of their losing the latter. The result of these several attempts has been the preservation of the duchy as a separate possession in order and government, but united in point of inheritance. The revenues of the duchy form no part of those hereditary revenues in lieu of which the Civil List (q. v.) was granted. The net proceeds are paid over to the Privy Purse, and wholly exempted from parliamentary control, except that the annual account for receipt and expenditure is presented. The county palatine forms only a portion of the duchy, which includes considerable estates not within the county palatine. There is a chancellor of the duchy (i. e., of the part of it which does not lie within the county), and of the county palatine, which two offices are generally united. The Duchy Court of Lancaster, held at Westminster, and presided over by the chancellor of the duchy, or his deputy, exercises jurisdiction in all matters of equity relating to the lands of the duchy. The administration of justice has recently been assimilated to that of the rest of England. The office of chancellor is a political appointment, which it is the practice to confer on a statesman of eminence, frequently a member of the cabinet, who is expected to devote his time to such larger questions occupying the attention of government as do not fall within other departments. The emoluments of the office are about £2000 per annum. By 17 and 18 Vict. c. 12, the chancellor of the duchy, with the two lords justices of the Court of Appeal, form the Palatinate Court of Appeal.

LANCASTER—LANCERS.

LANCASTER, SIR JAMES, the first English navigator who commanded a fleet bound for the East Indies, sailed from Plymouth, 10th April 1591. In 1600, the newly constituted *East India Company* intrusted him with their first expedition. L. having, in the course of his voyages, collected a number of valuable documents in support of the existence of a north-west passage, the government, acting on his advice, sent out an expedition to attempt to discover it. They discovered a strait in 74° N. lat., which was named by Baffin *Lancaster Sound*, in honour of Lancaster. L. was created a baronet for his services, and died in 1620. The history of his voyages has been preserved by Hakluyt and Purchas.

LANCASTER, JOSEPH. See **BELL, ANDREW**, and **MUTUAL INSTRUCTION**.

LANCASTER GUN, a species of rifled cannon, which has been partially adopted in the British service. When the great difficulty of rifling heavy ordnance to an extent to give a sufficient rotary motion to the projectile became apparent, Mr Lancaster devised a plan by which grooves might be dispensed with altogether. Instead of a strictly circular bore, he gave his gun an elliptical bore, the ellipse being of very small eccentricity. The major axis was not in one plane from end to end of the gun, but was made to revolve in the length, until it had moved round one-fourth the periphery of the ellipse. The projectiles are, of course, elliptical also; elongated, and somewhat pointed in front. When the shell is projected, it must follow the twist in the bore, and the rotary motion thus imparted is retained to the end of the range. The effect of this will be explained under **RIFLED ORDNANCE**. Several Lancaster guns were employed at the siege of Sebastopol, and some of them burst. But these were scarcely fair specimens, being service 8-inch guns (with circular bore) bored to Mr Lancaster's elliptical standard, and therefore weakened. The wrought-iron guns on his special model promise, however, more certain results, which, as experiments are still in progress, will be better given under **RIFLED ORDNANCE**.

LANCASTER HERALD, one of the six heralds of England, ranking second in point of seniority. His office is said to have been instituted by Edward III., in the 34th year of his reign, when he created his son, John of Gaunt, Duke of Lancaster. Henry IV. raised Lancaster to the dignity of a king-at-arms. Edward IV., after reducing him back to the status of a herald, abolished his office, which was revived by Henry VII.

LANCASTER SOUND, a western inlet of Baffin's Bay, in lat. 74° N., and extending from 80° to 87° W. long. Though this opening into the polar ocean was discovered by Baffin himself, as far back as 1616, yet it lay virtually neglected for more than 200 years. At length Parry, in 1819, penetrated through it into Barrow's Strait, and, beyond it, to the North Georgian Islands.

LANCE differed from *spear* or javelin in that it was not intended to be thrown, but to be thrust at the enemy by force of hand, and with the impetus acquired by speed, and thus was most effective in the hands of a mounted soldier. Hence the lance was the favourite arm with knights for commencing a combat; it was of tough ash, of considerable length, weighted at the end, and held not far from the hilt. See **TOURNAMENT**. In modern warfare, the lance is a long rod of tough ash, with an iron point, and usually a coloured flag near it. It is the offensive arm of **LANCERS** (q. v.).

LANCELET (*Amphioxus*, or *Branchiostoma*), a genus of Dermopterous (q. v.) fishes, of very remark-

able organisation, far lower than that of any other vertebrate animals, connecting cartilaginous fishes both with molluscs and with annelids. A few species are known, all small; one of them (*A. lanceolatus*), the first which was discovered, a native of the coasts of Britain and of Europe generally. It inhabits banks of sand, and when dug up, buries itself again in the sand with wonderful activity. It is at the utmost scarcely more than two inches in length, very much compressed, tapering to a point at each extremity, the head not notably distinct from the body. It is silvery white and semi-transparent; the skin destitute of scales. A low dorsal

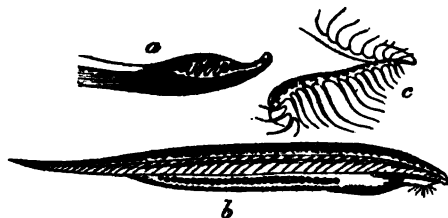

Lancelet (*A. lanceolatus*):

a, mouth, seen from below; b, general figure; c, hyoid bone, with filaments attached.

fin extends the whole length of the back. The skeleton is merely rudimentary, the spine being represented by a fibrous sheath, containing a great number of transverse membranous plates. There is no vestige of a skull, or any enlargement of the spinal cord into a brain; nor is the L. furnished with organs of sight or of hearing. The mouth is situated beneath that part of the body which may be regarded as the head; and is surrounded by a cartilaginous ring, in several, pieces, each of which gives off a prolongation to support *cirri*, or short filaments. The mouth communicates with a wide and long cavity, which contains the organs of respiration, and from the other extremity of which the alimentary canal proceeds. The L. does not eat or swallow, but simply imbibes its food, along with the water which supplies air for respiration. The intestine is slender and almost straight; but there is a very long cæcum. The walls of the respiratory cavity and the intestine are covered internally with vibratile cilia. The blood is colourless. Instead of a heart, there are several elongated blood-vessels, which contract successively; and at the commencement of each of the vessels connected with the organs of respiration there is a little contractile bulb. The muscular system accords with that of the higher fishes.—The very anomalous structure of the L. has led to the supposition, that this genus may represent a family or order once more numerous, but belonging rather to former geologic periods than to the present.

LANCELOT OF THE LAKE, one of the heroes of the legendary story of King Arthur and the Round Table. See **ARTHUR**.

LANCERS, a description of cavalry soldiers who are armed with lances. The type and perfection of lancers are the Russian Cossacks, whose long lances enable them to combat with enemies at a distance from which they themselves take little harm. The lancers were brought into European notice by Napoleon, who greatly relied upon some Polish regiments. After the peace of 1815, the arm was adopted in the English service, but it is thought by many that the British lancer has a weapon too short to enable him to charge an infantry square with any chance of success. The regiments armed as lancers are enumerated in the article **CAVALRY**.

LANCET-WINDOW—LANDED PROPERTY.

LANCET-WINDOW, a narrow window with acutely-pointed arch head. This form was much used in England and Scotland during the early pointed period of Gothic architecture. Several lancet-windows are frequently grouped together, so



Lancet-Window :
From Glasgow Cathedral.

as to produce a pleasing effect. In Scotland, the lancet-window was, like many other features of Scotch Gothic, retained to a much later period than in England. The fig. shews the east window of Glasgow Cathedral, which consists of four lancet-windows grouped together.

LANCEWOOD, a wood valuable for its great strength and elasticity. It is produced by the small tree *Guatteria virgata* (natural order *Anonaceae*). Another species, *G. laurifolia*, yields the wood called White Lancewood. The latter is not much used. L. is of great value to coach-builders, by whom it is used for shafts and carriage-poles, for which it is especially fitted. The part used is the main trunk of the tree, which is very straight, and rarely more than nine inches in diameter, with the bark on. It comes in small quantities from the West Indies, chiefly, however, from Jamaica.

LANCIA'NO (the *Anzia* or *Anza* of Pliny, subsequently *Ancianum*), the capital of a district in the Neapolitan province of Abruzzo-Citra, is situated 6 miles from the Adriatic, and 15 from Chieti. Pop. 14,500. Its present site occupies three hills, of which the two most adjacent are connected by an ancient bridge of great square blocks of stone, originally dedicated to Diocletian. The central position of this town favoured its being selected as a centre of judicial and civil administration during both the Roman and Gothic periods, and from its extensive traffic, it obtained the title of 'The Emporium of the Frentani.' L. possesses a fine cathedral, adorned with marbles and valuable paintings; contains several large foundries, and carries on manufactures of linen goods and farinaceous pastes.

LAND, TITLES TO. See **TITLE**.

LANDAU, a town of Rhenish Bavaria, and a fortress of the Germanic Confederation, is situated in a beautiful district on the Queich, which fills its fosse with water, twenty miles north-west of Carlsruhe. There are here important manufactures of tobacco. Pop., exclusive of the garrison, 7200. L. has been the scene of important events during every great war since the 15th century. In the Thirty Years' War, it was taken eight times by Swedes, Spaniards, Imperialists, and French. In 1684, it was fortified by Vauban, and was considered

impregnable until taken, in 1702, by the imperialists under the Markgraf Ludwig of Baden.

LAND-CRAB, the popular name of all those species of Crab (q. v.) which in a mature state are not aquatic. They are now erected into a family or tribe, and divided into several genera. The species are numerous, and all inhabitants of warm countries. They very much resemble the common crabs of our shores, and are remarkable as animals breathing by gills, and yet not aquatic, some of them inhabiting very dry places, where they burrow in the sand or earth; but such presence of moisture is absolutely necessary to them as to prevent the desiccation of their gills. Many, and probably all of them, deposit their spawn in water, for which purpose some of them annually migrate from considerable distances to the sea; but there is reason to suppose that some



Land-Crab (*Gelasimus masonis*).

deposit their spawn in fresh water. The **BLACK CRAB**, or **MOUNTAIN CRAB** (*Gecarcinus ruricola*), of the West Indies, usually resides in woods and on hills at a distance of at least one mile, often two or three miles, from the sea, which, however, it regularly visits in the months of April and May, when immense numbers may be seen journeying together, moving straight on, unless obstacles quite insuperable impede their progress. Like most of the other species, this L. is active chiefly during the night; and except in rainy weather, it seldom leaves its burrow by day. It feeds chiefly on vegetable food. When in season, it is highly esteemed for the table, as some of the other land-crabs also are; and its spawn or roe, which before being deposited forms a bunch as large as a hen's egg, is accounted a delicacy.—A L. of Ceylon (*Ocyropsis*) is so troublesome on account of the burrows which it makes in the dry soil of the equestrian promenade at Colombo, that men are kept in regular employment to fill them up.—The grass-lands of some parts of India swarm with small land-crabs, which feed on the grass or on green stalks of rice.

LANDED MEN, JURY OF. In Scotch Law, it is a privilege belonging to a landed proprietor, when tried for a criminal offence, to demand a jury the majority of whom are landed proprietors.

LANDED PROPERTY is not a legal, but rather a popular phrase, to denote that kind of property which consists of freehold estates in land, or, in Scotland, heritable estates. A person may have a mere chattel interest in land, such as a lease (though in Scotland even that is heritable estate), and the landed property does not in such case belong to him, but to his landlord, to whom and whose heirs the land descends for ever, until alienated. Landed property includes houses and all things called corporeal, and also some incorporeal rights connected with land.

The various ways in which this important kind of property is held, and the formalities attending its transfer, are treated of under such heads as ALLODIUM, FEE, FREEHOLD, COPYHOLD, FEOFFMENT, DEED, FEU, SASINE, CHARTER, CONVEYANCE, CONVEYANCING, SALE, TITLE, &c.

LANDER, RICHARD, the discoverer of the mouth of the Niger, was born in Cornwall in 1804, and became a printer; but in 1825 went with Captain Clapperton, as his servant, to Africa, and accompanied him from the Bay of Benin to S6koto. There Clapperton died; and L., returning to England, published a journal containing an account of the expedition, giving proof of such qualifications, that the British government intrusted to him the prosecution of further researches concerning the course of the Niger. In 1830, he and his brother John succeeded in proving that the Quorra, or Niger, falls by many mouths into the Bight of Benin. The brothers were, however, seized by the negroes, and sold to a slave-dealer, but being brought to Cape Formosa, were redeemed by the master of a Liverpool ship. They returned to England in June 1830, and published a *Journal of an Expedition to Explore the Course and Termination of the Niger* (3 vols. Lond. 1832). In 1832, they undertook a new expedition to the Niger in an iron steam-boat, and bought a small island as a British trading-station. In 1833, Richard L., with a few companions, made a trading excursion in the delta of the Niger; but they were assailed by the natives, and L. received a wound, of which he died, at Fernando Po, 27th January 1834.—JOHN L., who was about three years younger than his brother Richard, was rewarded with an appointment in the Customs; but died, 16th November 1839, from the effects of the African climate.

LANDES (Fr. heaths), extensive tracts on the coast of the Bay of Biscay, between the Gironde and the Pyrenees. Few districts in Europe are more desolate and unproductive. The part nearest the sea is more so than that which lies further inland on the rivers Adour and Midouze. The soil is in general sandy, sometimes marshy, mostly covered with nothing better than heath and dwarf shrubs, except where large plantations of fir and cork trees were made in 1789, by direction of the minister Necker. Only a few more fertile spots yield crops of rye, maize, and millet. The inhabitants, who are called *Parens*, live in scattered villages of wretched huts, in the eastern part of the L.: they are of Gascon race, very poor and rude, but active, good-natured, and hospitable. They very generally walk on stilts in the marshy and sandy grounds. They keep bees, swine, and sheep, and also live by fishing and hunting; and have begun to derive much advantage from the plantations, in which they find occupation in charcoal-burning, cork-cutting, and collecting turpentine, resin, and pitch. They also manufacture *sabots*, or wooden shoes. The sheep of the L. are of a very wretched breed, with coarse wool.

LANDES, a maritime department of France, and one of the largest and most thinly peopled in the country, is bounded on the W. by the Bay of Biscay. Area, 2,434,752 acres; pop. (1862) 300,839. The principal river is the Adour. The railway from Bordeaux to Bayonne passes through the whole length of the province from north to south. Of the entire area of the department, 51,100 acres are in vineyards, and about 10,000,000 gallons of wine are produced annually. The department is divided into the three arrondissements, Mont-de-Marsan, St Sever, and Dax. Capital, Mont-de-Marsan.

LANDGRAVE, or LANDGRAF. See GRAF.

LANDLORD AND TENANT. The contract by which the owner of land or houses, or the party entitled to the exclusive possession thereof, lets or hires this exclusive possession to another for a limited time, is generally called a lease, and thereby the relation of landlord and tenant is created. The party letting is called the landlord or lessor, and the party taking the lease is called the lessee or tenant. In order to let a house, the contract need not be in writing, unless the property is let for more than three years; but writing is always useful, especially if any variation is made from the usual terms. In Scotland a verbal lease is good only for one year. If nothing is said as to details beyond the amount of rent, and the length of time the lease is to last, there are certain rights understood to exist as between landlord and tenant, of which the most important are as follows in England. The tenant has a right to assign or sublet the property, if not otherwise agreed, but he still remains bound for the rent, unless the landlord accept the sub-tenant in his place. As a general rule, the tenant is primarily liable to bear all public impositions, whether they be parliamentary taxes or poor-rates, paving, lighting, watching, water-rates, highway-rates, county or borough rates, and church-rates. Hence, if the tenant wishes the landlord to pay these, or any of them, he must make some special agreement to that effect, for the only two rates which the landlord is bound to pay, or rather, to repay to the tenant, are the land-tax and property-tax, and the sewers-rate. As regards repairs, the burden of repairs is, at common law, thrown on the tenant; and therefore, if the landlord is to repair, he must bind himself by express contract. But the tenant is only bound for ordinary repairs, not for repairs to the fabric itself. He is bound to use the premises in a fair and reasonable manner, and to give them up at the end of the term in much the same condition, making allowance for tear and wear, and the effects of time. Strange to say, the landlord does not impliedly warrant the house to be reasonably fit for habitation, or that it will last during the existence of the lease; and it has been held that a house infested with bugs could not be thrown up by the tenant merely on that ground. Moreover, if the landlord agree to do repairs, and fail to do them, the tenant is not entitled to quit on that account, unless there is an express agreement to that effect. Where the premises consist of a farm, the tenant is bound to repair the fences; and when a tenant makes great improvements on a farm, he has no claim against the landlord for the value of such improvements, if no express agreement has been made. This state of the law, which exists also in Ireland, has given rise to constant disputes there. As regards game, the tenant has a right to shoot the game, if he has a game licence, unless he has otherwise specially agreed. The tenant of a farm has no right to the mines of coal or other mineral, unless they are already open, in which case he may take them for his own use. If nothing is specially agreed as to the time of payment of the rent, it is only due at the end of each year, but there is usually an express agreement to pay quarterly at the end of each quarter. Such quarter-days are Lady-day, March 25; Midsummer-day, June 24; Michaelmas-day, September 29; and Christmas-day, December 25. Rent is sometimes agreed to be paid in advance, but there must be an express agreement to that effect. In case of fire, if nothing has been expressly agreed, the tenant is bound to go on paying rent as if the house actually existed; and yet there is no means of compelling the landlord to rebuild the house, and it is not even expressly settled whether in that case the tenant can get quit of his lease by

offering to abandon it. A landlord is privileged above all other creditors as to the way in which he recovers his rent, for he need not, like other creditors, go to the expense and delay of bringing an action, but he can make a distress on the premises, i. e., seize at once as much furniture or goods as he finds there, to pay the rent in arrear; and he can recover six years' rent in this way. And it is immaterial whether the goods so seized belong to the tenant or not; it is enough for the landlord's purpose that they are found on the premises. Hence, though the house is sublet to another tenant whose goods are there, or even if the furniture is hired, and though the landlord knew this, yet he may seize it and pay himself; the only exception being made in favour of trade, as where the goods have been sent to a tailor or weaver to be made up. This privilege of distress, however, though most valuable to the landlord, is subject to this qualification: it cannot be resorted to till after the rent is due. Hence, if the tenant is bound only to pay his rent at the end of the year, he may on the last day remove all his goods and furniture, and so put them beyond the reach of the landlord's distress. It is true he does not get quit of the debt, for the landlord may then sue him, like other creditors, but he has no privilege. On the other hand, though the landlord cannot distrain till after the rent is due, still it may happen that, even after rent is due, the tenant may yet manage to clandestinely remove the goods, the rule being, at common law, that if once the goods be taken off the premises, the landlord's security is gone. In such cases, the landlord is entitled by an express statute to follow the goods so fraudulently removed to avoid a distress, provided he do so within thirty days; and he can then seize them, in whose hands soever they may be, and distrain them, as if they were still on his premises. Another qualification of the landlord's right of distress is of some importance: he cannot break open the outer-door of the house, or force his way in, though he may use stratagem to get in peaceably, and when once in, he can effect his purpose by seizing a table in name of the other goods, and leaving his broker or bailiff in possession. It is generally the bailiff or agent of the landlord who makes the distress, but it is the same thing. Hence, it often happens that a tenant who is vigilant, and not to be surprised, may for a long time effectually keep his landlord at bay, as far as the power of distress is concerned, for his house is his castle to this extent. Another advantage a landlord has as a creditor is, that if his tenant is indebted to third parties, who obtain judgment against such tenant, and put an execution in the house, i. e., seize, under the authority of the judgment, the tenant's goods, or if the tenant become bankrupt, the landlord is entitled to be first paid out of the proceeds of the furniture or goods, one year's rent if in arrear; if there is more rent due, then he must take the same remedy as other creditors. The mode of terminating a lease is by the time expiring, or by a notice to quit. In the ordinary tenancies of houses, which are called tenancies from year to year, the rule is, if nothing is agreed to the contrary, that either party can put an end to the tenancy by giving a half-year's notice at such a time that the lease will end at the same time of the year as the tenancy commenced. Thus, if the tenant entered on 1st May 1863, then he can give a half-year's notice to quit on 1st May 1864, 1865, or any subsequent year. Sometimes the parties agree that only a quarter's notice will suffice, and that at any of the usual quarter-days of the year. Sometimes the tenant, after giving or receiving notice, refuses to remove, and holds over; in which case, if the land-

lord chooses, he may accept him, and thereby the tenancy is renewed from year to year; or he may insist on the notice, in which case he requires to bring an action of ejectment to turn the tenant out; and in such cases, the landlord is entitled to demand double rent or double value, until he gets back the possession. A lodger is in much the same position as a tenant to the party from whom he hires the lodgings. See LODGINGS.

In Scotland, the law on the subject of landlord and tenant differs in a great variety of details from the law of England as above stated, but it will be necessary only to notice the leading points. There is no implied right in the tenant to assign and sublet an ordinary lease of an agricultural subject, such as a farm; but sub-letting and assigning are implied rights of the tenant of an urban property. If a tenant take a farm or house, he is impliedly bound to stock the one and furnish the other. If a house is let, the landlord impliedly warrants that it is in a fit state of repair; and if the landlord is bound to repair, the tenant may either do the repairs at the landlord's expense, or retain the rent till the repairs are done. Usually, the landlord puts the farm buildings, fences, roads, &c., in thorough repair at entry of the tenant, who is bound to leave the whole, at the end of the lease, in good condition, except as regards deterioration from ordinary tear and wear; by which arrangement all disputes, such as occur in Ireland, are avoided. The tenant has no claim for improvements, unless when his lease is abruptly terminated, and this is of rare occurrence. See LEASE. The tenant of a farm is, in the absence of special agreement, not entitled to the game. Rent is payable twice a year, if not otherwise agreed. In case of accidental fire, the tenant is no longer bound to pay rent if the destruction is complete, and otherwise is bound only *pro tanto*. A landlord has a hypothec, and can sequester (resembling the power of distress in England) the tenant's goods for rent which is current but not yet due. But the landlord cannot in general sequester a stranger's goods, unless in town-houses, and even then subject to qualification; and he cannot take a sub-tenant's goods, if the sub-tenant has paid the rent to the tenant. The landlord's hypothec or security over the goods follows the goods wherever they go, unless in the case of crops of a farm, when sold in bulk in public market; but this right must be exercised within three months after the term when the rent was due. The notice to quit, or warning, is sufficient if given forty days before the term of removal. But in Edinburgh the local custom is to give a three months' warning at Candlemas. Rent cannot be retained for an illiquid or unconstituted claim. If no notice is given forty days before the termination of a lease that advantage is to be taken of its close, the agreement is held to be renewed for another year by tacit relocation. See Paterson's *Compendium of English and Scotch Law*, pp. 127—149.

LANDLORD'S HYPOTHEC, in Scotch Law, means the lien or security for the landlord's rent which attaches upon the tenant's goods. See LANDLORD AND TENANT.

LONDON, LETITIA ELIZABETH, an English poetess—better known by her initials L. E. L.—was born in London in 1802. Her childhood was spent in the house of a relative in Hertfordshire. In 1820, her first poems appeared in the *Literary Gazette*, and attracted considerable attention. On the death of her father, she devoted her entire attention to literature, earning both fame and money. She published several volumes of verse, the most

widely read and admired of which was the *Improvisatrice*, and three novels, which have long since been deserted by the world of readers. On the 7th of June 1838, she married George Maclean, Esquire, Governor of Cape Coast Castle, and was found dead in her new house on the 18th October 1839. It is understood that for the alleviation of spasms, with which she was occasionally visited, she was in the habit of taking small doses of prussic acid, and her death is supposed to have been caused by an overdose. There is no reason to suppose that her death was other than accidental. In 1841, Mr Laman Blanchard published her *Life and Literary Remains*, in 2 vols.

L. E. L. might be called a sort of female Byron, if Byron had written nothing but the *Corssair* and *Lara*. Her poems are altogether high flown and romantic, but they have a certain musical impulse which is pleasing, and which gave them all the charm they ever possessed.

LANDOR, WALTER SAVAGE, son of Walter Landor and of Elizabeth Savage, was born at Ipaley Court, Warwickshire, in 1775. He was educated at Rugby, and at Trinity College, Oxford, quitting the university without taking a degree. He succeeded to the family estates on the death of his father. In 1808, he raised a body of men at his own expense, and joined the Spanish patriots under Blake. He was made a colonel in the service of Spain, but resigned his commission on the restoration of King Ferdinand. In 1811, he married Miss Julia Thuillier of Bath. After his marriage, he resided first at Tours, then at Florence, where he bought an estate. He first became known as the author of *Count Julian*, which was followed by a poem called *Gebir*. In 1820, appeared *Idyllia Heroica* (in Latin), and in 1824—1829, his *Imaginary Conversations of Literary Men and Statesmen* (5 vols.). L. is a thorough classical scholar, and his Greek and Roman characters speak as we should expect the ancient heroes to have spoken. He is greater as a prose writer than as a poet; but, according to Emerson, who visited him in 1833, nature meant him rather for action than for literature. 'He has,' says Emerson, 'an English appetite for action and heroes.' In 1836, he published *Letters of a Conservative*; in the same year, a *Satire on Satisfiers, and Admonition to Detractors*; in 1837, *The Pentameron and Pentologue*; in 1847, *The Hellenica*; in 1848, *Imaginary Conversations of King Carlo Alberto and the Duchess Belgiososo on the Affairs and Prospects of Italy*; in 1851, *Popery, British and Foreign*; in 1853, *Last Fruit off an Old Tree*; in 1854, *Letters of an American*. Some more recent productions of L.'s pen are not considered to have added to his reputation. He died at Florence, September 1864.

LANDOUR, a sanitary station in British India, on the south border of the protected state of Gurhwal (q. v.), at an elevation of 7579 feet above the sea. On ascending to this point from the plains, the thermometer has been known to fall from 90° to 52° F. in the course of two or three hours. Even in June, the temperature rarely rises to 80°; while, in January, it averages only about 53°. Much has been done to render the place available for invalids. Barracks have been erected, as also a post-office, a church, a hospital, a hotel, a library, and many private houses. L. is 1028 miles to the north-west of Calcutta. This sanitary station is all the more accessible from its proximity to both the great rivers of the neighbourhood, the Jumna and the Ganges.

LAND-RAIL. See CRAKE

LANDRAILS, in point of law, are protected by the game-laws from illegal trespassers, though not included in the definition of 'game.' See GAME, POACHERS.

LANDSBERG, a town of Prussia, in the province of Brandenburg, is situated in a pleasant and fruitful district on the Warthe, 40 miles north-east of Frankfurt. Its corn and wool markets are important; weaving, tanning, distilling, and machine-making are carried on. Pop. 13,495.

LANDSCAPE-GARDENING, the art of laying out grounds in order to beauty and pleasure, which may fairly claim to be reckoned among the fine arts. It is chiefly practised either in connection with the residences of the opulent, or in the public parks and pleasure-grounds of cities. The happiest results are indeed obtained, where the mere purpose of pleasing is not too much obtruded on attention, but where it is seen to harmonise with some other design.

Where the general aspect of a country is wild, and has been little modified by cultivation, enclosures, and other works of man, those scenes are felt to be most pleasing which exhibit his progress and triumph. Thus, when pleasure-grounds first began to be laid out, they exhibited only geometric forms; and alleys, avenues, and parterres did not seem artificial enough to give delight, without buildings of various kinds, terraces, mounds, artificial hills, lakes, and streams, close-clipped hedges, and trees or shrubs trimmed by *topiarian* art into fantastic shapes, such as figures of animals, vases, and the like. The art of the *topiarius* or *pleacher*—dating from the Augustan age in Rome—is now no longer in repute. In districts where the general scene exhibits a succession of rectangular fields, and where everything has evidently been reduced to a condition subservient to utility, a greater irregularity gives pleasure, and the eye loves to rest on any portion of the landscape which seems to exhibit the original beauties of nature. The landscape-gardener, however, must not attempt an exact imitation of nature, or to reduce everything to a state of primitive wildness. Like the painter, he must seek to exhibit nature idealised. The introduction of water is seldom successful; the mere landscape-gardener's lake or cascade is too obviously artificial. Where water is within view, it is a chief object of the landscape-gardener to arrange everything so that the view of it may be enjoyed from the windows of the mansion, or from the principal walks. Much care is given to the disposal of wood, in masses, groups, and single trees. Belts and clumps, which were much in vogue in the latter part of the 18th c., are now comparatively seldom planted.

The style of landscape-gardening in which regular forms prevail is called the *Geometric*; and the opposite style, from having been first extensively practised in England, in which country, indeed, it may be said to have originated, is known as the *English*. On the continent of Europe, a pleasure-ground laid out with winding and irregular walks, and scattered trees or groups of trees and shrubs, is called an *English garden*. But many of the continental English gardens are rather caricatures of the true English style than illustrations of it.

The taste of the present age rejects the grottoes, temples, statues, monuments, fountains, jets-d'eau, &c., with which it was once the fashion to fill pleasure-grounds, or admits only of their sparing introduction.

In the laying out of grounds, whether on a large or a small scale, it is of great importance that the trees and shrubs be well chosen, and the different kinds well grouped.

LANDS-CLAUSES ACT, a statute passed in

1845, containing a code of regulations generally inserted in all local acts where a power is given to take compulsorily a man's land for the purposes of public improvements. As no man can be compelled otherwise to sell his property, a statutory power to compel him is necessary in all cases where a public undertaking, such as a railway, harbour, &c., requires it. A statute, 8 Vict. c. 18, accordingly, with the above title, was passed for England, and 8 Vict. c. 19 for Scotland, each containing detailed provisions as to the mode of settling the price to be given in such cases, &c.

LANDSEER, SIR EDWIN, R.A., an English painter, son of John Landseer, an eminent engraver, was born in London in 1802, and was carefully trained by his father, who used to take him out, when only a child, to Hampstead Heath, and accustom him to sketch animals from life. The first work of L.'s that brought him prominently before the public was 'Dogs Fighting,' exhibited in 1819. It was succeeded by the 'Dogs of St Gothard' (1819), the popularity of which was very great. The scene of several of his finest pictures is laid in the Highlands of Scotland. For upwards of thirty years, every London exhibition has witnessed his success. In 1827 he was elected a R.A., and in 1850 he was knighted. Among his most celebrated achievements are: 'The Return from Deer-stalking,' 'The Illicit Whisky-still,' 'Highland Music,' 'Poachers Deer-stalking,' 'Bolton Abbey in the Olden Time,' 'A Scene in the Grampians—the Drover's Departure,' 'Return from Hawking,' 'The Old Shepherd's Chief Mourner,' 'Peace,' 'War,' 'Stag at Bay,' 'The Drive—Shooting Deer on the Pass,' 'The Random Shot,' 'Night,' 'Morning,' 'The Children of the Mist,' 'Saved,' 'Highland Nurses—Dedicated to Miss Nightingale,' 'Deer-stalking,' and 'Flood in the Highlands' (1861). L. is reckoned the most superb animal-painter of his time; his conceptions are often highly poetical; the sentiment which he throws into his representations of the 'dumb creatures' is quite wonderful, and the felicity of his execution is unsurpassed. Most, if not all his pictures have been engraved.—L. has two brothers, CHARLES and THOMAS, also artists. Thomas is one of the best living engravers in England.

LAND'S END. See CORNWALL.

LANDSHUT, an ancient and picturesque German town, capital of Lower Bavaria, is situated in a pleasant, fertile district on the Isar, 39 miles north-east of Munich. Its streets are rich in quaint old gables, and there are numerous towers; that of St Martin's Church (a Gothic building, dating from 1450) is 420 English feet in height. L. contains 36 breweries, and has manufactures of woollen cloth, leather, hosiery, and tobacco. In 1826, the university, which was removed hither from Ingolstadt in 1800, was transferred to Munich. The castle of Trausnitz, long the residence of the Dukes of Bavaria, is supposed to have been originally a Roman station. During the Thirty Years' War, and the war of the Austrian Succession, L. was an important fortress, and the scene of many conflicts. Pop. 11,316.

LANDSLIPS, large portions of land which from some cause have become detached from their original position, and slid down to a lower level. They are especially common in volcanic districts, where the trembling of the earth that frequently accompanies the eruption of a volcano is sufficient to split off large portions of mountains, which slide down to the plains below. Water is another great agent in producing landslips. It operates in various ways. The most common method is when water insinuates itself into minute cracks, which are widened and deepened by its freezing in winter. When the

fissure becomes sufficiently deep, on the melting of the ice, a landslip is produced. Sometimes, when the strata are very much inclined, and rest on a bed susceptible of absorbing water, and becoming slippery, the superincumbent mass slides over it to a lower level. This took place on a large scale in Dorsetshire between Lyme and Axminster in 1839, an unusually wet season, in which the strata had become saturated with moisture. A mass of chalk and greensand here slid over the slippery surface of a bed of liassic clay down into the sea, leaving a rent three-quarters of a mile long, 240 feet wide, and 150 feet deep. Of the same kind was the slip of the Rossberg, in Switzerland (see GOLDAU). Landslips of a different kind have been produced in peat-mosses, which becoming by heavy rains thoroughly saturated with water, have burst their natural boundaries, and discharged themselves on a lower level. The most remarkable case on record is that of the Solway Moss, which, in 1772, owing to greater rains than had fallen for nearly two centuries, spread itself in a slowly rolling, resistless deluge of black mud over 400 acres of cultivated fields, and to such a depth as almost to cover several houses, while it reached the roof of others.

LANDSMAN, a term applied on board ship to a sailor who has never been at sea before. The word is gradually becoming obsolete, and is supplied in the royal navy by the expression 'ordinary seaman of the 2d class.'

LAND-SURVEYING, or the measurement of the area of a portion, whether small or large, of the earth's surface, is an important application of mathematics, and involves a thorough acquaintance with geometry, trigonometry, and the theory and use of the instruments employed for the determination of angles. Fields or portions of ground of small extent are measured easily and with sufficient accuracy by a chain (for distances), and a box-compass or cross-staff (for angles). For larger areas, the use of the surveyor's table is requisite; and for those of still greater extent, in which the greatest accuracy is requisite in the determination of the angles, the astrolabe, the theodolite, sextant, circle, reflector, micrometer, &c., are used. The surface to be measured is divided into triangles, which are separately measured and calculated; but when a large extent is included in the measurement, it is not enough to proceed from one triangle to another, in which way an error at the outset may be propagated with continual increase; but a base line, as long as circumstances admit of, must, in the first instance, be accurately measured, upon which, by means of the measurement of angles, all the subsequent calculations are made to depend, and lines subsequently measured are only intended to be corrective of the results obtained by calculation. When the extent of surface is still greater, as when a whole country is to be measured, points here and there are astronomically determined, their meridians are accurately laid down, and a complicated system of triangles is employed to insure accuracy. This is called *Triangulation*.

LAND-TAX, a tax imposed upon land and houses for purposes of revenue, in lieu of the ancient subsidies, scutages, talliages, tenths, fifteenths, and such occasional taxes. From a very early period to the middle of the 17th c., parliament had provided for the extraordinary necessities of the government chiefly by granting subsidies, which were raised by an impost on the people in respect of their reputed estates. Landed property was the chief subject of taxation, and was assessed nominally at 4s. in the pound. But this assessment was made in such a way that it did not rise with the value

of land, but dwindled away to about 2d. in the pound. The Long Parliament devised a more efficient plan by fixing the sum to be raised, and then distributing it among counties according to their supposed wealth, leaving them to raise it by a rate. In 1692, a new valuation of lands was made, and it was found that a tax of 1s. per pound would yield half a million. In war, this was raised to 4s. In 1798, the parliament relieved itself of the trouble of every year passing an act, and a general act was passed, permanently fixing the land-tax at 4s. in the pound. This act (38 Geo. III. c. 60) enabled the landlord to redeem the tax, and accordingly, since that time, a great part of it has been redeemed, only about one million being unredeemed. Though the act of 1798 directed the tax to be assessed and collected with impartiality, this provision was not carried out, but the old valuation of 1698 was acted on, and in modern times the greatest possible inequality prevails. If the tax is in arrear, the tenant is liable to a distress; but the tenant may deduct it from the next rent he pays. The tax, though nominally chargeable on the landlord, falls neither on the landlord nor the tenant, but on the beneficial proprietor, as distinguished from the tenant at rack-rent; for if the tenant has sublet, and has a beneficial interest, he pays *pro tanto* the tax, charging the residue on the landlord. The proportion of land-tax fixed on Scotland was £47,964, and a proportion was fixed on each county, the commissioners having power to amend the valuation. The collection and management of the tax was given to the commissioners of taxes by the statute 3 and 4 Will. IV. c. 13.

LAND-TRANSPORT CORPS. See **MILITARY TRAIN.**

LANDWEHR (Land-defence), a military force in several of the German states, somewhat corresponding to the Militia (q. v.) of Great Britain. It is not always retained under arms. During peace, its members spend most of their time in civil pursuits, and are called out for military service only in times of war or of commotion—care being taken however, that they are sufficiently exercised to make them ready for such service when necessary. The name Landwehr was first applied to the Tyrolese, who rose against the French; and in 1805 a similar force was raised in the other German provinces of Austria, which, however, the emperor has recently abolished. By far the most elaborate and complete system of land-defence is the Prussian, which was called into existence in 1813, when all Germany rose against Napoleon. As early, indeed, as 1806, or earlier, Marshal Knesebeck, then a major in the Prussian army, had proposed such a thing; but it was not till the opening of the campaign of 1813 that the Prussian Landwehr was organised according to Scharnhorst's plan by a royal edict, dated 17th March. At first, it was designed solely as a land defence, properly so called, and not, what is now the case, as an integral part of the regular army. It was called out in two separate levies, the first comprising all men from 26 to 32, and the second those from 32 to 39. The old men up to 60 belonged to the *Landsturm*, which was called out only for the defence of house and hearth.

After the second Peace of Paris appeared the *Landwehrordnung* (Landwehr-regulation) of 21st April 1815, according to which the country was divided into 104 districts, each of which had to furnish a battalion of Landwehr. To every battalion of Landwehr was attached a squadron of ulans; three battalions formed a regiment; two regiments, a Landwehr brigade, which, along with the brigades of cavalry and infantry, was placed

under a general of division. More recently, the Landwehr was brought into closer union with the line, in order to remedy the faults which had shewn themselves, in spite of all the admirableness of the system. Landwehr brigades have been introduced into the regular army.

LANFRANC, the most eminent of the foreign churchmen who rose to distinction in the mediæval Church of England, was born of a noble family at Pavia, in 1005, and educated, partly at Pavia, partly at Bologna, for the profession of the law. For a time he followed the profession of an advocate at Pavia; but in the hope of greater distinction, he removed to France, and founded at Avranches a school of law, which soon became one of the most popular in France. Having been way-laid and all but murdered by robbers during one of his journeys to Rouen, he was carried to the monastery of Bec, where he was treated with much tenderness; and the deep religious impressions there received determined him to abandon the world and become himself a monk. He was soon (1041) chosen prior of the monastery; and his reputation for piety, as well as the fame for theological learning which he acquired, especially in his controversy on the Eucharist with Berengar, led to his translation in 1062 to the still more important monastery of St Stephen, at Caen, recently founded by William, Duke of Normandy. Having enjoyed the confidence of that prince for many years, he was selected by him, after the conquest of England, to fill the primatial see of Canterbury, and he was induced with much reluctance to accept it in 1070. Having once, however, undertaken the charge, he entered zealously into the policy of his sovereign; and under his spiritual rule the Church of England received as strong an infusion of the Norman element as was forced upon the political system of England by the iron hand of the Conqueror. L. outlived William; and to his influence the historians mainly ascribe the peaceful submission with which that monarch's successor, Rufus, was accepted by the kingdom, as well as the comparative moderation of the earlier years of Rufus's reign. The tyranny which has made the name of Rufus odious dates mainly after the death of L., which occurred in 1089, in the 84th year of his age. His chief writings are—Commentaries on the Epistles of St Paul, the Treatise against Berengar, and Sermons. His letters, however, are very interesting. The first complete edition of his works is that of D'Achery (fol. Paris, 1648). They are also found in the *Bibliotheca Patrum*. See Milman's *Latin Christianity*, vol. iii. pp. 438—440, and also Dr Hook's *Lives of the Archbishops of Canterbury*, vol. ii. 1861.

LANGÉLAND (i. e., *long land*), a Danish island, situated at the southern entrance to the Great Belt, between Fuhnen and Laaland. It is 33 miles in length, and about 3 miles in average breadth. Area, about 100 square miles; pop. 17,400. It consists of a ridge of low hills, is very fertile in soil, and is well wooded. Grain, pease, butter, and cheese are largely produced. Rudkjøbing, pop. 2000, on the west coast, is the only town.

LANGENBIE'LAU, a succession of small contiguous villages in Prussia, in the province of Silesia, 33 miles south-west of Breslau. Entire pop. 12,667, who are employed in linen, cotton, and other manufactures, and in sugar-refining and dyeing.

LANGENSA'LZA, a town of the Prussian province of Saxony, with a pop. of 9000, and considerable manufactures of various kinds. In the war of 1866, L. was the scene of an encounter between the Prussians and Hanoverians, when, after considerable bloodshed, the latter surrendered.

LANGHOLM, a burgh of barony and market-town in Dumfriesshire, Scotland, at the junction of the Ewes, the Wauchope, and the Esk, about 30 miles east of the county town, and 8 miles north of the English border. There are 8 factories in the town, whose staple manufactures are woollen yarns, and a woollen cloth called Tweed, for which the town is noted. Dye-works are also in operation. L. consists of the united villages of Old and New Langholm. Pop. (1861) 2979.

LANGRES, a manufacturing town of France, in the department of Haute-Marne, is situated at an elevation of 1408 feet above sea-level, 20 miles south-east of Chaumont. Here cutlery of the finest quality is manufactured, and there is a considerable trade in grain, lint, cattle, and sheep. It is said to have been the see of a bishop since the 3d c., and possesses a cathedral of the 11th century. Pop. 10,850. L., the ancient Andomatunum, was in the time of Cæsar the capital of the Lingones, a name corrupted into Langres.

LANGSAT, or **LANSEH**. See **MELIACEÆ**.

LANGTON, STEPHEN, celebrated in the history of the liberties of England, was born probably in Lincoln or Devonshire, in the early part of the 12th century. He received the chief part of his education in the university of Paris, where he was the fellow-student and friend of Innocent III.; and having completed his studies, he rose through successive grades to the office of chancellor of the university. After the elevation of Innocent, L., having visited Rome, was named to the cardinalate by the pope; and, on occasion of the disputed election to the see of Canterbury, he was recommended to those electors who had come to Rome on the appeal, and having been elected by them, was consecrated by Innocent himself at Viterbo, June 27, 1207. His appointment, nevertheless, was resisted by King John; and for six years, L. was excluded from the see, to which he was only admitted on the adjustment, in 1213, of the king's dispute with Innocent through the legate Pandulf. See **INNOCENT III.** This reconciliation, however, was but temporary. In the conflict of John with his barons, L. was a warm partisan of the latter, and his name is the first of the subscribing witnesses of **Magna Charta**. When the pope, acting on the representation of John, and espousing his cause as that of a vassal of the holy see, excommunicated the barons, L. refused to publish the excommunication, and was in consequence suspended from his functions in 1215. He was restored, however, probably in the following year; and on the accession of Henry III., he was reinstated (1218) in his see of Canterbury, from which time he chiefly occupied himself with church reforms till his death, which took place July 9, 1228. L. was a learned and successful writer, but his writings are lost, and the chief trace which he has left in sacred literature is the division of the Bible into chapters, which is ascribed to him. Giraldus Cambrensis (q. v.) dedicated several of his books to Langton.—See Wharton's *Anglia Sacra*, vols. i. and ii.; Lingard, vol. ii.; Milman's *Latin Christianity*, vol. iv.; and Dr Hook's *Lives of the Archbishops of Canterbury*, vol. ii. 1861.

LANGUAGE. See **PHILOLOGY**.

LANGUED, or **LAMPASSÉ**, in Heraldry. An animal whose tongue is of a different colour from his body, is said to be *langued* of that colour. It is understood in England that unless the blazon direct otherwise, all animals are langued gules whose tincture is not gules, and an animal gules is langued azure. This rule does not hold good in Scottish Heraldry, where, 'when the tongue, teeth, and claws are of different tinctures from their

bodies, they are to be mentioned as armed and langued of such a tincture.'—*Nisbet*. When a beast or bird is represented without teeth or claws, this is expressed in blazon 'sans langue and arms.'

LANGUEDOC, the name given in the middle ages, and down to the French Revolution, to a province in the south of France, bounded on the N. by Auvergne and Lyonnais; on the E. by the river Rhone; on the S. by the Mediterranean and the counties of Foix and Roussillon; and on the W. by Gascony and Guienne. It was traversed through its whole length, from north-east to south-west, by the Cevennes (q. v.). L. is now divided into the departments of Lozère, Gard, Ardèche, Aude, Hérault, Upper Loire, Tarn, and Upper Garonne. The capital of L. was Toulouse. The name is derived from that of the southern French dialect, or Provençal, which was called the *langue d'oc*, whilst the northern was called *langue d'oui* or *langue d'oïl*, because in the former the word *oc* (probably from the Teutonic *ouch*) was used for *yes*, and in the latter *oil* or *oui* (Teut. *wohl*).

LANI'ADÆ, a family of birds, generally ranked, as by Cuvier, in the order *Insectores*, sub-order *Dentirostres*, but allying them to *Accipitres*. They are the largest and most rapacious of the *Dentirostres*, preying on small birds, quadrupeds, and reptiles, as well as on large insects. Many of them have the curious habit of impaling their prey on thorns, after which they pull it in pieces, and devour it at leisure. They have a short, strong, abruptly hooked bill, with a notch or tooth on each side, and sharp claws. The Shrikes (q. v.), or Butcher-birds, are the type of the family; but it is united by numerous links to the family of the *Muscicapida*, or Fly-catchers, and the limits of the two families are very uncertain.

LANKĀ, the ancient name of the capital of Ceylon. In Hindu mythology, it is renowned as the chief city of the giant Ravana (q. v.), who, by carrying off Sītā, the wife of Rāma, caused the conquest of Ceylon by the latter personage, who is considered as an incarnation of the god Viāh'n'u.

LANKĀVATĀRA, the name of one of the chief religious works of the Buddhists. It treats of their religious law, and of some of their most abstruse philosophical problems. See E. Burnouf, &c., and W. Wassiljew, &c., as named under **LALITA-VISTARA**.

LANNER (*Falco lannarius*), a species of falcon,



Lanner (*Falco lannarius*).

much valued in the days of falconry for flying as the kite. The female only was called a L., in the

language of falconry; the male, being smaller, a *lannere*.

LANNES, JEAN, DUKE OF MONTEBELLO, a marshal of the French Empire, was born 11th April 1769, at Lectoure; entered the army in 1792, and soon rose to high military rank. He rendered Napoleon important service on the 18th Brumaire, and enjoyed his highest favour. On 9th June 1800 he won the battle of Montebello, whence his title. He bore a principal share in the battle of Marengo, and commanded the left wing at Austerlitz. He served in the campaign against Prussia in 1806, commanded the centre at Jena, and distinguished himself at Eylau and Friedland. Being sent to Spain, he defeated General Castaños at Tudela, 22d November 1808, and took Saragossa. In 1809, he again served on the Danube, and commanded the centre at Aspern (the 22d May), where he had both his legs carried away by a cannon-shot. He was removed to Vienna, and died there, 31st May. He was interred in the Pantheon, in Paris.

LANNION, a town and river-port of France, in the department of Côtes-du-Nord, on the Guer, about seven miles from the mouth of that river. Its trade is chiefly in deals, Bordeaux wine, and colonial produce. Pop. about 6000.

LANSDOWNE, HENRY PETTY-FITZMAURICE, third MARQUIS OF, an English statesman, was born at Lansdowne House, London, July 2, 1780. His father, the celebrated Earl of Shelburne, was premier to George III., and received the coronet of a marquis in 1784. L. (then Lord Henry Petty) was a younger son, and was sent to Westminster School, and afterwards to Edinburgh, then the school of the young Whigs destined for political life. He took his degree at Trinity College, Cambridge, in 1801, and when barely of age, entered parliament as M.P. for Calne. He turned his attention to finance; and on Pitt's death, he became, at the age of 25, Chancellor of the Exchequer, in the administration of Lord Grenville. In 1809, he succeeded his half-brother in the marquise, became one of the heads of the liberal party in the House of Lords, and during a long opposition, consistently advocated those various measures of progress which he lived to see triumphant. When the Whigs, after their long exclusion from power, came into office with Earl Grey at their head, L. became Lord President of the Council, which post he held, with a brief interval, from November 1830 to September 1841, resuming it in 1846, after the fall of the Peel ministry, and again filling it until 1852. He then formally bade farewell to office, and resigned the leadership of the House of Lords; but consented to hold a seat without office in the Aberdeen cabinet, and again in the first administration of Lord Palmerston. After the death of the Duke of Wellington, he became the patriarch of the Upper House, and the personal friend and adviser of the Queen. He had a keen relish and a cultivated taste for literature, and was the generous patron of men of letters. He formed a splendid library, and one of the noblest collections of pictures and statuary in the kingdom. He refused a dukedom, and might more than once have been prime minister. His death took place January 31, 1863, at Bowood.

LANSING, the capital of Michigan, U.S., on Grand River, 110 miles north-west of Detroit, contains a state-house, female college, state agricultural college, and model farm of 700 acres, house of correction for juvenile offenders, ten churches, a bank, two weekly papers, and several manufactories. Settled in 1847, it has a population of 5000.

LANTERN, in Architecture, an ornamental structure raised over domes, roofs, &c., to give light and ventilation. The dome of St Paul's Cathedral and many other large domes are crowned with a lantern. Where a lantern is for the purpose of giving light, it is called a *lantern-light*. In Gothic architecture, a *lantern-tower* is frequently placed over the centre of cross churches—the vault being at a considerable height, and the light admitted by windows in the sides. York and Ely cathedrals, and many churches in England, have such lantern-towers.

LANTERN-FLY (*Fulgora*), a genus of homopterous insects; the type of a family *Fulgoridae*, allied to *Cicadidae*, but having legs more adapted for leaping, and destitute of organs for producing sound. The forehead is remarkably prolonged into an empty vesicular expansion, which assumes in the different species various and very singular forms, sometimes equalling the body of the insect in size. The colours are generally rich. The species are



Lantern-Fly (*Fulgora laternaria*).

natives of the warmest parts of the world. The name L. was originally given to *F. laternaria*, a large species, found in Guiana, and of which the inflated projection of the forehead is said to be sometimes most brilliantly luminous; but the evidence is doubtful, and many naturalists refuse to believe in the luminosity of any of this genus. The most probable explanation is, that the luminosity is sexual, and merely occasional, perhaps limited to particular seasons. Concerning the luminosity of the CHINESE L. (*F. candelaria*), there is still greater doubt. The prolongation of the forehead in this species is a comparatively narrow snout.

LANTHANUM, or **LANTHANUM**, so named from the Greek word *Lanthanein*, to lie hid, is a metal which was discovered by Mosander in 1841 in *Cerite* (q. v.), a hydrated silicate of cerium. It is of little chemical interest, and is of no practical value. Till recently, the three metals cerium, lanthanum, and didymium were all confounded together under the name cerium.

LANYARDS, in a ship, are short ropes used either to make fast various apparatus in its place, or to stretch other and important ropes to their utmost tension.

LANZAROTÉ, one of the Canaries (q. v.).

LANZI, LUIGI, a celebrated Italian antiquary, was born at Monte dell' Olmo, near Macerata, June 14, 1732. He entered the order of the Jesuits, and resided at Rome, and afterwards at Florence, where he died March 30, 1810. In 1782, he published at Florence his *Descrizione della Galleria di Firenze*. His great works, distinguished for their profound erudition, are his *Saggio di Lingua Etrusca* (3 vols. Rome, 1789), in which, contrary to the prevalent opinion among Italian savants, he maintains the influence of Greece upon Etruscan civilisation, and his *Storia Pittorica d'Italia, &c.* (Florence, 1792; and Bassano, 1789, and 1806). This latter work

has been translated into English by Thomas Roscoe (Bohn's Standard Library, 3 vols. 1847). He is the author also of several poems, works on Etruscan vases, sculptures, &c. His posthumous works were published in 2 vols. at Florence in 1817.

LA'OCOÖN, according to classic legend, a priest either of Apollo or Neptune, in Troy, who in vain warned his countrymen of the deceit practised by the Greeks in their pretended offering of the wooden horse to Minerva, and was destroyed along with his two sons by two enormous serpents which came from the sea. They first fastened on his children, and when he attempted to rescue them, involved himself in their coils. This legend is not Homeric, but of later origin. It was, however, a favourite theme of the Greek poets, and is introduced in the *Æneid* of Virgil. It acquires a peculiar interest



Laocoön.

from being the subject of one of the most famous works of ancient sculpture still in existence; a group discovered in 1506 at Rome, in the Sette Sale, on the side of the Esquiline Hill, and purchased by Pope Julius II. for the Vatican. It was carried to Paris, but recovered in 1814. The whole treatment of the subject, the anatomical accuracy of the figures, and the representation both of bodily pain and of passion, have always commanded the highest admiration. According to Pliny, it was the work of the Rhodian artists Agesander, Polydorus, and Athenodorus, but this is doubtful. Casts of it are to be found in every European museum. For an æsthetic exposition of its merits, see Lessing's celebrated *Laocoön oder über die Grenzen der Malerei und Poesie*.

LAODICEA, a city of ancient Phrygia, near the river Lycos, so called after Laodice, queen of Antiochus Theos, its founder, was built on the site of an older town named Diospolis. It was destroyed by an earthquake during the reign of Tiberius, but rebuilt by the inhabitants, who were very wealthy, fell into the hands of the Turks in 1255, was again destroyed in 1402, and is now a heap of uninteresting ruins, known by the name of Eski-Hissar. Art and science flourished among the ancient Laodiceans, and it was the seat of a famous medical school. The number of Jews who were settled here at the rise of Christianity will account for its importance in the primitive history of the church. An important ecclesiastical council, the First Council of Laodicea, was held here in 363, which adopted resolutions concerning the canon of the Old and New Testaments, and concerning

ecclesiastical discipline. A second council was held here in 476, which condemned the Eutyohians.

LAON, chief town of the department of Aisne, in France, is situated in a strong position on a steep isolated hill, 80 miles north-east of Paris. The walls (flanked with towers) with which it is surrounded, the noble Gothic cathedral (built 1112—1114) on the summit of the hill, and the charming character of the scenery in the vicinity, greatly enhance the appearance of the town. The public library, with 20,000 vols., contains also a beautiful statue in marble of Gabrielle d'Estées. The manufactures are nails, hats, leather, and hosiery. Here, on March 9 and 10, 1814, Napoleon was defeated by the allies, and compelled to fall back on Soissons. Pop. 10,412.

LA'OS. See SHAN STATES.

LAOU-TSZE, a celebrated philosopher of China, the founder of a religion as ancient and important as that of Confucius (q. v.). This sect is commonly known as the *Taou*, or sect of reason. His family name was *Le*, or Plum, and his youthful name *Urh*, or Ear—given him on account of the size of his ears. His name of honour was *Pe-yang*, his surname *Laou-tze* ('old child'), or *Laou-keun-tze* ('old prince'), by which he is generally known. Little authentic is known of the life of L., his followers having subsequently made a myth of his biography. He was born in the third year of the Emperor Ting-wang, of the Chow dynasty (604 B. C.), in the state of Tseu, at present known as Hoo-pih and Hoo-nan, 54 years before Confucius. His father, according to the legends of the *Taou* sect, was 70 years before he married, and his mother 40 years of age when she conceived him. He was the incarnation of a shooting-star, a kind of god on earth, and was 80 years in his mother's womb. More trustworthy is the statement that he was a historian and archivist of a king of the Chow dynasty, who loved books, studied rites and history, and went, about 600 A. D., to the western parts of China, where he might have become acquainted with the worship of Fuh or Buddha. Confucius was so attracted by his renown, that he went to see him, but the meeting does not appear to have been entirely amicable, for L. reproached the sage with pride, vanity, and ostentation, stating that sages loved obscurity and retreat, studied time and circumstances before they spoke, and made no parade of knowledge and virtue. Confucius, however, highly lauded L. to his followers, and called him a dragon soaring to the clouds of heaven, which nothing could surpass. L. asked Confucius if he had discovered the *Taou* ('path' or 'reason') by which Heaven acts, when Confucius answered that he had searched for it without success. L. replied that the rich sent away their friends with presents, sages theirs with good advice, and that he humbly thought himself a sage. By this he probably meant that all he could offer Confucius was the advice of seeking the *Taou*. He retired to Han-kwan, where the magistrates of the place received him, and there he wrote the *Taou-ih-king*, or Book of Reason and Virtue. He died, or, according to other accounts, mounted to heaven on a black buffalo, in the 21st year of the reign of King-wang of the Chow dynasty, 523 B. C., having attained the age of 119 years.

The doctrines of L. differ from those of Confucius, indeed, have a higher scope—the object of the last-named philosopher, or rather statesman, being the practical government of man through a code of morals; that of L., the rendering of man immortal through the contemplation of God, the repression of the passions, and the perfect tranquillity of the soul. Hence his doctrine was, that Silence and the

Void produced the Taou, the 'Logos' or reason by which movement was produced; and from these two sprung all beings which contained in themselves the dual principle of male and female. Man was composed of two principles, the one material, and the other spiritual, from which he emanated, and to which he ought to return, by throwing off the shackles of the body, annihilating the material passions, the inclinations of the soul, and pleasures of the body. By this means, the soul was to regain its origin—become immortal. This could only be effected by the renunciation of riches, honours, and the ties of life. Up to the period of L, the national worship had been restricted to the *Shang-te*, or 'supreme ruler' of the world, and the *Teen*, or 'heaven.' For these, L substituted the *Taou* ('path' or 'reason') of the cosmos, not citing, as the Confucianists, the precedents of ancient kings or sages—appealing to the abstract principle, and, in fact, preaching a religion which found an echo in the Chinese breast. The followers of his sect, however, considerably altered his doctrines. The moral code of the Taou sect is excellent, inculcating all the great principles found in other religions—charity, benevolence, virtue, and the free-will, moral agency, and responsibility of man. But it subsequently became corrupted with strange doctrines and practices. They promulgated that they had discovered the drink of immortality, and obtained a host of partisans in the reign of Wan-te of the Han dynasty, 140 A.D., and many of the emperors were addicted to their rites, and some poisoned by the drink of immortality. Alchemy also became another pursuit of the sect; so did divination, the invocation of spirits, and the prediction of the future. The doctors of the sect, called *Teen-sze* ('celestial doctors'), were supposed by these means to become ethereal, and to be caught up to heaven without passing through the intermediate state of death. Such statements, however, were ridiculed by the *Joo-keou*, or sect of Confucius, the sceptics of China, who openly derided their pretensions. Innumerable gods were also introduced into the worship, which was assimilated to the Buddhist. Since the 2d c. A.D., the sect has continued to spread in China, Japan, Cochinchina, Tonquin, and amongst the Indo-Chinese nations. Monasteries and nunneries belonging to them were founded and flourished. The principal books or classics of the sect are the *Taou-tih-king* already cited; the collections called *Taou-chang*; the *Kan-ying-peen*, or Book of Rewards and Punishments; and the *Tan-kwei-tshih*, or List of the Scarlet Laurus Cassia.

Stanialas Julien, *Le Livre des Recompenses* (8vo, Paris, 1838); Panthier, *La Chine* (8vo, Paris, 1837, p. 114—117); Neumann, *Lehrsatz des Mittelreichs* (8vo, Munich, 1856); Grossier, *Description de la Chine* (4to, p. 571); *Mémoires sur la Chine* (x. 425; xv. 208—259).

LAPIDARY-WORK, the art of cutting, grinding, and polishing small pieces of ornamental or precious stones for jewellery. (For the engraving of figures on precious stones, see **CAMEO** and **GRMS.**) The working of the less precious ornamental stones has made great strides within the last twenty or thirty years, and nowhere has it reached greater perfection than in Scotland. A large trade is now carried on in this kind of work between Birmingham and some towns of Germany, where the Scotch patterns are imitated; and although the foreign productions are of inferior workmanship, their comparative cheapness commands a ready market.

Stones are cut by rubbing the powder of a harder stone against a softer one. There are ten types of Hardness (q. v.), from talc up to diamond; but in practice it is found most convenient to employ either

diamond-powder or emery, which is next to it, for the cutting of all kinds of stones. Diamond-dust is found to cut ten times faster than emery; so that, except where the machine is driven by water-power, it is found more profitable to employ diamond-powder, notwithstanding its high price. Diamond-powder is prepared from the inferior kind of Diamonds (q. v.) called *bort* (costing about a guinea per carat), by grinding in a steel mortar.

To produce a plain polished surface on any stone, say a jasper, it goes through the three processes of cutting or slitting, grinding, and polishing. The diamond-slitting machine (the emery-machine is essentially the same) is shewn in fig. 1. The

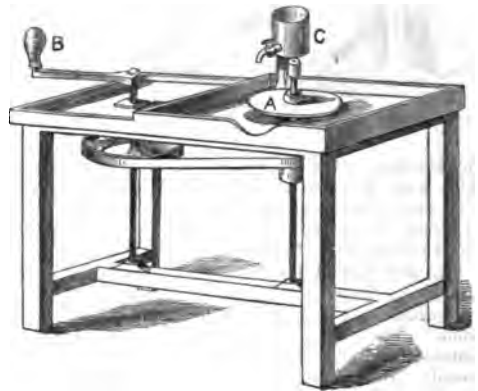

Fig. 1.

slitting-wheel, A, which is driven by means of the handle, B, is a mere disc of thin sheet-iron, from 6 to 9 inches in diameter, with a turned edge, and is generally placed in a horizontal position. The diamond-dust, mixed with a little sperm-oil, is applied to the edge of the slitting-wheel with the finger, and is then pressed into the soft iron with a smooth hard stone. The wheel will then continue to cut for several hours without any renewal of the powder. When the wheel is thus prepared, a stone held by the hand to the cutting edge is rapidly slit through. During the operation, sperm-oil is kept dropping from the can, C, to keep the wheel from heating.

The grinding is performed on a horizontal lead-wheel, charged on its upper surface with emery-powder; the stone to be ground being pressed against it with the hand until it is smooth enough for polishing. In polishing, a tin wheel is substituted for the leaden one, the polishing material being rotten-stone.

If, instead of a plane flat surface, some ornamental surface is required, say an agate brooch in the shape of a butterfly, a model is produced in plaster of Paris, to serve as a guide, and metal size-plates are prepared for the pieces of stone which are to form the wings, &c. For these, thin slices of agate are cut at the slitting-machine, or chipped off with a hammer and chisel, and are then formed roughly into shape, by means of soft iron nippers. The several pieces are now ground and polished, as already described, and the brooch is finished. When pieces of stone are too small to be held in the hand, they are attached with cement to a wooden handle, and then applied to the wheels.

One of the most elaborate operations of the lapidary is the cutting of Cairngorm (q. v.) stones. The mode of faceting the surface, which so much enhances their beauty, is shewn in fig. 2, which is just the ordinary grinding-wheel, with the addition

LAPIS LAZULI—LAPLAND.

of a wooden peg, stuck round with projecting wires. The stone is fixed with cement on the end of a stick, having a hole at the other end fitting on the wire-points, which, being at different heights, enables the stone to be held at any angle to the grinding surface. With this simple guide, the lapidary proceeds to cut the facets, dividing them off

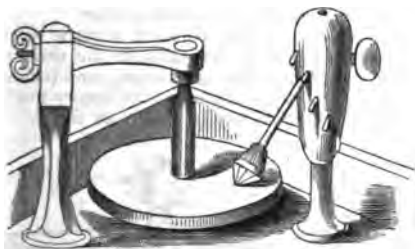

Fig. 2.

by the eye, aided by his sense of feeling; and in this way, in about a fortnight's time, as many as 700 facets are produced of perfect regularity upon a stone, say an inch in diameter. A Cairngorm of good colour, so cut, may be worth about £30.

LAPIS LAZULI, a mineral of beautiful ultramarine or azure colour, consisting chiefly of silica and alumina, with a little sulphuric acid, soda, and lime. The colour varies much in its degree of intensity. L.L. is often marked by white spots and bands. It is generally found massive, and is translucent at the edges, with uneven, finely granular fracture, but sometimes appears crystallised in rhombic dodecahedrons, its primitive form. It is found in primitive limestone and in granite; in Siberia, China, Tibet, Chili, &c. The finest specimens are brought from Bucharia. The Greeks and Romans called it *Sapphire*. It was more highly esteemed by them as an ornamental stone than it now is. They used it much for engraving, for vases, &c. It is extensively employed in ornamental and mosaic work, and for sumptuous altars and shrines. It is easily wrought, and takes a good polish. The valuable pigment called Ultramarine (q. v.) is made from it. It is one of the minerals sometimes called *Azure Stone*.

LAPITHÆ, a wild race, inhabiting, in ancient times, the mountains of Thessaly. They derived their name from a mythical ancestor, *Lapithes*, a son of Apollo, and the brother of Centaurs, the equally mythical ancestor of the Centaurs (q. v.). A bloody war is said to have been waged between the kindred races in pre-historic times, which ended in the defeat of the Centaurs, but the L. were in their turn subdued by Hercules.

LAPLACE, PIERRE SIMON, MARQUIS DE, one of the greatest of mathematicians and astronomers, was born 23d March 1749, at Beaumont-en-Auge, in the department of Calvados, was for some time a teacher of mathematics in the military school there, and afterwards went to Paris, where, having attracted the notice of D'Alembert, he was, through his influence, appointed professor in the military school, and was admitted a member of the Academy of Sciences. He had by this time mastered the whole range of mathematical science, as then known, and had besides solved several problems, which had for many years defied the attempts of geometers; and now it occurred to him to devote his mathematical powers to the service of astronomy, and he accordingly commenced to plan the work which afterwards appeared as the *Mécanique Céleste*. In his political life, L. presents a sorry picture. He

was appointed Minister of the Interior by Bonaparte, but was, after six weeks, deposed for incapacity. He continued, however, to receive marks of honour from Napoleon, and on the erection of the imperial throne, was made a count. In 1814, he voted for the appointment of the provisional government, for Napoleon's deposition, and the restoration of the Bourbons. After the second Restoration, Louis XVIII. made him a peer and a marquis. In the Chamber of Peers, he shewed, as he had done under the revolutionary government, the greatest unfitness for political affairs, and the most extreme servility. He died at Paris, 5th March 1827. L. was gifted with wonderful scientific sagacity; this appears especially in his explanations of certain results of mathematical analysis formerly looked upon as inexplicable, but which he shewed to be the expression of physical phenomena which had hitherto escaped detection, and subsequent observations generally confirmed L.'s conclusions. Above all his powers, his wonderful memory shone pre-eminent. His *Mécanique Céleste*, and supplements to it (5 vols. Paris, 1799—1825), are, next to Newton's *Principia*, the greatest of astronomical works. His *Exposition du Système du Monde* (2 vols. Paris, 1796; 6th ed. 1824) is intended for those who cannot follow the difficult demonstrations and calculations in his great work. All L.'s important investigations were made for the purpose of testing the generality of the law of gravitation, and the cause of sundry irregularities in the motions of the planets. His works comprise many able treatises on particular subjects in Astronomy, Pure Mathematics, Probabilities, Mechanics, Heat, and Electricity; most of them being Memoirs communicated to the Academy of Sciences.

LAPLAND. The territory still known under this name does not constitute a separate political autonomy, but is included under the dominions of Sweden and Norway, and of Russia, to the articles on which we refer for a special notice of its several divisions. L., or the Land of the Lapps, which is called by the natives Sameanda, or Somellada, occupies the north and north-east portions of the Scandinavian peninsula. Norwegian L. is included under the provinces of Norrland and Finmark; Swedish L., under North and South Bothnia, and divided into Torneå, Luleå, Piteå, Umeå, Ueså, Lappmark; Russian L., under Finland, in the circles of Kemi and Kola. Norwegian L. comprises an area of nearly 25,500 square miles, with a native population of 5000; Swedish L., an area of 50,600 square miles, with 4000 inhabitants; and Russian L., an area of 11,300 square miles, with a population of 8800. These numbers refer merely to the true Lapps, in addition to whom there are Finns, Swedes, Norwegians, and Russians, settled in various parts of the Lappish territory, whose respective numbers probably bring the population of the several parts to about the following figures—viz., for Norwegian L., about 50,000; for Swedish L., about 14,000; and for Russian L., about 60,000; but the boundaries of these divisions are so loosely defined, and their areas and populations so variously given by different writers, that it is difficult to arrive at an accurate estimate of either. The climate of the Lappish territory is extremely cold for nine months of the year; while the excessive heat of July and August, when in the northernmost parts the sun never sets for several weeks, is only separated from the cold seasons by a short spring and autumn of a couple of weeks. The general limit of the cereals is 66° N. lat.; but barley can be grown as far north in L. as 70°. The country is covered over a considerable part of its surface with forests, consisting chiefly of birch, pine,

fir, and alder, and having an undergrowth of lichens and mosses, which supply abundant food for the herds of reindeer which constitute the principal sources of wealth to the inhabitants. Many elevated tracts are, however, entirely destitute of vegetation, and consequently uninhabitable.

The LAPPS or LAPLANDERS, who are classed ethnologically in the same family as the Finns, Esthoniens, and Livonians, and who occupy the most northern parts of the Scandinavian peninsula, are distinguished, in accordance with the nature of their pursuits, as the *Sœlappen* and the *Boelappen*, or the Seafaring and Land-tilling Lapps. They were originally all nomadic; but the difficulty of finding sufficient food within the limited space to which the increasing civilisation of the neighbouring people had gradually restricted them, has compelled some of the tribes to settle near the larger rivers and lakes, where they follow the pursuits of fishing and hunting with considerable success. They shew great skill as marksmen, and regularly supply the large annual markets of Vitangi and Kengis with game and skins, which are sent by Tornœ to Stockholm, where they find a ready mart. The Lapps, who call themselves the *Sami* or *Sahmlade*, are a physically ill-developed, diminutive race, with small eyes, low forehead, high cheek-bones, pointed chin, and scanty beard. They are, however, neither wanting in mental capacity nor manual dexterity; and in the Seminary for Lapp teachers at Trondenes, in the district of Senjen, several of the students have distinguished themselves by their extensive acquirements. In the mythical sagas of Scandinavia, the Lapps are represented as an inferior race, distinguished only for craft and treachery, and addicted to practices of sorcery. They are regarded, in accordance with the same authorities, as the original occupiers of the whole of Scandinavia, from the fertile and more southern portions of which they were in ancient times driven forth by the superior, god-descended race of Odin, who banished them to the inhospitable regions in which they are now circumscribed. Their tendency to deceit is probably in a great measure to be attributed to the inferior position in which they are kept by the Norwegians, Swedes, and Russians, near whom they live, for they are honest, and strongly attached to their own people and country; and although they are still superstitious and credulous, they are not devoid of religious sentiment. They conform to the Christian faith of their neighbours—the Norwegian Lapps belonging to the Lutheran, and the Russian Lapps to the Greek Church. The Bible has been translated into their own language, which is divided, like that of all nomadic tribes, into numerous dialects, whose many affinities and differences have of late years attracted much attention from Northern and German philologists. The number of the Lapps probably falls below 30,000, of whom rather more than half are included in the population of Sweden and Norway, the remainder dwelling within the Russian dominions. The reindeer is the chief source of wealth, supplying the people with most of the articles of food and clothing which they use. Their dwellings consist either of conically shaped mud-huts, raised on stakes, and almost impervious to light and air, or of hide-covered tents. Towns or villages are unknown amongst them. The contempt with which they are regarded by the tall, well-developed Norwegian peasants, hinders all amalgamation between the races, while their peculiar habits, and the tenacity with which they cling to their own customs, tends still more to isolate them from the neighbouring nations.

LA PLATA. See PLATA.

LA PORTE, a flourishing town in the north-west of Indiana, United States of America, 12 miles from Lake Michigan, and at the junction of several important railways. It contains 11 churches, 3 newspapers, and large foundries, machine-shops, and manufactories. Pop. (1860) 5028.

LAPPENBERG, JOHANN MARTIN, a German historian, was born 30th July 1794, in Hamburg. He studied medicine at Edinburgh, but afterwards devoted himself to historical and political studies. He resided for some time in London, and afterwards studied law and history in Berlin and Göttingen. He became the representative of his native city at the Prussian court in 1820, and in 1823 was appointed archivist to the Hamburg senate, an appointment which led to his discovery of many valuable historic records which were supposed to have been lost. In 1850, he represented his native city at the diet of Frankfurt. One of his principal works is a *Geschichte von England* (2 vols. Hamb. 1834—1837; with continuation in 3 vols. Hamb. 1853, and Gotha, 1855—1858, bringing down the history to the end of Henry VII's reign); the first volume of which has been translated into English by B. Thorpe, with the title of *A History of England under the Anglo-Saxon Kings* (2 vols. Lond. 1845), and the second, with that of *A History of England under the Norman Kings* (1 vol. 1857). He is the author also of the following works, which are remarkable for the care and research which they display; viz., *Urkundliche Geschichte des Ursprungs der deutschen Hanse* (2 vols. Hamburg, 1830); *Die Geschichte Helgolands* (Hamburg, 1831); also an edition of Ditmar of Merseburg, and many valuable works relating specially to Hamburg and Bremen.

LAPSE. A legacy is said to lapse if the legatee dies before the testator; for as a will only operates from the death of the testator, and at that time the legatee is dead, the legacy lapses; i. e., falls into and becomes part of the residuary estate. So as to a devise. See LEGACY.

LAPSED (*Lapsi*), the designation applied, in the early centuries of the Christian Church, to those who, overcome by heathen persecution, did not continue faithful to the Christian religion. Their number was most considerable, when, after a long time of peace, the first general persecution under Decius began; but those who saved themselves by flight were reckoned amongst the L., although their case was not regarded as equally bad with that of those who sacrificed to idols. The L. were at first punished by excommunication, and their reception into the church again was strenuously resisted; but in the 3d c. a milder course was generally adopted with regard to them. The treatment of the lapsed was one of the practical questions most earnestly discussed in the early church.

LAPWING (*Vanelus*), a genus of birds of the family *Charadriidae* (Plovers, &c.), differing from the plovers chiefly in having a hind-toe, which, however, is small. The nasal grooves are also prolonged over two-thirds of the beak.—One species, the COMMON L., CRESTED L., or PEEWIT (*V. cristatus*), is a well-known British bird. It is also a native of almost all parts of Europe, and of some parts of Asia and of Africa. It is found in Bengal, in China, in Japan, and in Iceland; but it is not a native of America. It is not quite so large as a pigeon, and has the head surmounted with a beautiful crest. The head and crest are black; the throat black in summer, and white in winter; the back is green, glossed with purple and copper colour. The name L. is derived from the sound which the wings make in flight; the name Peewit

(Scottish *Peenosep*), with the French *Dichuit*, the Swedish *Wipa*, the Danish *Kivi* and *Vibe*, the old English *Wype*, the Greek *Atz*, &c., from the plaintive note; the local Scottish *Teuch-head* (Tufthead), from the crested head. The L. is very plentiful in moors, open commons, and marshy tracts, in pairs during the breeding-season; and in winter in flocks, chiefly on the sea-shore. Its artifices to prevent the discovery of its nest are very interesting.



Lapwing (*V. cristatus*).

The nest is little more than a mere depression in the ground, and the full complement of eggs is usually four; but if some are taken away, the bird goes on laying, an instinct of which the egg-gatherers take advantage. The eggs are esteemed a great delicacy, and great numbers are sent to the London market, under the name of *Plovers' Eggs*, from the marshy districts of England. The bird itself is also highly esteemed for the table.—A pet L. in a garden is of great service in preventing the too great increase of worms and slugs.—Some species of L. have wattles at the base of the bill.—The TERU-TERO of South America (*V. Cayanaensis*), a species with spurs on the wings, abounds on the Pampas of South America, is noisy on the approach of travellers, like the common L., and its eggs are likewise in the highest esteem as a delicacy.

LAR, an important town of Persia, capital of the province of Laristan; is situated on a well-wooded plain, at the foot of a ridge of hills, 60 miles from the Persian Gulf, and 180 miles south-south-east of Shiraz. The bazaar of Lar is said to be the finest and most elaborate in Persia. Pop. 12,000, who manufacture swords, muskets, and cotton-cloth.

LARBOARD, an obsolete naval term for the left side of a vessel, *looking forwards*. From its liability to be confused by the steersman with the not very different sound, 'starboard,' the word was a few years ago officially abolished, and the expression 'port' arbitrarily substituted. The terms *starboard* and *larboard* were originally Italian—*questo bordo*, this side (the right); and *quello bordo*, that side (the left); which were contracted into '*sto bordo* and '*lo bordo*, and finally became *starboard* and *larboard*. The word *port* is said to be an abbreviation of *porta la timone*, 'carry the helm,' suggesting the analogy of porting the arms on the left hand.

LAROENY is the technical legal term used in England and Ireland to denote the crime of stealing. Simple larceny means larceny unaccompanied with other crimes or circumstances of aggravation. Larceny is defined as an unlawful taking of things personal, with intent to deprive the right owner of the same. On each word and phrase of this definition many commentaries have been written; but as everybody understands what theft is, it is scarcely

necessary to enter into detailed explanations as to the variety of circumstances attending its perpetration. The common law, which was very defective in not mentioning many subjects which are now capable of larceny, such as title-deeds, wills, pigeons, dogs, oysters, vegetables, fruits, fixtures, &c., has been amended by various statutes, the provisions of which have been nearly all consolidated in the recent act 24 and 25 Vict. c. 96. An ancient doctrine of the common law was, that carriers, trustees, &c., could never be convicted of larceny, because they get the possession of the goods lawfully, in the first instance; but now these persons may be convicted of stealing, like others. Formerly, there was a distinction between petty larceny and grand larceny, according as the value of the thing stolen was under or above twelvepence; and the punishment was more severe in the latter case. The distinction has been abolished, and in all cases the crime of larceny is felony, though there are certain things, such as fruit, vegetables, hares, &c., the taking of which, though unlawful, and often called stealing, is not treated as such, but is punished by a moderate fine or imprisonment. Whoever corruptly takes a reward under pretence of assisting in recovering stolen property, unless he use due diligence to cause the offender to be brought to trial, is guilty of felony, and liable to seven years' penal servitude, or two years' imprisonment. Whoever shall publicly advertise a reward for the return of stolen property, stating that no questions will be asked, or promising to return to pawnbrokers or others any money advanced on such property, and also whoever shall print or publish such advertisement, shall forfeit £50 to any person who will sue for the same.

The punishment of larceny has varied in this as in all countries. In the Jewish law, it was punishable by fine and satisfaction to the owner. At Athens, it was converted from a capital offence into an offence punishable by fine. Our Saxon laws punished larceny, if the thing was above twelvepence in value, with death; but the law became subject afterwards to the softening effects of the Benefit of Clergy (q. v.). In 1827, the distinction of petty larceny was abolished, and every person convicted of simple larceny of any amount, was made liable either to transportation or imprisonment; but later statutes have abolished the punishment of transportation, and now the general punishment for simple larceny, and for felonies punishable like simple larceny, is penal servitude for three years, or imprisonment not exceeding two years, with or without hard labour and solitary confinement, and in the case of a male under 16, with or without whipping—such whipping to be administered by a birch-rod, and not more than twelve strokes. In case of previous offences, the term of penal servitude may be extended to seven or ten years. In some cases considered to be attended with great aggravation, as stealing linen, woollen, silken, &c. goods while in process of manufacture, if of the value of ten shillings, the term is increased to 14 years' penal servitude. In stealing cattle, the term is also 14 years, or imprisonment for two years. Larceny in a dwelling-house of money or goods above five pounds in value, is subject to 14 years' penal servitude, or two years' imprisonment; and the same is the punishment, whatever be the value, if by threats any one therein is put in bodily fear. The same punishment is awarded to larcenies in ships, wharfs, &c. Larceny from the person, when attended with personal violence, is called robbery. Robbery is felony punishable with 14 years' penal servitude, or two years' imprisonment. If it amount only to an assault with

intent to rob, the punishment is two years' imprisonment, or three years' penal servitude. Again, if the assault or robbery was with offensive weapons, or in company with other criminals, or attended with personal violence, the punishment is penal servitude for life. Larceny by a clerk or servant is punishable with 14 years' penal servitude, or two years' imprisonment. Larceny of letters by post-office letter-carriers is punishable with seven years' penal servitude, or two years' imprisonment, and if the letter contained money, with penal servitude for life. Receivers of stolen property are also guilty of felony, and punished with 14 years' penal servitude, or two years' imprisonment.

Besides the offences under the head of larceny which are indictable, there are many cognate offences which have been included in the same consolidation statute, but which are considered so far of a petty nature as not to merit the solemn punishment by indictment, and are left to be punished summarily by justices of the peace. Thus, some offences relating to wild animals and game are so treated; for example, hunting, carrying away or killing deer in the unenclosed part of a forest or park is punishable by justices with a fine of £50; and persons in possession of deer-skins, and not accounting for them, or setting snares for deer, incur a penalty of £20. Taking or killing, or setting snares unlawfully for hares or rabbits in enclosed ground by day, subjects the party to a penalty of £5. Stealing a dog is subject to a penalty of £20, over and above the value of the dog; and having a stolen dog or its skin in one's possession, subjects to a penalty of £20. Stealing birds, beasts, or other animals ordinarily kept in a state of confinement, or for any domestic purpose (not being fit for food), or wilfully killing the same, with intent to steal, subjects to a penalty of £20, besides the value, or to six months' imprisonment. Killing or wounding house-doves or pigeons subjects the party to a penalty of £2, besides the value of the bird. Taking or destroying fish in a stream or water which is private property, subjects the party to a penalty of £5, besides the value of the fish; and angling in the same induces a penalty of £2, besides seizure of the fishing-tackle. Stealing trees and shrubs or underwood worth 1s., subjects the party to a penalty of £5; so does stealing or destroying fences, or posts, wires, &c., used as such. Stealing fruit or vegetables from gardens, &c., subjects the party to a penalty of £20, besides the value, or to six months' imprisonment. Stealing cultivated roots or plants used for the food of man or beast, or for medicine, growing in fields, &c., subjects the party to a fine of 20s., besides the value, or to one month's imprisonment. Having shipwrecked goods knowingly in one's possession, or exposing the same for sale, subjects to a penalty of £20, besides the value, or to six months' imprisonment. See LOST PROPERTY.

In Scotland, theft is distinguished into trifling theft or pickery, which is punishable with fine, imprisonment, or whipping. Simple theft was never a capital offence, unless aggravated, as theft by a trustee, theft of cattle, or of children. The punishment of theft in Scotland is left very much to the discretion of the court.

LARCH (*Larix*), a genus of trees of the natural order *Conifera*, differing from firs (*Abies*)—of which, however, some botanists regard it as a mere sub-genus—in having the scales of the cones attenuated at the tip, and not falling off from the axis of the cone when fully ripe, and the leaves deciduous and in clusters, except on shoots of the same year, on which they are single and scattered.—The COMMON L. (*L. Europæa* or *Abies Larix*) is a beautiful tree,

growing wild on the mountains of the south and middle of Europe, and found also in Asia, where it extends much further north than in Europe, even to the limits of perpetual snow. The L. is not a native of Britain, and was not planted in any part of the island as a forest tree till the middle of the 18th c., when it began to be very extensively planted. Its introduction has changed the aspect of whole districts, particularly in Scotland. The perfectly erect and regularly tapering stem of the L., its small branches, its regular conical form, and its very numerous and very small leaves, make its aspect peculiar, and very different from that of any other tree seen in Britain. It attains a height of 60—100 feet, and an age of 200 years. The male catkins are small and bright yellow, the female catkins generally purple and erect; the cones ovate-oblong, about an inch long, and erect. The L. grows rapidly, and is useful even from an early age; the thinnings of a plantation being employed for hop-poles, palings, &c.; the older timber for a great variety of purposes.

It is very resinous, does not readily rot even in water, is not readily attacked by worms, and is much used in ship-building. It is, however, very apt to warp, and is therefore not well suited for planks.—L-bark is used for tanning, although not nearly equal in value to oak-bark.—In Siberia, where large tracts of L. forest are not unfrequently consumed by accidental fires, the scorched stems yield, instead of a resin, a gum similar to gum-arabic, reddish, and completely soluble in water, which is known as *Orenburgh Gum*, and is used for cementing and in medicine, and, notwithstanding a somewhat resinous smell, even as an article of food.—In warm countries, a kind of Manna (q. v.) exudes from the leaves of the L., in the hottest season of the year, having a sweetish taste, with a slight flavour of turpentine. It is gathered principally in France, and is known as *Briançon Manna*, or *L. Manna*.—The L. woods of Britain have of late years suffered greatly from a disease, in which the centre of the stem decays; the nature and causes of which are very imperfectly understood, although it seems to be sufficiently ascertained that those plantations are peculiarly liable to it which are formed where any kind of fir has previously grown, and those least so which are regularly thinned, so that the trees enjoy abundance of fresh air. The L. does not dislike moisture, but stagnation of water is very injurious to it, and thorough drainage is therefore necessary.—There are varieties of the Common L. remarkable for crowded branches, for pendulous branches, and for other peculiarities, which are sometimes planted as ornamental trees.—The RED AMERICAN L., or HACKMATAK (*L. tenuifolia*), distinguished by very small cones not quite half an inch in length, is common in the northern parts of North America, and on the Alleghany Mountains, often covering extensive tracts. It is a noble tree, much

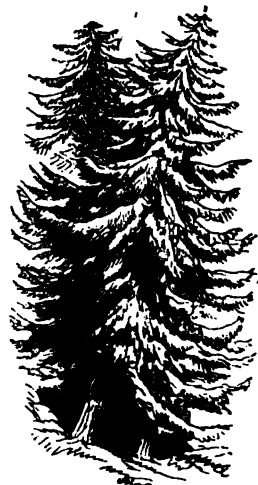

Larch (*L. Europæa*).

resembling the common L., and its timber is highly valued.—The PENDULOUS L., or BLACK AMERICAN L. (*L. pendula*), is another very fine North American species, with larger leaves.—The HIMALAYAN L. (*L. Griffithii*), abounds in the Himalaya, but is generally a small tree of 20–40 feet high. Its cones are larger than those of the Common Larch. Its wood is very durable.

LARD, the fat of the hog. Until after the first quarter of the present century, lard was only used for culinary purposes, and as the base of various ointments in medical use. The enormous extent, however, to which pork was raised in America, rendered it necessary to find some other applications for so valuable a material, and large quantities were pressed at a low temperature, by which the stearine and oleine were separated. The former was used for candle-making; and the latter soon became a very important article of commerce, under the name of 'lard oil,' which was found to be a valuable lubricant for machinery. As much as 20,000 tons of lard, stearine of lard, and lard oil have been imported in one year, more than two-thirds of which were from the United States of America. The manufacture of stearine candles and fine oleine from palm oil, cocoa-nut oil, and various kinds of grease, by Messrs Price & Co., and other large manufacturers, has greatly diminished the imports from America.

LARDNER, NATHANIEL, D.D., an eminent English divine, was born at Hawkhurst, in Kent, in 1684, and studied first in London, and afterwards at Utrecht and Leyden. L. belonged to a body of English Presbyterians, who had become Unitarians. He died in 1768. L. was not a popular preacher; but his *Credibility of the Gospel History*, and his *Jewish and Heathen Testimonies*, have secured for him a permanent place among the modern apologists for Christianity. The last edition of his works, in ten volumes, appeared at London in 1828.

LARDNER, DIONYSIUS, LL.D., a distinguished writer on physical science, was born in Dublin, April 3, 1793, and first became known by his *Treatise on Algebraical Geometry* (Lond. 1823), and by a work on the *Differential and Integral Calculus* (Lond. 1825). In 1828, he was appointed Professor of Natural Philosophy and Astronomy in University College, London; and in 1830, he projected a sort of encyclopædia, consisting of original treatises on history, science, economics, &c., by the most eminent authors; and 134 volumes were accordingly published, under the general name of *Lardner's Cyclopædia*, between 1830 and 1844. Some of these volumes were from his own pen. A second issue of this work was begun in 1853. He has published various scientific works, the most important of which are his 'handbooks' of various branches of natural philosophy (1854–1856). He is also the author of the *Museum of Science and Art*, an excellent popular exposition of the physical sciences, with their applications. He died in Naples, April 29, 1859.

LARES, MANES, AND PENATES, were tutelary spirits, genii, or deities of the ancient Romans. The derivation of the names is not perhaps quite certain, but the first is generally considered the plural of *lar*, an Etruscan word signifying 'lord' or 'hero'; the second is supposed to mean 'the good or benevolent ones'; and the third is connected with *penus*, 'the innermost part of a house or sanctuary.' The Lares, Manes, and Penates do not appear to have been regarded as essentially different beings, for the names are frequently used either interchangeably or in such a conjunction as almost implies identity. Yet some have thought that a distinction is discernible, and have looked upon the Lares as

earthly, the Manes as infernal, and the Penates as heavenly protectors—a notion which has probably originated in the fact, that Manes is a general name for the souls of the departed, those who inhabit the lower world; while among the Penates are included such great deities as Jupiter, Juno, Vesta, &c. Hence we may perhaps infer that the Manes were just the Lares viewed as departed spirits, and that the Penates embraced not only the Lares, but all spirits, whether daimons or deities, who exercised a 'special providence' over families, cities, &c. Of the former, Manes, we know almost nothing distinctively. An annual festival was held in their honour, on the 19th of February, called *Feralia* or *Parentalia*; of the latter, Penates, we are in nearly equal ignorance, but of the Lares we have a somewhat detailed account. They were, like the Penates, divided into two classes—*Lares domestici*, and *Lares publici*. The former were the souls of virtuous ancestors set free from the realm of shades by the Acherontic rites, and exalted to the rank of protectors of their descendants. They were, in short, household-gods, and their worship was really a worship of ancestors. The first of the Lares in point of honour was the *Lar familiaris*, the founder of the house, the family Lar, who accompanied it in all its changes of residence. The *Lares publici* had a wider sphere of influence, and received particular names from the places over which they ruled. Thus, we read of *Lares compitales* (the Lares of cross-roads), *Lares vicorum* (the Lares of streets), the *Lares rurales* (the rural Lares), *Lares viales* (the Lares of the highways), *Lares permarini* (the Lares of the sea), and the *Lares cubiculi* (the Lares of the bedchamber). The images of these guardian spirits or deities were placed (at least in large houses) in a small shrine or compartment called *œdicule* or *lararia*. They were worshipped every day: whenever a Roman family sat down to meals, a portion of the food was presented to them; but particular honours were paid to them on the Calends, Nones, and Ides of the month; and at festive gatherings, the lararia were thrown open, and the images of the household gods were adorned with garlands.

LARGESSE, money which, in early times, it was the practice to grant to heralds on certain state occasions, for proclaiming the style and title of the sovereign and his nobles. The regular fees, as recorded in one of the Ashmolean MSS., were, 'At the coronation of the king of England, c^d appraised in scarlet. At the displaying of the king's banner in any campe, c. markes. At the displaying of a duke's banner, £20; at a marquis', 20 markes; at an earle's, 10 markes. The king marrying a wife, £50, with the giftes of the king's and queene's uppermost garments; at the birth of the king's eldest son, 100 markes; at the birth of younger children, £20. The king being at any syge with the crowne on his head, £5.'

LARGO, an Italian word, used in music, to denote the slowest of all the *tempi*, and especially in compositions where the sentiment is quite solemn. LARGHETTO is the diminutive of *Largo*.

LARGS, a small town on the coast of Ayrshire, Scotland, a favourite resort for sea-bathers, is beautifully situated on the Firth of Clyde, on a pleasant strip of shore, backed by hills, 18 miles below Greenock. The population in 1861 was 2638, but the number is greatly increased in mid-summer. Here, in 1263, Alexander III. of Scotland, in the course of a war between that country and the Norwegian colonies of Man and the Isles, defeated Hacon, king of Norway, who, with 160 ships and 20,000 men, had descended upon the coast of Ayrshire. The results of this battle were

LARICIO—LARKSPUR.

the immediate withdrawal of the invading force, and the abandonment within three years of the Norwegian pretensions to the Scottish Islands.

LARICIO. See PINZ.

LARIDÆ, a family of birds, of the order *Palmpedes* or *Natatores*, called *Longipennes* by Cuvier, from the length of wing which is characteristic of them. They are generally capable of protracted as well as of rapid and graceful flight; all of them are sea-birds, although some resort to breeding-places at some distance inland, and some follow the course of rivers to very considerable distances from the sea. Some of them are the most oceanic of all birds, being often seen far from any shore. They generally take their prey either by a sudden descent to the water during flight, or whilst swimming, and are not good divers. The hind-toe is small and free; the bill is pointed or hooked, but destitute of lamellæ. Gulls, Skuas, Terns, Petrels, Shearwaters, Albatrosses, Noddies, Skimmers, &c., belong to this numerous family, which has many representatives in all parts of the world. They prey chiefly on fishes and molluscs, and are in general ready to eat any animal garbage.

LARISSA (called by the Turks *Yenischir*), a town of European Turkey, in the province of Thessaly, and one of the most ancient and important in that territory, is situated on the Salembria (anc. *Peneus*), in lat. 39° 37' N., long. 22° 28' E. It contains numerous mosques, from which arise many slender and dazzling white minarets. It carries on an important transit-trade, with manufactures of silk and cotton goods, and Turkey-red dyeworks. Pop. 25,000. In ancient times it was celebrated for its bull-fights.

LARISTAN AND **MOGISTAN**, two maritime provinces of Persia, bounded on the S. by the Persian Gulf, and the Gulf of Oman, and on the N. by the provinces of Farsistan and Kerman:

LARK (*Alauda*), a genus of small birds of the order *Insectorum*, section *Comirostres*, the type of a family *Alaudida*, to the whole of which the English name is commonly extended. In this family, the bill, although stout, and nearly conical, is more lengthened than in buntings and finches. The toes are long, and separate to the base; the claws long and little curved, that of the hind-toe generally very long. The true larks (genus *Alauda*) have also long wings, and great power of flight. Many of them are birds of passage. In common with almost all the family, they nestle and seek their food—seeds, insects, worms, &c.—on the ground; and in admirable harmony with this mode of life, their plumage exhibits much uniformity of colouring, so that when on the ground they may not readily be noticed by their enemies. The L.

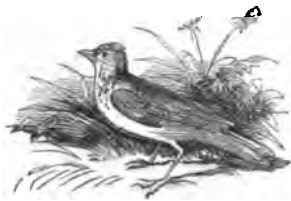

Sky Lark (*Alauda arvensis*).

family is very widely distributed over the world. The COMMON L., FIELD L., or SKY L. (*Alauda arvensis*), is one of the best-known British birds, and notwithstanding the tameness of its brown plumage, is a universal favourite, on account of the sweetness of its cheerful song, which it pours

forth whilst soaring and floating in the air, and which every one associates with pleasant scenes and delightful days. It more rarely sings on the ground. It is in great repute as a cage-bird, and sings well in confinement, but flutters its wings whilst singing, as if still desirous of soaring in the air. It abounds chiefly in open but cultivated districts. It is common in most parts of Europe, but from the more northern parts, it migrates southward on the approach of winter. It is also a native of Asia, and is a winter visitant of the north of Africa. It is not found in America. It makes its nest generally in an open field, and often under shelter of a tuft of herbage, or a clod of earth; lays four or five mottled eggs, and generally produces two broods in a season. It is not truly gregarious in summer, but in winter large flocks assemble together; and at this season multitudes of larks are taken for the table in the south of England, in France, and other countries. They are often caught by horse-hair nooses, attached to a long line of packthread, to which the nooses are fastened at distances of about six inches, the line being pegged to the ground at intervals of twenty yards. This mode is most successful when the ground is covered with snow, and a little corn is scattered along the line. The Clap-net (q. v.) and Trammel-net (q. v.) are also employed by lark-catchers, and great numbers of larks are taken in some parts of England by dragging the trammel-net over the stubbles and pastures. *Twirling for larks* is a peculiar mode of turning to account the attractiveness which any glittering object possesses for these birds. It is a French practice. A piece of highly polished mahogany, or of some common wood inlaid with bits of looking-glass, is fastened on the top of a rod, so as to reflect the sun's rays upwards, and is made to twirl by means of a string. Larks are greatly attracted by it, congregate around it, and are readily shot in large numbers.—The CRESTED L. (*A. cristata*), very similar in size and plumage to the common L., but having the feathers of the crown of the head more distinctly developed into a crest, although a very common bird in many parts of Europe, and abundant near Calais, has very seldom been seen in Britain.—The WOOD L. (*A. arborea*), a smaller species, not unfrequent in some parts of England, but rare in Scotland, is a bird of very delightful song, and usually sings perched on the branch of a tree. It frequents wooded districts. Its nest, however, is made on the ground.—The SHORE L. (*A. alpestris*), which has only in rare instances been found in Britain, inhabits the northern parts of Europe, Asia, and America, and is the only North American species. Its song is very sweet, and gladdens the visitor of such desolate shores as those of Labrador, where it breeds, amidst the tufts of mosses and lichens, with which the bare rocks are interspersed. It is a winter visitant of New England, and is sometimes seen as far south as Georgia. The head has two erect tufts of feathers, somewhat resembling those of horned owls. Black, white, and yellow vary the brown plumage of the Shore Lark.

LARKHANA, the capital of a district of its own name in Sindh, stands 145 miles north of Hyderabad. It contains about 12,000 inhabitants, and manufactures silk and cotton, besides being one of the largest corn-marts in the country.

LARKSPUR (*Delphinium*), a genus of plants of the natural order *Ranunculaceæ*, annual and perennial herbaceous plants, natives of the temperate and cold regions of the northern hemisphere. They have five sepals, the upper spurred; four petals, distinct or united into one, the two upper having spurs inserted into the sepaline spur; and 1—5 many-seeded

follicles. Some of them are well known and favourite garden-flowers, as the UPRIGHT L. (*D. Ajacis*), a native of Switzerland, and the BRANCHING L. (*D. consolida*), a native of most parts of Europe, and a



Palmated Larkspur or Stavosacre (*Delphinium stavisacria*).

rather doubtful native of England. *D. glaciale* is one of the most alpine plants in the world.

LARMES, in Heraldry. When the field is bestrewed with an indefinite number of drops of a blue colour, it is said to be *gutté de larmes*, a nomenclature which, though French, is peculiar to British Heraldry, the French blazoning such a shield *gutté d'azur*.

LAROCHEFOUCAULD, an old French family of great celebrity, whose original seat was the small town of Larochefoucauld, near Angoulême. The history of the family is traced back to 1026, when a certain Foucauld, first seigneur de la Roche, is spoken of in a charter of an abbey of Angoulême as *sir nobilissimus Fulcaudus*. In the religious wars of the 16th c., it embraced the cause of the Protestants.

—**FRANÇOIS, DUC DE L.**, and **PRINCE DE MARSILLAC**, born 1613, was much attached to literary pursuits; and after having been involved in intrigues against Cardinal Richelieu, and in the tumults of the Fronde, he retired into private life, cultivated the society of the most eminent literary persons of his time, Boileau, Racine, and Molière, and composed his famous *Mémoires* (Cologne, 1662; Amst. 1723, &c.), in which he gives a simple but masterly historic account of the political events of his time. In 1665, he published also his *Réflexions ou Sentences et Maximes Morales*, a work containing 360 detached thoughts, of which, perhaps, the most widely celebrated is his definition of hypocrisy, as 'the homage which vice renders to virtue.' The book is regarded as a model of French prose, and exhibits much acuteness of observation, and a clear perception of the prevalent corruption and hypocrisy of his time. He died 17th March 1680. His *Œuvres Complètes* were edited by Depping (Par. 1818), and his writings have been commented on by a host of critics of the most different schools, as Voltaire, Vinet, Sainte-Beuve, and Victor Cousin.—**FRANÇOIS ALEXANDRE FRÉDÉRIC, DUC DE L.-LIANCOURT**, an eminent philanthropist, born 11th January 1747, was representative of the nobles of Clermont in the States-general, and was a zealous advocate of reform, but sought to preserve the monarchy. After the catastrophe of 10th August, he fled to England,

and lived in great penury, till he obtained back, in 1794, some fragments of his property. He now visited North America, and afterwards published his *Voyage dans les Etats-Unis d'Amérique fait en 1795—1797* (8 vols. Par. 1798). Having returned to Paris, he lived for some time in retirement, occupied only with the extension of vaccination and similar works of benevolence. Napoleon restored him his ducal title in 1809. After the Restoration, he was made a peer, but soon gave offence to the court, by opposing its unconstitutional policy. He laboured zealously in promotion of many patriotic and philanthropic objects. He founded the first savings-bank in France. He died 27th March 1827.

LAROCHEJAQUELEIN, DU VERGER DE, an old noble family of France. The name Du Verger is derived from a place in Poitou. Guy du Verger married, in 1605, the heiress of the seigneur of Larochejaquelein. Several of his descendants distinguished themselves as soldiers, after the beginning of the French Revolution, by their strenuous efforts in the cause of the Bourbons.—**HENRI, Comte de Larochejaquelein**, born 1772, was an officer in the guard of Louis XVI., and after the 10th of August 1792, left Paris, and put himself at the head of the insurgent royalists in La Vendée. He signalled himself by many heroic deeds, and for a time successfully repelled the republican forces, but was defeated by Generals Westermann, Müller, and Tilly, 13th December 1793, and escaped with difficulty. He raised a new body of troops, however, in Upper Poitou, but was killed in a battle at Nouaillé, 4th March 1794.—His brother, **LOUIS DU VERGER, Marquis de Larochejaquelein**, born 1777, emigrated at the commencement of the Revolution; returned to France in 1801, but resisted all Napoleon's efforts to win him, and in 1813 placed himself at the head of the royalists in La Vendée. Louis XVIII. appointed him, in 1814, to the command of the army of La Vendée, and during the Hundred Days he maintained the royalist cause there, supported by the British. He fell in battle at Pont-des-Mathis, 4th June 1815. His wife, **MARIE-LOUISE VICTOIRE, Marquise de Larochejaquelein** (born 1772—died 1857), published *Mémoires of the War in La Vendée*, of which she was an eye-witness (Bordeaux, 1855), which are of great value, and have gone through many editions.

LA ROCHELLE. See ROCHELLE, LA.

LARREY, DOMINIQUE JEAN, BARON, a celebrated French surgeon, was born in 1766 at Baudéan, near Bagnères-de-Bigorre, studied medicine with his uncle, Alexis L., and attended the two hospitals, the Hôtel-de-Dieu and the Hôtel-des-Invalides, having previously served for a short time both in the army and navy. In 1792, he was appointed second physician to the Hôtel-des-Invalides, and in 1793 accompanied the French army to Germany and Spain, making at this time the important invention of the *ambulance volante*, for the convenience of transporting the wounded. Napoleon summoned him to Italy in 1797, after he had been for a short time a professor in the medico-surgical school at Val-de-Grâce; and he accompanied the expedition to Egypt. In 1805, he was placed at the head of the medico-surgical department in the French army, and was created a Baron of the Empire, receiving also a considerable pension. He was wounded and taken prisoner at Waterloo, and at the Restoration lost his rank and pension; the latter, however, was restored in 1818; and he continued to fill important and honourable offices till 1836, when he retired from that of surgeon-general of the Hôtel-des-Invalides. On the 16th of May 1842, he embarked for Algeria, having been appointed

LARVA—LARYNX.

inspector of the military hospitals there, and while on his return, after having concluded his labours, he died at Lyon, 24th July 1842. Apart from the skill, talent, courage, and humanity shewn in the course of his practice, L. has a high scientific reputation, and is the author of a number of very valuable books on various subjects connected with his profession, most of which have been translated into other languages. L.'s works have been considered by eminent authorities to be 'the connecting link between the surgery of the last age and that of the present day.'

LA'RYA, in Natural History, is the denomination of animals which undergo transformation, in that state in which they first exist after issuing from the egg. Until recently, the larva state was known in insects only, and the term larva is still commonly used only with regard to them; but it has been discovered that many marine animals spend a considerable part of their existence in such a state, during which they are often extremely different from what they become after their next transformation; some of them, as the young of the Cirrhopoda, swimming about freely in the larva state, whilst they become firmly fixed to one spot when they have reached their perfect development, and—which seems still more remarkable—possessing eyes in the former state, and becoming destitute of them in the latter. The larva state of crabs exhibits a very singular form, long known as a distinct genus of crustaceans, under the name *Zoëa*. The young of at least some Entozoa pass through a larval state; those of the tape-worms were formerly regarded as creatures altogether distinct, and received the generic name *Scölex*, which when now used is with regard to these animals equivalent to larva.—The larvæ of insects differ very much in the degree of their development, the differences being characteristic of different orders; some of them much resembling the perfect insect, except in the want of wings, and others being very unlike it. The larvæ of many insects, particularly those which are very unlike the perfect insect, as grubs (coleopterous larvæ), maggots (dipterous larvæ), and caterpillars (lepidopterous larvæ), accumulate fat in great quantity, which serves to sustain them during their *Pupa* (q. v.) state, in which they take no food. The same accumulation of fat does not take place in larvæ more nearly similar to the perfect insect, as in neuropterous insects, the pupæ of which are active and voracious.

LARYNGITIS, or INFLAMMATION OF THE LARYNX, may be either an acute or a chronic affection. Acute laryngitis, in its more severe form, commences with a chill, which is followed by fever, with a full strong pulse, a hot skin, and a flushed face. There is also soreness of the throat, hoarseness of the voice, great difficulty in swallowing, and a feeling of extreme constriction of the larynx. There is a painful stridulous cough, but only a little mucus is ejected. Great difficulty of breathing soon comes on, the act of inspiration being prolonged, and wheezing, in consequence of the swollen membrane of the glottis impeding the entrance of air. On examining the fauces, the epiglottis (see **LARYNX**) is observed to be of a bright red colour, erect, and so much swollen as not to be able to descend and close the glottis during deglutition. The patient exhibits symptoms of great anxiety and distress; his lips become blue, his face of a livid paleness, his pulse irregular and very feeble, and at length he sinks into a drowsy state, often preceded by delirium, and quickly followed by death. The disease is very rapid, ending, when fatal, in three or four days, and occasionally in less than one day.

The most frequent cause of laryngitis, whether

mild or severe, is exposure to cold and wet, especially when in a state of perspiration. It frequently also arises from direct injury to the larynx, as from attempting to swallow boiling water or corrosive fluids, from inhaling irritating gases, &c.

In severe cases, the strongest antiphlogistic treatment must be at once adopted, as general bleeding, leeching, and either tartar emetic or calomel. If these fail, the only remedy upon which much reliance can be placed is tracheotomy. In chronic laryngitis, there is hoarseness, the voice is altered, and various morbid sensations are felt in the larynx, which excite cough. If the disease goes on to ulceration, phthisis or syphilis is probably its cause. The treatment of ulcerated larynx is noticed in **LARYNX, DISEASES OF**.

LARYNGOSCOPE AND LARYNGOSCOPY. Although attempts had been previously made by Avery and Garcia to explore the recesses of the larynx by means of a reflecting mirror, it was not until two German physiologists, Drs Turck and Czermak, took up the subject in 1857 and 1858, that the great importance of laryngoscopy was first generally recognised.

The laryngoscope is a small mirror placed on a stalk attached to its margin, at an angle of from 120° to 150°, the stalk being about six inches in length, and being composed of flexible metal, so that it can be bent at the will of the operator.

The mouthpiece of a large reflector, with a central opening through which the observer looks, is held between the molar teeth; or, which is better, the reflector may be attached to a spectacle frame by a stiffly working ball-and-socket joint. The rays of the sun or of a good lamp are concentrated by means of this reflector on the laryngeal mirror, which is placed against the soft palate and uvula. The laryngeal mirror, introduced with the right hand, which rests by two fingers on the jaw, is maintained at such an inclination that it throws the light downwards, and illuminates the parts to be examined, while at the same time it reflects the images of these parts into the eye of the observer through the central opening of the reflector. By this means he can look through the larynx into the trachea or windpipe.

By means of this instrument we can see the actual position of small tumours, ulcers, &c., whose existence would otherwise have been at most only suspected; and the precision and accuracy of diagnosis to which we can thus attain, enable us to employ rational means of local treatment to an extent that was quite impossible before the introduction of laryngoscopy.

LARYNX, THE (Gr. *larynx*), is the organ of voice, and takes a part in the respiratory process, as all air passing either to or from the lungs must pass through it. It is a complex piece of mechanism, resembling a box composed of pieces of cartilage, which may be moved on each other, and enclosing the membranous bands (the *chordæ vocales*) by which the vocal vibrations are produced.

It is situated between the *trachea*, or windpipe, and the base of the tongue, at the upper and front part of the neck, where it forms a considerable projection (especially in men) in the mesial line; and it opens superiorly into the *pharynx*, or throat, and inferiorly into the windpipe.

The cartilages of which the skeleton of the larynx is composed are five in number—viz., the thyroid and the cricoid cartilages, the epiglottis, and the two arytenoid cartilages.

The *thyroid* (Gr. shield-like) cartilage consists of two square plates of cartilage united in front at an acute angle, which forms the projection which is

LARYNX.

commonly known as the *pomum Adami*, or Adam's apple. Each of these plates is prolonged at the upper and lower posterior corners. The thyroid



Fig. 1.

(From Todd and Bowman.)

Cartilages of larynx and epiglottis, and upper rings of trachea, seen from behind: *a*, arytenoid cartilages; *b*, superior cornua of thyroid cartilage; *c*, its inferior cornua; *d*, posterior surface of cricoid; *f*, epiglottis, with its perforations; *t*, upper margin of thyroid; *h*, its left inferior tubercle; *i*, trachea.

cartilage forms almost the whole of the anterior and lateral walls of the larynx.

The *cricoid* (Gr. ring-like) cartilage is a ring whose lower margin is parallel to the first ring of the trachea, to which it is united by fibrous membrane. Its upper border is connected in front with the lower border of the thyroid cartilage by a thick yellow fibrous tissue. It presents two articular surfaces on

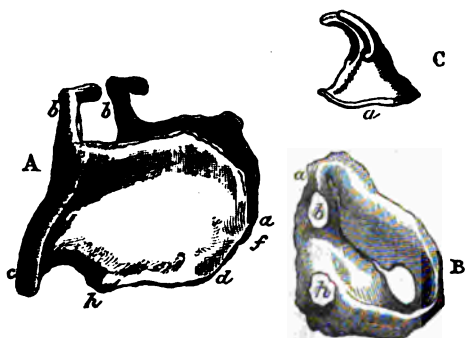

Fig. 2.

A, side view of thyroid cartilage: *a*, the notch; *b*, superior, and *c*, inferior cornua; *g*, *h*, superior and inferior tubercles; *f*, *pomum Adami*. *B*, side view of cricoid cartilage: *a*, posterior superior margin; *b*, articulating surface of right arytenoid cartilage; *c*, surface articulating with inferior cornua of thyroid. *C*, the right arytenoid cartilage: *a*, its base articulating with the upper margin of the cricoid.

either side, viz., a lower one (*h* in *B*, fig. 2), which articulates with the inferior cornua of the thyroid cartilage, and an upper one (*b* in *B*, fig. 2), which is

oval in form, and supports an arytenoid cartilage. The *arytenoid* (Gr. ladle-like) cartilages are pyramidal bodies resting on the oval articular surfaces at the upper and posterior part of the cricoid cartilage. When *in situ*, they present a concave posterior surface (fig. 1). From their connection with the vocal cords, and from their great mobility as compared with the two larger cartilages, the arytenoids play a very important part in the mechanism of the larynx. The *epiglottis* is a very flexible cartilaginous valve (fig. 1, *f*), situated at the base of the tongue, and covering the opening of the larynx. Its direction is vertical, except during deglutition, when it becomes horizontal. It is attached inferiorly by a kind of pedicle to the angle of the thyroid cartilage. Upon removing the investing mucous membrane, the cartilage is found to be perforated by numerous foramina, *f*. Each perforation admits some fasciculi, of yellow, elastic, ligamentous tissue, which expands on its anterior aspect, and secures the return of the epiglottis to its vertical position, independently of any muscular action. Such is the skeleton of the larynx, which hangs from the hyoid bone, with which it is connected by the thyro-hyoid ligament and certain muscles.

The various cartilages which have been described are connected to one another by ligaments, the chief

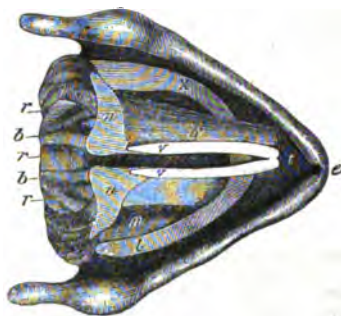

Fig. 3.

View of larynx from above, after Willis. *b*, ligaments uniting arytenoid and cricoid cartilages; *c*, thyroid cartilage in front; *k*, left thyro-arytenoid muscle, right removed; *l*, *r*, *z*, cricoid cartilage; *m*, right crico-arytenoid muscle; *s*, arytenoid cartilage; *t*, *v*, vocal cords.

of which are those known as the true and false vocal cords. In their quiescent state, the true vocal cords do not lie parallel to each other, but converge from behind forwards (see fig. 3). The length of the vocal cords is greater in the adult male than in the adult female, in the ratio of three to two. In infancy, they are very short, and increase regularly from that period to the age of puberty. The mucous membrane of the larynx is part of the great respiratory tract (see **MUCOUS MEMBRANE**), and is remarkable for its great sensibility.

The length of the chink or aperture of the glottis, which is directed horizontally from before backwards, varies, like the vocal cords, until the period of puberty, when its length, in the male, undergoes a sudden development, while in the female it remains stationary. In the adult male, it is about eleven lines in length.

The larynx is provided with two sets of muscles, viz., the *extrinsic*, by which the whole organ is elevated or depressed, and the *intrinsic*, which regulate the movements of the various segments of the organ in relation to one another. By the action of these latter muscles, aided, in some cases,

by the extrinsic muscles, the tension of the vocal cords may be increased or diminished, and the size of the opening of the glottis regulated at will.

The nerves of the larynx are derived from the superior and inferior laryngeal branches of the pneumogastric or vagus nerve. The superior branch is for the most part sensory (being mainly distributed to the mucous membrane), while the inferior branch communicates motor-power to all the intrinsic muscles except the crico-thyroid.

In the preceding account of the cartilages, vocal cords, mucous membrana, muscles, and nerves of the larynx, we have included only the most essential points. For details regarding the attachments of muscles, &c., the reader must consult any standard work on Anatomy. That the larynx is the organ of voice, is proved by numerous facts, amongst which the following may be mentioned. 'First, the least alteration in the condition of the mucous membrane covering the vocal cords, is invariably accompanied by a change in the tone of the voice, a g., hoarseness; secondly, ulcerative disease, eating through one or both of these vocal cords, destroys or greatly impairs the voice; thirdly, opening the trachea below the vocal cords, so as to divert the current of air in expiration from the larynx, will destroy the voice; fourthly, section of the inferior laryngeal nerves, by which the influence of the will is brought to bear on the muscles which regulate the tension of the vocal cords, destroys the voice; and lastly, by experiments on the dead larynx, sounds may be produced resembling those of the voice.'—Todd and Bowman's *Physiological Anatomy*, vol. ii. p. 431.

Diseases of the Larynx.—Of these, the most serious is *acute inflammation* of the larynx, or *Laryngitis* (q. v.).

Edema, or swelling of the glottis, although of common occurrence in laryngitis, may be developed independently of inflammation, from obstruction of the veins leading from that part, or from other causes. The symptoms are those of acute inflammation, except that there is no fever or inflammation, and less difficulty of swallowing. Tracheotomy (the operation of making an opening into the wind-pipe, below the seat of the disease) affords the patient almost his only chance of life.

Chronic inflammation and ulceration of the larynx are very common in tubercular consumption and in secondary syphilis. In these cases, the laryngeal affection is merely a local manifestation of a general disease. The chronic hoarseness and cough are often remarkably relieved, in these cases, by swabbing the epiglottis and upper part of the air-passages with a strong solution of lunar caustic.

LA SALLE, a city of Illinois, United States of America, 110 miles north-north-east of Springfield, is the terminus of the Illinois and Michigan Canal, and junction of the Illinois Central and Chicago and Rock Island Railways. La S. has eight coal-mines near the city, five churches, and two newspapers. The Illinois Central Railroad here crosses the Illinois River on a bridge of twenty arches, 900 feet in length. Pop. about 4000.

LASCAR, in the East Indies, signifies properly a camp-follower, but is generally applied to native sailors on board of British ships. The Lascars make good seamen, but being of an excessively irritable and revengeful nature, are generally kept in the minority in a ship's crew.

LASCARIS, CONSTANTINE, a celebrated Greek refugee, after the capture of Constantinople by the Turks, and one of the first founders of Greek studies in the West. He was received with distinction by Francesco Sforza, Duke of Milan, in 1454,

who intrusted to him the education of his daughter Hippolyta; but a more important scene of his labours was Rome, where he settled in the train of the learned Greek cardinal, Bessarion, and, finally, Naples and Messina, where he taught rhetoric and Greek letters until his death in 1493. His Greek grammar, entitled *Erotemata*, and dated 1476, is the earliest printed Greek book. To him his contemporaries were also indebted for several other elementary Greek books of less note. His grammar is known chiefly through a Latin translation printed at the Aldine press, and frequently reprinted. His library, which is very valuable, is now in the Ecucial.—**JOHN JANUS L.**, a member of the same family, surnamed **RHYNDACENUS**, has also acquired a place in the history of the revival of letters. He was one of those whom Lorenzo de' Medici employed in the collection of ancient, and especially Greek classical authors, of whom L. brought home a valuable collection from Mount Athos. On the death of Lorenzo, L. went to Paris, where he taught Greek under Charles VIII. and Louis XII.; but he eventually settled in Rome, where he was appointed by Leo X. to the superintendence of the Greek press which that pontiff established. L. edited several of the *editiones principes* at the Roman press. He was employed as ambassador at the court of Francis I., and afterwards at Venice, and died in Rome, at a very great age, in 1535. See Villemain's *Lascaris, ou les Grecs du 15^{me} Siècle* (Paris, 1825).

LAS CASAS, BARTOLOMÉ DE, Bishop of Chiapa, in Mexico, surnamed the *Apostle of the Indians*, a celebrated evangelist and philanthropist, was of French descent, and was born in Seville in 1474. He studied at Salamanca. In 1502, he accompanied Don Nicolas Ovando, who was sent out as governor, to St Domingo. Eight years after his arrival there, he was ordained to the priesthood, and was subsequently appointed to a charge in Cuba. Here he began to signalise himself by his exertions in favour of the oppressed Indians. To oppose the law which divided them amongst the conquerors, he went to Spain, where he prevailed on Cardinal Ximenes to send a commission of inquiry to the West Indies; but the proceedings of the commission by no means satisfying his zeal, he revisited Spain, to procure the adoption of stronger measures for the protection of the natives. Finally, to prevent the entire extirpation of the native race by the toils to which they were subjected, he proposed that the colonists should be compelled to employ negro slaves in the more severe labours of the mines and sugar-plantations; and the proposal was adopted. Las C. has on this account been represented as the author of the slave-trade, although it has been proved to have existed long before this proposal was made. Las C. afterwards attempted to carry out Castilian peasants as colonists to the West Indies, with the view of giving more complete effect to his schemes on behalf of the Indians; but failing in this, he retired to a Dominican convent in Hispaniola. He again visited Spain in 1539, out of benevolent regard to the native inhabitants of the West Indies, and published his *Brevissima Relacion de la Destruccion de las Indias*, which was soon translated into the other languages of Europe. The rich bishopric of Cuzco was offered to him, but he preferred the poor one of Chiapa, in a wild and almost unexplored region. The colonists received him with no friendly feelings, and as he went the length of refusing the sacraments to those who disregarded the new laws in favour of the Indians, he drew upon himself not only the resentment of the planters, but the disapprobation of the church, so that he was compelled

to return to Spain, where he ended his life in a convent in Madrid, July 1566, at the age of 92. In the course of his ardent career, he crossed the Atlantic sixteen times. A collection of his works appeared in his lifetime (Seville, 1552), but his most important work was published after his death, the *Historia general de las Indias*.

LAS CASES, EMMANUEL AUGUSTE DIEUDONNÉ, COURT, the companion and historiographer of Napoleon in St Helena, said to be of the same family as the preceding, was born in 1766, in the château of Las Cases, near Revel, was a lieutenant in the navy before the Revolution, and then fled from France, served in the Prince of Condé's army, spent some time in England, where he supported himself by private teaching, and took part in the expedition to Quiberon. After Napoleon's accession, he returned to France, and laboured in the preparation of his admirable *Atlas historique*, which was published under the name of Le Sage (Par. 1803—1804; last ed. Par. 1824—1828). This work attracted the attention of Napoleon, who made him a baron, and employed him in offices connected with the home-administration. After the battle of Waterloo, he offered to share the exile of Napoleon; and in St Helena, the ex-emperor dictated to him a part of his Memoirs. A letter which L. contrived to send to Lucien Bonaparte, led to his separation from Napoleon; and after eight months' confinement at the Cape of Good Hope, he was brought to Europe, and resided mostly in Belgium till Napoleon died, when he returned to France, and published the *Mémorial de Ste-Hélène* (8 vols. Par. 1823; amended edition, 1824, often reprinted), a work which must be always a chief source of information respecting Napoleon, but in which the author has taken too much liberty with his materials. After the revolution of 1830, he was for some time a member of the Chamber of Deputies, where his place was on the extreme Left. He died 15th May 1842.

LAS PALMAS, chief town of the Canary Islands (q. v.), is situated on the east coast of the island of Gran Canaria. It is a large, well-built town, is the seat of a bishop and of the supreme court for all the islands. Pop. 17,382.

LASSA. See H'LISSA.

LASSEN, CHRISTIAN, a most eminent orientalist, was born on 22d October 1800, at Bergen, in Norway; studied at Christiania, and afterwards (1822) at Heidelberg and Bonn, and assisted Schlegel in the publication of the *Râmâyana* and *Hûpadesa*. He also associated himself with Eugène Burnouf in the production of the *Essai sur le Pâli* (Par. 1826). In 1830, he became Extraordinary, and in 1840, Ordinary Professor of Ancient Indian Languages and Literature at Bonn. He has edited many Sanscrit works, deeply investigated the relations of the oriental languages and antiquities, and published several very important works, the chief of which are *Die altpersischen Keilinschriften* (Bonn, 1836); *Vollständige Zusammenstellung aller bis 1845 bekannt gemachten altpers. Keilinschr. mit Erklärung*, embodying Westergaard's investigations (Bonn, 1845); *Beiträge zur Geschichte der griech. und indo-scythischen Könige in Bactrien, Kabul und Indien* (Bonn, 1838); *Institutiones Linguae Pracriticae* (Bonn, 1837); *Gitagovinda Yayadevæ* (Bonn, 1837); *Anthologia Sanscritica* (Bonn, 1838); *Indische Alterthumskunde* (vols. 1—4, Bonn, 1847—1861); *Grammars of the Bahui and Belud Languages*; &c. He has contributed much to our knowledge of the cuneiform inscriptions, and of the ancient and modern Iranic dialects, on which and kindred subjects numerous articles from his pen are to be found

in the *Zeitschrift für Kunde des Morgenlandes*, the *Indische Bibliothek*, *Rheinische's Museum*, Ersch and Gruber's *Encyclopædia*, &c.

LA'SSO, a long stout cord or thong of akin, with a leaden ball at each end, employed by the South Americans in capturing wild horses, oxen, &c. It is thrown in such a manner, that when it strikes the neck or leg of the animal to be captured, the impetus of the ball causes the cord to coil round the limb. The hunter's horse is furnished with a saddle having a high pommel, so that the hunter may coil his end of the lasso round it, or even fix it, if he chooses, though this latter practice often leads to dangerous consequences. The lasso was frequently used against European soldiers during the contest of the South American republics for independence; and, though with very little success, by the barbarians in the Russian army against the French sentinels during the Crimean war. Similar in its name and application is another implement consisting of a stout, thong of hide with a slip-noose, used in many countries, but chiefly among the South American and Mexican hunters. It requires much greater address to use it successfully. In Mexico, the lasso is called a *loriat*.

LAST HEIR, in Scotch Law, means the sovereign, who takes the property of persons deceased who leave no legal heir. See INTTESTACY.

LAST TESTAMENT, or WILL, is the last instrument in point of date, and it revokes prior wills so far as inconsistent. See WILL.

LA'STAGE, in Maritime Language, denotes the ballast or lading of a vessel.

LATAKI'A (Turkish, *Ladakiyeh*; anc. *Laodicea*), a seaport of Syria, in the pashalic of Tripoli, and situated 75 miles north of the town of that name, and 60 miles south-west of Antioch, is surrounded by plantations of myrtle, pomegranate, mulberry, and olive trees. It consists of the decaying Upper Town and the Lower Town, which are separated by magnificent gardens. On the hills in the vicinity, a mild and finely-flavoured tobacco is grown, and is extensively exported. Pop. from 7000 to 10,000. L. occupies the site of the ancient *Laodicea ad Mare*, which was founded by Seleucus Nicator, and named after his mother, and which formed the port of Antioch. The ruins of the aqueduct built here by Herod the Great are still extant.

LATEEN-SAIL, a large triangular sail, common



Lateen-Sail.

in the Mediterranean. The upper edge is fastened to the lateen-yard, a spar of considerable length, which is held at about an angle of 45° with the

deck, by means of a mast crossing it at a third or a fourth of the way up.

LATENT FAULT. In the contract of sale, it is a rule that the buyer takes the risk of all latent faults or defects in the thing sold which were unknown to the seller at the time of the sale, all that the seller answers for being, that the thing is, so far as he knows, what it appears to be. This, which was the English rule, was extended to Scotland by the statute 19 and 20 Vict. c. 60, s. 5.

LATENT HEAT. See **HEAT.**

LATERAN, CHURCH OF ST JOHN, the first in dignity of the Roman churches, and styled in Roman usage 'the Mother and Head of all the churches of the city and the world,' is so called from its occupying the site of the splendid palace of Plantius Lateranus, which having been escheated (66 A.D.), in consequence of Lateranus being implicated in the conspiracy of the Pisos, became imperial property, and was assigned for Christian uses by the Emperor Constantine. It was originally dedicated to the Saviour; but Lucius II., who rebuilt it in the middle of the 12th c., dedicated it to St John the Baptist. The solemn entrance of the newly elected pope into office is inaugurated by his coming in procession to take possession of this church; and over its portico is the balcony from which, on certain festivals, as from St Peter's upon other days, he blesses the entire world. The original church is said to have been an adaptation to religious uses of the Basilica which was presented to Sylvester by Constantine, but has been several times rebuilt and modified, its final completion dating from the pontificate of Clement XII. It has been the scene of five councils, regarded as ecumenical by the Roman Church. See **COUNCIL**. The palace was the habitual residence of the popes until after the return from Avignon, when they removed to the Vatican. It is now occupied partly by officials of the chapter, partly for public purposes. The present pope, Pius IX., has converted a portion of it into a museum of Christian archæology. In the piazza of St John Lateran stands the celebrated relic called the 'Scala Santa,' or 'Holy Staircase,' which is reputed to be the stairs of Pilate's house at Jerusalem, made holy by the feet of our Lord as he passed to judgment.

LATERITE, a mineral substance, the product of the disintegration and partial decomposition of gneiss. It forms a bright red earth; which, where it abounds, as in some parts of Ceylon, being blown about as a fine dust, imparts its hue to every neglected article, and to the dresses of the inhabitants. The redness of the streets and roads attracts the notice of every stranger at Galle and Colombo. L., however, is not always red. Its redness is supposed to be owing to the presence of iron in considerable quantity. When felspar preponderates in the gneiss, it is whitish; when hornblende preponderates, it is yellow.

LATÈS (*Lates Niloticus*), a fish of the perch family, one of the most delicate and best-flavoured fishes of the Nile. It grows to a large size, sometimes 3 feet long. It is mentioned by several ancient authors. In form it resembles a perch, and the genus is very nearly allied.—Another species of this genus is the **VACRI** (*Lates nobilis*), called *Cock-up* by the English in Calcutta, one of the most esteemed fishes of the Ganges, which it ascends as far as the tide does.

LATEX, in Botany, the sap of plants after it has been elaborated in the leaves. It returns from the leaves to the bark by vessels called *laticiferous vessels*, which branch, unite, and anastomose very

variously. They are not always of uniform thickness, but present many distentions, often almost as if articulated. Peculiar currents are observed in the *Lates*, which were first pointed out by Schultz, who has bestowed great attention on this subject, and on the branches of physiology connected with it. The L. differs very much in different plants, in colour and other qualities, but in all it is full of granules.

LATHAM, ROBERT GORDON, an eminent English philologist and ethnologist, was born in 1812, at Billingborough, Lincolnshire. He was educated at Cambridge, and took the degree of M.D., but having made a tour in Denmark and Norway, he was led to direct his attention particularly to the Scandinavian languages. For several years he was professor of the English Language and Literature in University College, London. As a physician, he has held important appointments. His well-known work, *English Language*, was published in 1841, and has gone through numerous editions. The *Natural History of the Varieties of Mankind* (Lond. 1850) is a valuable contribution to ethnology. Among his other works may be mentioned his edition of Tacitus's *Germania*, with philological and historical notes (1850); *Ethnology of the British Colonies; Man and his Migrations* (Lond. 1851); *Descriptive Ethnology* (2 vols. Lond. 1859); and *The Nationalities of Europe* (Lond. 1863). He is a F.R.S.L., and member of many learned societies in Europe and America.

LATHE. See **TURNING.**

LATHS AND LATHWOOD. Laths are small strips of wood of various lengths, rarely more than 4 feet; they are made either by splitting lathwood, which is the Norway spruce fir (*Pinus abies*), or else they are sawn from Canada deal. The sawn laths are a modern introduction, due to the development of steam saw-mills in Canada, which thus use up the small portions of the lumber. Laths are used for nailing to the uprights of partition-walls, and to the rafters of ceilings in our buildings; they are placed slightly apart to receive the plaster, which, by being pressed into the intervals between the laths, is retained, and when dry, is held securely on the wall. Slaters' laths are longer strips of wood, nailed on to the framework of the roof, for the purpose of sustaining the slates, which are fastened to the laths by nails.

LATHYRUS, a genus of plants of the natural order *Leguminosæ*, sub-order *Papilionaceæ*. The leaves are furnished with tendrils, and are pinnate, but often only with one pair of leaflets. The species are numerous, annual and perennial herbaceous plants, natives of temperate countries in the northern hemisphere. Few of them are American. A number are natives of Britain. Some have very beautiful flowers of considerable size, on account of which they find a place in flower-gardens, as *L. latifolius* and *L. sylvestris*, the latter a native of England, and the former of the south of Europe, both perennials, and known by the name of **EVER-LASTING PEA**. The **SWEET PEA** (*L. odoratus*), a native of the East, is one of the best known ornaments of our flower-gardens, a hardy annual, esteemed not only on account of the beauty of its flowers, but of their delightful fragrance. Many varieties are in cultivation, differing in colour, &c. The most common British species is the **MEADOW VETCHLING** (*L. pratensis*), with bright yellow flowers. *L. sativus*, the **CHICKLING VETCH**, or **LENTIL OF SPAIN**, a native of the south of Europe, with flowers generally of a bright blue colour and winged pods, is cultivated in India and in Germany, France, and other countries for its seeds, the flour of which, however, is mixed with other flour rather than used

alone, on account of narcotic qualities which it possesses, and which caused its cultivation for food to be interdicted in Würtemberg in 1671. An incurable paralysis of the limbs has sometimes been produced by it, both in human beings and lower animals. The seeds of *L. cicera*, although sometimes used by the country people of France, are even more dangerous. Those of *L. Aphaca*, a species



Everlasting Pea (*L. tuberosus*):
a, creeping root, with tubers; b, pod, with calyx.

sometimes found on gravelly soils in England, possess similar qualities when ripe, but in an unripe state are eaten with the pods which contain them, and are quite wholesome. *L. tuberosus*, a native of Germany and other parts of Europe, but not of Britain, is cultivated on the continent for its amyloseous tubers. The tubers are sometimes called *Dutch Mice*; in Germany, they are known as *Earth-nuts*. The herbage of the plant is relished by cattle.

LATIMER, HUGH, one of the most distinguished of the English reformers, was born at Thurcaston, in Leicestershire, in the year 1490 or 1491. He was educated at Cambridge, and after a brief period of zealous devotion to the papacy ('I was as obstinate a papist,' he says, 'as any in England'), he became attached to the new learning and divinity which had begun to establish themselves there. He very soon became a zealous preacher of the reformed doctrines. The consequence of this new-born zeal was, that many of the adherents of the old faith were strongly excited against him, and he was embroiled in many controversies.

The dispute about Henry VIII's marriage with Catharine of Aragon brought L. more into notice. He was one of the divines appointed by the university of Cambridge to examine as to its lawfulness, and he declared on the king's side. This secured Henry's favour, and he was appointed one of his chaplains, and received a living in Wiltshire. In 1535, he was appointed Bishop of Worcester; and at the opening of convocation on the 9th of June 1536, he preached two very powerful and impressive sermons, urging the necessity of reform. After a while, the work of reform rather retrograded than advanced, and L. found himself with his bold opinions in little favour at court. He retired to his diocese, and laboured there in a continual round of 'teaching, preaching, exhorting,

writing, correcting, and reforming, either as his ability would serve, or the time would bear.' This was his true function. He was an eminently practical reformer. During the close of Henry's reign, and when the reactionary party, headed by Gardiner and Bonner, were in the ascendant, L. lived in great privacy. He was looked upon with jealousy, and closely watched, and finally, on coming up to London for medical advice, he was brought before the Privy Council, and cast into the Tower.

On the accession of Edward VI., he again appeared in public. He declined, however, to resume his episcopal functions, although his old bishopric was offered to him at the instance of the House of Commons. He devoted himself to preaching and practical works of benevolence. The pulpit was his great power, and by his stirring and homely sermons, he did much to rouse a spirit of religious earnestness throughout the country. At length, with the lamented death of Edward, he and other reformers were arrested in their career of activity. L. was put in prison, and examined at Oxford in 1554. After his examination, he was transferred to the common jail there, where he lay for more than a year, feeble, sickly, and worn out with his hardships. Death would not have long spared the old man, but his enemies would not wait for the natural termination of his life. In September 1555, he was summoned before certain commissioners, appointed to sit in judgment upon him and Ridley; and after an ignominious trial, he was condemned to be burned. He suffered along with Ridley 'without Bocardo Gate, opposite Balliol College, on the 16th of October 1555, exclaiming to his companion: 'Be of good comfort, Master Ridley, and play the man: we shall this day light such a candle, by God's grace, in England, as I trust shall never be put out.'

L.'s character presents a combination of many noble and disinterested qualities. He was brave, honest, devoted, and energetic, homely and popular, yet free from all violence; a martyr and hero, yet a plain, simple-hearted, and unpretending man. Humour and cheerfulness, manly sense and direct evangelical fervour, distinguish his sermons and his life, and make them alike interesting and admirable.

L.'s sermons were reprinted at London, in 2 vols., 1825. The latest edition is that by the Rev. G. E. Corrie, in 4 vols., 1845. Compare Tulloch's *Leaders of the Reformation* (1859).

LATIN CROSS, a cross with the lower limb considerably longer than the other three.

LATIN EMPIRE, the name given to that portion of the Byzantine empire which was seized in 1204 by the Crusaders, who made Constantinople their capital. It was overthrown by the Greeks in 1261. See **BYZANTINE EMPIRE**.

LATIN LANGUAGE AND LITERATURE.

—*Language*.—The Latin language is a member of the great family commonly called Indo-Germanic, Indo-European, or Aryan. It is therefore closely allied to the Greek, Persian, German, Celtic, English, and many other tongues and dialects of Europe, and to all these its kindred is more or less clearly shewn by identity of stems and similarity of structure. It was primarily developed among the people who inhabited that part of Western Italy which lies between the rivers Tiber and Liris; and though the city of Rome stamped her name on the political institutions of the empire, yet the standard tongue of Italy still continued to be called the *Latin* language, not the Roman. As the Roman conquests extended, Latin spread with equal strides over the conquered countries, and was generally used by the educated classes in the greater part of Italy, in France, Spain, Portugal, Germany, and other Roman

provinces. But even in Italy itself, and in Latium, there seem to have been two forms of the language, differing very considerably from each other—a polished dialect and a rustic one—a language of books and of the higher classes, and a language of conversation and everyday life among the vulgar. It was in the last years of the Republic and the first of the Empire that the polished language reached its highest point of perfection in the writings of Cicero, Horace, Virgil, and others. But by the influx of strangers, by the gradual decline of Roman feelings and Roman spirit, and by the intermixture of the classic forms with the dialects of the provinces, it became corrupted, the process of deterioration going on with double rapidity after the dismemberment of the Roman Empire in the 5th century. Thus were formed the modern French, Spanish, Italian, and Portuguese. The English language also owes much to Latin, both directly by derivation from the classical forms, and at second-hand through the Norman-French. Latin continued to be the diplomatic language of Europe till a comparatively recent period. It is still the medium of communication among the learned of the world, and is now, as it has always been, the official language of the Roman Catholic Church.—For a discussion as to the origin and sources of the Latin language, see Donaldson's *Varronianus*.

The grammar of the Latin language has been studied and illustrated by many celebrated scholars from Varro (116—28 B. C.) down to Zumpt, Grotefend, Kuhn, and Madvig, through a long list of names, such as Donatus, Priscian, Laurentius Valla, Manutius, Melancthon, Scaliger, Perizonius, Schneider, Linacre, Ruddiman, Alvarez, and many more. In lexicography, Perotti, Stephanus, Faber, Gesner, Forcellini, Scheller, Freund, Georges, and others of less note, have done valuable service.

Literature.—The Roman Republic had well-nigh run its course ere it possessed a writer or a literature worthy of the name. A kind of rude poetry was cultivated from the earliest times, and was employed in such compositions as the Hymn of the Fratres Arvales (dug up at Rome in 1778, and in the first burst of enthusiasm excited by its discovery, assigned to the age of Romulus), in the sacred songs to particular deities, and in triumphal poems and ballads, in the Fescennine Carols, and other rude attempts to amuse or dupe an illiterate and vulgar populace. And even when, in later years, the Romans did begin to foster a literary taste, the rage for Greek models hindered every effort at original thought. It was considered highly meritorious to imitate or translate a Greek writer; while, on the other hand, it was deemed dishonourable to follow a Latin author. Such was the feeling even in the days of Horace and Virgil, both of whom are largely indebted to their Greek models. The first period of Roman literature may be said to extend from 240 B. C. to the death of Sulla (78 B. C.); the second, or Golden Age, from the death of Sulla to the death of the Emperor Augustus (14 A. D.); the third, or Silver Age, from the death of Augustus to the death of Adrian (138 A. D.); and the fourth from the death of Adrian to the overthrow of the Western Empire in 476 A. D. In the first period, the most distinguished names are those of Livius Andronicus, a writer of dramas adapted from the Greek, whose first play was brought out in 240 B. C.; Ennius, whose chief work was an epic poem on the History of Rome, and who also wrote dramas and satires; with Nævius, Plautus, and Terence, the comedians. The second period is adorned by Varro, who wrote on agriculture, grammar, antiquities, &c.; by Lucretius, a writer of the didactic epic; by Virgil, who, to his great epic, the *Æneid*, added pastoral and agricul-

tural poetry in the *Eclogues* and *Georgics*; by Horace, in lyric verse and in satire; by Catullus, in lyric; by Tibullus and Propertius, in elegy; by Livy, Cæsar, Sallust, and Nepos, in history and biography; by Cicero, in philosophy, rhetoric, and oratory; and by Ovid, in elegiac and didactic poetry. The third period boasts of Tacitus, the historian and biographer; of the elder Pliny, the naturalist; of Persius and Juvenal, the satirists; of Martial, the epigrammatist; of Columella and Lucan, the didactic and epic poets; of Statius, Silius Italicus, and the younger Pliny, with many others of lesser note. The fourth period produced few men of name; but among those who are best known may be mentioned the Emperor M. Aurelius, Ammianus Marcellinus, Gellius, Justin, Appuleius, Lactantius, Eutropius, Macrobius, Calpurnius, Boëthius, Paulinus, and Claudianus, the last of the Roman classic poets.

The spread of Christianity gave rise to the ecclesiastical poetry of the middle ages, which departed from the classic models, and struck out for itself a new type. It disregarded the restrictions of quantity and metre, and substituted accent and rhyme as the regulating principles of its form. The most famous name in the earlier period is that of Prudentius—to whom we may add Sedulius, St Hilary, St Ambrose, and St Gregory the Great; and in the later period, Fortunatus; the Emperor Charlemagne, author of *Veni Creator*; Bede (the Venerable); Bernard de Morley; Adam of St Victor; Thomas of Celano, author of the famous *Dies Ire*; James de Benedictis, author of the equally famous *Stabat Mater*; and St Thomas Aquinas.—See Bernhardt's *Roman Literature*, and Trench's *Sacred Latin Poetry*.

LATINI, an Italian people, who in pre-historic times had established themselves on the lower part of the Tiber and the Anio, between the sea and the nearest Apennines. The limits of their territory (**LATIUM**) cannot, however, be fixed with precision. The L. had the Volsci for neighbours on the south, the *Æqui* and *Hernici* on the east, and the *Sabines* on the north; but after the subjugation of these tribes by the Romans, the name of Latium was given to the whole of the conquered districts. The original and strictly ethnological Latium is called by Pliny, *Latium Antiquum*, and the newer and added portions, *Latium Adjectum*. The legend which forms the subject of the *Æneid*, the great national epic of the Romans, and which describes the introduction of a third or *Trojan* element in the persons of *Æneas* and his companions, possesses no historical value. The principal towns of the Latins were Laurentum, Lavinium, Alba Longa (q. v.), from which, according to the legend, went forth the founders of Rome, Ostia, Antium, Tusculum, Præneste, and Tibur.

LATITAT, an old form of writ in England, which commenced an action in the Court of Queen's Bench; now obsolete.

LATITUDE AND **LONGITUDE**, in Geography, denote the angular distances of a place on the earth from the equator and first meridian respectively; the angular distance in longitude being found by supposing a plane to pass through the place, the earth's centre, and the poles, and measuring the angle made by this plane with the plane of the first meridian; the angular distance in latitude being found in the same manner, but substituting the two extremities of an equatorial diameter for the poles; or, more simply, latitude is the angle made by two lines drawn from the earth's centre—the one to the place, the other to the equator at the point where it is crossed by the meridian of the place. Latitude

is reckoned from the equator to the poles, a place on the equator having lat. 0°, and the poles 90° N. and 90° S. respectively. Longitude is reckoned along the equator from the first meridian; but as nature has not, as in the case of latitude, supplied us with a fixed starting-point, each nation has chosen its own first meridian; thus, in Great Britain and her colonies, in Holland, and other maritime states, longitude is reckoned from the meridian which passes through Greenwich; in France, from that through Paris, &c.; and in many old charts, from Ferro (one of the Canary Isles), or from the Madeira Isles. It is reckoned east and west from 0° to 180°, though astronomers reckon from 0° W. to 360° W., and never use east longitude. It will easily be seen that if the latitude and longitude of a place be given, its exact position can be determined, for the latitude fixes its position to a circle passing round the earth at a uniform fixed distance from the equator (called a parallel of latitude), and the longitude shews what point of this circle is to be intersected by the meridian of the place, the place being at the intersection.

The determination both of latitude and longitude depends upon astronomical observation. The principle on which the more usual methods of finding the latitude depend, will be understood from the following considerations: To an observer at the earth's equator, the celestial poles are in the horizon, and the meridian point of the equator is in the zenith. If now he travel northwards over one degree of the meridian, the north celestial pole will appear one degree above the horizon, while the meridian point of the equator will decline one degree southwards; and so on, until, when he reached the terrestrial pole, the pole of the heavens would be in the zenith, and the equator in the horizon. The same thing is true with regard to the southern hemisphere. It thus appears that to determine the latitude of a place we have only to find the altitude of the pole, or the zenith distance of the meridian point of the equator (which is the same thing as the complement of its altitude). The altitude of the pole is found most directly by observing the greatest and least altitudes of the polar star (see POLES), or of any circumpolar star, and (correction being made for refraction) taking half the sum. Similarly, half the sum of the greatest and least meridian altitudes of the sun, at the two solstices, corrected for refraction and parallax, gives the altitude of the meridian point of the equator. The method most usual with navigators and travellers is to observe the meridian altitude of a star whose declination or distance from the equator is known; or of the sun, whose declination at the time may be found from the *Nautical Almanac*; the sum or difference (according to the direction of the declination) of the altitude and declination gives the meridian altitude of the equator, which is the co-latitude. Other methods of finding the latitude require more or less trigonometrical calculation.

The determination of the longitude is by no means so readily accomplished. Various methods have at different times been proposed, most of which are only fitted for observatories. Among these may be classed those which depend upon the determination of the local time of the occurrence of certain celestial phenomena, such as the eclipses of the sun, moon, or Jupiter's satellites, occultations of fixed stars by the moon, the time occupied in the moon's transit over the meridian, &c.; and comparing the observed local time with the calculated time of the occurrence, at some station whose longitude is known (e. g., Greenwich), the difference of time when reduced to degrees, minutes, and seconds, at

the rate of 360° to 24 hours, gives the difference of longitude. The two methods in use among travellers and on board ship are remarkable for their combination of simplicity with accuracy. The first consists merely in determining at what hour on the chronometer (which is set to the time at Greenwich, or some place of known longitude) the sun crosses the meridian. It is evident that as the sun completes a revolution, or 360°, in 24 hours, he will move over 15° in 1 hour, or 1° in 4 minutes. Now, if the watch be set to Greenwich time—viz., point to 12 o'clock when the sun is on the meridian of Greenwich, and if at some other place, when the sun is on the meridian there, the watch points to 3 hours 52 minutes, the difference of longitude is 58°, and the longitude will be W., as the sun has arrived over the place later than at Greenwich; similarly, if the sun be over the meridian of a place at 9 hours 40 minutes A.M., the longitude is 35° E. (by the chronometer). The accuracy of this method depends evidently upon the correctness of time-keepers (see WATCHES). The other method—that of 'lunar distances'—may be briefly explained as follows: The distance of the moon from certain fixed stars is calculated with great accuracy (about three years in advance) for every three hours of Greenwich time, and published in the *Nautical Almanac*. The moon's distance from some one star having been observed, and corrected for refraction and parallax, and the local time having also been noted, the difference between this local time and that time in the table which corresponds to the same distance gives the longitude, which may be converted into degrees as before. It may also be mentioned, that the longitude of all places connected by telegraph with the reckoning-point can be easily found by transmitting from the latter a signal to an observer in the place, at a certain fixed time (reckoned in solar time at the reckoning-point); and by the observer instantly and accurately noting the local time at which the signal arrived; the difference of the two times, reduced in the way shewn above, will give the longitude, the time occupied in the transmission of the signal being so small as to be neglected. When applied to a heavenly body, the terms latitude and longitude have the same relations to the ecliptic and its poles, and to the point on the ecliptic called the Equinox (q. v.), that terrestrial latitude and longitude have to the equator and a first meridian. The positions of a heavenly body relatively to the equator are called its Declination (q. v.) and Right Ascension (q. v.).

L'ATOUR D'AUVERGNE, THÉOPHILE MALO CORRET DE, born 23d November 1743, at Carhaix in Finistère, France, of an illegitimate branch of the family of the Dukes of Bouillon. He entered the army in 1767; and in 1781 served under the Duke de Crillon at Port Mahon. On the outbreak of the Revolution, he attached himself to the national cause. The army of the Alps, which operated against the Sardinians in 1792, contained no braver officer than Latour. He was the first to enter Chambery, sword in hand, at the head of his company. But he would not hear of advancement in military rank; and in the following year, though placed at the head of a column of 8000 grenadiers in the army of the Pyrenees, he continued to wear the uniform of a captain. His corps obtained the name of the 'infernal column,' on account of the dread which its bayonet-charges inspired. When he was subsequently with the army of the Rhine in 1800, as he still refused all promotion, Bonaparte bestowed on him the title of 'The First Grenadier of France.' He was killed, on 27th June of that year, at Oberhausen, near Neuburg in Bavaria. The heroism and magnanimity of L. were wonderful;

and French biographies are full of instances of his daring valour, his Spartan simplicity of life, and his chivalrous affection for his friends. When he died, the whole French army mourned for him three days; every soldier set aside a day's pay to purchase a silver urn to hold his heart; his sabre was placed in the church of the Invalides; and each morning, till the close of the Empire, at the muster-roll of his regiment, his name continued to be called, and the oldest sergeant answered to the call: '*Mort au champ d'honneur*' (Dead on the field of honour). L. was not only a brave warrior, but also a man of a studious disposition, and the author of two works, *Nouvelles Recherches sur la Langue l'Origine et les Antiquités des Bretons* (Bayonne, 1792), and *Origines Gauloises* (Hamb. 1801), which is, however, only a third edition of the former.

LA TRAPPE, a narrow valley in Normandy, in the department of Orne, closely shut in by woods and rocks, and very difficult of access. It is notable as the place in which the Trappists (q. v.) originated.

LA'TRINES, conveniences for soldiers in camps and barracks. Much attention has of late been devoted to their construction, a large percentage of the army sickness having been traced to their defective and impure condition.

LA'TTEN, a term now seldom used. It is applied to sheet-brass, and previous to the reforms in the Customs tariff, the name was regularly recognised. There are three varieties of latten known—*black*, *shaven*, and *roll*. The first is rolled brass about the thickness of ordinary pasteboard, and unpolished; the second as thin as writing-paper; and the third is either of the other kinds polished on both sides. The term latten is of some archaeological interest, as it is not known what is meant by the 'mines of latten' mentioned in the time of Henry VIII., and frequent mention is made of this metal in various public records, without explanation of its nature.

LA'TTICE-BRIDGE, so called from having the sides constructed with cross-framing resembling lattice-work (Fr. and Ger. *lattice*, a lath). See **FRAME-BRIDGE**. Many very large bridges of this kind have been erected with timber-framing in America. That over the Susquehanna at Columbia is about one mile and a quarter long, and has twenty-nine spans, each 200 feet wide. The principle on which many lattice-bridges are constructed resembles that of the trussed rafters of roofs (A, B, C, fig. 1), with

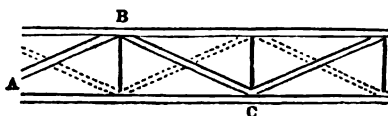

Fig. 1.

a king-post or hanger in centre. Each span consists of a series of these rafters, so arranged that the head of one rafter (B) is immediately over the feet of the two adjoining rafters. Other lattice-bridges are constructed with diagonal braces, united with strong pins, and without suspension-rods. The former method is the stronger, as in the latter the strain comes chiefly on the pins uniting the diagonal cross-braces. Lattice-bridges are also constructed in iron, and have been much used for railway purposes. The first application of the lattice principle to iron was made by Mr George Smart, who registered, in 1824, his 'patent iron bridge.' Many modifications of the same principle have been adopted—the horizontal ties at top and bottom being always of wrought iron, and the dia-

gonals either simple wrought-iron bars, or hollow malleable iron tubes, or of cast iron. The wrought-iron tubular bow-bridge, now in very common use in

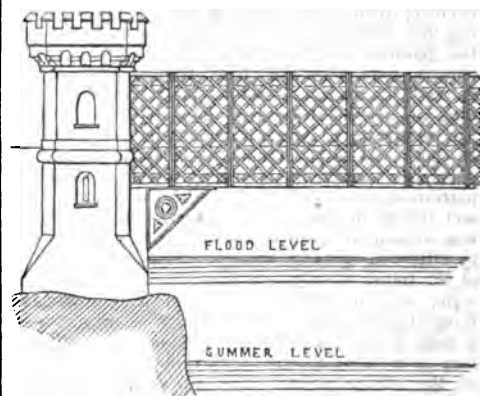
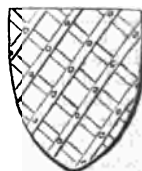

Fig. 2.

railway construction, is a combination of the tubular and the lattice principle. See **TUBULAR BRIDGES**. Fig. 2 shows a portion of the lattice bridge over the Ouse at Lendal Ferry, York, as designed by Mr Dredge, C.E. The bridge has a clear span of 175 feet 6 inches.

LATTICE LEAF, **LACE LEAF**, **WATER YAM**, or **OUVIRANDRANO** (*Ouvirandra fenestratis*), a plant referred by some botanists to the natural order *Juncaginæ*, and by some to *Naiadaceæ*. It is a native of Madagascar, and grows in running streams. It has a root-stock about the thickness of a man's thumb, six to nine inches long, often branching, internally white, with a light-brown skin, farinaceous, and used for food. The crown of the root is under water, and the leaves float just under the surface; the flower-stalks rise above it. The flowers are in forked spikes. The leaves are very curious; the blade resembling lattice-work or open needle-work of a most regular pattern; the longitudinal ribs being crossed at right angles by fine tendrils, and the intervening spaces being open. The blade is of an elongated oval form, abruptly acuminate; the length of the stalk varies according to the depth of the water. The whole appearance of the plant is very beautiful. It grows well in hothouse aquaria in Britain.



Latticed.

LA'TTICED, or **TREILLÉ**, in Heraldry, is a term applied to a shield covered with a decoration resembling Fretty (q. v.), but differing in this respect, that the pieces do not cross over and under each other: those directed from dexter chief to sinister base are placed uppermost and *cloué*, that is, have nails inserted at the joints.

LAU'BAN, a town of Prussia, in the province of Silesia, is situated in a charming valley on the Queis, 40 miles west-south-west of Liegnitz. Pop. 6582, who are engaged chiefly in woollen, linen, and cotton weaving, bleaching, printing, dyeing, and bell-founding.

LAUD, WILLIAM, Archbishop of Canterbury, was the son of a clothier in good circumstances, and was born at Reading, in Berkshire, October 7, 1573. He entered St John's College, Oxford, in 1589, became a Fellow in 1593, and took his degree of M.A. in 1598. Ordained a priest in 1601, he soon

made himself conspicuous at the university by his antipathy to Puritanism; but being then a person of very little consequence, he only succeeded in exciting displeasure against himself. Yet his learning, his persistent and definite ecclesiasticism, and the genuine unselfishness of his devotion to the church, soon won him both friends and patrons. In 1607, he was preferred to the vicarage of Stanford in Northamptonshire, and in 1608 obtained the advowson of North Kilworth in Leicestershire. In both of these livings he shewed himself an exemplary clergyman according to the High-church pattern—zealous in repairing the parsonage-houses, and liberal in maintaining the poor. In 1609, he was appointed Rector of West Tilbury, in Essex; in 1611—in spite of strong opposition—President of St John's College; in 1614, Prebendary of Lincoln; and in 1615, Archdeacon of Huntingdon. King James now began to recognise what sort of a man L. was, and to see that he might rely on him as a valuable ally in carrying out his notions of the 'divine right.' Not that their aims were quite identical—James was chiefly anxious to maintain the absolute authority of the sovereign, and L. the absolute authority of episcopacy. In 1617, L. accompanied his majesty to Scotland, with the view of introducing episcopacy into the church-government of that country; but the attempt failed. In 1621, he was consecrated Bishop of St Davids. After the accession of Charles I., he was translated from the see of St Davids to that of Bath and Wells, became high in favour at court, was more than ever hated by the Puritans, and was denounced in parliament. In 1628, he was made Bishop of London. After the assassination of Buckingham (q. v.), L. became virtually the chief minister of Charles, and acted in a manner so utterly opposed to the spirit of the times and to the opinions of the great body of Puritans in England, that one might have foreseen his ruin to be inevitable, in spite of the royal favour. In 1630, he was chosen chancellor of the university of Oxford, the centre of High-church loyalty. From this period he was for several years busily but fruitlessly employed in repressing Puritanism. The means adopted were not only unchristian, but even detestable. Cropping the ears, slitting the nose, branding the forehead, fines, imprisonments, are not at any time satisfactory methods of defending a religious system, but in the then temper of the English nation they were in the last degree weak and foolish. In the High-commission and Star-chamber Courts, the influence of L. was supreme; but the penalty he paid for this influence was the hatred of the English parliament and of the people generally. In 1633, he was raised to the archbishopric of Canterbury, and in the same year made chancellor of the university of Dublin. The famous ordinance regarding Sunday sports, which was published about this time by royal command, was believed to be drawn up by L., and greatly increased the dislike felt towards him by the Puritans. His minute alterations in public worship, his regulations about the proper position of the altar and the fencing of it with decent rails, his forcing Dutch and Walloon congregations to use the English Liturgy, and all Englishmen to attend the parish churches where they resided, display a petty intellect and an intolerant spirit; as other of his actions indicate that there lurked in his small obstinate nature no inconsiderable amount of cruelty and malice. Still, it must be confessed that in the long-run, L.'s ritualism has triumphed. The Church of England was gradually penetrated with his spirit, and the high value which she has come to put on religious ceremonies is partly owing to the pertinacious efforts of the archbishop. This

influence, in short, has hindered her from becoming as doctrinal and *Calvinistic* as her articles would logically necessitate. During 1635—1637, another effort was made by him to establish episcopacy in Scotland; but the first attempt to read the liturgy in St Giles's Church, Edinburgh, excited a dangerous tumult. Proceedings were finally taken against him, and on the 1st of March 1640—1641, he was, by order of the House of Commons, conveyed to the Tower. After being stripped of his honours, and exposed to many indignities and much injustice, he was finally brought to trial before the House of Lords, November 13, 1643, on a charge of treason and other crimes. The Lords, however, did not find him guilty; but the Commons had previously resolved on his death, and passed an ordinance for his execution. To this the Upper House gave its assent; and in spite of L.'s producing a royal pardon, he was—undoubtedly in violation of express statute, and by the exercise of a prerogative of parliament as arbitrary as any king had ever exhibited—beheaded, 10th January 1644—1645. L. had a genuine regard for learning—at least ecclesiastical learning—and enriched the university of Oxford, in the course of his life, with 1300 MSS. in different European and Oriental languages; but his exclusive sacerdotalism; his inability to understand his fellow-creatures, and his consequent disregard for their rights, forbid us to admire his character, though we pity his fate. His writings are few. Wharton published his *Diary* in 1694; and during 1857—1860, Parker, the Oxford publisher, issued *The Works of the Most Reverend Father in God, William Laud, D.D., sometime Lord Archbishop of Canterbury*, containing, among other things, his letters and miscellaneous papers, some of them not before published, and, like his *Diary*, of great value in helping us to form an adequate conception of the man and his time.

LAUDANUM, or TINCTURE OF OPIUM, is the most generally used of all the preparations of opium. It is obtained by macerating the sliced or powdered drug in spirit, and filtering. It is of a deep brownish-red colour, and possesses the peculiar odour and smell of opium. One of the greatest objections to it is, that it is liable to great variations of strength. Dr Christison remarks: 'Laudanum is made by all the colleges with such proportions of the opium and spirit that about thirteen minims and a half, or about twenty-five drops, contain the entire part of one grain of opium. But the London tincture may be sometimes sixteen per cent. stronger than the others, as dry opium is directed to be used.' This medicine is, moreover, very often adulterated.

Laudanum is a powerful anodyne and soporific, but is more liable to cause headache than the solution of one of the salts of morphia. Its general action and its uses will be described in the article OPIUM. The dose for an adult varies from ten minims to a drachm. To children (as is the case with all opiates), it must be given with extreme caution. One minim, which is equivalent to the 120th of a grain of morphia, has been known to prove fatal to an infant.

LAUDS. See CANONICAL HOURS.

LAU'ENBURG, or SAXE-LAUENBURG, a duchy belonging to the German confederacy, but united with the crown of Denmark. In the earlier half of the thirteenth century, it fell into the possession of the Duke of Saxony, one of whose sons became the founder of the ducal House of Saxe-Lauenburg. After the extinction of this line, it was inherited by the Duke of Brunswick-Celle in 1689, and passed into the possession of the

Hanoverian kings of Great Britain, was seized along with Hanover by the French in 1803, and afterwards, with some changes of boundary, was made over to Prussia, and by Prussia transferred to Denmark, but with reservation of all the rights and privileges of the country. It has an area of 400 square miles, and (in 1860) 50,147 inhabitants, lies on the right bank of the Elbe, and borders with Hanover, Mecklenburg, Holstein, and the territories of Hamburg and Lübeck, and is a well-cultivated and fertile country. It is closely connected in political affairs with Holstein. The capital, Lauenburg, has only about 1100 inhabitants: the two largest towns are Ratzeburg (pop. 3760), and Mülln (pop. 3322).

LAUGHING GAS. See NITROGEN.

LAUGHTER—THE LUDICROUS. This familiar and peculiarly human expression has been the occasion of a good deal of discussion and controversy, being connected with a large and important class of effects, named the ludicrous, and also with wit and humour. We shall first advert to the physical part of the phenomenon, and then consider the mental causes or accompaniments of it.

Physically, laughter is a convulsive action of the Diaphragm (q. v.). In this state, as remarked by Sir Charles Bell, the person 'draws a full breath, and throws it out in interrupted, short, and audible cackinnations.' This convulsion of the diaphragm is the principal part of the physical manifestations of laughter; but there are several accessories, especially the sharp vocal utterance arising from the violent tension of the larynx, and the expression of the features, this being a more intense form of the smile, the characteristic of pleasing emotions generally. In extreme cases, the eyes are moistened by the effusion from the lachrymal glands.

The causes of laughter are both *physical* and *mental*. Among physical causes, we must rank first hilarity, or animal spirits generally. When there is a great overflow of good spirits, it takes the form of the laugh among other violent manifestations. The rebound of robust natures from constraint or confinement, as when children are released from school, is marked with uproarious glee and excitement. Laughter is sometimes produced by the application of cold, as in the cold bath. Another notable form is the hysterical fit, where the explosiveness of the nervous system is an effect of disease, and followed by exhaustion.

The *mental* causes of laughter are what have given rise to the controversy. To determine the common characteristic of all those things termed 'ludicrous,' has been found a problem of no common difficulty. Various theories have been propounded, all with some truth, but perhaps none entirely explaining the facts. Aristotle lays it down that 'the ridiculous implies something deformed, and consists in those smaller faults which are neither painful nor pernicious, but unbecoming—thus, a face excites laughter wherein there is deformity and distortion without pain.' Here he touches upon several of the important conditions—viz., that there should be some strangeness or deviation from the ordinary appearances of nature, that this deviation should be on the side of degradation or inferiority, and that it should not be of a kind to excite any other strong emotion, as pity. Hobbes has given a theory to the effect that laughter is 'a sudden glory, arising from a sudden conception of some eminency in ourselves by comparison with the infirmity of others, or with our own formerly.' This evidently suits a certain number of cases, especially the laugh of ridicule, derision, and contempt. It would not be so easy to reconcile it with the humorous and genial laughter

of those that are but little given to self-glorification or proud exultation over other men's discomfiture. Partly owing to this deficiency, and partly from the harsh judgment of human nature implied in it, this theory has been very unpopular. It has been contended, in opposition to Hobbes, that there are jests that do not imply the degradation of any living being; and that we often feel contempt for others, and sudden glorying in ourselves by the comparison, without being urged to laughter. As to the first of these allegations, Campbell, in the *Philosophy of Rhetoric*, adduces the following instance: 'Many,' he says, 'have laughed at the queerness of the comparison in these lines (from *Hudibras*):

For rhyme the rudder is of verses,
With which, like ships, they steer their courses,

who never dreamed that there was any person or party, practice or opinion, derided in them.' But in addition to the agreeable surprise caused by the novelty of the comparison, which is the chief ingredient in wit, and may exist without any degradation of the subject, there is here a most apparent degradation of the poetic art, hallowed as it is in men's minds by the most dignified associations as something akin to divine inspiration, and now reduced to a vulgar mechanism of rhyme-making. Hobbes confines his definition too much to actual persons; for the laugh may be raised against classes, parties, systems, opinions, institutions, and even inanimate things supposed to be personified. It would not be easy to produce any unequivocal instance of a laugh raised without degrading some person or interest, while in a vast number of cases this circumstance is the indispensable and admitted condition of the effect.

Dr Campbell himself, while challenging the theory of Hobbes, substitutes nothing in its place except an enumeration of the most prominent kinds of ludicrous effects. These are, first, the debasement of things great and eminent; secondly, the aggrandisement of little things by the language of splendour; and thirdly, the queerness or singularity of the imagery. Now, as regards the first of these, the debasement of things eminently great—by far the largest class—the doctrine of Hobbes, if properly guarded, would be found fully applicable. There is a strong satisfaction in pulling anything down from a high pinnacle to plunge it in the mire, which we can interpret only as a mode of the sentiment of Power, one of the most energetic and deep-seated passions of the human mind. This sentiment is gratified by every striking effect that we can produce ourselves; and few effects are more striking than to debase or humiliate some person or interest from a proud eminence; and not only so, but (what Hobbes neglected to remark) also by seeing the effect produced by the agency of some other person. A familiar mode of pandering to the sense of power is to put any one to fright; even the child can chuckle over this triumph of its young ability. Campbell's second class of cases might seem at first sight to be the opposite of the first, and thereby to contradict the general theory which that illustrates. But when mean and little things are aggrandised, by elevated phraseology, so as to raise a laugh, it will always be found that the effect is owing, not to the raising of the subject, but to the degrading of the language by connection with such a subject. This is the so-called *mock-heroic*, where the grand and the lofty in speech being employed upon the mean and insignificant, are debased to the level of what they are applied to. Such is the nature of *parody*. So that, in fact, Campbell's second species are merely a variety of the first. The third species, marked by 'queerness and singularity of imagery,' are really

nondescript, but on analysis always yield more or less of the element of implied littleness or meanness in a subject usually held great or dignified.

In short, if we carefully set aside the element of the witty, we shall generally be able to explain the production of laughter upon a uniform principle. Every one would probably allow that nine cases out of every ten of the genuinely ludicrous are cases of the pleasure of degrading something, which furnishes a considerable presumption that the remainder are of the same general character, although perhaps enveloped with circumstances that disguise the fact. The figures of a powerful imagination, the resources of learning, and the polish of rhetorical art, may enter into a ludicrous combination. Such we have in the works of the great comic writers—in the plays of Aristophanes, Molière, and Shakspeare, and in the humour of Cervantes, Addison, Swift, and Sydney Smith—but wherever there is no expressed or implied degradation of some characters, classes, opinions, or institutions, we shall probably not experience the proper delight of the ludicrous.

LAUNCE (*Ammodytes*), a genus of fishes, of the eel tribe, with very elongated body, elongated head, large gill-openings, dorsal fin extending nearly the whole length of the back, anal fin also long, tail-fin distinct from them both, and forked. Two species are common on the British coast, often called SAND-KEEL, a name which, in some books of natural history, is restricted to the larger and less abundant of them (*A. Tobianus*), a fish about a foot long,



Sand Launce (*A. lancea*).

the *Hornel* of the Firth of Forth. The smaller species (*A. lancea*), about five or six inches long, is much used as bait by fishermen. Both are, however, very delicate and palatable. They are of a beautiful silvery colour. The under jaw projects beyond the upper, and is used in burrowing in the sand, to which these fishes retreat when the tide retires. They are obtained by digging in the sand, or by a kind of rake, or by nets drawn along the sand, when it is covered by the sea.

LAUNCESTON, the second town of Tasmania, or Van Diemen's Land, is to the north of the island what Hobart Town, the capital, is to the south—the chief port of entry and mart of trade. It stands at the junction of the Esk with the Tamar, which, after a course of 32 miles, enters Bass's Strait (q. v.) at Port Dalrymple. It is accessible to ships of considerable burden, and carries on a thriving commerce with the colonies of Victoria and South Australia. Among the principal buildings are a church, a government-house, a court-house, a jail, a college, a bank, barracks, and schools. The population is upwards of 6000. In 1860, 881 vessels, of 98,180 tons, entered and cleared the port. The imports, amounting in 1860 to £443,792, consist of manufactured goods, tea, sugar, &c. The exports in the same year amounted to £493,908, the chief articles being wool, oats, wheat, flour, timber, potatoes, horses, fruits. In the surrounding district of the same name rises Benlomed, to the height of 4500 feet.

LAUNCESTON, a parliamentary and municipal borough of England, formerly the capital of the county of Cornwall, is situated on the Kenese, a tributary of the Tamar, 21 miles north-east of Bodmin. It is a very old town; its castle was held of the Conqueror by the Earls of Moreton. It unites with the borough of Newport in sending a member to the House of Commons. The county assize formerly held here is now held at Bodmin. Pop. (1861) of municipal borough, 2790.

LAUNCH, the largest boat belonging to a ship. The launch has nearly superseded the long-boat, formerly the principal of a ship's boats. It is rowed by a considerable number of oars, double-banked, and has capabilities for sailing well, and for stowing several days' provisions. The launch of a man-of-war is frequently armed with a small piece of artillery in the bow; and when the ship is employed in narrow seas or rivers, it is not unusual for the launch to be despatched on expeditions far from the ship, and to points which she is unable herself to reach.

LAUNCH is the process of removing a vessel, especially a new one, from land to water. A ship is ordinarily built upon a wooden slip, which is an inclined plane (rising about 625 in 12), with one end reaching below the surface of the water to a depth greater than the ship's draught. The keel is built, not upon the slip itself, but on blocks of wood about three feet or less apart, standing on the slip. To maintain the hull in equilibrio while building, it rests in a cradle, the bottom

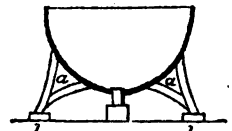

aa, cradle; bb, ways.

of which is supported by the ways on the slip, planed timbers leading towards the water. A section crosswise of a ship in this position is shown in the annexed figure. The time for launching having arrived, the ways are well greased, the shores and stanchions which hold the ship in place are knocked suddenly away, a bottle of wine is broken over the bow by some 'lady fair,' who gives the name, and the vessel glides down, *stern foremost*, into the water. The cradle is so formed that the weight of the vessel holds it together; but when that is withdrawn through the buoyancy of the water, the cradle breaks up into many pieces, and is recovered by boats in attendance.

The famous *Great Eastern* was built at Blackwall with the side parallel to the river, and launched over numerous iron rails; but owing to the bite of the iron keel upon the rails, it took three months' exertion, with the aid of the most powerful hydraulic rams, to push the immense ship (12,000 tons weight) into the river (January 31, 1858).

LAURACEÆ, a natural order of exogenous plants, consisting of trees or shrubs which have leaves without stipules, and flowers in panicles or umbels. The perianth is 4–6-cleft; the stamens opposite to its segments, and twice as many. The fruit is a one-seeded berry or drupe; the fruit-stalk often enlarging and becoming fleshy.—This order contains about 450 known species, mostly tropical. The Laurel (q. v.) is the only European species. An aromatic and fragrant character pervades the order, and amongst its products are cinnamon, cassia, and other aromatic barks, also a number of aromatic fruits somewhat resembling nutmeg. See NUTMEG. The timber of some species, as greenheart, is valuable; some are valuable for their medicinal barks, as greenheart (bebeer) and sassafras; some for their secretions, of which camphor is the most important. *Oreodaphne opifera*, a

LAUREATE—LAVA.

South American tree, yields a camphoraceous volatile oil in great quantity, if mere incisions are made in its bark. The fruit of some species is agreeable, as the Avocado Pear (q. v.).—A few very remarkable species, forming the genus *Cassia*, have been united with this order by many botanists, although others separate them as a distinct order. They are climbing parasites, like dodders, and inhabit the woods of the hottest parts of the globe.

LAUREATE, POET, is an officer of the household of the sovereigns of Great Britain. The appellation seems to have originated in a custom of the English universities of presenting a laurel wreath to graduates in rhetoric and vernification; the new graduate being then styled *Poeta Laureatus*. The king's laureate was then simply a graduated rhetorician in the service of the king. R. Whittington, in 1512, seems to have been the last man who received a rhetorical degree at Oxford. The earliest mention of a poet-laureate in England occurs in the reign of Edward IV., when John Key received the appointment. In 1630, the first patent of the office seems to have been granted. The salary was fixed at £100 per annum, with a tierce of canary; which latter emolument was, under Southey's tenancy of the office, commuted into an annual payment of £27. It used to be the duty of the laureate to write an ode on the birthday of the sovereign, and sometimes on the occasion of a national victory; but this custom was happily abolished towards the conclusion of the reign of George III. The following poets have held the office of laureate since the year 1670: John Dryden, Nahum Tate, Nicholas Rowe, Laurence Eusden, Colley Cibber, William Whitehead, Thomas Warton, Henry James Pye, Robert Southey, William Wordsworth—the office being at present held by Alfred Tennyson.

LAUREL (*Laurus*), a genus of *Lauraceæ* (q. v.), which, as now restricted, contains only a single known species, the NOBLE L., VICTOR'S L., or SWEET BAY (*L. nobilis*), a native of Asia Minor, but now diffused over all the countries around the Mediterranean Sea. It is often a mere bush of fifteen feet or less, but sometimes becomes a tree of thirty, or even sixty feet high. It has rather large, lanceolate, leathery, shining leaves, reticulated with veins, and axillary clusters of yellowish-white flowers of no beauty. The fruit is oval, bluish-black, and about half an inch long. Both the leaves and the fruit are bitter, astringent, and agreeably aromatic, and were formerly much used in medicine as a stomachic and stimulant, but are now almost out of use. The leaves, however, are still used in cookery for flavouring. They contain a volatile oil (*oil of sweet bay*), and a bitter, gummy extractive.

By the ancient Greeks, the L. was called *daphne*; it was sacred to Apollo. Berry-bearing twigs of it were wound round the forehead of victorious heroes and poets; and in later times, the degree of Doctor was conferred with this ceremony—whence the term *laureation*; and, according to some, the term *Bachelor* (q. v.). And to this day, a L. crown is the emblem of the honour to which poets, artists, and warriors aspire.

The Noble L. is common in shrubberies in Britain, but not nearly so common as the species of Cherry-laurel (q. v.), which share with it the name L., as do not a few other shrubs botanically very different, but somewhat similar in their evergreen foliage.

LAUREL-WATER is obtained by distilling a mixture of chopped and bruised leaves of the cherry-laurel and water, after 24 hours' maceration. It is seldom prescribed medicinally in this country, but may be given in doses of from half a drachm to a drachm as a sedative narcotic, in

neuralgic pains, spasmodic cough, and palpitation of the heart; in short, in all the cases in which hydrocyanic is applicable. Death has occurred, with all the symptoms of hydrocyanic poisoning, from its incautious use as a flavouring ingredient in creams and puddings.

LAURENTIAN SYSTEM, a series of highly metamorphosed rocks, older than the Cambrian, and apparently the fundamental series of the stratified rocks. They have been so named from their covering the whole country north of the St Lawrence, where they were originally described by Sir William Logan. They consist of hornblendic and micaceous gneiss, alternating with or passing into mica-schist, the whole being considered to have been originally sedimentary deposits, and to have been thus altered by long-continued metamorphic action. A few large, irregular beds of crystalline limestones, and bed-like masses of magnetic oxide of iron and other minerals, are interstratified with the gneiss. True igneous rocks are frequently intruded among these strata, as veins and masses of granite, syenite, and greenstone. The beds are highly inclined and greatly contorted, so that no approximate estimate can be made of their thickness, which seems to be very great. Murchison and Geikie have lately determined that certain great masses of highly crystalline gneiss, which underlie the Cambrian Series in the north of Scotland, belong to this period. It is probable that some of the highly metamorphosed rocks of the north of Ireland may be of the same age.

LAURUSTINUS (*Viburnum Tinos*, see **VIBURNUM**), a shrub very frequent in pleasure-grounds in Britain, a native of the south of Europe and the north of Africa. It is a beautiful evergreen, with dark, shining, leathery leaves, small whitish flowers in corymbs, and small blackish-blue berries. The flowers appear in winter or very early spring. The berries have drastic purgative properties; they are very acrid, and inflame the mouth violently, yet some kinds of birds eat them with avidity. The L. cannot endure much frost; and in Germany and the northern parts of the United States, it is a green-house plant.

LAUSANNE (Lat. *Lovsana*), a city of Switzerland, capital of the canton of Vaud, is picturesquely situated on the southern slope of the Jura Mountains, close to the northern shore of the Lake of Geneva, on which the village of Ouchy forms its harbour. The two principal parts of the city are separated by a valley, across which a fine bridge has been recently thrown. L. has a number of religious, educational, and scientific institutions. The cathedral, a beautiful Gothic building, begun in the 10th c., and completed in the 13th, is the greatest ornament of the city. L. is much frequented by visitors from all parts of the world. Here Gibbon resided for many years, and the house in which he wrote the greater part of the *Decline and Fall* is still shewn. John Kemble the actor is buried in a cemetery in the vicinity. Brewing, lithographing, and cotton and wool spinning are the principal branches of trade. Pop. 18,000, of whom 1000 are Roman Catholics.

LAVA, a name sometimes applied generally to Volcanic Rocks (q. v.), but more strictly confined to those rocks which have been poured out as a stream of molten matter from a volcanic opening, either on dry land or in shallow water. The surface of the stream, which speedily cools and hardens, is generally quite porous and vesicular, from the escape of the confined gases; but as rock is always a bad conductor of heat, the interior often remains long in a liquid condition, permitting the continued

flow of the stream sometimes to a very great distance from the orifice from which it has been discharged, notwithstanding its indurated covering. The end of the stream is a slowly-moving mass of loose porous blocks, rolling and tumbling over each other with a loud rattling noise, being pushed forward in fits and starts by the viscid lava, when it bursts the hardened crust and rushes on. The structure of the interior of a solid lava-stream shews a compact and homogeneous rock, assuming a more and more crystalline structure as the cooling has been the work of a longer or shorter period of time. Caverns are sometimes formed in lava-streams by the escape of the molten mass below, leaving the cooled crust standing like the roof of a tunnel.

LAVAL, an ancient and picturesque town of France, capital of the department of Mayenne, is situated on the river Mayenne, 42 miles east of Rennes. Its chief building is an old chateau, now a prison, and formerly the residence of the Dukes of La Tremouille. For 500 years, this town has been celebrated for its linen manufactures, which are exported from, as well as sold throughout France. Cottons, calicoes, serge, soap, and leather are also manufactured, and there is a considerable trade in grain, wool, timber, and iron. In the vicinity of L. the Vendéans under Larochejaquelein gained a brilliant victory over the Republicans, who lost 12,000 men and 19 cannon in the engagement. Pop. 21,300.

LA VALETTA. See VALETTA, LA.

LA VALLIÈRE, FRANÇOISE LOUISE DE LABAUME LERLANC DE, a celebrated mistress of Louis XIV. of France, was born at Tours, in 1644, of an ancient and noble family. At an early age, she lost her father, and was brought to court by her mother, who had married a second time. She was not a great beauty, and had a slight lameness; but her amiability and winning manners, and, above all, the extraordinary sweetness and tenderness expressed in her looks, rendered her very attractive. It is seldom that one can do more than praise the face of a king's mistress, but this singular creature was characterised by an extreme, we might almost say a morbid delicacy and modesty. She really loved Louis, and bore him four children, of whom two died in infancy; but although she and they received wealth and titles of honour, she remained always extremely sensible of the disgrace of their birth. When Madame de Montespan became the royal favourite, she retired into a Carmelite nunnery in Paris, where she took the veil in 1674. She died 6th June 1710, after having spent more than 30 years in penances and religious austerities. She wrote a work entitled *Réflexions sur la Miséricorde de Dieu* (Paris, 1680), of which a copy, dated 1688, with corrections by Bossuet, was discovered in the Louvre in 1852. Both have been edited by M. Romaine Cornut (Paris, 1854). A collection of her letters was published in 1767.

LAVATER, JOHANN KASPAR, born on the 15th November 1741 at Zürich, was the son of a physician. As a boy, he was by no means distinguished for his talents; but in 1762, whilst yet a youth, he gave a signal proof of his energy and courage in coming forward, along with Henry Fuseli, to accuse the *Landvoigt* Grebel of oppression and injustice, under which others had groaned without daring to complain. He early gained a high reputation by a volume of poems, entitled *Schweizerlieder* (Bern, 1767). His next publication was *Aussichten in die Bergwelt* (3 vols. Zür. 1768—1773), of which several editions were soon called for. The tone of this work is that of high religious enthusiasm, mingled with

asceticism. He filled in succession several ecclesiastical offices in his native city, and finally, in 1786, became minister of the church of St Peter there. His powers of observation were very keen, and his discrimination of character most delicate, and believing that he could discover much of men's characters from their countenances, he concluded that Physiognomy might come to be reckoned among the sciences. He laboured, therefore, to form a system of physiognomy, hoping thus to promote greatly the welfare of mankind, and at last he published the work to which he owes the chief part of his celebrity, *Physiognomischen Fragmente zur Beförderung der Menschenkenntnis und Menschenliebe* (4 vols., Leip. and Winterth. 1775—1778). This work, which has often been reprinted and translated, is written in an inflated style. It gave rise to much discussion, and occasioned not a little display of wit and humour. L. himself appears latterly to have been convinced that his system was fanciful. But he was of a highly imaginative temperament, and the religious orthodoxy which he firmly retained was incongruously combined with novel speculations and with superstitious notions. He was the chosen spiritual adviser of many persons both in Switzerland and Germany, with whom he maintained an unwearied correspondence. On his tours in Germany he received extraordinary marks of popular esteem and honour. When the French Revolution began, L. hailed it with joy; but after the murder of the king, he regarded it with religious abhorrence. In performing kind offices to some wounded persons on the street at the capture of Zürich by Massena, 26th September 1799, he received a wound, of the effects of which he died, after long suffering, 2d January 1801.

LAVAUUR, a town of France, in the department of Tarn, is situated on the left bank of the Agout, 20 miles north-east of Toulouse. Its manufactures are cotton-yarn, leather, and silk. Pop. 7330.

LA VENDER (*Lavandula*), a genus of plants of the natural order *Labiata*, having the stamens and style included within the tube of the corolla, the corolla two-lipped, the upper lip bifid, the lower trifid.—The COMMON L., or NARROW-LEAVED L. (*L. vera* or *L. angustifolia*), grows wild on stony mountains and hills in the south of Europe, and in more northern regions is very generally cultivated in gardens. It has a delightful aromatic fragrance, and an aromatic bitter taste, and contains a great quantity of a volatile oil, *oil of lavender*. The whole plant possesses stimulant properties, and is used in medicine, but particularly the spikes of the flowers, as a tonic, stomachic, nervous stimulant, &c. L. flowers are often put into wardrobes to keep away moths. They are much used in perfumery. *Oil of L.* is procured by distillation of L. flowers with water. It requires 70 lbs. of flowers to yield 1 lb. of oil. It is rather lighter than water, pale yellow, very fluid, and very fragrant. *Spirit of L.* is made by distilling L. flowers with rectified spirit; *L. water*, one of the most popular of all perfumes, by dissolving oil of L. with smaller quantities of other volatile oils in rectified spirit. L. is extensively cultivated for its flowers in some places near London, and particularly at Mitcham in Surrey, where more than 200 acres are occupied by it, the light and sandy soil being especially suitable to it.—BROAD-LEAVED L. (*L. latifolia* or *L. spica*) is also a native of the south of Europe, but is more tender than common lavender. It is also less fragrant, and the oil which it yields is called *Oil of Spike*, and sometimes *Foreign Oil of Lavender*. This oil is used by painters on porcelain, and in the preparation of varnishes.

LAYER, a name given to a number of kinds of sea-weed, which are used as food, especially *Porphyra vulgaris* and *P. laciniata*, of the sub-order *Conferaceae*, and nearly allied to the genus *Ulva*. These plants grow on rocks and stones in the sea, and are not unfrequent on the British shores. They consist of a very thin flat purple frond, which is not gelatinous. The frond of *P. vulgaris* is wavy and undivided, that of *P. laciniata* (sometimes called **SLOKE**) is deeply cleft, and has the segments lobed and cut at the edges. L. is stewed and brought to table as a luxury; also pickled and eaten with pepper, vinegar, and oil, or with lemon juice. It is regarded as useful in scrofulous affections and glandular tumours, a property which it probably owes to the iodine which it contains.—The name of **GREEN L.** is given to *Ulva latissima*, a common sea-weed of the British shores, the frond of which is green, membranous, broad, flat, wavy, and sometimes inflated. It is bitterish, but is often used in the same way as the true L., and possesses similar properties.

LAVISH PERSONS. See **INTERDICTION.**

LAVOISIER, ANTOINE LAURENT, the founder of the antiphlogistic or modern chemistry, was born in Paris, August 1743, and devoted himself to scientific, and particularly to chemical studies, to obtain the means of more fully prosecuting which, he accepted, in 1769, the office of farmer-general. In 1768, he was made an academician; in 1776, discovered a way of greatly improving the quality of gunpowder; and made other beneficial discoveries in economics, and in the application of chemistry to agriculture. Availing himself of the discoveries of Black, Priestley, and Cavendish, and making many experiments and discoveries himself, he was led to connect the recently-discovered gas, oxygen, with the phenomena of combustion and of acidity; and in 1783, he proved that water can be formed by burning oxygen and hydrogen together, and that it can be decomposed into the same elements. He and his associates invented a new chemical nomenclature, adapted to the advanced state of the science, which was very generally adopted. See **CHEMISTRY**, and **CHEMICAL NOMENCLATURE**. L.'s services to science could not save him from the popular rage directed against farmers of the taxes during the Reign of Terror, and he died by the guillotine, 8th May 1794. His principal work is his *Traité Élémentaire de Chimie* (2 vols., Paris, 1789); but of course all his chemical works are now interesting merely as marking the history of the science.

LAW, in Theology, a term variously used. In the Bible, it often includes the whole of revelation, doctrinal as well as preceptive; but it is often also used, in a more restricted and somewhat conventional sense, to signify the books of Moses, the whole Jewish scriptures being comprehended under the twofold designation of 'the law and the prophets.' A very natural and common use of the term law is to denote the preceptive part of revelation, in contradistinction to the doctrinal, the one being designated as *the law*, and the other as *the gospel*. When employed in scripture with exclusive reference to the preceptive part of revelation, the term law sometimes signifies the Jewish code of precepts as to rites and ceremonies, called by theologians the **CEREMONIAL LAW**, and which is regarded as having been abrogated when the Jewish dispensation gave place to the Christian. The ceremonial law is also regarded as having in its rites and ceremonies—'a shadow of good things to come'—symbolised the great doctrines which form the system of Christianity.—The **MORAL LAW** is that preceptive revelation of the divine will which is of perpetual

and universal obligation. It is commonly regarded by theologians as summed up in the *Ten Commandments*; and, according to our Saviour's own statement, as still more briefly and comprehensively summed up in the two commandments of loving God with all our heart, and soul, and strength, and mind, and loving our neighbours as ourselves. Although the Ten Commandments were given to the Jews at Mount Sinai, it is not therefore held that they were intended for the Jews alone, or were then first promulgated; the moral law being regarded as really the *law of nature*, written on the heart of man at his creation, although to fallen man a clear and express revelation of it has become necessary. One of the chief contested points in connection with this subject is that of the Sabbath (q. v.). Another relates to the law of nature, and the value which ought to be practically assigned to the decisions of the judgment and conscience of man, apart from express revelation.—The obligation of the moral law on the consciences of Christians is admitted by all except Antinomians (q. v.).

LAW has been variously defined. Blackstone says it means the rules of human action or conduct. This definition is too wide, for it is confined only to such rules as courts, supported by proper authority, will enforce. The law of nature consists of those laws which are common to all mankind, and are supposed to be, as nearly as can be conjectured, independent of the accidents of time and place. The civil or municipal law of a nation is what is commonly understood by the term law, when applied to a particular country. The 'Civil Law' is also sometimes used *par excellence* to denote the old Roman Law as embodied in the *Institutes* of Justinian, the Code, and other parts of what is commonly called the *Corpus Juris Civilis*. Many of the leading doctrines of that law have been adopted by modern nations. England is the civilised country which has adopted the least from that code of law, while Scotland follows the continental nations in adopting the Roman or Civil Law to a large extent, and on many subjects in adopting it entirely. The law of nations is subdivided into public International Law (q. v.) and private international law, or the *comitas gentium*. Law is often used in England as contradistinguished from equity, but this is chiefly due to the accidental circumstance, that there is a subdivision of courts into courts of law and equity, according to the nature of the remedy given. See **JURISPRUDENCE**, **INTERNATIONAL LAW**, **CHANCERY**. Law is also often in popular parlance distinguished from justice, the latter being supposed to be perfect in its nature, or as near the standard of perfection as can be supposed; whereas there are numberless cases of injury, hardship, and oppression, which, owing to human infirmity, no system of human laws can adequately redress; and this is often adduced as confirmation of the doctrine of future rewards and punishments. Law is also sometimes subdivided into criminal law, constitutional law, &c., according to the particular subject-matter.

LAW, ROMAN OR CIVIL. See **LAW.**

LAW, WILLIAM, an influential religious writer of last century, was born at Kingscliff, Northamptonshire, in 1686, and educated at Emmanuel College, Cambridge, where he took his degree of M.A. in 1712. He was for some time tutor to Edward Gibbon, father of the historian, who speaks of his piety and talents with unusual warmth. About 1740, two of his friends, Miss Hester Gibbon, sister of his pupil, and Mrs Hutcheson, widow of a London barrister, having resolved to retire from the world, and devote themselves to works of charity and a

religious life, chose L. for their almoner and instructor. The ladies settled at Kingscliffe, and here L. died, April 9, 1761. L.'s writings are deeply tinged with what is commonly called mysticism. His principal work is his *Serious Call to a Devout and Holy Life* (1729), a treatise that first awakened the religious sensibilities of Dr Johnson, who speaks of it in high terms, and from which the brothers Wesley also derived much advantage. Next to the *Serious Call*, his most important works are his *Answer to Mandeville's Fable of the Bees* (published 1724; republished, with an introduction by the Rev. F. D. Maurice, 1844), his *Letters to the Bishop of Bangor*, *The Way to Knowledge*, and *The Spirit of Love*. His collected works were published (Lond. 9 vols. 1762).

LAW, JOHN, comptroller-general of the finances of France, and famous for his credit operations during the minority of Louis XV., was born at Edinburgh, 21st April 1671. His father was a goldsmith and banker, and proprietor of the estate of Lauriston, near Edinburgh. L. early shewed a most remarkable talent for arithmetic, algebra, and kindred sciences. After the death of his father, he removed to London, where he was admitted into the first circles of fashion, but was soon compelled to flee, in consequence of a duel in which he killed his adversary. He went to Amsterdam, and spent his time in studying the credit operations of the bank. About the year 1700, he returned to Edinburgh, a zealous advocate of a paper currency; but his proposals to the Scottish parliament on this subject met with an unfavourable reception. He now visited different parts of the continent, where he accumulated a large fortune by gambling, but sought in vain to win the favour of governments to his banking schemes. At last, he settled in Paris, and in company with his brother William, set up, in 1716, a private bank, which was soon successful and prosperous to such an extraordinary degree, that the Duke of Orleans, the Regent, adopted, in 1718, L.'s plan of a national bank, and issued prodigious quantities of bank-notes, which enjoyed perfect credit, whilst the ordinary national bonds remained, as they had long been, at a price far below their nominal value. In 1719, L. originated his *Mississippi Scheme* (q. v.), and the following year was made a Councillor of State and Comptroller-general of Finances; but on the failure of his scheme, and the insolvency of the national bank, he resigned the latter office, and thought it prudent to quit France. He proceeded first to Brussels, but finally settled in Venice, where he managed to eke out a wretched living by gambling, and died there in May 1722. A complete edition of his works was published at Paris in 1790, and another in 1843.

LAWBURROWS, LETTERS OF, in Scotch Law, a writ or document in the name of the sovereign, commanding a person to give security against offering violence against another. The person applying for or issuing the letters must swear to the truth of some cause of alarm, such as actual personal violence or threats of violence. Sometimes a wife may apply for lawburrows against a husband. The person against whom the letters are directed, must find caution to keep the peace within a certain number of days specified, and this he does by executing a bond of caution. If he, notwithstanding, use violence, an action of contravention of lawburrows may be raised against him before justices of the peace, and he is fined in a sum equal to the actual damage resulting, which is paid to the party injured. An action lies against a person who maliciously takes out letters of lawburrows against another. Lawburrows corresponds

to what are called Articles of the Peace (q. v.) in England or Ireland.

LAW-MERCHANT, a name often used in law to denote the customs which have grown up among merchants in reference to mercantile documents and business, such as bills of exchange, bills of lading, &c. These customs become incorporated with, and form part of, the common law, and are binding as such.

LAWRENCE, a city of Massachusetts, U.S., on both sides of the Merrimack River, 26 miles from its mouth, and the same distance north of Boston. It is a handsome manufacturing city, with a park, and fountains supplied from a reservoir 140 feet high; has 14 churches, 3 weekly newspapers, and cotton manufactories employing a capital of 6 millions of dollars. These are supplied with water-power by a granite dam across the Merrimack River, 1629 feet long, and at the deepest part 40½ feet high, which has created a basin 9 miles long. The water is distributed to the mills by a canal 1 mile long, 100 feet wide, and 12 deep. The city has been entirely built within a few years, and was incorporated in 1853. Pop. in 1860, 17,639.

LAWRENCE, GULF OF ST., a western inlet of the Northern Atlantic, washes at once all the British provinces, properly so called, of North America—Newfoundland, Canada, New Brunswick, Nova Scotia, and Prince Edward's Island. It has three communications with the ocean—the Strait of Belleisle, between Newfoundland and Labrador; the Gut of Canso, between the island of Cape Breton and the peninsula of Nova Scotia; and a far wider passage than either, with the island of St Paul in the middle, between Cape Breton and Newfoundland: while in the opposite direction it narrows, at the west end of Anticosti, into the estuary of the mighty river, to which, as far even as its source, it has gradually extended its own name. Besides Anticosti, St Paul's, and Prince Edward's, already mentioned, this arm of the sea contains very many clusters of islands, and, more particularly in its southern half, the Magdalens and the Birds; these islands being, one and all, rendered more dangerous to shipping by the thickness of the fogs and the uncertainty of the currents. The Gulf of St L. is celebrated for the productiveness of its fisheries; but perhaps it is best known as a channel of traffic, connecting, as it does, the busiest thoroughfares of maritime trade with one of the most extensive systems of inland navigation in the world.

LAWRENCE, ST., the river mentioned in the preceding article, constitutes by far the largest body of fresh water in the world. Including the lakes and streams, which it comprises in its widest acceptation, it covers, according to the lowest estimate, fully 73,000 square miles; and as nearly the whole of this area averages considerably more than 600 feet in depth, the aggregate cannot represent less than 9000 solid miles—a mass of water which would take upwards of 40 years to pour over the Falls of Niagara, at the computed rate of a million cubic feet in a second. As the entire basin of this water-system falls short of 300,000 square miles, the surface of the land is only three times that of the water.

This mighty artery of North-east America rises, under the name of the St Louis, on the spacious plateau which sends forth also the Mississippi towards the Gulf of Mexico, and the Red River of the north towards Hudson's Bay—all three being said, in wet seasons, occasionally to mingle their floods. Lake Superior, the next link in the chain, finds its way to Lake Huron through the rapid of St Mary, which has been overcome by a ship

canal on the right, or American side. Below Lake Huron, which receives Lake Michigan from the south, the river St Clair, Lake St Clair, the river Detroit and Lake Erie maintain pretty nearly the same level, till the river Niagara descends 334 feet to Lake Ontario, which is itself still 230 feet above sea-level. From this, the last of the connected series of inland seas, issues the St L. proper, which, with a few comparatively insignificant expansions, presents the character first of a river, and then of an estuary, down to the gulf. Between Lake Ontario and the city of Montreal, which marks the head of the navigation, there are various cataracts or rapids, which, besides having been gradually ascertained to be more or less practicable, may be all avoided by means of canals on the British side. At about two-thirds of the distance from Lake Ontario to the city of Montreal, the intersection of the parallel of 45° determines the point where the St L., after having been an international boundary from the head, or nearly so, of Lake Superior, becomes exclusively Canadian. Immediately above the island of Montreal, the St L. is joined by its principal auxiliary, the Ottawa, from the north-west; and a little more than half-way between this confluence and Three Rivers, the highest point of tidal influence, the Richelieu or Sorel, from the south, brings in the tribute of Lake Champlain. Between Montreal and Quebec the St L. has recently been much deepened (see MONTREAL). At Quebec, after a run of nearly 400 miles from Lake Ontario, it steadily widens into an estuary of about the same length. The entire length, including the chain of lakes, is about 2200 miles.

In connection with the improvements on itself and its affluents, the St L. offers to sea-going ships the noblest system of inland navigation in the world, embracing a continuous line of about 2000 miles; its advantages, however, are materially impaired by the severity of the climate, which binds it in the chains of winter at least five months in the year.

LAWRENCE, Sr, the Deacon, one of the most celebrated martyrs of the early church, the subject of many ancient panegyrics, and of one of the most elaborate of the hymns of Prudentius. He was one of the deacons of Rome, in the pontificate of Sixtus I. (3d c.), and as such was especially charged with the care of the poor, and the orphans and widows. In the persecution of Valerian, being summoned, according to the legend, before the prætor as a Christian, and being called on to deliver up the treasures of the church, he mockingly produced the poor and the sick of his charge, declaring that 'those were his treasures;' and on his persisting in his refusal to sacrifice, being condemned to be roasted on a gridiron, he continued throughout his tortures to mock his persecutors. Many of the details of his martyrdom are probably due to the imagination of the poetical narrator; but the martyrdom is unquestionably historical, and dates from the year 258. His feast is celebrated on the 10th August.

LAWRENCE, SIR THOMAS, President of the Royal Academy, was born at Bristol in 1769, and at the early age of ten years entered on the profession of a portrait-painter in crayons, at Oxford, where he immediately obtained full employment. There is an engraving which bears to have been 'directed by L. K. Sherwin,' the celebrated engraver, of a portrait of the young artist; it is dedicated in the following terms: 'To the nobility and gentry in general, and the university of Oxford in particular, who have so liberally countenanced his pencil, this portrait of Master Lawrence is inscribed by their most devoted and most grateful servant, T.

Lawrence, senior.' It was published by Lawrence, senior, at Bath, June 18, 1783, along with a print of Mrs Siddons in the character of Zara, drawn by Master L., and engraved by J. R. Smith. The young artist next set up at Bath, where he met with great encouragement; and at the age of eighteen, settled in London, and entered as a student of the Royal Academy, having a year previously taken to painting in oil. His success was extraordinary; in 1791, before he attained the age required by the laws of the Academy, he was elected a supplemental associate by desire of the king; on Reynolds's death a year afterwards, was appointed limner to his majesty; was made a Royal Academician in 1798; knighted in 1815; and on Benjamin West's death in 1826, succeeded him as President of the Royal Academy. He died in London, 7th January 1830. L. was the favourite portrait-painter of his time, had an immense practice, and obtained larger prices for his works than were ever paid to any previous portrait-painter. His talent as a painter was doubtless overrated during his life, but justice has scarcely been done to it of late years; for his style, though in many respects meretricious, was greatly influenced by the fashion and dress of the period, and in time to come, impressions of the principal characters who figured during the Regency, and in the reign of George IV., will be taken mainly from his works. His portraits in the Waterloo Gallery at Windsor are of the greatest value as historical monuments. He was a man of great urbanity and fine taste, and left at his death a most valuable collection of drawings by the old masters, now unfortunately broken up. See the *Life and Correspondence of Sir T. Lawrence*, by Williams (1831), and Cunningham's *Lives of British Painters* (1833).

LAWRENCE, RIGHT HONOURABLE SIR JOHN LAIRD-MAIR, Bart., Indian statesman, is younger son of Lieutenant-colonel Alexander Lawrence, who served in the Mysore campaign, and at the capture of Seringapatam. Born at Richmond, Yorkshire, 1811, he obtained, in 1827, a presentation to Haileybury College, where he carried off the chief prizes for law, oriental languages, &c. His first years in the Indian civil service were spent in Delhi and the neighbourhood. On the annexation of the Punjab, consequent upon the treacherous rebellion of the Sikhs, L. was appointed commissioner, and afterwards lieutenant-governor of the Punjab. His administration was marked by rare talents, and rewarded by brilliant success. When the Indian mutiny broke out, his great qualities and force of character proved the main stay of the British dominion in India. The once restless Sikhs had become so attached to his firm, equitable, and beneficent rule, that L. was enabled to send troops to the relief of Delhi, &c. So timely was this succour, and so great was his foresight, that he was styled, with a perhaps pardonable exaggeration, 'the saviour of India.' On his return to England, he received the order of G.C.B., the thanks of parliament, with the grant of a pension of £1000 a year, the freedom of London, Glasgow, &c. He was made a baronet and appointed a member of the council of India in 1858, and a privy-councillor in 1859. In 1861, when the order of the 'Star of India' was instituted by the Queen, L. was nominated one of the knights.

His elder brother, Brigadier-general SIR HENRY MONTGOMERY LAWRENCE, born in 1806, was chief commissioner of Lucknow, and virtually governor of Oude when the Indian mutiny broke out. While in command of the handful of heroic men who defended the women and children in the Residency of Lucknow, Sir Henry was wounded by the explosion of a shell, and died July 4, 1857. He was the

founder of the Lawrence Asylum, for the reception of the children of the European soldiers in India. A monument to his memory has been placed in St Paul's Cathedral.

LAW-TERMS. The usual law-terms in England and Ireland mean those periods of the year during which the law-courts sit in banc or in full court to dispose of business. These are of ancient origin, and are now fixed by statute as follows: Hilary term begins January 11, ends 31st January; Easter term begins April 15, ends 8th May; Trinity term begins May 22, ends 12th June; Michaelmas term begins November 2, ends 25th November. Though the courts always sit at those periods, yet they have a power of appointing sittings after term also, which power is always exercised for the despatch of arrears of business. And the judges also practically sit nearly all the year round, disposing of business of one kind or another, except in the long vacation, which extends from 10th August to 24th October. But even during that period also, one or more judges attend to perform incidental business; and it is only for some purposes, and for some kinds of business, that the long vacation acts as a suspension of hostilities.

In Scotland, the law-terms are differently arranged. The Court of Session sits from 12th November to 20th March, and from 12th May to 20th July. But there also the judges are employed in other business during the intervals.

As to the quarter-days usual between landlord and tenant, see **LANDLORD AND TENANT**.

LAWYER, in the United Kingdom, is not a technical term of law, but a popular name given to those who are either practitioners of the law or intimately connected with its administration. In Great Britain and Ireland, lawyers are subdivided into two classes. See **ATTORNEYS AND SOLICITORS**, **BARRISTERS**, **ADVOCATES**. In the United States of America, an attorney acts as counsel, and *vice versa*, there being no similar subdivision of the profession, and the expediency of the subdivision has often been canvassed in the United Kingdom of late years.

LAYARD, **AUSTEN HENRY**, English traveller and politician, was born at Paris in 1817. He was destined for the law, but finding the profession little congenial to his tastes, he set out on a course of eastern travel, visited several districts of Asiatic Turkey, and became familiar with the manners and dialects of Persia and Arabia. On his first journey along the banks of the Tigris, in 1840, he was struck with the ruins at Nimrud—a village near the junction of the Tigris and the Zab, pointed out by local tradition as the site of the original city of Nineveh—and felt an irresistible desire to examine the remains of the 'birthplace of the wisdom of the west.' In 1842, M. Botta, the French consul at Mosul, conducted some extensive excavations at that place, and L. returning to the region, again directed his attention to Nimrud. It was 1845 before he could obtain the requisite means and facilities for his search, and he then, with the help of some Arabs, began secretly to dig in the mound supposed to contain the ruins. He soon came upon some sculptured remains, and became convinced that he had touched a rich vein of archaeological treasure. His excavations were resumed in 1846 and 1847, and his energy and perseverance were rewarded by the discovery of the ground remains of four distinct palatial edifices. The walls had been lined with large slabs of gypsum or alabaster, covered with bas-reliefs and cuneiform inscriptions. Many of these were sent to England by L., together with gigantic-winged human-headed

bulls and lions, and eagle-headed deities. They were placed in the British Museum, of which they have since remained the chief attraction. L. at first conducted his search at his own expense; he was, in 1845, liberally assisted by Lord Stratford de Redcliffe, then British ambassador in Constantinople; and eventually, as the value of these specimens of Assyrian art began to be known, the House of Commons voted a sum of £3000, which was applied by the trustees of the British Museum, in continuing the excavations under L.'s superintendance. On his return to England, he published a narrative of his explorations, under the title of *Nineveh and its Remains*, and another work entitled *Monuments of Nineveh*. He was presented with the freedom of the city of London, received the honour of D.C.L. from the university of Oxford, and was Lord Rector of Aberdeen university in 1855—1856. Having determined to devote himself to a political career, he became, in 1852, M.P. for Aylesbury, but lost his seat in 1857. He visited the Crimea during the Russian war, and went to India after the mutiny. In 1860, he again entered the House of Commons as member for Southwark. In 1861, he was appointed Under-Secretary of State for Foreign Affairs in the Palmerston government. This post he continues (1863) to fill.

LAYING, or **LAYERING**, a mode of propagating trees, shrubs, and perennial herbaceous plants, which is very frequently employed by gardeners and nurserymen. It consists in bending and fastening a branch, so that a portion of it is imbedded in earth, there to throw out roots, the extremity being made to grow erect in order to form a new plant. The separation from the parent plant is not effected till the layer is sufficiently provided with roots. Any injury which prevents the free return of the sap greatly promotes the formation of roots, and a notch is therefore usually made in one side of the branch, at the place where the formation of roots is desired; it is also often a little split up from the notch; and sometimes a ring of bark is cut off, or a wire is twisted round it. The time which must elapse before the layer should be separated from the parent plant is very various; a few months being sufficient for some, and two years requisite for others. Many plants which can be propagated by cuttings are more easily and successfully propagated by layers.

LA'ZULITE, or **AZURITE**, a mineral long confounded with Lapis Lazuli (q. v.), but although somewhat similar in colour, very different in composition; consisting chiefly of phosphoric acid and alumina, with magnesia and protoxide of iron. It occurs imbedded in quartz, or in fissures in clay-slate, in Styria, North Carolina, Brazil, &c.

LAZZARONI, a name said to be derived from that of Lazarus in the parable, and, until lately, designating a particular class of the inhabitants of Naples. They had no fixed habitations, regular occupation, or secure means of subsistence, but occasionally obtained employment as messengers, porters, boatmen, itinerant vendors of food, &c. They have performed an important part in all the revolutions and movements in Naples for a long period, and in recent times have allied themselves to the cause of despotism. They were wont annually to elect a chief (*Capo Lazzaro*), who was formally recognised by the Neapolitan government, and who exercised an extraordinary power over them. Of late, they have lost many of their peculiarities, have come more within the pale of civilisation, and, in fact, are no longer recognised as a separate class, though the name is still given to the boatmen and fishermen of the city, who are really

the most industrious and best-principled of the Neapolitan populace.

LE, the capital of Ladakh, or Middle Tibet, on the right bank of the Upper Indus, in lat. 34° 10' N., and long. 77° 40' E., at an elevation of more than 10,000 feet above the sea. The population is about 4000. The place is a main *entrepôt* between Chinese Tartary and the Punjab, being more especially the grand mart for the famous shawl-wool of Tibet.

LEAD, THE, used on shipboard, for ascertaining the depth of water, consists of a piece of lead shaped like an elongated clock-weight, attached to a line of about 20 fathoms. The lower part of the lead is scooped out, and filled with tallow, that portions of the bottom may adhere. The *deep-sea lead* weighs from 25 to 30 lbs., and is attached to a line of far greater length.

LEAD (symb. Pb., equiv. 103.7, spec. grav. 11.4) is a bluish-white metal of considerable brilliancy, which soon disappears on exposure to the air, owing to the formation of a thin film of oxide. It is so soft that it may be readily cut with a knife, or may be made to take impressions, and it leaves a streak upon paper. It may be cut or beaten into thin sheets, but in ductility and tenacity it is low in the scale of metals. It is readily fusible at a temperature of about 625°, and at a higher temperature it absorbs oxygen rapidly from the air, and the oxide thus formed volatilises in the form of white fumes.

The combined action of air and water on lead is a subject of great practical importance, in consequence of the metal being so frequently employed in the construction of cisterns and water-pipes. The lead becomes oxidised at the surface, and the water dissolves the oxide; this solution absorbs the carbonic acid of the atmosphere, a film of hydrated oxycarbonate of lead ($PbO,HO + PbO,CO_2$) is deposited in silky scales, and a fresh portion of oxide of lead is formed and dissolved, and in this way a rapid corrosion of the metal ensues. This action is materially increased by the presence of some salts, and diminished by the presence of other salts in the water. It is much increased by the occurrence of chlorides (which, as chloride of sodium, is often present in spring water), and of nitrates and nitrites (which are often present in spring and river waters, from the decomposition of organic matter); while it is diminished by the sulphates, phosphates, and carbonates, and especially by carbonate of lime, which is an extremely common impurity in spring water. In the latter case, a film of insoluble carbonate of lead is rapidly formed on the surface, and the metal beneath is thus protected from the action of the water. If, however, the water contain much carbonic acid, the carbonate of lead may be dissolved, and considering the dangers that arise from the use of water impregnated with lead, cisterns constructed of slate are far preferable to leaden ones.

Pure lead is of very rare occurrence. Almost all the lead of commerce is obtained from Galena, the native sulphide of lead by a process to be presently explained. The lead thus obtained is often *nearly* pure, and to obtain it *perfectly* pure, it should be reduced with black flux from the oxide left by igniting the pure nitrate or carbonate.

The compounds of lead with oxygen are four in number—viz., a sub-oxide, Pb_2O , which is a black powder of no importance; a protoxide, PbO , which is the base of the ordinary salts of the metal; a binoxide, PbO_2 ; and red lead, which is a compound of the two last-named oxides, and is usually represented by the formula $2PbO, PbO_2$. The protoxide is commonly known as *Litharge*. It is

obtained on a large scale by the oxidation of lead in a current of air, when it forms a scaly mass of a yellow or reddish tint. If the oxidation be effected at a temperature below that required for the fusion of oxide, a yellow powder, termed *Massicot*, is obtained. *Litharge* is much used by the assayer (see *ASSAY*) as a flux; it enters largely into the composition of the glaze of common earthenware, and it is employed in pharmacy in the preparation of plasters. A mixture of 1 part of massicot with 10 of brickdust, made into a paste with linseed-oil, forms the compound known as *Dhl massic*, which, from the hardness with which it sets, is frequently employed to repair defects in stone-facings.

The most important of the salts of the protoxide of lead are—1. The *carbonate* (PbO,CO_2), which occurs native as a beautiful mineral in transparent needles or fibrous masses, and which is prepared under the name of *white lead* on a large scale as a pigment by a process to be subsequently described. The carbonate is insoluble in water, unless it is largely charged with carbonic acid. It is quickly blackened by exposure to hydrosulphuric acid (sulphuretted hydrogen), either in the form of gas or in solution, and this is a serious drawback to the use of the lead salts as pigments. 2. The *sulphate* (PbO,SO_2), which occurs native in white prismatic crystals, and is formed as a heavy white precipitate on adding sulphuric acid or a soluble sulphate to a soluble lead salt. 3. The *nitrate* (PbO,NO_2), which is formed by dissolving lead or its protoxide in dilute nitric acid. 4. The *chromates*, of which the principal are the neutral chromate or *chrome yellow* (PbO,CrO_2), and the dichromate or *orange chrome*. These are much used as pigments, and in calico-dyeing. 5. The *acetates*. The ordinary or neutral acetate ($PbO,C_2H_3O_2 + 3aq.$) is prepared on a large scale by the solution of litharge in distilled vinegar, and evaporation, when the salt is obtained in four-sided prisms, or more commonly in a mass of confused minute white crystals, which at 212° lose their water of crystallisation. From its appearance, and from its sweetish taste, it derives its common name of *sugar of lead*. It is much used both in medicine and in the arts. Basic acetate of lead, regarded by some chemists as a diacetate, and by others as a triacetate, and commonly known as *Goulard's Extract*, is prepared by boiling a solution of sugar of lead with litharge, and adding alcohol, when the salt separates in minute transparent needles. It is the active ingredient of *Goulard Water*, which is imitated by the *Liquor Plumbi Diacetatis Dilutus*, and of *Goulard's Cerate*, which is imitated by the *Ceratum Plumbi Compositum* of the London Pharmacopœia.

The best tests for solutions of the salts of lead are the formation of a black sulphide with hydrosulphuric acid or hydrosulphate of ammonia, insoluble in an excess of the reagent; of a white insoluble sulphate with sulphuric acid, or a soluble sulphate; of a yellow chromate with chromate of potash; and a yellow iodide with iodide of potassium. All the salts of lead, insoluble in water, are soluble in a solution of potash. Before the blow-pipe on charcoal, the salts of lead yield a soft white bead of the metal, surrounded by a yellow ring of oxide.

Its use in Medicine.—The most important compound of lead in the *materia medica* is the *acetate of lead*, which is administered internally as an astringent and as a sedative. It is of service as an astringent, especially in combination with opium, in cases of mild English cholera, and even of Asiatic cholera, and in various forms of diarrhoea. It will frequently check the purulent expectoration in

LEAD.

phthisis, and the profuse secretion in bronchitis. In the various forms of hæmorrhage—as from the lungs, stomach, bowels, or womb—it is employed partly with the view of diminishing the diameter of the bleeding vessels, and partly with the object of lowering the heart's action, and by these means to stop the bleeding. The ordinary dose is two or three grains, with half a grain of opium, in the form of a pill, repeated twice or thrice daily. If given for too long a time, symptoms of Lead-poisoning (q. v.) will arise.

Mining, Smelting, &c.—Lead was largely worked by the Romans in Great Britain, and pigs with Latin inscriptions have been frequently found near old smelting-works. The mining of lead in England was formerly regulated by curious laws; some places, such as the King's Field, in Derbyshire, having special privileges. It was the custom in this district not to allow the ore to leave the mine till it was measured in the presence of an official called a *bar-master*, who set aside a 25th part as the king's cope or lot. Up to a comparatively recent period, persons were allowed to search for veins of the ore without being liable for any damage done to the soil or crops.

Lead ore is pretty generally distributed, but by far the largest supply of this metal is obtained from Great Britain and Spain, the former country yielding some 65,000 tons per annum, and the latter probably an equal supply. Nearly a fourth of the total British produce is procured from the Northumberland and Durham district, where there exists, at Allenheads, one of the largest mining establishments in the world. Scotland and Ireland furnish only a very small quantity.

With the exception of a little from the carbonate of lead, all the supplies of this metal are obtained from the sulphuret of lead or Galena (q. v.). The lead ore, when taken from the mine, is broken up into small pieces, 'hotched,' and washed, to separate impurities, by means of apparatus described under METALLURGY. Sulphuret of lead, when tolerably pure, is smelted with comparative ease. It is first roasted in a reverberatory furnace, such as is shewn in the figures 1 and 2. From

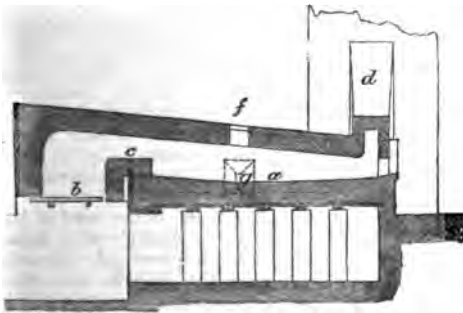

Fig. 1.—Section of a Reverberatory Lead Furnace.

20 to 40 cwts. of galena are put into the furnace at a time, either with or without lime. In about two hours, the charge becomes sufficiently roasted. During the process, the larger portion of the ore (PbS) takes up four equivalents of oxygen, and becomes sulphate of lead (PbO,SO_2), a little oxide of lead (PbO) is also formed, while another portion remains unaltered as sulphuret of lead. After it is roasted, the ore is thoroughly mixed together, and the heat of the furnace suddenly raised. The result is, that the sulphur and oxygen of the sulphate, and the sulphur of the sulphuret of

lead, combine to form sulphureous acid gas (SO_2), which passes off as waste, and metallic lead remains in the bottom of the furnace, and is run off at the tap-hole, *g*.

In some districts, the roasted ore is smelted on a separate ore-hearth called the Scotch furnace. It somewhat resembles a smith's forge, and like it, has the heat urged by bellows. Peat and coal are used as the fuel. This is a slower mode of smelting than by the reverberatory furnace, but yields a purer lead.

During the operation of smelting, a considerable quantity of lead is volatilised, and carried off as *fume* or *smoke*, which, when allowed to escape into



Fig. 2.—Plan of a Reverberatory Lead Furnace :
a, hearth on which the ore is spread; *b*, fireplace or grate; *c*, the fire bridge; *d*, chimney; *e*, working doors; *f*, opening for supplying ore; *g*, tap-hole.

the atmosphere, is not only so much lead lost, but destroys all vegetation for some distance around the works, and poisons cattle and other animals feeding near them. Of late years, a mode of obviating these evils has been partially introduced—it consists in leading the smoke from the several furnaces into one large flue, which is conducted to an exhausting chamber. The smoke passes in a zig-zag manner through the vacuum chamber, in the interior of which a stream of water, sufficient to condense the lead and other matters suspended in the vapours, is kept flowing. About 33 per cent. of the fume thus recovered consists of metallic lead.

When lead contains antimony and tin as impurities, they are separated by fusing the metal in shallow pans, and allowing it to oxidise at the surface. In this way, the antimony and tin form oxides, and as such are skimmed off. Lead reduced from galena always contains a little silver, of which 8 or

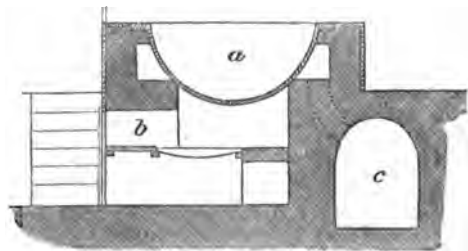

Fig. 3.—Desilverizing Pot :
a, pot; *b*, fireplace; *c*, main flue.

10 ounces to the ton is a very common proportion, although it often exists in much larger quantity. The separation of this silver is now greatly facilitated by means of a desilverizing process patented by the

late Mr H. Pattinson of Newcastle-on-Tyne. It consists in melting the lead, and allowing it to cool slowly, at the same time briskly stirring the melted mass. A portion of the lead is thus made to crystallise in small grains, which, as pure lead solidifies at a lower temperature than when alloyed with silver, leaves the uncrystallised portion richer in silver. In this operation, a row of, say, nine cast-iron pots are used similar to the one shewn in fig. 3. They are usually about 6 feet in diameter, and each heated with a fire below. The lead from the smelting furnace is treated as above in the middle pot, from which the poorer crystallised portion is ladled with a strainer into the first pot on the right, and the richer portion, which remains liquid, is removed to the first pot on the left. With both kinds, the process is several times repeated—the one becoming poorer, and the other richer in silver every time, till the lead in the pot on the extreme right has had its silver almost entirely removed, and that in the pot on the extreme left contains about 300 ounces of silver to the ton. The silver is then obtained from this rich lead by melting it on a flat bone ash cupel, placed in a reverberatory furnace, and exposing it to a current of air which reduces the lead to the oxide or *litharge* of commerce, leaving the silver on the cupel. Nearly 600,000 ounces of silver are in this way annually separated from British lead, the latter at the same time being improved in quality.

Lead is an important metal in the arts. Rolled out into sheets, it is largely used for roofing houses, for water-cisterns, and for water-pipes. It is also of great service in the construction of large chambers for the manufacture of sulphuric acid. Its value for the manufacture of shot is well known. Alloyed with antimony, &c., it is largely consumed for type-metal, and with tin for solder. Much lead is also required for the manufacture of pewter, Britannia metal, &c. See ALLOY.

Of the compounds of lead other than alloys which occur largely in commerce, the following are the principal:

White Lead or Carbonate of Lead, a substance very extensively used as white paint, and also to form a body for other colours in painting. As much as 16,000 tons of it are annually made in England. White lead is still largely made by the old Dutch process, which consists in treating metallic lead, cast in the form of stars or gratings, in such a way as to facilitate the absorption of carbonic acid. These stars of lead placed in earthenware vessels, like flower-pots, containing a little weak acetic acid, are built up in tiers in the form of a stack, and surrounded with spent tan or horse-dung. The heat given out from the dung volatilises the acid, which, along with the air, oxidises the lead. The acetic acid changes the oxide into the acetate of lead, and this is, in turn, converted into the carbonate by the carbonic acid given off from the hotbed. By this process, metallic lead requires from six to eight weeks for its conversion into white lead. Some new and more rapid modes have been introduced for the preparation of this material from litharge, and also from acetate of lead, by exposing them to a current of carbonic acid gas, but the white lead so manufactured is inferior in opacity.

Minium, Red Lead, or Red Oxide of Lead, is much consumed in the manufacture of flint-glass and porcelain, and to some extent as a pigment. It requires to be made of very pure lead, as a slight trace of copper would impart a colour to glass. Minium is prepared by heating *massicot* or protoxide of lead to a temperature of 600° F. in iron trays, in a reverberatory furnace, carefully avoiding fusion. More oxygen is thus gradually absorbed; and a compound of the protoxide and the peroxide of lead is formed,

having a bright red colour, which is the red lead of commerce.—*Litharge* has been already noticed.

LEAD-POISONING. Persons whose system becomes impregnated with lead, as, for example, painters, who are constantly handling white lead, or persons who for a length of time have been using water charged with a lead-salt, exhibit a series of phenomena of lead or saturnine poisoning.

The early phenomena, which constitute what Tanquerel des Planches, the highest authority on this subject, terms *primitive saturnine intoxication*, are, (1), a narrow blue line, due to the presence of sulphide of lead, on the margin of the gums next the teeth; (2), a peculiar taste in the mouth, and a peculiar odour of the breath; (3), a jaundiced state of the skin, with more or less emaciation; (4), a depressed state of the circulation.

These premonitory phenomena are followed, unless remedial means are adopted, by the four following forms of disease, each of which may exist alone, or may be complicated with one or more of the others, or may follow the others, without, however, having any definite order of succession.

1. **LEAD COLIC**, which is by far the most frequent of the diseases.

2. **LEAD RHEUMATISM or ARTRALGIA**, which in frequency is next to colic.

3. **LEAD PALSY or PARALYSIS**, which may affect either motion or sensation, and is next in frequency.

4. **DISEASE of the BRAIN**, which is the least common of all the forms of lead-poisoning, and is manifested by delirium, by coma, or by convulsions.

Lead Colic is characterised by sharp continuous abdominal pains, which are usually diminished on pressure; by hardness and depression of the abdominal walls; by obstinate constipation, slowness and hardness of the pulse, and general disturbance of the system. The blue line on the gums serves at once to distinguish it from other varieties of colic.

Lead Rheumatism is characterised by sharp pains in the limbs, unaccompanied by redness or swelling, diminished by pressure, increased by motion, and accompanied by cramps, with hardness and tension of the affected parts. It is distinguished from similar affections by the blue line on the gums.

Lead Palsy is characterised by a loss of voluntary power over certain muscles. It more commonly affects the upper than the lower extremity, and the muscles most frequently affected are those of the ball of the thumb, and the extensors of the wrist, giving rise to the condition represented in the figure as *wrist-drop*.

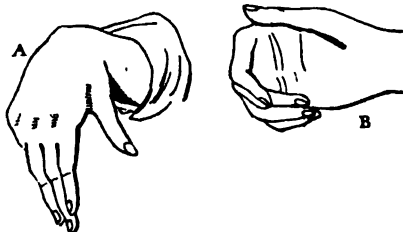

A shows the drooping of the hand in consequence of the palsy of the extensor muscles, while B shows the wasted condition of the muscles which form the ball of the thumb.

The Treatment.—The patient should be placed in a sulphuretted bath, which converts all the lead-salts on the skin into the inert black sulphide of lead. These baths should be repeated till they cease to cause any coloration of the skin. At the same time, he should drink water acidulated with sulphuric acid, or a solution of sulphate of magnesia, with a slight excess of sulphuric acid, by which

means an insoluble sulphate of lead is formed, which is eliminated by the purgative action of the excess of sulphate of magnesia. Iodide of potassium is then administered, which acts by dissolving the lead out of the tissues, and allowing it to be removed by the urine.

The palsy may be specially treated, after the elimination of the lead, by electricity, and by strychnine in minute doses.

Persons exposed from their occupation to the risk of lead-poisoning should be especially attentive to cleanliness; and if they combine the frequent application of the warm bath with the use of sulphuric lemonade or treacle beer acidulated with sulphuric acid, as a drink, they may escape the effects of the metallic poison.

LEADER, the name given to the performer in an orchestra who plays the principal first-violin.

LEADING NOTE (Fr. *note sensible*), in Music, is usually understood to mean the sharp seventh of the diatonic scale, or the semitone below the octave, to which it leads. The most of the German theorists have now relinquished the term leading note, as every note, when it is felt that another immediately above or below it should follow, may be said to be a leading note.

LEADING QUESTION is a technical expression in Law to denote a question so put to a witness as to suggest the answer that is desired or expected. Thus, if a witness is asked: 'Was he dressed in a black coat?' it is supposed the witness will answer, yes; whereas the proper way of putting the question is: 'How was he dressed?' or, 'What kind of coat?' &c. The rule established in courts of justice as to the correct practice in such matters, is, that when a witness is examined in chief, i. e., by the party who adduces such witness, leading questions are not allowed, except in one or two rare cases; whereas, when the witness is cross-examined, i. e., by the opposing party, leading questions may be put; for the object is to make the witness contradict and stultify himself, so that the jury will disbelieve him. The above rule, however, only applies to material questions, for in immaterial questions leading questions may be put, so as to save time.

LEAF-CUTTER BEE, a name given to certain species of *solitary bees* (see **BEE**) of the genera *Megachile* and *Osmia*, in consequence of their habit of lining their nests with portions of leaves, or of the petals of flowers, which they cut out for this purpose with the mandibles. *Megachile centuncularis*, a common British species, 'uses the leaves—not the petals—of roses, fitting the pieces together so as to form one thimble-shaped cell within another, in a long cylindrical burrow, the bottom of each cell containing an egg and a little pollen paste. The structure of these nests is very nice and curious.

LEAF-INSECT, or **WALKING-LEAF** (*Phyl-*



Leaf-Insect.

laea), a very remarkable genus of orthopterous insects, of the family *Phyllotretidae* (q. v.), natives of

tropical countries, having wings extremely like leaves, not only in colour, but in the way in which they are ribbed and veined. The joints of the legs are also expanded in a leaf-like manner. These insects spend their lives among leaves, move slowly, and would be much exposed to every enemy, did not their leaf-like appearance preserve them from observation.

LEAGUE (from the Lat. *leuca*), a measure of length of great antiquity. It was used by the Romans, who derived it from the Gauls, and estimated it as equivalent to 1500 Roman paces, or 1·376 modern English miles. The league was introduced into England by the Normans, probably before the battle of Hastings (1066), and had been by this time lengthened to 2 English miles of that time, or 2½ modern English miles. At the present day, the league is a nautical measure, and signifies the 20th part of a degree—i. e., 3 geographical miles, or 3·456 statute miles. The French and other nations use the same nautical league, but the former nation had (until the introduction of the metrical system) two land-measures of the same name, the legal posting-league = 2·42 Eng. miles, and the league of 25 to the degree, which is = 2·76 statute English miles.

LEAGUE, the term generally employed in the 16th and 17th centuries to designate a political alliance or coalition. The most famous leagues were those of Cambray, Schmalkald, Nürnberg, &c. But the name has a peculiar importance in the history of France, as applied to the opposition organised by the Duke of Guise (q. v.) to the granting of the free exercise of their religion and political rights to the Huguenots. This league, known as the Holy League (*Sainte Ligue*), was formed at Péronne, in 1576, for the maintenance of the Roman Catholic religion in its predominance; but the object of the Guises was rather to exclude the Protestant princes of the blood from the succession to the throne. For an account of the civil war that ensued, see **HENRY III.**, **HENRY IV.**, and **GUISE**.—See Mignet, *Histoire de la Ligue* (5 vols. Par. 1829).

LEAKE, WILLIAM MARTIN, a lieutenant-colonel in the British army, and a traveller who has contributed much to our knowledge of the ancient and modern geography, history, and antiquities of Greece. He was born in 1777, and died January 6, 1860. With remarkable critical acuteness and soundness of judgment, he combined great learning and an admirable power of clear statement. His principal works, containing the matured fruit of his observations and studies, are—*Researches in Greece*, &c. (1814); *The Topography of Athens*, &c. (1821); *Journal of a Tour in Asia Minor, with Comparative Remarks on the Ancient and Modern Geography of that Country* (1824); *Travels in the Morea* (1830); *Travels in Northern Greece* (1835); and *Numismatica Hellenica* (1854).

LEAMINGTON, a fashionable watering-place in the county of Warwick, England, and one of the handsomest towns in the country, is beautifully situated on the Leam, a tributary of the Avon, about two miles from Warwick. It contains public gardens, a proprietary college, erected in 1847 in the Tudor style, and other institutions. In the centre of the town is a Pump Room, a handsome structure. L. is wholly of modern growth, having become important only within the present century. Its mineral waters are saline, sulphureous, and chalybeate. The watering-season lasts from October till May. The town stands in the centre of a fine hunting-country, and is much-resorted to by lovers of the chase. Pop. (1861) 17,958.

LEAP-YEAR, a year of 366 days (see **CALENDAR**), so called because it leaps forward a day as compared with an ordinary year. It so happens that the leap-years coincide with the years that are divisible by four, and thus they may be known. Of the years concluding centuries, only every fourth is a leap-year, beginning with 2000, which is divisible by 400, as is also 2400, &c. The term *Bissextile*, applied by the Romans to leap-year, arose from their reckoning the 6th before the Kalends of March (24th February) twice (*bis*), whereas we add a day to the end of the month, making the 29th of February.

LEASE is the contract establishing the relation between Landlord and Tenant (q. v.). If the term of years is more than three, then it must be by deed under seal in England, or by writing in Scotland, if for more than one year. An improving lease is where the lessee agrees to keep the premises in repair. A building lease is where the tenant intends to build a house on the land. See **BUILDING LEASE**, also **GROUND-RENT**.

The granting of leases to those holding land from the owners, has been general in Scotland for more than a century. To this is, no doubt, to be ascribed, to a great extent, the rapid progress which improvements in farming have made in the north within that period. The length of leases in Scotland is commonly nineteen years. Recently, in pastoral farms, where no rotation of crops is required, and no substantial improvement expected, short leases of seven or ten years have come into use. What we have to notice in particular, is the common agricultural lease of nineteen years, which forms the great base of rural prosperity. During the currency of this species of lease, the tenant has in a great measure the uncontrolled possession of the land, and this lengthened term enables him to reap the benefits of improvements or money expended. Leases on the Scotch system are now becoming more general both in England and Ireland. No doubt, holding land from year to year has wrought well in some parts of England, where large capitals are invested in the land by tenants who have no other security than the good faith and feeling between themselves and landlords. In Scotland, however, the system of leases alone meets the tastes and genius of farming. A lease should be clearly and concisely written, so that the terms may be well understood by both parties, and all disputes at its expiry avoided. The cropping clauses of leases vary with the localities. In the neighbourhood of towns, the tenant is usually allowed to sell the whole produce, including the straw, but is bound to bring back manure to make up the waste. In inland parts, on the other hand, where the selling of the straw year after year might impoverish the soil, it is customary to restrict tenants from so doing. It is also common to debar tenants from selling turnips. Both these clauses cannot be considered as any hardship to improving tenants. The raising and selling of potatoes off the land should not be restricted. In the best arable districts, tenants are often bound not to take two white crops in succession. This is, perhaps, a good enough rule to be applied to light lands, but in other cases barley might be allowed to be taken after wheat. All farmers should be allowed to grow pease to a certain extent, but not more than the twentieth part of the land under regular cultivation. The cropping clauses should be framed in accordance with the systems prevailing in the neighbourhood. Whatever these are, they should be clearly defined. No such clauses as 'farming according to the rules of good husbandry' should be allowed, as this is apt to lead to a disagreement in defining what these rules are.

The terms of entry are usually Whitsunday and Martinmas, which require very different arrangements in the terms of leases. In drawing up these, the most experienced farmers of their respective districts should be consulted, and the terms framed, as far as possible, to encourage the free application of capital to land, and at the same time to avoid the deterioration of the land at the expiry of the term.

The following are the usual clauses in an agricultural lease: viz.—1. Landlord lets lands specified for term of years, excluding assignees and subtenants. 2. Reserves mines, &c., with power to work them; power to exclaim, plant, alter and make roads, hunt, shoot and fish, cut and carry away trees, feu part of lands for building purposes, inspect farm, &c. When exercise of reservations causes surface damage, this to be paid for. 3. Clause of warrandice. 4. Assignment to obligation of previous tenant to leave premises in order. 5. Specific details as to additional houses and fences required. 6. Obligation on tenant to pay rent specified at two terms. 7. To maintain and leave fences in good repair. 8. To insure houses against damage by fire. 9. Cropping clause regulating cultivation of lands, and manner in which they are to be left; and also disposal of waygoing crop, manure, fallow-break, &c. 10. Arbitration clause for settlement of disputes. 11. Obligation to remove at expiration of lease. 12. General obligatory clause. 13. Clause of registration. And 14. Testing clause.

Every lease has its own peculiar details in reference to drainage, houses, and cropping. When a tenant enters without paying for the straw or manure, it is called 'steelbow,' and he receives no value for these when he leaves. Occasionally, rents are paid wholly or in part by the current price of grain, a quantity of grain being fixed, convertible at the average market price of the season, as determined by a jury before the sheriff in a court called the *Fiars Court*. In consequence of the preciseness in which Scotch leases are drawn up, disputes are of rare occurrence. It will, of course, be understood that such leases can only be brought into operation where landlords are able and willing to put farms thoroughly in order for the tenant, and where the tenant possesses sufficient capital to work the farm advantageously.

LEASE AND RELEASE, a name given to a conveyance of land formerly much used in England, but now superseded by a Grant.

LEASEHOLD. A leasehold estate is merely the interest or property which a man has who holds a lease; and he is also sometimes called a leaseholder. A leasehold estate is of much less value than a freehold estate, for a lease must some time or other come to an end, whereas a freehold estate is held by a man and his heirs for ever—that is, until he or they choose to part with it. See **LANDLORD AND TENANT**.

LEASH, in Falconry, the thong of leather by which a hawk is held. The word also signifies a line affixed to the collar of a greyhound, and is used in both significations in Heraldry.

LEASING-MAKING, in Scotch Law, means seditious words, which constituted an offence punishable with death by ancient statutes of 1584 and 1585. The punishment was afterwards mitigated to fine and imprisonment, or both, at the discretion of the court.

LEATHER consists essentially of the skins of animals chemically altered by the vegetable principle called Tannin, or Tannic Acid (q. v.), so as to arrest that proneness to decompose which is characteristic of soft animal substances. Its invention reaches beyond the dawn of history, and was

LEATHER.

probably among the earliest germs of civilisation; for as the skins of animals would naturally be among the first articles of clothing, any means of preserving them more effectually than by drying would be highly prized. The discovery that bark had this effect was doubtless the result of accident. The principle of its action was unknown up to the present century; and the same unvarying method had been employed from the earliest times until the last few years, when the invention of new processes has much facilitated the manufacture.

The skins of all animals used in the production of leather consist chiefly of gelatine, a substance which easily enters into chemical combination with the tannic acid found in the bark of most kinds of trees, and forms what may be termed an insoluble *tanno-gelatin*. This is the whole theory of tanning, or converting the skins of animals into leather. Formerly, oak-bark was supposed to be the only tanning material of any value; but lately, very numerous additions have been made to this branch of economic botany.

In addition to the process of tanning in making leather, there are other modes, one of which is *tawing*, another *dressing in oil*. The following are the skins which form the staple of our leather manufacture: ox, cow, calf and kip, buffalo, horse, sheep, lamb, goat, kid, deer, dog, seal, and hog.

The term *pelt* is applied to all skins before they are converted into leather. When simply made into leather in the state we find in shoe-soles, it is called 'rough leather;' but if, in addition, it is submitted to the process called currying, which will be hereafter described, it is termed 'dressed leather.'

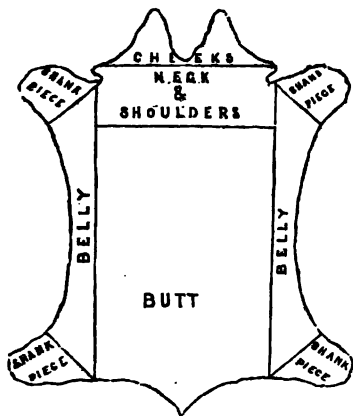

Fig. 1.

The following trade-terms are in general use: hides or crop-hides, butts and backs, bends, offal, and skins. The complete hide is seen in fig. 1. The same rounded, with the cheeks, shanks, and belly-pieces, &c., pared off, is called a *butt*; the pieces cut off constitute the *offal*; and *skins* are all the lighter forms of leather, such as sheep, goat, deer, &c.

Besides the ox and cow hides furnished by the home-trade, vast numbers are imported from Montevideo, Buenos Ayres, Russia, and Northern Germany, and a very considerable number of dry buffalo-hides are brought from the East Indies. The number of all sorts imported into Great Britain, in 1862, amounted to about two millions and a half; and the entire value of the hides and leather imported in 1861 amounted to £2,891,783. These

returns, however, comprise a considerable number of horse-hides, which are also sent from South America. Calf-skins and kip-skins (that is, the skins of beasts older than calves, but not full-grown oxen) are, when tanned, used chiefly for the upper-leather of boots and shoes.

Sheep and lamb skins are imported (in the wool) in large quantities from Australia and the Cape of Good Hope; and tanned, from our East Indian possessions. The latter, with the Cape skins, are used for bookbinding, furniture, gloves, &c. Lamb-skins are imported also from Italy, Sicily, and Spain, and tawed and dyed for making gloves, in imitation of kid. A great portion of all sorts of lambs and sheep are tawed and used for masons' aprons, sewing harness, plaister-skins, tying up bottles, lining shoes, and other jobbing and inferior purposes.

Deer-skins are dressed by the oil process, and form a great portion of the so-called *shamoy* leather, which derives its name from the chamois of the Alps, from the skin of which it was formerly made.

Dog-skins are tanned or tawed for gloves, and for thin shoes and boots. *Seal-skins* are manufactured into the so-called 'patent leather,' by varnishing their upper surface. The manufacture of this kind of leather has of late become of great importance to the London, Edinburgh, and Newcastle tanners.

Hog or pig skins are imported from Russia and other continental countries, and many are supplied by Scotland; their use is chiefly in the manufacture of saddles for horses, &c.

Walrus and hippopotamus hides are tanned in considerable numbers for the use of cutlers and other workers in steel goods, 'buffing-wheels' being made of them, often an inch thick, which are of great importance in giving the polish to metal and horn goods. Lately, belts for driving machinery have successfully been made from them.

Kangaroo-skins of various species are tanned or tawed in Australia, and form a kind of leather in great favour for gentlemen's dress-boots.

The first process in making *tanned sole leather* is to soak the skins or hides in water for a greater or less time, to wash and soften them; they are then laid in heaps for a short time, and afterwards hung in a heated room, by which means a slight putrefactive decomposition is started, and the hair becomes so loose as to be easily detached. This process of 'unhairing' is mostly followed in America; but in Great Britain, milk of lime is used for soaking the hide till the hair loosens. Hides or skins intended for dressing purposes, such as shoe, coach, harness, or bookbinding, after the hair is taken off by lime, have to be submitted to a process called 'bating,' for the purpose of reducing the thickening or swelling occasioned by the introduction of the lime, and for cleansing the skin from grease and other impurities. This is effected by working the skins in a decoction of pigeons' or dogs' dung and warm water, and no dressing-leather is ever submitted to bark or shumac without undergoing this process.

If the old method of *tanning* is followed, the hides, after unhairing, are placed in the tan-pits, with layers of oak-bark or other tanning materials between them; and when as many layers of hides and bark are arranged as the pit will hold, water is let in, and the hides remain to be acted upon by the tanning material for months, and even in some cases for years, being only occasionally turned. But this primitive process is now rarely carried out; so much improvement has been effected in the tanner's art since its chemical principles were discovered,

LEATHER.

that much less time suffices; and materials are now used which act so much more quickly than oak-bark alone, that even if the old process is used, it is greatly accelerated. The most useful of these materials are catechu and cutch (of which 9000 tons are annually imported into Great Britain from India and Singapore), gambier (about 1200 tons, from Singapore), divi-divi (3000 tons, from Maracaibo, &c.), valonia (the acorns of the *Quercus Ægyptos*, 23,000 tons of which are yearly imported from Turkey), and sumach leaves (20,000 tons, chiefly from Turkey).

The first attempts at improvement in tanning were the method invented by Mr Spilsbury in 1823, and the improvement on this method by Mr Drake, of Bedfordshire, in 1831. The principle consisted in causing the *ooze* or *tan-liquor* to filter through the hides under pressure. For this purpose, in Drake's process, the edges of the hides were sewed up so as to form a bag. The bags being suspended, were filled with cold tan-liquor, which gradually filtered through the pores of the hides, and impregnated them with the tannin. The processes by infiltration, however, have been entirely abandoned for heavy leather, as they have the effect of rendering the leather porous and deficient in firmness.

Various patents for improvements in tanning have been in operation of late years. Herepath and Cox, of Bristol, tied hides to each other to form a long belt, and pressed them between rollers, to squeeze out the partially exhausted tan-liquor from the pores, so that a stronger liquor might be absorbed. Messrs J. and G. Cox, of Gorgie Mills, near Edinburgh, made an improvement on this mode, by attaching the hides to a revolving drum, so that the hides press on each other on the top of the drum, but hang suspended in the tan-liquor from the lower part; and thus, by the hides being alternately in and out of the liquor, the tanning is quickly effected.

After the hides have become thoroughly tanned in the pit by the action of the tannic acid upon their gelatinous substance, and when partly dried (if for 'struck' sole-leather), they are operated upon by a two-handled tool with three blunt edges, called a pin (fig. 2, and section, a), which, by being



Fig. 2.

rubbed with great pressure backwards and forwards on the grain-side of the leather, makes it more and more compact; and this is still further accomplished by submitting the leather to the action of a heavily loaded brass roller.

The tanning of goat-skins (from which our morocco is made), sheep for imitation-morocco, and small calf-skins for bookbinding, is done by sewing up the skins, and filling the bag with a decoction of shumac in a warm state. They are kept in an active state for twenty-four hours or so, which sufficiently saturates them.

A process has been patented by Mr Preller, of Bermondsey, within the last ten years, by which the heaviest skins are converted into leather in a very short space of time; but the process is tawing rather than tanning, and is used for machinery-belts principally.

Tawing consists in dressing the skins with anti-septic materials, so as to preserve them from decay; but by this operation no chemical change is effected in the gelatine of the skins; hence, tawed leather

can be used in the manufacture of glue. In tawing, the first process is careful washing, next dressing them with lime, then removing the hair or wool, and lastly, steeping them in some one or more of the various mixtures which are used for converting skins into leather by this method. The method of tawing lamb-skins will give a fair idea of the process, which is, however, much varied, according to the kind of skin and the experience of the worker. Lamb-skins of home-production are generally limed on the flesh-side with cream of lime, which enables the wool to be easily pulled off. Dried lamb-skins are generally submitted to the *heating process*, to get the wool removed. The pelts, after being washed, are rubbed on the convex piece of wood called the *beam*; and when supple, the flesh-side of each skin is thickly besmeared with a cream of lime; and when two are so treated, they are laid with the limed surfaces in contact; and a pile of them being made, they are left for a few days, when they are examined by pulling the hair. If it separates easily, then the lime is washed out, and the hair is removed with the unhairing knife (fig. 3), as in the case of hides,

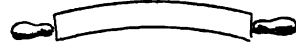

Fig. 3.

unless it is required to be kept on, as in the case of skins for door-mats, &c. After thorough cleansing, the pelts are steeped for two or three weeks in a pit filled with water and lime, being taken out from time to time, and drained on sloping benches. When removed finally from the lime-pit, the skins are worked with the knife, to render them still more supple, and they are then put into the *branning* mixture. This consists of bran and water, in the proportion of two pounds of bran to a gallon of water. From this mixture, in about two days, they are transferred to another bath, consisting of water, alum, and salt. After the proper amount of working in this mixture, they undergo what is called the *pasting*, if intended to form white leather. The *paste* is a mixture of wheaten-bran and sometimes flour and the yolks of eggs. They are usually worked in a rotating cylinder with this paste and water, and are found in time to have absorbed the paste, leaving little more than the water. If the skins are not intended to be white, other materials are often used, and much pigeons' and dogs' dung is employed, some large leather-dressers expending as much as £100 per annum upon each of these materials. Lastly, the skins are dried and examined, and, if necessary, the pasting is repeated; if not, they are dipped into pure water and worked or staked by pulling them backwards and forwards on what is called a *stretching* or *softening* iron, and smoothed with a hot smoothing-iron.

Another kind of dressing is by treating the skin with oil. By hard rubbing with cod oil, or by the action of 'stocks,' after the skin has been properly cleaned with the lime, the oil works into the skin, displaces all the water, and becomes united with the material, rendering its texture peculiarly soft and spongy. Wash-leather or chamois-leather is so prepared, and for this purpose the flesh-halves of split sheep-skins are chiefly used.

Besides *tanning* and *tawing*, many kinds of leather require the currier's art to bring them to the state of completion required for various purposes. The currier receives the newly tanned skins, and finds them harsh to the feel, and rough on the flesh-side. He removes all the roughness by carefully shaving with a peculiar knife. After a soaking in clean water, he then scrapes the skin with considerable

pressure upon a scraping-tool or *slicker*, and thus removes any irregularities. The moisture is then removed as much as possible, and oil, usually cod-oil and tallow, are rubbed over the leather, which is laid aside to dry completely, and as the moisture leaves it, the oil penetrates. When quite dried and saturated with the oil, the skin is rubbed on a board with rounded ridges, by which a peculiar grained appearance is given, and the leather is rendered very pliable. In currying, almost every variety of leather requires some variation in the processes employed, but the currier's object is in all cases to give a suppleness and fine finish to the skins.

Morocco leather, formerly an article of import from the Barbary coast, is now prepared in large quantities in this country, from goat-skins; sheep-skins also are used for imitation. It is always dyed on the outer or grain side with some colour, and the leather-dresser in finishing gives a peculiar ribbed or a roughly granulated surface to it, by means of engraved boxwood balls which he works over the surface.

Russia leather is much valued for its aromatic odour, which it derives from the peculiar oil of the birch-bark used in tanning it. The fact that this odour repels moths and other insects, renders this leather particularly valuable for binding books; a few books in a library, bound in Russia leather, being effective safeguards against insect enemies. It is also said to destroy or prevent the vegetable evil called mildew, to which books are so very liable.

LEATHER, VEGETABLE, is a composition, the base of which is supposed to be oxidised oil. It is spread over cotton or other cloth, and is used as a water-proof material for carriage-hoods, seats, gaiters, boots, &c. At present, it is only made by one company, which holds the secret of its manufacture.

LEATHERWOOD (*Dirca palustris*), a deciduous shrub of 3–6 feet high, with the habit of a miniature tree, a native of North America. It belongs to the natural order *Thymelaeaceae*. The bark and wood are exceedingly tough, and in Canada the bark is used for ropes, baskets, &c. The leaves are lanceolate-oblong; the flowers are yellow, and appear before the leaves.

LEAVE AND LICENCE, a phrase in English law to denote that leave or permission was given to do some act complained of. It is a common defence in actions of trespass.

LEAVEN, 'sour' dough, or dough in which putrefaction has begun, and which, owing to the presence and rapid growth or multiplication of the yeast-plant, quickly communicates its character to fresh dough with which it is mingled, causing the process of fermentation to take place sooner than it otherwise would. The use of leaven in baking dates from a very remote antiquity; the employment of yeast is more recent. See **YEAST** and **BREAD**.

LEAVENWORTH, a city of Kansas, United States of America, founded in 1854, on the right bank of the Missouri River, 25 miles above Kansas City. It is a handsome town, of broad avenues, lighted with gas, with 12 churches, 8 banks, 11 hotels, 3 daily, and 5 weekly papers, one of which is German, and one French, with large mills and factories. This is the head-quarters of the government contractors for trains across the plains to Utah, New Mexico, &c., who employ 6000 teamsters, and 45,000 oxen. Pop. (1860) 7429.

LEAVES (*folia*) are organs of plants, springing from the sides of the stem or branches, generally more or less flat and green, never bearing flowers, and of great use in the vegetable economy, as

exposing the sap to air and light on their extensive surfaces. It is usually in the Axils (q. v.) of leaves that buds and branches are developed; and with reference to buds and branches, they are never situated otherwise than beneath them, although in the axils of many leaves no development of bud or branch ever takes place. After its full development, a leaf retains its form and size unchanged till its death. As to the duration of their life, leaves exist either for one year—that is, during a year's period of active vegetation—in which case they are called *Deciduous* (q. v.), or for more than one year, when they are called *Evergreen* (q. v.).

A leaf first appears as a little conical body pushed out from the stem or branch. At first, it consists entirely of cellular tissue, continuous with the bark, but vascular tissue afterwards generally appears in it. When fully developed, it usually consists of two parts: an expanded part, called the *blade* or *limb*; and a stalk supporting this part, and called the *leaf-stalk*, or *petiole*, which sometimes assumes the form of a *sheath* of the stem, as in grasses. The leaf-stalk, however, is often wanting, in which case the leaf is called *sessile*; and when the base of the leaf embraces the stem, it is called *amplexicaul*. A leaf which has a leaf-stalk is called *petiolate*. Sessile leaves often extend in wing-like prolongations down the stem, and are then called *decurrent*. They are sometimes *perfoliate*, entirely surrounding the stem with their base, so that it seems to pass through the leaf. Opposite leaves are sometimes combined in this way. Leaves are called *simple*, when all their parts are united into one whole by a connected cellular tissue; they are called *compound*, when they consist of a number of distinct, completely separated parts, which are called *leaflets*.—As to the place where leaves arise from the stem, they are either *radical* (root-leaves), when they arise from the very base—and many plants have radical leaves only; or *cauline* (stem-leaves), when they arise from the *developed* stem or branches—the radical leaves really arising from the stem; or *floral*, when they arise from the flowering axis.—As to their arrangement on the stem, leaves are *verticillate*, or *whorled*, or *opposite*, or *alternate*, or *scattered*. Opposite leaves are usually placed so that each pair is at right angles to those next above and below. All these modes of arrangement on the stem can be reduced either to the *whorl* or to the *spiral*; whilst by the tearing out of the whorl, the spiral arrangement arises, and the whorl by the compression of the spiral, but so that the whorl and the spiral are essentially the same. The number of leaves requisite to form a complete *cycle*, or to encircle the stem, is very constant in the same species. In the Common Houseleek, the cycle consists of no fewer than thirteen leaves, which are grouped together to form the *rosette* of this plant.

Leaves consist either exclusively of cellular tissue, as in mosses, or, more generally, of cells and bundles of spiral vessels, as in the leaves of trees and most other phanerogamous plants. The stronger bundles of vessels form *nerves*, externally conspicuous, the finer ramifications of which are called *veins*. In endogenous plants, the nerves of the leaves run mostly in straight lines, and nearly parallel; whereas, in exogenous plants, a net-like ramification of the nerves prevails.

The leaves of phanerogamous plants and ferns are covered with a well-developed separable *epidermis*, which extends over all their parts, and which is provided with numerous small pores—*Stomata* (q. v.)—sometimes on one, sometimes on both sides, serving for the absorption and exhalation of gaseous substances. Submerged leaves, however, and the under side of leaves which float on the surface of

LEAVES.

water, have no stomata, no true epidermis, and no true vascular tissue.

Some plants have no leaves, their functions being performed by the green juicy rind of the stalks, as in *Cactaceæ* and some of the genus *Euphorbia*; or by the general surface of the Thallus (q. v.) in many acrogenous plants.

It is in the leaves of plants that the elaboration of the sap chiefly takes place, and when a tree is deprived of its leaves, no wood is formed until they are again developed. The incessant removal of leaves as they are formed destroys a plant, and this method is sometimes advantageously adopted as to weeds having deep or spreading perennial roots, and otherwise difficult of extirpation.

Leaves exhibit more or less decidedly a periodical alternation in their direction and expansion, generally corresponding with the alternation of day and night. Some leaves exhibit a peculiar irritability under various influences, and those of two or three

species of plants, by their closing together, catch and kill insects which alight on them, a thing, however, of which no relation to the vegetable economy is known. See IRRITABILITY IN PLANTS, SLEEP OF PLANTS, and DIONÆA.

The forms of leaves are extremely various. *Simple* leaves vary from a form almost perfectly circular, or even broader than long, to an extreme elongation, as *linear* or *filiform* (thread-like). The breadth of some increases towards the apex, and this is indicated by the terms *obovate*, *obcordate*, &c., and sometimes by the word *inversely* prefixed to the term which describes the form. Simple leaves are either *entire*, or they are more or less deeply *toothed* or *serrate*; or they are *cut* or *lobed* by divisions extending from the margin towards the base; or the division may extend towards the midrib of the leaf, when the leaf is *pinnatifid*, or *sinuate*, or *runcinate*, &c. The accompanying figure exhibits some of the forms of leaves, and explains more



Forms of Leaves:

1, cordate; 2, ovate; 3, lanceolate; 4, hastate; 5, sagittate; 6, linear; 7, subulate; 8, pectinate; 9, lyrate; 10, digitate; 11, palmate, or quinate; 12, ternate; 13, impari-pinnate; 14, sinuate; 15, runcinate.

briefly than words could, some of the terms used in describing them. Similar terms are employed as to the leaflets of compound leaves, but the variety of forms is not nearly so great. Compound leaves exhibit two chief varieties of form, according as the divisions which form the leaflets extend towards the base of the blade, or towards the

midrib. Of the former class are *ternate*, *quaternate*, *quinate* leaves, &c.; the latter are called *pinnate* leaves. But the same mode of division may be repeated in the leaflets, and thus a leaf may be *biternate*, or, if again divided, *triternate*, &c., and very many leaves are *bipinnate*, *tripinnate*, &c. When the division is often repeated, the leaf is

called *decompound*. A pinnate leaf, terminating in a pair of leaflets, is called *pari-pinnate*, or *abruptly pinnate*; but a pinnate leaf very often terminates in an odd leaflet, and is then called *impari-pinnate*. The blade of a leaf is generally in the same plane with the stalk, but is sometimes at right angles to it, as in *orbicular* and *peltate* leaves.

The *Vernation* (q. v.) of leaves, or the manner in which they are folded in bud, is, like the *activation* of flowers, very characteristic of different plants and tribes of plants.

Root-leaves are generally larger than *stem-leaves*, but are only present in herbaceous plants, and are generally the first to fade. The upper stem-leaves are generally smaller and less divided than the lower, those nearest the flowers often passing into bracts. By metamorphosis of leaves, all bracts, involucre, &c., are produced, and all the different parts of flowers, as calyx, corolla, stamens, carpels, and therefore even fruits; and the mode of their arrangement relatively to the axis corresponds with that of leaves. All organs formed by metamorphosis of leaves are called *leaf-organs*. See MORPHOLOGY.

Seed-leaves are the cotyledons of the seed, raised above ground after germination, and serving the purposes of leaves to the young plant, although generally very unlike its future leaves. This, however, only takes place in some plants.

LEBANON MOUNT, or JEBEL LIBNAN, the western and higher of two mountain-chains which run through Syria from north to south parallel with the coast of the Levant. Its average height is about 7000 feet, but its loftiest peak, Dahrel-Khotib, in the range called Jebel Makmel, attains an elevation of 10,050 feet. For six months of the year, this mountain is covered with snow. The next highest point is Jebel Sunnin, 8555 feet. The road from Baalbek to Tripoli crosses L. at an elevation of 7330 feet. From the western side of the range, several spurs strike off across the narrow strip of level coast, and project upon the Levant in bold promontories. In the south are the sources of the Jordan, the most important river that rises in Lebanon; not far from Dahrel-Khotib, those of the Orontes, the next largest stream, which flows northward, and intersects the chain at Antaki (*Antioch*). L. derives its name, not from the snow that whitens its peaks, but from its chalk cliffs. The vegetation of L. is, on the whole, scanty; here and there, woods and willow-groves are seen; the lower parts of the mountains, however, are everywhere well watered and cultivated, and the valleys are often covered with orchards, vineyards, olive and mulberry plantations, and cornfields. The habitable districts are mostly in the possession of Maronites (q. v.) and Druses (q. v.). Everywhere the range of L. is wild and solitary; the only sound that falls upon the ear of the traveller is the scream of the eagle. Numerous monasteries offer comfortable accommodation to the weary traveller at the close of almost every day's wanderings. The once famous Cedars of L. have almost disappeared; only a solitary grove remains. See CEDAR OF LEBANON.

ANTI-LEBANON, or *Jebel-esh-Sherki*, lies east of the preceding; the range is less compact, and its average height inferior. The great plain between the two is known as Coele-Syria (q. v.). Anti-Lebanon terminates southwards in Mount Hermon, its highest point, which reaches an elevation of 8376 feet. Its sides are clothed with green poplar-trees, but it has no cedars. On its table-lands are found numerous little lochs or tarns, which are a characteristic feature of this range, and distinguish it from Mount Lebanon.

LEBEDIA'N, a district town of Great Russia, in the government of Tambov, 100 miles west-north-west of the city of that name, on the Don, in lat. 53° N. It has two annual fairs, the commercial transactions of which realise £700,000. One of the chief articles of sale is horses; and government officers frequent the fairs of L., in order to furnish horses for the cavalry regiments.

LEBEDI'N, a town of Little Russia, in the government of Kharkov, 90 miles north-west of the town of that name, in lat. 50° 38' N., long. 34° 30' E. It was founded in the 17th century. Pop. 13,377, who manufacture girdles and sashes to the value of many thousand roubles. These articles, which are worn by the Russian peasants, are sent for sale to Moscow, and to the fairs of Nijni-Novgorod, Kurak, &c.

LEBRUN, CHARLES, a French painter, born at Paris, March 22, 1619, studied in the school of Vouet, and afterwards at Rome, under Poussin, for six years, returning to France in 1648. He became principal court-painter to Louis XIV., and died at Paris, February 12, 1690. L.'s best works are a series of pictures representing the battles of Alexander, which were felicitously engraved by Gérard Audran. L. belongs to the classical and artificial school, but he is a very favourable specimen of it.

LE'CCO, the chief town of a district of the same name in the province of Terra di Otranto, in Southern Italy, 10 miles from the Adriatic, and 25 south-south-east of Brindisi, has a population of 19,400. It is the Lupice of the ancient Salentines, the name having become Lycia in the middle ages, and hence Lecce. It contains fine churches and public edifices, the architecture of which is much enhanced by the beauty of the fine white stone found in abundance in the neighbourhood, which admits of exquisitely minute cutting. L. has a large trade in olive-oil.

LECO'MPTON, the capital of Kansas, United States of America, is situated on Kansas River, 60 miles from its mouth at Kansas City. It contains the state capitol, United States Land Office, and other government buildings. Pop. about 1000.

LE'CTERN, or LETERN (Lat. *lectorium* or *lectricium*), a reading-deak or stand, properly movable, from which the Scripture *lessons* (*lectiones*), which form portion of the various church-services, are chanted or read. The lectern is of very ancient use, of various forms, and of different materials. It is found both in Roman Catholic churches and in the cathedrals and college-chapels of the Church of England. The most ancient lecterns are of wood, a beautiful example of which is that of Ramsey Church, Huntingdonshire (about 1450), represented in the wood-cut; but they were frequently also made of brass, and sometimes in the form of an eagle (the symbol of St John the Evangelist), the outspread wings of which form the frame



Lectern.

supporting the volume.—In some parts of the east of Scotland, the preceptor's desk in the Presbyterian churches is called the *lettran*.

LECYTHIDA'CEÆ, a natural order of exogenous plants, or sub-order of *Myrtaceæ*, the distinguishing characteristic being that the fruit is a large woody capsule, with a number of cells, which in some species remains closed, and in some opens with a lid. All the known species, about forty, are natives of the hottest parts of South America. All are large trees. They have alternate leaves, and large showy flowers, solitary, or in racemes. The stamens are numerous, and a portion of them sometimes connected into a kind of petal-like hood. Brazil Nuts (q. v.) and Sapucaia Nuts (q. v.) are the seeds of trees of this order. The Cannon-ball Tree (q. v.) belongs to it. The capsules of some species are known as *monkey-pots*. Monkeys are very fond of the seeds.

LE'DA, in Grecian Mythology, the wife of the Spartan king Tyndareus, whom Jupiter visited one night in the disguise of a swan. She became by the god the mother of Castor and Pollux, and after her death, was raised to a divinity under the name of Nemesis. The story has supplied a theme for many works of art.

LE'DBURY, a small town of England, in the county of Hereford, is situated fourteen miles east-south-east of the city of that name, on the Hereford and Gloucester canal. Glove-making is the principal branch of industry. Pop. (1861) 3263.

LEDGER-LINE, a kind of tackle used in fishing. It consists of a bullet or piece of lead with a hole through the centre; through which a gut-line is threaded, having at the end of it a hook. About 18 or 20 inches above the hook, a shot or bead is fastened firmly to the line, to prevent the lead from slipping down the line nearer to the hook. The hook being baited, the tackle is then cast into the water. The lead rests on the bottom, and the line is kept tight, but without lifting the lead off the bottom. The moment a fish bites at the bait, it is felt by the angler, who immediately gives a strong pull or strike. This method of fishing is used chiefly for barbel or bream.

LEDRU-ROLLIN, ALEXANDRE AUGUSTE, a noted French democrat, was born in Paris in 1808, and studied for the bar, to which he was admitted in 1830. He was counsel for the defence in most of the prosecutions of opposition journals during the reign of Louis Philippe, and obtained a great reputation for eloquence among the lower orders. In 1841, he was elected deputy by the department of Sarthe, and became a prominent member of the extreme Left. In 1846, he published a Socialistic manifesto, entitled *Appel aux Travailleurs*, in which he declared 'universal suffrage' to be the only panacea for the miseries of the working-classes. He was also an ardent, or even a violent promoter of the reform-meetings that preceded the crash of 1848. On the outbreak of the revolution, he opposed the proposal of a regency, advocated the formation of a Provisional Government, and when this was carried out, was intrusted with the portfolio of the Interior. He was afterwards one of the committee of five in whose hands the National Assembly placed the interim government of the country. In this high position, he shewed great want of perception, firmness, and energy. In consequence of the insurrection of June 1848, he ceased to hold office, and then sought to recover (what he had lost by accepting office) his influence with the extreme democrats. He partially succeeded in his attempt, and even ventured on a candidature for the presidency, but obtained only 370,119

votes. The unsuccessful *émeute* of June 1849 put an end to L.-R.'s political rôle in France. He fled to England, and in less than a year politely published a work against the land which had given him an asylum, *De la Décadence de l'Angleterre* (2 vols. Par. 1850). He has also written a great many pamphlets, treatises, letters, &c., which do not possess any permanent interest.

LE'DUM, a genus of plants, of the natural order *Ericaceæ*, sub-order *Rhodoreæ*, consisting of small ever-green shrubs, with comparatively large flowers, of which the corolla is cut into five deep petal-like segments. The species are natives of Europe and North America; some of them are common to both. The leaves of *L. latifolium* are said to be used in Labrador as a substitute for tea, whence it is sometimes called **LABRADOR TEA**. Sir John Franklin and his party, in the arctic expedition of 1819—1822, used in the same way the *Ledum palustre*, which produced a beverage with a smell resembling rhubarb, yet they found it refreshing. The leaves of both these shrubs possess narcotic properties, and render beer heady. They are regarded as useful in agues, dysentery, and diarrhoea.

LEE, or **LEEWARD**, a nautical term for the quarter to which the wind is directed, as distinguished from *windward*, or the part *whence* the wind comes.

LEE, the name of a distinguished Virginian family. Their ancestor, **RICHARD LEE**, emigrated with a numerous household to America, in the reign of King Charles I, and settled in the country lying between the Rappahannock and Potomac rivers. He was a bold royalist, and during the Protectorate of Cromwell, was mainly instrumental in inducing the colony of Virginia to assume a semi-independent attitude.—**RICHARD HENRY LEE**, great-grandson of the preceding, and the most illustrious member of the family, was born at Stratford, in Virginia, January 20, 1732. He was educated first at home, and afterwards in England. He did not come prominently before his countrymen till after the British parliament had passed (1764) the act declaring its right to tax the colonies, and also the Stamp Act (1765), when he immediately became the centre of an active opposition among the colonists, associated himself with Patrick Henry (q. v.), and drew up most of the 'resolutions' of the period. He was sent as a delegate from Virginia to the first American Congress, which met at Philadelphia (September 5, 1774), and at once became a leader in the assembly. He wrote most of those addresses to the king, the people of England, and the colonies, which compelled the great Chatham to admit, that 'for solidity of reasoning, force of sagacity, and wisdom of conclusion, under such complication of circumstances, no nation or body of men can stand in preference to the general congress at Philadelphia.' When war between the mother-country and the colonies became inevitable, Lee was placed on the committees charged with preparing the munitions of war, and with devising all other means of offering a vigorous resistance to the British government. His labours at this time were enormous. On the 7th of June 1776, Lee made the most celebrated (and important) of all his speeches, when introducing before the congress of Philadelphia a measure declaring the 'united colonies' to be 'free and independent states,' and 'absolved from all allegiance to the British crown.' During the war of independence, he was—in spite of ill-health—one of the most active of the patriotic party, chiefly, however, as a civilian. In 1784, he was elected president of congress, and when the federal constitution was established, he entered the senate for Virginia.

Towards the close of his career, he became a decided federalist, although originally he had viewed that system of government with great suspicion, as tending towards a despotic centralisation of power. In 1792, he retired from public affairs, and died in his native state, June 19, 1794. His *Life and Correspondence* was published by his great-grandson, R. H. Lee (2 vols. Philadelphia, 1825).—LEE, ARTHUR, youngest brother of the preceding, was born in Virginia, December 20, 1740. He was educated at Eton, then studied medicine at Edinburgh, and after travelling on the continent for some time, returned to America, and started as a physician. Circumstances, however, soon drew him into the field of politics; he returned to England, advocated the rights of the colonies in the English newspapers, and in 1776, took up his residence at Paris, as the secret agent of the American congress. In this capacity, he was busily employed during the whole struggle, and conducted his business on the continent greatly to the advantage of the colonists. He died December 12, 1792. Lee, like his brother, was an admirable scholar and writer, enjoyed the friendship of some of the most eminent men of his time, Burke, Wyndham, Sir William Jones, the Abbé Raynal, and the Duke de Rochefoucauld. See *Life and Correspondence*, by R. H. Lee (2 vols. Boston, 1829).—LEE, HENRY, a distinguished American general, whose father was cousin of the preceding, was born in Virginia, January 29, 1756. He was one of the most daring, vigilant, and successful cavalry officers on the side of the colonists. 'Lee's Legion' was probably the most effective and courageous body of troops raised in America. In the famous retreat of Greene before Lord Cornwallis, it formed the rear-guard, the post of honour, and covered itself with glory. At the battles of Guilford Court House and Eutaw, at the sieges of Forts Watson, Motte, and Granby and Augusta, and at the storming of Fort Grierson, Lee particularly signalled himself. After the war, he was sent to congress as a delegate from Virginia, advocated the adoption of a federal constitution, and in 1792, was chosen governor of Virginia. In 1809, he published a valuable work, entitled *Memoirs of the War in the Southern Department of the United States*. He died at Cumberland Island, Georgia, March 25, 1816.—LEE, ROBERT E., General and Commander-in-chief of the army of the Confederate States of America, is a son of the preceding, and was born in Virginia about 1810. He was educated at the military academy of West Point, entered the army of the United States, served as captain of engineers under General Scott in the war with Mexico, was raised to the rank of lieutenant-colonel, and brevetted colonel for distinguished services. He was employed in the office of the commander-in-chief at Washington when Virginia seceded from the Union, April 1861, when he resigned his commission, and was appointed commander-in-chief of the forces of Virginia. When that state entered the Confederacy, he was appointed to its highest military rank of general, and though not the senior, was selected by President Davis as commander-in-chief. In July 1862, he defended Richmond against the Federal army under General McClellan, and after six days of sanguinary battles, drove him to the shelter of his gun-boats. Marching north, he defeated General Pope, August 29, in the second battle of Manassas. Crossing the Potomac into Maryland, with a force of 40,000, he was met at Antietam by General McClellan with 80,000, and after a bloody but indecisive conflict, September 17, recrossed the Potomac, and took a position at Fredericksburg, on the Rappahannock, where, December 13, he was attacked by General Burnside, whose army he defeated with great slaughter.

General Hooker, the successor of Generals McClellan, Pope, and Burnside, whom Lee had successively defeated, crossed the Rappahannock, May 1, 1863, and was attacked by General Lee on the 2d and 3d, routed with heavy loss, and compelled to escape in the night across the river. More recently, he has carried the war into the northern states, but with what result remains to be decided. General Lee married the adopted granddaughter and heiress of Washington, by whom he has five sons, all soldiers in the Confederate service—one a general, another a colonel, and the youngest, a boy of 18, a private artillery volunteer in the army under his father's command.

LEE, SAMUEL, D.D., an English orientalist and linguist, was born, 14th May 1783, at Longnor, in Shropshire, studied at Queen's College, Cambridge, and took his degree of B.A. in 1817. Two years after, he was chosen Arabic Professor in the same university, obtained the degree of D.D. from Halle (unsolicited) in 1822, and from Cambridge in 1833, was appointed Regius Professor of Hebrew in 1831, and died rector of Barley, in Hertfordshire, 16th December 1852. His *Grammar of the Hebrew Language* (2d ed. Lond. 1831), his *Book of Job, translated from the Original Hebrew* (3 vols. Lond. 1837), his *Hebrew, Chaldaic, and English Lexicon* (Lond. 1840), his translation from the Arabic of the *Travels of Ibn-Batuta* (Lond. 1833), have secured for him a very high reputation. His *Sermons on the Study of the Holy Scriptures* (1830), and *Events and Times of the Visions of Daniel and St John* (Lond. 1851), are also highly esteemed. He took charge, for the British and Foreign Bible Society, of editions of the Syriac Old Testament, and of the Syriac New Testament, or Peshito, of the Malay, Persian, and Hindustani Bibles, and of the Psalms in Coptic and Arabic.

LEE, FREDERIC RICHARD, R.A., an English landscape painter, born at Barnstaple, in Devonshire, about the close of last century, and first exhibited at the Royal Academy in 1824. He became an A.R.A. in 1834, and an R.A. in 1838. Lee is one of the most thoroughly national painters of his day, the characteristic scenery of his native country, its quiet river-banks, its parks, its leafy lanes, and its picturesque villages, forming the favourite subjects of his pencil. Among his best known and most admired pictures are 'The Broken Bridge,' 'The Mill,' 'The Watering-place,' 'The Fisherman's Haunt,' 'The Silver Pool,' 'The Ploughed Field,' 'A Devonshire Village,' 'A Village Green,' 'Cover Side,' 'Harvest Field,' 'A Devonshire Lane,' 'Penshurst Avenue,' 'Avenue in Shobrook Park.' Among his latest works are 'The Bay of Biscay,' 'Plymouth Breakwater,' 'View of Gibraltar from the Sands.' In 1848, he began to paint a series of works along with S. Cooper, the cattle-painter—the former executing the landscape, and the latter the animals.

LEECH, JOHN, an English artist, was born in London in 1817, and received his education at the Charter-house. The reputation of this artist is almost entirely associated with *Punch*, to which, beginning about 1840, he contributed thousands of humorous sketches. These sketches are frequently as full of grace as of humour; the drawing is often excellent; and his female faces have a quiet, healthful beauty, which would be attractive in the ball-room, but more attractive by the fireside and with children on the knee. In the *Punch* sketches, he has satirised keenly, yet on the whole humanely, the vagaries of male and female attire, the precocity of the young, the pomp of Paterfamilias, the pride of domestic servants, and the singular relations

LEECH.

which sometimes subsist between the parlour and the kitchen. To the future historian of the Victorian era, these hasty sketches will be invaluable.

A collection of L.'s best contributions to *Punch* has been published separately, in several series, under the title of *Pictures of Life and Character*; also a volume of *Pencilings from Punch*. He died November 1864.

LEECH (*Hirudo*), a Linnæan genus of *Annelida*, of the order *Suctorio*, now forming the family *Hirudinidae*, and divided into a number of genera, some of which contain many species. They are mostly inhabitants of fresh waters, although some live among grass, &c., in moist places, and some are marine. They are most common in warm climates. The body is soft, and composed of rings like that of the earthworm, but not furnished with bristles to aid in progression, as in the earthworm; instead of which, a sucking disk at each extremity enables the leech to avail itself of its power of elongating and shortening its body, in order to pretty rapid

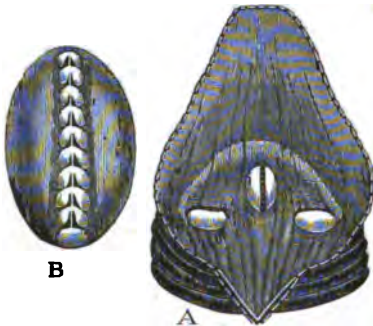

A, mouth of the Medicinal Leech (magnified), showing the position of the teeth; B, one of the teeth on a larger scale, showing the serrated edge.

locomotion. The mouth is in the anterior sucking disk. The mouth of many of the species, as of the common medicinal leeches, is admirably adapted not only for killing and eating the minute aquatic animals which constitute their ordinary food, but for making little wounds in the higher animals, when opportunity occurs, through which blood may be sucked. The mouth of the medicinal leech has three small white hard teeth, minutely serrated along the edges, and curved so as to form little semicircular saws, provided with muscles powerful enough to work them with great effect, and to produce a triradiate wound. The stomach is very large, and is divided into compartments, some of which have large lateral caeca; and a leech which has once gorged itself with blood retains a store for a very long time, little changed, in these receptacles, whilst the digestive process slowly goes on. The circulating system consists of four great pulsating trunks, one dorsal, one ventral, and two lateral, with their branches; there is no heart. The aëration of the blood takes place by numerous small apertures on the ventral surface, leading into respiratory sacs. Leeches are oviparous, and each individual is androgynous. They have small eyes—in the medicinal leeches ten—appearing as black spots near the mouth, and of the most simple structure. Leeches frequently change their skin; and one cause of the great mortality so often experienced among leeches kept for medicinal use, is the want of aquatic plants in the vessels containing them, among which to rub themselves for aid in this process, and for getting quit of the slime which their skins exude. Leech aquaria in which aquatic plants grow, are

therefore much more favourable for the health of leeches than the tanks and vessels formerly in use.

—The MEDICINAL L. (*H. medicinalis* or *Sanguisuga officinalis*) is a rare native of Britain; but leech-gathering is the occupation of some poor persons, particularly in Cumberland. Leeches, however, are generally imported from Hamburg and from the south of Europe. The collecting of leeches gives employment to many persons in some parts of Europe; and leech-gatherers sometimes adopt the simple mode of wading into the water, and seizing the leeches which attach themselves to their bare legs. Pieces of liver, &c., are sometimes used for baits, and a kind of net is sometimes used. Some parts of Europe are supplied from more eastern regions. Slight differences have led to the establishment of two species—one more northern, and one more southern—among those commonly imported into Britain. The more northern—which is that above named—has the belly spotted with black; the more southern (*H. provincialis*, or *Sanguisuga medicinalis* or *meridionalis*) has the belly unspotted. Other species are used for the same medicinal purpose of blood-sucking in other parts of the world. The ancients were well acquainted with leeches, but their medicinal use seems to have originated in the middle ages. Many millions of leeches are annually imported into Britain.—The HORSE-LEECH (*Hæmopsis sanguisorba*) is common in Britain; it is much larger than the medicinal species, but its teeth are comparatively blunt, and it is little of a blood-sucker—notwithstanding the popular notion—and useless for medicinal purposes. It feeds greedily on earthworms, which issue from the banks of the ponds or sluggish streams which it inhabits.—In many parts

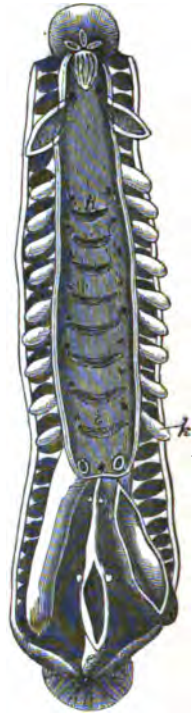

The Digestive Apparatus of the Medicinal Leech:

st, the stomach; l, lateral caeca; e, intestine.



Horse Leech.

of India, as in the warm valleys of the Himalaya, the moist grass swarms with leeches, some of them very small, but very troublesome to cattle and to men who have occasion to walk through the grass. Sir James E. Tennent's description of the land-leech of Ceylon (*Hæmadipsa Ceylanica*) is very amusing. In size, it is about an inch in length, and as fine as a common knitting-needle, but capable of distension to the thickness of a quill and a length of nearly two inches. It can insinuate itself

LEECHING—LEEDS.

through the meshes of the finest stocking. It is always ready to assail a passing traveller or quadruped. The coffee-planters are obliged to wear *leech-gaiters* of closely-woven cloth for protection. Horses are driven wild by these pests, 'and stamp the



Land Leeches :
From Tennant's *Ceylon*.

ground in fury, to shake them from their fetlocks, to which they hang in bloody tassels.' The bare legs of palanquin-bearers are adorned with clusters of them like bunches of grapes. Their numbers have often occasioned the death of men compelled to spend days where they abounded. The moist valleys of Java, Sumatra, Chili, and other tropical countries, swarm with land-leeches as much as those of India and Ceylon.

LEECHING, or the application of **LEECHES** (q. v.), for the purpose of abstracting blood, is preferable to venesection or cupping in many forms of disease; as, for example—1. In local determinations of blood, unattended with febrile symptoms, as in acute inflammation of the female breast, when the pressure of the cupping-glass would cause intense pain. 2. In abdominal inflammations, especially in Peritonitis (q. v.), the application of leeches is often preferable to general blood-letting, particularly in patients of a weak constitution. 3. In various organic affections of the heart and lungs, leeching often affords great relief. Indeed, there are few diseases in which loss of blood is required, excepting erysipelas, in which the application of leeches is objectionable; although it is inexpedient, as compared with venesection, in those cases in which it is desirable to make an immediate impression on the disease (as in peritonitis in robust persons), or where the disease is very rapid and fatal (as in croup).

In the diseases of infants and young children, leeches must be applied with caution. Infants are sometimes completely blanched by the application of one or two leeches, and a case is recorded by Pelletan in which six leeches applied to the chest proved fatal to a child aged six years. In applying leeches, the part should be thoroughly cleaned, and the leeches, after being dried by rubbing them in a clean linen cloth, should be placed in an open pill-box, or in a wine-glass, and applied to the spot at which it is desired that they should attach themselves. When it is wished to affix a leech to the inside of the mouth, it is placed in a narrow tube called a leech-glass. When the animals will not attach themselves readily, they may sometimes be induced to bite by moistening the part with milk or blood.

The quantity of blood which a leech is capable of drawing may be estimated at an average at about a drachm and a half, although occasionally a leech will abstract between three and four drachms; and this quantity does not include that lost after the animal has fallen off, which is frequently, especially in children, very considerable. In order to cause the leech to disgorge the blood, the usual practice is to apply salt to its body.

When the leeches have fallen off, it is usually desirable to promote to some extent the flow of blood from their bites, and this is readily done by the application of warm fomentations or poultices. The bleeding generally stops spontaneously after a short time; if it goes on longer than is desirable, mere exposure to the air, or the application of the fluff of a hat, or of a bit of cobweb, will usually check it, the fibrine of the blood coagulating on the applied filaments, and forming a small clot. If these means fail, a little cone of lint should be inserted into the bite, over which a compress should be laid and a bandage applied; or the bite should be touched with a stick of nitrate of silver (lunar caustic) scraped to a point.

Leeches, when applied to the mouth or interior of the nose, have been occasionally swallowed, and have given rise to very unpleasant symptoms. The best treatment in a case of this kind is to prescribe wine—half a glass, or even a glass, every quarter of an hour—which will speedily destroy the leech. A moderately strong solution of common salt would probably exert a similar fatal action on the animal.

LEEDS, the first town in Yorkshire, and fifth in England in point of population, is a parliamentary and municipal borough, being one of those which were enfranchised at the passing of the Reform Bill. It is situated in the north-west of the West Riding of Yorkshire, in the valley of the Aire, and is the centre of the clothing district. The extent of this and the other commercial pursuits of the town may be estimated from the following statistics of employments in L., as ascertained in 1858.

Employments.	Persons Employed.	Annual Total Wages.
Woollen manufacture,	10,193	£270,005
Worsted "	740	90,238
Flax, "	2,090	188,052
Iron, and machine-making,	10,909	560,092
Iron-stone and coal-miners,	3,000	156,000
Silk manufacture,	590	18,900
Paper "	190	7,590
Tobacco "	115	10,090
Clay-pipes, fire-bricks, &c.,	900	40,900
Earthenware,	540	15,942
Glass,	670	35,900
Oil,	943	12,594
Chemicals,	590	32,940
Leather,	2,000	102,317
Dyeing,	1,688	76,752

Public Buildings.—There are 36 churches in Leeds, of which 26 are in the town and 10 in the suburbs. Of these, 22 are parochial vicarages, and 14 are perpetual curacies. The chief is St Peter's, which is in Kirkgate, and was rebuilt in 1838 at a cost of £29,770. It is 180 feet long by 86 feet wide; the tower is 139 feet high, and contains a peal of 13 bells. It is a very noble edifice. The principal windows are of beautiful stained glass. It also contains some fine statues, one of which is erected in memory of those natives of Leeds who fell in the Crimea; the church has a good choir. The other principal buildings are chiefly of recent erection, and are as follows: The Town-hall is 250 feet long, 200 feet broad, and the tower is 225 feet high. It covers 5600 square yards. The great hall is 161 feet long, 72 feet wide, and 75 feet high. It is richly decorated, and contains one of the largest and most powerful organs in Europe, also statues of Edward Baines and Robert Hall, formerly members for the borough. There is also a colossal statue of the Queen in the vestibule, and of Wellington in the front of the building. Kirkstall Abbey, about three miles from L., was founded between 1147 and 1153 by Henry

de Lacie for the Cistercian order of monks. It is a fine old ruin, remarkable for its simple grandeur and unity of design. Adel Church, about four miles from L., is an interesting building, erected 1140. Near it was a Roman station, where several antiquities have been found. The Grammar-school was built in 1859, at a cost of £13,000. It is built in the shape of a cross in the Gothic style, decorated period, and was designed by E. M. Barry, Esq. The borough jail is a large castellated building at Armley, admirably adapted for its purpose. The Corn Exchange, a handsome building of an oval form; the Post-office, formerly the Court House, near which is a statue of Sir Robert Peel; the Queen's Hotel, recently erected by the Midland Railway Company; the Philosophical Hall, built in the Doric order of architecture, and having a fine museum, &c. The educational institutions comprise the Mechanics' Institute, founded 1824. It possesses a library of 12,000 volumes, reading-room and lecture-hall, day-schools, and evening classes; it has 1500 members. In connection with it is the School of Art, one of the most prosperous in the kingdom, and giving instruction in drawing to 3000 persons. The Working-Men's Institute, numbering, on an average, 2000 members: its attractions are lectures and entertainments, newspapers, indoor and outdoor games, refreshments at cost-price, all for a weekly subscription of 1d. Besides the above, there are about twelve smaller institutions for the promotion of popular instruction. There is also a library of 30,000 volumes, founded by Priestley in 1768. The number of subscribers is limited to 500. Among charitable institutions may be mentioned the Infirmary, which is about to be rebuilt on a new site from designs by George Gilbert Scott, R.A., and towards which upwards of £66,000 has been subscribed; the Dispensary; House of Recovery; Hospital for Women and Children; Tradesman's Benevolent Society; Industrial School, and handsome new workhouse; the Reformatory at Adel, where about 60 juvenile criminals are usefully employed in agricultural and other occupations. L. has also a Commercial News-room, a Stock Exchange, two general markets—one of which is a handsome structure of iron and glass—a cattle-market, coloured and white cloth halls, three railway-stations, seven banks, two theatres, one daily and three weekly newspapers. L. sends two members to parliament. Pop. in 1861, 207,165.

LEEK (*Allium Porrum*; see ALLIUM), a biennial plant, and a native of the South of Europe; with no proper bulb at the root, but generally a slight increase of the thickness of the stem; a stem about 3 feet high, leafy at bottom; the leaves about an inch wide; the flowers in a large and very dense terminal globular umbel, which is not bulbiferous. It has been long in cultivation, and some of the varieties exhibit the effects of cultivation in greatly increased size and delicacy. The lower part of the stem, before it has run up into a flower-stalk, blanched by earthing up or other means which also induce it to swell and extend, is much esteemed for culinary purposes. Its flavour is much milder than that of the onion, or any other species of *Allium*. The L. has long been an especial favourite of the Welsh; and much attention has of late been paid to its cultivation in some parts of Scotland. It is generally sown in spring, and is used during the following winter. It delights in a rich but light and dry soil. Gardeners often transplant seedling leeks, instead of merely thinning out the original rows; and sometimes make deep holes for them with the dibble, into which they merely throw a little earth to cover the roots, leaving the stem to swell in the open hole.

LEEK, a manufacturing and market-town of England, in the county of Stafford, 24 miles north-north-east of the town of that name. The parish church dates originally from 1180, and the town contains also numerous educational and benevolent institutions. Pop. (1861) 10,045, who are employed chiefly in the manufacture of silk goods.

LEET COURTS, in English Law, mean courts held in a manor, township, or hundred, for local purposes.

LEEUWARDEN, a town of the Netherlands, capital of the province of Friesland, in a rich and extensive plain, on the Harlingen and Gröningen Canal, 16 miles east-north-east of Harlingen. It contains a handsome town-hall, an ancient palace of the Princes of Orange, and many churches. Numerous canals intersect the town. L. has a society for the investigation of Frisian history, antiquities, and language, and another for the study of natural history. Linen fabrics and paper are manufactured, and a trade in horses is carried on. Pop. 24,461.

LEEUWENHOEK, or LEUWENHOEK, ANTHONY VAN, one of the earliest microscopic observers, was born at Delft, in Holland, in 1632, and died in the same town in 1723. The compound microscope, as it existed in his time, was very imperfect, and subject to many errors, which induced L. to employ only simple microscopes, that is to say, very small lenses of short focal lengths, which were fixed between two plates of metal that had been pierced with a very narrow opening. He bequeathed to the Royal Society of London (where they are carefully preserved) a collection of these microscopes. It was in the *Philosophical Transactions* of this Society, to which he contributed 112 papers, that most of his observations were originally published.

Amongst the most important of his investigations may be mentioned a Memoir communicated to the Royal Society in 1690, in which he discovered, and clearly demonstrated, the continuity of the arteries and veins through intervening capillaries, and thus afforded ocular demonstration of the truth of Harvey's views regarding the circulation; he also examined the structure of the crystalline lens and of the brain. He is perhaps most generally known as the discoverer of the *Rotifers*, and as being the first to recognise the property which these animals possess of alternately dying and being resuscitated, according as they are dried or provided with the water necessary for the maintenance of their vitality.

His writings were collected and published in Dutch at Leyden and Delft in seven 4to volumes, the publication extending from 1686 to 1732. A Latin translation, under the title of *Opera Omnia, seu Arcana Nature*, was published at Leyden in 1792; and an English translation was published by Mr Samuel Hoole, in two 4to volumes, in 1798—1800.

LEEWARD ISLANDS. See ANTILLES.

LEEWAY. When a ship is steering in a direction AB, and a strong wind is blowing as indicated by the arrow, the ship's actual course is the resultant of two forces, one represented by her headway (or locomotive power), the other by the force urging her in the direction of the wind. This resultant must be somewhat in the line CD; and with the



same power of wind, the angle BED will be great or small as the headway is diminished or increased. This angle represents the leeway; and the amount

LEFEBVRE—LEGACY.

of ground lost to leeward in a given distance sailed is shewn by the side of the triangle subtending this angle. In all computations of the course pursued, allowance has to be made for leeway. Some ships, in tolerable weather, make scarcely any perceptible leeway, while bad sailers fall off as much as seven points of the compass.

LEFEBVRE, FRANÇOIS JOSEPH, Duke of Danzig and Marshal of France, was born at Ruffach, in Alsace, 25th October 1755. He entered the army at the age of eighteen, and was a sergeant in the French Guards when the Revolution broke out. On the dissolution of his regiment, he was transferred to another, and on two occasions had the opportunity of rendering important help to the royal family. There was always something gallant and humane in the valour of Lefebvre. He rose in rank with wonderful rapidity. He took part with Bonaparte in the *coup d'état* of the 18th Brumaire, and it was he who, at the head of his grenadiers, burst into the hall of the Council of Five Hundred, and rescued his fainting chief. In 1804, he was made a Marshal of the Empire. At the battle of Jena, he commanded the infantry of the Guards. He also conducted the siege of Danzig, and after its capture was created Duke of Danzig. He distinguished himself in the early part of the Peninsular War, but was recalled to Germany, where he was invested with the command of the Bavarian army, and suppressed the insurrection in the Tyrol. During the Russian campaign, he had the command of the Imperial Guard, and in 1814, of the left wing of the army which resisted the advance of the allies in France. Submitting to the Bourbons after Napoleon's abdication, he was made a peer. He died 14th September 1820.

LEFKOSI'A, called also **NIKOSI'A**, ancient **LEUCOSIA**, capital of the Turkish island of Cyprus (q. v.), is situated in a plain surrounded by mountains, about 35 miles inland from Famagusta Bay. It is surrounded by walls 3 miles in circumference, and contains several buildings of interest, as the cathedral, now the mosque of St Sophia, the church of St Nicholas, and the governor's palace. The kings of Cyprus of the Lusignan dynasty resided here. Calico-printing, tanning, and silk-weaving are the principal employments of the inhabitants. Pop. 15,000.

LEFORT, FRANÇOIS, son of Jacques Lefort, member of the Grand Council of Geneva, was born at Geneva in 1656. He was descended from an old Scotch family that had been settled there for a century, and members of which still exist at Geneva. After serving for some time in the French and Dutch service, he went to Russia, where he obtained a captain's commission in the army. He fought with distinction against the Turks and Tartars under the command of Romadanofski, and took an active part in the intrigues which placed Peter the Great on the throne. The czar never forgot L., who became his chief favourite, and, next to Peter, the most important personage in Russia. He was a man of great acuteness and ability. He remodelled the Russian army, and also laid the foundation of its navy; he sought also to encourage manufactures, and to promote the improvement of agriculture, and obtained for strangers a certain measure of toleration in matters of religion. In 1694, he was made Grand Admiral and Generalissimo of the Russian Army, and in 1697, governor of Novogorod. When Peter the Great undertook his visit to foreign countries in 1697, Lefort was the chief of the embassy, in the train of which the czar travelled *incognito*. L. died in 1699. Compare Voltaire's *Histoire de Pierre le Grand*, and Golikof's *Vie de Lefort*.

LEG, THE, comprises all that part of the lower extremity which lies between the knee and the ankle. It consists of two bones, the tibia and fibula (see **SKELSTON** and **FOOT**), and of masses of muscles (together with nerves and vessels) which are held in their position by coverings of fascia, and are enveloped in the general integument.

The shaft of the tibia is of a triangular prismoid form, and presents three surfaces and three borders. The internal surface is smooth, convex, and broader above than below; except at its upper third, it lies directly under the skin, and may be readily traced by the hand. The external and the posterior surfaces are covered by numerous muscles. The muscular mass forming the calf (formed by the *gastrocnemius*, *soleus*, and *plantaris* muscles) is peculiar to man, and is directly connected with his erect attitude and his ordinary mode of progression. The anterior border of the tibia, the most prominent of the three, is popularly known as *the shin*, and may be traced down to the inner ankle.

The fibula, or small bone of the leg, lies on the outer surface of the tibia, and articulates with its upper and lower extremities, and with the astragalus inferiorly. It affords attachments to many of the muscles of this region.

This region is nourished by the anterior and posterior tibial arteries into which the popliteal artery separates. Both these arteries occasionally require to be tied by the surgeon in cases of wounds or aneurism. The blood is returned towards the heart by two sets of veins—the deep, which accompany the arteries, and the superficial, which are known as the internal or long saphenous, and the external or short saphenous veins. These superficial veins are very liable to become permanently dilated or varicose (a condition the nature and treatment of which are considered in the article **VARICOSE VEINS**), if there is any impediment to the free transmission of the blood, or even from the mere weight of the ascending column of blood, in persons whose occupation requires continuous standing.

The nerves of the leg, both sensory and motor, are derived from the great sciatic nerve and from its terminal branches, the internal popliteal and the external popliteal or peroneal nerve.

In cases of fracture or *broken leg*, the two bones are more frequently broken together than singly, and the most common situation is at the lower third. The tibia is more often broken by itself than the fibula, in consequence of its sustaining the whole weight of the body, while the fibula has nothing to support.

LEGACY is a bequest or gift contained in the will of a deceased person of a chattel or sum of money or other thing. In England, it is provided by statute that if a legacy is given to the witness of a will, or to his or her wife or husband, the legacy is void; therefore, a legatee should never act as a witness. So bequests to superstitious uses are void, as, for example, to maintain a priest, or an anniversary or obit, or a lamp in a church, or to say masses for the testator's soul, or to circulate pamphlets inculcating the pope's supremacy. Legacies of money for charitable purposes, as for the use of schools, churches, &c., are valid, but if the money is directed to be laid out in the purchase of land for such purposes, the legacy is void by what is called the Mortmain Act (q. v.), 9 Geo. II. c. 36. The policy of this statute has often of late been questioned, and it is enough to say that there is a mode, often practised, of evading it.

Legacies are divided into specific and general. A specific legacy means a legacy of a specific thing, as a particular horse, picture, silver-plate, &c., or a sum of stock in the funds. A general

legacy means a sum of money, without saying out of what fund it is to come, and it is payable out of the assets generally. The important difference between the two kinds of legacy is this, that if the subject-matter of the specific legacy fail, as if the horse die or be previously sold, &c., the legacy is gone, and no compensation is given for it; while, on the other hand, if there is not enough to pay all the general legacies, then they must abate—that is, share the loss—whereas the specific legacy, if it exist, must still be paid in full. There are various rules of great nicety and intricacy connected with the proper construction of legacies in a will, which are too technical to be noticed. It is a general rule applicable to all legacies, that they are only payable if there is money enough for the purpose, after paying all the testator's debts, for the maxim applies, that a man must be just before he is generous. The rule is, that a legacy is not payable by the executor till a year has elapsed after the testator's death, for it is presumed he requires this time to inquire into the state of the property; and this is true even though the testator has ordered the legacy to be paid within six months after the death. If a legacy is left to an infant under twenty-one, it cannot be paid to the father, or any other relation, without the sanction of the Court of Chancery. If a legacy is left to a married woman, the husband is entitled to claim it, unless it is left to her separate use, or unless she is unprovided for by the husband; in which case, the Court of Chancery will order the amount, if exceeding £200, to be settled upon her exclusively. Interest is due on legacies from the time when the principal sum is payable—i. e., one year after the death—unless otherwise specified. If the legatee die before the testator, the legacy lapses—that is, becomes void; but there are some exceptions, as where the legatee is a child or grandchild of the testator.—In Scotland, the rules as to legacies are mainly the same, but not entirely. The details are too technical to require notice here. See Paterson's *Compendium of English and Scotch Law*, p. 233. In Scotland, a legacy can be enforced in six months after the testator's death, and bears interest from such death. If a legacy is left to a married woman, the husband is now in general bound, as in England, to settle it on the wife, by the statute 24 and 25 Vict. c. 86.

In the United Kingdom, a legacy or succession duty is levied on the amount of all legacies (except to husband or wife). Children and issue, also parents and ancestors, pay one per cent duty; brothers and sisters, and their issue, pay three per cent; uncles and aunts, and their issue, pay five per cent; granduncles, &c., and their issue, pay six per cent. Strangers in blood, and distant relatives, also illegitimate children, pay ten per cent.

LEGAL, or **LEGAL REVERSION**, in Scotch Law, means the right of redemption of an adjudication of heritable property, equivalent in England to equity of redemption of a tenant *in elegit*.

LEGATE, the name of the ambassador or representative, whether temporary or permanent, sent by the pope to a particular church. In the ancient church, we meet many examples of officials, called in Greek *apocrisitarii*, and in Latin *responsales*, at the court of Constantinople; but their commission was commonly temporary, and granted for some special object. In the later constitution of the church, three classes of legates are distinguished: 1. *Legati a latere*, 'legates despatched from the side' of the pontiff, who are commonly cardinals; 2. *Legati missi*, called also 'apostolic nuncios,' and including a lower grade called 'internuncios;' 3. *Legati nati*, 'legates born,' whose office is not

personal, but is attached by ancient institution or usage to the see or other ecclesiastical dignity which they hold. Of the last class there were examples in most national churches; thus, the Bishop of Thessalonica was legate born for Illyricum, the Bishop of Arles for Gaul, the Bishop of Mainz for Germany, the Bishop of Toledo (though his claim was often disputed) for Spain, the Bishop of Canterbury for England, &c. This institution, however, has gone entirely into abeyance; and, indeed, the authority of legates is much modified in the modern church. In the mediæval times, the legate claimed full papal jurisdiction in the country assigned to him, even overruling the local jurisdiction of the bishops of the national church. This led to many disputes; to refusals to receive legates, as in France, where the legate was obliged to wait at Lyon till his credentials should have been examined and approved at court; and to counter legislation, as in England, to the statute of 16 Richard II., commonly known as the Statute of Premunire; and the Council of Trent removed the ground of contention by abolishing all such claims to local jurisdiction as trench upon the authority of the bishops. The legate, in the modern church, is little other than the ambassador, mainly for spiritual purposes, of the pope. He is held as belonging to the diplomatic body, and by the usage of Catholic courts enjoys precedence of all other ambassadors. The legates at the second-rate courts have the title of *internuncio*. Legates are commonly bishops or archbishops, in *partibus infidelium*. The establishment of a nunciature at Munich, in 1785, led to an animated controversy. In the pope's own states, as they existed before the late revolution, the governors of the Legations (see ITALY, PAPAL STATES) were called *legates*.

LEGA'TO (Ital. *tied*), in Music, means that the notes are to be played as if bound or tied together, or in such a manner that the one note is as if were rounded off, or flows into the following one. Many musicians think that legato passages should be played slower, which is a great mistake. Wherever *Legato* is marked, either as the character of the whole piece, or only over a part of the notes, it is the sign that the music requires to be performed in a flowing manner, and without any interruption between the striking of the notes.

LEGA'TUM REI ALIENÆ, in the Roman Law, is the legacy of a thing which does not belong to the testator. In England and Ireland, such a legacy is simply null and void; but in Scotland, the Roman law has been adopted, by which, if the testator knew the thing bequeathed was not his own, the executor is bound to purchase something else, as compensation to the legatee.

LEGEND (Lat. *legenda*, things to be read, lessons) was the name given in early times, in the Roman Catholic Church, to a book containing the daily lessons which were wont to be read as a part of divine service. Then the narratives of the lives of saints and martyrs, as well as the collections of such narratives, received this name, because the monks read from them at matins, and after dinner in the refectories. Such legends were also inserted in the breviaries (see **BREVIARY**), in order that they might be read on the festivals of the saints and martyrs. Among the mediæval collections of legends, that drawn up by the Genoese archbishop, Jacobus de Voragine, in the second half of the 13th c., under the title of *Legenda Aurea* (the Golden Legends), or *Historia Lombardica*, is the most celebrated. But the most comprehensive and valuable work on the subject is that commenced by the Bollandists (q. v.) in the 17th c.—*Acta Sanctorum*

(q. v.)—and still going on. The way in which a credulous love of the wonderful, exaggeration of fancy, and ecclesiastical enthusiasm, at times even pious fraud, mixed themselves up in these narratives with true history, caused stories of a religious or ecclesiastical nature generally to be designated as legends, in contradistinction from authentic ecclesiastical history; and thus the word 'legends' also serves to separate religious from secular traditions, and from those wild tales (Ger. *märchen*) that delighted the peasantry of medieval Europe. Legends in this sense of the word, as spiritual or ecclesiastical sagas, are found not only in the Roman Catholic, but also in the Greek Church, and their origin reaches back to the earliest ages of Christianity—Christ himself, the Virgin, John the Baptist, the apostles, and other prominent persons of the gospel history having become, at a very early period, the subject of them. But this tendency to mythic embellishment shewed itself more especially in regard to Mary, the later saints, martyrs, and holy men and women. From the ecclesiastical literature of the Eastern and Western Churches, especially of the latter, the legends also found an entrance into the national literature of Christian nations. Among the Germans, this was very markedly the case after the second half of the 12th c., although specimens of legendary poems are not altogether wanting at an earlier period. We may mention, for example, the *Kaiserchronik* (Imperial Chronicle), where the legendary element forms a very important part of the whole; and Werner's versified *Marienleben* (Life of Mary), written in 1173, &c. The authors of these works were ecclesiastics; but already laymen, too, had appeared in the same field. The poetic versions of the legend of St Oswald and that of Pilate sprung from this class; and in the following age, when the medieval poetry of Germany was in its richest bloom, and the fosterers of the poetic art were emperors and princes, rather than ecclesiastics, the legend was employed by laymen on a grand scale, as the subject-matter of epic narratives. Thus, Hartmann von Aue (q. v.) worked up into a poem the religious legends about Gregory; Konrad von Fuesenbrunnen, those concerning the 'childhood of Jesus'; Rudolf von Ems, those about 'Barlaam and Josephat' (q. v.); and Reinbot von Durne, those about 'St George.' Between the 14th and 16th centuries, legends in prose began also to appear, such as Hermann von Fritzlars *Von der Heiligen Leben* (written about 1343), and gradually supplanted the others. Finally, in the 16th c., when Protestantism began to powerfully influence the whole of German literature, the legend disappeared from German poetry, or passed over into the moral-didactic and also the comic narrative, in which form it was employed by Hans Sachs with the happiest effect. Numerous attempts have been made to resuscitate it in modern times. The first of the recent poets who clearly apprehended the poetic and spiritual elements of the old Christian legend was Herder (q. v.); and since his day, many German poets—for example, the 'Romantic School'—have endeavoured to give these a new embodiment.

LEGENDE, ADRIEN MARIE, an eminent French mathematician, born at Paris in 1752. He obtained, in 1774, a professorship of mathematics in the Military School at Paris, and in 1783 was admitted a member of the Academy. In 1787, he was employed by the French government, along with Cassini and Mechain, in measuring a degree of latitude, and was chosen to perform the calculations after the work of observation had been finished. In 1808, he was appointed by the imperial government president for life of the university, and after the

second Restoration, an honorary member of the Commission for Public Education, and chief of the committee of Weights and Measures. But because in an election to a place in the Academy he did not vote for the ministerial candidate, he was deprived, in 1824, of his pension of 3000 francs. He died 9th January 1833. L. is the author of *Théorie des Nombres* and *Eléments de Géométrie*, and particularly distinguished himself by his investigation of the difficult subject of the attraction of the elliptic spheroid, and of a method for determining the paths of comets.

LEGER-LINES, in Music, the name of those short lines above or below the staff which are used to express those notes which extend beyond the five lines of the staff.

LE'GHORN (*Livorno*), one of the chief Mediterranean seaports, is a city of Tuscany, in the modern province of Livorno, 50 miles west-south-west of Florence, and 14 miles south-south-west of Pisa; lat. 43° 32' 7" N., long. 10° 17' 7" E.; pop. 78,850, including about 8000 Jews, who possess a considerable portion of the commercial wealth of the place.

L. is one of the leading emporiums of trade in Italy, and enjoys the advantage of being a free port, to which circumstance it owes its extensive import-trade both with England and France: in no continental town are the manufactures of these countries to be found on a larger scale or at a more moderate cost. The average annual import and export trade of L. amounts to about £6,000,000, upwards of 10,000 vessels being employed for the transport of the various commodities of this traffic. The town is partly intersected with canals, by which merchandise is conveyed from the harbour to the numerous warehouses of the city. The port consists of an inner and outer harbour, the latter being sheltered by a mole, which projects into the sea upwards of half a mile, close to the great light-house. To secure increased shipping accommodation, a new harbour has been lately constructed for the reception of vessels of considerable tonnage. The roadstead, which is capacious, lies west-north-west of the harbour, and is protected by towers and a castle. On an island south of the harbour stands the lazaretto.

The population comprises natives of many climes (Greeks, Armenians, Turks, Moors, &c.), whose foreign appearance and striking garb give a picturesque appearance to the place. This concourse of strangers is further enlarged in the summer season by a great influx of native and foreign visitors, who resort to L. for its baths and mineral springs, the latter of which enjoy high medical repute. The town itself is chiefly of modern origin, and destitute of the grand historical associations and classical monuments which invest most Italian cities with their highest interest; its fine Mediterranean site, animated aspect, and great commercial life, are its principal attractions. The streets are regular and well paved, but narrow, and in consequence of being flanked by high houses, they are for the most part dark and gloomy. The churches are numerous. Many of the private dwellings of L. are tasteful and luxurious, and charming villas abound in the environs. The public institutions are well organised, and include three hospitals, an observatory, a poor-house, and a free library. The circuit of the town has been lately much extended by the demolition of old fortifications, and the extension of the barriers or city walls. The manufactures of L. are various and important; it possesses great factories of oil, tobacco, soap, salt, and the well-known liqueur *Rosolio*; its distilleries and dyeing works are also celebrated. Its chief exports are raw and

manufactured silks, straw-hats and straw-plaiting, oil, fruits, borax, cheese, anchovies, marble, sulphur, and coral. Its imports comprise colonial produce, raw and manufactured cotton, and wool, cutlery, hardware, metallic goods, earthenware, and salted fish.

Towards the end of the 13th c., L. was an unprotected village, which only assumed some importance on the destruction of the port of Pisa, and especially on its being assigned to Florence in 1421. Alessandro dei Medici constructed its citadel and fortified the town; Cosmo I. declared it a free port, and from that time dates the rise of its prosperity. In the 17th c., under Ferdinand I., it was a town of great commercial importance; and during the French imperial occupation of Italy, L. was proclaimed the chief town of the department of the Mediterranean. Since 1830, L. has taken a foremost part in the revolutionary life of Italy.

LEGION, in the Roman military system, corresponded in force and organisation to what in modern times we should call a *corps d'armée*. It differed in constitution at different periods of Roman history. In the time of the Republic, a legion comprised 4500 men, thus divided: 1200 *hastati*, or inexperienced troops; 1200 *principes*, or well-trained soldiers; 1200 *velites*, or skirmishers; 600 *triarii*, or *pilani*, veterans forming a reserve; and 300 *equites*, knights who acted as cavalry, and belonged to families of rank. During this period the legions were formed only for the season; standing armies being of later growth.

The *hastati*, *principes*, and *triarii* formed three separate lines, each divided into 10 *maniples* or companies, of 120 men each in the case of the two front lines, and of 60 men in the *triarii*. A *maniple* was commanded by a centurion or captain, who had a second-centurion, or lieutenant, and two sub-officers, or sergeants, under him: as non-commissioned officers, there was a *decanus*, or corporal, to every squad or tent of ten men. The senior centurion of each line commanded that line, and had therefore functions corresponding to a modern lieutenant-colonel. The *primipilus*, or senior centurion of the *triarii*, was the most important regimental officer, and commanded the legion in the absence of the tribunes. The 300 cavalry formed a regiment of ten *turme*, or troops of 30 horsemen, each under three *decurions*, of whom the senior had the command. The *velites* were light troops, not forming part of the line of battle; had apparently no officers of their own; and were attached to the 30 *maniples* in equal proportions. The staff of the legion consisted of six tribunes, who managed the paying, quartering, provisioning, &c. of the troops, and who commanded the legion in turns for a period each of two months. This changing command, although inconvenient, lasted till the times of the civil wars, when a *legatus*, or lieutenant-general, was appointed as permanent commandant of the legion.

The offensive weapons of the *hastati* and *principes* were two barbed iron-headed javelins, one of which was hurled at the enemy on the first onslaught, while the other was retained as a defence against cavalry. The *triarii* had long pikes. In addition to these arms, every soldier bore a short, strong, cut-and-thrust, two-edged sword. The legionaries' defensive armour consisted of plumed helmet, breast-plate, iron-bound boot for the right leg, and a semi-cylindrical shield 4 feet long by 2½ broad. The *velites* had no defensive armour, were lightly armed, and in action usually operated for flanking purposes. Each *maniple* bore an ensign aloft, and each legion had its distinguishing eagle. Up to the time of Marius, service in a legion was sought as honourable occupation, and men of some means were alone eligible; but Marius enlisted slaves, and turned

the legions into corps of a purely mercenary army. At the same period, the manipular formation was abolished, the three lines were assimilated, and the legion was divided into 10 cohorts, each of 3 *maniples*. Soon the cohorts were raised to 600 men, making the legion 6000 infantry besides cavalry and *velites*. It was ranged in 2 lines of 5 cohorts each; but Cæsar altered the formation to 3 lines, of respectively 4, 3, and 3 cohorts.

During the later Empire, the legion became complex and unmanageable; many sorts of arms being thrown together, and ballistæ, catapults, and onagers added by way of artillery. Having so degenerated from its pristine simplicity and completeness, the legionary formation was soon overthrown amid the incursions of the victorious barbarians.

LEGION, THE THUNDERING (Lat. *Legio Fulminatrix*), a legion of the Roman army which is the subject of a well-known miraculous legend. During Marcus Aurelius's war with the Marcomanni (174 A. D.), his army, according to this narrative, being shut up in a mountainous defile, was reduced to great straits by want of water; when, a body of Christian soldiers having prayed to the God of the Christians, not only was rain sent seasonably to relieve their thirst, but this rain was turned upon the enemy in the shape of a fearful thunder-shower, under cover of which the Romans attacked and utterly routed them. The legion to which these soldiers belonged was thence, according to one of the narrators, called the Thundering Legion. This legend has been the subject of much controversy; and it is certain that the last told circumstance at least is false, as the name 'thundering legion' existed long before the date of this story. There would appear, nevertheless, to have been some foundation for the story, however it may have been embellished by the pious zeal of the Christians. The scene is represented on the column of Antoninus. The event is recorded by the pagan historian Dion Cassius (lxxi. 8), who attributes it to Egyptian sorcerers; and by Capitolinus and Themistius, the latter of whom ascribes it to the prayers of Aurelius himself. It is appealed to by the nearly contemporary Tertullian, in his *Apology* (c. 5), and is circumstantially related by Eusebius, by Jerome, and Orosius. It may not improbably be conjectured, supposing the substantial truth of the narrative, that the fact of one of the legions being called by the name 'Thundering' may have led to the localising of the story, and that it may have, in consequence, been ascribed to this particular legion, which was supposed to have received its name from the circumstance.

LEGION OF HONOUR, an order of merit instituted under the French Republic in 1802 by the First Consul, as a recompense for military and civil services. It was ostensibly founded for the protection of republican principles and the laws of equality, and for the abolition of differences of rank in society, every social grade being equally eligible; but its real aim doubtless was, by popularising the idea of personal distinction, to pave the way for the establishment of the Empire and of the more exclusive titles of nobility that were to accompany it. The proposal for its institution was at first violently opposed by the legislative body and the tribunate, on democratic grounds, and carried eventually by a narrow majority.

The order originally comprised three classes—Grand Officers, Commanders, and Legionaries. The class of Grand Officers was, on the coronation of Napoleon I., divided into Knights of the Grand Eagle (the highest class), and Grand Officers. On the restoration of the Bourbons, the Legion was

retained, but remodelled so as to lose much of its original character. The eagle was called a cross, and the effigy of Henry IV. replaced that of Napoleon. The Knights of the Grand Eagle became Grand Crosses, the Legionaries were transformed into Knights, and the numerous educational institutions, founded by Napoleon for the children and relatives of the members of the order, were much reduced in scale. In 1837, a new military class called Officers was admitted. Under the Presidentship of Louis Napoleon, part of the property of Louis Philippe, which had been restored to the state, was set apart as an endowment for the Legion, and new regulations were made regarding the pensions of the different classes. The original form of decoration was reintroduced, which has under the second Empire been somewhat modified. As now worn, it consists of a cross of ten points of white enamel edged with gold; the points are connected with a wreath of laurel proper, and in the centre, within an azure circle charged with the words 'Napoléon III, Empereur des Français,' is a head of the emperor. The cross is ensigned by the imperial crown of France, and worn attached to a red ribbon. The Grand Officers also wear on the right breast a silver star charged with the imperial eagle. The same star is worn on the left breast by the Knights Grand Cross, and their cross is attached to a broad red ribbon which passes over the right shoulder.

The vast numbers of this order, and the insignificance of many of the persons on whom it has been conferred, have detracted much from its value. In 1843, the members numbered 49,417; but since 1851, only one new nomination has been made for every two extinct ones. The College of the Legion is in possession of considerable means, which have been augmented by the addition of property belonging to Louis Philippe. Out of this fund pensions are paid to certain members of the order, including knights and legionaries who have been wounded, or have undergone the amputation of a limb in service. These pensions have sometimes amounted to as large a sum as six million francs annually. By the existing statutes, candidates in time of peace must have served in some military or civil capacity for twenty years; exploits in the field or severe wounds constitute a claim in time of war. Two distributions take place in the year. The nomination of military persons takes place on parade, and of civil in the courts of justice. No ignoble punishment can be inflicted on a member of the order so long as he belongs to it. To rise to a superior rank, it is indispensable, at least for natives of France, to have passed through the inferior grades.

LEGITIM, or BAIRN'S PART, in the Scotch Law, is the legal provision which a child is entitled to out of the movable or personal estate of the deceased father. In Scotland, a father is not allowed to disinherit his children to a certain extent, the extent varying according as the wife survives or not. If a wife survive, and also children survive, the movable estate is divided into three equal parts. One is the widow's *Jus Relictæ* (q. v.), another is the children's legitim, the other third is the Dead's Part (q. v.), which the father may bequeath by will if he pleases, but if he make no will, then it goes to the children as next of kin. If the wife is dead, then half is legitim, and the other half is dead's part. Moreover, a father, though in his lifetime he may, without any check from his children, squander his property, still is not allowed on his death-bed to make gifts so as to lessen the fund which will supply legitim. The children's claim to legitim may be qualified by an antenuptial contract of marriage, which provides some other provision to the children in lieu of legitim; but, as a general rule,

the children's claim cannot be defeated by anything the father can do by means of a will or what is equivalent to a will. The legitim is claimable by all the children who survive the father, but not by the issue of those children who have predeceased. It is immaterial what the age of the child may be, and whether married or not. Children claiming legitim must, however, give credit for any provision or advance made by the father out of his movable estate in his lifetime. All the children, though of different marriages, share in the legitim. In England and Ireland, there is no similar right to legitim, for the father can bequeath all his property to strangers if he please; but a similar custom once existed in the city of London, and York, now abolished by 19 and 20 Vict. c. 94.

LEGI'TIMACY, PETITION TO DECLARE. In Scotland, it has always been competent for a party who wished to establish that he was a legitimate person, to raise an action of declarator of legitimacy, when the court solemnly decided the question. In England, this could not be done, except indirectly in the course of some suit for another purpose, until 1858, when the statute 21 and 22 Vict. c. 93 allowed all natural-born subjects whose legitimacy was doubted to present a petition to the Divorce Court to have the question decided.

LEGITIMA'TION, in Scotch (and Foreign) Law, is the rendering legitimate a person who was born illegitimate. This is done by the father subsequently marrying the mother of the child, and hence it is often called legitimation *per subsequens matrimonium*. This effect, however, can only be produced provided at the time of the birth the parents might have been married, or there was no obstacle to their then marrying, if so inclined, as, for example, if they were both unmarried, and there was no impediment. Sometimes it has happened that the father, A, or mother, B, after the child's birth, marries a third person, and has children, and after the dissolution of the marriage, A and B then marry. In this perplexing case, the courts have held that the intervening marriage with a third party does not prevent the bastard child, born before that event, from being legitimated by the subsequent marriage of A and B. But it has not been settled what are the mutual rights of the children of the two marriages in such circumstances, though it appears that the legitimate-born children cannot be displaced by the legitimated bastard. The doctrine of legitimation *per subsequens matrimonium* is not recognised in England or Ireland, having been solemnly repudiated by the famous statute of Merton, and the maxim prevails there, 'once a bastard, always a bastard.' Legitimation is also recognised in Scotland, but not in England or Ireland, where the parents were not really married, though they both *bond-fide* believed themselves to be married. This is called a putative marriage. The law of Scotland on these subjects follows the canon law, and the French law is the same.

LEGS, HUMAN, are not unfrequently borne as charges in Heraldry, sometimes naked, sometimes booted, and they may be coupéd, i. e., cut evenly off, or erased, cut with a jagged edge, and that either at the thigh or below the knee. The knee when represented is always embowed. A remarkable device of three legs in armour, conjoined at the thighs, and flexed in triangle, forms the insignia of the ancient kingdom of Man (see fig.), with the appropriate motto, *Quocunque jeceris*

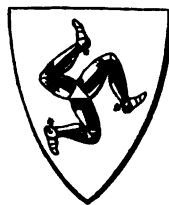

stabilis. 'The classical symbol of the island of Sicily (Trinacria) was formed of three naked legs similarly conjoined, and the triple-mountained Isle of Man might have awakened in its Norman sovereigns some recollections of their Mediterranean conquests.'—*Planché*.

LEGUME (*Legumen*), in Botany, a fruit consisting of a single carpel, two-valved, and with the seeds—one or many—attached to the ventral suture only. It is commonly called a *pod*, and occurs in most of the species of the great natural order *Leguminosæ* (q. v.), of which the Bean and Pea are familiar examples. The legume generally opens when ripe, and then both by the dorsal and ventral suture; whereas the *follicle*, which nearly resembles it, opens by a suture along its face, and is one-valved. A few legumes do not open, but the sutures are present. Some are divided by transverse partitions (*diaphragms*); and the kind called a *lomentum* is contracted in the spaces betwixt the seeds, and separates into pieces instead of opening.

LEGUMINE, or VEGETABLE CASEINE. The seeds of most leguminous plants (pease, beans, lentils, &c.), and of the sweet and bitter almond, contain a proteine or albuminous body, which in all its essential properties corresponds with the caseine of milk. For example, it is precipitated from its solutions by rennet, acetic acid, alcohol, &c., and is not coagulated by boiling; while, as in the case of milk, the application of heat occasions the formation of a pellicle on the surface. The affinity of the two kinds of caseine is further shewn by the fact, that cheese is made by the Chinese from pease and beans.

In order to obtain legumine, pease, beans, or lentils are well soaked in hot water, and after being reduced to a pulp, are mixed with a considerable quantity of water. The starch, membranes, &c., soon sink to the bottom, and the legumine must be precipitated by acetic acid from the decanted or filtered fluid. Dry pease contain about one-fourth of their weight of legumine.

LEGUMINOUSÆ (*Fabaceæ* of Lindley), a great natural order of exogenous plants, containing herbaceous plants, shrubs, and trees, many of them of the greatest magnitude. The leaves are alternate, usually compound, and have two stipules at the base of the leaf-stalk, which often soon fall off. The inflorescence is various. The calyx is inferior, 5-parted, toothed or cleft, the segments often unequal. The petals are 5, or, by abortion, fewer, inserted into the base of the calyx, usually unequal, often *Papilionaceous* (q. v.). The stamens are few or many, distinct or variously united. The ovary is 1-celled, generally of a single carpel; the style simple, proceeding from the upper margin, the stigma simple. The fruit is either a Legume (q. v.) or a *Drupe* (q. v.). The seeds are solitary or numerous, occasionally with an aril, often curved: the cotyledons very large.—There are three sub-orders: 1. *Papilionaceæ*, with papilionaceous flowers; 2. *Casalpinea*, with irregular flowers and spreading petals; 3. *Mimoseæ*, with small regular flowers.—This natural order contains almost 7000 known species, of which about 5000 belong to the sub-order *Papilionaceæ*. They are spread over all parts of the world, from the equator to the poles, but their number is greatest in tropical and sub-tropical regions. They are applied to a great variety of purposes, and some of them are of great importance in domestic economy, the arts, medicine, &c. To this order belong the Bean, Pea, Kidney-bean, and all kinds of *pulse*; Clover, Liquorice, Broom, Laburnum, Lupine, Senna, and many other medicinal plants; Tamarind, Logwood, Indigo, and many others

which afford dyes, &c.; the *Acacias*, *Mimosæ*, &c. Many species are interesting on account of their beauty of form, foliage, or flowers. In the seeds of many is found a nitrogenous substance called *Legumine* (q. v.) or *Vegetable Caseine*.

LEITA, an important trading town of India, in the Punjab, is situated in a fertile district on the left bank of the Indus, 60 miles south of Dera Ismael Khan. Lat. 31° N., long. 71° E. Besides being a mart for the sale of the produce of the surrounding district, it carries on an extensive transit-trade between the Punjab and the regions west of the Indus. Provisions, metals, grain, and cotton and wool, are the chief articles of sale. Pop. 15,000.

LEIBNITZ, GOTTFRIED WILHELM VON, perhaps the most extraordinary example of universal scholarship upon record, was born, July 8, 1646, at Leipzig, where his father was professor of law. He passed through the elementary studies at the 'Nicholas School' of his native city, under Thomasius; but he derived much more of the vast store of miscellaneous learning which his after-life exhibits from his private studies in a library to which he had access, and thus entered the university with peculiar advantages, in his 15th year, selecting the law as his profession, but devoting himself also to philosophy and literature. He spent some time at the university of Jena, and on his return, presented himself for the degree in law, for which he composed two essays of very remarkable merit. In consequence of his youth, however, he was refused the degree at Leipzig, and ultimately (in his 20th year), in 1666, graduated at Altdorf, where he was offered, but declined, a professorship; accepting in preference the post of secretary and tutor in the family of the Baron von Boineburg, to whom he rendered, from 1667 till 1672, a variety of literary and politico-literary services, and through whose recommendation he was appointed member of the judicial council in the service of the Archbishop-elect of Mainz. In 1672, he accompanied Boineburg's sons to Paris, and there submitted to Louis XIV. an essay entitled *Consilium Ægyptiacum*, containing a plan for the invasion of Egypt, which is by some supposed to have led to the Egyptian expedition of Bonaparte in 1798. In the course of this tour, which extended also to London, he formed the acquaintance of the most eminent philosophers of France and England, and among them of Newton. On the death of the Elector of Mainz, L., declining an appointment at Paris which would have necessitated his becoming a Catholic, entered the service of the Duke of Brunswick, and followed that prince, in 1676, as privy-councillor and librarian, to Hanover, where he permanently fixed his residence. His literary services to this court were of a very miscellaneous character. After a tour of historical exploration, he prepared a series of works illustrating the History of the House of Brunswick, seven volumes of which were published by himself, and two have been edited in our own time by Dr Perz, *Annales Imperii Occidentis Brunsvicensis* (1843—1845). He undertook likewise the scientific direction and organisation of the royal mines, into which he introduced many improvements; and he also, at the desire of the prince, took an active part in the negotiations for church union, and the theological discussions connected therewith, which formed the subject of a protracted correspondence with the celebrated Bossuet (q. v.) and with M. Pelisson, and led to the preparation, on his own part, of a very curious exposition of doctrinal belief (published from his MS. within this century, under the title *Systema Theologicum*), which, although written in the assumed character of a Catholic,

was intended to form a basis of negotiation. His private studies, however, were chiefly philosophical and philological. His correspondence on these subjects was most extensive, and he contributed largely to almost every literary and scientific journal of his day. He was the chief organiser of the Academy of Berlin, of which he was the first president, and originated both at Dresden and Vienna a project for the establishment of similar bodies. It was to him, likewise, that Peter the Great, who invited him to a meeting at Torgau, and bestowed on him a pension of 1000 rubles, with the title of privy-councillor, owed the plan of the since celebrated Academy of St Petersburg. On the accession of the Elector George to the crown of Great Britain, as George I., L. was disappointed in his expectation of accompanying the prince to his new court; nor did he long survive that event. His death, which was rather unexpected, occurred at Hanover, November 14, 1716. His biographers justly complain that his memory was treated with but little honour by his contemporaries; but a tardy atonement for their neglect has been recently offered by the erection of a public monument in his native city of Leipzig. The scholarship of L., as regards the vastness of its range, is probably unexampled. He was eminent in languages, history, divinity, philosophy, political studies, experimental science, mechanical science, and even belles-lettres. But it is chiefly through his philosophical reputation that he lives in history. It would be difficult to convey, in a popular sketch, a correct notion of his philosophical system, especially as he has nowhere himself methodised it. In the main, he may be described as a Cartesian, but he differed from Descartes both in his method and in some of his principles. The most important peculiarities of L.'s system may be reduced to four: his doctrine as to the Origin of Ideas, his theory of MONADS (q. v.), the 'Pre-established Harmony,' and the theory of OPTIMUM (q. v.). Of these, three will be found discussed under separate heads. The Pre-established Harmony requires a few words of explanation. The object of this singular conception was to explain the mysterious problem of the joint action of mind and body, or even in general the joint action of any two or more of the so-called 'monads,' since L. held that no two 'monads' could act upon each other. Descartes had resolved this problem by his theory of assistance, which attributed all action to the direct assistance of God. L., rejecting this hypothesis, supposed the mind and the body to be two distinct and independent machines, each having its own independent, though simultaneous action; but both so regulated by a harmony pre-established by God, that their mutual actions shall correspond with each other, and shall occur in exact and infallible unison. This harmony L. explained by the example of two time-pieces, one of which should be made to strike just as the other pointed to the hour. In the same way, just at the moment when the mind freely determines itself to a particular act, the body, by a harmony pre-arranged by God, will produce the particular action which is required to give efficacy to the volition of the mind. One of the most painful incidents in the literary and scientific history of L., was his controversy with Newton as to priority in the discovery of the method of the calculus. See CALCULUS, FLUXIONS. L. was the inventor of a calculating-machine, the working-model of which is still preserved at Göttingen. His works were first collected by Dutens, in 6 vols. 4to, Geneva; his philosophical works by Raspe, Amsterdam, 1767; and his letters at Lausanne and Geneva, 2 vols. 4to, 1745. But these collections are very imperfect, and large additions have been made of

late years, both in Germany and in France, especially by Dr Guhrauer, to whom we are also indebted for a biography. See Leibnitz, *Eine Biographie*, 2 vols. 8vo, Breslau, 1842.

LEICESTER, a town of England, municipal and parliamentary borough, and capital of the county of the same name, is situated on the right bank of the Soar, about 100 miles north-north-west of London. It contains numerous interesting churches, one of which, St Nicholas, is partly built of bricks from an ancient Roman building in the vicinity. Besides the ecclesiastical edifices, there are a number of important educational and benevolent institutions. Manufactures of boots and shoes, and of woollen and hosiery goods, lace-making, wool-combing and dyeing, are extensively carried on. L. is the centre of a famous agricultural and wool-raising district. There are about twelve fairs annually. The town of L. returns two members to parliament. Pop. (1861) 68,056.

L., known to the Romans as *Rata*, derives its present name either from Leire, the former name of the Soar, or from its having been a *Civitas Legionum*, a station or camp (*castra*) of the legions, which the Saxons would translate into Legeo-caester, corresponding to the British or Welsh *Caer-leon*. Under the Lancastrian princes, its castle, now almost entirely destroyed, was frequently a royal residence. The ruins of the abbey of St Mary Prê, or De Pratis, where Cardinal Wolsey died, still exist.

LEICESTER, ROBERT DUDLEY, EARL OF BORN in 1531, was the son of John Dudley, Duke of Northumberland. His father was executed on account of the part which he took in the cause of Lady Jane Grey, and he was himself imprisoned on the same account. He was liberated in 1564; and in 1568, on the accession of Elizabeth, the dawn of his fortune began. He was made Master of the Horse, Knight of the Garter, a Privy-councillor, High Steward of the university of Cambridge, Baron Dudley, and Earl of Leicester. For these high honours, he seems to have been indebted solely to a handsome person and a courtly manner, for the course of his life shews him to have been possessed of not one single quality either of head or heart deserving of admiration. When young, he married Amy, daughter of Sir John Robsart. The general voice of the times has charged him with being accessory to her murder; and it is certain that she died suddenly, and very opportunely for his ambitious views, he being at that time a suitor for the hand of Elizabeth. Elizabeth gave out that she wished him to marry Mary of Scotland; but in this the English queen was acting with her usual insincerity. She encouraged L. openly as a suitor long after his arrogance had disgusted the nobles, and his profligacy had brought him into disrepute with the nation. His marriage to Lady Essex for a time excited the anger of his royal mistress, but she soon forgave him. In 1585, he went into the Low Countries at the head of a military force; but on this, as on two subsequent occasions, he shewed himself utterly unfitted for command. He died suddenly, on September 4, 1588. It was commonly said that he was poisoned by his wife, she having given him a potion which he had intended for her.

LEICESTERSHIRE, an inland county of England, lies immediately south of the counties of Derby and Nottingham. Area, 514,164 acres; pop. 237,412. The surface of the county is covered throughout by low hills. The district in the south-west, still called 'Charnwood Forest,' retains its name, although it is now almost destitute of wood. The 'Forest' is occupied by hills, which, though

inconsiderable in height, are rugged, distinct, and individual in outline. From the highest of them, Bardon Hill, 853 feet in height, an extensive view is obtained. Chief rivers, the Trent, which forms for a few miles the boundary of the county, and its affluent the Soar. The climate is mild, and the soil, which varies in fertility, is chiefly loamy. The richest tracts are kept in pasture, for which this county is famous. In all, upwards of 250,000 acres are in grass. Grazing, and sheep and cattle breeding, are carried on with great skill and success. An improved long-horn is the favourite breed of cattle. The 'Stilton' variety of cheese is for the most part made in this county. Coal-mines are worked, and granite, coarse slate, and freestone are quarried. The county returns four members to parliament.

LEIGH, a small but rapidly increasing manufacturing town in Lancashire, England, a station on the Bolton and Liverpool Railway, is situated 13 miles west of Manchester. Silks, cambrics, muslins, and fustians, are extensively manufactured; cotton-spinning and weaving are carried on; there is a large foundry, where agricultural implements are extensively made; and in the vicinity are productive coal-mines and flour-mills. Pop. (1851) 5206; (1861) 10,621.

LEIGHTON, ROBERT, Archbishop of Glasgow, was born in Edinburgh, or, as others think, in London, in the year 1611. He entered the university of the former city in 1627, took his degree of M.A. in 1631, and afterwards proceeded to France. Here he resided with some relatives at Douay, and formed the acquaintance of several Roman Catholic students, whose Christian virtues confirmed the natural charity of his spirit. L., indeed, could never have been a bigot. Gentle, tender, and pious from his earliest years, he shrunk from all violence and intolerance; but his intercourse with men whose opinions were so different from his own, convinced him reason of the folly and sinfulness of 'thinking too rigidly of doctrine.' Returning to Scotland, he was appointed, in 1641, to the parish of Newbattle, near Edinburgh; but he was not militant enough to please his fierce co-presbyters. They appeared to him, who had studied far more deeply than any Scotchman of his time the various ecclesiastical politics of Christendom, truculent about trifles. According to Bishop Burnet, 'he soon came to dislike their Covenant, particularly their imposing it, and their fury against all who differed from them. He found they were not capable of large thoughts; theirs were narrow as their tempers were sour; so he grew weary of mixing with them.' Yet we cannot altogether approve the facility with which he fraternised with the party that had inflicted such horrid cruelties on his excellent father, Dr Alexander Leighton, in 1630, for merely publishing a book in favour of Presbyterianism. In 1652, he resigned his charge, and in the following year was elected Principal of the university of Edinburgh, a dignity which he retained for ten years. Earnest, spiritual, and utterly free from all selfish ambition, he laboured without ceasing for the welfare of the students. After the restoration of Charles II., L., who had long separated himself from the Presbyterian party, was, after much reluctance, induced to accept a bishopric. He chose Dunblane, because it was small and poor. Unfortunately for his peace, the men with whom he was now allied were even more intolerant and unscrupulous than the Presbyterians. The despotic measures of Sharpe and Lauderdale sickened him. Twice he proceeded to London (in 1665 and 1669) to implore the king to adopt a milder course—on the former of these

occasions declaring 'that he could not concur in planting of the Christian religion itself in such a manner, much less a form of government.' Nothing was really done, though much was promised, and L. had to endure the misery of seeing an ecclesiastical system which he believed to be intrinsically the best, perverted to the worst of purposes, and himself the accomplice of the worst of men. In 1670, on the resignation of Dr Alexander Burnet, he was made Archbishop of Glasgow; an office which he accepted only on the condition, that he should be assisted in his attempts to carry out a liberal measure for 'the comprehension of the Presbyterians.' His efforts, however, were all in vain; the high-handed tyranny of his colleagues was renewed, and L. felt that he must resign, which he did in 1673. After a short residence in Edinburgh, he went to live with his sister at Broadhurst, in Sussex, where he spent the rest of his days in a retired manner, devoted chiefly to works of religion. He died June 25, 1684. L.'s best works (he published nothing during his lifetime) are to be found in an edition published at London (4 vols. 1825). All his writings are pervaded by a spirit at once lofty and evangelical. The truths of Christianity are set forth in the spirit of Plato. It was this that recommended them so much to Coleridge, whose *Aids to Reflection* are only commentaries on the teaching of the saintly archbishop.

LEIGHTON-BUZZARD, a market-town of England, Bedfordshire, is situated in a large agricultural district, 40 miles north-north-west of London. It has claims to considerable antiquity—its church was erected in the beginning of the 13th c., and in its market-place is an ancient and elegant pentangular cross. Many of the inhabitants are employed in making straw-plait. Pop. (1861) 4882.

LEININGEN, the name of one of the wealthiest of the mediatised Houses of Germany, was formerly applied to a German county in the district of Worms and Spires, with which, in the beginning of the 13th c., the county of Dachsburg became connected as part of the family possessions. The family is one of the oldest still existing in Germany. In 1779, the head of one of the branches into which it had become divided, the Count of Leiningen-Hardenburg-Dachsburg, was raised to the rank of a prince; but the peace of Lunéville deprived him of his ancient possessions—about 252 square miles in extent, on the left bank of the Rhine. He received, however, a compensation in other parts of Germany; and though no longer an independent prince, he retains his rank and wealth, his possessions being within the territories of Baden, Bavaria, and Hesse.

LEINSTER, one of the four provinces of Ireland, occupies the south-east portion of the country, and is bounded on the E. by St George's Channel and the Irish Sea. Area, 4,876,211 acres; pop. (1861) 1,439,596. At the period of the invasion by England (1170), this province formed two kingdoms, those of L. and Meath. Previously to the reign of Henry VIII., the province had been divided into the counties of Dublin, Meath, Louth, Kildare, Carlow, Kilkenny, and Wexford. The following counties were erected subsequently: Wicklow, formed from a portion of the county of Dublin; West Meath and Longford, from a part of Meath; and King's and Queen's Counties formed out of part of Kildare.

LEIPOA, a genus of gallinaceous birds, of the family *Megapodidae*, of which the only known species is *L. ocellata*, a native of Australia, inhabiting sandy and bushy plains. It is called L.,

or NATIVE PHEASANT, by the colonists. Like the Australian jungle-fowl, the L. constructs mounds of sand, or earth, and leaves, in which to lay its



Leipoa (*Leipoa ocellata*).

eggs. More than a dozen are often found in a nest. They are about three times as large as those of a common fowl; and are much esteemed as food. When pursued, it seeks to escape rather by running and hiding in the bush, than by the use of its wings. Few birds seem more likely to prove useful in domestication than the Leipoa.

LEIPZIG (formerly *Libiziki*, said to mean the home of the linden or lime trees, from the Slavic *Lip* or *Lipa*, a lime-tree), a city of the kingdom of Saxony, situated about 65 miles west-north-west of Dresden, near the Prussian border, in a large and fertile plain. The Elster, the Pleisse, and the Parthe flow through or past the city, and unite about 3 miles below it. The inner or ancient city was formerly surrounded by walls, which have now disappeared, but it is still separated from the far more extensive suburbs (*Friedrichs-stadt*, *Johannes-stadt*, &c.) by promenades planted with beautiful avenues of lime and chestnut trees. Many of the streets of the inner city are narrow and crooked; those of the more modern part (which contains also a number of fine squares) are wide and well built. The sanitary state of the city has been much promoted by an extensive and costly system of sewers. The inner city is the principal seat of business and merchandise. Pop. (1861) 78,495, of whom 1300 are Catholics, and 400 Jews; the rest are Protestants, mostly belonging to the Lutheran Church. Of the public buildings of L., few are in any way remarkable. The best is the Augusteum, the seat of the university, finished, according to designs by Schinkel, in 1836. The court has a splendid appearance. Of the three castles which formerly existed, only one remains, the Pleissenburg, now used for government offices and barracks; and, a portion of it, as a wool-store; the ditch has become a place for drill; and the tower, an observatory. L. is the seat of courts and public offices for a large district, as well as of those properly belonging to the city itself. It has many benevolent institutions, and also many educational institutions, including the university and two gymnasia. The university owes its origin to the removal of a large number of German students from Prague to L. in 1409, in consequence of disputes between the Bohemians and Germans. It opposed a strenuous resistance to the Reformation. It has always maintained a high reputation among the universities of Germany, and many distinguished

names are connected with it. Connected with the university are 60 professors, and 70 private teachers. The number of students is about 800. In the early part of the present century, the number amounted to about 1300. The University Library contains 150,000 volumes and 2000 manuscripts, and there are also in connection with the university a botanic garden, and a number of museums devoted to different departments of science. The City Library contains 80,000 volumes and 2000 manuscripts. There are a number of scientific associations, and various associations and institutions for the cultivation of the fine arts. In particular may be mentioned the conservatorium of music, which is reckoned one of the first in Europe. See CONSERVATOIRE.

The three annual fairs (held at Easter, Michaelmas, and the New Year, and lasting from three to five weeks) add much to the importance of L., and render it, with the exception of Hamburg, the greatest seat of trade in Germany. The origin of these fairs is traced back for more than 600 years. They are attended by Jews, Turks, Greeks, Armenians, Persians, and even (of late) by Chinese. The accession of Saxony to the German Customs' Union, (*Zollverein*), and the opening of railways, have of late years produced a great increase of the concourse and of the business at these fairs, which had previously begun to decline. Transactions to the extent of 70,000,000 thalers (above £10,000,000 sterling) now take place at an Easter fair. The wool-market, which was instituted in 1826, and is held for three days in June, is much frequented.

L. is the principal seat of the book-selling and publishing trade in Germany, and indeed, in this respect, ranks third among the cities of the world, coming immediately after London and Paris. Upwards of 150 houses are engaged in the book-trade. There were also, in 1854, 35 printing establishments. Here the German booksellers have founded a common exchange, and annual settlements of accounts take place at the Easter Fair. One thousand houses are then represented by their commissioners at Leipzig. In consequence of this activity, L. has become the principal seat of type-founding in Germany. Among its other manufactures are pianofortes, scientific instruments, wax-cloths, oils, chemical products, perfumes, &c.

The city sprung up round a castle built by King Heinrich L., at the junction of the Pleisse and the Parthe. It is first mentioned as a town in 1015, and in the latter part of the 12th c., had from 5000 to 6000 inhabitants. It gradually increased in prosperity and importance. The famous *Leipzig Conference* between Luther, Eck, and Carlstadt, in 1519, greatly tended to the promotion of the Reformation. L. suffered greatly in the Thirty Years' War, in which it was five times besieged and taken, and again in the Seven Years' War; and although the commercial changes connected with the French Revolution at first affected it very favourably, yet it suffered not a little amidst the terrible struggles of the years 1812 and 1813, when it was alternately in possession of the French and of the allies.

The immediate neighbourhood of L. has been the scene of two battles of great importance in the history of Germany and of Europe—the battle of Leipzig, or of Breitenfeld (q. v.), on September 7, 1631; and the great battle of Leipzig—called the *Battle of Nations*, which continued for three days—from the 16th to the 18th of October 1813. The latter was one of the most bloody and decisive of those which effected the deliverance of Europe from French domination. The troops under Napoleon in this battle amounted to about 180,000 men, and those of the allies, commanded by Prince Schwarzenberg,

Marahal Blucher, and Bernadotte, Crown-prince of Sweden, to almost 300,000. About 2000 pieces of artillery were brought to the field. The loss of the French was reckoned at about 38,000 killed and wounded, and 30,000 prisoners; that of the allies to about 48,000. The victory of the allies was complete, and the French were compelled to evacuate L., and to retreat towards their own country.

LEITH, an important seaport, a municipal and parliamentary burgh of Scotland, on the southern shore of the Firth of Forth, at the mouth of the Water of Leith, two miles north of Edinburgh, with which it is now connected by a continuous line of houses. Although not without many fine edifices, the town, as a whole, is rather mean in appearance, being irregular and dingy, especially in the older and central parts. The Custom-house, Town-hall, Royal Exchange, and recently-erected Corn Exchange, are handsome buildings. West of the town, on the shore, is Leith Fort, an artillery station. L. is connected by branch-lines with the various railways centring in Edinburgh. The harbour extends, by means of two piers, upwards of a mile into the Firth, and has a depth of from 20 to 25 feet at high-water. There are already three wet-docks, containing an area of 15 acres; and two new docks of large dimensions are in contemplation. There are six graving-docks; one of them, recently finished, being 400 feet long by 80 feet broad (at coping), and 24 deep on sill at spring-tides. In 1862, 4761 vessels, of 930,670 tons, entered and cleared the port. The trade of L. is chiefly in colonial and foreign produce. Among the imports for 1862 were 481,530 qrs. wheat; 213,538 qrs. barley; 47,075 qrs. oats; 51,547 qrs. beans and pease; 11,746 qrs. Indian corn; 86,192 sacks and barrels of flour; 68,352 loads of timber; 14,604 tons of guano. Wine and tobacco are also extensively imported. The Customs Duties for 1861 amounted to £472,433. The chief manufactures are ships (in wood and iron), machinery, sailcloth, ropes, ale, rectified spirits, soap, bottles, flour (for which there are extensive mills). Pop. 33,530. L. unites with Portobello and Musselburgh in sending a member to parliament.

LEITRIM, a county of the province of Connaught, in Ireland, which reaches the sea on the Bay of Donegal, but is encircled on its other sides by the counties of Donegal, Fermanagh, Cavan, Longford, Roscommon, and Sligo. Area, 613 square miles, or 392,363 acres, of which 249,350 are arable, and 23,784 are covered by water. The surface of L. is irregular. It is divided into two parts by a considerable lake called Lough Allen. The southern division is broken up by low narrow ridges, which enclose numerous small lakes, the chief of which is called Lough Rinn. The more level portion of this division of the county forms part of the great limestone plain of Ireland, and contains some excellent arable and pasture land. The northern division is much more irregular in surface, being intersected by several ridges of considerable elevation. To the north of Lough Allen the soil, except at rare intervals, is unfavourable for agriculture, and the climate is damp and ungenial. The principal crops are potatoes, oats, and hay; but, on the whole, the condition of the agriculture is very backward, the total number of acres under crops of all kinds having been, in 1861, 89,864, and in 1862, 86,457. L., however, is more a grazing than a tillage district. Large quantities of horned cattle are raised in the southern division. The total number of cattle in 1862 was 76,891; of sheep, 13,442. Turf is abundant in all parts of the county. The population in 1861 numbered 104,615, of whom 93,844

were Roman Catholics, 9516 Protestants of the Established Church, and the rest Protestants of other denominations. The number of children receiving education in the schools of the Board of National Education in 1861 was 14,969, of whom 13,716 were Roman Catholics. The river Shannon (q. v.) enters this county near its source in Cavan, and traversing Lough Allen, passes out at the southern extremity of Leitrim. Of other rivers, the Bonnet, the Yellow River, and the Daff, may be specially mentioned. The only towns of any note are Carrick-on-Shannon, Manor-Hamilton, and Mohill. The northern division of the county is more rich in minerals than most districts of Ireland. Coal is found in the Lough Allen basin, the chief working-beds being in the Slieve-an-Ierin Mountains, where coal is raised for smelting purposes. In the same district is found iron, the ore of the Arigna mines yielding as much as 58.2 per cent. of metal. Lead ore is also abundant, although the mining operations have been discontinued. The occupation of the people being chiefly agricultural, there are hardly any manufactures.

L. anciently formed part of the territory of Breifne O'Rourk. It was reduced to the English submission in the reign of Elizabeth, but revolted in 1588, submitting once more in 1603, when the O'Rourk accepted a patent of the residue of his estate. The confiscations which followed the great civil war may be said to have extinguished the native proprietary and the family of O'Rourk.

LELAND, JOHN, D.D., an English divine and apologist for Christianity, was born at Wigan, in Lancashire, in 1691, became a dissenting minister in Dublin in 1761, and first appeared as an author in 1733, by publishing a reply to Tindal's deistical work, *Christianity as Old as the Creation*. In 1737, appeared another apology, *The Divine Authority of the Old and New Testament asserted against the Unjust Aspersions and False Reasonings of a Book entitled 'The Moral Philosopher.'* As the learning displayed in these works was great, and the abilities considerable, the university of Aberdeen conferred on L. the degree of D.D. His best work is *A View of the Principal Deistical Writers that have appeared in England*. It once held a high position in Christian apologetic literature, and many people still regard it as a satisfactory demolition of deism. L. died in 1766. To his honour it should be added, that though his life was one of controversy, the spirit of fairness and charity never forsook him.

LELY, SIR PETER (PETER VANDER FAES), was the son of one Vander Faes, a captain of a regiment of infantry, who was generally called Le Capitaine du Lys, or Lely, from having been born at the Hague, in a house the front of which was decorated with a fleur-de-lis. L. was born at Soest, in Westphalia, in 1618. His father placed him in the school of Peter Grebber, a painter of talent at Haarlem, where he remained two years. He commenced his career as a painter of landscapes and subjects from history; but his talent induced him to devote himself exclusively to portrait-painting, and soon after the death of Van Dyck, he settled in London. He was employed successively by Charles I., Cromwell, and Charles II., who nominated him court-painter, and conferred on him the honour of knighthood. He had great facility of execution, and his style, though deficient in all the higher qualities of art, was well suited for his position as the favourite portrait-painter of such a court as that of his chief patron. There is a large collection of his portraits at Hampton Court, well known to the numerous visitors of

the public apartments there as the Beauties of the Court of Charles II. He died in London in 1680.

LE'MAN, LAKE. See GENEVA, LAKE OF

LE'MBERG (formerly *Löwenburg*, 'city of the lion'; i. e., of Leo Danielowicz, Prince of Halicz, who founded it in 1259; Polish name, 'Liwów'), the capital of the Austrian kingdom of Galicia and Lodomeria, is situated on a small stream called the Peltew, in a narrow basin among hills. Lat. 49° 50' N., long. 24° E. Pop. 68,000, of whom 24,000 are Jews. L. is the seat of a Roman Catholic, a Greek United, and an Armenian archbishop, and has 29 (it once had 50) churches. It is one of the finest towns in Austria, yet the houses are, for the most part, roofed with shingle. The synagogues in particular are very beautiful. The university (*Alma Franciscæ*), founded in 1784, has 35 professors and 1000 students. The university library contains 40,000 volumes, 350 MSS., and a collection of coins, amounting to 10,000. Here also is the seat of the institute founded by Ossolinaki, with a library of 60,000 volumes, and 1200 MSS., chiefly of Polish literature. The trade and manufactures of L. are of great importance. The town is now regularly fortified.

LEMMA (Gr. a thing assumed), a preparatory proposition introduced for the purpose of rendering the demonstration of a theorem or construction of a problem more perspicuous. The term is confined to the science of mathematics.

LEMMING (*Lemmus* or *Georychus*), a genus of rodent quadrupeds, of the family *Muridae*, and subfamily *Arvicolidae*, nearly allied to voles, but differing from them in the extreme shortness of the ears and tail, and in having larger and stronger claws, more adapted for digging. They are also more heavily formed. The most noted species is the Scandinavian L. (*L. or G. Norvegicus*), an animal of about



Lemming (*Lemmus Norvegicus*).

five inches long, with variegated black and tawny fur, an inhabitant of the northern Scandinavian mountains, where it ordinarily feeds on reindeer-moss and other lichens, grass, catkins of birch, &c. But, breeding often in the course of a year, and producing four or five at a birth, it multiplies so much, that, periodically, vast troops leave their native regions, migrating either toward the Atlantic Ocean or the Gulf of Bothnia. Bears, wolves, foxes, lynxes, follow and prey upon them. Hawks and owls also attend, and contribute to the diminution of their numbers. It is said that those which survive, after spending a winter in the region to which they have migrated, seek to find their way back to their original abode. In times of prevalent superstition, lemmings were often exorcised by the priests, and the peasantry of Norway supposed them to fall from the clouds. The Laplanders eat the lemming.

LEMNIAN EARTH, a mineral found in the island of Lemnos; massive, chalk-like, soft, yellowish gray, or whitish, and falling to powder in water. It consists of about 66 per cent. silica,

with 14 of alumina, and a little oxide of iron, soda, and water. It long had a great and undeserved reputation in medicine, and being sold in little pieces, each stamped with a particular stamp, it acquired the name of *Terra Sigillata* (Sealed Earth). The belief in its medicinal power is of very great antiquity. The stamp in ancient times, Galen says, was the head of Diana, the tutelary goddess of Lemnos; but is now only the Turkish name of the mineral. The ancients had more than one legend respecting the discovery of the virtues of Lemnian Earth.

LE'MNOS (now commonly called *Stalimne*), an island in the northern part of the Grecian Archipelago, about 40 miles west of the entrance to the Dardanelles. It is irregular in shape, and is nearly divided into two islands, by two deep bays—Port Paradise on the north, and Port St Antony on the south. Area, 150 square miles. Pop. about 12,000. The women are famed for their beauty. It is hilly, rather bare of wood, and bears unmistakable traces of volcanic action at an early period, which fact probably originated the ancient myth of Vulcan lighting on this island when Jupiter hurled him from heaven. Moschylos, a volcano, no longer active, was believed to be the workshop and favourite residence of this deity. The principal product of L. is the *Lemnian Earth* (q. v.), used in ancient times as a cure for wounds and serpent-bites, and still highly valued by both Turks and Greeks. The chief town, Kastro (on the site of the ancient *Myrina*), has a population of 2000. It furnishes excellent sailors.

LEMON (*Citrus Limonum*), a tree which has by many botanists been regarded as a variety of the Citron (q. v.), and, like it, a native of the north of India. Its leaves are ovate or oblong, usually serrulate, pale green, with a winged stalk; the flowers are streaked and reddish on the outside; the fruit is oblong, wrinkled or furrowed, pale yellow, with generally concave oil-cysts in the rind. In the



Lemon (*Citrus Limonum*).

common variety, which is very extensively cultivated in many tropical and sub-tropical countries, the pulp of the fruit is very acid, abounding in citric acid. There is, however, a variety called the Sweet L., occasionally cultivated in the south of Europe, of which the juice is sweet. It is *Citrus Lumia* of some botanists, and has both concave and convex oil-cysts in the rind. The acid juice of the

common L. is much used in the preparation of the well-known cooling beverage called *Lemonade*, and is also administered in various forms in febrile and scorbutic complaints. It is much used by calico-printers to discharge colours, to produce greater clearness in the white part of patterns, dyed with dyes containing iron. As a preventive of sea-scurvy, it is an important article of sea-stores. Citric acid and lemon-juice are likewise made from it in great quantities. The rind of the fruit (*Lemon-peel*), separated from the pulp, and kept in a dried state, is a grateful stomachic, and is much used for flavouring. The produce of the lemon-groves of Italy, the Tyrol, Spain, Portugal, the south of France, and other countries bordering on the Mediterranean Sea, is largely exported to more northern regions. Sicily alone exports annually 30,000 chests, each containing 440 lemons. The L.-tree is very fruitful; it is more hardy than the orange, and in some parts of the south of England produces very good crops, being trained to a wall, and protected by a movable frame in winter.—The L. is supposed to have been introduced into Europe during the Crusades. It is almost naturalised in the south of Europe. It is so completely naturalised in some parts of the south of Brazil, that the flesh of the cattle which pasture in the woods acquires a strong smell of lemons, cattle being very fond of the fallen fruit.

LEMONADE is formed by adding two lemons sliced, and two ounces of white sugar, to a quart of boiling water, and digesting till cold. It is a useful drink for allaying thirst, and as a refrigerant in febrile and inflammatory complaints, and in hæmorrhage, in which cases it should be given iced.

LEMON-GRASS (*Andropogon schamanthus*), a beautiful perennial grass, three or four feet high, with panicle mostly leaning to one side, and spikelets in pairs, or, if terminal, in threes. It is a native of India, Arabia, &c., and is extremely abundant in many places. It has a strong lemon-like fragrance, oppressive where the grass abounds. It is too coarse to be eaten by cattle except when young, and is therefore often burned down. Europeans in India make an agreeable stomachic and tonic tea of the fresh leaves. By distillation, an essential oil is obtained (*Lemon-grass Oil*), which is employed externally as a stimulant in rheumatic affections, and is yellow, with a strong lemon-like smell. This oil is used in perfumery, and is often called *Oil of Verbena* by perfumers. L. has been introduced into the West Indies, Australia, &c. See also GRASS OIL.

LEMON-JUICE is a somewhat opaque, very sour liquid, obtained from lemons by expression and straining. Its acidity is due to the presence of citric and a little malic acid. Its principal uses in medicine are the following: 1. As an anti-scorbutic.—‘Those only,’ says Sir Gilbert Blane, ‘who have made themselves acquainted with the early part of the naval history of this country, can duly appreciate the value of this simple remedy.’ Its active principle, citric acid, is now frequently substituted for it. 2. In rheumatism.—Dr G. O. Rees, who first employed it in this disease, ‘considers the citric acid to undergo changes in the stomach, and to supply oxygen to such elements as tend to produce uric acid, and thereby to induce the formation of urea and carbonic acid instead.’ 3. In the formation of effervescent draughts.—A scruple of bicarbonate of potash in solution, mixed with about three drachms and a half of lemon-juice, so as to form a citrate of potash, forms an excellent effervescent draught; it acts as a mild diaphoretic and diuretic, tends to allay febrile disturbance, and serves to check nausea and vomiting. If the object is

specially to determine to the skin, a draught composed of a scruple of sesquicarbonate of ammonia in solution, with six drachms of lemon-juice, so as to form a citrate of ammonia, is preferable. Effervescent draughts are often employed as agreeable vehicles for the exhibition of other remedies.

LEMONS, OIL or ESSENCE OF, is extracted from the minute cells which are visible on the rind of the lemon, by submitting raspings of the fruit to pressure in hair sacs. It may also be obtained by distilling the peel with water; but its flavour, when obtained in this way, is less agreeable, although the oil itself is purer, owing to the absence of mucilaginous matter. The distilled oil is sold under the name of *scouring-drops*, for removing grease-spots from silks and other fabrics. Pure oil of lemons is mainly composed of a hydrocarbon, *citren* or *citronyl*, $C_{10}H_{16}$, which is consequently isometric with oil of turpentine, with which it is often adulterated. It is principally used for the purpose of communicating an agreeable odour to other medicines, although it is sometimes taken in the dose of two or three drops on sugar as a carminative. From its agreeable scent, it is often added to evaporating lotions and to ointments.

LEMONS, SALT OF, a name commonly but improperly applied by druggists to binoxalate of potash mixed with a little of the quadroxalate. This mixture occurs in the *Oxalis acetosella*, and hence it has been designated *Salt of Sorrel*. It is employed in taking out ink-spots.

LEMPRIERE, JOHN, D.D., born in Jersey about 1760, was educated at Westminster School and Pembroke College, Oxford, and died February 1, 1824. His name was once well known to every classical student in the British empire, but the rising generation is forgetting it, and it will soon become *vox et prætereia nihil*. L.’s *Classical Dictionary* (*Bibliotheca Classica*, 1788) was for many years the standard work of reference in England on all matters of ancient mythology, biography, and geography. To elderly scholars, the name will call up many pleasant memories of years long gone by; but the book itself ceased to possess any intrinsic value after the publication of the magnificent classical dictionaries edited by Dr William Smith, 1842—1853. Another work of L.’s was *Universal Biography* (Lond. 1808).

LEMUR, a genus of mammalia which gives its name to the family *Lemuridae*, a family allied to monkeys, and, like them, quadrumanous, having on each of the four extremities a well-developed thumb



Lemur.

opposed to the fingers, but in other respects exhibiting an approach to the ordinary quadrupedal type. The general form is slender and elongated, the muzzle pointed, the eyes large, the ears very small, the hind limbs longer and larger than the fore limbs.

The molar teeth are furnished with pointed tubercles fitting into each other, as in *Insectivora*, and the whole dentition of many of the family is adapted to animal rather than vegetable food. All the *Lemuridae* are natives of the warm parts of the old world, and live chiefly in forests, most of them climbing trees with all the agility of monkeys. The name L. (Lat. *lemur*, a ghost) is allusive to their rapid and peculiar noiseless movements. They are graceful and beautiful creatures, and generally gentle and easily tamed; but they have neither the prying and mischievous dispositions, nor the intelligence of monkeys. The species of the genus L., as now restricted, are all natives of Madagascar. They are gregarious, and their food consists partly of fruits. The names *Maki* and *Macauco* are given to some of them, and sometimes extended to all. The largest species is about the size of a large cat.—To the L. family belong also the Loria, Indris, Galagos, and Tarsiers.

LEMURES, the general designation given by the Romans to all spirits of departed persons, of whom the good were honoured as Lares (q. v.), and the bad (*Larvæ*) were feared, as ghosts or spectres still are by the superstitious. Like the latter, they were said to wander about during the night, seeking for an opportunity of inflicting injury on the living. The festival called *Lemuria* was held on the 9th, 11th, and 13th of May, and was accompanied with ceremonies of washing hands, throwing black beans over the head, &c., and the pronunciation nine times of these words: 'Begone, you spectres of the house!' which deprived the L. of their power to harm. Ovid describes the Lemuria in the fifth book of his *Fasti*.

LENA, an important river of Eastern Siberia, rises amid the mountains on the north-west shore of Lake Baikal, in the government of Irkutsk, flows first in a north-eastern direction to the town of Jakutsk, then north to the Arctic Ocean, into which it falls by several mouths. Its course is 3000 miles in length, and its chief affluents are the Vilui on the left, and the Vitim, the Olekma, and the Aldan on the right. Navigation on the L. is open from May till November. During spring, the waters of the river regularly overflow their banks. Near the town of Jakutsk, the breadth of the river is 6½ miles. L. is the principal artery of the trade of Eastern Siberia. Russian and Chinese goods, as well as Siberian furs, furnished by the natives, are exported from this river. The chief harbours on the river are Olekminsk, Jakutsk, and Kachugak, where £50,000 worth of goods from Irkutsk are shipped annually.

LENCZI'ZA, an ancient Polish town, in the government of Warsaw, about 90 miles west-south-west of the city of that name. It contains the ruins of a castle of Kazimir II., erected in 1180. Pop. 5955, half of whom are Germans and Jews. Linen and woollen cloths and soap are manufactured.

LENKORAN, a Russian seaport on the Caspian Sea, and a district town in the government of Baku, in the Caucasus, in lat. 38° 48', is a place of great importance for the trade between Russia and Persia; but a defective harbour, and the vicinity of warlike tribes, have hitherto rendered its natural advantages of little avail. Pop. 5644.

LENNEP, JAN DANIEL VAN, a Dutch philologist, was born at Leeuwarden, in the province of Friesland, in 1724, and studied at Franeker and Leyden. In 1752, he was appointed Professor of Ancient Languages at Groningen, and fifteen years afterwards at Franeker. He died in 1771. The works which principally obtained him a reputation for learning and acuteness, are his *Etymologicum Linguae Græcæ*, and his *De Analogiâ Linguae Græcæ*, both of which

were posthumously published. The progress of etymological science, however, has rendered them useless.—**DAVID JACOB VAN LENNEP**, a member of the same family as the preceding, was born at Amsterdam, 15th July 1774, devoted himself to the study of philology, and ultimately became Professor of Rhetoric at Leyden. He died 10th February 1853. Besides being one of the best Latinists among his countrymen, he wrote several exquisite pieces of poetry in his mother-tongue. His principal writings are *Carmina Juvenilia* (Amst. 1791), *Exercitationes Juris* (Leyd. 1796), valuable annotated editions of some of the classic authors, and a metrical Dutch translation of the *Works and Days* of Hesiod (Amst. 1823).—His son, **JACOB VAN LENNEP**, born at Amsterdam, 25th March 1802, is proudly called by his countrymen, the 'Walter Scott of Holland.' Educated for the law, he passed as a barrister, and soon achieved a great reputation for legal knowledge. Yet without neglecting his extensive practice, he has for more than thirty years cultivated literature with untiring assiduity, and, considering the drudgery of his professional work, with astonishing success. L. first appeared as an author shortly before 1830, in a work entitled *Vaderlandsche Legendes* (National Legends). Since then, his most popular works have been the comedies, *Het Dorp aan die Grenzen* (The Frontier Village, 1830), *Het Dorp over die Grenzen* (The Village over the Frontier, 1830), and the novels, *Onze Voorouders* (Our Forefathers), *De Roos van Dekama* (The Rose of Dekama, 1837—English by Woodley, 1847), and *De Pleegzoon* (The Adopted Son—English by Hoskins, New York, 1847). L., who possesses a remarkable knowledge of the English language and literature, has translated into Dutch some of Shakspeare's finest plays, and of Byron, Southey, and Tennyson's poems. A complete edition of his dramatic works, comprising tragedies, comedies, and operas, appeared at Amsterdam in 1852—1855. He has been engaged for several years on an edition of the great Dutch poet Vondel.

LENNOXTOWN, a village of Stirlingshire, Scotland, is situated in a picturesque district on Glazert Water, at the terminus of the Campsie Railway, eleven miles north-north-east of Glasgow. It contains (1861) 3184 inhabitants, employed chiefly in the print-works and alum-works in the immediate neighbourhood.

LENOCI'NIUM is a term borrowed from the canon law, and used in English, but more frequently in Scotch law to denote a husband's connivance in his wife's adultery. The wife can set up such defence to a suit for divorce, on the ground of her adultery so procured.

LENS (Lat. 'a lentil') is a thin circular section of any transparent substance, adapted to magni-



Fig. 1.—Lenses.

1, double-convex; if the surfaces are of equal curvature, equal-convex; 2, plano-convex; 3, convexo-plane; 4, double-concave, or concavo-concave; 5, plano-concave; 6, concavo-plane; 7, convexo-meniscus; 8, concavo-meniscus; 9, convexo-concave; 10, concavo-convex. The arrow shows the direction in which the light is supposed to fall upon the lenses.

fying purposes by having its two surfaces either both spherical, or one of them plane and the other spherical. The above figure represents, in

transverse section through their centres, the different forms of lenses. All these separate forms are arranged into two classes, those which are thickest, and those which are thinnest, in the centre, the first being generally denominated *convex*, and the second *concave* lenses. The effect produced by lenses upon rays of light passing through them, is, as in prisms, to bend the rays towards the thickest part of the lens; so that when a pencil of parallel rays passes through a convex lens, the emergent rays are *Convergent* (q. v.), while, if a concave lens be used, they are *Divergent* (q. v.), and the point to which the rays converge, or from which they diverge, approaches nearer to the lens as its curvature increases. This point is called the principal focus, and is real, i. e., the rays actually pass through it, for a *convex* lens; but virtual or imaginary, for one that is concave. As a simple illustration of the mode in which this point is determined, we shall take the case of parallel rays falling directly upon a double convex lens (fig. 2). Here, O is the centre of the curved surface PAP', and O' of the surface PBP'; q is the point towards which the rays tend while passing through the lens, and F the point to which they converge after emergence. Let OA = r, O'B = s, Ag = f, and BF (the focal length) = f; then, if

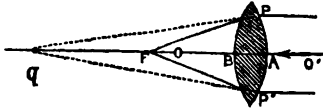

Fig. 2.

the thickness of the lens is so small as to be neglected, which may always be done when the curvature of the lens is small, Ag = Bq, and AF = BF. By the demonstration given under the article

DIOPTRICS, we find $f' = \frac{\mu}{\mu - 1} r$, for the refraction at the first surface; and, for the second surface, we find, in the ordinary treatises on Optics, that when a pencil of converging rays emerges from a lens, $\frac{\mu}{f'} = \frac{\mu - 1}{s} - \frac{1}{f}$. Adding this formula to the former, we obtain $0 = (\mu - 1) \left(\frac{1}{r} + \frac{1}{s} \right) - \frac{1}{f}$ or $\frac{1}{f} = (\mu - 1) \left\{ \frac{1}{r} + \frac{1}{s} \right\}$; and if the lens be equi-convex (r = s), and of glass ($\mu = \frac{3}{2}$), we have $\frac{1}{f} = \frac{1}{r}$, or $f = r$.

This result is equally correct for a double concave lens; but if the thickness of the lens be taken into account, there is a small quantity which is additive to the value of $\frac{1}{f}$ in the convex, but subtractive in the concave lens. The determination of the principal focus in the other and less common forms of lenses, will be found in any of the ordinary text-books. All the lenses figured in fig. 1, though they may be of the same focal length, have peculiar properties which render them suitable for particular optical instruments; thus, the convexo-plane lens has only one-fourth of the aberration of a plano-convex, or two-thirds of an equi-convex or equi-concave of the same focal length—but, in general, the equi-convex is the most desirable form of lens. This aberration* has been to opticians what refrac-

* The directions which have been given for finding the foci of lenses, apply only to rays which pass through and near the centre of the lens; the rays which pass near the edges converge to a different focus, and the distance between these two foci is called the longitudinal aberration.

tion is to the astronomer, an unwelcome intruder, which spoils his finest theories, and sets a limit to the accuracy of his results. But, in the case of lenses, the aberration has been destroyed by combining lenses of equal and opposite aberrations, as, for instance, uniting, by means of Canada balsam, a double convex with a double concave. A still better method would be the formation of lenses having one side spherical, and the other of an ellipsoidal or a hyperboloidal form; this, however, has not yet been successfully accomplished.

LENT (Ang.-Sax. *lencen* = Ger. *lenz*, spring; Gr. *Tessaracoste*; Lat. *Quadragesima*), the fasting-time before Easter, which is observed in the Roman, and in the Greek, and other Oriental churches. Under the head of FAST have been considered the doctrinal and historical questions connected with the general practice of fasting. It remains only to explain briefly what is peculiar in the institution and the observance of the Lenten fast. It is certainly of very ancient, if it be not even of primitive institution. The earliest allusions to it speak of it as an established usage handed down from the Fathers. The forty days' period, as commemorative of our Lord's forty days' fast, or of the similar perfunctory fasts of Moses and of Elias, commences with Ash-Wednesday, between which day and Easter-Sunday (omitting the Sundays on which the fast is not observed), forty clear days intervene. The rigour of the ancient observance, which excluded all flesh, and even the so-called 'white meats,' is now much relaxed; but the principle of permitting but one meal, with a slight refection or collation, is everywhere retained. In Spain, during the Crusades and the wars with the Moors, a practice arose of permitting, in certain cases, the substitution of a contribution to the holy war for the observance of the Lenten abstinence; and although the object has long since ceased, the composition is still permitted, under the same title of the *Cruzada*. In the Greek Church, the ante-paschal fast is of 48 days; but it is only one of four similar fasting periods observed in that church. See FAST. In the Anglican Church, Lent is retained as a church season of the calendar, with special services, and proper collects and prayers; but the observance of the fast is left to the discretion of each individual.

LENTANDO, in Music, the same as *rallentando* or *ritardando*, meaning a gradual decrease in the speed of the movement.

LENTIBULARIA'CEÆ, a natural order of exogenous plants, allied to *Primulaceæ*, but distinguished by an irregular corolla, and diandrous flowers. It has also intimate relations with *Scrophulariaceæ*. It contains nearly 200 known species, all herbaceous, and all living in water or marshes. They abound chiefly in the tropics. A few species of Bladderwort (q. v.) and Butterwort (q. v.) are its only representatives in Britain.

LENTIL (*Ervum lens*), an annual plant of the same genus with Tares (q. v.), a native of the countries near the Mediterranean, and which has been cultivated from the earliest times, yielding an esteemed kind of pulse. The English translation of the Bible is probably correct in calling the red pottage with which Jacob purchased Esau's birth-right, *pottage of lentils*; the red colour being very characteristic of this, which is still a very common article of food in the East. The L. is extensively cultivated in the south of Europe, Egypt, and the East, and to some extent in other parts of the world. It has a weak and branching stem, from 6—18 inches high, and pinnate leaves with 6—8 pair of

leaflets, the upper leaves only running into tendrils. The flowers are small, white, lilac, or pale blue, the corolla much concealed by the calyx, which is divided almost to its base into five narrow teeth. The pods are very short and blunt, thin, two-seeded, and smooth; the seeds have the form of a round lens, convex on both sides. There are numerous



Lentil.

varieties, having white, brown, and black seeds, which also differ considerably in size, the greatest diameter of the largest being about equal to that of moderate-sized pease. Lentils are a very nutritive food, containing an uncommonly large amount of nitrogenous substances, and more easily digested than pease. They have recently become common in the shops of Britain in a form resembling *split pease*, and in that of meal (*L. farina*), which is the basis, if not the whole substance, of *Revalenta Arabica* and *Ercalenta*, so much advertised as food for dyspeptic patients, at prices greatly exceeding those for which *L. meal* can be obtained under its own name. Lentils mixed with pease in the making of pea-soup, greatly diminish its tendency to produce flatulence. Lentils are also excellent food for horses; and the herbage used as green food for cows, renders them extremely productive of milk. The *L.* grows best in a light and rather dry soil. In a very rich soil, it produces comparatively few pods. Some of the varieties succeed well even on very poor soils. The whole life of the plant is shorter than that of any other of the *Leguminosae* cultivated in Britain. The seed may be sown in April in the climate of Britain; but although there is nothing in the coldness of the climate to prevent the successful cultivation of lentils, it seems to be too moist for them, the ripe or ripening seeds being very apt to be injured by moisture. There is no evident reason, however, why this plant should not be cultivated for green food of cattle.

LENTINI, a town of Sicily, in the province of Siracusa, stands near the lake of the same name, on a hill 15 miles south-south-west of Catania, and has about 5000 inhabitants. It has a large gunpowder mill, and derives a good revenue from the fishery in Lake Lentini.

LENTO, or **LENTAMENTE**, in Music, means

slow, gentle. According to the best authorities, the movement implied by *Lento* is quicker than *Adagio*, or between it and *Andante*.

LEO, the fifth sign of the ZODIAC (q. v.).

LE'O, the name of twelve among the popes of the Roman Catholic Church, of whom the following call for particular notice.—**LEO I.**, surnamed 'the Great,' who is held a saint of the Roman Catholic Church, and is one of the most eminent of the Latin Fathers, was born of a distinguished Etrurian family at Rome about the end of the 4th century. Of his early life, little is known. On the death of Sixtus III. in 440, *L.* was chosen as his successor. It is in his pontificate that the regular series of papal letters and decretals may be said to commence. *Leo's* letters, addressed to all parts of the church, exhibit prodigious activity and zeal, and are used by Roman controversialists as an evidence of the extent of the jurisdiction of the Roman see. In a council held at Rome in 449, he set aside the proceedings of the council of Ephesus, which had pronounced in favour of Eutyches (q. v.), summoned a new council at Chalcedon, in which his legates presided, and in which *Leo's* celebrated 'Dogmatical Letter' was accepted 'as the voice of Peter,' and adopted as the authentic exposition of the orthodox doctrine on the person of Christ. The history of *Leo's* interposition with Attila in defence of the Roman city and people will be found under the head **ATTILA**; and his subsequent similar interposition with Genseric, if less dramatic in the incidents with which history or legend has invested it, was at least so far successful as to save the lives of the citizens, and the public and private buildings of the city of Rome. *Leo* died at Rome in 461. His works, the most important of which are his Letters and Sermons, were first printed in 1479, and afterwards by Queanel (2 vols. Paris, 1675); but a much more complete and trustworthy edition is that of Cacciari (3 vols. fol. Rome, 1753—1755), and of the Brothers Ballerini (Venice, 1757).—The pontificate of **LEO III.** is chiefly noticeable as the epoch of the formal establishment of the Empire of the West. He was a native of Rome, and was elected pope on the death of Adrian I. in 796. During the greater part of the 8th c., the popes, through the practical withdrawal of the eastern emperors, had exercised a temporal supremacy in Rome, which was fully recognised by the gift of Pepin, and placed under the protectorate of the Frank sovereigns, who received the title of Patrician. The pontificate of *Leo*, however, was a troubled one, and in 799 he was treated with much violence, and obliged to flee to Spoleto, whence he afterwards repaired to Paderborn, in order to hold a conference with Charlemagne. On his return to Rome, he was received with much honour by the Romans, and the chiefs of the conspiracy against him were sentenced to banishment. In the following year (800), Charlemagne, having come to Rome, was solemnly crowned and saluted emperor by the pope, and the temporal sovereignty of the pope over the Roman city and state, under, however, the suzerainty of the emperor, was formally established. In 804, *Leo* visited Charlemagne at his court at Aix-la-Chapelle. With Charlemagne's successor, Louis le Débonnaire, *Leo* was embroiled in a dispute about the right of sovereign jurisdiction in Rome, which had not been brought to a conclusion when *Leo* died in 816.—**LEO X.**, Giovanni de' Medici, the second son of the celebrated Lorenzo de' Medici, was born at Florence in December 1475. From his cradle, he was destined to the ecclesiastical career. His education was intrusted to the ablest scholars of the age; and through the influence of his father with the pope, Innocent VIII., he was

created cardinal at the unprecedented age of thirteen years, in 1488. In the expulsion of the Medici from Florence, after the death of Lorenzo, the young cardinal was included, and he used the occasion as an opportunity of foreign travel. He was employed as legate by Julius II.; and during the war with the French, he was taken prisoner in the battle of Ravenna, but soon afterwards effected his escape. On the death of Julius II. in 1513, Cardinal de' Medici was chosen pope at the early age of 37, under the name of Leo X. His first appointment of the two great scholars Bembo and Sadoleto as his secretaries was a pledge of the favour towards learning which was the characteristic of his pontificate; but he did not neglect the more material interests of the church and the Roman see. He brought to a successful conclusion the fifth council of the Lateran (see COUNCIL), and the schism which was threatened by the rival council of Pisa. He concluded a concordat with Francis I. of France, which continued to regulate the French church till the Revolution. In the political relations of the Roman see, he consolidated and, in some degree, extended the re-conquests of his warlike predecessor, Julius II., although he also used his position and his influence for the aggrandisement of his family. His desertion of the alliance of Francis I. for that of his young rival, Charles V., although the subject of much criticism, was dictated by a sound consideration of the interests of Italy. But it is most of all as a patron of learning and art that the reputation of Leo has lived with posterity. Himself a scholar, he loved learning for its own sake; and his court was the meeting-point of all the scholars of Italy and the world. He founded a Greek college in Rome, and established a Greek press, which he endowed munificently (see LASCARIS). In the encouragement of art, he was no less munificent. Painting, sculpture, architecture, were equally favoured; and it is to his vast project for the rebuilding of St Peter's, and to the step to which he had recourse for procuring the necessary funds—his permitting the preaching of an indulgence, one of the conditions of obtaining which was the contribution to this work—that the first rise of the Reformation in Germany is ascribed. He himself seems to have regarded the movement as of little importance, describing it as 'a squabble among the friars;' and though he condemned the propositions of Luther, and issued a commission to inquire into his doctrines, his measures, on the whole, were not marked by much severity. His personal habits were in keeping with his taste—splendid and munificent in the highest degree; but in his moral conduct he maintained a strict propriety, and his character, although not free from the stain of nepotism, the vice of that age, and more modelled on the ideal of an enlightened prince than on that of a zealous and ascetic churchman, was beyond all imputation of unworthiness or irregularity. His death, which occurred rather suddenly during the public rejoicings in Rome for the taking of Milan, was by some ascribed to poison; but there seems no solid reason for the suspicion. It took place December 1, 1521, in the 46th year of his age. See Roscoe's *Life and Pontificate of Leo X.* (4 vols. Liverpool, 1806; Italian by Bossi, 12 vols. Milan, 1818).

LEO III., FLAVIUS, surnamed 'the Isaurian' (from his birthplace), Emperor of Constantinople (718—741 A. D.), was, like most of the eastern emperors, first a soldier in the imperial army, and soon rose to eminence through his military talents. Anastasius II. appointed him to guard the Asiatic portion of the empire from the ravages of the Arabs, who were headed by the celebrated Moalema; but on

the deposition of the former by Theodosius III., Leo, outwitting his Arab opponent, marched against the usurper, whom he compelled to resign his crown, which he himself assumed (March 718). Leo was scarcely seated on the imperial throne, when the Calif Suleiman laid siege to Constantinople by land and sea; this, the third siege of the capital by the Arabs, lasted for two years, but was finally raised through the energy of Leo. The governors of several provinces had meantime rebelled, and it cost Leo several years of petty warfare before peace was restored to the empire. The opportunity having at length arrived for which he had long watched, Leo issued an edict condemning the worship of images in the Catholic churches throughout the empire. In this he seems to have been actuated by a double motive—the restoration of purity of worship in the Catholic churches, and the removal of a grievous eyesore to many of his subjects, Christian, Mohammedan, Jewish, and Oriental. The edict produced a most startling effect; rebellions broke out in all quarters, and Ravenna, Rome, and the other Greek possessions in Italy were finally severed from the empire. Leo, enraged at his losses, determined to take revenge on their author, the pope, and accordingly removed Greece, Ilyria, and Macedonia from his spiritual jurisdiction, subjecting them to the Patriarch of Constantinople, thus creating a permanent breach between the Latin and Greek churches (734). During the remainder of his reign, little of importance occurred, excepting an indecisive war with the Arabs, and a great earthquake (October 740), which caused dreadful calamities throughout the empire. Many of the principal buildings and monuments in Constantinople were thrown down; the towns of Nicomedia, Prænetus, and Nicæa in Bithynia, were completely destroyed, and in Egypt several towns disappeared with all their inhabitants. Leo died 18th June 741.

LEOBSCHÜTZ, a town of Prussia, capital of the circle of the same name, near the river Zinna, 32 miles south of Oppeln, has large corn and flax markets, and manufactures of various kinds. Pop. 7890.

LEOMINSTER, a market-town, and municipal and parliamentary borough of England, in the county of Hereford, situated 12 miles north of the city of that name, on the river Lug. It returns two members to parliament. The immediate vicinity of L. is the most celebrated cattle-breeding district in the world—all the prize 'Herefords' at the shows being bred and fed here. Pop. (1861) 5658.

LE'ON, the name of a city and of a lake, called also Managua, in Nicaragua, in lat. 12° 25' N., and long. 86° 57' W. It stands near the north-west extremity of the lake of its own name, distant about 10 miles from the Pacific Ocean, is finely situated in a most picturesque district, and contains a cathedral, a noble edifice, and a university. From the top of the cathedral a beautiful and extensive view, embracing 13 volcanoes, may be obtained. Pop. about 35,000.—The lake measures 35 miles by 15. It derives considerable importance from its being an essential part of perhaps the most promising route across Central America between the Atlantic and the Pacific. Between it and the former ocean lies the still larger Lake of Nicaragua, into which it empties itself, with a fall of only 28 feet.

LEON (the *Legio septima gemina* of the Romans), capital of the former Spanish province of the same name, is situated between the rivers Bernesga and Torio, in a beautifully wooded plain, 85 miles north-west of Valladolid. Part of the old Roman

wall, 20 feet thick, is still standing. The streets are crooked and dirty, but the churches are both numerous and splendid, especially the cathedral, a specimen of the purest Gothic, containing the tombs of many sovereigns of L., saints, and martyrs. The trade of L. is now unimportant. Pop. 9603.

LEON, formerly a kingdom, and subsequently a province of Spain, now subdivided into the smaller provinces of Salamanca, Zamora, and Leon, is situated in the north-west of Spain, south of Asturias, and bordering on Portugal. Area about 15,000 square miles. Pop. 861,434. The country, which is intersected by the Douro, is mountainous, generally fertile, but miserably cultivated. It affords pasturage to vast flocks of merino sheep. The inhabitants are for the most part uneducated and lazy, but are very high-spirited, rich in peculiar customs, of pure Spanish descent, sincere, hospitable, and brave. It is said that in the high districts south of Salamanca, remnants of the pure Gothic tribes exist, and at Astorga, remnants of the old Celtiberi—the *Maragatos*. The means of communication are everywhere very defective. The Kingdom of Leon was erected, in 746, by Alfonso the Catholic out of the provinces he had wrested from the Saracens, and the older kingdom of Asturias, and in 1230 it was permanently united to Castile.

LEONARDO DA VINCI. This great genius, whose works in painting are classed with those of Raphael and Michael Angelo, was also a sculptor, architect, and engineer, and he cultivated successfully anatomy, botany, mathematics, astronomy, poetry, and music. He was born, in 1452, at Vinci, in the Val d'Arno, near Florence; his father, Pietro da Vinci, notary to the signory of Florence, placed him in good time with Andrea Verrocchio, who was an able sculptor, and a good painter; but in painting, his pupil soon surpassed him. In 1483, he went to Milan, and the Duke Lodovico il Moro conferred on him an annual pension of 500 dollars. Besides performing various services for the duke, particularly as an engineer, he instituted an Academy of Arts in 1485. This Academy, of which he was named director, was attended by many eminent artists, and influenced most beneficially the Lombard school of painting. It was in 1497, when 45 years of age, that he executed his famous picture, 'The Last Supper,' which was painted in oil on the wall in the refectory of the Dominican convent of Santa-Maria-delle-Gracie. He remained in Milan till 1500, when, on its occupation by the French, he returned to Florence, and in 1502 was appointed architect and chief engineer to Cesare Borgia, captain-general of the pope's army. In 1503, he was employed by Soderini Gonfaloniere of Florence to paint one end of the council-hall of the Palazzo Vecchio. For this, L. only completed the celebrated cartoon called the 'Battle of the Standard;' another cartoon for a painting in the same apartment, the equally celebrated design called the 'Cartoon of Pisa,' having been executed at the same time by Michael Angelo. He returned to Milan in 1506. In 1513, he visited Rome in the train of Giuliano de' Medici, who went there to assist at the coronation of his brother, Leo X.; and in 1515, accompanied Francis I. to Bologna, where he signed the concordat with Leo X. On the pressing invitation of Francis, he accompanied that monarch to France, in 1516, along with his pupils Salai and Melzi. In bad health during the whole period he was in France, he executed no paintings there, being chiefly occupied in engineering. His death occurred at Amboise, 2d May 1519. The genius of L. was universal: painting was not his sole occupation. He imparted to his works certain

qualities of the highest kind, for his drawing evinces very great delicacy and elevation of style, not modelled on the antique, but formed on a profound knowledge of nature; and in his treatment of light and shadow, he infused a degree of power, combined with softness, into his productions that invests them with a peculiar charm; while the influence of his style has operated powerfully on the schools of Milan and Parma. L.'s Treatise on Painting, *Trattato della Pittura*, has been published in several languages. The principal edition is that published at Paris, in folio, by Du Fresnoy, illustrated with drawings by Nicolas Pousin; the best, as regards the text, was published at Rome in 1817. Mr Hallam says, in his *Introduction to the Literature of Europe*: 'Leonardo's greatest literary distinction is derived from those short fragments of his unpublished writings that appeared not many years since, and which, according, at least, to our common estimate of the age in which he lived, are more like revelations of physical truths vouchsafed to a single mind, than the superstructure of its reasoning upon any established basis. The discoveries which made Galileo and Kepler and Maestlin and Maurolicus and Castelli, and other names illustrious, the system of Copernicus, the very theories of recent geologists, are anticipated by Da Vinci, within the compass of a few pages, not, perhaps, in the most precise language, or on the most conclusive reasoning, but so as to strike us with something like the awe of preternatural knowledge.' The writings referred to by Mr Hallam were published by Venturi at Paris, in 1797, under the following title: *Essai sur les Ouvrages Physico-Mathematiques de Leonard da Vinci, avec des Fragmens tirés de ses Manuscrits apportés de l'Italie*. These MSS. were afterwards restored to Milan, where they are still preserved.

LEONFORTE, a Sicilian town, in the province of Messina, situated in a mountainous neighbourhood, on the shore of the Mediterranean. It is surrounded by walls, and has a pop. of 11,170 inhabitants. There is a thriving trade in oil, wine, and grain.

LEONIDAS I., son of Anaxandrides, king of Sparta, succeeded his half-brother, Cleomenes I., about 491 B.C. When the Persian monarch Xerxes approached with an immense army, L. opposed him at the narrow pass of Thermopylae (480 B.C.) with a force of 300 Spartans, and rather more than 5000 auxiliaries. The Persians attempted in vain to win over L. by the promise of making him ruler of the whole of Greece; and when Xerxes sent a herald calling the Greeks to lay down their arms, the Spartan answered: 'Let him come and take them.' The treachery of one Ephialtes having made it impossible to bar any longer the progress of the foe, L. and his little band threw themselves on the swarming myriads, and found a heroic death.

LEONINE VERSES, the name given to the hexameter and pentameter verses, common in the middle ages, which rhymed at the middle and end. They were so named after Leoninus, a canon of the church of St Victor, in Paris, about the middle of the 12th c., or, as others say, after Pope Leo II., who was a lover and improver of music. Traces of this kind of versification appear here and there in the Roman poets, especially in Ovid, in some of whose Epistles, indeed, they are as common on an average as once in every eight lines. Camden gives some curious specimens from Walter de Mape, Michael, the Cornish poet, and Dan Elingham, a monk of Linton. The story of the Jew who, having fallen into a refuse-pit on Saturday, would not be helped out, because it was his Sabbath, while the Christian, who offered him assistance, refused to do

so next day, because it was his, has been thrown into Leonine verse as follows :

Tende manus Salomon, ego te de stercore tollam ;
Sabbata nostra colo, de stercore surgere nolo.
Sabbata nostra quidem Salomon celebrabis *ibidem*.

Leonine verse is not uncommon in English poetry, e. g. :

Arethusa arose from her couch of snows
In the Acrocerasian mountains,
From peak and from crag, with many a jag,
Shepherding her bright fountains.

LEOPARD (*Felis leopardus*), one of the larger *Felidae* (q. v.), now generally supposed to be identical with the panther (*F. pardus*), although by some they are regarded as varieties, and others still suppose them to be distinct species. Great confusion has prevailed in the nomenclature ; the panther and *pardalis* of the ancients are not certainly known ; the jaguar was erroneously described as the panther by Buffon ; the puma is often called panther in



Leopard (*Felis leopardus*).

America ; the L. is known by the name of tiger in Africa ; and as Sir J. E. Tennent tells us, it is by mistake often called cheetah in Ceylon. Supposing the L. and panther to be one species, we may describe it as characterised by a peculiar gracefulness, slenderness and flexibility of form, with a very long tail, and spotted fur, the spots being arranged in numerous rows along the sides, and each spot composed of five or six small spots arranged in a circle or rosette. The general colour is yellowish ; the lower parts lighter ; the spots darker than the general colour of the fur. The L. is extremely agile, and possesses the power of leaping and also that of climbing trees in great perfection. It haunts wooded places, and is seldom to be found in open regions of long grass, like the tiger. When pursued, it takes refuge, if possible, in a tree, and if hard pressed, springs down on its assailants. It is cunning, and adopts devices similar to those of the fox for carrying on its depredations, and concealing its place of retreat. Deer and antelopes are its habitual prey ; but it is equally ready to feed on pigs, poultry, or whatever may be found in the vicinity of a farm or village. The size and strength of the L. render it as dangerous to man as any of the *Felidae* ; but it generally seems to dread and flee from man, unless assailed. It is very capable of domestication.

LEOPARD, in Heraldry. The leopard has been described by some heralds as the issue of the pard and lioness ; and the circumstance that such hybrids are unproductive, is assigned as a reason for appropriating that animal to the armorial ensigns of abbots and abbees. However, the representations of leopards, at least in English heraldry, are so exactly like those of the lion passant gardant, that it has been made a question whether there is any difference between the two, and it has more

especially been a keenly contested point whether the three animals in the royal escutcheon of England were lions or leopards. In early times, we find them blazoned in both ways, and the true solution of the *quæstio vexata* seems to be, that at one period the heraldic leopard came to be considered as a mere synonym for the lion passant gardant, though the two animals were originally regarded as distinct. In the infancy of heraldry, before distinctive appellations were invented for the different attitudes of animals, it was customary to draw a lion in the attitude since called rampant, and a leopard as passant gardant. This difference of position sufficiently indicating which animal was meant, they were otherwise similarly represented, and no attempt was made to exhibit the spots of the leopard. By and by, as coats of armour were multiplied, it became necessary to difference them by varying the position of the animals depicted ; and the blazoners of those days, thinking more of attitude than of zoology, had recourse to a compromise in their nomenclature. The lion was naturally supposed to be rampant and in profile, the leopard passant gardant. When the conventional animal that might stand for either was passant and in profile, he was designed a *lion-leopardé* ; and when rampant gardant, he was a *leopard-bionné*. The king of beasts was very early assumed as his appropriate insignia by the sovereign of England, as well as by the sovereigns of other countries in Western Europe. The lion was at first borne singly, and his natural attitude, like that of other lions, was considered to be rampant. But when a second and third lion were added, it became less convenient to draw them in the rampant attitude, and the lions became lions-leopardé or passant, as seen in the seal of King John ; a further change of position to passant gardant made them heraldically leopards. Edward III., Edward the Black Prince, and Richard II., speak of their crest of the leopard. Nicholas Serby was designated Leopard Herald in the reign of Henry IV. ; and it was not till the middle of the 15th c. that the lions of England regained their original name.

Though leopards, properly so called, hardly occur in English heraldry, having passed into lions passant gardant, their heads or faces are occasionally borne. If no part of the neck is shown, the proper blazon is a leopard's face ; if a portion of the neck is drawn, it is a leopard's head, erased or coupé, according as it is cut off evenly or with a jagged edge.

LEOPARDI, GIACOMO COUNT, a modern poet and classical scholar of Italy, was born at Recanati, a town in the march of Ancona, on the 29th June 1798. Without the aid of instructors, L., at the age of seventeen, had attained to a degree of classical scholarship almost marvellous. Latin and Greek he mastered as his own mother-tongue, and composed some of his philological criticisms at the age of nineteen, when he was elected member of the Academy of Science at Viterbo. Shortly after, he departed from his secluded home for Rome, where he won the friendship of several celebrated men, amongst others, of Niebuhr, who was deputed to offer him the chair of Greek philosophy, in the university of Berlin, which he declined. Ill health acting on the temperament characteristic of genius, seems to have cast a gloom over his spirit, which deeply tinged his general impressions of men and things. On his return from Rome to his native place, his health grew seriously impaired, from the arduous with which he pursued his varied studies. He finally took up his abode in Florence, where he published his admired *Canzoni* and other works, amidst a conflict with failing health, straitened

finances, and deep despondency. In this bitter crisis of his life, he formed a warm friendship with the historian Antonio Ranieri; and by the delicate and incessant cares of Ranieri and his sister, the shattered, suffering poet was shielded to the hour of his death. From this period, a sensible softening of spirit became manifest in his writings; it seemed as if the poet had learned to value and cling to life and friends only when summoned to relinquish both. He died in his friend's arms at Naples, 14th June 1837, at the age of 39. His remains lie in a small church at Posillipo. The works of L. are all more or less the reflex of his morbid, desponding mind. They are remarkable for originality, vigour, and elegance of style. His collected works were published in 1849, by Le Monnier, at Florence, under the title of *Versi e Prose di Giacomo Leopardi*. His Italian love-sonnets are full of fire and grace; and his ingenious imitations of the antique form of composition, written in Greek and Latin, were so perfect, as to be mistaken by many for genuine long-lost gems of classical literature.

LEOPOLD I., GEORGE CHRISTIAN FREDERICK, King of the Belgians, son of Francis, Duke of Saxe-Coburg, was born 16th December 1790. He received an excellent literary and scientific education, and at the conclusion of his studies had the reputation of being one of the best informed princes in Europe. The marriage of his sister Juliana with the Grand Duke Constantine having closely allied the House of Saxe-Coburg with the imperial family of Russia, he became a general in the Russian army; but the menaces of Napoleon compelled him, in 1810, to resign his commission. He afterwards again joined the Russian army, and was present at the battles of Lützen, Bautzen, Leipzig, and Kulm. Having visited England after the peace of 1815, he won the affections of the Princess Charlotte, the heiress of the throne. L. was now naturalised by act of parliament in 1816, and received an annual pension of £50,000. The marriage took place on 2d May 1816; but the princess died in childhood on 5th November 1817, and her child did not survive. Prince Leopold now lived in complete retirement, sometimes in London, and sometimes at his seat of Claremont. He received, in February 1830, the offer of the crown of Greece, and at first favourably entertained the proposal, but afterwards rejected it, because of the dissatisfaction of the Greeks with the arrangements determined upon by the Great Powers. In June 1831, he was elected, by a National Congress, king of the Belgians, and on 21st July of that year, his inauguration took place at Brussels. In 1832, he married the Princess Louise, daughter of Louis Philippe, King of the French, who died in October 1850, and by whom he has issue the Crown Prince Leopold, Duke of Brabant, another son and a daughter. As a monarch, he has conducted himself with great prudence, firmness, and moderation, with constant regard to the principles of the Belgian constitution, and an evident anxiety to advance the national welfare.

LEOPOLD OF BABENBERG or BAMBERG, the descendant of a noble family which derived its origin from the Frankish kings, was the first hereditary Markgraf of Austria (983 A. D.), and his descendants continued to rule over that country till the line became extinct, in the person of Frederick the Warlike, in 1246. This family played an important part in the Guelph and Ghibelline conflicts of the 12th c., and obtained the duchy of Bavaria, in 1138, on the rebellion of Henry the Proud, but after a long conflict with his son, Henry the Lion, was compelled to resign it to that prince in 1156.

LEPANTO (ancient *Naupactus*), now called by the Greeks *Epacta*, the chief town of the eparchy of the same name, in the province of *Ætolia-Acarnania* in Greece, is situated on the north side of the Gulf of Lepanto, 25 miles east of Missolonghi. The town, which is ill built, and has a miserable appearance, is the seat of an archbishop, and has an excellent port. Pop. 2000. In the middle ages, it was given by the Greek emperors of the East to the Venetians, who fortified it so strongly, that in 1477, it stood a siege of four months by 30,000 Turks, and was only taken in 1499 by Bajazet II., at the head of 150,000 men. Near L., took place the celebrated naval battle between the Turks and Christians in 1571, in which the latter, commanded by Don John of Austria, (q. v.), achieved a decisive victory.

LEPIDODENDRON, a genus of fossil plants, abundant in the coal measures. Some species were of small size, but the greater number were large trees, 40 or 50 feet long, and more than 4 feet in diameter. They taper upwards, and branch generally in a dichotomous manner. The surface is



Lepidodendron.

either covered with narrow, sharp-pointed, scale-like leaves, or marked with lozenge-shaped spaces—the scars of the fallen leaves—arranged in a spiral manner. The leaves which are found separated from but associated with the trunks, have been placed in a provisional genus under the name of *Lepidophyllum*. The fruits are elongated, cylindrical bodies, composed of a conical axis, around which a great quantity of scales are compactly imbricated.

Brogniart and J. D. Hooker consider that *Lepidodendra* are gigantic Lycopoda. Their modern representatives would thus be a class of small, generally creeping, moss-like plants, the largest not being more than three or four feet high. In their form and in the structure of their fruit, they certainly approach them more nearly than any other living plants; Lindley, however, sees in the *Coniferae*, and especially in the Norfolk Island pines, the closest resemblances to this ancient class of plants.

LEPIDOPTERA (Gr. scaly-winged), an order of insects, undergoing complete metamorphosis, having the mouth in their perfect state exclusively adapted for sucking, and further characterised by four membranous wings covered with minute, closely set scales. The order contains a vast number of species, abounding chiefly in warm climates; but the British species alone are about two thousand. The L. are very naturally divided into three great sections—*Diurna*, *Crepuscularia*, and *Nocturna*, so named because almost all those of the first section are to be

seen on wing only during the day, those of the second more generally during the twilight, whilst those of the third are more nocturnal; their popular designations respectively being BUTTERFLIES, HAWK-MOTHS, and MOTHS. See these heads. Among the L. are included many of the largest and most beautiful of insects, with colours as exquisitely varied as they are brilliant; there are also many—particularly among the moths—of small size and sober hue, but not one of them can be denied the praise of beauty. The difference between the larvæ and the perfect insects in food, structure, and habits, is very wonderful. The larvæ are described in the article CATERPILLAR, the pupæ in CHERYALIS. The perfect insect feeds only on the nectarous juices of plants. The principal organs of the mouth are the *maxillæ*, the mandibles and labrum being reduced to mere rudiments; and the *maxillæ* appear in the form of two long slender filaments, which combine to form a proboscis or trunk, spirally rolled up when not in use. This trunk is capable of great variety of movement, and is of extremely delicate structure.—The scales of the wings are of very various forms, but with a general similarity. Some of them are figured in the article BUTTERFLY. The wings are generally large, and are not folded when at rest. The three segments of the thorax are much united. The abdomen has neither sting nor ovipositor. None of the L. form *societies*, although great numbers are often found together. SILK is the product of some of them.

LEPIDOSIREN (or *Protopterus*), a very remarkable genus of animals, one of the connecting links between Amphibia (or Batrachia) and Fishes, and ranked by some naturalists with the former, and by some with the latter. Owen strenuously maintains the proper place of this genus to be among fishes. There are several species of L., of which the best known is *L. annectans*, an inhabitant of the upper part of the river Gambia. It is about a foot long. The bones are very soft and cartilaginous, or even gelatinous, except those of the head, which resemble in substance those of osseous fishes. The scales are cycloid. The dentition is very remarkable. The



Lepidosiren.

jaws are furnished with an undulating ribbon of bone, covered with enamel, the undulations of the upper and lower jaw adapted to each other, and along the edges are small sharp teeth. There are free filamentary gills situated under gill-covers, as in osseous fishes, but two of the arterial arches, which ordinarily supply the gills of fishes with blood, are represented in L. by trunks, which proceed to the double air-bladder, and ramify over its cellular surface, so that the air-bladder, having a communication with the mouth, is capable of serving to a certain extent the purposes of lungs, and the animal is enabled to sustain a torpid existence during the dry season in mud, in which it forms for itself a kind of nest, which has been likened to the cocoon of an insect, by means of a mucous secretion from its body. Specimens of *L. annectans* have sometimes been brought from Africa with plants, among the roots of which they had taken up their residence. Numerous specimens have been kept alive in the Zoological Gardens of London and the Crystal Palace, and their habits have been carefully studied. They do not seem to need the

annual period of torpidity, for which, as forced upon them in their native country, they are so well prepared. They readily eat any kind of animal food; frogs are particularly acceptable; and when placed in the same tank with gold-fishes, they kill them by a single bite close to the pectoral fins, approaching them from below, biting out the piece, and often eating no more of the fish than that one bite. In its native country, the flesh of the L. is much esteemed.

LEPIDUS, an illustrious Roman family of the ancient Æmilian gens. It makes its first appearance in history about the beginning of the 3d c. before Christ; and was long one of the most distinguished in the patrician order, reckoning among its members many who held the greatest dignities in the state, consuls, augurs, prætors, military tribunes, censors, and heads of the priesthood. It disappears about the close of the 1st c. A. D. The only individual, however, who requires special mention, and that not because of his talents, but because of the important events in which he took a part, is MARCUS ÆMILIUS L., who, when war broke out (49 B. C.) between Cæsar and Pompey, declared for Cæsar, who appointed him, during his own absence in Spain, Dictator of Rome, a *Magister Equitum* (47 B. C.), and his colleague in the consulate (46 B. C.). He afterwards supported Antony, and became one of the triumvirate with Octavianus and Antony; but his weakness of character, and want both of military talents and of statesmanship, made him of very inferior importance to the other two, who assigned him Africa as his province (40—39 B. C.). After the defeat of Sextus Pompeius, he thought to have maintained himself in Sicily against Octavian, but his soldiers deserted him, and went over to his rival, who, however, allowed him to retain his wealth and the dignity of *pontifex maximus*. He died 13 B. C.

LEPORIDÆ. See HARE.

LEPRA is a Greek term which is now generally employed by medical writers to designate a scaly affection of the skin. These scales occur in circular patches of a grayish colour, with a red, slightly elevated margin. If the scales fall off or are removed, the surface of the skin is red and shining, and new scales rapidly form. The patches vary in size, being often about an inch in diameter, and sometimes much larger. Lepra most commonly occurs on the limbs, and especially on those parts where the bones are most thinly covered. Its duration is uncertain, and if not interrupted by treatment, it will frequently continue for years, without materially affecting the general health. It is not contagious. The local application of tar ointment, or the iodide of sulphur ointment, will sometimes remove it. If it does not yield to this treatment, small doses of Fowler's Arsenical Solution (three to five minims) may be prescribed, twice or thrice a day, either in water or in the decoction of dulcamara, which is supposed to be specially beneficial in chronic skin diseases.

LEPROSY. This term has been very vaguely used both by medical and other writers; we shall here restrict it to the *Lepra tuberculosa*, as it appears to have prevailed during the middle ages and down to modern times in Europe, and as it is now met with in various warm climates; the scaly variety, which in reality is a perfectly separate disease, being noticed in the article LEPRA. The affection here discussed is identical with the *elephantiasis of the Greeks*, and the *lepna of the Arabians*, while it is altogether different from the *elephantiasis of the Arabians*, and the *lepna of the Greeks*, which latter is the *scaly lepna* of our own day.

The most prominent symptoms of leprosy are summed up by Dr Copland in his *Medical Dictionary* as follow: 'Dusky red or livid tubercles of various sizes on the face, ears, and extremities; thickened or rugose state of the skin, a diminution of its sensibility, and falling off of the hair, excepting that of the scalp; hoarse, nasal, or lost voice; ozena; ulcerations of the surface and extreme fetor.' These tubercles vary in size from that of a pea to an olive. Of all parts, the face is particularly affected, and especially the nose and ears.

The leprosy of Iceland, described by Dr (now Sir Henry) Holland and others, that of the Farøe and Shetland Islands, described by Dr Edmonston and others, and that still met with in Africa, in the East and West Indies, and in many tropical islands, are all identical with the disease now described—the leprosy of the middle ages.

Closely allied to it, and often confounded with it, are: 1. The *Lepra Anæsthesiaca* of Winterbottom, Copland, and others, which is characterised by remarkable absence of sensibility of the general surface, by comparative smoothness of the skin, and ulceration and falling off of the fingers and toes. The cases recorded by Winterbottom and Copland were seen in Africa.

2. The *Jewish Leprosy*, regarding which nothing certain is known. The term leprosy (or *Berat* in the Hebrew) was probably applied by the priests to various cutaneous affections, particularly those which were of a chronic and contagious nature. 'It is probable,' says Dr Copland, 'that frambesia or the yaws (a tuberculous disease) was one of these, as well as other inveterate cutaneous maladies arising from the modes of living, the habits and circumstances of the Jews at that time, and of the Egyptians; and that these maladies have changed their characters, owing to changes in the nature and combinations of their exciting causes.'

Nothing certain is known regarding the causes of this disease. The investigations of Mr Stewart at Tranquebar, where it is very prevalent, led him to conclude: 1. That women are less liable to this malady than men; 2. That it is hereditary; 3. That its contagiousness is extremely problematical; 4. That a fish-diet is found to render every symptom worse; 5. That poor living, want of cleanliness, and exposure to cold and damp, are constant attendants on this affliction. Dr Copland ascribes its origin to the use of semiputrid meat and fish, and of rancid oils; to insufficient vegetable food; and to the contact of matter discharged from leprosy sores.

The disease may continue without causing death for many years. When it is far advanced, it is probably incurable, and even in the early stages, its cure is uncertain. Probably such alterative medicines as corrosive sublimate and arsenious acid in minute doses are the most likely to be of service. Sulphur fumigating baths, and various medicated water-baths, have also been recommended.

LEPSIUS, KARL RICH., a distinguished German investigator of Egyptian antiquities, was born at Naumburg, 20th December 1813. His father, an advocate and magistrate there, was a zealous antiquary, and published many works on the antiquities of that part of Germany. The younger L. studied at Leipzig, Göttingen, Berlin, and Paris. His first work was his *Die Paläographie als Mittel der Sprachforschung* (Berl. 1834), for which he obtained the Volney prize of the French Institute. This was followed by works on the most ancient alphabets and other kindred subjects. In 1836, he associated himself intimately with Bunsen at Rome, and eagerly prosecuted his favourite studies there. Between 1834 and 1842, he published his

Lettre à M. Rosellini sur l'Alphabet hiéroglyphique (Rome), and a number of dissertations on the monuments of Egyptian art and their general architectural style, which were inserted in the *Transactions* of the Archæological Institute. He also applied himself to the study of the ancient Etrurian and Oscan languages, the remains of which he published in his *Inscriptiones Umbricæ et Oscæ* (Leip. 1841), and other works. In 1842, he was placed at the head of an antiquarian expedition sent to Egypt by the king of Prussia, and on his return was appointed ordinary professor in Berlin. He now began to give to the world the results of his Egyptian researches, in his *Denkmäler aus Aegypten und Aethiopien* (in folio, 1853—1857), a magnificent work, published at the expense of the king of Prussia. His *Chronologie der Aegypten* (vol. i. Berl. 1849), and *Ueber den ersten Aegypt. Goetterskreis*, have laid the foundation for a scientific treatment of the earlier parts of Egyptian history. He has connected with the study of the more familiar departments of Egyptian archæology, the investigation of the languages, history, and monuments of the regions further up the Nile. His *Briefe aus Aegypten, Aethiopien, und der Halbinsel des Sinai* (Berl. 1852), *Ueber einige Ergebnisse der Aegyptischen Denkmäler, &c.* (1853), and *Das allgemeine linguistische Alphabet* (1855), are also valuable works.

LEPTOSPERMUM, a genus of trees and shrubs, natives of Australia, New Zealand, &c., of the natural order *Myrtaceæ*, sub-order *Leptospermeæ*. They are evergreen, with leaves somewhat resembling those of myrtles. Some of them bear the name of TEA-TREE, as *L. lenigerum*, *L. baccatum*, *L. flexuosum*, and *L. grandiflorum*, because the leaves have been used as a substitute for tea. *L. scoparium* is sometimes called the *New Zealand Tea-plant*, sometimes the *Broom-tree* or *Dogwood-tree*. It is common both in New Zealand and Australia. Captain Cook's crew used its leaves for tea. They have a pleasant smell when fresh. Beer brewed with them acquires a pleasant flavour.

LE'RICI, a town and port on the Gulf of Spezia, which has recently gained celebrity by the imprisonment of Garibaldi within its fortress. Pop. 5217. The port is frequented by numerous vessels; the town is walled, and protected by a castle. In the 11th and 12th centuries, L. was included in the territory of Pisa, when it was strongly fortified against the rival states of Lucca and Genoa. At L., the famous transfer of Andrea Doria's services from Francis I. to the Emperor Charles V. took place.

LE'FRIDA, a town of Spain, capital of the province of the same name, on the river Segre, a tributary of the Ebro, about 100 miles west-north-west of Barcelona. It is built partly on a plain and partly on an eminence. The town—which is important in a military point of view—is surrounded by walls and a wet fosse, and commanded by the citadel. It is a gloomy labyrinth of mean-looking streets. The castle has an old cathedral attached to it of the 13th c.; the town, a new and imposing one of the 18th century. L. carries on manufactures of woollen, cotton, leather, glass, and gunpowder. Pop. 19,581.

L. is probably the Celtiberian *Nerda*. In the neighbouring plain, Scipio Africanus defeated Hanno, and at a later period Cæsar, the lieutenants of Pompey. A council was held at L. 564 A. D.

LERNE'ADA, an order of Crustacea, having the mouth formed for suction alone, and in organisation very inferior to any of the other crustaceans, so that the genus *Lernæa*, from which the order derives

its name, was placed even by Cuvier not among crustaceans, but *Entozoa*. The true relations of these creatures, however, after having been rendered probable by others, were finally demonstrated by Von Nordmann. A remarkable circumstance is that, when young, they resemble the higher crustaceans much more than in their mature state; having then organs for swimming, which they are capable of doing with great agility, and eyes—or an eye as in Cyclops, to which they exhibit much general resemblance; whilst, when mature, they are fixed to a single spot, as parasites on fishes, and are destitute both of eyes and of organs of locomotion. The number of the *L.* is very great, each kind of fish having apparently its own peculiar species of parasite. Some of them adhere to the eyes of fishes, which they render blind, some to the gills, some to other parts of the body. The ancients were acquainted with such parasites of the tunny and sword-fish, and Aristotle mentions them as causing great annoyance to the fishes infested by them. The *L.* assume in their mature state very various and grotesque forms.

LEROY DE SAINT ARNAUD, JACQUES, a French marshal of the second Empire, was born at Paris, 20th August 1801, entered the army in 1816, but found it necessary more than once to leave it, so that, in 1831, after a lapse of fifteen years, he was only a lieutenant. In 1837, he was appointed captain of the foreign legion, and first rose to eminence in the African wars. The valour he exhibited at the siege of Constantine won him the cross of the Legion of Honour. In 1840, he became a *chef de bataillon*; in 1842, a lieutenant-colonel; and in 1844, a colonel. During the rising of the desert tribes under Bou-Maza, Colonel L. de St A. signalled himself at the head of the column placed under his orders, reduced the Dahra to subjection, and made Bou-Maza a prisoner. On the termination of the campaign, he was promoted to be a Commander of the Legion of Honour. In 1847, he was raised to the rank of a field-marshal; and in the early part of 1851 carried on a bloody but successful warfare with the Kabyles. He was now appointed a general of division. At this period, Louis Napoleon was plotting the overthrow of the republic, and was on the look-out for resolute and unscrupulous accomplices; and accordingly, about the beginning of autumn, L. de St A. appeared in Paris, and was immediately appointed to the command of the second division of the city forces. On the 26th October he became war minister, and took an active part in the *coup d'état* of 2d December, and the subsequent massacres at the barricades. On the breaking out of the Crimean war in 1854, he was intrusted with the command of the French forces, and co-operated with Lord Raglan in the battle of the Alma, 20th September. He died nine days afterwards, the victim of an incurable disease.

LE'RWICK, a burgh of barony, chief town of the Shetland Islands, is situated on the Mainland, on Bressay Sound, 110 miles north-east of Kirkwall. The town presents a strange appearance from having no regular streets, the only thoroughfares between the houses being badly kept and winding pathways. The harbour is commodious and safe. Pop. (1861) 3061. In 1861, 304 vessels, of 50,742 tons, entered and cleared the port. Fishing is the chief branch of industry.

LESAGE, ALAIN RENÉ, a French dramatist and novelist, born 8th May 1668, at Sarzeau, now in the department of Morbihan, and studied under the Jesuits. In 1692, he came to Paris, to pursue his philosophic and juristic studies, and to seek

employment. His personal qualities attracted the favourable regard of a lady of rank, who offered him her hand; but in 1695 he married the daughter of a citizen of Paris. He renounced the practice of his profession as an advocate to devote himself to literature, and lived entirely by his literary labours, till the Abbé de Lyonne gave him a small pension of 600 livres. Some of his dramatic pieces attained great popularity; and in 1709 he was offered 100,000 francs to suppress one of them, *Turcaret*, a bitter satire on the financiers of the time, but he refused the offer. His comic novels, which have never been excelled by anything of the same kind, won for him a still higher place in literature, particularly *Le Diable Boiteux*, *Les Aventures de Guzman d'Alfarache* (an abridged translation from the Spanish of Aleman), and *Gil Blas de Santillane* (2 vols. Par. 1715), which is universally regarded as his master-piece. He died 17th November 1747. A complete edition of his works was published in Paris in 1730. The novels above named have been translated into different languages, and *Gil Blas*, in particular, is extremely popular.

LE'SBOS, the ancient name of an island in the Grecian Archipelago, belonging to Turkey, called, during the middle ages, *Mitylene* (from its capital city), and hence, by the modern Greeks, *Mitylen* or *Melino*, and by the Turks *Midilli*. It lies 40 miles south-east of Lemnos (q. v.), near the coast of Asia Minor, from which it is distant only 10 miles; area, about 600 square miles; pop. about 40,000, of whom from 15,000 to 18,000 are Turks, the rest are Greeks. *L.* is rather mountainous, but only one of the mountains attains an elevation of 3000 feet. The climate is salubrious beyond that of any other island in the Ægean, and the soil is fertile. Anciently, it was famous for its wines—Horace celebrates the *innocentia pocula Lesbii*—but the modern produce is indifferent. Its figs, however, are excellent; but its principal exports are oil, timber, and gall-nuts. The chief town is Castro (q. v.).—*L.* was the birthplace of Terpander, Arion, Alcæus, Sappho, Pittacus, Theophrastus, and Cratippus.

LESION, a term in Scotch Law to denote injury or prejudice sustained by a minor or by a person of weak capacity, sufficient to be a ground of action to reduce or set aside the deed which caused the lesion. See **INFANT**.

LESLIE, LESLY, or LESLEY, THE FAMILY OF. The first trace of this Scottish historical house is found between the years 1171 and 1199, when David, Earl of Huntingdon and the Garioch, brother of King William the Lion, granted a charter to Malcolm, the son of Bartholf, of the land of Lesslyn (now written Leslie), a wild pastoral parish in Aberdeenshire. Bartholf's descendants, taking their surname from their lands of Leslie, acquired large domains before the end of the 13th c., by marriages with the heiress of Rothes on the Spey, and with one of the co-heiresses of Abernethy on the Tay. Sir Andrew of Leslie appears as one of the magnates of Scotland in 1320, and from this time the family figures more or less prominently in the history of the country.

EARLS AND DUKE OF ROTHES.—It became ennobled in 1457, when George of Leslie, of Rothes, and of Leslie upon Leven (the family had transferred the name of its first possession in the Garioch to the lands of Fethkil, in Fife) was made Earl of Rothes and Lord Leslie. The third earl was the father of Norman Leslie, Master of Rothes, the chief actor in the murder of Cardinal Beaton. The fifth earl, although a man of dissolute life, distinguished himself as one of the ablest of the Covenanted leaders. His son, scarcely less able, though almost uneducated,

became Lord Chancellor of Scotland in 1667, and in 1680 was created Duke of Rothes, Marquis of Ballinbreich, Earl of Leslie, &c. These honours, being limited to the heirs-male of his body, became extinct upon his death without male issue in 1681. The earldom of Rothes went to his eldest daughter, whose descendant, the present Countess of Rothes, is the sixteenth who has held the dignity.

EARLS OF LEVEN.—Before the family forsook its first seat in Aberdeenshire, it had thrown off branches, some of which still flourish there. The chief, that of Balquhain, has given birth by itself or by its offshoots to several men of mark, such as the learned John Leslie, Bishop of Ross (born in 1527, died in 1596), the devoted champion of Mary, Queen of Scots; Sir Alexander Leslie of Anchtoul, a general in the Muscovite service, who died governor of Smolensko in 1663; and Charles Leslie, chancellor of the diocese of Connor, author of a *Short Method with the Deists*, who died in 1782. A still more distinguished man was Alexander Leslie, a soldier of fortune, who, bursting the trammels of illegitimate birth and a scanty education (he could write his name, but nothing more), rose to be a field-marshal of Sweden under the great Gustavus Adolphus. He was recalled to Scotland in 1639, to take the command of the Covenanting army; and in 1641 was made Earl of Leven and Lord Balgony. He died in 1661, leaving two grandchildren, the younger of whom married the Earl of Melville, and left a son, who became third Earl of Leven and second Earl of Melville. His descendant is now eleventh Earl of Leven and tenth Earl of Melville.

LORDS LINDORES.—The second son of the fifth Earl of Rothes was created Lord Lindores in 1600. The title has been dormant since the death of the seventh lord in 1775.

LORDS NEWARK.—David Leslie, fifth son of the first Lord Lindores, served with distinction under Gustavus Adolphus of Sweden, and returning to Scotland, on the outbreak of the Great Civil War, was one of the leaders of the Parliamentary army at Marston Moor, and surprised and routed Montrose at Philiphaugh. He was defeated by Cromwell at Dunbar in 1650, and after ten years' imprisonment in the Tower, was set at liberty at the Restoration. He was made Lord Newark in 1661, and died in 1682. The title has been dormant since the death of his great-grandson, the fourth lord, in 1791.

COUNTS LESLIE.—Walter Leslie, a younger son of the House of Balquhain, distinguished himself in the Austrian army, and in 1637 was created a count of the empire, as a reward for his services in the murder of Wallenstein. He died without issue in 1667, when he was succeeded by his nephew, James, a field-marshal in the Austrian service, who died in 1694. The title, it is understood, became extinct in 1844.

The history of the Leslies was written by Father William Aloysius Leslie, a younger brother of the second count, in a large and sumptuous folio published at Grätz in 1692, with the title of *Laurus Lesliana Explicata*. The *Pedigree of the Family of Leslie of Balquhain* was printed at Bakewell in 1861, for private circulation. Some histories of the family still remain in MS. One of them boasts that 'at one time three Leslies were generals of armies in three kingdoms—Walter, Count Leslie, in Germany; Alexander Leslie, Earl of Leven, in Scotland; and Sir Alexander Leslie of Auchintoul, in Muscovy.'

LESLIE, SIR JOHN, a celebrated natural philosopher, was born in Largo, Fife, 16th April 1766. While a boy, shewing a strong bias for the exact

sciences, he was sent to St Andrews University in 1779. In 1785, he entered the Edinburgh Divinity Hall, but devoted most of his time to the sciences, particularly chemistry. In 1788, he left Edinburgh, and after being two years in America, as tutor to the sons of a Virginian planter, he returned to London in 1790. From that time till 1805 he was employed as tutor to the family of Mr Wedgewood, at Etruria, Staffordshire, in travelling on the continent, in contributing to the press, and in making experimental researches: the fruits of his labours were a translation of Buffon's *Natural History of Birds* (1793), the invention of a Differential Thermometer, a Hygrometer, and a Photometer, and the publication of an *Experimental Inquiry into the Nature and Propagation of Heat* (1804), a most ingenious work, constituting an era in the history of that branch of physical science, and for which the Royal Society awarded him the Rumford medals. In March 1805, he was, after a great deal of opposition from the Edinburgh clergy, elected Professor of Mathematics in the university of Edinburgh, and soon after commenced the publication of his *Course of Mathematics*. In 1810, L. invented the process of artificial congelation, performed the experiment in the following year before the Royal Society of London, and in 1813 published a full explanation of his views on the subject; subsequently, he discovered a mode of freeing mercury. In 1819, he was transferred to the chair of Natural Philosophy, a position better adapted to his peculiar genius, and in 1823 published one volume of *Elements of Natural Philosophy*, never completed. In 1832, he was created a knight of the Guelphic Order; and on November 3 of the same year expired at Coates, a small estate which he had purchased near Largo. Besides the instruments above mentioned, he invented an Æthrioscope, Pyroscope, and Atmometer, and contributed many articles to various periodicals on Heat, Light, Meteorology, the Theory of Compression, Electricity, Atmospheric Pressure, &c. His last important work was his discourse on the *Progress of Mathematical and Physical Science during the Eighteenth Century*, which constitutes the fifth dissertation in the first volume of the *Encyclopædia Britannica*.

LESLIE, CHARLES ROBERT, R. A. This distinguished artist was born in London in 1794. His parents were Americans resident there at the time of his birth; they went back to America in 1799, taking with them Charles Robert along with their other children. His father died in 1804, leaving the family in straitened circumstances. Young L. having, from infancy, been fond of drawing, wished to be a painter; but his mother not having the means of giving him a painter's education, he was bound apprentice to Messrs Bradford and Inskcep, booksellers and publishers in Philadelphia. He had been three years at his apprenticeship, when he managed to execute a drawing of the popular actor, George Frederick Cook. The likeness having been pronounced excellent by a number of connoisseurs, a subscription was raised to enable the rising artist to study painting two years in Europe. He accordingly returned to England in 1811, and entered as a student in the Royal Academy. He seems at first to have attempted subjects in what is called the classical style, together with portraits; but by degrees he came to follow out the bent of his genius, and turn his attention to works in that style in which he distinguished himself—viz., genre-painting of the highest class. The first picture that brought him into notice was 'Sir Roger de Coverley going to Church,' exhibited in the Royal Academy in 1819. In 1821, his picture of

'May-day in the Reign of Queen Elizabeth' secured his election as an Associate of the Academy; and 'Sancho Panza and the Duchess,' painted for Lord Egremont, and exhibited in 1824, his best work (of which there is a repetition among the paintings of the British school bequeathed by Mr Vernon to the National Gallery), obtained for him the rank of Academician. After this, till near the period of his death, there were few exhibitions of the Royal Academy to which L. did not contribute. L.'s principal pictures are embodiments of scenes from the works of many of the most popular authors—Shakspeare, Cervantes, Lesage, Molière, Addison, Sterne, Fielding, and Smollett. His works have had a great influence on the English school; and though he almost always executed repetitions of his principal works—a practice that generally leads to decrease the value of pictures—his pictures bring immense prices. Great power of expression, and a delicate perception of female beauty, are the leading points in L.'s pictures. In the early part of his career, his style may be objected to as deficient in colour, and rather dry and hard; but the influence of Newton, his talented compatriot, led him to direct his attention to the works of the Venetian masters, and impart greater richness to his colouring. Later in life, the example of Constable inclined him to strive at producing *empasto*, or fullness of surface, in his pictures. L. accepted the appointment of Professor of Drawing at the military academy of West Point, New York; but he gave up this occupation after a five months' residence, and returned to England. In 1848, he was elected Professor of Painting at the Royal Academy, but resigned in 1851. He died in London in May 1859. His lectures were published in 1845 under the title of *A Handbook for Young Painters*—a very sound and most useful work on art. A life of his intimate friend and brother-artist, Constable, whose great talent he was the first fully to appreciate, was published by him in 1845, and deservedly ranks with the best writings of that class. The *Autobiographical Recollections of Leslie*, edited by Tom Taylor, Esq. (Lond. 1860), is a very interesting book.

LESSING, GOTTHOLD EPHRAIM, an illustrious German author and literary reformer, was born January 22, 1729, at Kamenz, in Saxon Upper Lusatia, where his father was a clergyman of the highest orthodox Lutheran school. After spending five years at a school in Meissen, where he worked very hard, he proceeded to the university of Leipzig in 1746, with the intention of studying theology. But he soon began to occupy himself with other matters, made the acquaintance of actors, contracted a great fondness for dramatic entertainments, and set about the composition of dramatic pieces and Anacreontic poems. This sort of life pained his severe relatives, who pronounced it 'sinful,' and for a short time L. went home; but it was his destiny to revive the national character of German literature; and after one or two literary ventures at Leipzig of a trifling character, he proceeded to Berlin in 1750, where he commenced to publish, in conjunction with his friend Mylius, a quarterly, entitled *Beiträge zur Historie und Aufnahme des Theaters*, which only went the length of four numbers. About this time also appeared his collection of little poems, entitled *Kleinigkeiten*. After a brief residence at Wittenberg, in compliance, once more, with the wishes of his parents, he returned to Berlin in 1753, and in 1755 produced his *Miss Sara Sampson*, the first specimen of *bourgeoisie* tragedy in Germany, which, in spite of some hostile criticism, became very popular. L. now formed valuable literary friendships with Gleim, Ramler, Nicolai, Moses

Mendelssohn, and others. In company with the last two, he started (1757) the *Bibliothek der Schönen Wissenschaften*, the best literary journal of its time, and still valuable for its clear natural criticism; he also wrote his *Fabeln*, his *Literaturbriefe*, and a variety of miscellaneous articles on literature and aesthetics. Between 1760—1765, he lived at Breslau as secretary to General Tauenzien, governor of Silesia. The year after his return to Berlin, he published his master-piece, the *Laocoon*, perhaps the finest and most classical treatise on aesthetic criticism in the German or any other language. In 1767, appeared *Minna von Barnhelm*, a national drama, hardly less celebrated than the *Laocoon*; and in 1768, his *Dramaturgie*, a work which exercised a powerful influence on the controversy between the French and the English styles of dramatic art—i. e., between the artificial and the natural, between the conventional and the true, between shallow and pompous rhetoric, and genuine human emotion. In 1770, L. was appointed keeper of the Wolfenbüttel Library. Two years later appeared his *Emilie Galotti*; and between 1774—1778, the far-famed *Wolfenbüttelschen Fragmente eines Ungenannten*. These Wolfenbüttel Fragments are now known to have been the composition of Reimarus (q. v.), but the odium of their authorship fell at the time on L., and he was involved in much bitter controversy. In 1779, he published his *Nathan der Weise*, a dramatic exposition of his religious opinions (his friend Moses Mendelssohn is said to have been the original of Nathan); and in 1780, his *Erziehung des Menschengeschlechts*, a work which is the germ of Herder's and all later works on the Education of the Human Race. He died February 15, 1781. L. is one of the greatest names in German literature. If his works seem hardly equal to his fame, it is because he sacrificed his own genius, as it were, for the sake of others. When he appeared, the literature of his country was corrupted and enslaved by French influences. The aim of L. was to reinvigorate and emancipate the national thought and taste; and the splendid outburst of national genius that followed, was in a large measure the result of his labours. Compare Adolf Stahr's *G. E. Lessing, Sein Leben und Seine Werke* (2d. edit. Berlin, 1862).

LETHAL WEAPON, in Scotch criminal law, means a deadly weapon by which death was caused, as a sword, knife, pistol.

LETHÉ, in Grecian Mythology, the stream of forgetfulness in the lower world, from which souls drank before passing into the Elysian Fields, that they might lose all recollection of earthly sorrows.

LETTER OF MARQUE (because the sovereign allowed a market or mart—i. e., authorised the disposal of the property taken), the commission authorising a privateer to make war upon, or seize the property of, another nation. It must be granted by the Lords Commissioners of the Admiralty, or by the vice-admiral of a distant province. Vessels sailing under such commissions are commonly spoken of as *letters of marque*. Making war without letters of marque by a private vessel is piracy. Letters of marque were abolished among European nations at the treaty of Paris in 1856.

LETTERS, a legal term used in the United Kingdom in combination with other words. *Letters of Administration* in England and Ireland mean the legal document granted by the Probate Court to a person who is appointed administrator to a deceased person who has died intestate. See ADMINISTRATION, WILL, INTESTACY. *Letter of Attorney*, or power of attorney, in English law, is a writing or deed authorising an agent (whether he is a certificated attorney or not) to do any lawful act

LETTERS—LETTERS AND ARTICULATE SOUNDS.

in the stead of the party executing it. *Letters conform*, in Scotch law, mean a writ issued by the supreme court enforcing a decree of an inferior court. *Letter of credit* is an authority from one banker to another to pay money to a third person. *Letters of execupation*, in Scotch criminal law, are a warrant obtained by a prisoner to summon witnesses on his behalf at his trial. *Letter of guarantee*, in Scotch law, means a writing guaranteeing a debt or engagement of another. *Letter of licence* is a deed or instrument executed by the creditors of a trader who is insolvent, giving him time to pay, and, in the meantime, to carry on his business under surveillance. *Letters missive*, in England, is an order from the Lord Chancellor to a peer requesting the latter to enter an appearance to a bill filed in Chancery against such peer; in Scotland, the word means any written agreement or memorandum relative to some bargain as to mercantile matters, or as to the sale of land or houses or the letting of land. *Letters patent* mean a writing of the Queen, sealed with the Great Seal of Great Britain, authorising or appointing the party to whom it is addressed to do some act, or execute some office, as creating a peer; a judge, a Queen's Counsel; also granting a patent right to a person who is the first inventor of some new contrivance. See PATENT. *Letters of request*, in English ecclesiastical law, mean a writ which commences a suit in the Court of Arches against a clergyman, instead of proceeding, in the first instance, in the Consistory Court. *Letters of safe conduct* mean a writ, under the great seal, to the subject of a state at war with this country, authorising and protecting such subject while dealing or travelling in this country, so that neither he nor his goods may be seized, as they otherwise might be.

LETTERS AND ARTICULATE SOUNDS.

Letters are conventional marks or visible signs of the elemental sounds of spoken language. The earliest symbols of sounds represented syllables rather than simple sounds (see ALPHABET, HIEROGLYPHICS, CHINESE LANGUAGE). It was only gradually that syllables were reduced to their ultimate elements, and all alphabets yet bear marks of their syllabary origin (see letter K), displaying various imperfections both of excess and defect.

Articulate sounds are divided into vowels and consonants; and the latter are subdivided into voiceless and vocal elements (otherwise called 'sharps' and 'flats'), obstructive and continuous elements (otherwise called 'mutes' and 'semi-vowels'), and liquids. Many other divisions have been proposed, but the above classification embraces all real varieties. The elements are likewise classified according to the organs which form them, as labials, linguals, gutturals, nasals, &c. A physiological description of the articulate sounds used in English speech, will shew the necessary extent of a perfect system of letters, and exhibit the shortcomings of our present alphabet.

All the elements of speech are susceptible of separate formation; and in the following description, reference is always intended to the exact sound of each element, and not to the names of the letters.

Emitted breath mechanically modified forms every articulate sound. The breath is first modified in the throat, by a certain amount of constriction in the larynx, wanting which restraint, the air would flow out noiselessly, as in ordinary breathing, or gushingly, as in sighing. The breath is thus economised into a steady stream, and rendered audible by the degree of roughness or 'asperation' it acquires when forced through a narrow aperture. This 'asperated' current of air, when articulated, forms whispered speech. In passing through the larynx, the breath is further acted on by the

opposing ligaments of the glottis (the aperture of the larynx), and sonorous voice is produced. The vocalised or asperated breath receives vowel and articulate modification in its passage through the mouth. When the mouth is sufficiently open to allow the breath to flow without obstruction or oral asperation, the air is moulded into the various qualities of vowel-sound; and when the channel of the mouth is obstructed, or narrowed so much as to cause a degree of asperation of the breath between the tongue and the palate, the lips, &c., consonant-sounds are produced.

The upper part of the mouth is an immovable arch: all variations in the shape of the oral passage are consequently effected by the tongue and the lips. [A nasal variety of vowel-sounds occurs in French—represented by *ñ* after the vowel-letters. These sounds are formed by depressing the soft palate, which otherwise covers the inner end of the nostrils, and allowing part of the breath to pass through the nose, while the remainder is modified in the usual way.]

Vowels.—When the tongue is raised in its greatest convexity towards the roof of the mouth, but without being so close as to roughen or asperate the breath, the resulting vowel quality is that heard in the word *ee*; and progressively less degrees of elevation produce a series of lingual vowels, of which *Ah* is the most flattened—the lips being equally expanded throughout the series, to allow the breath to escape without labial modification.

When the aperture of the lips is contracted in the greatest degree short of asperating the breath, the resulting vowel-quality is that heard in the word *ooze*; and progressively less degrees of labial contraction form a series of labial vowels, of which *Aw* is the most open—the tongue being retracted throughout the series, to direct the breath without lingual modification forward against the lips.

A third series of vowels is formed by combining elevated positions of the tongue and contracted positions of the lips, or retracted positions of the tongue, and expanded positions of the lips. Of this labio-lingual series, the German *ü* is the most contracted, and the English sound heard in the word *err* the most open.

The following table shews the principal vowels of each class:

	Lingual.	Labio-Lingual.	Labial.
Close, . . .	{ ee(i)	{ ü	{ oo(ze)
Medial, . . .	{ ai(i)	{ ö	{ oi(i)
Open, . . .	{ e(re)	{ ø	{ o(re)
	{ ah	{ ørr)	{ øll)

The possible modifications of the oral channel are endless, and untraceably minute, as are the shades of vowel-quality heard in dialects, and among individual speakers. In English, there are altogether thirteen established varieties, as heard in the words *ee*, *ill*, *ale*, *ell*, *an*, *ask*, *ah*, *err*, *up*, *all*, *ore*, *old*, *ooze*. Besides these, which a perfect alphabet must represent, we have the diphthongal sounds heard in the words *isle*, *owl*, *oil*, and the asperated compound *yoo*—the sound of the letter *u* in *use*—which is often, but erroneously, supposed to be a diphthongal vowel.

The Aspirate H.—The letter H (see ASPIRATE) represents an expulsive breathing, modified by the form of the vocal element which follows it—as in *he*, *hay*, *high*, *hoe*, &c., in which the H will be observed to have the quality of *è*, *ä*, *é*, &c., but without the laryngeal contraction, and consequent asperation of the breath, which forms a whispered vowel.

Consonants.—When the tongue is raised convexly against the back of the palatal arch so as to stop the breath, the separation of the tongue from the roof

LETTERS AND ARTICULATE SOUNDS.

or back of the mouth is accompanied by a percussive effect, which is represented in the English alphabet by C, K, and Q, and by G when the obstructed breath is vocalised. While the tongue is in this obstructive position, if the soft palate be depressed so as to uncover the inner end of the nostrils, the breath will pass through the nose. This, with vocalised breath, is the formation of the element represented in English, for lack of an alphabetic character, by the digraph *ng*.

[The percussive effect of K—G is slightly modified by the point at which the tongue leaves the palate before different vowels, as in the words *key* and *cow*; the consonant of the latter word being struck from the soft palate, and that of the former word further forward, from the hard palate. A peculiar Anglicism of pronunciation is derived from the substitution of the anterior for the posterior formation of K—G in certain words, as *kind*, *card*, *guide*, *guard*, *girl*, &c.]

When the fore-part of the tongue is raised to the front of the palate, so as to stop the breath, the separation of the tongue is accompanied by the percussive effect which is represented by T, and by D when the obstructed breath is vocalised. The uncovering of the end of the nostrils while the tongue is in this obstructive position produces, with vocalised breath, the sound represented by N.

When the lips are brought in contact (the lower lip rising to join the upper lip), their separation from the obstructive position is accompanied by the percussive effect represented by P, and by B when the obstructed breath is vocalised. The uncovering of the nares while the lips are in contact, produces, with vocalised breath, the sound represented by M.

The remaining consonants are all of the continuous or non-obstructive class; the organs of articulation being so placed as merely to narrow the apertures, central or lateral, through which the breath issues with a degree of hissing or asperation.

The elevation of the base of the tongue so as to leave a narrow aperture between its centre and the back-part of the palate, forms, with vocalised breath, the sound of Y initial as in *ye*. The sound of *y* resembles that of the vowel *é*, but with the contracted aperture and resulting oral asperation of the breath essential to a consonant. The same position with voiceless breath forms the German *ch* as in *tch*—an element which is heard in English as the sound of H before *u*, as in *hue*. [The Scotch guttural heard in *loch* differs from this only in the more retracted position of the tongue, which is approximated to the soft instead of the hard palate. The same position with vocalised breath produces the soft Parisian *burr*. The approximation of the concave root of the tongue to the fringe of the soft palate causes the uvula to flutter in the breath, and forms the rough Northumbrian *burr*.]

The elevation of the middle of the tongue towards the front of the palatal arch, with a narrow central passage for the breath, produces the element which, for lack of an alphabetic character, is represented by the digraph *Sh*; and the same position forms, with vocalised breath, the common element heard in *pleasure*, *sciure*, &c., but which has no appropriate literal symbol in English.

The approximation of the flattened point of the tongue to the front of the mouth, so as to leave a narrow central passage between the tongue and the upper gum, forms the sound represented by S; and by Z when the breath is vocalised.

The elevation of the tip of the tongue towards the rim of the palatal arch causes a degree of vibration of the edge of the tongue, and consequent asperation of the breath, proportioned to the degree of elevation, which is the English sound of the letter R.

[R final, or before a consonant, has little or no asperation, but has almost the pure sonorosity of a vowel, as in *err*, *earn*, &c. The roughly trilled Scotch or Spanish R is formed by the quivering of the whole fore-part of the tongue as it is laxly approximated to the palate.]

The approximation of the lower to the upper lip, so as to leave a central aperture for the breath, produces, with vocalised breath, the sound of W initial, as in *woo*. The sound of *w* resembles that of the vowel *oo*, but with a more contracted aperture. The same position, with voiceless breath, forms the element represented, for lack of an alphabetic character, by the digraph *Wh*.

The remaining varieties of English articulate sounds are formed by forcing the breath through lateral apertures, instead of one central aperture.

When the fore-part of the tongue is spread against the front of the palate, and vocalised breath passes laterally over the middle of the tongue, the sound of L is heard. [The same position of the tongue forms, with voiceless breath, the sound of *Ll* in Welsh. The English L, as heard before *u* (= *yeo*) is modified by convexity of the back-part of the tongue towards its position for Y, forming the sound which is represented in Smart's Dictionary by *L'*, as in *lawe*, pronounced *loor*. A peculiar Gaelic variety of L is formed by raising the back-part of the tongue to the soft palate, and passing the voice laterally over the root of the tongue.]

When the tip of the tongue is applied to the upper teeth (or the gum), and the breath is emitted laterally over the point of the tongue, the sound of the digraph *Th* as in *this* is heard; and, with vocalised breath, the sound of *Th* in *then*—neither of which elements is represented in our alphabet.

When the middle of the lower lip is applied to the edge of the upper teeth, and the breath is emitted laterally between the teeth and the lip, the sound represented by F is produced; and, with vocalised breath, the sound of V.

Liquids.—The voice is so little intercepted in passing through the nostrils (forming *m*, *n*, or *ng*), and through the wide apertures of L, and also of R when not initial in a syllable, that the sound has almost the pure sonorosity of a vowel; and these elements have received the name of Liquids, to designate their property of syllabically combining with voiceless consonants—seeming to flow into and to be absorbed by them, and losing much of their natural quantity as vocal sounds; as in *lamp*, *teme*, *tent*, *sense*, *tenth*, *int* (= *ing*), &c.; *milk*, *spilt*, *help*, *self*, *elce*, *Welsh*, *health*, &c.; *hark*, *heart*, *harp*, *scrif*, *earth*, *harsh*, *horses*, &c. The characteristic effect of the Liquids will be best perceived by contrasting such words as *teme* and *Thames*, *hence* and *hens*, *elce* and *ells*, *curse* and *curs*—in which the normal influence of vocal consonants on subsequent elements is manifested in the vocalising of the sibilant in the second word of each pair.

From this review of the physiological varieties of articulate sounds, it will be evident that our alphabet of 26 letters is very imperfect, both by redundancy and deficiency. (1.) The same sounds are represented by more than one letter; as C, K, and Q; C and S; G and J. (2.) The same letter represents more than one sound; as C, which is sometimes K, and sometimes S; G, which is sometimes the vocalised form of K, and sometimes J; N, which is sometimes N, and sometimes *ng*; S, which is sometimes S, and sometimes Z; and Y, which is sometimes a consonant (when initial), and sometimes a vowel, sounded like the letter I. (3.) Single letters are used to represent articulate compounds; as G and J, which are sounded *dzh* [the voiceless form of J is represented by *ch*, as in *chair*]; U, which is

LETTER-WOOD—LETTUCE.

sounded *yo*; and X, which is sounded *ks*, and sometimes *gs*. (4.) The alphabet contains no characters for six of our undoubted consonant elements—viz, Wh, Th(in), Th(en), Sh, Zh, Ng. (5.) Each vowel-letter represents many sounds; and the lack of seven characters to denote the excess of our vowel-sounds over the number of our vowel-letters, is supplied by about sixty combinations of two or of three letters, so that the original phonetic character of the alphabet is almost entirely lost in the confusion of our orthography.

Consonants form, as it were, the bare and bony skeleton of speech; vowels give definite shape and individuality to words. Thus the consonants *spri* constitute the common skeleton of such diverse words as *spirit—spirit, sprat—sprite, spirit, support, separate, aspirate—asperate*, which receive their distinct configuration and filling up from the vowel-sounds, which cover the consonant skeleton with moulded elegance and variety. Consonants are thus the more stable elements of words, and their interchanges in the corresponding words of allied tongues are found to follow certain general laws dependent on the relations and affinities of letters. See GRAMM'S LAW. These relations are exhibited in the following table :

	SHUT.		OPEN.		NASAL.	
	Sharp.	Flat.	Sharp.	Flat.	Sharp.	Flat.
1. Labials, .	<i>p</i>	<i>b</i>	<i>f</i> <i>wh</i>	<i>v</i> <i>w</i>	<i>ʃ</i>	<i>m</i>
2. Linguals, .	<i>t</i>	<i>d</i>	<i>th</i> <i>s</i> <i>sh</i>	<i>dh</i> <i>s</i> <i>sh</i>	<i>r</i>	<i>n</i>
3. Gutturals, .	<i>k</i>	<i>g</i>	<i>U (Welsh)</i> <i>ch (loch)</i>	<i>h</i> <i>gh</i>	<i>ng</i>	<i>ng</i>

In pronouncing the letters of the first class, the lips are chiefly concerned; in the second, the principal organ is the tongue, or the tongue and the teeth (whence they are also called *dentals*); and in the third, the back-parts of the tongue and palate are employed. But while all the sounds of each class have thus a common organic relation, the first pair differs from the other letters of the same class by being *obstructive* or shut—otherwise called *Mute* (q. v.); the remaining letters, having open apertures, are *continuous* or sibilant in effect—otherwise called *Asperate* (q. v.). The difference also between the members of the several pairs is of the same kind throughout; *p* differs from *b* as *f* does from *v*, or *t* from *d*, or *sh* from *dh*.

Various attempts have been made, hitherto unsuccessfully, to introduce a system of phonotypes, in which each sound should be represented by one invariable character; see PHONETIC WRITING. In Mr Ellis's *Plea for Phonetic Spelling*, and Mr Melville Bell's *Principles of Speech*, the student will find the most recent and complete developments of the theory of Articulate Sounds which have appeared in this country.

LETTER-WOOD, one of the most beautiful productions of the vegetable kingdom; it is the heart-wood of a tree, found sparingly in the forests of British Guiana, the *Piratinera Guianensis* of Aublet, and the *Brosimum Aubletii* of Poeppig,

* The 'sharp' or voiceless *r* is of frequent but unrecurrent occurrence. It is heard in French, as the sound of *r* final after a consonant, as in *theatre*; and in Scotch, as a substitute for *thr*, as in *three*, pronounced *rhee*.

† The 'sharp' forms of the nasals are in constant use as interjectional sounds, as in *humph!* (pronounced 'hm /), 'kn / (expressive of sneering), and 'mhm / used as an affirmative in Scotland.

belonging to the Bread-fruit family (*Artocarpaceae*). It grows from 60 to 70 feet high, and acquires a diameter of from 2 to 3 feet. The outer layers of wood (albumen) are white and hard; the central portion, or heart-wood, which rarely exceeds 7 inches in thickness, is extremely hard and heavy, and is of a rich dark-brown colour, most beautifully mottled with very deep brown, almost black spots, arranged with much greater regularity than is usually the case in the markings of wood, and bearing a slight resemblance to the thick letters of some old black-letter printing. Its scarcity and value make it an article of rare and limited application. It is used only in this country for fine veneer and inlaying work, and in Guiana for small articles of cabinet-work. The natives make bows of state of it, but are said to prefer a variety which is not mottled.

LETTRES DE CACHET, the name given to the famous warrants of imprisonment issued by the kings of France before the Revolution. All royal letters (*lettres royales*) were either *lettres patentes* or *lettres de cachet*. The former were open, signed by the king, and countersigned by a minister, and had the great seal of state appended. Of this kind were all ordinances, grants of privilege, &c. All letters-patent were registered, or *enterained*, by the parliaments. But these checks on arbitrary power did not exist with regard to *lettres de cachet*, also called *lettres closes*, or sealed letters, which were folded up and sealed with the king's little seal (*cachet*), and by which the royal pleasure was made known to individuals or to corporations, and the administration of justice was often interfered with. The use of *lettres de cachet* became much more frequent after the accession of Louis XIV. than it had been before, and it was very common for persons to be arrested upon such warrant, and confined in the Bastille (q. v.), or some other state prison; where some of them remained for a very long time, and some for life, either because it was so intended, or, in other cases, because they were forgotten. The lieutenant-general of the police kept forms of *lettres de cachet* ready, in which it was only necessary to insert the name of the individual to be arrested. Sometimes an arrestment on *lettres de cachet* was a resource to shield criminals from justice.

LETTUCE (*Lactuca*), a genus of plants belonging to the natural order *Compositae*, sub-order *Cichoraceae*, having small flowers with imbricated bractees, and all the corollas ligulate, flatly compressed fruit, with a thread-like beak, and thread-like, soft, deciduous pappus.—The GARDEN L. (*L. sativa*) is supposed to be a native of the East Indies, but is not known to exist anywhere in a wild state, and from remote antiquity has been cultivated in Europe as an esculent, and particularly as a salad. It has a leafy stem, oblong leaves, a spreading flat-topped panicle, somewhat resembling a corymb, with yellow flowers, and a fruit without margin. It is now generally cultivated in all parts of the world where the climate admits of it; and there are many varieties, all of which may, however, be regarded as sub-varieties of the COLE L. and the CABBAGE L., the former having the leaves more oblong and upright, requiring to be tied together for blanching—the latter with rounder leaves, which spread out nearer the ground, and afterwards *boll* or roll together into a head like a small cabbage. The L. is easy of digestion, gently laxative, and moderately nutritious, and is generally eaten raw with vinegar and oil, more rarely as a boiled vegetable. The white, and somewhat narcotic milky juice of this plant is inspissated, and used under the name of *Lactucarium* (q. v.), or *Thridace*,

as an anodyne, sedative, opiate medicine. The best and most useful kind of this juice is obtained by making incisions in the flowering stems, and allowing the juice which flows to dry upon them. Lettuces are sown in gardens from time to time, that they may be obtained in good condition during the whole summer. In mild winters, they may be kept ready for planting out in spring.—The other species of this genus exhibit nothing of the bland quality of the garden lettuce.—The STRONG-SCENTED L. (*L. virosa*) is distinguished by the prickly keel of the leaves, and by a black, smooth seed, with a rather broad margin. It is found in some parts of Britain. *Lactucarium* is prepared from its fresh-gathered leaves, in the flowering season. The leaves have a strong and nauseous, narcotic and opium-like smell.—*L. perennis* adorns with beautiful blue flowers the stony declivities of mountains and clefts of rocks in some parts of Germany, as in the Harz, &c., but is not a native of Britain, which, however, possesses one or two other species in qualities resembling *L. virosa*.

LEUCADIA, the ancient name of SANTA MAURA (q. v.).

LEUCHTENBERG. See BEAUHARNAIS.

LEUCINE (derived from the Greek word *leucos*, white) belongs to the class of bodies to which chemists now apply the term amido-acids, and which are substances in which one equivalent of the hydrogen of the radicle of an acid is replaced by one equivalent of amidogen (NH_2). The empirical formula for leucine is $\text{C}_6\text{H}_{11}\text{NO}_4$, while that of caproic acid (whose amido-acid it is supposed to be) is $\text{C}_6\text{H}_{11}\text{O}_4$. It is obvious that if for one of these twelve equivalents of hydrogen one equivalent of amidogen is substituted, the latter formula becomes $\text{C}_6\text{H}_{11}(\text{NH}_2)\text{O}_4$, which contains the same equivalents as the formula $\text{C}_6\text{H}_{12}\text{NO}_4$, but indicates more closely their mode of grouping.

Leucine is of great importance in physiological chemistry, being a constituent of most of the glandular juices of the body. Considering the sources from which it is obtained artificially, there can be no doubt that the leucine found in the body is one of the numerous products of the regressive metamorphosis of the nitrogenous tissues.

LEUCIPPUS, the founder of the Atomistic School of Grecian philosophy, and forerunner of Democritus (q. v.). Nothing is known concerning him, neither the time nor the place of his birth, nor the circumstances of his life.

LEUCISCUS, a genus of fresh-water fishes, of the family *Cyprinidae*, containing a great number of species, among which are the Roach, Ide, Dace, Graining, Chub, Red-eye, Minnow, &c. There are no barbels. The anal and dorsal fins are destitute of strong rays.

LEUCOCYTHEMIA (derived from the Greek words *leucos*, white, *cytos*, a cell, and *hæma*, blood) is a disease in which the number of white corpuscles in the blood appears to be greatly increased, while there is a simultaneous diminution of the red corpuscles. The disease was noticed almost at the same time (in 1850) by Bennett of Edinburgh and Virchow of Würzburg; the former giving it the name standing at the beginning of the article, while the latter gave it the less expressive name of *Leukæmia*, or *White Blood*.

The increase of the white or colourless corpuscles seems to be always accompanied, and probably preceded, by other morbid complications, of which the most frequent are enlargement of the spleen, of the liver, and of the lymphatic glands. In nineteen cases, it was found that enlargement of the spleen

was present in sixteen, enlargement of the liver in thirteen, and enlargement of the lymphatics in eleven instances. Hence, tumefaction of the abdomen is one of the most prominent symptoms.

The microscopic examination of a single drop of blood is sufficient to determine the nature of the disease. The causes of leucocythemia are unknown; and although the most varied remedies have been tried, the disease is almost invariably fatal.

LEUCOL, LEUCOLINE, or QUINOLINE ($\text{C}_{15}\text{H}_7\text{N}$), is one of the compounds obtained by the distillation of coal-tar. It is also obtained by the distillation of quinine, cinchonine, or strychnine with potash. It is a colourless and strongly refracting oil, which boils at about 460° , has a specific gravity of 1.081, is insoluble in water, is soluble in alcohol and ether, and neutralises acids, forming crystallisable salts with them. On boiling two parts of leucol with three of iodide of amyl, crystals are obtained, which, when dissolved in water, treated with an excess of ammonia, and boiled for some time, yield a resinous substance, which is readily soluble in alcohol, and furnishes a splendid blue dye.

LEUCOMA (derived from the Greek word *leucos*, white) is the term applied to a white opacity of the cornea—the transparent front of the Eye (q. v.). It is the result of acute inflammation, giving rise to the deposition of coagulable lymph on the surface, or between the layers of the cornea. It is sometimes re-absorbed on the cessation of the inflammation, and the cornea recovers its transparency; but in many cases it is persistent and incurable.

LEUCTRA, anciently, a village of Bœotia, in Greece, famous for the great victory which the Thebans under Epaminondas (q. v.) here won over the Spartan king Cleombrotus (371 B. C.), in consequence of which the influence exercised by Sparta for centuries over the whole of Greece was broken for ever.

LEUK, a small town (pop. about 600) in the canton of Valais, Switzerland, on the right bank of the Rhone, 15 miles above Sion. It is noted in association with the *Baths* of Leuk, situated 8 miles northward at the head of the valley of the Dala and the foot of the ascent over the Gemmi pass. At this place, which is 4500 feet above the sea, there is a hamlet of 300 inhabitants, and several lodging-houses and hotels for the accommodation of patients and travellers. The springs have a high temperature (120°F .), are slightly saline, chalybeate, and sulphureous, and are used both for drinking and bathing. They are chiefly useful in diseases of the skin; and one peculiarity is the length of time the patients remain in the baths—as long as 8 hours a day. For this purpose there are several apartments of 20 feet square, in which as many as 15 or 20 persons of both sexes, clad in long woollen dresses, bathe in common; sitting up to their necks in water, they beguile the time with conversation, chess, reading the newspapers, &c. There appears to have been a bathing establishment here as early as the 12th century.

LEUTHEN, a village of Prussia, in Lower Silesia, 9 miles west of Breslau. Pop. 894. It is celebrated for the victory won there, 5th December 1757, by Frederick the Great, with 33,000 men, over the Austrians under Prince Charles of Lorraine at the head of 92,000. The Austrians lost 7000 killed and wounded, 21,500 prisoners, and 134 pieces of artillery; the Prussians only 3000 killed and wounded. The result of this victory was the reconquest of the greater part of Silesia by the Prussians.

LEVANT—LEVER.

LEVANT, THE—from the Italian *Il Levante*, the *Orient*, or *Rising*, that is, the East—a name employed throughout the whole of Europe to designate the eastern parts of the Mediterranean Sea and adjacent countries. In a wider sense, it is applied to all the regions eastward from Italy, as far as the Euphrates and the Nile; but more generally is used in a more restricted sense, as including only the coasts of Asia Minor, Syria, and Egypt.

LEVANT AND COUCHANT, a phrase in English Law applied to cattle which have strayed into another's lands, and have been so long there that they have lain down and slept there.

LEVA'RI FA'CIAS, WRIT OF, in English Law, is a writ of execution issued upon a judgment, by which the judgment creditor takes the real and personal estate, such as lands, houses, furniture, &c., of his debtor to satisfy his debt. The mode by which this was done was by the sheriff drawing the rents and paying the creditor. The writ is now practically superseded by the writ of *Elegit* (q. v.) as regards real estate, and *Fieri Facias* (q. v.) as regards personal estate.

LEVEE, the state ceremonial of the sovereign receiving visits from those subjects whose position entitles them to that honour. By the usage of the court of Great Britain, a levee differs from a drawing-room in this respect, that gentlemen only are present (excepting the chief ladies of the court), while at a drawing-room both ladies and gentlemen appear. The name is owing to such receptions being originally held in the monarch's bedchamber at the hour of rising (*Fr. lever*).

LEVÉE, the French name for an Embankment (q. v.).

LEVEL AND LEVELLING. Level is a term applied to surfaces that are parallel to that of still water, or perpendicular to the direction of the plumb-line; it is also applied to the instrument employed in determining the amount of variation from perfect levelness. The instrument is a cylindrical glass tube very slightly convex on one side, and so nearly filled with water, or, what is better, with alcohol, that only a small bubble of air remains inside. The level is then mounted on a three or four legged stand, with its convex side upwards, and by means of a pivot and elevating screws, is made capable of assuming any required position. If the level be properly constructed, the bubble should lie *exactly* in the middle of the tube when the instrument is properly adjusted, and, at the same time, the line of sight of the telescope attached to the level should be accurately parallel to the surface of still water. In ordinary levels, this first condition is seldom seen, and, instead, two notches are made on the glass to mark the position

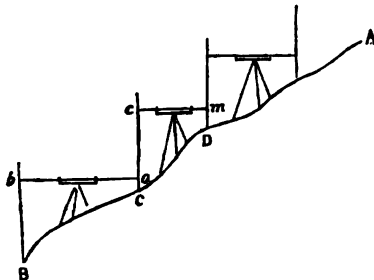

of the two extremities of the bubble when the instrument is level. The tube and bubble should be of considerable length to insure accuracy. The leveller requires two assistants, each furnished with

a pole from 10 to 14 feet high, and graduated to feet and inches, or feet and tenths of feet. If he wishes to measure the height of A above B, he may do this by beginning either at A or B. Let the latter be the case, then one assistant is placed at B, holding his pole upright; the other is sent forward to C (which must be below the level of the top of the pole at B); the surveyor, who places himself between them, reads off the height Bb, which he puts down in the back-sight column of his book, and then turns the level to C, reading off Cc, which is entered in the front-sight column. The surveyor and his assistant at B then take up new positions, the latter at D; the back-sight Cc and the front-sight Dm are read off, and the process is repeated till one of the assistants reaches A. The excess of the sum of the back-sights over that of the front-sights gives the height of A above B. A little consideration will show that this method can only hold true when practised on a small scale, and consequently in extensive surveys, the level (as found by the above-described method) requires to be reduced by an allowance for the earth's curvature.

LEVEN, LOCH, a beautiful sheet of water, of an oval form, in the east of Kinross-shire, Scotland, measuring between 10 and 11 miles in circuit, and dotted here and there with small islands, the chief of which are, St Serf's Inch, at the east end, 80 acres in extent, with the remains of a religious house of great antiquity (see *CULDEES*), and another of 5 acres, opposite the town of Kinross, on which stand the ruins of Loch Leven Castle. The loch is supplied by several small streams, and empties itself by the Leven into the Firth of Forth. It has long been celebrated for the quantity and quality of its trout, which are of excellent flavour, and average about a pound in weight, although some are found of 4, 6, and even 10 lbs. Pike and perch also occur; a pike was caught in 1846 weighing 29 lbs. The rich colour of the Loch L. trout is due to the abundance of a certain kind of crustacea upon which they feed. Loch Leven Castle is connected with several events in Scottish history, the most noted being the imprisonment of Queen Mary in June 1567. Here she was forced to sign her abdication of the throne; and, after one unsuccessful attempt, succeeded, by the aid of George Douglas, the governor's brother, and of Willie Douglas, 'a foundling,' supposed to be a relative of the family, in effecting her escape (2d May 1568).

LEVEN, LOCH, an arm of the sea, or rather of Loch Linnhe (q. v.), on the west coast of Scotland, between Argyll and Inverness, is about 11 miles in length by, on an average, less than one mile in breadth, and is remarkable for the wildness and grandeur of its scenery. The current produced in this loch by the ebb and flow of the tide runs at the rate of at least 4 miles an hour.

LEVER, the most simple and common, but, at the same time, most important of the seven mechanical powers, consists of an inflexible rod—straight or bent, as the case may be—supported at some point of its length on a prop which is called the *fulcrum*, and having the *weight* to be moved and the *power* to move it applied at other two points. In the accompanying illustration (fig. 1, a), AB is the lever, F the fulcrum, A and B the points of application of P and W, the power (or pressure) and weight respectively.



Fig. 1, a.

If the arms AF and BF be equal, the power P and the weight W must also be equal to produce equilibrium; if the arm of the power, AF, be longer

LEVER.

than the arm of the weight, BF, then, to produce equilibrium, the power P must be less than the weight W, and *vice versa*; if AF be double the length of BF, then P, to produce equilibrium, must be half of W; and, generally, as is shewn in the elementary treatises on mechanics, the power and weight are in the inverse ratio of their distances from the fulcrum. This is equally true for straight or bent levers; but (fig. 1, b), the distance of the

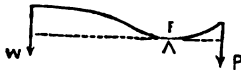

Fig. 1, b.

power and weight from the fulcrum is not, in all cases, the actual length of the arms, but the lengths of perpendiculars from the fulcrum upon the directions of the power and weight. This principle holds good, whatever be the relative positions of the power, weight, and fulcrum; and as there can be three different arrangements of these, we thus obtain what are called 'the three kinds of levers.' The first kind (fig. 2) is where the fulcrum is placed between the power and the weight; the Balance (q. v.), spade (when used for raising earth), see-saw, &c., are examples of this; and scissors and

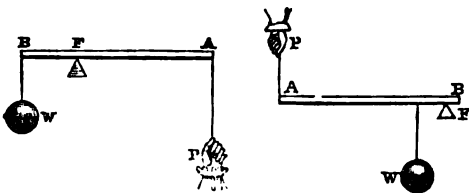

Fig. 2.

Fig. 3.

pincers are examples of double-levers of the same kind. Levers of the second kind (fig. 3) are those in which the weight is between the power and fulcrum; examples of this are the crowbar, when used for pushing weights forward, the oar—the water being the fulcrum, and the row-lock the point of application of the weight—and the wheelbarrow; and of double-levers of this kind we have nut-crackers as an example. In levers of the

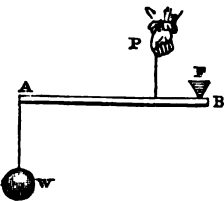

Fig. 4.

third kind (fig. 4), the power is between the weight and the fulcrum. Fishing-rods, whips, umbrellas, and most instruments used with the hand alone, are levers of the third kind, and shears, tongs, &c., are examples of double-levers of this class. It is evident that, to produce equilibrium in levers of the first kind,

the power may, according to the ratio of the lengths of the arm, be either greater or less than the weight; in the second kind, it must always be less; and in the third kind, always greater. This is expressed in technical phrase by saying that the first kind of lever gives a mechanical advantage or disadvantage (see MECHANICAL POWERS), the second always gives a mechanical advantage, and the third always a mechanical disadvantage. Levers of the second kind, having the same mechanical advantage, are, when worked by man, twice as powerful as those of the first kind, because in the one case he uses his muscular force as the power, in the other case only his weight. Levers of the third kind are used when velocity, or a large extent of motion, is required at the expense of power, and we consequently find this form much used in the

structure of the limbs of animals. The structure of the human arm (fig. 5) is a very good example of this; the fulcrum is the socket (C) of the elbow-joint, the power is the strong muscle (the biceps)

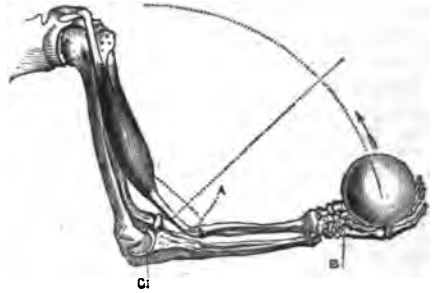

Fig. 5.

which passes down the front of the humerus, and is attached, at A, to the radius (see ARM); the weight is the weight of the forearm, together with anything held in the hand, the two being supposed to be combined into one weight acting at B. By this arrangement, a large extent of motion is gained, by a slight contraction or extension of the muscle.

When a large mechanical advantage is required, this may be obtained, without an inordinate lengthening of the lever, by means of a combination of them (as in fig. 6). Here the levers have their arms in the ratio of 3 to 1, and a little consideration will make it plain that a power (P) of 1 lb. will balance

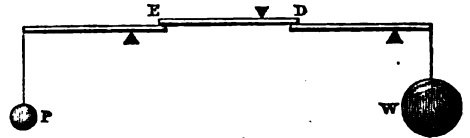

Fig. 6.

a weight of 27 lbs.; but in this instance the particular defect of the lever as a mechanical power shews itself prominently; for if the weight has to be lifted two inches, the power requires to be depressed (2 x 27 or) 54 inches; and as the extent of sweep of the power cannot be largely increased without inconvenience, the advantages of this machine are confined within narrow limits.

LEVER, CHARLES, Irish novelist, was born in Dublin, 31st August 1806. He was educated for the medical profession, studying first at Trinity College, and afterwards on the continent. After taking his degree at Göttingen, he was attached (as physician) to the legation at Brussels, and, on his resignation of that post, became editor of the *Dublin University Magazine*. He opened his brilliant literary career by *Harry Lorrequer*; and since that period he has published a whole library of fiction, the larger proportion of which was issued in the serial form with illustrations. Among L.'s best novels may be specified *Charles O'Malley*, *Tom Burke*, *Roland Cashel*, *The Knight of Gwynne*, *The Dodd Family Abroad*, *Davenport Dunn*. When he undertook the editorship of the famous Irish magazine, L. fixed his residence in the neighbourhood of Dublin; but when, after a few years' trial, his work became distasteful, he removed to Florence, where he at present (1863) resides.

The earlier novels of L. are remarkable for a certain boisterous mirth and whirl of incident. His ladies and gentlemen seem under the influence

of champagne, his peasants and servant-men of 'potheen.' Latterly, the current of his genius has become broader and clearer, and several of his recent works, while they are not devoid of the early flash and outbreak, aim after something of a thoughtful interest, and an artistic development of character.

LEVERET, the young of the hare during the first year of its age.

LEVERRIER, URBAIN JEAN JOSEPH, a French astronomer of great celebrity, was born at St L , in the department of Manche, 11th March 1811. He was admitted into the Polytechnic in 1831, and was subsequently employed for some time as an engineer in connection with the Tobacco Board. In 1836, he published *Memoires sur les Combinaisons du Phosphore avec l'Hydrog ne et avec l'Oxyg ne*. His *Tables de Mercure*, and several memoirs on 'the secular inequalities,' opened to him the door of the Academy in 1846; and at the instigation of Arago, he applied himself to the examination of the disturbances in the motions of the planets, from which the existence of an undiscovered planet could be inferred; and as the result of his laborious calculations, directed the attention of astronomers to the point in the heavens where, a few days afterwards, the planet Neptune was actually discovered, the same thing being also, by a remarkable coincidence, done about the same time, and independently, by the English astronomer Adams (q. v.). For this L. was rewarded with the Grand Cross of the Legion of Honour, a professorship of astronomy in the Faculty of Sciences at Paris, and various minor honours. When the Revolution of 1848 broke out, L. sought distinction as a democratic politician; the department of La Manche chose him in May 1849 to be a member of the Legislative Assembly, where he at once became counter-revolutionary; and in 1852, Louis Napoleon made him a senator. After the death of Arago, an imperial decree of January 1854 conferred upon L. the directorship of the Observatory of Paris.

LEVI, the third son of Jacob and Leah (Gen. xlix. 34). He is conspicuous through the part he took with his brother Simeon in the wholesale slaughter of the inhabitants of Shihem, together with Hamor and Shechem their princes, while in a defenceless state, in order to avenge the wrong inflicted by the latter on Dinah. Jacob, even on his deathbed, could not forgive this, their bloody 'anger and self-will,' and pronounced this curse on them both, that they should be scattered among Israel (Gen. xlix. 7). How this was fulfilled in the case of Levi, whose descendants, singled out for the service of the sanctuary and the general instruction of the people, had to reside in cities set aside for them throughout the length and the breadth of the land, will be more fully shewn under LEVITES. In Egypt, the House of Levi had divided itself into three families, those of Gerahom, Kehath, and Merari.

LEVYATHAN, a scriptural term for a great 'sea-monster,' but more especially a Crocodile (q. v.). In the Prophets and Psalms, it is occasionally used as a symbol of Egypt and Pharaoh. Many wondrous allegorical tales are connected with this word in the Talmud and Midrash.

LEVITA, ELIJAH (*Halevi, Ben Asher; Ashkenasi* = the German, *Habachur* = the Master, *Hamedak-det* = the Grammarian), a Jewish grammarian and exegete, who, though much overrated, still holds a high rank among Hebrew scholars, was born at Neustadt on the Aisch, near Nuremberg, in 1470. One of the then frequent expulsions of the Jews forced him to seek refuge in Italy, where he held a high position as teacher of Hebrew, first in Venice,

next in Padua, finally in Rome (1514). Cardinal Egidio here became his patron and pupil, but even he could not prevent L.'s again being expelled this city, together with his Jewish brethren, in 1527. He then returned to Venice, where he lived for the most part until his death, 1549. His principal exegetical and biblical works are a *Commentary on Job in verse*, a *German Translation of the Psalms*, an *Edition of the Psalms with Kimchi's Commentary*, an *Edition of the Targum to Proverbs*, and of *Kimchi's Commentary to Amos*. His grammatical works are chiefly: *Masoreth Hammesoreth* (Tradition of Traditions), a treatise on the vowel-points, &c., in the Old Testament; *Tub Taam* (Good Judgment), a treatise on Accents; *Sefer Habachur* or *Dibbuk* (Grammar), besides many minor treatises. In the field of lexicography, he has contributed *Meturgeman* (= Dragoman), an attempt at a Talmudical and Targumical Dictionary; *Tishbi*, a complement to Hebrew dictionaries; *Shemoth Debarim* (The Names of Things), a Hebrew-German dictionary; *Nimukim*, glosses to David Kimchi's *Book of Hebrew Roots*, &c. Most of L.'s works have been repeatedly edited and partly translated by Buxtorf, M nster, Fagius, and others, who owed most of their Hebrew knowledge to L. exclusively: a fact not generally recognised.

LEVITES, the descendants of Levi (q. v.), who were singled out for the service of the sanctuary. The term is more particularly employed in contradistinction to Priests (q. v.), in designating all those members of the tribe who were not of the family of Aaron. It was their office—for which no further ordination was required in the case of the individual—to erect, to remove, and to carry the tabernacle and its utensils during the sojourn of the Israelites in the wilderness. When the sanctuary had found a fixed abode, they acted as its servants and guardians, and had to assist the priests in their holy functions in the sanctuary and in their medical capacity among the people. The vocal and instrumental music in the temple was likewise under their care, as were also the general instruction of the people, certain judicial and administrative functions, the keeping of the genealogical lists, and the propagation of the Book of the Law among the community. In order to enable them better to fulfil these functions, no special part of the land was allotted to them, but they were scattered—in accordance with Jacob's last words (Gen. xlix. 7)—in Israel; forty-eight Levitical cities, among which there were also certain 'cities of refuge,' being set aside for them on both sides of the Jordan; without, however, preventing their settling wherever else they pleased. Their revenues consisted of the annual Tithe (q. v.), and of a share in the second tithe, due every third year, and in the sacrificial repasts. The length of their service varied at different times. No special dress was prescribed for them until the time of Agrippa.

While in the desert not more than 8580 serviceable men strong, they had, under David, reached the number of 38,000 men fit for the service, 24,000 of whom this king selected, and divided them into four classes—sacerdotal assistants, doorkeepers, singers and musicians, and judges and officers. A very small number only returned from the exile, and all the Mosaic ordinances with respect to their cities, tithes, share in sacrificial repasts, &c., were virtually abrogated during the second temple. Nothing but the service in the temple, in which they were assisted by certain menials called *Nethinim*, was left to them. It may be presumed that they earned their livelihood partly like the rest of the community, partly as teachers, scribes, and

the like. Their travelling-garb consisted, according to the Talmud (Jebam., 122 a), of a staff, a pouch, and a Book of the Law. Foreign rulers also granted them exemption from taxes. This is the only tribe which is supposed to have kept up its pure lineage to this day, and certain, albeit small, signs of distinction are still bestowed upon its members, more especially in the case of the presumed descendants of Aaron (the *Kohanim*). But the purity of lineage is more than questionable in many instances.—L. is also the name given to certain sacerdotal assistants in the Romish Church.

LEVITICUS (Heb. *Vajikra*) is the name of the third book of the Pentateuch, containing chiefly the laws and ordinances relating to the Levites and priests. Little or no progress is made in it with respect to the history of the people, and the few events recorded are closely connected with the special aim and purport of the book. The erection of the sanctuary having been described at the end of Exodus, the nature of the worship—revealed by God within this tabernacle—is set forth in Leviticus, which forms its continuation. The order followed is not strictly systematical, but a certain plan is apparent, in its outlines at least.

The age and authorship of Leviticus will be considered, together with that of the other 'Mosaic' records, under PENTATEUCH. We shall confine ourselves to mentioning, in this place, that the whole of the supposed 'original' or Elohistic document (see GENESIS) is by modern critics held to be embodied, in its primitive shape, as nearly as possible at least, in the 'Leviticus' as we have it now. Among the few additions and alterations ascribed to the Jehovist, are reckoned chapters x. 16—20, xx. 20—25, xxv. 18—22, and the greater part of chap. xxvi. (3—35), the second verse of which (end of *Parashah xxxii.*) is held to have concluded the Sinaitic legislation in the original document.

LEVY (Fr. *levée*), is the compulsory raising of a body of troops from any specified class in the community for purposes of general defence or offence. When a country is in danger of instant invasion, a *levée en masse* is sometimes made—i. e., every man capable of bearing arms is required to contribute in person towards the common defence. On less urgent occasions, the levy may be restricted to a class, as to men between eighteen and forty years of age. At other times, a levy of so many thousand men of a certain age is decreed, and the districts concerned draw them by lot from among their eligible male population. In armies sustained by volunteering, the levy, which is a remnant of barbarous times, is unnecessary; but the system was frequently resorted to in France before the enactment of the conscription laws: 1862 has shewn great levies in the United States of America; and in any country where great danger is apparent, and volunteers are not sufficiently numerous, recourse must at all times be had to a levy of the people.

LEWES, the county-town of Sussex, market-town, and parliamentary borough of England, most picturesquely situated on the navigable river Ouse, 50 miles south from London, and 7 from Newhaven, which is its port. L. has a population of 10,116, and is the seat of the assizes. It returns two members to parliament, and is the seat of election for East Sussex. Fairs are held here on Whit-Tuesday and 6th May for horses; on the 20th July, for wool; and on 21st and 28th September, for South-down sheep, of which from 40,000 to 50,000 are often collected. The chief trade is in grain, sheep, and cattle. There are three iron foundries; and ship-building, brewing, tanning, rope-making, and lime-burning, employ many of the inhabitants.

Races are held here annually in July or August, near Mount Harry, on the Downs, where the celebrated battle of Lewes was fought, between Henry III. and the insurgent barons of the kingdom, on the 14th May 1264. The castle, the principal tower of which now forms the museum of the Sussex Archaeological Society, was long the seat of William de Warrenne, whose remains and those of his wife, Gundrada, daughter of the Conqueror, were discovered here. L. is of very remote origin, and was the site of a Roman station or camp. Three papers are here published, and the town is governed by two high-constables.

LEWES, GEORGE HENRY, a versatile English author of the present day, was born in London, April 18, 1819, educated at various schools, studied medicine for some time, and finally resolved to devote himself to authorship. In his twenty-first year, he proceeded to Germany, where he remained for two years, studying the life, language, and literature of that country. On his return to England, he took up his residence in London, and has ever since been one of the most industrious as well as successful of *littérateurs*. An intellect clear and sharp, if not remarkably strong; a wit lively and piquant, if not very rich; sympathies warm, if not wide; and a style as firm as it is graceful, have made L. one of the best of critics and biographers. He has contributed to most of the quarterlies and magazines of the day; edited (with admirable talent) the *Leader* newspaper from 1849 to 1854; composed novels, comedies, and tragedies; and, of late years, has turned his active mind to the study of physiology and cognate branches of science, in which he has won as high a reputation as in the lighter departments of literature. His principal works are his *Biographical History of Philosophy* (1845, a new edition of which, much enlarged, has since been published); *The Spanish Drama, Lope de Vega and Calderon* (1846); *Comte's Philosophy of the Sciences* (forming one of the volumes in Bohn's *Scientific Library*, 1853), a work which is not a mere translation of the French savant, but in several parts a complete remodelling, by which the style at least does not suffer; *Life and Works of Goethe, &c.* (1855), probably his most valuable performance, and indisputably the best work on the subject; *Seaside Studies at Ilfracombe* (1858); and *Physiology of Common Life* (1860). He is understood to be engaged at present (1863) on an edition of the works of Spinoza.

LEWIS, or SNAKE RIVER, the great southern branch of Columbia River, United States of America, rises in the Rocky Mountains, on the western borders of Nebraska Territory, and after a circuitous course, the general direction is north-west, through Oregon Territory, it joins the Columbia, near Fort Walla-Walla, lat. 46° 6' N., long. 118° 40' W. Length, 900 miles.

LEWIS, RIGHT HON. SIR GEORGE CORNEWALL, BART., English statesman and author, was born in London 1806. He was eldest son of Sir Thomas Frankland Lewis, first baronet, of Harpton Court, Radnorshire, who, after a long official career, was chairman of the Poor-law Board from 1834 to 1839. L. was educated at Eton and Christ-church, Oxford, where, in 1828, he was first-class in classics, and second-class in mathematics. He was called to the bar of the Middle Temple in 1831, and after acting on various commissions of inquiry, succeeded his father as Poor-law Commissioner in 1839, and remained at the Poor-law Board until it was broken up and reconstituted in 1847. He had meanwhile married Lady Maria Theresa, sister to the fourth Earl of Clarendon, and a connection by marriage of Earl Russell.

Having determined to adopt a political career, and being thus incorporated into the number of Whig official families, his promotion was certain and rapid. He sat for Herefordshire from 1847 to 1852, and became successively Secretary to the Indian Board of Control, Under-secretary for the Home Department, and Financial Secretary to the Treasury. In 1852, he lost his seat in the House of Commons, and subsequently accepted the editorship of the *Edinburgh Review*, which he continued to conduct until 1855, when he was elected for the Radnor district of boroughs. He had scarcely taken his seat when Lord Palmerston offered him the Chancellorship of the Exchequer in his first administration, which he held from March 1855 to the dissolution of the government in February 1858. On the return of Lord Palmerston to power, in June 1859, L. accepted the post of Secretary of State for the Home Department, which, to the surprise of the nation, he exchanged, in 1861, on the death of Lord Herbert, for the office of Secretary of State for War. In the same year, he published a work of much research, entitled the *Astronomy of the Ancients*. This unremitting labour weakened his frame, and a cold caught while he was enjoying the Easter holidays at his family seat, was followed by congestion of the lungs, which proved fatal, April 13, 1863. L. was an able, earnest, and sincere politician. As an orator, he could scarcely be said to express himself with eloquence or vivacity; yet his sound sense, varied knowledge, and moral and intellectual qualities, made him one of the chief ornaments of public and political life in England. His *Inquiry into the Credibility of Early Roman History*, is conducted on the critical principles of Niebühr, but is more rigorous and sceptical in spirit than the work of the great German historian. The treasures of varied knowledge and wisdom which he had collected during his comparatively short life, may be gathered from a list of his works, which include a treatise on the *Origin and Formation of the Romance Language*, *The Fables of Bæbius*, *The Use and Abuse of Political Terms*, *The Influence of Authority in Matters of Opinion*, *The Method of Observation and Reasoning in Politics*, *Local Disturbances and the Irish Church Question*, *The Government of Dependencies*, *A Glossary of Provincial Words used in Herefordshire*, and the *Astronomy of the Ancients*. His latest work was a *Dialogue on the Best Form of Government*, which was published a few days before his death.

LEWIS-WITH-HARRIS (the name Lewis is derived from the Norwegian *Ljóðhus*, the sounding house), an island of Scotland, one of the Outer Hebrides, the most northern and the largest of the group, lies about 30 miles north-west from Ross-shire, from which it is separated by the Minch (q.v.). Lewis, the larger and most northerly part of the island, belongs to Ross-shire; the other portion, Harris, belongs to Inverness-shire. Entire length, 60 miles; greatest breadth, 30 miles. Area, 770 square miles; pop. (1861) 23,666. The coasts are wild and rugged; the chief indentations being Broad Bay, Lochs Ericart, Seaforth, Resort, and Roag. The Butt of Lewis, a promontory at the extreme north, in lat. 58° 31' N., long. 6° 15' 30" W., rises 142 feet above sea-level. The surface is rugged, with tracts of swamp, a considerable portion is covered with peat, and there are remains of ancient forests. Barley and potatoes are the principal crops raised. Remains of ancient edifices abound on the island. The inhabitants are almost all of Celtic extraction, with the exception of a colony in the north, who, although they speak the Gaelic language, are of purely Scandinavian descent. Stornoway, on the east coast, is the principal town. Near it is Storno-

way Castle, the seat of Sir James Matheson, Bart., who, as proprietor of Lewis, has expended large sums in various kinds of improvements. Stornoway is visited by steamers from Glasgow. See **HEBRIDES**.

LEWISIA, a genus of plants, of the natural order *Portulacaceæ* (see **PURSLANE**), named in honour of the American traveller Lewis. *L. rediviva* is found in the regions of his explorations, on the west side of the Rocky Mountains. Its roots are gathered in great quantities by the Indians, and are highly valued as nutritive, and also as restorative, a very small quantity being deemed sufficient to sustain a man throughout a long journey and much fatigue. It is called *Tobacco Root* because, when cooked, it has a tobacco-like smell.

LEWISTOWN, a town of Maine, United States of America, on the Androscoggin River, 33 miles north of Portland. The river has here a fall of 50 feet in 200, and the water-power is distributed by a dam and canal to 7 manufacturing companies, and several large saw-mills, &c. There are 8 churches, 4 newspapers, and a Baptist seminary. Pop. 7000.

LEX FO'RI, a legal expression often used to denote the law of the country where a suitor brings his action or suit. See **INTERNATIONAL LAW**.

LEX LO'CI, a legal expression to denote the law of the country where a particular act was done, or where land is situated. See **INTERNATIONAL LAW**.

LEX NON SCRIPTA, the unwritten law, an expression often applied to the common law, or immemorial custom.

LEX TALIO'NIS, the law of retaliation, common among all barbarous nations, by which an eye for an eye, and a tooth for a tooth, was considered the appropriate punishment. The doctrine is repudiated by all civilized countries.

LEXICON. See **DICTIONARY**.

LEXINGTON, a small village of Massachusetts, United States of America, 10 miles north-west of Boston, celebrated as the scene of the first conflict between the colonists and British troops in the War of Independence, April 18, 1775. Pop. 2000.

LEXINGTON, a city of Kentucky, United States of America, on the Town Fork of the Elkhorn, a tributary of Kentucky River, 77 miles east of Louisville. It is a handsome city, surrounded by a country of great beauty and fertility. Its principal edifices are a Court-house, Transylvania University, State Lunatic Asylum, City Hospital, Orphan Asylum, banks, 12 churches. There are 2 newspapers, 80 manufacturing establishments, mostly of hemp and tobacco. The town was being laid out when news arrived of the skirmish at Lexington, 1775, when the name was adopted. It has a beautiful cemetery, with a handsome monument to Henry Clay. Pop. (1860) 9321.

LEXINGTON, a town of Missouri, United States of America, on the right bank of the Missouri River, 350 miles above St Louis. It has 7 churches, 2 newspapers, a branch of the Bank of Missouri. It has been the scene of repeated conflicts during the present War of Secession. Pop. (1860) 4115.

LEYDEN (Fr. *Leyde*, the *Lugdunum Batavorum* of the Romans, originally *Lwijkduin*, from *luijk*, an end, and *dun*, a hill; during the middle ages, *Lugdun* or *Leydis*), a celebrated seat of learning in Holland, situated on the Old Rhine, 22 miles south-west of Amsterdam, and 17 north of Rotterdam. Pop. 37,339. It is said to be the oldest town in Holland, and has space for three times its present population. In 1640, L. contained 100,000 souls; in 1750, the numbers had fallen to 70,000; and at the

beginning of the present century, to 30,000. Since 1830, trade has again begun to flourish, and the population to increase. The streets are wide, the public buildings beautiful, and the canals broad and numerous. Within the city are the ruins of an old castle, called the 'Burg,' supposed to have been built by the Romans before the birth of Christ. The principal manufactures are linen cloths, calicoes, woollens, but on a very small scale, as compared with former times. There is a considerable weekly market, for the whole of that part of Holland called Rhineland, held at L., at which much butter and cheese change hands. But the chief ornament and glory of the city is its university—once unsurpassed by any in Europe. The origin of the university is well known. In 1574, when Holland was struggling to throw off the yoke of Spain, L. was besieged by the Spaniards, and had to endure all the horrors of famine. For seven weeks the citizens had no bread to eat, and multitudes perished of hunger. The heroic burgomaster, Pieter Adriaanszoon Van der Werff, even offered his body as food to some who were imploring him to capitulate. At last, the Prince of Orange broke down the dykes, flooded the country, drowned a great number of the Spaniards, and relieved the inhabitants. The Prince of Orange now offered, as some compensation for their unparalleled sufferings, either to remit certain taxes or to establish a university in the city. The Leydeners nobly chose the latter, which was inaugurated by Prince William in 1575. Many eminent men, from all countries of Europe, have been connected with it, both as professors and students. We may mention Scaliger, Gomarus, Arminius, Grotius, Descartes, Boerhaave, Camper, Spanheim, Rhunken. At present, it has 27 ordinary professors and 1 extraordinary. In 1862, the students were 487—being, law, 259; theology, 100; medicine, 82; other classes, 46. It also possesses a valuable library, with many rare MSS.; a magnificent collection in medicine; a botanical garden, valuable for its tropical plants; a museum of natural history, one of the richest in Europe; and another equally fine of comparative anatomy. The Museum of Antiquities is also excellent. On the 12th January 1807, the most beautiful quarter of the city was destroyed, and many lives lost, by the explosion of a ship's cargo of gunpowder, and the site of the ruined streets is now a plain on which the troops are exercised.

LEYDEN, LUCAS VAN, one of the most celebrated painters of the early Dutch school, was born in Leyden in 1494. His talents, which were developed when he was very young, were first cultivated by his father, Hugo Jacobs, an obscure painter; but he was afterwards placed in the school of Cornelius Engelbrechtsten, an artist of repute in his day. He commenced engraving when scarcely nine years of age. His picture of St Hubert, painted when he was only twelve, brought him very high commendation; and the celebrated print, so well known to collectors by the name of 'Mahomet and the Monk Sergius,' was published in 1508, when he was only fourteen. He practised successfully almost every branch of painting, was one of the ablest of those early painters who engraved their own works, and he succeeded, like Albert Dürer, in imparting certain qualities of delicacy and finish to his engravings that no mere engraver ever attained. The pictures of Lucas van L. are noted for clearness and delicacy in colour, variety of character and expression; but his drawing is hard and Gothic in form. Examples are to be seen in many of the galleries on the continent. His range of subjects was very wide, and embraced events in sacred history, incidents illustrative of the manners of his own period, and portraits. His engravings

are very highly prized by collectors, and are ranked about as highly as those of Albert Dürer. He also executed some wood-cuts, which are very rare. Bartsch gives a list of 174 engravings by him. His habits were expensive. He seems to have occasionally entertained his brother-artists in a sumptuous manner; was on terms of intimacy with the celebrated painter, Jean de Mabuse, who is alleged to have been rather too fond of good living; and held friendly intercourse with Albert Dürer, whose talents he admired without professional jealousy. He married in early life a lady of the noble family of Boahagen, by whom he had one daughter. He died in 1533, aged 39. He had been confined to bed six years before his death, but contrived to paint and engrave till within a short period of his decease.

LEYDEN JAR. See ELECTRICITY.

LE'ZE MAJESTY, an offence against sovereign power—*læsa majestas*.

LIABILITY (LIMITED) ACTS. See JOINT-STOCK COMPANIES.

LIA'NAS, a term first used in the French colonies, but afterwards adopted by English, German, and other travellers, to designate the woody, climbing, and twining plants which abound in tropical forests, and constitute a remarkable and ever-varying feature of the scene. Such plants are comparatively rare in colder climates, although the honeysuckles and some species of *Clematis* afford



Lianas.

familiar examples of them; but as these often overtop the hedges or bushes in which they grow, and fall down again by the weight of their leaves as their stems elongate, so the L. of tropical countries overtop the tallest trees, descend again to the ground in vast festoons, pass from one tree to another, and bind the whole forest together in a maze of living network, and often by cables as thick as those of a man-of-war. Many parts of the forest—as in the alluvial regions of the Amazon and Orinoco—thus become impenetrable without the aid of the hatchet, and the beasts which inhabit them either pass through narrow covered paths, kept open by continual use, or from bough to bough far above the ground. Many L.—as some of the species of *Wrightia*—become tree-like in the thickness

of their stems, and often kill by constriction the trees which originally supported them; and when these have decayed, the convolutions of the L. exhibit a wonderful mass of confusion magnificent in the luxuriance of foliage and flowers. No tropical flowers excel in splendour those of some lianas. Among them are found also some valuable medicinal plants, as sarsaparilla. The rattans and vanilla are lianas. Botanically considered, L. belong to natural orders the most different. Tropical plants of this description are seldom to be seen in our hothouses, owing to the difficulty of their cultivation.

LIAS. The lias is the lower division of the Oolitic or Jurassic Period (q. v.). The beds composing it may be considered as the argillaceous basis of that series of rocks, consisting of more than a thousand feet of alternations of clay and limestone, with but a few unimportant deposits of sand. It consists of the following groups:

UPPER LIAS	{ Cephalopoda bed. Lias sands.	
	Upper shale,	300 feet.
MARLSTONE,		900 "
LOWER LIAS	{ Lower shale. Bone bed,	600 "

The Upper Lias consists of thin limestone beds scattered through a great thickness of blue clay, more or less indurated, and so aluminous that it has been wrought for alum at Whitby. A thick band of vegetable matter or impure lignite occurs in this division, in which are found nodules and lumps of jet, a peculiar mineral composed of carbon and hydrogen, and probably having a similar origin to the amber of the tertiary lignites. A series of brown and yellow sands, and a peculiar layer called the cephalopoda bed, from the abundance of these fossils contained in it, occur above these clays; recently, they have been separated from the inferior colite, and joined to this division, on the evidence of the contained fossils.

The Marlstone is an arenaceous deposit, bound together either by a calcareous or ferruginous cement, in the one case passing into a coarse shelly limestone, and in the other into an ironstone, which has been extensively wrought both in the north and south of England.

The Lower Lias beds consist of an extensive thickness of blue clays, intermingled with layers of argillaceous limestone. In weathering, the thin beds of blue or gray limestone become light brown; while the inter-stratified shales retain their dark colour, giving the quarries of this rock, at a distance, a striped or ribbon-like appearance, whence, it is supposed, the miner's name lias or layers is derived. Generally, the clays rest on triassic rocks, but occasionally there is interposed a thin bed of limestone, containing fragments of the bones and teeth of reptiles and fish, generally of undoubted liassic age; occasionally, the bones of keuper reptiles are met with in it, causing it to have been referred to the Trias.

The Lias is highly fossiliferous, the contained organisms being well preserved; the fishes are often so perfect as to exhibit the complete form of the animal, with the fins and scales in their natural position. Numerous remains of plants occur in the lignite and in the shales. The name Gryphite Limestone has been given to the Lias, from the great quantities of *Gryphea incurvata*, a kind of oyster, found in it. Some of the older genera of mollusca are still found in these beds, but the general character of these animals more nearly approaches the newer secondary forms. Fish-remains are frequently met with; the reptiles, however, are the most striking features. They are remarkable for the great numbers in which they

occur, for the size which many of the species attain, and for the adaptations in their structure which fitted them to live in water. The most noteworthy are species of *Ichthyosaurus* (q. v.) and *Plesiosaurus* (q. v.)

The Liassic rocks extend in a belt of varying breadth across England, from Whitby, on the coast of Yorkshire, south to Leicester, then south-east by Gloucester to Lyme Regis in Dorsetshire.

LIBANIUS, one of the latest and most eminent of the Greek sophists or rhetoricians, was born at Antioch, in Syria, about 314 or 316 A.D. He studied at Athens under various teachers, and first set up a school in Constantinople, where his prelections were so attractive that he emptied the benches of the other teachers of rhetoric, who had him brought before the prefect of the city on a charge of 'magic,' and expelled. He then proceeded to Nicomedia; but after a residence of five years, was forced by intrigues to leave it, and returned to Constantinople. Here, however, his adversaries were in the ascendant; and after several vicissitudes, the old sophist, broken in health and spirit, settled down in his native city of Antioch, where he died about 393 A.D. L. was the instructor of St Chrysostom and St Basil, who always remained his friends, though L. was himself a pagan. He was a great friend of the Emperor Julian, who corresponded with him. His works are numerous, and mostly extant, and consist of orations, declamations, narratives, letters, &c. The most complete edition of the orations and declamations is that by Reiske (4 vols. Altenb. and Leip. 1791—1797), and of the letters that by Wolf (Amst. 1738).

LIBANON. See **LEBANON.**

LIBATION (Lat. *libare*, to pour out), literally, anything poured out before the gods as an act of homage or worship; a drink-offering. The term was often extended in signification, however, to the whole offering of which this formed a part, and in which not only a little wine was poured upon the altar, but a small cake was laid upon it. This custom prevailed even in the houses of the Romans, who at their meals made an offering to the Lares in the fire which burned upon the hearth. The libation was thus a sort of heathen 'grace before meat.'

LIBAU, a seaport of Courland, Russia, on the Baltic, 526 miles south-west of St Petersburg. It existed previous to the settlement here of the Teutonic Knights, who surrounded the town with walls, and erected in 1300 a cathedral and a castle. In 1795, it was annexed to Russia. The port, with a secure harbour 14 feet deep, is open almost the whole year. Its inhabitants, since the 17th c., have devoted themselves to ship-building, and now furnish merchant-vessels to St Petersburg, Riga, and Revel. In 1861, 239 ships entered, and 145 cleared the port. The imports, amounting in value to 1,673,866 rubles, consist of salt herrings, wines, fruit, and colonial produce; the exports (1,739,802 rubles in value) are chiefly cereals, leather, flax, seeds, and timber. Pop. 10,126.

LIBEL, in Scotch Law and in English Ecclesiastical Law, means the summons or similar writ commencing a suit, and containing the plaintiff's allegations.

LIBEL is a publication either in writing, print, or by way of a picture, or the like, the tendency of which is to degrade a man in the opinion of his neighbours, or to make him ridiculous. When similar results follow from words spoken, the act is called Slander (q. v.), which, however, is less severely punished. It is extremely difficult to

define what amounts to libellous matter, for the question whether a publication amounts to libel must always be left to the decision of a jury, and this decision is somewhat uncertain, and varies with the popular mood for the time. But the test is, in point of law, whether there results degradation of character. There are two remedies in England for the wrong caused by libel; one is by indictment, the other is by action. If the offence is of a public nature, an indictment is generally resorted to, for every libel tends to a breach of the peace; or the libelled party applies to the Court of Queen's Bench for a criminal information, which is a variety of indictment. When an action is brought, its object is to recover damages for the private injury sustained. The rule formerly was, in indictments and criminal informations, that the defendant was not allowed to plead in defence that the libellous matter was true. But the law was in 1843 altered, and the defendant is now allowed, by way of defence, to allege the truth of what was charged, and further that it was for the public benefit that the matter should be published, stating how. If, however, the jury by their verdict find otherwise, this defence often aggravates the punishment. The statute 6 and 7 Vict. c. 96 also improved the law of libel as regards editors, and proprietors of newspapers, and periodical publications, who were formerly held liable for libels inserted without their knowledge. By the present law, the defendant may plead in defence that the article in question was inserted without actual malice and without gross negligence, and that, before the commencement of the action, or at the earliest opportunity afterwards, the defendant inserted an apology, or if the periodical did not appear within an interval of a week, that he offered to publish an apology in any newspaper or periodical to be selected by the plaintiff. But the defendant, when he pleads this defence, must also pay into court a sum of money, by way of amends for the injury done. In these cases, even where the proceeding is by indictment or criminal information, the defendant, if he obtains a verdict, will (contrary to the general rule) be entitled to have his costs paid by the prosecutor. There are certain libels which are called blasphemous on account of their denying the fundamental truths of Christianity, and these are punishable by fine and imprisonment. So there are seditious, treasonable, and immoral libels, according to the nature of the subject-matter. If any person threaten to publish a libel, or offer to prevent such publication, with intent to extort any money, security, or valuable thing, or with intent to induce any person to confer or procure any appointment or office of profit or trust, he is liable to imprisonment with or without hard labour for three years. If any person maliciously publish a defamatory libel, knowing the same to be false, he is liable to two years' imprisonment and a fine; and the malicious publication, even though not with knowledge that it is false, makes the author liable to one year's imprisonment and a fine.

LIBELLULA AND LIBELLULIDÆ. See DRAGON-FLY.

LIBER. See BARK and BAST.

LIBERATION, in Scotch Law, means discharge from imprisonment. Formerly, if a person was imprisoned for debt, and paid the amount, he had to present a bill of liberation and suspension to get out of prison, which is not now necessary.

LIBERIA, a negro republic on the Grain Coast of Upper Guinea. The territory of the republic extends from long. 5° 54' to 12° 22' W. The length of coast is about 500 miles, the average breadth of

the territory about 50 miles. On December 31, 1816, an association, of which Henry Clay (q. v.) was president, styled the American Colonisation Society, was formed, for the purpose of founding a colony of emancipated negroes, and of giving them favourable opportunities of self-improvement. The first attempt failed, in consequence of the selection of an unhealthy locality; but in December 1821, a treaty was concluded with the native princes, by which a tract of land fit for the purpose was acquired. The association immediately commenced operations, and allotted to each man 30 acres of land, with the means of cultivating it. A town, called Monrovia, was founded at Cape Mesurado; the boundaries of the colony were enlarged by the purchase of new tracts; and a second town, called Caldwell, in honour of the originator of the association, was founded upon the river Mesurado. New settlements were afterwards formed at Cape Monte and in the newly acquired Bassa Land, in which, in 1834, a town was founded, and called Edina, in acknowledgment of pecuniary aid sent to the colony from Edinburgh. Many of the neighbouring chiefs were received into the colony, whilst others were subdued. In 1847, L. was left to its own resources, declared an independent republic, and the government committed to a president, senate, and house of representatives. The president and representatives are elected for two, and the senators for four years, all citizens being qualified electors when they reach 21 years of age, and possess *real estate*. The judicial power is vested in one supreme and several subordinate courts. Slavery and the slave-trade are prohibited, and the right of petition established. Whites are excluded from rights of citizenship, but this is only a temporary measure. The prosperity of the colony soon became very obvious; churches and schools were founded in greater proportion to the population than in most parts of Britain or America; a regular postal system was established, newspapers published, and slavery in the neighbouring states abolished. Negroes from the neighbouring regions, settling in the republic and submitting to its laws, were admitted to participation in civil and political freedom equally with the colonists. The new republic was recognised by Britain in 1848, and since by other European powers. The British government made it a present of a corvette of war with four guns. The prosperity and usefulness of L. have since continued to increase, but the number of settlers from North America has never been great in any year, and up to 1856, the whole number in the country was reckoned not to exceed 10,000. Additional negro tribes are, however, from time to time included within its territory. In 1850, the native inhabitants of L. were estimated at 300,000; and about 50,000 had acquired the English language, of whom about 3000 were members of the Christian church. Agriculture is carried on, but, as yet, without much success. Coffee is a principal article of produce. Cocoa, cotton, the sugar-cane (1856), arrow-root, and rice are also cultivated. Trade is rapidly extending, and palm-oil, ivory, gold-dust, camwood, wax, coffee, indigo, ginger, arrow-root, and hides, are amongst the principal articles of export. In 1860, a cargo of sugar was sent to New York, and this is the only manufacture yet prosecuted. Consult Bowen's *Central Africa* (New York, 1857), and Thomas's *West Coast of Africa* (New York, 1860).

LIBERIUS, a native of Rome, born in the early part of the 4th c., succeeded to the see of Rome in 352, on the death of Pope Julius I. His pontificate falls upon the stormiest period of the semi-Arian controversy. See **ARUS**. The Emperor

Constantinus supported the semi-Arian party with all his authority; and the council of Arles in 353, and that of Milan in 355, formally condemned Athanasius (q. v.), the great representative of the orthodox belief. L. refused to confirm this decree, and, even in opposition to the personal commands of Constantinus, withheld his subscription. He was, in consequence, in common with several others, deposed and banished to Beroea by the emperor, who caused a Roman deacon, Felix, to be elected in his stead. The later history of L. is a subject of controversy. He was restored to his see in 358, but the terms on which he was recalled are much disputed. He survived his return from exile eight years, and died in high repute for sanctity at Rome in 366. His only remains are some letters preserved by Constant in the *Epistolæ Romanorum Pontificum*. During his life, many spurious letters and decrees were circulated in his name.

LIBERTY, in English Law, is often used to denote a franchise, or portion of the royal prerogative delegated to a subject; also a privileged district in a county exempt from the sheriff's jurisdiction.

LIBERTY, EQUALITY, FRATERNITY. For nearly a century, these three words have been accepted as embodying the creed of those who maintain the rightful supremacy of the numerical majority; and they have been sounded as the watchword of that formidable movement known on the continent of Europe as 'the Revolution,' of which the object is to assert this supremacy by overturning the existing fabric of society. When contrasted with the democratic creed of antiquity, the only novelty which the modern symbol exhibits consists in the proclamation of 'equality;' for 'liberty,' in the widest sense—meaning thereby the ultimate extension of political power to the whole body of the citizens—has been the object of the most enlightened politicians of all ages; whilst the protest in favour of 'fraternity' is a mere sentimental commonplace, about the speculative soundness of which there never was any real difference of opinion.

The first state document of importance in which the doctrine of equality is set forth is the American Declaration of Independence of July 4, 1776. This celebrated document proceeds thus: 'We hold these truths to be self-evident: that all men are created equal; that they are endowed by their Creator with certain unalienable rights; that among these are life, liberty, and the pursuit of happiness, &c.' This, as we have said, was in 1776. But as a speculative opinion, the doctrine of equality had been proclaimed by Hobbes more than a century before, and from his time down to the period at which it thus received practical recognition, it had never been lost sight of by the class of speculators to which Hobbes belonged. Under different forms, and from various points of view, it had been reasserted by Spinoza, Rousseau, Helvetius, and ultimately by the class of political declaimers whose works were simultaneous with the American, and immediately preceded the French Revolution.

Hobbes was bolder than his followers, and by assuming a premise which, had it been true, would certainly have justified his conclusion, saved his logic, though he did not secure a very stable foundation for his law. He asserted that men are not only born, but continue in essentials very nearly equal. 'Nature,' he said, 'has made little odds among men of mature age as to strength and knowledge. Rousseau, on the other hand, feeling that subjective and objective experience would at once repudiate such an assumption, admitted the existence of inequalities in maturity, and scarcely ventured to

deny them even at birth, but ascribed them mainly to education, and to other distorting and deranging principles in human nature and human society, which it is the object of law and government to counteract. A third class of reasoners, whilst admitting the fact of inequality, and not condemning it as abnormal in the case of individuals, asserted that the argument in support of social and political equality is sufficiently founded on the generic equality of mankind—on the proposition, viz, that *all men are equally men*. They forgot, or found it convenient to ignore, that the argument of their opponents rested on the proposition, that *all men are not equal men*; and consequently would not have been in the slightest degree affected even by the admission of the generic equality for which they contended. To this last class belongs Professor Ahrens, whose work on Natural Law is at present used as the text-book in the *École de Droit* in Paris. But all these writers agree in maintaining the inalienable connection between equality and liberty; and in asserting that the realisation of the latter must of necessity be in proportion to the completeness with which the former is realised. In Great Britain, hitherto, the opposite creed has prevailed. Experience, both subjective and objective, has led to the conclusion that in point of fact men come into the world and continue during the whole course of their earthly sojourn to be extremely unequal in strength, intelligence, virtue, and worth. It is on this assumption that the whole fabric of our liberties rests. So far from believing liberty to involve the fictitious recognition of an equality which does not exist, or the creation of an equality which is contrary to nature, we hold it to necessitate the recognition of the inequalities which nature has established, and which God as the author of nature has decreed. Nay, further, we conceive its perfection to be in direct proportion to the completeness with which these inequalities are recognised, and their consequences, in the shape of property, social position, and the like, are vindicated by the political machinery of the state. Society, in our view of the matter, is an organic structure, is cosmic, just in so far as it recognises these inequalities; and begins to be inorganic, chaotic, the moment that it ignores them. In like manner, the political, which is the mirror of the social organisation of the state, performs its appropriate function only when, and in so far as it truly reflects the inequalities which society has recognised and sanctioned. It must neither add to nor take from the facts which society presents to it. To each it must assign his own, and nothing but his own; and his *own* politically is the place which society has already conceded to him. These views, which in a somewhat irregular manner have always been recognised and acted upon in England, have been thought out and systematised within these last few years by Mr Mill and the class of politicians to whom in future the title of Progressive Conservatives will probably be applied. By no writer, perhaps, has the true doctrine been stated with greater force than by John Adams, the friend and successor of Washington, and second president of the United States. The following passage is selected from many to the like effect in the recent edition of his works by his grandson, Charles Francis Adams: 'That all men are born to equal rights, is true. Every being has a right to his own as clear, as moral, as sacred, as any other being has. This is as indubitable as a moral government in the universe. But to teach that all men are born with equal powers and faculties, to equal influence in society, to equal property and advantages through life, is as gross a fraud, as glaring an imposition on the credulity of the people, as ever

was practised by monks, by Druids, by Brahmans, by priests of the immortal Lama, or by the self-styled philosophers of the French Revolution. For honour's sake, Mr Taylor, for truth and virtue's sake, let American philosophers and politicians despise it.—(Vol. vi. p. 454.)

LIBERTY OF THE PRESS. See **PRESS, LIBERTY OF; LIBEL.**

LIBERTY OF THE SUBJECT is a general phrase descriptive of the right of the individual subject to do all things not specially prohibited by the law, and the less restriction there is by the law, the greater is the extent of the liberty enjoyed. In its widest sense, the phrase may be understood as comprising the whole of the rights allowed by law to the subject; but what is generally understood is the liberty of the person, or of rights connected with the person—such as personal liberty or freedom from slavery, the right of free speech, liberty of conscience, liberty of the press, and constitutional liberty, or the liberty to influence and take part in legislation, which may be further subdivided into the limitation of the royal prerogative, the powers and privileges of parliament, the right of applying to courts of law for redress of injuries, the right of petitioning the crown or parliament, the right of having arms for defence, the right of habeas corpus, &c. All these subjects are noticed in detail under their proper heads.

LIBIDIBI. See **DIVIDIVI.**

LIBOURNE, a handsome town of France, in the department of Gironde, on the right bank of the Dordogne, at its confluence with the Isle, 20 miles north-east of Bordeaux. It is one of the ancient *Bastides* or Free Towns, and was founded by Edward I., king of England, in 1296. It carries on considerable trade in wines, spirits, grain, salt, and timber. Cotton-yarn, iron, leather, ropes, and nails are manufactured. Pop. 13,290.

LI'BRA, the seventh sign in the zodiac. At the first point of Libra, the ecliptic passes across the equator to the southern hemisphere, this point being thus the *autumnal equinox*.

LIBRARIES. The term library is applied indifferently to buildings, &c., destined to contain books, and to the books themselves deposited in these buildings. In the present article, it is used chiefly, if not exclusively, in the latter sense.

Passing over the 'libraries of clay,' as the collections of inscribed bricks and tiles of the Assyrians and Babylonians have been aptly designated, the first library, properly so called, of which we have any knowledge, is that which, according to Diodorus Siculus, was formed by the Egyptian king Osymandyas. The existence of this establishment, with its appropriate inscription, *Psyche's iatreion*—the storehouse of medicine for the mind—was long regarded as fabulous; but the researches of Champollion, Wilkinson, and other modern investigators, go far to prove that the account of Diodorus, though perhaps exaggerated, is at least based upon truth. A more celebrated Egyptian library was that founded at Alexandria by Ptolemy Soter, for an account of which see **ALEXANDRIAN LIBRARY.** The library of Pergamus, a formidable rival to that of Alexandria, was founded probably by Attalus I., and was largely increased by the fostering care of his successors. As stated in the article just referred to, it was ultimately removed to Alexandria, being sent by Antony as a gift to Cleopatra. At the time that this transference took place, it contained, according to Plutarch, 200,000 volumes.

The first public library established at Athens is said to have been founded by Pisistratus; but the

information we possess regarding this and other Grecian libraries is meagre and unsatisfactory. The earliest Roman libraries were those collected by Lucullus and by Asinius Pollio. The latter was a public library, in the fullest sense; and the former, though private property, was administered with so much liberality as to place it nearly on the same footing. Various other libraries were founded at Rome by Augustus and his successors; the most important, perhaps, being the Ulpian Library of the Emperor Trajan. The private collections of Emilius Paulus, Sulla, Lucullus (already mentioned), and Cicero, are well known to every student of the classics.

The downfall first of the Western, and subsequently of the Eastern Empire, involved the destruction or dispersion of these ancient libraries. The warlike hordes by whom these once mighty monarchies were overthrown, had neither time nor inclination for the cultivation of letters; but even in the darkest of the dark ages, the lamp of learning continued to shine, if with a feeble, yet still with a steady light. Within the sheltering walls of the monasteries, the books which had escaped destruction, the salvage, if we may so express it, of the general wreck, found a safe asylum; and not only were they carefully preserved, but so multiplied by the industry of the transcriber, as to be placed beyond all risk of loss for the future. Amongst the conventual libraries of the middle ages specially worthy of notice are those of Christ Church, and of the monastery of St Augustine, Canterbury; of the abbey of Fleury and Clugni, in France; of Monte Cassino, in Italy; and of St Gall, in Switzerland. Private collectors, too, existed then as now, though, of course, their number was small. Amongst these, Richard de Bury, Bishop of Durham, holds a distinguished place.

The revival of learning in the 14th and 15th centuries, followed immediately by the invention of the art of printing, led naturally to a vast increase in the production of books, and introduced a new era in the history of public libraries. The number of these establishments which have since sprung into existence is immense, and is constantly increasing; so much so, that a bare list of them would far exceed the limits of an article like the present. All, therefore, that we propose to do is to give a short account of the most important and interesting amongst them.

First among the libraries of Great Britain, and second to few, if to any abroad, is that of the British Museum. For an account of this magnificent collection, see **BRITISH MUSEUM.** Next in rank is the Bodleian Library at Oxford, which has also been already described. See **BODLEYAN** or **BODLEIAN LIBRARY.** The third and fourth places are occupied by the Public, or University, Library of Cambridge, and the Library of the Faculty of Advocates at Edinburgh, which are nearly on a par as regards extent and value. A notice of the latter will be found under the heading **ADVOCATES' LIBRARY**; but the number of volumes which it contains has been slightly understated in the article referred to. At present (1863), they are not fewer than 180,000. The Library of Trinity College, Dublin, with about 130,000 volumes, is the largest and most valuable in Ireland. These five libraries have long been, and still are, entitled by statute to a copy of every book published in the empire; the act of parliament by which the privilege is at present regulated is the 5 and 6 Vict. c. 45. Besides the above, six other libraries had been in the enjoyment of the same privilege up to the year 1836. By the act 6 and 7 Will. IV. c. 110, which was then passed, the number was reduced from eleven to five; compensation

LIBRARIES.

for the loss of the privilege being allowed, in the form of an annual grant of money charged on the Consolidated Fund. The amount of this grant was, in each case, determined by a computation of the average annual value of the books received during the three years immediately preceding the passing of the act. The names of the libraries referred to, with the number of volumes they at present contain, and the annual sum received in lieu of the privilege, are as follows :

Edinburgh University,	100,000	4575
Glasgow	70,000	707
St Andrews	65,000	630
Aberdeen	44,000*	380
Queen's Inn's, Dublin,	35,000	433
Sion College, London,	30,000	353

The minor libraries of Great Britain are so numerous, that a mere list of their names would exceed the limits within which an article like the present must be confined. Amongst those deserving special notice are the Library of the Society of Writers to the Signet, Edinburgh, containing upwards of 45,000 volumes; the Hunterian Library, Glasgow, with about 13,000 volumes, including many choice specimens of early printing; the Chetham Library, Manchester, upwards of 18,000 volumes; Dr Williams's Library, Red Cross Street, London, with more than 20,000 volumes, freely open to the public; the Archbishop's Library at Lambeth, containing at least 25,000 volumes; Marsh's Library, Dublin, the most liberally accessible collection in Ireland, with about 18,000 volumes; and the libraries belonging to the different colleges at Oxford and Cambridge, some of which are of considerable extent and value. The Public Libraries' Acts of 1850 and 1855 have been adopted by several of the large towns in England, Manchester and Liverpool being the most important. The free libraries established in these places under the provisions of the acts just named are in a flourishing condition. Of private libraries in England, it will be sufficient to name that of Earl Spencer, at Althorp, containing upwards of 50,000 volumes, many of extreme rarity and value, and all in admirable condition.

The great national library of France, La Bibliothèque du Roi, as it used to be called, La Bibliothèque Impériale, as it is called at present, is one of the largest and most valuable collections of books and manuscripts in the world. Attempts to form a library had been made by Louis XI and his successors with considerable success; but the appointment of De Thou to the office of chief librarian by Henry IV. may be regarded as the foundation of the establishment as it now exists. The number of printed volumes contained in it is estimated at nearly 900,000, and of manuscripts at about 90,000. Amongst libraries of the second class existing in Paris, the Mazarine Library, and the Library of St. Geneviève, are the chief. The former contains nearly 140,000 volumes; the latter, upwards of 180,000. Many excellent libraries are to be found in the provincial towns of France, particularly at Rouen, Bordeaux, Lyon, and Strasbourg.

Italy is rich in important libraries, amongst that of the Vatican at Rome stands pre-eminent. The number of printed volumes contained in it cannot be stated with accuracy; but it is in the manuscript department—replete with treasures of the rarest and most valuable kind—that its chief strength lies. The Casanata Library, also at Rome, is said to contain upwards of 200,000 volumes. The Ambrosian Library, at Milan, has a collection of nearly 100,000 volumes; and the Brera Library, of

the same city, one of about 130,000. At Florence we find the Laurentian Library, consisting almost entirely of manuscripts; and the Magliabechi Library, with about 160,000 volumes. Amongst the other libraries of Italy worthy of notice are the Royal Library at Naples, with 200,000 volumes, and that of St Mark at Venice, with 120,000.

The principal libraries of Spain are the Biblioteca Real at Madrid, numbering nearly 200,000 volumes, and the Library of the Escorial, which has been already noticed. See ESCORIAL.—Of the libraries of Portugal, no trustworthy statistics can be obtained.

The Imperial Library at Vienna, founded by the Emperor Frederick III., in the year 1440, is a noble collection of not fewer than 400,000 volumes; of which 15,000 are of the class called incunabula, or books printed before the year 1500. The Royal Library at Munich owes its origin to Albert V., Duke of Bavaria, about the middle of the 16th century. The statements which have been made as to the extent of this library are of a very conflicting character, varying from 400,000 volumes on the one hand to 800,000 on the other. The real number is probably about 600,000. It is worthily lodged in the splendid building erected by the late king, Ludwig I., in the Ludwig Strasse. The Royal Library at Dresden is a collection of nearly 320,000 volumes, amongst which are included some of the scarcest specimens of early printing, amongst others the Mains Psalter of 1457, the first book printed with a date. The foundation of the Royal Library at Berlin dates from about the year 1650. It now extends to about 530,000 volumes of printed books, and 10,000 volumes of manuscripts, including amongst the latter many precious relics of Luther and the other leaders of the Reformation. Of the other libraries of Germany, it will perhaps be enough to notice that of the university of Göttingen, with upwards of 350,000 volumes; and the ducal library of Wolfenbüttel, with about 200,000.

In Holland, the principal library is the Royal Library at the Hague, containing rather more than 100,000 volumes, of which about 1500 are good specimens of early printing.

The Royal Library at Copenhagen was founded about the middle of the 16th century. Its contents are now estimated at nearly 450,000 volumes. The University Library possesses nearly 160,000 volumes; and Classen's Library, also in Copenhagen, about 30,000.

In Sweden, the largest library is that of the university of Upsal, consisting of nearly 140,000 volumes. One of its chief treasures is the famous manuscript of the Gothic Gospels of Ulfilas, commonly known as the Codex Argenteus. The university of Lund possesses a collection of upwards of 70,000 volumes.

The library of the university of Christiania in Norway, founded in 1811, contains upwards of 115,000 volumes.

The Imperial Library of St Petersburg was founded about the beginning of the 18th century. In the year 1795, it was largely increased by the addition of the Zaluski Library of Warsaw, which was seized and carried off to St Petersburg by Suwaroff. At present, the total number of volumes cannot be less than about 550,000.

In the United States of America, though there are no libraries equalling those of the first rank in Europe, there are still not a few of considerable magnitude and value. The oldest and one of the largest amongst them is that of Harvard College, Cambridge, Massachusetts, which has been in existence for more than 200 years, and contains nearly 100,000 volumes. Libraries are also attached to the

* About three-fourths of these are lodged in King's College, and the remainder in Marischal College.

other collegiate institutions of the country. The Astor Library, New York, named after its liberal founder, was opened in 1854 with a collection of about 80,000 volumes, which has since been largely increased. It is in the fullest sense a free public library. The Smithsonian Institution at Washington embraces in its plan the formation of an extensive library. As yet, but little progress has been made in carrying out this part of the scheme, which is much to be regretted. The number of volumes already acquired cannot be stated. The proprietary libraries of the United States are numerous, and several of them are of considerable extent; that of Philadelphia, in the foundation of which Franklin was largely concerned, numbers upwards of 60,000 volumes; and that of the Boston Athenæum, founded in 1806, is still larger. It is to be feared that the present state of affairs in America may inflict serious injury on these establishments.

The best work on the subject of libraries is Edwards's *Memoirs of Libraries* (2 vols. London, 1859), which those desirous of further information may consult with advantage.

LIBRARIES' ACTS. Though there is no systematic provision of libraries for public use, at the expense of the state, except the British Museum Library in London, an attempt has been made by the legislature of late years to empower districts to establish libraries, and to tax the inhabitants for that purpose. The first act was passed in 1850 for England, but has been repealed by the act 18 and 19 Vict. c. 70, in 1855. Town councils of towns having a population exceeding 5000, may, after due notice, convene a public meeting of the burgesses, and two-thirds may resolve to establish a library, and rate the inhabitants. So in parishes of a like population, and local improvement districts, two-thirds of the ratepayers may also adopt the act. The rate to be levied in all such cases is not to exceed one penny in the pound. All such libraries are to be open to the public, free of all charge. A similar act, 16 and 17 Vict. c. 101, extended the first English act, 13 and 14 Vict. c. 65, to Ireland and Scotland, but is not so extensive, as it applies only to boroughs in Ireland and Scotland having a population of 10,000.

LIBRARIES, MILITARY, are either garrison or regimental. The former comprise large collections of books, with newspapers, games, lectures, &c., in commodious rooms, and are intended to win soldiers from the gin-shops and vicious haunts which are ever prevalent in garrison towns. Attempts have been made to provide the soldiers with books, both for instruction and amusement; but statistics prove that the men patronise few besides fiction and travels, and religious books not at all. Regimental libraries are smaller collections of books, which accompany regiments in their various movements. The charge for military libraries in the British army is for 1863—1864 the sum of £4213.

LIBRATION (from Lat. *libra*, a balance, meaning a balancing or oscillating motion), a term applied to certain phenomena of the moon's motion. The moon's librations (or, more properly, *apparent* librations) are of three kinds—libration in longitude, in latitude, and the diurnal libration. If the moon's rotation in her orbit were uniform, as her rotation on her axis is, we should always see exactly the same portion of her surface, but as this is not the case, there are two small strips of surface running from pole to pole, on the east and west sides, which become alternately visible; this is called the moon's *longitudinal libration*. The *libration in latitude* arises from the moon's axis not being perpendicular to her orbit, in consequence of which, a portion of

her surface round the north pole is visible during one half, and a corresponding portion round the south pole during the other half of her revolution in her orbit. The *diurnal libration* hardly deserves the name, and is simply a consequence of the observer's position on the surface of the earth, and not at the centre: it consists in the gradual disappearance of certain points on one edge of the moon's disk as she approaches her culmination, and the appearance of new points on her opposite border as she descends. The first and third of these librations were discovered by Galileo, and the second by Hevelius.

LI'BYA, the name given by the oldest geographers to Africa. In Homer and Hesiod, it denoted the whole of this quarter of the globe, except Egypt; in Herodotus, occasionally, the entire continent; but it is also applied by others in a more restricted sense, to the northern part of the country, from Egypt and the Arabian Gulf westward to Mount Atlas. The great sandy tract of which the Sahara forms the principal part, was called the Libyan Desert. To what extent it was known to the ancients is not very clearly ascertained. See **AFRICA**.

LICENCE. See **GAME, PUBLIC-HOUSES, MARRIAGE, ALIEN.**

LICENTIATE (from Lat. *licet*, it is lawful), one of the four ancient university degrees. It is no longer in use in England, except at Cambridge, which confers the degree of licentiate of medicine. In France and Germany, however, where it is more general, a licentiate is a person who, having undergone the prescribed examination, has received permission to deliver lectures. The degree, as an honour, is intermediate between *Bachelor of Arts* and *Doctor*.

LICENTIATE, among Presbyterians, is a person authorised by a presbytery or similar body to preach, and who thus becomes eligible to a pastoral charge.

LICHEN, a papular disease of the skin. There are two species, viz., *L. simplex* and *L. agrius*, the latter of which may be regarded as a very aggravated form of the former. *L. simplex* consists in an eruption of minute papule of a red colour, which never contain a fluid, and are distributed irregularly over the body. They appear first on the face and arms, then extend to the trunk and lower extremities, and are accompanied with a sense of heat, itching, and tingling. In a mild case, the disease is over in a week, but sometimes one crop of papule succeeds another for many weeks or months. In *L. agrius*, the papule are more pointed at the summit, and are of a bright-red colour, with more or less redness extending round them. In this form of the disease, the general health is usually affected, in consequence of loss of sleep and general irritation.

It is often hard to say what is the cause of lichen. The simpler form is often dependent in children on intestinal irritation, while in other cases it may frequently be traced to exposure to heat, or errors of diet. The severe form is also occasioned by extreme heat and by the abuse of spirituous drinks.

In ordinary cases, an antiphlogistic diet, a few gentle aperients, and two or three tepid baths, are all that is required. When the disease assumes a chronic character, a tonic treatment (bark and the mineral acids) is necessary; and in very obstinate cases, small doses (three to five minims, well diluted) of Fowler's Arsenical Solution may be given with advantage.

LICHENIN is a starch-like body, found in Iceland moss and other lichens, from which it is extracted by digesting the moss in a cold, weak solution of carbonate of soda for some time, and

then boiling. By this process, the lichenin is dissolved, and on cooling, separates as a colourless jelly. According to Gorup-Besanez (*Lehrbuch der organischen Chemie*, 1860, p. 514), it sometimes assumes a blue, and sometimes a greenish tint, when treated with iodine. In most of its relations it corresponds with ordinary starch.

LICHENS, a natural order of acotyledonous plants, allied to Fungi and to Alga. They are *thallogenous*, consisting mainly of a *Thallus* (q. v.), and without stem and leaves; wholly cellular, and nourished through their whole surface by the medium in which they live, which is air, and not water, although a certain amount of moisture in the air is always necessary to their active growth; and when the air becomes very dry, they become dormant, ready to resume their growth on the return of more favourable weather. The thallus of some is pulverulent; that of others is crustaceous; of others, leaf-like; of others, fibrous. Reproduction takes place by spores, usually contained in sacs (*asci*, *thece*), embodied in repositories of various form, often shield-like or disc-like, called *apothecia* (or shields), which arise from the outer layer of the thallus, and are generally very different in colour from the thallus. But there is also another mode of propagation by *gonidia*, separated cells of the inner or medullary layer of the thallus, usually spherical or nearly so, and always of a green colour. This seems to be a provision for the propagation of L., even in circumstances—as of the absence of light—unfavourable to the formation of thecae and spores. L. are plants of long life, differing in this very widely from fungi. They are most widely diffused, growing equally in the warmest and the coldest regions. On the utmost limits of vegetation, in very high latitudes, or on the very highest mountains, they cover the soil in great masses. Some grow on earth, others on stones, others on the bark of trees, and some of the tropical species on evergreen leaves. In the great economy of nature, they serve for the first commencement of vegetation, especially to prepare the soil for plants of higher organisation. The gray, yellow, and brown stains on old walls are produced by minute L., which have begun to vegetate where nothing else could. The curiously scattered apothecia of some present the appearance of written characters often seen on the bark of trees. Some hang as tufts or shaggy beards from old trees, some grow amidst heaths and mosses to cover the soil of the most frigid regions. L. contain a peculiar gelatinous substance resembling starch, and called *Lichenin* or *Lichen Starch*; generally also a bitter substance called *Cetrarine*; resin; a red, bright yellow, or brown colouring matter; oxalate and phosphate of lime, &c.; and are therefore adapted to purposes of domestic economy, medicine, and the arts. Some are used for food, as Iceland Moss (q. v.) and *Tripe de Roche* (q. v.); some afford food for cattle, as Reindeer Moss (q. v.); some are medicinal, as Iceland Moss; some afford dye-stuffs, as Archil (q. v.), Cudbear (q. v.), &c.

LITCHFIELD, an ancient episcopal city of Staffordshire, England, a municipal and parliamentary borough and county in itself, is situated 17 miles south-east of Stafford, and 115 north-west of London. Its chief edifice is the cathedral, part of which is in the Early English style. It has three towers, each surmounted by a spire, and is profuse and elaborate in its ornamentation. The Free Grammar-school, in which Addison, Aahmole, Johnson, and Garrick were educated, has an income of about £100 a year, and has nine exhibitions, tenable for three years. Considerable brewing is carried on. Pop. 6893. L. returns two members to parliament.

LICINIUS, a Roman emperor. See **CONSTANTINE I.**

LICTORS (according to Aulus Gellius, from *ligare*, to bind, because the lictors had to bind the hands and feet of criminals before punishing them) were, among the Romans, the official attendants of magistrates of the highest rank. They carried the *Fasces* (q. v.) before the magistrates, clearing the way, and enforcing the use of the appropriate marks of respect. It was their duty to execute the punishments ordered by the magistrates, such as scourging with rods, and beheading. They were originally free men of the plebeian order, and not till the time of Tacitus could the office be held by freedmen. Slaves were never appointed lictors.

LIE, in point of Law, is not a ground of action, unless in peculiar circumstances. If, for example, it is material, and is uttered by a witness or deponent, it is the criminal offence of perjury. Sometimes, also, if a person, knowing that another will act upon his information, tell a lie, and which is believed to be true, and acted on, and damage follows, the party telling the lie may be sued for the damages. But in other cases, lying *per se* is not punishable by law, civilly or criminally.

LIEBIG, JUSTUS, BARON VON, one of the greatest chemists of the present day, was born at Darmstadt, 12th May 1803. He early shewed a strong predilection for natural science. He studied at Bonn and Erlangen, and afterwards in Paris, where he attracted the attention of Alexander von Humboldt by a paper on Fulminic Acid. This led to his appointment, in 1824, as Extraordinary Professor, and in 1826, as Ordinary Professor of Chemistry at Giessen, where he laboured with great activity for more than a quarter of a century, making that small university a centre of attraction to students of chemistry from all parts of Germany and from foreign countries. Many honours were conferred on him. The Duke of Hesse raised him to the rank of baron. In 1852, he accepted a professorship in the university of Munich, and the charge of the chemical laboratory there; and in 1860 was appointed president of the Munich Academy of Sciences, as the successor of Thiersch.

L. has laboured with success in all departments of chemistry, but particularly in organic chemistry, in which he has made many discoveries and done much to improve the methods of analysis. He has investigated with great care the relations of organic chemistry to physiology, pathology, agriculture, &c.; and although many of his views have been combated, and several have been abandoned by the author himself, it is, nevertheless, universally admitted that his researches have greatly advanced the science of agriculture in particular. Many of his papers are contained in the *Annalen der Chemie und Pharmacie*. He published the *Wörterbuch der Chemie* (Brunsw. 1837—1851) in conjunction with Poggendorf, and also a Supplement to this work (1850—1852), but the discoveries of more recent years are exhibited in the later volumes. He wrote the part relative to Organic Chemistry in the new edition of Geiger's *Handbuch der Pharmacie* (Heidelb., 1839), published afterwards as *Die Organische Chemie in ihrer Anwendung auf Physiologie und Pathologie*, which was translated into French and English (1842). His work on *Organic Chemistry in its Application to Agriculture* (Brunsw. 1840; English translation by Dr Lyon Playfair, 1840; and French translation by Gerhardt, 1840), and his *Chemical Letters* (Paris, 1852), all of which have gone through numerous editions, and have been translated into different languages, are among the most valuable contributions to chemical literature which have been made in our age.

LIECHTENSTEIN, the smallest principality of the German Confederation, has an area of only 60 square miles, with a pop. of 7150. L. is a mountainous district, lying on the Upper Rhine, between Switzerland and the Tyrol, the latter bounding it to the N. and E., while the Rhine forms its western, and the canton of the Grisons its southern boundary. It is divided into the districts of Vadutz and Schellenberg, and the principal town is Liechtenstein (pop. 1000), formerly known as Vadutz. The products are wheat, flax, and good wines and fruit. Considerable numbers of cattle are raised, and game is abundant. L., together with several other small states, forms the 15th member of the German Confederation, but in the *Plenum*, or full Council of the Diet, it has a separate vote. It furnishes a contingent of 70 men to the federal army. The Prince of L., whose family is one of the most ancient and illustrious of Central Europe, possesses extensive mediatised principalities in Austria, Prussia, and Saxony, which together extend over an area of nearly 2200 square miles, with a population of more than 600,000, and yield their proprietor an annual revenue of 1,400,000 florins. The government of L. is administered by the aid of a chamber of representatives, who meet annually to hold a diet, but whose acts are under the control of a Council of State, which has its seat at Vienna, where the prince usually resides. The revenue of L., independently of the mediatised possessions of the sovereign, amounts to 31,000 thalers. There is no national debt.

LIEGE (so called in French, but by the Germans *Lüttich*, and by the Flemings *Luik*) is the most easterly province of Belgium. Area, 1106 square miles; pop. (1861) 530,398. The southern part of the province is hilly, rocky, heathy, and much covered with wood, in some places yielding, however, great quantities of coal and iron; but the part called the *Herve*land (north of the Weeze) is extraordinarily fertile and well cultivated, and has also splendid pasturage for cattle. The valley of the Weeze is very beautiful, and exhibits an endless diversity of scenery. The railway from Aix-la-Chapelle to L., which passes through this valley, has had immense difficulties to overcome in the nature of the ground, and is consequently regarded as a *chef-d'œuvre* of the kind. Nearly a sixth of the whole road had to be artificially constructed. The inhabitants are Walloons.

LIEGE, capital of the province of the same name, is situated on the Meuse, immediately below its confluence with the Ourthe, in a magnificent plain. A hill rises on each side of the city, one of which is occupied by the citadel. The river, which divides L. into two parts, the old and the new town, is crossed by 17 bridges. L. is said to be the most picturesque city in Belgium. Many of the public buildings are fine, especially the churches, of which the principal are the Church of St James (founded 1014, finished 1538), the cathedral (finished 1557), the Church of St Martin's, the Church of the Holy Cross (consecrated 979), and St Barthelemy (which has 5 naves). The Palace of Justice, with its paintings and 60 rooms—formerly the residence of the episcopal princes of L.—and the University, noted for its mining-school, also deserve mention. The general interior of the city, however, is by no means pleasant; everything is blackened by the smoke of the coals, which have been worked for 300 years; the streets are narrow, the houses high, badly aired, and uncleanly. The manufacture of arms is the great staple of industry. Everywhere the hammer is heard; countless forges flash out their sudden sparks, and whole streets are red with the reflection of fires.

All kinds of steam-machinery, locomotives, steam-boats, &c., are made here for Germany. In the immediate neighbourhood are important zinc-foundries. L. is connected by railways with Brussels, Antwerp, Namur, &c. Pop. (1861) 96,207.

L. became the seat of a bishop in the 8th c., and continued to be so till 1794; and its bishops were reckoned among the princes of the German empire; but as it early acquired considerable magnitude and importance, its inhabitants maintained a struggle for their own independence against their bishops, in which frequent appeals were made to arms. During the wars of Louis XIV., it was several times taken and retaken.

LIEGE POUSTIE. See DEATH-BED.

LIEGNITZ, a town of Prussia, in the government of Silesia, at the confluence of the Schwarzwasser and the Katzbach, 40 miles west-north-west of Breslau. It has numerous educational and benevolent institutions, art-collections, and industrial museums. Cloth, leather, and tobacco are largely manufactured, and vegetables are extensively cultivated in the gardens of the suburbs. This town was, from 1164 to 1675, the residence of the Dukes of Liegnitz. Here, in 1813, Blücher defeated the French. Pop. 16,584, of whom about 3000 are Catholics.

LIEN, in English and Irish Law, means the security or hold over goods or land for a debt which is due. A right of lien is the right to retain goods of a third party which are in the creditor's hands, until a debt due by such party to the creditor is paid. Possession is in general essential to constitute a lien, for the moment the goods are voluntarily parted with the lien is gone. Liens are general or particular. Thus, an attorney has a general lien over his client's papers and title-deeds till the amount of his bill of costs is paid. So have bankers, dyers, calico-printers, factors. A particular lien is a lien over goods, for a debt contracted in respect of such goods, as for the price of them, or some labour expended on them. Thus, a miller has a lien on the flour he has ground, a trainer on the horse he has trained, &c. There are also maritime liens and equitable liens, which do not require possession to constitute the right. In Scotland, lien is generally called either Retention (q. v.) or Hypothec (q. v.).

LIEÛRE, a town of Belgium, in the province of Antwerp, 10 miles south-east of the city of that name, at the confluence of the Great and Little Nethe. L. has noted breweries; extensive manufactures of linen, silk, lace, and musical instruments are carried on, and there are several sugar-refineries and oil-mills. Pop. 15,000.

LIEUTENANT (Fr. from Lat. *locum-tenens*, holding the place of another), a term applied to a variety of offices of a representative kind. Thus, in military matters, a *lieutenant-general* personates with each division of an army the general-in-chief. A *lieutenant-colonel* (q. v.) commands a battalion for a colonel, in the latter's absence. But the title lieutenant, without qualification, denotes the second officer and deputy, or *locum-tenens*, of the captain in each company of cavalry or infantry. A lieutenant in the British Foot Guards ranks as captain in the army, and exchanges with a captain in another regiment.—*Captain-lieutenant*, an obsolete rank, was the subaltern who commanded the 'colonel's company' in each regiment.—A *second-lieutenant* is the junior subaltern of a company, and corresponds to an Ensign (q. v.). The pay of a lieutenant varies from 10s. 4d. a day in the Life Guards to 6s. 6d. in the line.

In the British navy, lieutenant is a misnomer in the case of the officer bearing that title. His

functions in all respects correspond to those of a captain in the army, with whom he ranks, and with whom he also nearly matches in regard to pay. A lieutenant's full pay is 10s. a day; and his half-pay ranges, according to length of services, from 4s. to 7s. a day. Six years' service afloat are requisite to qualify an officer for the rank of lieutenant, and the candidate has also to pass a satisfactory examination in seamanship and general professional knowledge. As leaders in all minor enterprises, such as boat expeditions, cutting out, &c., lieutenants in war-time carry off most of the laurels awarded to actions of singular personal daring.

LIEUTENANT, LORD-, OF A COUNTY, a permanent provincial governor appointed by the sovereign by patent under the great seal. The office in England arose from the occasional commissions of array issued by the crown in times of danger or disturbance, requiring experienced persons to muster the inhabitants of the counties to which the commissioners were sent, and set them in military order. The right of the crown to issue such commissions was denied by the Long Parliament, this question proving the immediate cause of the breach between Charles I. and his subjects. Their legality was established at the Restoration by a declaratory act. The lord-lieutenant is now the permanent local representative of the crown, who, on the occasion of an invasion or rebellion, has power to raise the militia, form regiments, troops, and companies, and give commissions to officers. The history of the office seems to have been somewhat similar in Scotland. In act 1438 c. 3, the 'lieutenant' is commanded to 'raise the county' whenever it may be necessary to bring the rebellious and unruly possessors of castles and fortalices into subjection; and though his powers were executive rather than judicial, he seems sometimes to have had authority to exercise the functions of the sheriff, or overrule his decisions. The lord-lieutenant of a county is at the head of the magistracy, the militia, and the yeomanry; he nominates officers of militia and volunteers, and is the chief executive authority, forming the settled channel of communication between the government and the magistracy, and considered as responsible in cases of emergency for the preservation of public tranquillity. Under him, are permanent deputy-lieutenants appointed by him.

LIEUTENANT, LORD-, OF IRELAND, the viceroy or deputy of the sovereign to whom the government of Ireland is committed. The office has existed from a remote period, the appointment having been made under different designations. His powers were in early times very extensive, almost regal. For the last half century following the Revolution, the lord-lieutenant resided little in Ireland, visiting it only once in two years, to hold the session of parliament. Some lords-lieutenant never went to Ireland at all, and occasionally, instead of a viceroy, lords-justices (see JUSTICES, LORDS) were appointed.

The lord-lieutenant is appointed under the great seal of the United Kingdom, and bears the sword of state as the symbol of his viceregal office. He has the assistance of a privy-council of 58 members, appointed by the sovereign, and of officers of state. He is commissioned to keep the peace, and the laws and customs of Ireland, and to see that justice is impartially administered. He has the control of the police, and may issue orders to the general commanding the troops for the support of the civil authority, the protection of the public, the defence of the kingdom, and the suppression of insurrection. He may confer knighthood, and has the disposal of church preferment (except bishops' sees and deaneries), as well as all the other patronage of the

country. The granting of money, and lands, and pensions, of all titles of honour except simple knighthood, the appointment of privy-councillors, judges, law-officers, and governors of forts, and the appointment to military commissions, are reserved to the sovereign, acting, however, on the lord-lieutenant's advice and recommendation. No complaint of injustice or oppression in Ireland will be entertained by the sovereign until first made to the lord-lieutenant, who is in no case required to execute the royal instructions in a matter of which he may disapprove until he can communicate with the sovereign and receive further orders. Yet, notwithstanding the dignity and responsibility of his office, the lord-lieutenant acts in every matter of importance under the direct control of the cabinet of Great Britain. The views and opinions of the cabinet on all the more important questions connected with his government are communicated to him by the Home Secretary, who is held responsible for the government of Ireland, and with whom it is the duty of the lord-lieutenant to be in close correspondence; on matters of revenue, he must be in constant communication with the Treasury. On his occasional or temporary absence from Ireland, lords-justices are appointed, who are usually the Lord Primate, the Lord Chancellor, and the Commander of the Forces. His salary is £20,000, with a residence in Dublin Castle, as well as one in Phoenix Park. His tenure of office depends on that of the ministry of which he is a member. By act 10 Geo. IV. c. 7, a Roman Catholic is ineligible for the lieutenancy of Ireland.

LIEUTENANT-COLONEL, in the British Army, is nominally the second officer in a regiment; but virtually a lieutenant-colonel commands every battalion of infantry and regiment of cavalry, the post of colonel being merely an honourable sinecure, with usually £1000 a year attached, awarded to a general officer. The lieutenant-colonel is responsible for the discipline of his battalion, the comfort of his men, and ultimately for every detail connected with their organisation. He is assisted in his duties by the major. In the artillery and engineers, where the rank of colonel is a substantive rank, with tangible regimental duties, the functions of lieutenant-colonel are more limited, one having charge of every two batteries of artillery, or two companies of engineers. The pay of a lieutenant-colonel varies from £1,9s. 2d. per diem in the Household Cavalry to 17s. in the infantry of the line. Five years' regimental service as lieutenant-colonel entitles an officer to brevet rank as colonel, which, while improving his position in the army, does not, however, affect his status in his regiment.

LIEUTENANT-GENERAL. See GENERAL OFFICER.

LIFE. In seeking a definition of life, it is difficult to find one that does not include more than is necessary, or exclude something that should be taken in. Richerand's definition of life, that it is 'a collection of phenomena which succeed each other during a limited time in an organised body,' is equally applicable to the decay which goes on after death. According to De Blainville, 'life is the twofold internal movement of composition and decomposition, at once general and continuous.' As Mr Herbert Spencer in his *Principles of Biology* well observes, this conception is in some respects too narrow, and in other respects too wide. Thus, it excludes those nervous and muscular functions which form the most conspicuous and distinctive classes of vital phenomena, while it equally applies to the processes going on in a living body and in a galvanic battery. Mr Spencer (in 1852) proposed to define life as 'the co-ordination of actions,' but, as he

observes, 'like the others, this definition includes too much, for it may be said of the solar system, with its regularly recurring movements and its self-balancing perturbations, that it also exhibits co-ordination of actions.' His present and amended conception of life is: 'The definite combination of heterogeneous changes, both simultaneous and successive, in correspondence with external co-existences and sequences.' One of the latest definitions of life is that which has been suggested by Mr G. H. Lewes: 'Life is a series of definite and successive changes, both of structure and composition, which take place within an individual without destroying its identity.' This is perhaps as good a definition as has yet been given; but no one of those we have quoted is more than approximately true, and a perfect definition of life seems to be an impossibility.

LIFE, MEAN DURATION OF. By this term is meant the average length of life enjoyed by a given number of persons of the same age. Suppose we look at the Northampton Table of Mortality, we find that, of 3635 persons aged forty, 3559 reach forty-one, 3482 reach forty-two, and so on; the whole failing at ninety-six. The average age then attained by the 3635 persons being ascertained on these data, would be the mean duration of life after the age of forty has been reached. Suppose, then, that a be the given number alive at a given age by a given mortality table, and b the number alive at the end of the first year, c the number alive at the end of the second, and so on; then there die at the end of the first year, $a - b$; and assuming that those who have died have, on an average, lived half a year, the aggregate length of life enjoyed by those who have died during the first year will be $\frac{1}{2}(a - b)$ years; then b being still alive, the a persons have enjoyed, at the end of the first year, $\frac{1}{2}(a - b) + b = \frac{1}{2}(a + b)$ years. In the second year, the a persons enjoy $\frac{1}{2}(b + c)$; in the third, the c persons enjoy $\frac{1}{2}(c + d)$ years; and so on. Summing these, and dividing by the original number of lives, so as to ascertain the average, gives $\frac{1}{2} + \frac{b + c + d}{a}$; hence the rule: Add

the numbers alive at each age above that given, divide by the number alive at the given age, and add half a year. The mean duration of life at a given age is often called the 'expectation of life'; but this is clearly a wrong term to use. Of 1000 lives at twenty, suppose 500 to reach forty-five; then a man aged twenty has an equal chance of reaching forty-five, and twenty-five years would be his expectation of life. But it clearly does not follow that taking the 500 who have not reached twenty-five, along with the 500 who have survived it, we should find, on extinction of the whole, that the mean duration was twenty-five years. It might be either greater or less. The term 'expectation of life,' as generally applied by assurance companies to denote mean duration, is therefore a wrong one. In connection with this subject, see **MORTALITY**, also **MAN**.

LIFE-ASSURANCE. See **INSURANCE**.

LIFE-BOAT, a boat adapted to 'live' in a stormy sea, with a view to the saving of life from shipwreck. Its qualities must be buoyancy, to avoid foundering when a sea is shipped; strength, to escape destruction from the violence of waves, from a rocky beach, or from collision with the wreck; facility in turning; and a power of righting when capsized.

A melancholy wreck at Tynemouth, in September 1789, suggested to the subscribers to the South

Shields News-room, who had witnessed the destruction of the crew one by one, that some special construction of boat might be devised for saving life from stranded vessels. They immediately offered a premium for the best form of life-boat; and the first boat built with the express object of saving life was that constructed on this occasion by Mr Henry Greathead. It was of great strength, having the form of the quarter of a spheroid, with sides protected and rendered buoyant within and without by the superposition of layers of cork. So useful was it in the first twenty-one years after its introduction, that 300 lives were saved through its instrumentality in the mouth of the Tyne alone. Mr Greathead received the gold medals of the Society of Arts and Royal Humane Society, £1200 from parliament in 1802, and a purse of 100 guineas from Lloyd's, the members of which society also voted £2000 to encourage the building of life-boats on different parts of the coast. Although various other life-boats have been invented from time to time, Greathead's remained the general favourite until about the year 1851, and many of his construction are still to be seen on different points of the coast. They failed, however, occasionally; and several sad mishaps befell the crews of life-boats, especially in the case of one at South Shields, in which twenty pilots perished. Upon this the Duke of Northumberland offered a prize for an improved construction, and numerous designs were submitted, a hundred of the best of which were exhibited in 1851. Mr James Beeching of Yarmouth obtained the award; but his boat was not considered entirely satisfactory, and Mr R. Peake, of Her Majesty's Dockyard at Woolwich, was intrusted with the task of producing a life-boat which should combine the best qualities of the different inventions. His efforts were very successful, and the National Life-boat Institution adopted his model as the standard for the boats they should thereafter establish on the coasts.

Sections of Mr Peake's life-boat are shewn below, one lengthwise through the keel, the other cross-wise in the middle. A, A, are the thwarts on which the rowers sit; BB, a water-tight deck, raised sufficiently above the bottom of the boat to be above the level of the sea when the boat is loaded; C, C, are air-tight chambers running along each side, and occupying from 3 to 4 feet at each end:

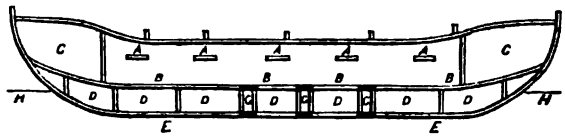

Fig. 1.—Section lengthwise.

the buoyancy afforded by these more than suffices to sustain the boat when fully laden, even if filled with water. To diminish the liability to capsize in a heavy sea, the life-boat has great beam (breadth) in proportion to her length, viz., 8 feet beam to 30 length. In addition, the bottom is almost flat. As in her build it has been found convenient to dispense with cross-pieces, some means are required to preserve the rigidity of the whole structure amid the buffeting of a tempest. To achieve this, and also to serve the purposes of light ballast, Mr Peake fills the space between the boat's bottom and the water-tight deck (BB) with blocks, tightly wedged together, of cork and light hard wood, D, D. These would form a false bottom, were a rent made in the outer covering, and, by their comparative weight, counteract in some degree the top-heaviness induced by the air-vessels, which are entirely above the water

line (H). This arrangement would be insufficient to maintain the equilibrium of the boat, however, and especially under sail, so Mr Peake has added a

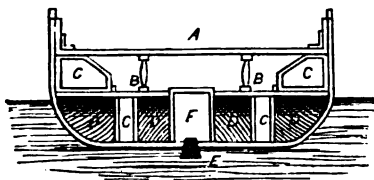

Fig. 2.—Section crosswise.

heavy iron keel (E) of from 4 to 8 cwt., which effectually keeps the boat straight. Some builders object to this iron ballast: the Liverpool and Norfolk boats take out their plugs, and preferably admit water until steadiness is secured; but Mr Peake has an additional object in view—that of causing the boat to immediately right itself if turned upside down, as the best boats sometimes will be in heavy gales. It will be noticed that the ends of the boat rise above the centre $1\frac{1}{2}$ to 2 feet. This, for one thing, facilitates turning, as the pivot on which her weight rests is shortened; for another, if she capsizes and is thrown bottom up, these raised caissons are sufficient to sustain her by their buoyancy. So long, then, as she floats precisely in an inverted state, she will be steady; but the slightest motion to either side—which, of course, in practice ensues instantly—throws the heavy keel off the perpendicular, in which its centre of gravity was exactly over the line between bow and stern, and the boat must immediately right itself. This process is shewn in fig. 3,

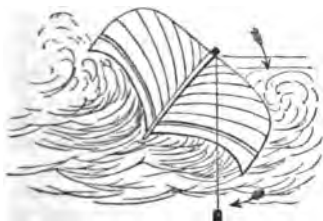

Fig. 3.

where it will be perceived that the overturned boat must forthwith right itself in the direction indicated by the arrow, on account of the heavy top-weight at E. F is a covered trough, to contain the tackle, sails, &c., when not in use; in service, it is also useful to receive any water that may penetrate among the cork and wooden chocks beneath the water-tight deck: this leakage is at times considerable when the outer skin of the boat has sustained damage. The trough may be fitted with a small hand-pump, to enable one of the sitters to clear it out when necessary.

Perhaps the most beautiful contrivance in the life-boat is that for discharging the water which she ships. This consists of six relieving tubes, G, each six inches in diameter, passing through the deck, B, the ballast, D, and the bottom. The tubes, which are near the centre of the boat, three on each side, have at the bottom a valve opening outwards. As the deck, B, is always above the water-level, any water in the boat necessarily flows out through these tubes, so that if a wave bursts over her, and completely fills the boat, the relieving tubes free her, and she is empty again in a few minutes. The greater the height of water within, the faster will it run out. The advantages of the

life-boat may be thus summed up. The air-chambers and the light ballast render sinking impossible; the keel nearly prevents capsizing, and rectifies it, if it does happen; while the relieving tubes effectually clear off any water that finds its way within. With such precautions, the safety of the crew appears almost assured, and, in fact, loss of life in a life-boat is a very rare occurrence.

The boat is kept on a truck—of considerable strength, as the life-boat weighs two tons—close to the beach, and is drawn to the water's edge when required; the crew are trained to their work, and, it need not be added, are among the hardiest of seamen. Ordinary life-boats are rowed by eight or twelve oars (of the best fir) double banked; but for small stations, where it would be difficult to collect so many men at short notice, smaller boats are made, rowing six oars single banked.

The importance of the life-boat in saving life can scarcely be over-estimated. Hundreds of vessels have their crews rescued through its use every year; and as the National Life-boat Institution obtains funds, this invention is being gradually extended all round the coast of the United Kingdom, while foreign nations have not been remiss in thus protecting their shores.

The *Royal National Life-boat Institution*, after an unrecognised existence of several years, was formally incorporated in 1824. Its objects are the provision, maintenance, and efficient working of life-boats on all parts of the coast; also, by granting rewards in places where the scanty population would not justify a life-boat station, the stimulation of coast-seamen to save life from wrecks. The society is of course dependent for its support on voluntary contributions, which have not hitherto failed; and it may safely be said, that scarcely can a nobler recipient for charity be found than this purely philanthropic institution. By the latest Report, it appeared that, up to December 1861, the society owned 121 life-boats in active employ; and that up to the same period, it had saved 12,272 lives from shipwreck, all of which would, there is reason to believe, have been lost but for its assistance. During 1861, the Institution received £15,093, and spent £6162 on new boats, houses, and gear, £3057 on repairs, £1368 in rewards, and £1950 on cocksweins' wages and to the crews for practising quarterly. The cost of a new station complete (from £300 to £500) is frequently presented by some charitable individual.

The size of a common life-boat renders it inconvenient for stowage on shipboard. To obviate this, the Rev. E. L. Berthon, of Fareham, has invented a collapsing boat, which is readily expanded, possesses great strength, and at the same time occupies comparatively little space when out of use. Its sides are connected by various hinges. This boat is extensively employed for ocean steam-ships.

LIFE-ESTATE, in English Law, is an estate or interest in real property for a life. The life may be either that of the owner or of some third party, in which latter case it is called an estate *pur autre vie*. Life-estates in lands are classed among Freeholds (q. v.). The tenant for life has certain rights in regard to the uses of the estate. He is entitled to cut wood to repair fences, to burn in the house, &c. He cannot open a mine on the estate, but if it was already opened, he is entitled to carry it on for his own profit. Life-estates are created by deed, but there are certain estates created by law, as Courtesy (q. v.), Dower (q. v.), tenancy in tail after possibility of issue extinct. As to Scotland, see **LIFERENT**.

LIFE GUARDS, the two senior regiments of the mounted portion of the body-guard of the

British sovereign and garrison of London. They took their origin in two troops of horse-grenadiers raised respectively in 1693 and 1702: these troops were reduced in 1783, and reformed as regiments of Life Guards. Although usually employed about the court and metropolis, the Life Guards are not exempt from the liability to foreign service when required, having distinguished themselves in the Peninsula and at Waterloo. The men are all six feet high and upwards, armed with sword and carbine, wear knee-boots, leather breeches, red coats, and steel helmets. They also wear steel cuirasses, the utility of which is considered very doubtful. With this unwieldy armour, they require powerful horses, which are uniformly black. The two regiments comprise 878 men, with 550 horses, and their pay and personal allowances amount to £54,742.

LIFE-PRESERVERS, inventions for the preservation of life in cases of fire or shipwreck. The fire life-preservers will be found treated of under **FIRE-ESCAPES**. The other class includes the various contrivances for preserving the buoyancy of the human body, and for reaching the shore. Of these, the readiest and most effective are empty water-casks, well bunged-up, and with ropes attached to them to hold on by. It has been found that a 36-gallon cask so prepared can support ten men conveniently, in tolerably smooth water. Cook's and Rodger's patent life-rafts consist of square frames buoyed up by a cask at each corner. Among foreign nations, frames of bamboo, and inflated goat and seal skins, have been long employed as life-preservers; and in China, it is customary for those living on the banks of the canals to tie gourds to their children, to buoy them up in case of their falling into the water. Since the introduction of cork, jackets and belts of that material in immense variety have been patented. It has been calculated that one pound of cork is amply sufficient to support a man of ordinary size and make. A few years ago, on the invention of india-rubber cloth, inflated belts of this material were made, and found to be superior in buoyancy to the cork belt, besides, when emptied of air, being very portable. They are, however, much more liable to damage by being punctured or torn, or to decay by being put away while damp. Some of these defects are remedied by having the interior of the belt divided into several compartments; so that, when one is damaged, the remainder may still suffice. Various forms of inflated mattresses, pillows, &c., have been made on the same principle, and been found very effective; one shewn at the Great Exhibition of 1851 having sustained 96 pounds for five days without injury. But the favourite life-buoy among sailors is composed of slices of cork neatly and compactly arranged, so as to form a buoyant zone of about 30 or 32 inches in diameter, 6 in width, and 4 in thickness. It consequently contains about 12 lbs. of cork, and is generally covered with painted canvas to add to its strength and protect it from the injurious action of the water. A buoy so constructed can sustain six persons, and it is generally furnished with a *life-line* (a cord running round the outside of the buoy and fastened to it at four points) to afford a more convenient hold. This life-preserver is found on board of all vessels.

LIFERENT, in Scotch Law, means a right to use a heritable estate for life, the person enjoying it being called a liferenter. The rights of a liferenter nearly resemble, though they are not identical with, those of a tenant for life in England. See **LIFE-ESTATE**.

LIFTS, ropes, on shipboard, for raising or lowering and maintaining in position the yards. They

pass from the deck over pulleys at the mast-head, and thence to near the extremities of the yard. The lift bears the designation of the yard to which it is attached, as *fore-lift*, *main-top-gallant-lift*, &c. See **RIGGING**.

LIGAMENTS are cords, bands, or membranous expansions of white fibrous tissue, which play an extremely important part in the mechanism of joints, seeing that they pass in fixed directions from one bone to another, and serve to limit some movements of a joint, while they freely allow others.

Todd and Bowman, in their *Physiological Anatomy*, arrange ligaments in three classes: 1. *Funicular*, rounded cords, such as the external lateral ligament of the knee-joint, the perpendicular ligament of the ankle-joint, &c.; 2. *Fascicular*, flattened bands, more or less expanded, such as the lateral ligaments of the elbow-joint, and the great majority of ligaments in the body; 3. *Capular*, which are barrel-shaped expansions attached by their two ends to the two bones entering into the formation of the joint, which they completely but loosely invest: they constitute one of the chief characters of the ball-and-socket joint, and occur in the shoulder and hip joints. See **JOINTS**.

LIGATURA, an Italian term in Music, meaning binding, frequently marked by a slur, thus \frown , which is placed over certain notes for the purpose of shewing that they are to be blended together; if in vocal music, that they are to be sung with one breath; also used in instrumental music, to mark the phrasing.

LIGATURE, the term applied, in Surgery, to the thread tied round a blood-vessel to stop bleeding. The ligatures most commonly used consist of strong hempen or silk threads; but catgut, horse-hair, &c., have been employed by some surgeons. A ligature should be tied round an artery with sufficient tightness to cut through its middle and internal walls. Although the operation of tying arteries was clearly known to Rufus of Ephesus, who flourished in the time of Trajan, it subsequently fell into desuetude, till it was rediscovered by Ambrose Paré, in the 16th century.

LIGHT is the subject of the science of Optics (q. v.). We here just notice its principal phenomena, and the hypotheses advanced to explain them. Every one knows that light diverges from a luminous centre in all directions, and that its transmission in any direction is *straight*. It travels with great velocity, which was first ascertained, by observations on the eclipses of Jupiter's satellites, to be 195,000 English miles in one second. Shadows (q. v.) are a result of its straight transmission; and it follows from its diverging in all directions from a luminous centre, that its intensity diminishes inversely as the square of the distance from the centre. When it falls on the surfaces of bodies, it is reflected from them, regularly or irregularly, totally or partially, or is partly or wholly transmitted or refracted through them. The phenomena of the reflection and of the refraction of light are treated of respectively under the heads *Catoptrics* (q. v.) and *Dioptrics* (q. v.). The facts of observation on which catoptrics is founded are two: 1. In the reflection of light, the incident ray, the normal to the surface, and the reflected ray are in one plane; 2. The angle of reflection is equal to the angle of incidence. Similar to these are the physical laws on which dioptrics is founded. When a ray of homogeneous light is incident on a refracting surface, 1. The incident and refracted ray lie in the same plane as the normal at the point of incidence, and on opposite sides of it; 2. The sine of the angle

of incidence, whatever that angle may be, bears, to the angle of refraction, a ratio dependent only on the nature of the media between which the refraction takes place, and on the nature of the light. In stating these laws, we have hinted at light being of different kinds. At one time, it was not supposed that colour had anything to do with light; now, there is no serious dispute but that there are lights of different colours (see CHROMATICS and SPECTRUM), with different properties, though obeying the same general laws. Among the most striking phenomena of light are those treated of under the head POLARISATION (q. v.). Next to these in interest are the phenomena of double refraction. See REFRACTION, DOUBLE. For an account of the chief chemical properties of light, see PHOTOGRAPHY and SPECTRUM. See also, for phenomena not noticed above, the articles ABERRATION, DIFFRACTION, DISPERSION, INTERFERENCE.

Two hypotheses have been advanced to explain the different phenomena of light, viz. the theory of emission, or the corpuscular theory, and the theory of vibration, or the undulatory theory. According to the former, light is an attenuated imponderable substance, whose colours depend on the velocity of its transmission. It regards reflection as analogous to the rebounding of elastic bodies; while, to explain refraction, it assumes that there are interstices in transparent bodies, to allow of the passage of the particles of light, and that these particles are attracted by the molecules of bodies—their attraction combining with the velocity of the particles of light to cause them to deviate in their course. The undulatory theory assumes that light is propagated by the vibrations of an imponderable matter termed Ether (q. v.). On this view, light is somewhat similar to sound (see INTERFERENCE). Newton was the author of the former theory, and Huyghens may be regarded as the author of the latter. The theories were long rivals, but now no doubt remains that the theory of undulations has triumphed over the other. Its soundness may be said to rest on similar evidence to that which we have for the theory of gravitation: it had not only satisfactorily accounted for all the phenomena of light, but it has been the means of discovering new phenomena. In fact, it has supplied the philosopher with the power of prescience in regard to its subject. Those who wish to study the theory may advantageously consult its popular exposition by Young (*Lectures on Natural Philosophy*, London, 1845), and Lloyd's *Wave Theory of Light* (Dublin, 1856). The mathematical theory is very fully investigated in Airy's *Mathematical Tracts*.

LIGHT. In point of Law, the right to light is one of the rights incident to the ownership of land and houses. When it is claimed in such a way as to interfere with a neighbour's absolute rights, it is called, in England and Ireland, an Easement (q. v.), and in Scotland a Servitude (q. v.). In England and Ireland, the right to light, as between neighbours, is qualified in this way, and forms a subject of frequent dispute in towns and populous places. If A build a house on the edge of his ground with windows looking into B's field or garden which is adjacent, B may next day, or any time within 20 years, run up a house or screen close to A's windows, and darken them all, for one has as good a right to build on his own land as the other. But if B allow A's house to stand 20 years without building, B is for ever after prevented from building on his own land so as to darken A's lights, for A then acquires a prescriptive right to an easement over B's lands. In the Roman law, a person was entitled not only to a servitude of light, but also of prospect; but in this country the

right of prospect, or of having a fine view, is not recognised by the law, except so far that the lights, after 20 years, must not be sensibly darkened. In Scotland, a servitude of light may exist in like manner, but it cannot be constituted except by special grant; whereas in England, if nothing is said, the right is acquired by prescription, or mere lapse of time. In Scotland, a neighbour, B, may, after 20 years, or any distance of time, build on his own land, and darken A's windows, provided he do not act wantonly, emulouly, or so as to cause a nuisance.

LIGHTER, a large flat-bottomed barge or boat, usually propelled or guided by two heavy oars, and used for conveying merchandise, coals, &c., between ships and portions of the shore they cannot reach by reason of their draught.

LIGHTFOOT, JOHN, one of the earlier Hebrew scholars of England, was born in 1602 at Stoke-upon-Trent, in Staffordshire. He studied at Christ's College, Cambridge, and, after entering into orders, became chaplain to Sir Rowland Cotton, who, being himself a good Hebrew scholar, inspired L. with a desire to become one also. In 1627, appeared his *Erubhim, or Miscellanies Christian and Judaical*, which were dedicated to Sir Rowland, who, in 1631, presented him to the rectory of Ashley in Staffordshire. Subsequently, he removed to London, that he might have better opportunities for the prosecution of his favourite study; and in 1642 he was chosen minister of St Bartholomew's, to the parishioners of which he dedicated his *Handful of Gleanings out of the Book of Exodus* (London, 1643). His most important work is *Horæ Hebraicæ et Talmudicæ, &c.* (Cambridge, 1648), recently re-edited by R. Gandell (4 vols., Oxford, 1859). L. was one of the Assembly of Divines who met at Westminster in 1643, and in the debates that took place there, betrayed a decided predilection for the Presbyterian form of church government. In the same year, he was chosen Master of Catharine Hall, Cambridge, and in 1655 vice-chancellor of the university. At the Restoration, he complied with the terms of the Act of Uniformity. He died at Ely, December 6, 1675. At his death, he was engaged on a *Harmony*. The first collected edition of L.'s works was published in 1684, in 2 vols. folio; the best, by the Rev. J. Pitman, in 1822—1825, in 13 vols. L. was a very learned Hebraist for his time, but he was not free from the unscientific crotchets of the period, holding, for example, the inspiration of the vowel-points, &c. He has done good service to theology by pointing out and insisting upon the close connection between the Talmudical and Midraahic writings and the New Testament, which, to a certain extent, is only to be understood by illustrations from the anterior and contemporaneous religious literature.

LIGHT-HOUSE, a building on some conspicuous point of the sea-shore, from which a light is exhibited at night as a guide to mariners. Light-houses are of great antiquity, but they were long of an imperfect kind, and only in recent times have the systems of lighting them been perfected. The most celebrated light-house in ancient times was that erected on the island of Pharos, at Alexandria, 280 B. C., from which Pharos came to be a general name for a light-house, and still subsists in the French *Phare*.

There is no surer test of the advance in civilisation of any maritime country, than an increase in the number of its light-houses. When we consider the amount of property constantly afloat around the shores of Britain, and the number of valuable lives at stake, it seems hardly possible to over-estimate the importance of those beacon-lights,

which supply, though, of course, in an extremely imperfect way, the want of the light of the sun. The light-houses of the United Kingdom now number, with harbour-lights, upwards of 400 stations, and include some of the finest specimens of engineering, such as Smeaton's Eddystone, Robert Stevenson's Bell Rock, Alan Stevenson's Skerryvore, and James Walker's Bishop Rock. As information will be found under their respective heads regarding some of these interesting works, we shall restrict ourselves in the following short memoir to the internal economy of light-houses, and the most approved means of producing a powerful light for the use of the mariner.

Catoptric or Reflecting System.—So recently as the latter part of last century, the sea-lights of Britain consisted of open coal-fires; but this imperfect means of illumination was replaced by reflectors having lamps in their foci. At first, these instruments consisted of small facets of mirror-glass fixed in a mould by means of cement; but reflectors of copper-plate faced with silver, and hammered to the proper form, and carefully polished, were afterwards introduced. The parabolic form (see fig. 1), as is well known, is the most correct for reflecting the light proceeding from the focus and falling upon its

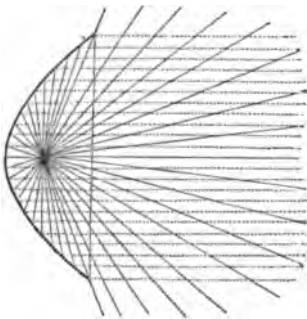

Fig. 1.

surface into one beam of parallel rays. When a series of such reflectors are arranged close to each other round a cylinder in a light-house, they illuminate constantly, though not with equal intensity, the whole horizon. As the property of the parabolic reflector is to collect the rays incident upon its surface into one beam of parallel rays, it would be absolutely impossible, were the flame from which the rays proceed a mathematical point, to produce a light which would illuminate the whole of the horizon, unless there were an infinite number of reflectors. But as the radiant, instead of being a mathematical point, is a physical object, consisting of a flame of very notable size, the rays which come from the outer portion of the luminous cone proceed, after reflection, in such divergent directions, as to render it practically possible to light up, though unequally, the whole horizon. The divergence produced in this way by a burner of one inch in diameter, with a focal distance of four inches, is in the horizontal plane about $14^{\circ} 22'$. The whole horizon may thus be illuminated by reflectors.

If, for the purpose of distinction, it is desired to shew a revolving light, then several of those reflectors are placed with their axes parallel to each other on each of the faces of a four-sided frame, which is made to revolve. In such a case, the mariner sees a light only at those times when one of the faces of the frame is directed towards him, but at all other times he is left in darkness. The rotation of the frame upon its axis thus produces

to his eye a succession of light and dark intervals, which enables him to distinguish it from the fixed light which is constantly in view in every azimuth. The distinction of a red light is best produced by using a chimney of red instead of white glass for each burner. The *flashing* or scintillating light, which is one of the most striking of all the distinctions, was first introduced by the late Mr Robert Stevenson, the engineer of the Northern Light-houses, in 1822, at Buchanness, in Aberdeenshire. The same engineer also introduced what has been called the *intermittent* light, by which a stationary frame with reflectors is instantaneously eclipsed, and is again as suddenly revealed to view by the vertical movement of opaque cylinders in front of the reflectors. The intermittent is distinguished from the revolving light, which also appears and disappears successively to the view, by the suddenness of the eclipses and of the reappearances, whereas in all revolving lights there is a gradual waxing and waning of the light.

Dioptric System.—Another method of bending the diverging rays proceeding from a lamp into such directions as shall be useful to the mariner, is that of *refraction*. If a flame be placed in the focus of a lens of the proper form, the diverging rays will be bent parallel to each other, so as to form a single solid beam of light. So early as 1750, a London optician proposed to grind the glass of the Eddystone Light-house to a lenticular form; but this proposal came to nothing, for the first light of the Eddystone consisted of a few wax-candles, placed upon a chandelier, without even so much as a reflector of any kind behind them. M. Augustin Fresnel was the first to propose and to introduce lenticular action into light-house illumination, by the adoption of the annular or built lens, which had been suggested as a burning instrument by Buffon and Condorcet. He also, in conjunction with Arago and Mathieu, used a large lamp having four concentric wicks. In order to produce a revolving light on the lenticular or dioptric system, a different arrangement was adopted from that which we have described for the catoptric system. The large lamp was now made a fixture, and four or more annular lenses were fitted together, so as to form a frame of glass which surrounded the lamp. When this frame is made to revolve round the lamp, the mariner gets the full effect of the lens whenever its axis is pointed towards him, but in all other positions there is darkness. In order to operate upon those rays of light which passed above the lens, a system of double optical agents was employed by Fresnel. These (see fig. 2) consisted of a pyramid of lenses, *a*, with mirrors, *b*, placed above at the proper angle for rendering the rays passing upwards parallel to those which came from the annular lens, *L*. But Fresnel did not stop here, for, in order to make the lenticular system suitable for fixed as well as revolving lights, he designed a new optical agent, to which the name of cylindrical refractor has been given. This consisted of cylindrical lenses, which were the solids that would be generated were the profile of an annular lens made to circulate round a vertical axis. The action of this instrument is obviously to allow the rays to spread naturally in the horizontal plane, while they suffer refraction in the vertical plane. The effect of this instrument is therefore to shew a light of equal intensity all round the horizon, and thus to form a better light than that which was formerly produced for fixed lights by parabolic reflection. It is obvious, however, from our description that the diverging rays which were not intercepted by this cylindrical hoop, or those which would have passed upwards and been uselessly expended in illuminating the clouds, or

LIGHT-HOUSE.

downwards in uselessly illuminating the light-room floor, were lost to the mariner; and in order to render these effective, Fresnel ultimately adopted the use of what has been called the internal or total reflection of glass; and here it is necessary to explain that one of the great advantages of the action by glass over reflection by metal is the smaller quantity of light that it absorbs. It has been ascertained that there is a gain of almost one-fourth ($\frac{1}{4}$) by employing glass prisms instead

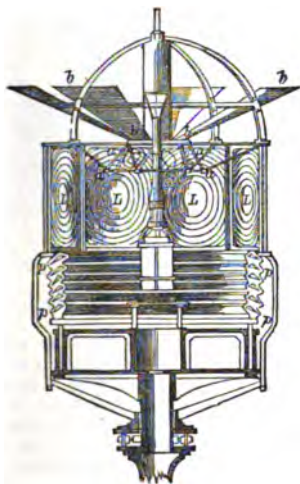

Fig. 2.

of metallic reflectors for light-house illumination. Fresnel introduced, above and below the cylindrical refracting hoop which we have described, certain separate glass prisms of triangular section, the first surface of each of which refracted to a certain extent any ray of light that fell upon it, while the second surface was placed at such an angle as to reflect, by what is called internal or total reflection, the ray which had before been refracted by the first surface; and the last or outer surface produced another refraction, which made the rays pass out parallel with those refracted by the central cylindrical hoop. The light falling above the cylindrical hoop was thus bent downwards, and that falling below was bent upwards, so as to be made horizontal and parallel with that proceeding from the hoop. Figs. 3 and 4 represent



Fig. 3.

in elevation and section this, which is the most perfect of Fresnel's inventions in light-house illumination, and when made of the rhomboidal form,

and used in connection with the diagonal framing introduced by Mr Alan Stevenson, it may be said

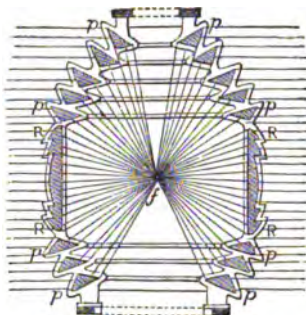

Fig. 4.

to be a perfect apparatus. In the figure, *p* shew the prisms and *R* the cylindrical refractor.

From what has already been stated, it will be readily seen that, in so far as regards fixed lights, which are required to illuminate the whole of the horizon with equal intensity, the dioptric light of Fresnel is a perfect instrument. But the case is otherwise as regards revolving lights, or those where the whole rays have to be concentrated into one or more beams of parallel rays. To revert to the parabolic reflector, it must be obvious (see fig. 1) that every ray which escapes past the lips of the reflector never reaches the eye of the mariner, while, if we return to the dioptric revolving light of Fresnel, we find that those rays which escape past the lens are acted on by two agents, both of which cause loss of light by absorption. The loss occasioned by the inclined mirrors (see fig. 2), and in passing through the pyramidal inclined lenses, was estimated by Fresnel himself at one-half of the whole incident rays. In order to avoid this loss of light, Mr Thomas Stevenson proposed, in 1849, to introduce an arrangement by which the use of one of these agents is avoided, and the employment of total reflection, which had been successfully employed by Fresnel for fixed lights, was introduced with great advantage for revolving lights.

'This effect may be produced by the combination

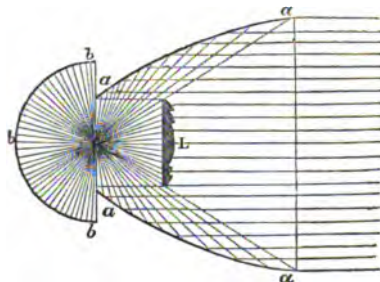

Fig. 5.

of an annular lens, *L* (fig. 5); a parabolic conoid, *a*, truncated at its parameter, or between that and its vertex; and a portion of a spherical mirror, *b*. The lens, when at its proper focal distance from the flame, subtends the same angle from it as the outer lips of the paraboloid, so that no ray of light coming from the front of the flame can escape being intercepted either by the paraboloid or the lens. The spherical reflector occupies the place of the parabolic conoid which has been cut off behind the parameter. The

which supply, though, of course, in an extremely imperfect way, the want of the light of the sun. The light-houses of the United Kingdom now number, with harbour-lights, upwards of 400 stations, and include some of the finest specimens of engineering, such as Smeaton's Eddystone, Robert Stevenson's Bell Rock, Alan Stevenson's Skerryvore, and James Walker's Bishop Rock. As information will be found under their respective heads regarding some of these interesting works, we shall restrict ourselves in the following short memoir to the internal economy of light-houses, and the most approved means of producing a powerful light for the use of the mariner.

Catoptric or Reflecting System.—So recently as the latter part of last century, the sea-lights of Britain consisted of open coal-fires; but this imperfect means of illumination was replaced by reflectors having lamps in their foci. At first, these instruments consisted of small facets of mirror-glass fixed in a mould by means of cement; but reflectors of copper-plate faced with silver, and hammered to the proper form, and carefully polished, were afterwards introduced. The parabolic form (see fig. 1), as is well known, is the most correct for reflecting the light proceeding from the focus and falling upon its

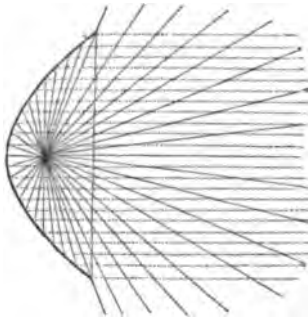

Fig. 1.

surface into one beam of parallel rays. When a series of such reflectors are arranged close to each other round a cylinder in a light-house, they illuminate constantly, though not with equal intensity, the whole horizon. As the property of the parabolic reflector is to collect the rays incident upon its surface into one beam of parallel rays, it would be absolutely impossible, were the flame from which the rays proceed a mathematical point, to produce a light which would illuminate the whole of the horizon, unless there were an infinite number of reflectors. But as the radiant, instead of being a mathematical point, is a physical object, consisting of a flame of very notable size, the rays which come from the outer portion of the luminous cone proceed, after reflection, in such divergent directions, as to render it practically possible to light up, though unequally, the whole horizon. The divergence produced in this way by a burner of one inch in diameter, with a focal distance of four inches, is in the horizontal plane about $14^{\circ} 22'$. The whole horizon may thus be illuminated by reflectors.

If, for the purpose of distinction, it is desired to shew a revolving light, then several of those reflectors are placed with their axes parallel to each other on each of the faces of a four-sided frame, which is made to revolve. In such a case, the mariner sees a light only at those times when one of the faces of the frame is directed towards him, but at all other times he is left in darkness. The rotation of the frame upon its axis thus produces

to his eye a succession of light and dark intervals, which enables him to distinguish it from the fixed light which is constantly in view in every azimuth. The distinction of a red light is best produced by using a chimney of red instead of white glass for each burner. The *flashing* or scintillating light, which is one of the most striking of all the distinctions, was first introduced by the late Mr Robert Stevenson, the engineer of the Northern Light-houses, in 1822, at Buchanness, in Aberdeenshire. The same engineer also introduced what has been called the *intermittent* light, by which a stationary frame with reflectors is instantaneously eclipsed, and is again as suddenly revealed to view by the vertical movement of opaque cylinders in front of the reflectors. The intermittent is distinguished from the revolving light, which also appears and disappears successively to the view, by the suddenness of the eclipses and of the reappearance, whereas in all revolving lights there is a gradual waxing and waning of the light.

Dioptric System.—Another method of bending the diverging rays proceeding from a lamp into such directions as shall be useful to the mariner, is that of *refraction*. If a flame be placed in the focus of a lens of the proper form, the diverging rays will be bent parallel to each other, so as to form a single solid beam of light. So early as 1759, a London optician proposed to grind the glass of the Eddystone Light-house to a lenticular form; but this proposal came to nothing, for the first light of the Eddystone consisted of a few wax-candles, placed upon a chandelier, without even so much as a reflector of any kind behind them. M. Augustin Fresnel was the first to propose and to introduce lenticular action into light-house illumination, by the adoption of the annular or built lens, which had been suggested as a burning instrument by Buffon and Condorcet. He also, in conjunction with Arago and Mathieu, used a large lamp having four concentric wicks. In order to produce a revolving light on the lenticular or dioptric system, a different arrangement was adopted from that which we have described for the catoptric system. The large lamp was now made a fixture, and four or more annular lenses were fitted together, so as to form a frame of glass which surrounded the lamp. When this frame is made to revolve round the lamp, the mariner gets the full effect of the lens whenever its axis is pointed towards him, but in all other positions there is darkness. In order to operate upon those rays of light which passed above the lens, a system of double optical agents was employed by Fresnel. These (see fig. 2) consisted of a pyramid of lenses, a , with mirrors, b , placed above at the proper angle for rendering the rays passing upwards parallel to those which came from the annular lens, L . But Fresnel did not stop here, for, in order to make the lenticular system suitable for fixed as well as revolving lights, he designed a new optical agent, to which the name of cylindrical refractor has been given. This consisted of cylindrical lenses, which were the solids that would be generated were the profile of an annular lens made to circulate round a vertical axis. The action of this instrument is obviously to allow the rays to spread naturally in the horizontal plane, while they suffer refraction in the vertical plane. The effect of this instrument is therefore to shew a light of equal intensity all round the horizon, and thus to form a better light than that which was formerly produced for fixed lights by parabolic reflection. It is obvious, however, from our description that the diverging rays which were not intercepted by this cylindrical hoop, or those which would have passed upwards and been uselessly expended in illuminating the clouds, or

LIGHT-HOUSE.

downwards in uselessly illuminating the light-room floor, were lost to the mariner; and in order to render these effective, Fresnel ultimately adopted the use of what has been called the internal or total reflection of glass; and here it is necessary to explain that one of the great advantages of the action by glass over reflection by metal is the smaller quantity of light that it absorbs. It has been ascertained that there is a gain of almost one-fourth ($\frac{1}{4}$) by employing glass prisms instead

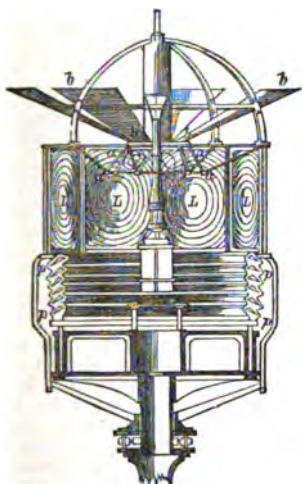

Fig. 2.

of metallic reflectors for light-house illumination. Fresnel introduced, above and below the cylindrical refracting hoop which we have described, certain separate glass prisms of triangular section, the first surface of each of which refracted to a certain extent any ray of light that fell upon it, while the second surface was placed at such an angle as to reflect, by what is called internal or total reflection, the ray which had before been refracted by the first surface; and the last or outer surface produced another refraction, which made the rays pass out parallel with those refracted by the central cylindrical hoop. The light falling above the cylindrical hoop was thus bent downwards, and that falling below was bent upwards, so as to be made horizontal and parallel with that proceeding from the hoop. Figs. 3 and 4 represent



Fig. 3.

in elevation and section this, which is the most perfect of Fresnel's inventions in light-house illumination, and when made of the rhomboidal form,

and used in connection with the diagonal framing introduced by Mr Alan Stevenson, it may be said

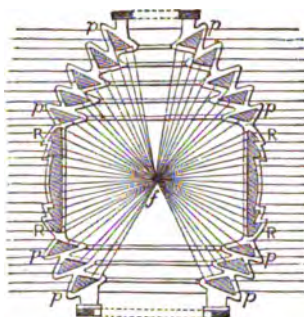

Fig. 4.

to be a perfect apparatus. In the figure, *p* shew the prisms and *R* the cylindrical refractor.

From what has already been stated, it will be readily seen that, in so far as regards fixed lights, which are required to illuminate the whole of the horizon with equal intensity, the dioptric light of Fresnel is a perfect instrument. But the case is otherwise as regards revolving lights, or those where the whole rays have to be concentrated into one or more beams of parallel rays. To revert to the parabolic reflector, it must be obvious (see fig. 1) that every ray which escapes past the lips of the reflector never reaches the eye of the mariner, while, if we return to the dioptric revolving light of Fresnel, we find that those rays which escape past the lens are acted on by two agents, both of which cause loss of light by absorption. The loss occasioned by the inclined mirrors (see fig. 2), and in passing through the pyramidal inclined lenses, was estimated by Fresnel himself at one-half of the whole incident rays. In order to avoid this loss of light, Mr Thomas Stevenson proposed, in 1849, to introduce an arrangement by which the use of one of these agents is avoided, and the employment of total reflection, which had been successfully employed by Fresnel for fixed lights, was introduced with great advantage for revolving lights.

'This effect may be produced by the combination

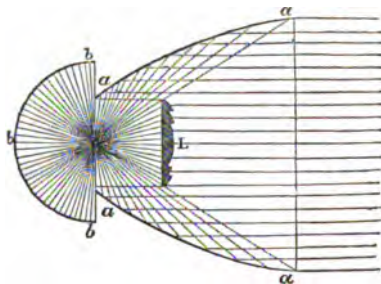

Fig. 5.

of an annular lens, *L* (fig. 5); a parabolic conoid, α , truncated at its parameter, or between that and its vertex; and a portion of a spherical mirror, *b*. The lens, when at its proper focal distance from the flame, subtends the same angle from it as the outer lips of the paraboloid, so that no ray of light coming from the front of the flame can escape being intercepted either by the paraboloid or the lens. The spherical reflector occupies the place of the parabolic conoid which has been cut off behind the parameter. The

flame is at once in the centre of the spherical mirror, and in the common focus of the lens and paraboloid. Let us now suppose, as represented in the figure, that the parabolic conoid is truncated at the parameter; the whole sphere of rays emanating from the flame may then be regarded as divided into two portions, viz., the hemisphere of front rays and the hemisphere of back rays. Part of the anterior hemisphere of rays is intercepted by the lens, and made parallel by its action, while the remainder is intercepted by the paraboloidal surface, and made parallel by its action. The rays forming the posterior hemisphere fall on the spherical mirror behind the flame, and are reflected forwards again, through the focus in the same lines, but in opposite directions to those in which they came, whence passing onwards, they are in part refracted by the lens, and the rest are made parallel by the paraboloid. The back rays thus finally emerge horizontally in union with the light from the anterior hemisphere. This instrument, therefore, fulfils the necessary conditions, by collecting the *entire sphere of diverging rays into one beam of parallel rays* without employing any unnecessary agents.

The description given above is for a metallic holophote; but where total reflection, or the most perfect system of illumination, is adopted, the front half of the rays is operated upon by totally reflecting prisms (*p, p*, fig. 6), similar in section to those

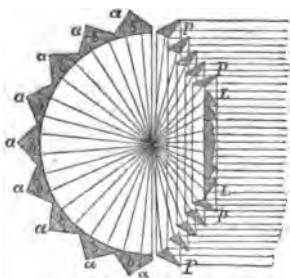

Fig. 6.

applied by Fresnel for fixed lights; but instead of being curvilinear in the horizontal plane only, they are also curvilinear in the vertical plane, and thus produce, in union with an annular lens, a beam of parallel rays, similar to what is effected by the parabolic mirror (fig. 1). The rays proceeding backwards fall upon prisms, *ab, ab*, which produce two total reflections upon each ray, and cause it to pass back through the flame, so as ultimately to fall in the proper direction upon the dioptric holophote in front, so that the whole of the light proceeding from the flame is thus ultimately parallelised by means of the smallest number and the best kinds of optical agents. It is a remarkable property of the spherical mirror, *ab*, that no ray passes through it, so that an observer standing behind the instrument perceives no light, though there is nothing between him and the flame but a screen of transparent glass.

Where the light is produced by a great central stationary burner, the apparatus assumes the form (fig. 7) of a polygonal frame, which circulates round the flame, and each face of which produces a beam of parallel rays. Hence, when the frame revolves with uniform rapidity round the central flame, the mariner is alternately illuminated and left in darkness, according as the axis of the holophotes is pointed towards him or from him. The difference between the revolving light of Fresnel and the holophotal light, as it has been termed, will

be readily seen by comparing fig. 7 and fig. 2, in the former of which, one agent is enabled to do the work of two agents in the latter, while total reflection, or that by which least light is lost, is substituted for metallic, by which one half of the whole incident rays are absorbed. The dioptric holophotal system, or that by which *total reflection is used as a portion of the revolving apparatus*, was first employed on a small scale in 1850 at the Horsburgh Light-house, and on the large scale in 1851, at North Ronaldshay in Orkney. Since that date, this system has been all but universally introduced into Europe and America.

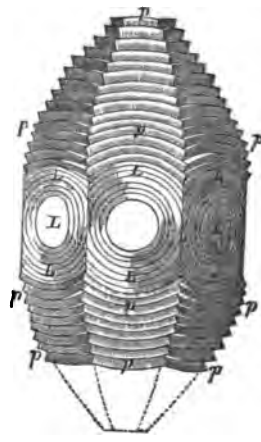

Fig. 7.

Azimuthal Condensing Light.—The above is a description of the general principles on which light-houses are illuminated. In placing a light in some situations, regard, however, must be had to the physical peculiarities of the locality; the following two plans of Mr Thomas Stevenson may be cited as examples. In fixed lights of the ordinary construction, the light is distributed, as already explained, equally all round the horizon, and is well adapted for a rock or island situated in the middle of the ocean. But where it is only necessary to illuminate a narrow sound (fig. 8), it is obvious that the

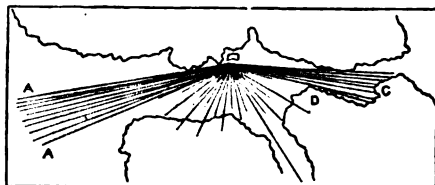

Fig. 8.

requirements are very different. On the side next the shore, no light is required at all; across the sound, a feeble light is all that is necessary, because the distance at which it has to be seen is small, owing to the narrowness of the channel; while up (DC) and down (AA) the sound, the sea to be illuminated is of greater or lesser extent, and requires a corresponding intensity. If the light were made sufficiently powerful to answer for the greater distance, it would be greatly too powerful for the shorter distance across the sound. Such an arrangement would occasion an unnecessary waste of oil, while the light that was cast on the landward side would be altogether useless. Fig. 9 represents (in plan) the condensing light, by which the light proceeding from the flame is allocated in the different azimuths in proportion to the distances at which the light requires to be seen by the mariner in those azimuths. Let us suppose that the rays marked α require to be seen at the greatest distance down the sound, and those marked β to a somewhat smaller distance up the sound. In order to strengthen those arcs, the spare light proceeding landwards, which would otherwise be lost, is intercepted by portions of holophotes, B

LIGHT-HOUSE.

and C, subtending spherical angles proportioned to the relative ranges and angular spaces of the arcs α and β . The portions of light thus intercepted

It has been called an apparent light, from its appearing to proceed from a flame on the rock, while the light in reality proceeds from the shore, about 650 feet distant, and is refracted by glass prisms placed on the beacon.

Sources of Light.—Drummond Light.—The descriptions which have already been given have all had reference to the best means of employing a given light. Many attempts have from time to time been made to increase the power of the radiant itself—such as combustion of the limeball, when exposed to a flow of oxygen and hydrogen gas. When this source of light is placed in the focus of a parabola, as was proposed by Lieutenant Drummond, a very intense beam of parallel rays is produced. The difficulty of maintaining continuous combustion has hitherto prevented its adoption in light-houses, although recent improvements have rendered this method more feasible than formerly.

Magneto-electric Light.—The electric light discovered by Dr Faraday, and recently adapted to light-house purposes by Professor Holmes, has lately undergone careful trials, under the auspices of the Trinity House of London. Although it is understood that sanguine hopes are entertained of its being rendered practically efficient, it has not yet been brought to that state of perfection which would warrant its general adoption.

Gas.—The uncertainty and other objections attending the manufacture and use of gas in remote and inaccessible places, have as yet prevented its adoption at light-house stations, but it has been successfully used at many harbour-lights.

Oil.—The oil which is now employed in Great Britain is that which goes by the name of *colza*, and the quantities annually consumed by the Northern Light-houses may be stated at 40 gallons for an argand one inch in diameter, and 800 gallons for the four-wick burner, which is used in dioptric lights of the first order.

Visibility of Lights.—The distance at which any light can be seen, of course depends on the height of the tower, and varies with the state of the atmosphere. The greatest recorded distance at which an oil-light has been visible is that of the holophotal light of Allepey at Travancore, which has been seen from an elevated situation at a distance of 45 miles. The holophotal revolving light at Baccalieu, in Newfoundland, is seen every night in clear weather at Cape Spear—a distance of 40 nautical miles.

Power of Light-house Apparatus.—The reflector (25 inches diameter) used in the Northern Light-houses, with a burner of one inch diameter, has been estimated as being equal to about 360 argand flames. The cylindric refractor, used in fixed lights, with a 4-wick burner, has in like manner been estimated at 250; while the annular lens employed in revolving lights, with the same burner, is equal to about 3000 argand flames.

Administration.—The light-houses of the United Kingdom are managed by the three following boards: viz., the English, by the Trinity House of London; the Scotch, by the Commissioners of Northern Light-houses; and the Irish, by the Ballast Board of Dublin. The Merchant Shipping Act of 1854 provides that the Scotch and Irish boards shall receive the sanction of the Trinity House before the erection of new light-houses; while all the three must receive the sanction of the Board of Trade both as to new lights and the expenditure of their funds, the source of which is a passing toll on the shipping.

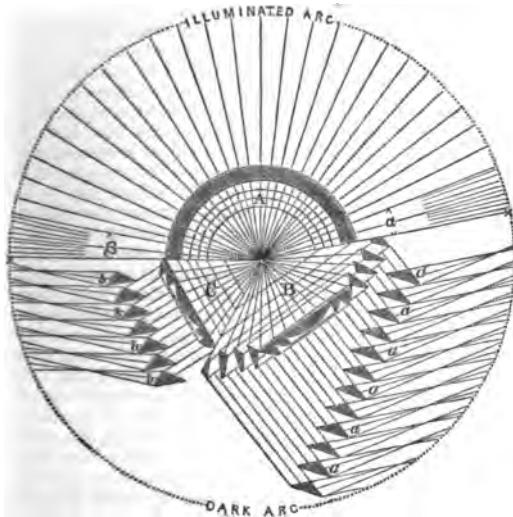

Fig. 9.

are parallelised by the holophotes, and fall upon the prisms a, a , and b, b , respectively, which again refract them in the horizontal plane only; and, after passing through focal points (independent for each prism), they emerge in separate equal beams, and diverge through the same angles as α and β respectively. In this way, the light proceeding up and down the sound is strengthened in the required ratio by utilising in the manner we have described the light, which would otherwise have been lost on the land. These instruments were first introduced at three sound lights in the west of Scotland, in 1857, where apparatus of a small size, combined with a small burner, was found to produce in the only directions in which great power was required, beams of light equal to the largest class of apparatus and burner. The saving thus effected in oil, &c., has been estimated at about £400 or £500 per annum.

Apparent Light.—At Stornoway Bay, the position of a sunk rock has been sufficiently indicated by means of a beam of parallel rays thrown from the shore upon certain optical apparatus fixed in the top of a beacon erected upon the rock itself. By

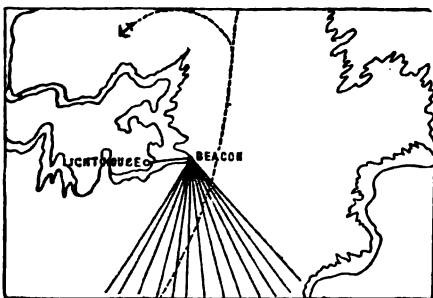

Fig. 10.

means of this plan (vide fig. 10), the expense of erecting a light-house on the rock itself has been saved, and all the purposes of the mariner served.

LIGHTNING (Fr. *éclair*, Ger. *Blitz*), the name given to the sudden discharge of electricity between one group of clouds and another, or between the clouds and the ground. It is essentially the same, though on a much grander scale, as the spark obtained from an electric machine. Clouds charged with electricity are called thunder-clouds, and are easily known by their peculiarly dark and dense appearance. The height of thunder-clouds is very various: sometimes they have been seen as high as 25,700 feet, and a thunder-cloud is recorded whose height was only 89 feet above the ground. According to Arago, there are three kinds of lightning, which he names lightning of the first, second, and third classes. Lightning of the first class is familiarly known as forked-lightning (Fr. *éclair en zig-zag*). It appears as a broken line of light, dense, thin, and well defined at the edges. Occasionally, when darting between the clouds and the earth, it breaks up near the latter into one or two forks, and is then called bifurcate or trifurcate. The terminations of these branches are sometimes several thousand feet from each other. On several occasions, the length of forked-lightning has been tried to be got at trigonometrically, and the result gave a length of several miles. Lightning of the second class is what is commonly called sheet-lightning (Ger. *Flachenblitz*). It has no definite form, but seems to be a great mass of light. It has not the intensity of lightning of the first class. Sometimes it is tinged decidedly red, at other times, blue or violet. When it occurs behind a cloud, it lights up its outline only. Occasionally, it illumines the world of clouds, and appears to come forth from the heart of them. Sheet-lightning is very much more frequent than forked-lightning. Lightning of the third kind is called ball-lightning (Fr. *globes de feu*, Ger. *Kugelblitz*). This so-called lightning describes, perhaps, more a meteor, which, on rare occasions, accompanies electric discharge, or lightning proper, than a phenomenon in itself electrical. It is said to occur in this way: After a violent explosion of lightning, a ball is seen to proceed from the region of the explosion, and to make its way to the earth in a curved line like a bomb. When it reaches the ground, it either splits up at once, and disappears, or it rebounds like an elastic ball several times before doing so. It is described as being very dangerous, readily setting fire to the building on which it alights; and a lightning-conductor is no protection against it. Ball-lightning lasts for several seconds, and, in this respect, differs very widely from lightning of the first and second classes, which are, in the strictest sense, momentary.

The thunder (Fr. *tonnerre*, Ger. *Donner*) which accompanies lightning, as well as the snap attending the electric spark, has not yet been satisfactorily accounted for. Both, no doubt, arise from a commotion of the air brought about by the passage of electricity; but it is difficult to understand how it takes place. Suppose this difficulty cleared, there still remains the prolonged rolling of the thunder, and its strange rising and falling to account for. The echoes sent between the clouds and the earth, or between objects on the earth's surface, may explain this to some extent, but not fully. A person in the immediate neighbourhood of a flash of lightning hears only one sharp report, which is peculiarly sharp when an object is struck by it. A person at a distance hears the same report as a prolonged peal, and persons in different situations hear it each in a different way. This may be so far explained. The path of the lightning may be reckoned at one or two miles in length, and each point of the path is the origin of a separate sound. Suppose, for the sake of simplicity, that the path is a straight line, a person at the extremity of this line must hear a prolonged report;

for though the sound originating at each point of the path is produced at the same instant, it is some time before the sound coming from the more distant points of the line reaches the ear. A person near the middle of the line hears the whole less prolonged, because he is more equidistant from the different parts of it. Each listener in this way hears a different peal, according to the position he stands in with reference to the line. On this supposition, however, thunder ought to begin at its loudest, and gradually die away, because the sound comes first from the nearest points, and then from points more and more distant. Such, however, it is well known, is not the case. Distant thunder at the beginning is just audible, and no more; then it gradually swells into a crashing sound, and again grows fainter, till it ceases. The rise and fall are not continuous, for the whole peal appears to be made up of several successive peals, which rise and fall as the whole. Some have attempted to account for this modulation from the forked form of the lightning, which makes so many different centres of sound, at different angles with each other, the waves coming from which interfere with each other, at one time moving in opposite directions, and obliterating the sound, at another in the same way, and then strengthening the sound, produced by each. Thunder has never been heard more than 14 miles from the flash. The report of artillery has been heard at much greater distances. It is said that during the cannonading at the battle of Waterloo was heard at the town of Creil, in the north of France, about 115 miles from the field.

LIGHTNING-CONDUCTOR (Fr. *paratonnerre*, Ger. *Blitzableiter*). The principle of the lightning-conductor is, that electricity, of two conducting passages, selects the better; and that when it has got a sufficient conducting passage, it is disarmed of all destructive energy. If a person holds his hand near the prime conductor of a powerful electric machine in action, he receives long forked stinging sparks, each of which causes a very sensible convulsion in his frame. But if he holds in his hand a ball, connected with the ground by a wire or chain, the above sensation is scarcely, if at all, felt, as each spark occurs, for the electricity, now having the ball and wire passage to the ground, prefers it to the less conducting body. If, instead of a ball, a pointed rod were used, no sparks would pass, and no sensation whatever would be felt. The point silently discharges the prime conductor, and does not allow the electricity to accumulate in it so as to produce a spark; and the quantity passing at a time, even supposing the rod disconnected with the ground, is not sufficient to affect the nerves. If, for the prime conductor of the machine, we substitute the thunder-clouds; for the body, a building; for the convulsive sensation, as the evidence of electric power, heating and other destructive effects; for the ball, or rod, and wire, the lightning-conductor, we have the same conditions exhibited on a larger natural scale. It is easier, however, to protect a building from the attacks of lightning than the body from the electric spark, as the rod in the one case is a much better conductor, compared with the building, than it is compared with the body, and, in consequence, more easily diverts the electricity into it.

The lightning-conductor consists of three parts: the rod, or part overtopping the building; the conductor, or part connecting the rod with the ground; and the part in the ground. The rod is made of a pyramidal or conical form (the latter being preferable), from 8 to 30 feet in height, securely fixed to the roof or highest part of the building. Gay-Lussac proposes that this rod should consist, for the greater part of its length below, of

iron; that it should then be surmounted by a short sharp cone of brass; and that it should finally end in a fine platinum needle; the whole being riveted or soldered together, so as to render perfect the conducting connection of the parts. The difficulty of constructing such a rod has led generally to the adoption of simple rods of iron or copper, whose points are gilt, to keep them from becoming blunt by oxidation. It is of the utmost importance that the upper extremity of the rod should end in a sharp point, because the sharper the point the more is the electrical action of the conductor limited to the point, and diverted from the rest of the conductor. There is thus less danger of the electricity sparking from the conductor at the side of the building into the building itself. Were the quantity of the electricity of the clouds not so enormous, the pointed rod would prevent a lightning-discharge altogether; but even as it is, the violence of the lightning-discharge is considerably lessened by the silent discharging-power of the point previously taking place. According to Eisenlohr, a conical rod, 8 feet in height, ought to have a diameter at its base of 13.3 lines, and one of 30 feet a diameter of 26.6 lines.

The part of the lightning-conductor forming the connection between the rod and the ground, is generally a prismatic or cylindrical rod of iron (the latter being preferable), or a strap of copper; sometimes a rope of iron or copper wire is used. Iron wire improves as a conductor when electric currents pass through it; copper wire, in the same circumstances, becomes brittle. An iron rope is much better, therefore, for conducting than a copper one. Galvanised iron is, of all materials, the best for conductors. The conducting-rod ought to be properly connected with the conical rod either by riveting or soldering or both. Here, as at every point of juncture, the utmost care must be taken that there is no break in the conduction. The conducting-rod is led along the roof, and down the outside of the walls, and is kept in its position by holdfasts fixed in the building. There must be no sharp turns in it, but each bend must be made as round as possible. Considerable discussion has arisen as to the proper thickness for the conducting-rod. If it were too small, it would only conduct part of the electricity, and leave the building to conduct the rest, and it might be melted by the electricity endeavouring to force a passage through it as an insufficient conductor. The Paris Commission, which sat in 1823, gave the minimum section of an iron conductor as a square of 15 millimètres (about $\frac{1}{4}$ ths of an inch) in side, and this they considered quite sufficient in all circumstances. A rod of copper would need to be only $\frac{1}{4}$ ths of this, as copper conducts electricity about six times more readily than iron. This calculation is very generally followed in practice. In leading the conductor along the building, it should be kept as much apart as possible from masses of conducting matter about the building, such as iron beams, machinery, &c. These may form a broken chain of conductors communicating with the ground, and divert a portion of the electricity from the lightning-conductor. If such took place, then at each interruption electricity would pass in a visible and dangerous way, and the efficacy of the conductor would be lost. If the conductor cannot be properly insulated from these masses of metal, the necessary security is got by putting them in connection with the conductor, so as to form a part of it. Water-runs, leaden roofs, and the like, must, for this reason, all be placed in conducting connection with the conductor.

The portion of the lightning-conductor which is placed in the ground is no less worthy of attention

than the other two. Should the lower part of the conductor end in dry earth, it is worse than useless, for when the lightning, attracted by the prominence and point of the upper rod, strikes it, it finds, in all likelihood, no passage through the unconducting dry earth, and, in consequence, strikes off to a part of the ground where it may easily disperse itself and be lost. Wherever it is practicable, a lightning-conductor should end in a well or large body of water. Water is a good conductor, and having various ramifications in the soil, offers the best facility to the electricity to become dispersed and harmless in the ground. The rod, on reaching the ground, should be led down a foot and a half, or two feet, into the soil, and then turned away at right angles to the wall from the building in a horizontal drain filled with charcoal, for about from 12 to 16 feet, and then turned into the well so far that its termination is little likely to be left dry. Where a well cannot be made, a hole 6 inches wide (wider, if possible) should be bored, from 9 to 16 feet, the rod placed in the middle of it, and the intervening space closely packed with freshly heated charcoal. The charcoal serves the double purpose of keeping the iron from rusting, and of leading away the electricity from the rod into the ground.

Lightning-conductors, when constructed with care, have been proved beyond a doubt to be a sufficient protection from the ravages of lightning. The circle within which a lightning-conductor is found to be efficacious, is very limited. Its radius is generally assumed to be twice the height of the rod. On large buildings, it is therefore necessary to have several rods, one on each prominent part of the building, all being connected so as to form one conducting system. In ships, a rod is placed on every mast, and their connection with the sea is established by strips of copper inlaid in the masts, and attached below to the metal of or about the keel.

LIGHTNING-PRINTS are appearances sometimes found on the skin or clothing of men or animals that are either struck by lightning, or are in the vicinity of the stroke, and currently believed to be photographic representations of surrounding objects or scenery. The existence of such prints appears, from a theoretical point of view, highly improbable, as the essential conditions of forming a photographic image are wanting; still, several apparently well-authenticated instances have been recorded, which have led scientific authorities to give at least partial credence to them. One or two instances may serve to give a general idea of what are meant by lightning-prints. At Candelaria (Cuba), in 1828, a young man was struck dead by lightning near a house, on one of the windows of which was nailed a horse-shoe; and the image of the horse-shoe was said to be distinctly printed upon the neck of the young man beneath the right ear. On the 14th of November 1830, lightning struck the Château of Benattonnière, in La Vendée; at the time, a lady happened to be seated on a chair in the salon, and on the back of her dress were printed minutely the ornaments on the back of the chair. In September 1857, a peasant-girl, while herding a cow in the department of Seine-et-Marne, was overtaken by a thunder-storm. She took refuge under a tree; and the tree, the cow, and herself were struck with lightning. The cow was killed, but she recovered, and on loosening her dress for the sake of respiring freely, she saw a picture of the cow upon her breast. These anecdotes are typical of a great mass of others. They tell of metallic objects printed on the skin; of clothes, while being worn, receiving impressions of neighbouring objects; or of the skin

being pictured with surrounding scenery or objects, during thunder-storms. One object very generally spoken of as being printed is a neighbouring tree. This may be accounted for by supposing that the lightning-discharge has taken place on the skin in the form of the electric brush (see ELECTRICITY), which has the strongest possible resemblance to a tree, and that this being in some way or other imprinted on the skin, has led observers to confound it with a neighbouring tree. Of other prints, it would be difficult to give a satisfactory account. However, observers have done something in imitation of them. It has been shewn, for instance, by German observers, that when a coin is placed on glass, and a stream of sparks poured on it from a powerful electrical machine, on the glass being breathed upon, after its removal, a distinct image of the coin is traced out by the dew of the breath. Mr Tomlinson, by interposing a pane of glass between the knob of a charged Leyden jar and that of the discharging-tongs, obtained a perfect *breath-figure* of the discharge on each side of the glass, which bore the most striking resemblance to a tree. With all due allowance for the probable printing-power of lightning, the accounts given of it, in most cases, bear the stamp of exaggeration; and such of them as have been inquired into have been found to dwindle to a very small residuum of fact, in which there remained little that was wonderful.

LIGHTS, USE OF, IN PUBLIC WORSHIP, a practice which prevailed in the Jewish (Exodus xxv. 31—39) and in most of the ancient religions, and which is retained both in the Roman and in the Oriental churches. The use of lights in the night-services, and in subterranean churches, such as those of the early Christians in the catacombs, is of course easily intelligible; but the practice, as bearing also a symbolical allusion to the 'Light of the World' and to the 'Light of Faith,' was not confined to occasions of necessity, but appears to have been from an early time an accompaniment of Christian worship, especially in connection with the sacraments of baptism and the eucharist. The time of the service in which lights are used has varied very much in different ages. St Jerome speaks of it only during the reading of the gospel; Amalarius, from the beginning of the mass till the end of the gospel; Isidore of Seville, from the gospel to the end of the canon; and eventually it was extended to the entire time of the mass. In other services, also, lights have been used from an early period. Lighted tapers were placed in the hand of the newly baptised, which St Gregory Nazianzen interprets as emblems of future glory. Indeed, in the Roman Catholic Church, the most profuse use of lights is reserved for the services connected with that sacrament. The usage of blessing the Paschal Light is described elsewhere. See HOLY WEEK. The material used or lights in churches is either oil or wax, the latter in penitential time, and in services for the dead, being of a yellow colour. In the Anglican Church, candlesticks, and in some instances candles themselves, are retained in many churches, on the communion table, but they are not lighted. The retention of them is greatly favoured by the 'High Church' party, and much disapproved by the 'Low Church' or 'Evangelical' party. In the Presbyterian and Independent churches of Britain, America, &c., the symbolical use of lights and candlesticks is rejected as superstitious.

LIGNINE (derived from the Latin word *lignum*, wood) is the incrusting matter contained within the cellular tissue, which gives hardness to wood. Like cellulose, of which the cellular tissue is composed, it

is insoluble in water, alcohol, ether, and dilute acids, and its chief chemical characteristic is, that it is more readily soluble in alkaline liquids than cellulose. Its exact composition is uncertain, but it is known to consist of carbon, hydrogen, and oxygen, and to differ in its composition from cellulose in containing a greater percentage of hydrogen than is necessary to form water with its oxygen. When submitted to destructive distillation, it yields acetic acid; and that it is the source of the pyroligneous acid (which is merely crude acetic acid) obtained by the destructive distillation of wood, is proved by the fact, that the hardest woods (those, namely, which contain the greatest proportion of lignine) yield the largest amount of acid. Lignine is identical with the *matière incrustante* of Psen and other French botanists.

LIGNITE, fossil wood imperfectly mineralised, and retaining its original form and structure much more completely than the truly mineral coals, and therefore not improperly described as intermediate between peat and coal. *Brown coal*, *Surturbrand*, and *Jet*, are generally regarded as varieties of lignite. The fossil plants of lignite are always terrestrial; palms and coniferous trees are amongst them. Remains of terrestrial mammalia are also found in it.

LIGNUM RHODIUM, a kind of wood which occurs as an article of commerce, having a pleasant smell resembling the smell of roses. It is brought to Europe in strong, thick, and rather heavy pieces, which are cylindrical but knotty, and sometimes split. They are externally covered with a cracked gray bark; internally, they are yellowish, and often reddish in the heart. They have an aromatic bitterish taste, and, when rubbed, emit an agreeable rose-like smell. This wood comes from the Canary Islands, and is produced by two shrubby and erect species of *Convolvulus*, with small leaves, *C. scoparius* and *C. floridus*. It is the wood both of the root and of the stem, but the latter is rather inferior. An essential oil (*Oil of L. R.*), having a strong smell, is obtained from it by distillation, and is used for salves, embrocations, &c., and also very frequently for adulteration of oil of roses.—Besides this L. R. of the Canary Islands, an American kind is also a common article of commerce; it is produced by the *Amyris balsamifera*, a native of Jamaica, and yields an essential oil, very similar to the former. The L. R. of the Levant is now scarcely to be met with in commerce. It is the produce of *Liquidambar Orientale*. From this, however, the name has been transferred to the other kinds.

LIGNUM-VITÆ, the wood of *Guaicum officinale* (nat. ord. *Zygophyllaceæ*), and probably of some other species, natives of Jamaica and St Domingo. The hardness and exceeding toughness of this very useful wood was shewn by Professor Voigt to depend upon a very peculiar interlacing of the fibres. The heart-wood, which is the part used, is very dense and heavy, of a dark, greenish-brown colour, rarely more than 8 inches in diameter; the stem itself seldom reaches 18 inches in diameter, and grows to the height of about 30 feet. The wood is much valued for making the wheels of pulleys and other small articles in which hardness and toughness are required; large quantities are consumed in making the sheaves (see PULLEY) of ships' blocks. Besides these uses, the wood, when reduced to fine shavings or raspings, the bark, and also a greenish resin which exudes from the stem, are much used in medicine, being regarded as having powerful anti-syphilitic and anti-rheumatic properties. See QUALACUM.

LIGNY, a village in Belgium, in the province of Namur, about 10 miles north-east of Charleroi, famous on account of the battle fought here by the French, under Napoleon, and the Prussians, under Blücher, 16th June 1815, the same day on which the French, under Marshal Ney, were engaged with the British, under Wellington, at Quatre-Bras. Napoleon had formed a plan for overpowering his antagonists in detail ere they could concentrate their forces; and contrary to the expectations both of Wellington and Blücher, began his operations by assailing the Prussians. The battle took place in the afternoon. The possession of the villages of L. and St Amand was hotly contested; but the Prussians were at last compelled to give way. The Prussians lost in this battle 12,000 men and 21 cannon; the French, 7000 men. A mistake prevented a corps of the French army, under Erlon, from taking the part assigned to it in the battle, and led to Ney's encountering the Belgians and British at Quatre-Bras (q. v.), instead of uniting his forces with those engaged against the Prussians at Ligny.

LIGULATE (Lat. *ligula*, a little tongue), a term used in Botany to describe a corolla of one petal split on one side, and spread out in the form of a tongue or strap, toothed at the extremity. This form of corolla is very common in the *Compositæ*, appearing in all the florets of some, as the dandelion, and only in the florets of the *ray* of others, as the daisy and aster. The term, however, is of general application.

LIGULE. See GRASSES.

LIGUORI, ALFONZO MARIA DE, a saint of the Roman Catholic Church, and founder of the order of Liguorians or Redemptorists. He was born of a noble family at Naples, 27th September 1696, and embraced the profession of the law, which, however, he suddenly relinquished for the purpose of devoting himself entirely to a religious life. He received priest's orders in 1725; and in 1732, in conjunction with twelve companions, founded the association which is now called by his name. See LIGUORIANS. In 1762, he was appointed bishop of Sant' Agata dei Goti, in the kingdom of Naples, and his life as a bishop is confessed by Protestant as well as Catholic historians to have been a model of the pastoral character; but shrinking from the responsibilities of such an office, he resigned his see in 1775, after which date he returned to his order, and continued to live in the same simple austerity which had characterised his early life. Having survived his retirement twelve years, he died at Nocera dei Pagani, August 1, 1787, and was solemnly canonised in the Roman Catholic Church in 1839. L. is one of the most voluminous and most popular of modern Catholic theological writers. His works, which extend to seventy volumes 8vo, embrace almost every department of theological learning, divinity, casuistry, exegesis, history, canon law, hagiography, asceticism, and even poetry. His correspondence also is voluminous, but is almost entirely on spiritual subjects. The principles of casuistry explained by L. have been received with much favour in the modern Roman schools; and in that church his moral theology, which is a modification of the so-called 'probabilistic system' of the age immediately before his own, is largely used in the direction of consciences. See PROBABILISM. It would be out of place here to enter into a discussion of the exceptions which have been taken to certain portions of it on the score of morality, whether in reference to the virtue of chastity or to that of justice and of veracity. These objections apply equally to most of the casuists, and have often

been the subject of controversy. L.'s *Theologia Moralis* (8 vols. 8vo) has been reprinted numberless times, as also most of his ascetic works. The most complete edition of his works (in Italian and Latin) is that of Monza, 70 volumes. They have been translated entire into French and German, and in great part into English, Spanish, Polish, and other European languages.

LIGUORIANS, called also REDEMPTORISTS, a congregation of missionary priests founded by Liguori in 1732, and approved by Pope Benedict XIV. in 1759. Their object is the religious instruction of the people and the reform of public morality, by periodically visiting, preaching, and hearing confessions, with the consent and under the direction of the parish clergy. Their instructions are ordered to be of the plainest and most simple character, and their ministrations are entirely without pomp or ceremonial. The congregation was founded originally in Naples, but it afterwards extended to Germany and Switzerland. In the Austrian provinces they had several houses, and were by some represented as but establishments of the suppressed Jesuits under another name. Nothing, however, could be more different than the constitution and the objects of the two orders. Since the Restoration, and especially since the Revolution of 1830, the L. have effected an entrance into France, and several houses of the congregation have been founded in England, Ireland, and America; but their place is in great measure occupied by the more active congregation of the Lazarist or Vincentian Fathers, whose objects are substantially the same, and who are much more widely spread. See VINCENT DE PAUL, and VINCENTIAN CONGREGATION.

LIGURIAN REPUBLIC, the name given to the republic of Genoa in 1797, when, in consequence of the conquests of Bonaparte in Italy, it was obliged to exchange its aristocratic for a democratic constitution. See GENOA. The name was chosen because the Genoese territory formed the principal part of ancient Liguria.

LILAC (*Syringa*), a genus of plants belonging to the natural order *Oleaceæ*, and consisting of shrubs and small trees, with 4-cleft corolla, 2 stamens, and a 2-celled, 2-valvular capsule. The COMMON LILAC (*S. vulgaris*) is one of the most common ornamental shrubs cultivated in Europe and North America. It is a native of the north of Persia, and was first brought to Vienna by Busbecq, the ambassador of Ferdinand I., to whom we also owe the introduction of the tulip into European gardens. From Vienna it soon spread, so that it is now to be found half wild in the hedges of some parts of Europe. There are many varieties. The flowers grow in large conical panicles; are of a bluish 'lilac' colour, purple or white, and have a very delicious odour. The leaves are a favourite food of cantharides. The bitter extract of the unripe capsules has very marked tonic and febrifugal properties. The wood is fine-grained, and is used for inlaying, turning, and the making of small articles. A fragrant oil can be obtained from it by distillation. The CHINESE LILAC (*S. Chinensis*) has larger flowers, but with less powerful odour, and the PERSIAN LILAC (*S. Persica*) has narrower leaves. Both are often planted in gardens and pleasure-grounds. There are several other species.

LILIA'CEÆ, a natural order of endogenous plants, containing about 1200 known species. They are most numerous in the warmer parts of the temperate zones. They are mostly herbaceous plants, with bulbous or tuberous, sometimes fibrous roots;

rarely shrubs or trees. The shrubby and arborescent species are mostly tropical. The stem is simple, or branching towards the top, leafless or leafy. The branches are simple, generally narrow, sometimes cylindrical, sometimes fistular. The flowers are generally large, with 6-cleft or 6-toothed perianth; and grow singly or in spikes, racemes, umbels, heads, or panicles. The stamens are six, opposite to the segments of the perianth; the pistil has a superior 3-celled, many-seeded ovary, and a single style. The fruit is succulent or capsular; the seeds packed one upon another in two rows. This order contains many of our finest garden, green-house, and hot-house flowers, as lilies, tulips, dog's-tooth violet, lily of the valley, tuberose, crown imperial and other fritillaries, hyacinths, *Gloriosa superba*; many species useful for food, as garlic, onion, leek, and other species of *Allium*, *Asparagus*, the Quamaash or Biscuit Root (*Camassia esculenta*) of North America, the Ti (*Dracena terminalis* or *Cordylone Ti*) of the South Seas, &c.; many species valuable in medicine, as squill, aloe, &c.; and some valuable for the fibre which their leaves yield, as New Zealand Flax, and the species of Bowstring Hemp or *Sansevieria*.—This natural order has been the subject of a number of splendid works, among which may be particularly named Redoute's *Les Liliacées* (8 vols. Paris, 1802—1816).

LILLE (formerly L'ISLE, 'the island;' Flemish, *Ryssel*), an important manufacturing town and fortress in the north of France, chief town of the department du Nord, is situated on the Deule, in a level, fertile district, 140 miles north-north-east of Paris, and 62 miles south-east of Calais. The streets are wide, the squares imposing, and the houses, which are mostly in the modern style, well built. The principal buildings and institutions are the Medical School, the Lyceum, the Bourse, and the palace of Richebourg, now the Hôtel-de-Ville, in which is the school of art, with a famous collection of drawings by Raphael, Michael, and other masters. L. derives its name from that of the castle around which the town originally arose, and which from its position in the midst of marshes was called Isla. It was founded in 1007 by Baldwin, the fourth Count of Flanders, and has suffered greatly from frequent sieges. Of these, the most recent, and perhaps the most severe, took place in 1708 and 1792. On the former occasion, during the war of the Spanish Succession, the garrison capitulated to the allies, after a bombardment of 120 days; on the latter, the Austrians, after a terrific bombardment, were obliged to raise the siege. L. is the head-quarters of the third military division. It is also the seat of extensive and thriving manufactures. The goods principally manufactured are linen, hosiery, gloves, blankets, lace, and tulle. The town contains many spinning-mills, bleach-fields, sugar-refineries, distilleries, tanneries, dye-houses, &c. In the vicinity are numerous oil-mills, porcelain-factories, and glass and pottery works. Pop. 131,827.

LILLIPUT, the name of a fabulous kingdom described by Swift in *Gulliver's Travels*, of which the inhabitants are not greater in size than an ordinary man's finger. The term Lilliputian has come into common use as a designation of anything very diminutive.

LILLY, WILLIAM, an English astrologer, born at Diseworth, in Leicestershire, in 1602. Whilst yet a young man, he was employed as book-keeper by a merchant in London, who could not write, and on his employer's death, married his widow, with whom he obtained a fortune of £1000 sterling. He betook himself to the study of astrology, particu-

larly the *Ars Notoria* of Cornelius Agrippa, and soon acquired a considerable fame as a caster of nativities, and a predictor of future events. In 1634, he is said to have obtained permission from the Dean of Westminster to search for hidden treasure in Westminster Abbey, but was driven from his midnight work by a storm, which he ascribed to hellish powers. From 1644 till his death, he annually issued his *Merlinus Anglicus Junior*, containing vaticinations, to which no small importance was attached by many. In the Civil War, he attached himself to the parliamentary party, and was actually sent in 1648, with another astrologer, to the camp at Colchester, to encourage the troops, which service he performed so well that he received a pension for it, which, however, he only retained two years. Nevertheless, he made a small fortune by his 'art' during the Commonwealth, and was able to purchase an estate. After the Restoration, he was for some time imprisoned, on the supposition that he was acquainted with the secrets of the Republicans; but being set free, he retired to the country. He was again apprehended on suspicion of knowing something of the causes of the great fire of London in 1666. He died, 9th June 1681, at his estate at Hersham. L. wrote nearly a score of works on his favourite subject. They are of no value whatever, except to illustrate the credulity or knavery of their author.

LILY, a genus of plants of the natural order *Liliaceæ*, containing a number of species much prized for the size and beauty of their flowers. The perianth is bell-shaped, and its segments are often bent back at the extremity. The root is a scaly bulb, the stem herbaceous and simple, often several feet high, bearing the flowers near its summit.—The **WHITE LILY** (*L. candidum*), a native of the Levant, has been long cultivated in gardens, and much sung by poets. It has large, erect, pure white flowers, as much prized for their fragrance as for their beauty.—The **Orange Lily** (*L. bulbiferum*), a native of the south of Europe, with large, erect, orange-coloured flowers, is a well-known and very showy ornament of the flower-garden.—The **Martagon** or **Turk's Cup Lily** (*L. Martagon*), a native of the south of Europe, and allied species with verticillate leaves and drooping flowers, are also common in gardens. The **Tiger Lily** (*L. tigrinum*) is a native of China, remarkable for the axillary buds on the stem; and some very fine species are natives of North America, as *L. superbum*, which grows in marshes in the United States, has a stem 6—8 feet high, and reflexed orange flowers, spotted with black; *L. Canadense*, &c. Several very fine species have been introduced from Japan, as *L. Japonicum*, *L. speciosum*, and *L. lancifolium*.—The bulbs of *L. Pomponium*, *L. Martagon*, and *L. Kamtschacense*, are roasted and eaten in Siberia. That of *L. candidum* loses its acidity by drying, roasting, or boiling; when cooked, it is viscid, pulpy, and sugary, and is eaten in some parts of the East.—Lilies are generally propagated by offset bulbs. A single scale of the bulb will, however, suffice to produce a new plant, or even part of a scale, of which skilful gardeners avail themselves.—The name lily is often popularly extended to flowers of other genera of the same order, and even of allied orders.

LILY, GIGANTIC (*Doryanthes excelsa*), of Australia, a plant of the natural order *Amaryllidææ*, with flowering stem 10 or 14, sometimes 20 feet high, bearing at top a cluster of large crimson blossoms. The stem is leafy, but the largest leaves are near the root. This plant is found both on the mountains

LILY OF THE VALLEY—LIMBURG.

and the sea-coast of New South Wales. It is of splendid beauty. The fibre of its leaves has



Lily-Tree (*Doryanthes excelsa*).

been found excellent for ropes and for textile fabrics.

LILY OF THE VALLEY (*Convallaria*), a genus of plants of the natural order *Liliaceae*, having terminal racemes of flowers; a white, bell-shaped, or tubular 6-cleft or 6-toothed perianth; a 3-celled germen, with two ovules in each cell, and a succulent fruit.—The species commonly known as the Lily of the Valley (*C. majalis*), the *Maiblume* or *Mayflower* of the Germans, grows in bushy places



Lily of the Valley (*C. majalis*).

and woods in Europe, the North of Asia, and North America, and has a leafless scape, with a raceme of small flowers turned to one side. It is a universal favourite, on account of its pleasing appearance, the fragrance of its flowers, and the early season at which they appear. It is therefore very often cultivated in gardens, and forced to earlier flowering in hothouses. Varieties are in cultivation with red, variegated, and double flowers. The berries, the root, and the flowers have a nauseous, bitter, and somewhat acrid taste, and purgative and diuretic effects. The smell of the flowers when in large quantity, and in a close apartment, is narcotic. Dried and powdered, they become a sternutatory. The esteemed *Eau d'or* of the French is a water distilled from the flowers.—Allied to Lily of the Valley is **SOLOMON'S SEAL** (q. v.).

LIMA, the capital of the republic of Peru, stands on the Rimac, from whose name its own is

corrupted, in lat. 12° 3' S., and long. 77° 5' W. It is six miles distant from its port, on the Pacific, Callao, with which it is connected by a railway. Including its suburban villages, ten in number, it contains about 100,000 inhabitants. L is of Spanish origin, and its generally magnificent public buildings entitle it to rank as the handsomest city of South America. At one time the grand *entrepôt* for the west coast of the continent, it still carries on a large trade, importing cottons, woollens, silks, hardware, wines, and brandy; and exporting silver, copper, bark, soap, vicuna wool, chinchilla skins, nitre, sugar, &c. The temperature is agreeable, averaging 68.1° in winter, and 77.6° in summer; and the climate is comparatively salubrious, abundant dews making up for the want of rain.

LIMA WOOD, a name of the dye-wood also called *Pernambuco Wood*, *Nicaragua Wood*, and *Peach Wood*, the heart-wood of *Caesalpinia echinata*. See **BRAZIL WOOD**. It is extensively used for dyeing red and peach-colour.

LIMAX AND LIMACIDAE. See **SLUG**.

LIMBER is half the field-equipage of a cannon or howitzer. The one half consists of the carriage itself, with the gun; while the limber, a two-wheeled carriage, fitted with boxes for the field-ammunition of the piece, and having shafts to which the horses are harnessed, forms the remainder. At the back-part, the limber has a strong hook, to which, on the march, is attached the foot of the gun-carriage by a ring at *h*, in the figure under **GUN-CARRIAGE** (q. v.). This constitutes at once a four-wheeled frame, which, whilst easier for transport than a gun on two wheels only, has the advantage of keeping together the gun and its ammunition. In marching, the gun points to the rear; but in coming to action, the artillerymen, by a rapid evolution, wheel round, so that the gun points to the front. It is then *unlimbered*, or unhooked, and the limber conveyed far enough to the rear to be out of the way of the men working the piece. To *limber up* again, and retreat or pursue, is the work but of a few moments.

LIMBURG, an old province of Belgium, which, after having formed part of Belgium, France, Holland, and Austria, was, in 1839, divided between Belgium and Holland.—**BELGIAN LIMBURG**, or **LIMBOURG**, in the north-east of the kingdom, is separated from Holland by the Meuse up to lat. 51° 9' N., and thence by a line running east-north-east to the northern boundary of the kingdom. The surface of the province is flat, and a large portion of it is occupied by barren heath; but in the south and centre there is good arable land. There is excellent pasturage along the banks of the Meuse, and large herds of cattle and swine are here reared. The manufactures include soap, salt, pottery, paper, tobacco, straw-hats, beet-sugar, &c. The area of the province is 923 English square miles, and the population (1861) 195,319. The capital of the province is Hasselt (q. v.).

LIMBURG, a province of Holland, which also ranks as a duchy in the Germanic Confederation, forms the south-east corner of the kingdom, being contiguous to the Belgian province of the same name. Its surface is generally level, and the soil is poor, a great part of it consisting of moors and marshes. However, in the valleys of the Meuse and its chief tributaries, excellent crops of grain, hemp, flax, oil-seeds, &c., are raised, and cattle and sheep reared. There are many manufactures of gin, tobacco, soap, leather, paper, and glass. The capital is Maastricht (q. v.). Area, 844 English square miles; pop. (1861) 218,727.

LIMBUS (Lat. *limbus*, a border), the name assigned in Roman Catholic theology to that place or condition of departed souls in which those are detained who have not offended by any personal act of their own, but, nevertheless, are not admitted to the divine vision. They distinguish it into the *Limbus Patrum* and the *Limbus Infantium*. By the former name they understand the place of those just who died before the coming of the Redeemer, and of whom it is said (1 Peter iii. 19), that he preached to those spirits that were in prison. By the latter is meant the place or state of the souls of infants who die without baptism. See **HELL**. Regarding the nature of both these places of detention, great variety of opinion prevails in Roman Catholic schools. See Wetzer's *Kirchen-Lexicon*, art. 'Höllenfahrt Christi.'

LIME is the oxide of the metal Calcium (q. v.), and is known in chemistry as one of the alkaline earths. Its symbol is CaO , its equivalent is 28, and its specific gravity is 3.18. In a state of purity, it is a white caustic powder, with an alkaline reaction, and so infusible as to resist even the heat of the oxyhydrogen jet. See **DRUMMOND LIGHT**. It is obtained by heating pure carbonate of lime (as, for instance, Carrara marble or Iceland spar) to full redness, when the carbonic acid is expelled, and lime is left. Commercial lime, which is obtained by burning common limestone in a kiln, is usually very far from pure. This compound (CaO) is known as *quicklime*, or, from the ordinary method of obtaining it, as *burned lime*, to distinguish it from the *hydrate of lime*, or *slaked lime*, which is represented by the formula CaO,HO . On pouring water on quicklime, there is an augmentation of bulk, and the two enter into combination; and if the proportion of water be not too great, a light, white, dry powder is formed, and a great heat is evolved. On exposing the hydrate to a red heat, the water is expelled, and quicklime is left.

If quicklime, instead of being treated with water, is simply exposed to the air, it slowly attracts both aqueous vapour and carbonic acid, and becomes what is termed *air-slaked*, the resulting compound in this case being a powder which is a mixture (or possibly a combination) of carbonate and hydrate of lime.

Lime is about twice as soluble in cold as in boiling water, but even cold water only takes up about $\frac{1}{4}$ th of its weight of lime. This solution is known as *lime-water*, and is much employed both as a medicine and as a test for carbonic acid, which instantly renders it turbid, in consequence of the carbonate of lime that is formed being more insoluble even than lime itself. It must, of course, be kept carefully guarded from the atmosphere, the carbonic acid of which would rapidly affect it. If in the preparation of slaked lime considerably more water is used than is necessary to form the hydrate, a white semi-fluid matter is produced, which is termed *milk of lime*. On allowing it to stand, there is a deposition of hydrate of lime, above which is lime-water.

The use of lime in the preparation of mortars and cements is described in the articles on these subjects. Lime is also largely employed as a manure (see below), and in the purification of coal-gas, in the preparation of hides for tanning, for various laboratory processes (from its power of attracting water), &c. Its medicinal uses are noticed below.

The following are the most important of the salts of lime. *Sulphate of lime* (CaO,SO_2) occurs free from water in the mineral *anhydrite*, but is much more abundant in combination with two equivalents of water in *selenite*, and in the different varieties of *gypsum* and *alabaster*. See **GYPSUM**.

Carbonate of lime (CaO,CO_2) is abundantly present in both the inorganic and organic kingdoms.

In the inorganic kingdom, it occurs in a crystalline form in Iceland spar, Aragonite, and marble—in which it is found in minute granular crystals—while in the amorphous condition it forms the different varieties of limestone, chalk, &c. It is always present in the ashes of plants, but here it is, at all events, in part the result of the combustion of citrates, acetates, malates, &c., of lime. It is the main constituent of the shells of crustaceans and molluscs, and occurs in considerable quantity in the bones of man and other vertebrates. Carbonate of lime, held in solution by free carbonic acid, is also present in most spring and river waters, and in sea-water. Stalactites, stalagmites, tufa, and travertin are all composed of this salt, deposited from calcareous waters. Certain forms of carbonate of lime—the Portland and other colites, some of the magnesian limestones, &c.—are of extreme value for building purposes, and the various uses of the finer Marbles (q. v.) are too well known to require comment.

There is a combination of lime with an organic acid, viz., oxalate of lime, which is of great importance in pathology as a frequent constituent of urinary calculi and sediments; for a description of it see **OXALIC ACID**.

The soluble salts of lime (or, more accurately speaking, of calcium) give no precipitate with ammonia, but yield a white precipitate (of carbonate of lime) with carbonate of potash or of soda. These reactions are, however, common to the salts of barium, strontium, and calcium. Solution of sulphate of lime produces no marked effect when added to a salt of calcium, but throws down a white sulphate with the other salts. The most delicate test for lime is oxalate of ammonia, which, even in very dilute neutral or alkaline solutions, throws down a white precipitate of oxalate of lime.

There are several compounds of phosphoric acid and lime, of which the most important is the *basic phosphate of lime*, sometimes termed *bone phosphate*, from its being the chief ingredient of bones. The basic phosphate is represented by the formula $3\text{CaO},\text{PO}_3$, and not only occurs in bones, but also in the minerals apatite and phosphorite, and in the rounded nodules termed coprolites, which are found in the Norfolk crag. It forms $\frac{1}{4}$ th of the ash of well-burned bone, the remaining $\frac{3}{4}$ th being carbonate of lime. This ash is known as *bone-earth*, and is employed as a manure and in the preparation of phosphorus, &c.

The substance commonly designated as *chloride of lime* has been already described in the article **BLEACHING POWDER**.

Lime as Manure.—This mineral substance has been used for many centuries as a means of increasing the fertility of land. All crops require a certain amount, as is found by analysing the ash which remains after combustion. It is sometimes supplied, without previous preparation, in the form of marl and chalk, but in most cases is first calcined and reduced to a fine powder by slaking with water. The quantity of calcined lime applied varies from three to eight tons to the acre. The smaller quantity may be sufficient for light land containing little vegetable matter, while the larger may be required for strong land, or for land holding much organic matter in an inert state. The large quantity of lime applied shews that its manurial effect is due more to its producing a certain chemical effect on the land, than to its affording nutriment to the crops. Lime promotes the decomposition of all kinds of vegetable matter in the soil, and, further, it corrects any acidity in the organic matter, and thus destroys those weeds which are favoured by such a condition of the soil. It assists in the

LIME—LIMERICK.

decomposition of certain salts whose bases form the food of plants, and in this way it may be said to digest or prepare their food. On certain kinds of land, the finer grasses do not thrive until the land has been limed, and in these cases its use becomes all-important. Lime is the only cure, too, that can be relied on for 'finger-and-toe' in turnips, and its use is, from this cause, becoming more general.

Lime-Compounds in Materia Medica.—*Quicklime*, in association with potash, either as the *Potassa cum calce*, or as *Vienna Paste*, is occasionally used as a caustic. *Lime-water*, mixed with an equal quantity or an excess of milk, is one of our best remedies for the vomiting dependent on irritability of the stomach. From half an ounce to two or three ounces may be thus taken three or four times a day. Its use as a constituent of Carron oil in burns is noticed in the article *LINIMENTS*. *Chalk*, or *carbonate of lime*, when freed from the impurities with which it is often associated, is used as a dusting-powder in moist excoriations, ulcers, &c.; and in the form of *chalk mixture* and *compound powder of chalk*, is a popular remedy in various forms of diarrhoea. A mixture of an ounce of precipitated carbonate of lime and a quarter of an ounce of finely powdered camphor, is sold as *Camphorated Cretaceous Tooth-powder*.

LIME (*Citrus acida*), a fruit similar to the Lemon (q. v.), but much smaller, being only about $1\frac{1}{4}$ inch in diameter, and almost globular, with a thin rind, and an extremely acid juice. It is regarded by many botanists as a variety of the same species with the Citron and Lemon. The plant does not attain the magnitude of a tree, but is a shrub of about eight feet in height, with a crooked trunk, and many spreading prickly branches. It is a native of India and China, but has long been cultivated in the West Indies, the south of Europe, &c. In the West Indies, it is planted both for the sake of its fruit and for hedges. The fruit is used for the same purposes as the lemon; but its acid is by many reckoned more agreeable. Lime-juice is imported into Britain like lemon-juice for the manufacture of citric acid.—The Sweet Lime (*C. Limetta* of Risso), cultivated in the south of Europe, appears to be a mere variety, probably the result of cultivation, with a sub-acid pulp.

LIME, or **LINDEN** (*Tilia*), a genus of trees of the natural order *Tiliaceae*, natives of Europe, the north of Asia, and North America. The species are very similar; graceful, umbrageous trees; with deciduous, heart-shaped, serrated leaves, and cymes or panicles of rather small yellowish flowers; each cyme or panicle accompanied with a large, oblong, yellowish, membranous bractea, with netted veins, the lower part of which adheres to the flower-stalk. The wood is light and soft, but tough, durable, and particularly suitable for carved work. It is much used by turners, and for making pill-boxes. The charcoal made of it is often used for tooth-powder, for medicinal purposes, for crayons, and for the manufacture of gunpowder. The use of the fibrous inner bark for making ropes, mats, and other plaited work, is noticed in the article *BAST*. It is also used as a healing application to wounds and sores, being very mucilaginous, and abounding in a bland sap. The leaves are in some countries used as food for cattle, but cows fed on them produce bad butter. The flowers have an agreeable odour, and abound in honey, much sought after by bees. The celebrated *Kowno Honey*, much valued for medicinal use and for making liqueurs, is the produce of great L. forests near Kowno, in Lithuania. The infusion and distilled water of the dried flowers are gently

sudorific and antispasmodic. The former is in France a popular remedy for catarrhs. The seeds abound in a fixed sweet oil.—The **EUROPEAN L.**, or **LINDEN** (*T. Europaea*), often attains a large size, particularly in rich alluvial soils. Some botanists distinguish a small-leaved kind (*T. parvifolia* or *microphylla*) and a large-leaved (*T. grandifolia*) as different species;



Lime-Tree (*T. Europaea*).

others regard them as mere varieties. The **HOODED** or **CAPUCHIN L.** is an interesting monstrous variety. The L.-tree is often planted for shade in towns; and the principal street of Berlin is called *Unter den Linden*, from the rows of L.-trees which line it. The L. is a very doubtful native of Britain, although indigenous on the continent from Scandinavia to the Mediterranean. In Britain, the L.-tree is generally propagated by layers.—The **AMERICAN L.** (*T. Americana*, or *T. glabra*), commonly called **BASSWOOD** in America, has larger leaves than the European species. It abounds on the shores of Lakes Erie and Ontario. Other species take its place in more western and more southern regions.

LIMERICK, an inland county of the province of Munster, in Ireland, separated by the Shannon on the N. from Clare, and bounded on the E. by Tipperary, on the S. by Cork, and on the W. by Kerry. Its extreme length is 35 miles, its breadth 54 miles; area, 1064 square miles, or 680,842 acres. Pop. in 1851, 208,684; in 1861, 170,983, of whom 164,878 were Roman Catholics, 5606 Protestants of the Established Church, and the rest Protestants of other denominations. The surface of L. is an undulating plain, which forms part of the central carboniferous limestone plain of Ireland. A mountainous district on the west belongs to the great coal-tract of Munster, but the coal is of an inferior quality, and is chiefly used for the burning of lime. Within a short distance of the city of Limerick is a quarry which produces a reddish-brown marble of fine quality, as well as a black marble of inferior value. More than one of the districts contains iron, copper, and lead ores; but at present, no mining operations are carried on. The soil in general is very fertile, especially the district called the Golden Vale, which comprises upwards of 150,000 acres; as also a portion of the left bank of the Shannon below Limerick. Of the entire acreage of the county, 526,876 acres are arable, and 121,101 unsuited to cultivation. In general, the soil is equally fitted for tillage and for pasture. In 1862, 200,614 acres were under crops of various kinds, only 410 being reported fallow.

LIMERICK—LIMESTONE

In the same year, the number of horned cattle was 146,686, and of sheep 62,576. The national schools in 1861 were 177, attended by 30,413 pupils, of whom 16,862 were boys, and 15,551 girls.

The principal towns of L. are the city of that name, Newcastle, and Rathkeale. Of the secondary rivers, the Deel and the Maigue are the most important. The great highway of water-communication, however, is the Shannon itself, the navigation of which has been much improved, and in which the harbour of Foynes promises to form the nucleus of an extended foreign trade. L. communicates by railway with Dublin, Waterford, Cork, and Ennis. The population is chiefly occupied in agriculture, hardly any manufactures existing outside the city. L. anciently formed part of the territory of Thomond, the principality of the O'Briens. After the English invasion, it fell, through many vicissitudes, in great part to the Desmond Fitzgeralds—the confiscated estates of the last earl in L. containing no fewer than 96,165 acres. On the forfeitures after 1641 and 1690, it was parcelled out to new proprietors. L. is more than usually rich in antiquities, both ecclesiastical and civil, of the Celtic as well as of the Anglo-Norman period. There were at one time nearly 40 religious foundations of the O'Briens alone, and the ruins of about 100 castles are still in existence. The ecclesiastical remains of Adare are exceedingly interesting, two of the ancient churches having been restored, one as the Protestant, the other as the Catholic parish church. Two other monastic ruins, in very good preservation, form a group of ecclesiastical remains hardly surpassed, in number and picturesqueness, even in the most favoured districts of the midland and northern counties of England.

LIMERICK, city, capital of the county just described, is situated on the river Shannon, 120 miles west-south-west from Dublin, with which it is connected by the great Southern and Western Railway. Pop. in 1851, 53,448; in 1861, 44,626, of whom 39,689 were Roman Catholics; 3934 Protestants of the Established Church, and the rest Protestants of other denominations. L. is a parliamentary and municipal borough, and returns two members to parliament. It occupies both sides of the Shannon, together with a tract called King's Island, which lies on a bifurcation of the river; and is divided into the English Town, the oldest part of the city (and connected with the extensive suburb called Thomond Gate, on the Clare side of the Shannon), and the Irish Town, which, within the present c., has extended on the south bank of the river into what is now the best part of L., called the New Town, or Newtown Pery, one of the handsomest towns in Ireland. L. is a place of great antiquity. From its position on the Shannon, it was long an object of desire to the Danes, who occupied it in the middle of the 9th c., and held possession till reduced to a tributary condition by Brian Boroiimhe, in the end of the 10th century. It was early occupied by the English, and in 1210, King John visited and fortified it. It was afterwards assaulted and partially burned in 1314 by Edward Bruce. Its later history is still more interesting. It was occupied by the Catholic party in 1641, but surrendered to Ireton in 1651. At the Revolution, it was the last stronghold of King James. Having been unsuccessfully besieged by William after the victory of the Boyne, it was regularly invested in 1691 by General Ginkel, and after a vigorous and brilliant defence of several weeks, an armistice was proposed, which led to the well-known 'Treaty of Limerick,' the alleged violation of which has been the subject of frequent and acrimonious controversy between political parties in Ireland. The

so-called 'Treaty Stone' still marks the spot, near Thomond Bridge, at the entrance of the suburb of Thomond Gate, where this treaty was signed. The modern city of L. is more tasteful in its general character, and possesses more of the appliances of commercial enterprise and social culture than most towns of Ireland. Its public buildings, especially the new Roman Catholic cathedral, and church of the Redemptorist order, are imposing, and in excellent taste. Its charitable and religious establishments are truly munificent for a provincial town. It possesses several national schools, as well as many other educational institutions. The Shannon at L. is still a noble river, navigable for ships of large burden. The docks and quays are on a very extensive and commodious scale; and the export trade, as well as the navigation of the river, is conducted with considerable enterprise. The inland navigation is by means of a canal to Killaloe, where it enters Lough Derg, and thence by the upper Shannon to Athlone, and by the Grand Canal, which issues from the Shannon at Shannon Harbour, to Dublin. The manufactures of L. are not very extensive, but some of them enjoy not merely an Irish, but an imperial reputation—such are the manufactures of lace, of gloves, and of fish-hooks. There are several iron-foundries, flour-mills, breweries, distilleries, and tanneries, and of late years, the ship-building trade has been considerably extended. In 1862, 1037 vessels, of 200,396 tons, entered and cleared the port.

LIMESTONE, the popular as well as technical name for all rocks which are composed in whole, or to a large extent, of carbonate of lime. Few minerals are so extensively distributed in nature as this, and in some form or other, limestone rocks occur in every geological epoch. Carbonate of lime is nearly insoluble in pure water, but it is rendered easily soluble by the presence of carbonic acid gas, which occurs in a variable quantity in all natural waters, for it is absorbed by water in its passage through the air as well as through the earth. Carbonate of lime in solution is consequently found in all rivers, lakes, and seas. In evaporation, water and carbonic acid gas are given off, but the carbonate of lime remains uninfluenced, becoming gradually concentrated, until it has supersaturated the water, when a precipitation takes place. In this way are formed the stalactites which hang icicle-like from the roofs of limestone caverns, and the stalagmites which rise as columns from their floors. Travertine (Tiber-stone), or calcareous tufa, is similarly formed in running streams, lakes, and springs, by the deposition of the carbonate of lime on the beds or sides, where it encrusts and binds together shells, fragments of wood, leaves, stones, &c. So also birds' nests, wigs, and other objects become coated with lime in the so-called petrifying wells, as that at Knaresborough. From the same cause, pipes conveying water from boilers and mines often become choked up, and the tea-kettle gets lined with 'fur.'

While water is thus the great store-house of carbonate of lime, very little of it, however, is fixed by precipitation, for in the ocean, evaporation does not take place to such an extent as to permit it to deposit, besides, there is five times the quantity of free carbonic acid gas in the water of the sea that is required to keep the carbonate of lime in it in solution. Immense quantities of lime are nevertheless being abstracted from the sea, to form the hard portions of the numerous animals which inhabit it. Crustacea, mollusca, zoophytes, and foraminifera are ever busy separating the little particles of carbonate of lime from the water, and solidifying them, and so supplying the materials

for forming solid rock. It has been found that a large portion of the bed of the Atlantic between Europe and North America is covered with a light-coloured ooze, composed chiefly of the perfect or broken skeletons of foraminifera, forming a substance, when dried, which, in appearance and structure, closely resembles chalk. In tropical regions, corals are building reefs of enormous magnitude, corresponding in structure to many rocks in the carboniferous and other formations. The rocks thus organically formed do not always occur as they were originally deposited; denudation has sometimes broken them up to re-deposit them as a calcareous sediment. Great changes, too, may have taken place through metamorphic action in the texture of the rock, some limestones being hard, others soft, some compact, concretionary, or crystalline.

The chief varieties of limestone are: *Chalk* (q. v.); *Oolite* (q. v.); *Compact Limestone*, a hard, smooth, fine-grained rock, generally of a bluish-gray colour; *Crystalline Limestone*, a rock which, from metamorphic action, has become granular; fine-grained white varieties, resembling loaf-sugar in texture, are called *Saccharine* or *Statuary Marble*. *Magnesian Limestone* or *Dolomite* (q. v.) is a rock in which carbonate of magnesia is mixed with carbonate of lime. Particular names are given to some limestones from the kind of fossils that abound in them, as *Nummulite*, *Hippurite*, *Indusial*, and *Crinoidal limestones*; and to others from the formation to which they belong, as *Devonian*, *Carboniferous*, and *Mountain Limestones*.

LIMFIORD. See DENMARK.

LIMITATION, in English Law, is the limited time allowed to parties to commence their suits or actions, or other proceedings, so as to shorten litigation. In all civilised countries, some period is prescribed by statute (called statutes of limitations, or prescription) with this view, though few countries adopt the same limit, and Scotland differs much from England and Ireland in this point. In England, suits to recover land must generally be brought within twenty years, and to recover debts (including bills of exchange) and damages within six years. Actions for assault or battery must be brought within four years, and for slander within two years. In Scotland, Prescription is the word generally used for limitation, and actions to recover land generally must be brought within forty years, for many ordinary debts within three years, but for bills of exchange within six years. There are many other differences of detail. See Paterson's *Compendium of English and Scotch Law*.

LIMITED LIABILITY. See JOINT-STOCK COMPANIES.

LIMITS, THEORY OF. The importance of the notion of a *limit* in Mathematics cannot be over-estimated, as many branches of the science, including the differential calculus and its adjuncts, consist of nothing else than tracing the consequences which flow from this notion. The following are simple illustrations of the idea: The sum of the series $1 + \frac{1}{2} + \frac{1}{4} + \frac{1}{8} + \dots$, approaches nearer and nearer to 2 as the number of terms is increased; thus, the several sums are $1\frac{1}{2}$, $1\frac{3}{4}$, $1\frac{7}{8}$, &c., each sum always differing from 2 by a fraction equal to the last of the terms which have been added; and since each denominator is double of the preceding one, the further the series is extended, the less the difference between its sum and 2 becomes; also this difference may be made smaller than any assignable quantity—say, $\frac{1}{100,000}$ by merely extending the series till the last denominator becomes greater than 100,000 (for this, we need only take

18 terms; 3 terms more will give a difference less than $\frac{1}{1,000,000}$; and so on); again, the sum of the series can never be greater than 2, for the difference, though steadily diminishing, still subsists; under these circumstances, 2 is said to be the limit of the sum of the series. We see, then, that the criteria of a limit are, that the series, when extended, shall approach nearer and nearer to it, in value, and so that the difference can be made as small as we please. Again, the area of a circle is greater than that of an inscribed hexagon, and less than that of a circumscribed hexagon; but if these polygons be converted into figures of twelve sides, the area of the interior one will be increased, and that of the exterior diminished, the area of the circle always continuing intermediate in position and value; and as the number of sides is increased, each polygon approaches nearer and nearer to the circle in size; and as, when the sides are equal, this difference can be made as small as we please, the circle is said to be the limit of an equilateral polygon, the number of whose sides is increased indefinitely; or, in another form of words commonly used, 'the polygon approaches the circle as its limit, when its sides increase without limit,' or again, 'when the number of sides is infinite, the polygon becomes a circle.' When we use the terms 'infinite' and 'zero' in mathematics, nothing more is meant than that the quantity to which the term is applied is *increasing without limit*, or *diminishing indefinitely*; and if this were kept in mind, there would be much less confusion in the ideas connected with these terms. From the same cause has arisen the discussion concerning the possibility of what are called vanishing fractions (i. e., fractions whose numerator and denominator become zero simultaneously) having *real values*;

thus $\frac{x^2 - 1}{x - 1} = 0$, when $x = 1$; but by division we find that the fraction is equal to $x + 1$, which = 2, when $x = 1$. Now, this discussion could never have arisen had the question been interpreted rightly, as follows: $\frac{x^2 - 1}{x - 1}$ approaches to 2 as its limit,

when x continually approaches 1 as its limit, a proposition which can be proved true by substituting successively 3, 2, $1\frac{1}{2}$, $1\frac{1}{3}$, $1\frac{1}{4}$, $1\frac{1}{5}$, &c., when the corresponding values of the fraction are 4, 3, $2\frac{1}{2}$, $2\frac{1}{3}$, $2\frac{1}{4}$, &c. The doctrine of limits is employed in the Differential Calculus (q. v.). The best and most complete illustrations of it are found in Newton's *Principia*, and in the chapters on Maxima and Minima, Curves, Summation of Series, and Integration generally, in the ordinary works on the Calculus.

LIMMA, an interval which, on account of its exceeding smallness, does not appear in the practice of modern music, but which, in the mathematical calculation of the proportions of different intervals, is of the greatest importance. The limma makes its appearance in three different magnitudes—viz., the great limma, which is the difference between the large whole tone and the small semitone, being in the proportion of 27 to 25; the small limma, which is the difference between the great whole tone and the great semitone, being in the proportion of 135 to 138; and the Pythagorean limma, which is the difference between the great third of the ancients (which consisted of two whole tones) and the perfect fourth, the proportion of which is as 256 to 243.

LIMNÆA (Gr. *limne*, a swamp), a genus of gasteropodous molluscs of the order *Pulmonata*, giving its name to a family, *Limnæada*, allied to *Helicida* (Snails), *Limacida* (Slugs), &c. The species

of this family are numerous, and abound in fresh waters in all parts of the world. They feed on vegetable substances. They all have a thin, delicate, horn-coloured shell, capable of containing the whole animal when retracted, but varying very much in form in the different genera; being produced into a somewhat elongated spire in the true *Limnææ* (POND-SNAILS), whilst in *Planorbis* the spire is coiled in the same plane, and in *Ancylus* (RIVER LIMPETS) it is limpet-shaped, with a somewhat produced and recurved tip. Many of the *Limnææ* have a habit of floating and gliding shell downwards at the surface of the water, as may readily be observed in a fresh-water aquarium, in which they are of great use in preventing the excessive growth of confervoids, and removing all decaying vegetable matter. They serve the same purpose in the economy of nature in lakes, ponds, and rivers, and furnish food for fishes. They are hermaphrodite. They deposit their eggs on stones or aquatic plants, enveloped in masses of a glairy substance. The development of the young mollusc may easily be watched in the aquarium, the membrane of the egg being perfectly transparent.

LIMNORIA, a genus of crustacea of the order *Isopoda*, containing only one known species, which, however, is important from the mischief it does to piers, dock-gates, and other wood-work immersed in the water of the sea, on the coasts of Britain, and of some parts of continental Europe. It is only about a sixth of an inch in length, of an ash-gray colour, with black eyes, which are composed of numerous *ocelli*, placed close together. The head is broad. The legs are short. The general appearance resembles that of a small wood-louse, and the creature rolls itself up in the same manner, if seized. The contents of the stomach consist of comminuted wood, and food is the object of the perforation of wood for which the *L.* is notable. Mr Stevenson found it very troublesome during the operations connected with the building of the Bell Rock Lighthouse. The piers at Southampton have suffered greatly from it. The kyanising of wood and other expedients have been resorted to, to prevent its ravages.

LIMOGES, capital of the department of Haute-Vienne, in France, and of the former province of Limousin, picturesquely situated on a hill in the valley of the Vienne, 67 miles south-east of Poitiers. It is an ancient city, and the seat of a bishop. It has a cathedral, begun in the 13th c., but still incomplete; a number of scientific and benevolent institutions and public buildings; considerable manufactures of druggets, of a kind of packthread known as Limoges, &c. It was the Augustorium of the Romans, in the country of the Gallic Lemovices, and afterwards received the name of Lemovica, whence the present Limoges. Before the French Revolution, it had more than forty convents. Pop. 51,053.

LIMPET (*Patella*), a genus of gasteropodous molluscs, of the order *Cyclobranchiata*, the type of the family *Patellidæ*. In all this family, the shell is nearly conical, not spiral, and has a wide mouth, and the apex turned forwards. The animal has a large round or oval muscular foot, by which it adheres firmly to rocks, the power of creating a vacuum being aided by a viscid secretion. Limpets live on rocky coasts, between tide-marks, and remain firmly fixed to one spot when the tide is out, as their gills cannot bear exposure to the air, but move about when the water covers them; many of them, however, it would seem, remaining long on the same spot, which in soft calcareous rocks is found hollowed to their exact form. They feed on algae, which they eat by means

of a long ribbon-like tongue, covered with numerous rows of hard teeth; the COMMON *L.* (*Patella vulgaris*) of the British coasts having no fewer than 160 rows of teeth on its tongue, 12 in each row, 1920 teeth in all. The tongue, when not in use, lies folded deep in the interior of the animal. The gills are arranged under the margin of the mantle, between it and the foot, forming a circle of leaflets. The sexes are distinct.—The power of adherence of limpets to the rock is very great, so that unless surprised by sudden seizure, they are not easily removed without violence sufficient to break the shell. The species are numerous, and exhibit many varieties of form and colour. The Common *L.* is most abundant on the rocky coasts of Britain, and is much used for bait by fishermen; it is also used for food. Some of the limpets of warmer climates have very beautiful shells. A species found on the western coast of South America has a shell a foot wide, which is often used by the inhabitants as a basin.

LINA'CEÆ. See **FLAX.**

LINCOLN, ABRAHAM, sixteenth President of the United States of America, was born in Kentucky, February 12, 1809. His grandfather was an emigrant from Virginia; his father, a poor farmer, who, in 1816, removed from Kentucky to Indiana. In the rude life of the backwoods, L.'s entire schooling did not exceed one year, and he was employed in the severest agricultural labour. He lived with his family in Spencer County, Indiana, till 1830, when he removed to Illinois, where, with another man, he performed the feat of splitting 3000 rails in a day, which gave him the popular soubriquet of 'the Railsplitter.' In 1834, he was elected to the Illinois legislature. At this period, he lived by surveying land, wore patched homespun clothes, and spent his leisure hours in studying law. He was three times re-elected to the legislature; was admitted to practise law in 1836; and removed to Springfield, the state capital. In 1844, he canvassed the state for Mr Clay, then nominated for president. Mr Clay was defeated, but the popularity gained by L. in the canvass secured his own election to congress in 1846, where he voted against the extension of slavery; and in 1854 was a recognised leader in the newly-formed Republican party. In 1855, he canvassed the state as a candidate for United States' senator, against Mr Douglas, but without success. In 1856, he was an active supporter of Mr Fremont in the presidential canvass which resulted in the election of Mr Buchanan. In 1860, he was nominated for the presidency by the Chicago Convention over Mr Seward, who expected the nomination. The non-extension of slavery to the territories, or new states to be formed from them, was the most important principle of his party. There were three other candidates—Mr Douglas of Illinois, Northern Democrat; Mr Breckenridge of Kentucky, then vice-president, and since a general of the Confederate army, Southern Democrat; and Mr Bell of Tennessee, Native American. With this division, Mr Lincoln received a majority of votes over any of the other candidates, though a million short of an absolute majority; every Southern and one Northern state voted against him. He was installed in the president's chair 4th March 1861. His election by a sectional vote and on a sectional issue hostile to the South, was followed by the secession of 11 Southern states, and a war for the restoration of the union. As a military measure, he proclaimed, January 1, 1863, the freedom of all slaves in the rebel states; but this proclamation did not produce the immediate results which had been anticipated. His own views on the slavery question appear to

LINCOLN—LINDSAY.

have been moderate, and in accordance with the constitution.

LINCOLN (called by the Romans *Lindum*; from which, with *Colonia* subjoined, comes the modern name), a city of England, capital of the county of the same name, a parliamentary and municipal borough and county of itself, is situated on the Witham, 140 miles north-north-west of London by railway. Built on the slope of a hill, which is crowned by the cathedral, the city is imposing in effect, and can be seen from a very considerable distance. It is very ancient, is irregularly laid out, and contains many interesting specimens of early architecture. The cathedral, one of the finest in England, is the principal building. It is surmounted by three towers, two of which, 180 feet in height, were formerly continued by spires of 101 feet. The central tower, 53 feet square, is 300 feet high. The interior length of the cathedral is 482, the width, 80 feet. The famous bell called Tom of Lincoln was cast in 1610, and was hung in one of the west towers of this edifice. It was broken up, however, in 1834, and, together with six other bells, was recast to form the present large bell and two quarter bells. The present bell, which hangs in the central tower, is 5 tons 8 cwt. in weight, and is 6 feet 10½ inches in diameter at the mouth. The style of the cathedral, though various, is chiefly Early English. L. also contains many other interesting religious edifices, among which are three churches, dating from before the Reformation, &c., numerous schools, and benevolent institutions. Several iron foundries, and manufactories of portable steam-engines and agricultural machines, as well as large steam flour-mills are in operation here, and there is an active trade in flour. Brewing and machine-making, with a trade in corn and wool, are also carried on. Two members are returned to the House of Commons for the city. Pop. (1861) 20,999.

L., under the Romans, was a place of some importance, and under the Saxons and the Danes, it preserved a good position. It was the seat of an extensive and important trade at the time of the Norman Conquest; but its advancement since that time has not been equally rapid. It contains some very interesting antiquities, as the Roman gate, the remains of the palace and stables of John of Gaunt, and the town-hall, which dates from the time of Henry VIII.

LINCOLNSHIRE, a maritime county of England, and, after Yorkshire, the largest in the country, is bounded on the N. by Yorkshire, and on the E. by the North Sea. Area, 1,775,457 statute acres; pop. 412,246. The coast, from the Humber—which separates the county from Yorkshire on the north—to the Wash, is almost uniformly low and marshy; so low, indeed, in one part—between the mouths of the Welland and the Nen—that the shore here requires the defence of an embankment from the inroads of the sea. L. has long been divided into three districts, or 'parts,' as they are called—viz., the Parts of Lindsey, an insular district, forming the north-eastern portion of L., and including the Wolds or chalk hills, which are about 47 miles in length by 6 miles in average breadth; the Parts of Kesteven, in the south-west; and the Parts of Holland, in the south-east, including the greater part of the fens. Chief rivers, the Trent, the Ancholme, the Witham, and the Welland. The surface is comparatively level, with the exception of the Wolds in the north-east. The soil, though very various, is on the whole very fertile. It includes tracts of grazing-ground unsurpassed in richness, and the 'warp-lands' (see WARPING) along the side of the Trent

produce splendid crops of wheat, beans, oats, and rape, without the aid of manure. No other county in England has finer breeds of oxen, horses, and sheep. Horncastle and Lincoln horse-fairs are frequented by French, German, Russian, and London dealers for the purpose of buying superior hunters and carriage-horses. The climate, though subject to strong westerly winds, is pretty much the same as that of the other central counties of England. Four members are returned to parliament.

LINCOLN'S INN, one of the four English Inns of Court, having exclusive power to call persons to the bar. It is so called because it belonged to the Earl of Lincoln in the reign of Edward II., and became an Inn of Court soon after his death in 1310. See INNS OF COURT.

LIND, JENNY. See GOLDSCHMIDT, MADAME.

LINDLEY, JOHN, a distinguished botanist, was born, February 1799, at Catton, near Norwich, where his father, who was the author of *A Guide to Orchard and Kitchen Gardens*, owned a large nursery garden. Botany seems to have early attracted his attention, as, in 1819, he published a translation of Richard's *Analyse du Fruit*, and in 1820, his *Monographia Rosarum* appeared. Amongst his most important works are his *Introduction to the Natural System of Botany* (1830); *Introduction to the Structure and Physiology of Plants* (2 vols. 1832); *Flora Medica* (1838); and *The Vegetable Kingdom* (1846), which is a standard work on the subject of classification, and is an expansion of his *Introduction to the Natural System*, which had previously (in 1836) been remodelled under the title of *A Natural System of Botany*. L. did a great deal to popularise the study of botany by the publication of his *Ladies' Botany*, *School Botany*, 'Botany' in the *Library of Useful Knowledge*, and the botanical articles as far as the letter R in the *Penny Cyclopaedia*. In his *Theory of Horticulture*, which has passed through several editions, and in the well-known periodical, *The Gardener's Chronicle* (the horticultural department of which he edited from its commencement in 1841), he shewed the great practical value of a knowledge of vegetable physiology in the common operations of the field and garden. In conjunction with Mr Hutton, he published *The Fossil Flora of Great Britain*, which consists of descriptions and figures of all the fossil plants found in this country up to the time of the commencement of this publication in 1833. Our limited space prevents us from noticing his other works, or his numerous contributions to scientific transactions. In 1829, at the opening of the London University, he was appointed Professor of Botany, and he continued to discharge the duties of the chair till 1860, when he resigned. From 1822, he acted as assistant secretary to the Horticultural Society, and not only edited their Transactions and Proceedings, but took an active part in the management of their gardens at Turnham Green to the date of their discontinuance. He was a Fellow of almost all the learned societies both at home and abroad. He died November 1865.

LINDSAY, SIR DAVID, OF THE MOUNT, one of the best, and long the most popular of the older Scottish poets, was the son of David Lindsay of Garmylton in East Lothian, and of the Mount in Fife, whose grandfather was a natural son of Sir William Lindsay of the Byres. The poet is believed to have been born at the Mount about the year 1490, to have had his first training at the grammar-school of Cupar, and to have studied at the university of St Andrews from 1505 till 1509. He seems to have visited Italy in 1510. He returned to

Scotland before the winter of 1511, when he is found taking part in a play acted before the court of King James IV. In the following spring, he was appointed 'keeper' or 'usher' of the prince, who, when little more than a twelvemonth old, became King James V.; and his verses preserve some pleasing traces of the care and affection with which he tended the king's infant years. His wife, Janet Douglas, had long the charge of the royal apparel. In 1524, the court fell under the power of the queen-mother and the Douglasses, and L. lost his place; but four years afterwards, when the Douglasses were overthrown, L. was made one of the king's heralds. About 1530, he was knighted, and promoted to the office of Lion King at Arms. In this capacity he accompanied embassies to the courts of England, France, Spain, and Denmark. He appears to have represented Cupar in the parliaments of 1542 and 1543; and he was present at St Andrews in 1547, when the followers of the reformed faith called Knox to take upon himself the office of a public preacher. He died childless before the summer of 1555.

The first collection of L.'s poems appeared at Copenhagen about 1553. They were republished at Paris or Rouen in 1558; at London in 1566, 1575, and 1581; at Belfast in 1714; in Scotland in 1559, 1568, 1571, 1574, 1588, 1592, 1597, 1604, 1610, 1614, 1634, 1648, 1696, 1709, 1720, and 1776. This mere enumeration of editions might be enough to shew the great popularity which L. long enjoyed. For nearly two centuries, indeed, he was what Burns has since become—the poet of the Scottish people. His works were in almost every house, his verses on almost every tongue. Like Burns, he owed part of his popularity, no doubt, to his complete mastery of the popular speech. But, like Burns, L. would have been read in whatever language he chose to write. His verses shew few marks of the highest poetical power, but their merits otherwise are great. Their fancy is scarcely less genial than their humour, and they are full of good sense, varied learning, and knowledge of the world. They are valuable now, if for nothing else than their vivid pictures of manners and feelings. In the poet's own day, they served a nobler purpose, by preparing the way for the great revolution of the 16th century. It has been said that the verses of L. did more for the Reformation in Scotland than all the sermons of Knox. Like Burns, L. shot some of his sharpest shafts at the clergy. If his verse is much more open than the verse of Burns to the charge of licentiousness, it is to be remembered that he lived in a much coarser and looser age. The earliest and most poetical of his writings is *The Dreame*; the most ambitious, *The Monarchie*; the most remarkable in his own day, perhaps, was *The Satyre of the Thrie Estaitis*; but that which is now read with most pleasure, both for the charm of its subject and for its freedom from the allegorical fashion of the time, is *The Historie of Squyer Meldrum*. The best edition of L.'s works is that of the late George Chalmers (Lond. 1806, 3 vols. 8vo); but there is ample room for a better. *The Booke and Register of Armes*, which L. compiled as Lion King at Arms in 1542, was printed in fac-simile at Edinburgh in 1822.

LINE, an expression used in the army to distinguish ordinary cavalry and infantry from the Guards, Artillery, and Engineers. It obviously takes its origin from the fact, that the troops in question constituted the usual 'line of battle.'

LINE, MATHEMATICAL, denotes a magnitude having only one dimension. Euclid defines it to be, 'that which has length without breadth.'

LINEAL DESCENT, the descent in a right line, as from father to son, grandson, &c.

LINEN AND LINEN MANUFACTURES, fabrics manufactured wholly from flax or lint (Lat. *linum*). The manufacture of linen has reached its greatest perfection in France and the Netherlands, where the stimulus to produce fine yarns (see SPINNING) for the lacemakers has given rise to such care and attention in the cultivation and preparation of flax, that in point of fineness of fibre they have been unequalled. Consequently, the linens of France, Belgium, and Holland have long enjoyed a well-deserved reputation, and in the article of lawn, which is the finest kind of linen-cloth made, the French are unrivalled. In the ordinary kinds of linen, our own manufactures are rapidly improving, and will soon equal in quality the productions of continental competitors. Those of Ireland, especially, are remarkable for their excellence, and this trade has become a very important one in that country; whilst in Scotland a large trade in the coarser and inferior kinds has located itself. The export of linen and linen yarns from the United Kingdom exceeds in value £6,000,000; and the amount produced for home-consumption may be reckoned at £5,000,000 more.

The chief kinds of linen manufactures, besides yarn and thread, which will be described under SPINNING, are: LAWN (Fr. *linon*), the finest of flax manufactures, formerly exclusively a French production, but very fine lawns are now made in Belfast, Armagh, and Warrington; CAMBRIC (q. v.); DAMASK (q. v.); DIAPER (q. v.). Of the finer plain fabrics, *Sheetings* are the most important in this country. The chief places of their manufacture are Belfast, Armagh, and Leeds. Common *Sheeting* and *Towelling* are very extensively manufactured in Scotland, particularly at Dundee, Kirkcaldy, Forfar, and Arbroath. *Ducks*, *Huckabacks*, *Osaburgs*, *Crash*, and *Tick* (corrupted from *ticken* and *dekken*, Dutch for cover), are very coarse and heavy materials, some fully bleached, others unbleached, or nearly so. They are chiefly made in Scotland, the great seat of the manufacture being at the towns just mentioned, although much is made in the smaller towns and villages, also at Leeds and Barnsley in England. Some few varieties of velvet and velveteen are also made of flax at Manchester, and much linen-yarn is used as warp for other materials.

Linen is one of the most ancient of all textile manufactures, at least it is one of the earliest mentioned. The cerecloth, in which the most ancient mummies are wrapped, proves its early and very extensive use among the Egyptians. It formed also parts of the garments of the Hebrew as well as the Egyptian priests. Panopolis was the Belfast of the ancients, as, according to Strabo, it was there the manufacture of linen was chiefly conducted. The wonderful durability of linen is evidenced by its existence on mummies, and by the remarkable fact mentioned by the German writer, Seetzen, and referred to by Blumenbach, that he had found several napkins within the folds of the covering on a mummy which he unwrapped, and that he had them washed several times without injury, and used with great veneration 'this venerable linen, which had been woven more than 1700 years.' From the time of these ancient Egyptians up to the present period, the use of linen for clothing and other purposes has been continuous; and although the introduction and vast development of the cotton manufacture checked its consumption for a time, it has fully regained, and has indeed exceeded, its former proportions as one of our great staples.

LING (*Lota molva*), a fish of the family *Gadidae*, abundant on most parts of the British coasts, and elsewhere throughout the northern seas, and in value almost rivalling the cod. In form, it is much more elongated than the cod, and even more than the hake, with which it agrees in having two dorsal fins and one anal fin, the anal and second dorsal long; but the genus differs in the presence of barbels, of which the L. has only one at the extremity of the lower jaw. The L. is generally three or four feet long, sometimes more, and has been known to weigh seventy pounds. The colour is gray, inclining to olive; the belly, silvery; the fins edged with white. The tail-fin is rounded. The gape is large, and the mouth well furnished with teeth. The L. is a very voracious fish, feeding chiefly on smaller fishes. It is also very prolific, and deposits its spawn in June, in soft oozy ground near the mouths of rivers. It is found chiefly where the bottom of the sea is rocky. Great numbers are caught in the same manner as cod, by hand-lines and long lines, on the coasts of Cornwall, the Hebrides, the Orkney and Shetland Islands, &c.; and are split from head to tail, cleaned, salted in brine, washed, dried in the sun, and sent to the market in the form of *Stock-fish*. They are largely exported to Spain and other countries. The air-bladders or *sounds* are pickled like those of cod. The liver also yields an oil similar to cod-liver oil, which is used for the supply of lamps in Shetland and elsewhere.—Other species of L. are found in the southern seas.—The *Burbot* (q. v.) is a fresh-water species of the same genus.

LINGA (a Sanscrit word which literally means a sign or symbol) denotes, in the sectarian worship of the Hindus, the *phallus*, as emblem of the male or generative power of nature. The Linga-worship prevails with the S'aivas, or adorers of S'iva (see Hindu Religion under INDIA). Originally of an ideal and mystical nature, it has degenerated into practices of the grossest description; thus taking the same course as the similar worship of the Chaldeans, Greeks, and other nations of the east and west. The manner in which the Linga is represented is generally inoffensive—the pistil of a flower, a pillar of stone, or other erect and cylindrical objects, being held as appropriate symbols of the generative power of S'iva. Its counterpart is *Yoni*, or the symbol of female nature as fructified and productive. The S'iva-Purāna names twelve Lingas which seem to have been the chief objects of this worship in India.

LINGARD, JOHN, D.D., a member of a humble Roman Catholic family, was born at Winchester, February 1, 1771; and being destined for the priesthood of that church, was sent to the English College of Douai, in France, where he remained till that college, in common with most of the religious establishments of France, was broken up by the troubles of the Revolution. The recent Catholic Relief Bill enabling Catholics to open schools in England, the Douai community was transferred to Crookhall, and ultimately to Ushaw, in the county of Durham. L. continued attached to the college in its several migrations, although not always resident. In 1793, he accepted the office of tutor in the family of Lord Stourton; but in the following year he returned to complete his theological studies at Crookhall, where he entered into priest's orders, and in which he continued as professor of philosophy, prefect of studies, and vice-president, until 1810, when he was named president. In 1811, however, he accepted the humble cure of Hornby, near Lancaster, in which he continued to reside till his death, July 13, 1851. L.'s first important

work was the *Antiquity of the Anglo-Saxon Church* (8vo, 1806), reprinted in 1810, and afterwards, in a much enlarged edition (2 vols. 1845). This was but the pioneer of what became eventually the labour of his life—a *History of England* (6 vols. 4to), published at intervals, 1819—1825; and afterwards in 14 vols. 8vo, 1823—1831. This work, before the death of the author, had passed through six editions, the last of which (10 vols. 8vo) appeared in 1854—1855. From its first appearance, it attracted much attention, as being founded on original authorities and the result of much new research. It was criticised with considerable asperity in its polemical bearings; but the author, in his replies, displayed so much erudition, and so careful a consideration of the original authorities, that the result was to add materially to his reputation as a scholar and a critic. It won for itself a place as a work of original research, and although it bears unmistakable evidence of the religious opinions of the author, yet there is also evidence of a sincere desire to investigate and to ascertain the truth of history. In recognition of his great services, many honours were offered to him; and he received a pension of £300 from the crown in reward of his literary services. His remains were interred in his old college of St Cuthbert, at Ushaw.

LINGAYE'N, a town of the island of Luzon, Philippine Islands (q. v.), on a bay of the same name. Pop. 23,063, who export rice and sugar.

LINIMENTS (from the Latin word *linire*, to besmear) may be regarded, in so far as their physical properties are concerned, as ointments having the consistence of oil, while, chemically, most of them are *soaps*—that is to say, compounds of oils and alkalies. In consequence of their slighter consistence, they are rubbed into the skin more readily than ointments. Among the most important of them are: *Liniment of Ammonia*, popularly known as *Hartshorn and Oil*, which is prepared by mixing and shaking together solution of ammonia and olive-oil, and is employed as an external stimulant and rubefacient to relieve neuralgic and rheumatic pains, sore throat, &c.: *Soap Liniment*, or *Opodeldoc*, the constituents of which are soap, camphor, and spirits of rosemary, and which is used in sprains, bruises, rheumatism, &c.: *Liniment of Lime*, or *Carron Oil*, which is prepared by mixing and shaking together equal measures of olive or linseed oil and lime-water; it is an excellent application to burns and scalds, and from its general employment for this purpose at the Carron iron-works, has derived its popular name: *Camphor Liniment*, consisting of camphor dissolved in olive-oil, which is used in sprains, bruises, and glandular enlargements, and which must not be confounded with *Compound Camphor Liniment*, which contains a considerable quantity of ammonia, and is a powerful stimulant and rubefacient: *Opium Liniment*, which consists of soap liniment and tincture of opium, and is much employed as an anodyne in neuralgic, rheumatism, &c.; and the *Simple Liniment of the Edinburgh Pharmacopœia*, which is composed of four parts of olive-oil and one part of white wax, and is used to soften the skin and promote the healing of chaps.

LINKÖPING (old Norse *Longakþingur*, later *Liongakþing*), one of the oldest towns in Sweden, capital of the län of the same name, is situated on the Stångå, which here flows into Lake Roxen, 110 miles south-west of Stockholm. It is regularly built, with fine market-places and public squares, but the houses are mostly of wood. L. has three churches, of which the cathedral—a Gothic edifice

of the 12th c., containing monuments of many illustrious personages—is one of the most beautiful in Sweden. It also possesses a library of 30,000 vols. Its trade is considerable. Pop. 6733. In old heathen times, L. was a place of sacrifice.

LINLITHGOW, or **WEST LOTHIAN**, a county in Scotland, is bounded on the N. by the Firth of Forth, having the counties of Mid-Lothian, Lanark, and Stirling on the E., S., and W. Its length, north to south, is 20 miles, and east to west 15 miles. Its area is 127 square miles, or 81,280 acres. The surface of the ground is irregular, but the hills are inconsiderable in height, the highest not being above 1000 feet. The climate is changeable, but healthy. The soil is very varied, and, except along the borders of the Firth, there is little land of first quality. In some of the high grounds there is good pasture, also a considerable breadth of unreclaimed moss. There are few streams of any note, the Almond and Avon being the principal. The minerals are of considerable value, yielding upwards of £22,000 yearly. The freestone used in building the Royal Institution, National Gallery, and other public buildings in Edinburgh, was got at Binny, near the county town. There are several collieries in full and profitable operation.

There are two royal burghs—Linlithgow, the county town, and Queensferry. The other principal towns are Bathgate and Borrowstounness. This county is intersected with railways, and the Edinburgh and Glasgow Union Canal, on which there is a great traffic in manure and minerals, traverses it for upwards of ten miles. The old valued rent was £6237. In 1811, the real rent was £88,745; and in 1862 it was, excluding railways and canals, £173,171.

The following are the agricultural statistics for 1857: Number of occupants of land, 443; acres under a rotation of crops, 50,547; of which there were 3737 acres of wheat, averaging 30 bushels 3 pecks per acre; 4653 barley, 33 bushels 3 pecks per acre; 11,990 oats, 34 bushels per acre; 5246 acres of turnips, averaging 14 tons 16 cwt. per acre; and 1666 acres of potatoes, 2 tons 6 cwt. per acre. Of live-stock the numbers were—horses, 2533; cattle, 10,766; sheep, 15,982; swine, 2232. Total stock, 31,513. This county contains several remains of Roman antiquities. Pop. 38,645. Constituency in 1862, returning one M.P., 766.

LINLITHGOW, a market-town, and royal and parliamentary burgh of Scotland, chief town of the county of the same name, is situated on a small lake, 16 miles west of Edinburgh. It is one of the oldest towns in Scotland, and, though it has been much modernised, still contains many antiquated houses, and some ruins rich in historical association. The parish church of St Michael's (built partly in the 15th and partly in the 16th c.), a portion of which is still in use, is a beautiful specimen of the latest Scottish Gothic. The palace, strikingly situated on an eminence which juts into the lake (of 102 acres), dividing it into two almost equal parts, is heavy, but imposing in appearance; was frequently the residence of the Scottish monarchs, and was the birthplace of Mary Queen of Scots, and of her father, James V. The earliest record of its existence is of the time of David I. (1124—1153), and fragments of various ages are easily detected. The latest work is of the time of James VI. I. unites with several other burghs in sending a member to parliament. Pop. (1861) 3693.

LINNÉ, **KARL VON**, often called **LINNÆUS**, one of the greatest of naturalists, was born 4th May 1707, at Rashult, in Smaland (Sweden), where his father was a country parson in very poor circum-

stances. His parents intended him for his father's profession, but he made little proficiency in the necessary classical studies, manifesting, however, from his very boyhood, the greatest love for botany. His father, disappointed, proposed to apprentice him to a shoemaker; but Dr John Rothmann, a physician at Wexiö, a friend of his father, undertook for a year the expense of his education, and guided him in the study of botany and of physiology. In 1727, the young naturalist went to study medicine at Lund, and in the year following he went to Upsala, but during his attendance at the university he endured great poverty. Olaf Celsius received him at last into his house, and availed himself of his assistance in preparing a work on the plants of the Bible. He also won the favourable regard of Olaf Rudbeck, the professor of botany at Upsala, by a paper in which he exhibited the first outlines of the sexual system of botany, with which his name must ever remain connected. Rudbeck appointed him curator of the botanic garden and botanical demonstrator. In his 24th year he wrote a *Hortus Uplandicus*. From May to November 1732, he travelled in Lapland, at the expense of the government. The fruits of this tour appeared in his *Flora Lapponica* (Amst. 1737). He afterwards spent some time at Fahlun, studying mineralogy, and there he became acquainted with the lady whom he afterwards married, the daughter of a physician named Moräus, who supplied him with the means of going to Holland to take his degree, which he obtained at Harderwyck in 1735. In Holland, he became the associate of some of the most eminent scientific men of the time, and won for himself a high reputation as a naturalist, developing original views which attracted no little attention, while he eagerly prosecuted his researches in all departments of natural history. During his residence in Holland, L. composed and published, in rapid succession, some of his greatest works, particularly his *Systema Naturæ* (Leyd. 1735), his *Fundamenta Botanica* (Leyd. 1736), his *Genera Plantarum* (Leyd. 1737), his *Corollarium Generum Plantarum* (Leyd. 1737), &c. He visited England and France, and returned to Sweden, where, after some time, he was appointed royal botanist and president of the Stockholm Academy. In 1741, he was appointed professor of medicine in Upsala, and in 1742 professor of botany there. The remainder of his life was mostly spent at Upsala in the greatest activity of scientific study and authorship. He produced revised editions of his earlier works, and numerous new works, a *Flora Suecica* (1745), *Fauna Suecica* (1746), *Hortus Upsaliensis* (1748), *Materia Medica* (1749—1752), his famous *Philosophia Botanica* (1751), and the *Species Plantarum* (1753), in some respects the greatest of all his works. He died on 10th January 1778, the last four years of his life having been spent in great mental and bodily infirmity. L. was not only a naturalist of most accurate observation, but of most philosophical mind, and upon this depended in a great degree the almost unparalleled influence which he exercised upon the progress of every branch of natural history. Among the important services which he rendered to science, not the least was the introduction of a more clear and precise nomenclature. The groups which he indicated and named have, in the great majority of instances, been retained amid all the progress of science, and are too natural ever to be broken up; while, if the botanical system which he introduced is artificial, L. himself was perfectly aware of this, and recommended it for mere temporary use till the knowledge of plants should be so far advanced that it could give place to a natural arrangement. See **BOTANY**.

LINNET (*Linota*), a genus of small birds of the family *Fringillidae*, nearly resembling the true finches, gold-finches, &c. The bill is short, straight, conical, and pointed; the wings long, and somewhat pointed; the tail forked. The species are widely distributed in the northern, temperate, and arctic regions, but much confusion has arisen concerning them, from the difference between the plumage of the breeding season and that of the greater part of the year.



Common Linnet (*L. cannabina*).

The **COMMON L.** (*L. cannabina*), or **GREATER REDPOLE** (qu. *Redpoll*), is common in almost every part of the British Islands and of Europe, and extends over Asia to Japan. In size, it is about equal to the chaffinch. In its winter-plumage, its prevailing colour is brown, the quill and tail feathers black with white edges; in the nuptial-plumage, the crown of the head and the breast are bright vermilion colour, and a general brightening of colour takes place over the rest of the plumage. This change of plumage causes it to be designated the brown, gray, or rose L., according to the season of the year and the sex. It is the *Lintie* of the Scotch. The sweetness of its song makes it everywhere a favourite. It sings well in a cage, and readily breeds in confinement; but the brightness of the nuptial-plumage never appears. The L. abounds chiefly in somewhat open districts, and seems to prefer uncultivated and furze-covered grounds. Its nest is very often in a furze-bush or hawthorn-hedge; is formed of small twigs and stems of grass, nicely lined with wool or hair; the eggs are four or five in number, pale bluish white, speckled with purple and brown. Linnets congregate in large flocks in winter, and in great part desert the uplands, and resort to the sea-coast.—The **MEALY REDPOLE** (*L. canescens*) is also a widely distributed species, and is found in North America, as well as in Europe and Asia, chiefly in very northern regions. It is rare in Britain. In size, it is nearly equal to the Common Linnet. By some, it is regarded as a larger variety of the **LESSER REDPOLE** or **COMMON REDPOLE** (*L. linaria*), which is common in Britain, although in the south of England it is chiefly known as a winter visitant. The forehead, throat, and lore are black; in the spring-plumage, the crown of the head is deep crimson; the general colour is brown of various shades. This species is common in all the northern parts of the world, enlivening with its pleasant twitter and sprightly habits even the desolate wastes of Spitzbergen.—The only other British species is the **MOUNTAIN L.**, or **TWITE** (*L. montium*), chiefly found in mountainous or very northern districts. It is smaller than the preceding, has a yellowish bill, and never assumes the red colour which marks the nuptial-plumage of other species.

LINSEED, the seed of flax, is imported in large quantities into Britain from the continent of Europe, and from India, for the making of *linseed oil* and

oil-cake; in order to which the seeds are first bruised or crushed, then ground, and afterwards subjected to pressure in a hydraulic or screw press, sometimes without heat, and sometimes with the aid of a steam heat of about 200° F. *Linseed oil* is usually amber-coloured, but when perfectly pure it is colourless. It has a peculiar and rather disagreeable odour and taste. It is chiefly used for making varnishes, paints, &c. That made without heat (*cold-drawn linseed oil*) is purer, and less apt to become rancid, than that in making which heat is applied. By cold expression, the seed yields from 18 to 20 per cent., and with heat from 22 to 27 per cent. of oil. *Linseed oil*, boiled either alone or with litharge, white lead, or white vitriol, dries much more rapidly on exposure to the air than the unboiled oil; and *boiled* or *drying oil* is particularly adapted for many uses.—The *oil-cake* made in expressing *linseed oil* is very useful for feeding cattle, and, besides what is made in Britain, it is largely imported from the continent. See **OIL-CAKE**. *Linseed* itself is excellent food for cattle and for poultry. The seed coats abound in mucilage, which forms a thick jelly with hot water, and is very useful for fattening cattle.—*Linseed meal*, much used for poultices, is generally made by grinding fresh *oil-cake*, but it is better if made by grinding the seed itself.

LINSTOCK, an iron-shod wooden staff used in gunnery, for holding the lighted match in readiness to be applied to the touch-hole of the cannon. In old pictures, the *linstock* is seen planted in the ground to the right rear of each piece, with a match smoking in each of the ends of the fork in which it terminates.

LINT. See **FLAX**.

LINTEL, the horizontal bearer over doors, windows, and other openings in walls, usually either of stone or wood.

LIN-TSEH-SU, Chinese Imperial Commissioner, was born in 1785 at Hing-hwa, in the province of Fuh-keen, and his Chinese biographers have not failed to find that his birth was attended with supernatural indications of future eminence. Till he reached his 17th year, he assisted his father in his trade of making artificial flowers, and spent his evenings in studying to qualify himself for the village competitive examinations, at which he succeeded in obtaining successively the degrees analogous to Bachelor of Arts and Master of Arts. His ambitious mind, not satisfied with these triumphs, pointed to Peking as the fitting sphere of his talents, but poverty barred the way. Happily, however, a wealthy friend, who was filled with admiration for L.'s merits and virtues, invited him to become his son-in-law, and he was now in a position to push his fortune at the capital. He became a doctor of laws and a member of the Hanlin College, which latter honour qualified him for the highest official posts. When 30 years of age, he received his first official appointment as censor; and by displaying the same zeal and industry, combined with irreproachable probity, which he had shewn in private life, he gradually rose into the favour of the emperor and his ministers. He was sent to superintend the repairing of the banks of the Yellow River; and on the termination of his mission, two years after, was highly complimented by his sovereign for his diligence and energy, and, as an evidence of imperial favour, was appointed to the post of financial commissioner for Kiang-nan, in which province a famine was at that time decimating the population. L. exhausted all his private resources and emoluments in providing food for the sufferers, and by careful management succeeded in restoring the prosperity of the province. He was next

appointed viceroy of the two provinces of Shen-se and Kan-su, where, as in Kiang-nan, he soon gained the affections of the people and the commendations of the emperor. On his reception by the emperor after his return, new titles were showered upon him, and he obtained the signal honour of entering the imperial precincts on horseback. But now his brilliant progress was to be checked. He had long urged upon his sovereign the adoption of stringent measures towards the importers, dealers, and consumers of opium, the bane and scourge of his native land; and on the commencement of difficulties with Great Britain, he was appointed to deal with the growing evil, and, if possible, put a stop to the obnoxious traffic. He arrived at Canton, invested with unlimited authority; but his unwise though well-meant measures excited a war with Britain, and brought down upon himself the vengeance of his incensed sovereign. He was banished to the region of Ele, where he employed himself in improving the agriculture of the country, by introducing more scientific methods of cultivation. He was soon recalled, and restored to more than his former honours, and did good service by crushing a rebellion in Yun-nan. His health now began to fail, and he obtained permission to retire to his native province; but shortly afterwards, while on his way to attack the Tai-pings, he died, January 1850. His death was the signal for general mourning throughout China, and the emperor ordered a sacrificial prayer to be composed, recording the illustrious deeds of the departed; a signal favour, only conferred upon persons of extraordinary merit and virtue.

L., besides thoroughly mastering the statistics and politics of China, devoted much of his time to studying the geography and history of foreign countries, and to private literary study. He is ranked as one of the chief among Chinese poets; and the style, literary merit, and logical order of his public documents form a strange contrast to the usual diffuse, rambling, and incoherent style of Chinese state-papers.

LINTZ, the capital of the crown-land of Upper Austria, is situated in a pleasant district on the right bank of the Danube, which is here crossed by a wooden bridge 838 feet long, 100 miles west of Vienna. Pop. 27,000. It is a strongly fortified, quiet town, and a bishop's seat, with numerous churches, benevolent institutions, and government offices. There are large imperial factories for carpets and other woollen goods; and cloths, cottons, cassimeres, fustians, leather, and cards are also made. The navigation of the Danube occasions a lively trade. Steam-boats ply daily up the river to Ratisbon, and down the river to Vienna. The women of L. are celebrated for their beauty.

LION (*Felis leo*), the largest and most majestic of the *Felidæ* and of carnivorous quadrupeds. It is, when mature, of a nearly uniform tawny or yellowish colour, paler on the under-parts; the young alone exhibiting markings like those common in the *Felidæ*; the male has, usually, a great shaggy and flowing mane; and the tail, which is pretty long, terminates in a tuft of hair. The whole frame is extremely muscular, and the fore-parts, in particular, are remarkably powerful; giving, with the large head, bright-flashing eye, and copious mane, a noble appearance to the animal, which, with its strength, has led to its being called the 'king of beasts,' and to fancies of its noble and generous disposition, having no foundation in reality. A L. of the largest size measures about 8 feet from the nose to the tail, and the tail about 4 feet. The *lioness* is smaller, has no mane, and is of a lighter colour on the under-parts. The

strength of the L. is such that he can carry off a heifer as a cat carries a rat.

The L. is chiefly an inhabitant of Africa, although it is found also in some of the wilds of Asia, particularly in certain parts of Arabia, Persia, and India. It was anciently much more common in Asia, and was found in some parts of Europe, particularly in Macedonia and Thrace, according to Herodotus and other authors. It has disappeared also from Egypt, Palestine, and Syria, in which it was once common. The L. is not, in general, an inhabitant of deep forests, but rather of open plains, in which the shelter of occasional bushes or thickets may be found. The breeding-place is always in some much secluded retreat, in which the young—two, three, or four in a litter—are watched over with great assiduity by both parents, and, if necessary, are defended with great courage—although, in other circumstances, the L. is more disposed to retire from man than to assail him or contend with him. When met in an open country, the L. retires at first slowly, as if ready for battle, but not desirous of it; then more swiftly; and finally by rapid bounds. If compelled to defend himself, the L. manifests great courage. The L. often springs upon his prey by a sudden bound, accompanied with a roar; and it is said that if he fails in seizing it, he does not usually pursue, but retires as if ashamed; it is certain, however, that the L. also often takes his prey by pursuing it, and with great perseverance. The animal singled out for pursuit, as a zebra, may be swifter of foot than the L., but greater power of endurance enables him to make it his victim. Deer and antelopes are perhaps the most common food of lions. The L., like the rest of the *Felidæ*, is pretty much a nocturnal animal; its eyes are adapted for the night or twilight rather than for the day. It lurks generally in its lair during the day, and issues as night comes on, when its tremendous roar begins to be heard in the wilderness. It has a horror of fires and torch-lights; of which travellers in Africa avail themselves, when surrounded by prowling lions in the wilderness by night, and sleep in safety. Lion-hunting is, of course, attended with danger—a wounded and exasperated L. becoming a most formidable adversary—but besides the necessity of it to farmers in South Africa and other countries where lions abound, it has been found attractive to mere sportsmen from the excitement attending it. The rifle has proved too mighty for the L. wherever it has been employed against him, and lions rapidly disappear before the advance of civilisation. In India, they are now confined to a few wild districts; and in South Africa, their nearest haunts are far from Cape Town and from all the long and fully settled regions.

The L. is easily tamed, at least when taken young; and when abundantly supplied with food, is very docile, learning to perform feats which excite the admiration of the crowds that visit menageries. Exhibitions of this kind are not, however, unattended with danger, as too many instances have proved. Lions were made to contribute to the barbarous sports of the ancient Romans; a combat of lions was an attractive spectacle; and vast numbers were imported into Rome, chiefly from Africa, for the supply of the amphitheatre. Pompey exhibited 600 at once.—Lions have not unfrequently bred in the menageries of Europe, and a hybrid between the L. and the tiger has occasionally been produced.

The mane of the L., and the tuft at the end of the tail, are not fully developed till he is six or seven years old. The tail terminates in a small prickle, the existence of which was known to the ancients, and which was supposed by them to be a kind of goad to the animal when lashing himself with his

tail in rage. The prickle has no connection with the caudal vertebra, but is merely a little nail or horny cone, about two lines in length, adhering to the skin at the tip of the tail.

There are several varieties of the L., slightly differing from each other in form and colour, but particularly in the development of the mane. The largest lions of the south of Africa are remarkable for the large size of the head and the great and black mane. The Persian and other Asiatic lions are generally of a lighter colour, and inferior in size, strength, and ferocity to the African lion. Guzerat and the south of Persia produce a somewhat smaller variety, remarkable as being almost destitute of mane.

LION, in Heraldry. The lion holds an important place among the animals borne in coat-armour. As early as the 12th c., the king of beasts was assumed as an appropriate emblem by the sovereigns of England, Scotland, Norway, Denmark, the native princes of Wales, the counts of Flanders and Holland, and various other European potentates. Lions occur in different positions. 1. The earliest attitude of the heraldic lion is *rampant (a)*, erect on his hind-legs, and looking before him, the head being shewn in profile, as he appears in the arms of Scotland, and originally did in those of England. This was the normal position of a lion; but as the royal animal came to be used by all who claimed kindred with royalty, and to be granted to favourite followers by way of augmentation, a diversity of attitude was adopted for distinction's sake. 2. *Rampant gardant (b)*, erect on the hind-legs, and affronté or full-faced. 3. *Rampant regardant (c)*,



erect on the hind-legs, and looking backwards. 4. *Passant (d)*, in a walking position, with the head seen in profile. 5. *Passant gardant (e)*, walking, and with the head affronté. 6. *Passant regardant*, walking, and with the head looking behind. 7. *Stant*, with all the four legs on the ground. 8. *Saliant*, in the act of springing forward on his prey. 9. *Sejant (f)*, rising to prepare for action. 10. *Sejant affronté*, as in the crest of Scotland. 11. *Couchant*, lying down, but with his head erect, and his tail beneath him. 12. *Dormant*, asleep, with his head resting on his fore-paws. 13. *Coward* or *Coulé*, with his tail hanging between his legs. The lion passant gardant is often blazoned as the *lion of England*; and at a time when terms of blazonry were comparatively few, it was confounded with the Leopard (q. v.), and hence the lion passant and rampant gardant came to be called respectively the *lion-leopardé* and *leopard-lionné*. Two lions may be depicted *rampant combatant*—i. e., face to face—or *rampant adossés*, placed back to back. Among leonine monsters, we have two-headed lions, bicorporate and tricorporate lions, lion-dragons and lion-poissons. There is also

the Bohemian lion, with two tails, and the more celebrated winged lion of St Mark, adopted by the republic of Venice. The island republic bore, azure, a lion winged or sejant, holding between his fore-paws a book open argent, in which are the words, *Pax tibi Marce Evangelista meus*. Two or more lions borne on one shield are sometimes (though never when on a royal coat) blazoned *Lioncels*.

LIPARI ISLANDS, a group of volcanic islands in the Mediterranean, twelve in number, are situated between lat. 38° 20' and 38° 55' N., long. 14° 15' and 15° 15' E., on the north coast of Sicily, and comprised in the department of Messina. The intense volcanic action induced the ancient classical poets to localise in these islands the abode of the fiery god Vulcan—hence their ancient name, *Vulcanica Insulae*. Their collective population is about 22,000, 15,000 of whom are found in the island of Lipari, which, for extent and produce, is much the most important of the group. Lipari is about 18 miles in circuit. Its finest products are grapes, figs, olives, and corn. It has a large export trade in pumice-stone, sulphur, nitre, sal-ammoniac, soda, capers, fish, and Malmsey wine, which is largely manufactured both for home and foreign trade. The warm springs of this island are much resorted to. The climate is delightful. Lipari, its chief town, is a bishop's see, possesses two harbours, an episcopal palace, hospital, gymnasium, and a castle built on a fine rock. Pop. 12,000. The island is almost wholly composed of pumice-stone, and supplies all parts of the world with that article. Besides Lipari, the principal islands are Vulcano, Stromboli, Salini, Panaria, Felicudi, Alicudi, and Ustica; Stromboli and Vulcano are actively volcanic.

L'IPETZK, a town in the south-west of the government of Tambov, European Russia, on the right bank of the Voronetz, a tributary of the Don, was founded in 1700 by Peter the Great, but only began to flourish at the commencement of the present century, when the admirable qualities of its chalybeate springs became known. At present, it has a large annual influx of visitors during summer, for whose accommodation a bathing establishment and a splendid garden have been formed. L. has manufactures of woollen cloths. Pop. 12,335.

L'IPOGRAM (Gr. *leipo*, to leave out, and *gramma*, a letter) is a species of verse characterised by the exclusion of a certain letter, either vowel or consonant. The earliest author of lipogrammatic verse was the Greek poet Lasus (born 539 B. c.); and it is recorded of one Tryphiodorus, a Græco-Egyptian writer of the same period, that he composed an *Odyssey* in 24 books, from each of which, in succession, one of the letters of the Greek alphabet was excluded. Fabius Claudius Gordianus Fulgentius, a Christian monk of the 6th c., performed a similar feat in Latin. In modern times, the Spaniards have been most addicted to this laborious frivolity. Lope de Vega has written five novels, from each of which one of the vowels is excluded; but several French poets have also practised it. See Henry B. Wheatley's book on *Anagrams* (1862).

L'IPPÉ, sometimes also (but improperly) LIPPE-DETMOLD, a small principality of Northern Germany, surrounded on the W. and S. by Westphalia, and on the E. and N. by Hanover, Brunswick, Waldeck, and a detached portion of Hesse-Cassel. Area, 432 square miles; pop. (1861) 108,513, nearly the whole of whom belong to the Reformed Church, and are very well educated. The present constitution of L. dates from 15th March 1853; capital, Detmold (q. v.); other towns, Lemgo and

Horn. The famous Teutoburg-Wald (*Saltus Teutoburgensis*), in which the legions of Varus were annihilated by Arminius (see GERMANICUS CÆSAR), runs through the southern part of the principality, which is on the whole rather hilly, but has many fertile valleys. The largest river is the Werra, a tributary of the Weser. The principal occupation of the inhabitants is agriculture, and the rearing of cattle, sheep, and swine; much pains is likewise bestowed on the cultivation and management of forests, as L. is perhaps the most richly wooded district in Germany. Linen weaving is the chief manufacturing industry of the country. Among the mineral products are marble, iron, lime, and salt. The princes of L. are one of the oldest sovereign families of Germany, and were in a flourishing condition as early as the 12th century. The first who took the name of L. was Bernhard von der Lippe, in 1129. The family split into three branches in 1613—Lippe, Brake and Schaumburg.

LIPPI, FRA FILIPPO, a Florentine painter of great talent, the events of whose life were of a very romantic kind. Born about 1412, left an orphan at an early age, he spent his youth as a novice in the convent of the Carmine at Florence, where his talent for art was encouraged and developed. Sailing for pleasure one day, he was seized by corsairs, and carried to Barbary; after some years' captivity, he regained his liberty, and is next found, in 1438, painting at Florence. Filippo was much employed by Cosmo de' Medici, and executed many important works for him. While painting in the convent of Sta Margarita at Prato, a young lady, Lucrezia Buti, a boarder or novice, who had been allowed by the nuns to sit for one of the figures in his picture, eloped with him; and though strenuous efforts were made by her relations to recover her, he successfully resisted their attempts, supported, it is thought, by Cosmo; and she remained with and had a son by him, who became an artist perhaps even more celebrated than Filippo himself. He died at Spoleto, 8th October 1469, being at the time engaged in painting the choir of the cathedral, along with Fra Diamante, one of his pupils.

LIPPI, FILIPPINO FILIPPO, commonly called FILIPPINO LIPPI, the son of Fra Filippo and Lucrezia Buti, was born at Florence in 1460. It is said that his father left him to the care of Fra Diamante, his pupil. He afterwards studied under Sandro Botticelli, also a pupil of his father's, and one of the most celebrated of his school. He soon acquired a high reputation, and executed various works in Florence, Bologna, Genoa, Lucca, and at Rome, where, in 1492, he painted some frescoes for the Cardinal Caraffa, in the church of Sta Maria Sopra Minerva. But the high position he attained is proved principally by his works in the Brancacci Chapel in the church of the Carmine at Florence. The frescoes in this chapel have always been held in the highest estimation; they have been studied by the most celebrated painters, among others by Raphael and Michael Angelo; and though long believed to be entirely the work of Masaccio, are now ascertained to have been commenced by Masolino, continued by Masaccio, and finished by Filippino; the works of the last being—'The restoring of a Youth to Life,' part of which was painted by Masaccio; 'The Crucifixion of St Peter;' 'St Peter and St Paul before the Proconsul;' and 'St Peter liberated from Prison;' also, according to some, 'St Paul visiting St Peter in Prison, in which the figure of St Paul was adopted by Raphael in his cartoon of 'Paul preaching at Athens.' Filippino died at Florence on 13th April 1505.

LIQUEUR. This name is given to any alcoholic preparation which is flavoured or perfumed and sweetened to be more agreeable to the taste; there is consequently a large class of liqueurs, of which the following are the principal: *Aniseed Cordial*, prepared by flavouring weak spirit with aniseed, coriander, and sweet fennel seed, and sweetening with finely clarified syrup of refined sugar. *Absinthe* is sweetened spirit flavoured with the young tops of certain species of *Artemisia* (q. v.). *Clove Cordial*, much sold in the London gin-shops, is flavoured with cloves, bruised, and coloured with burned sugar.

Kümmel, or *Doppel-Kümmel*, is the principal liqueur of Russia; it is made in the ordinary way with sweetened spirit, flavoured with cumin and caraway seeds, the latter usually so strong as to conceal any other flavour. It is chiefly made at Riga, and there are two qualities: that made in Riga is the sort in common use, and is not the finest; the better sort is only manufactured in smaller quantities at Weissenstein, in Eathonia; the chief difference is in the greater purity of the spirit used. *Maraschino* is distilled from cherries bruised, but instead of the wild kind, a fine delicately-flavoured variety, called *Marasques*, grown only in Dalmatia, is used. This cherry is largely cultivated around Zara, the capital, where the liqueur is chiefly made. Great care is taken in the distillation to avoid injury to the delicate flavour, and the finest sugar is used to sweeten it.

Noyau, or *Crème de Noyau*, is a sweet cordial flavoured with bruised bitter-almonds. In Turkey, the fine-flavoured kernels of the Mahaleb cherry are used, and in some places the kernels of the peach or the apricot. *Peppermint*, a common liqueur, especially amongst the lower classes of London where very large quantities are sold; it usually consists of the ordinary sweetened gin, flavoured with the essential oil of peppermint, which is previously rubbed up with refined sugar, and formed into an oleosaccharum, which enables it to mix with the very weak spirit.

Curaçoa and *Kirschwasser* are described under their own names.

LIQUIDAMBAR, a genus of trees of the natural order *Altingiaceæ*, and the only genus of the order, having flowers in male and female catkins on the same tree, the fruit formed of 2-celled, many-seeded



Liquidambar.

capsules, and the seeds winged. They are tall trees, remarkable for their fragrant balsamic products. *L. styraciflua*, the AMERICAN L., or SWEET GUM tree, is a beautiful tree with palmate leaves, a native of

Mexico and the United States. It grows well in Britain. Its wood is of a hard texture and fine grain, and makes good furniture. From cracks or incisions in the bark, a transparent, yellowish balsamic fluid exudes, called *Liquid Liquidambar*, *Oil of Liquidambar*, *American Storax*, *Copalm Balsam*, and sometimes, but erroneously, *White Balsam of Peru*. It gradually becomes concrete and darker coloured. Its properties are similar to those of storax. That of commerce is mostly brought from Mexico and New Orleans.—*L. Orientale*, a smaller tree with palmate leaves, is a native of the Levant and of more eastern regions, and yields abundantly a balsamic fluid, which has been supposed to be the *Liquid Storax* imported from the Levant, but on this point there is diversity of opinion.

LIQUORICE (*Glycyrrhiza*), a genus of perennial herbaceous plants of the natural order *Leguminosæ*, sub-order *Papilionaceæ*; having long, plant, sweet roots, and generally creeping root-stocks; pinnate leaves of many leaflets, and terminating in an odd one; flowers in spikes, racemes, or heads; a 5-cleft, 2-lipped calyx, and a 2-leaved keel. The ancient Greek name, now the botanical name, signifies *sweet root*, and from it, by corruption, liquorice and other modern names are derived. The roots of *L.* depend for their valuable properties on a substance called *Glycyrrhizine*, allied to sugar, yellow, transparent, uncrystallisable, soluble both in water and alcohol, and forming compounds both with acids and bases. They are a well-known article of *materia medica*, and were used by the ancients as in modern times, being emollient, demulcent, very useful in catarrh and



Common Licorice (*Glycyrrhiza glabra*).

irritations of the mucous membrane.—The roots of the COMMON *L. (G. glabra)* are chiefly in use in Europe. The plant has stems 3—4 feet high, and racemes of whitish violet-coloured flowers. It is a native of the south of Europe and of many parts of Asia, as far as China. It is cultivated in many countries of Europe, chiefly in Spain, and to some extent in the south of England, where its cultivation is at least as old as the times of Elizabeth. The roots are extensively employed by porterbrewers. They are not imported into Britain in considerable quantity, but the black inspissated extract of them (*Black Sugar* or *Stick Licorice*)

is largely imported from the south of Europe, in rolls or *sticks*, packed in hay-leaves, or in boxes of about two cwts., into which it has been run. *L.* is propagated by slips; and after a plantation has been made, almost three years must elapse before the roots can be dug up for use. The whole roots are then taken up. *L.* requires a deep, rich, loose soil, well trenched and manured; the roots penetrating to the depth of more than a yard, and straight tap-roots being most esteemed. The old stems are cleared off at the end of each season, and the root-stocks so cut away as to prevent overgrowth above ground next year. The plant is propagated by cuttings of the root-stocks.—The roots of the PRICKLY *L. (G. echinata)* are used in the same way, chiefly in Italy and Sicily, Russia, and the East.—The only American species is *G. lepidota*, which grows in the plains of the Missouri.

LIRA (Lat. *libra*; see **LIVRE**), an Italian silver coin of greater or less value according to time and place. The Tuscan lira was equal to 80 French centimes; the Austrian lira or *zwanziger* was about the same value. The present Lira Italiana, or Lira nuova, of the Italian kingdom is equal to the French franc, and is divided into 100 centimes.

LIRIODENDRON. See **TULIP TREE**.

LISBON (called by the ancient Lusitanians, *Olisipo* or *Ulisippo*, and by the Moors *Lishbuna* or *Ashbuna*), the capital of Portugal, is situated in the province of Estremadura, on the right bank of the Tagus, which is here about six miles wide, and about eighteen miles from the mouth of the river. Pop. 275,300. The city is built partly on the shores of the Tagus, and partly on three larger and four smaller hills. Its appearance is wonderfully picturesque; and its resemblance, in point of situation and magnificence of prospect, to Constantinople, at precisely the opposite extremity of Europe, has been frequently remarked. Including its suburbs, it extends about five miles along the river. The harbour, which is safe and spacious, is protected by strong forts, but the city itself is unwallled and without any fortifications. The eastern and older part, which lies round the Castle-hill—an eminence crowned with an old Moorish castle, destroyed by earthquakes—is composed of steep, narrow, crooked, badly-paved streets, with high, gloomy, wretched-looking houses; but the newer portions are well and regularly built. The most beautiful part is called the *New Town*—it stretches along the Tagus, and is crowded with palaces. Among the places or squares, the principal are the *Praça do Commercio*, on the Tagus, 565 feet long, 520 broad, surrounded on three sides with splendid edifices; the *Praça do Rocio*, in the New Town, forming the market-place, 1800 feet long, and 1400 broad; and the *Passeio Publico*. The whole of the New Town, and the district round the royal castle, is lighted with gas. *L.* has 41 parish churches, 82 monasteries, hospices, and hospitals, 99 chapels, 5 large theatres, and an amphitheatre. The most conspicuous public buildings are the Church of the Patriarch, the Monastery of the Heart of Jesus (with a cupola of white marble), the Church of St Roque (built of marble), the Foundling Hospital (receiving annually about 1600 children), St James's Hospital (capable of receiving 16,000 sick persons), the royal palaces of Ajuda, *Nossa Senhora das Necessidades*, and Bemposta, the custom-houses, the arsenal, and the National Theatre, which occupies the site of the old Inquisition buildings. There are likewise a number of educational and scientific institutions. Among other notable objects, the most important is the Alcântara Aqueduct (called *Os Arcos*, or *Agua livres*, and finished in 1743),

which supplies all the public fountains and wells of the city. It is 18 miles in length, and in one place 260 feet high, and remained uninjured at the great earthquake. It is the greatest piece of bridge-architecture in the world. The manufactures of L. are inconsiderable, but it is the principal trading port of Portugal, and contains 130 foreign commercial firms. In 1861, 1630 vessels entered and cleared the port; and of these, 677 vessels, of 122,191 tons, were British. In the year 1860—1861, the imports, consisting chiefly of cottons, metals, colonial produce, and woollens and furs, amounted to £2,842,853; and the exports, chiefly liquids and animal and chemical products, to £1,297,062. About 30,000 Galegos (Galicians) earn a subsistence here as porters, and in other sorts of hard work.

L. is said to have been founded by the Phœnicians, was a flourishing commercial city when the Romans first became acquainted with it, and the capital of Lusitania. It was taken by the Moors in 712, from whom, after undergoing many vicissitudes, it was recaptured by Alfonso I. in 1147; became the seat of an archbishopric in 1390, and of a patriarchate in 1716. L. has been frequently visited by earthquakes; that of 1755 destroyed a great part of the city and 20,000 of the inhabitants.

LISBURN, a market-town and parliamentary borough, situated on the river Lagan, partly in the county of Antrim, partly in the county of Down, Ireland. It is distant from Dublin 97 miles north-north-east, and 8½ south-south-west from Belfast, with both which places it is connected by the Dublin and Belfast Junction Railway. The population in 1861 was 9653; of whom 4330 were Protestants of the Established Church, 2543 Catholics, and the rest Protestants of various denominations. L. originated in the erection of a castle, in 1610, by Sir Fulk Conway, to whom the manor was assigned in the settlement of James I.; but its importance dates from the settlement of a number of Huguenot families, who, after the revocation of the Edict of Nantes, established themselves at L., where they introduced the manufacture of linen and damask, after the method and with the machinery then in use in the Low Countries. It is a clean and well-ordered town, with a convenient market, and considerable manufactures of linens and damasks; besides which, bleaching, dyeing, flax-dressing, flax-spinning, &c., are carried on. Its parish church is the cathedral of Down and Connor, and is interesting as the burial-place of Jeremy Taylor, who was bishop of that see, and died at L. in 1667. L. returns one member to parliament.

LISIEUX (ancient *Noviomagus Lexovium*), a town of Northern France, on the Touques, 27 miles east-south-east of Caen, at the entrance of a beautiful valley. The principal building is the church of St Pierre (formerly a cathedral), belonging to the 13th c., and built on the site of an older edifice, in which Henry II. of England married Eleanor of Guienne. L. is the centre of an extensive manufacture of coarse linens, woollens, flannels, horsecloths, ribbons, &c., which gives employment to more than 3000 workmen. Pop. 13,000.

LISKEARD, a municipal and parliamentary borough in Cornwall, is situated in a well-cultivated district, on the Looe, 16 miles west-north-west of Plymouth. Two miles to the south of the town is a famous spring, said to have been presented to the inhabitants by St Keyne, and the virtue of whose waters is set forth in Southey's well-known ballad, *The Well of St Keyne*. There are manufactures of serge and leather, and considerable traffic in the produce of the tin, copper, and lead mines of the

neighbourhood. L. returns a member to parliament. Pop. (1861) of parliamentary borough, 6585.

LISMO'RE, an island of Argyleshire, six miles from Oban, is situated in Loch Linnhe, and is 10 miles in length, with an average breadth of 1½ miles. It contains the remains of several interesting buildings, as Achinduin Castle—formerly the residence of the Bishops of Argyll—an old cathedral, and Castle Rachal, a Scandinavian fort, now very ruinous. The island is for the most part under cultivation. Pop. (1861) 853.

L'ISSA (Pol. *Leszna*), a town of Prussia, in the province of Posen, and the circle of Fraustadt, 44 miles south-south-west of Posen. Pop. 10,014, of whom nearly one half are Jews. L. has a fine townhouse, a castle, one Roman Catholic and three Protestant churches, with manufactures of woollens, leather, and tobacco. This place became for a time the chief seat of the Bohemian Brothers.

LIST. See FILLER.

LISTON, ROBERT, a celebrated surgeon, was born at Ecclesmachan, in the county of Linlithgow, in 1794, and was the son of the Rev. Henry Liston, the minister of the parish. After studying anatomy under Barclay in Edinburgh, and following the usual course of medical study in that city, he proceeded to London in 1816, where he attended the surgical practice of the Blizards at the London Hospital, and of Abernethy at St Bartholomew's. After becoming a member of the Royal College of Surgeons of London, he returned to Edinburgh, and in 1818 was elected a Fellow of the Royal College of Surgeons of that city.

L. now commenced his career as a lecturer on anatomy and surgery, and soon became remarkable for his boldness and skill as an operator. In consequence of his performing many successful operations on patients who had been discharged as incurable by the surgeons of the Edinburgh Infirmary, he was requested by the managers to refuse his assistance to any person who had been a patient in that institution, and to abstain from visiting the wards. He naturally declined to accede to these extraordinary propositions, and in consequence was expelled, and never entered again its wards, until in 1827 he was elected one of its surgeons. His surgical skill, and the rapidity with which his operations were performed, soon acquired for him a European reputation; and in 1835, he accepted the invitation of the council of University College to fill the chair of Clinical Surgery. He soon acquired a large London practice; in 1840, he was elected a member of the council of the College of Surgeons; and in 1846, he became one of the Board of Examiners. In the very climax of his fame, and apparently in the enjoyment of vigorous health, he was struck down by disease, and died 7th December 1847.

His most important works are his *Elements of Surgery*, which appeared in 1831, and his *Practical Surgery*, which appeared in 1837, and has gone through four editions. His uncontrollable temper, and the coarseness of language in which he frequently indulged, involved him in various quarrels with his professional brethren; yet, notwithstanding these defects, he always succeeded in obtaining the regard and esteem of his pupils.

LISZT, FRANZ, pianist, was born at Raiding, in Hungary, 22d October 1811. His father, a functionary employed on the estates of Prince Esterhazy, was himself possessed of some musical skill, and carefully cultivated the wonderful talent which L. shewed even in his infancy. In his ninth year, the child played publicly at Presburg, and excited universal astonishment. By the assistance of two Hungarian noblemen—Counts Amadi and

Sapary—L. was sent to Vienna, and placed under the instruction of Czerny and Salieri. He studied assiduously for eighteen months, after which he gave concerts in Vienna, Munich, and other places with brilliant success. In 1823, he proceeded with his father to France, intending to complete his musical education at the Conservatoire; but he was refused admission on account of his being a foreigner; nevertheless, his genius made a way for itself. He played before the Duke of Orleans, and very soon the clever, daring boy became the favourite of all Paris. Artists, scholars, high personages, ladies—all paid homage to his marvellous gift, and it was only owing to his father's strict supervision that young L. was not entirely spoiled. In the course of the next three years, he visited England thrice, and was warmly received. In 1827, his father died at Boulogne, and L. became his own master at the age of sixteen. For some years after this, his life sufficiently proved that he had become independent too soon. Alternations of dissipation and religious mysticism induced his admirers to fear that his artistic course would end in disastrous failure. Fortunately, he heard the famous violinist, Paganini, in 1831, and was seized with a sudden—but, as it also proved, a permanent—ambition to become the Paganini of the piano; and one may say that, on the whole, he has succeeded. Up till 1847, his career was a perpetual series of triumphs in all the capitals of Europe. He then grew tired of his itinerant life, and accepted the situation of leader of the court concerts and operas at Weimar, where he has since resided. In this capacity he has been as successful as in that of a public performer, and has made Weimar one of the musical centres of Europe. L. has also been an industrious and original contributor to musical literature.

LITANY (Gr. *litaneia*, a supplication), a word the specific meaning of which has varied considerably at different times, but which means in general a solemn act of supplication addressed with the object of averting the divine anger, and especially on occasions of public calamity. Through all the varieties of form which litanies have assumed, one characteristic has always been maintained—viz., that the prayer alternates between the priest or other minister, who announces the object of each petition, and the congregation, who reply in a common supplicatory form, the most usual of which was the well-known 'Kyrie eleison!' (Lord, have mercy!) In one procession which Mabillon describes, this prayer, alternating with 'Christe eleison,' was repeated 300 times; and in the capitularies of Charlemagne, it is ordered that the 'Kyrie eleison' shall be sung by the men, the women answering 'Christe eleison.' From the 4th c. downwards, the use of litanies was general. The *Antiphony* of St Gregory the Great contains several. In the Roman Catholic Church, three litanies are especially in use—the 'litany of the saints' (which is the most ancient), the 'litany of the name of Jesus,' and the 'litany of Our Lady of Loretto.' Of these, the first alone has a place in the public service-books of the church, on the rogation-days, in the ordination service, the service for the consecration of churches, the consecration of cemeteries, and many other offices. Although called by the name of litany of the saints, the opening and closing petitions, and indeed the greater part of the litany, consist of prayers addressed directly to God; and the prayers to the saints are not for their help, but for their intercession on behalf of the worshippers. The litany of Jesus consists of a number of addresses to our Lord under his various relations to men, in connection with the several details of his passion, and of adjurations of him

through the memory of what he has done and suffered for the salvation of mankind. The date of this form of prayer is uncertain, but it is referred, with much probability, to the time of St Bernardino of Siena, in the 15th century. The litany of Loretto (see LORSTO) resembles both the above-named litanies in its opening addresses to the Holy Trinity, and in its closing petitions to the 'Lamb of God, who taketh away the sins of the world;' but the main body of the petitions are addressed to the Virgin Mary under various titles, some taken from the Scriptures, some from the language of the Fathers, some from the mystic writers of the medieval church. Neither this litany nor that of Jesus has ever formed part of any of the ritual or liturgical offices of the Catholic Church, but there can be no doubt that both have in various ways received the sanction of the highest authorities of the Roman Church.

In the Prayer-book of the English Church, the litany is retained, but although it partakes of ancient forms, it differs from that of the Roman Church, and contains no invocation of the Virgin or the saints. It is divided into four parts—invocations, deprecations, intercessions, and supplications, in which are preserved the old form of alternate prayer and response. It is no longer a distinct service, but, when used, forms part of the morning prayer.

LITCHI, or LEE-CHEE (*Nephelium Litchi*), one of the most delicious fruits of China and of the Malayan Archipelago. The tree which produces it belongs to the natural order *Lapindacea*, and has pinnate leaves. It is extensively cultivated in the southern provinces of China, and in the northern provinces of Cochinchina, but is said to be impatient of a climate either much more hot or much more cold. The fruit is of the size of a small walnut, and grows in racemes. It is a red or green berry, with a thin, tough, leathery, scaly rind, and a colourless semi-transparent pulp, in the centre of which is one large dark-brown seed. The pulp is slightly sweet, subacid, and very grateful. The Chinese preserve the fruit by drying, and in the dried state it is now frequently imported into Britain, still preserving much richness of flavour.—The *Longan* and *Rambutan* are fruits of the same genus.

LITHARGE. See LEAD.

LITHIA. See LITHIUM.

LITHIC ACID. See URIC ACID.

LITHIC ACID DIATHESIS is the term employed in Medicine to designate the condition in which there is an excess of lithic (or uric) acid, either free or in combination, or both, in the urine. The urine of persons who have the lithic acid diathesis is usually of a dark golden colour, like brown sherry, and is more acid, of higher specific gravity, and less abundant than the urine in health. When the urine cools, there is usually a deposit or sediment of lithates. The sediment is usually spoken of as one of lithate (or urate) of ammonia, but in reality it consists mainly of lithate of soda mixed with lithates of ammonia, potash, and lime. Its colour varies according to the amount and nature of the urine-pigment which tenaciously adheres to it, so that its tints vary from a whitish yellow to a brickdust red, or even a deep purple. Persons seeing these deposits in their urine when it has cooled, are very apt to believe that they may aggregate and harden in the bladder, and form a stone. Such fears may, however, be relieved by heating the urine containing the sediment to the temperature of the interior of the body (about 100°), when the fluid will resume its original clearness, and the sediment will disappear.

The colour of the deposit is of considerable importance in determining its value as a morbid symptom. Tawny or reddish sediments of this kind are frequently the result of mere indigestion or a common cold; the yellowish-white ones deserve more attention, as they are believed frequently to precede the excretion of sugar through the kidneys. The pink or brickdust sediments are almost always associated with febrile disturbance or acute rheumatism; and if these sediments are habitual, without fever, there is most probably disease of the liver or spleen. If the urine is very acid, a portion of the lithic acid is separated from its base, and shews itself, as the fluid cools, in a free crystallised state, resembling, to the naked eye, grains of Cayenne pepper, but appearing under the microscope as rhombic tableta. This free lithic acid is far less common than the lithates, and does not dissolve on the application of heat.

The persons who suffer from this diathesis are chiefly adults beyond the middle age, and of indolent and luxurious or intemperate habits. As the formation of lithic deposits is due to over-acidity of the urine, alkalies are the medicines most commonly prescribed, and the preparations of potash are far preferable to those of soda, because lithate of potash is perfectly soluble, and will pass off dissolved in the urine, while lithate of soda is a hard, insoluble salt.

Regimen is, however, of far more use than medicine in the lithic acid diathesis. The patient should dine moderately and very plainly, avoiding acid, saccharine, and starchy matters and fermented liquors. The skin should be made to act freely by friction, and by occasional warm or daily tepid baths. Warm clothing must be used; plenty of active exercise must be taken in the open air; and the healthy action of the bowels and liver duly attended to. It must be recollected that the lithates are sometimes thrown down, not from undue acidity of the urine, but simply from that fluid not containing the due quantity of water to hold them in solution. In such cases, a tumbler of cold spring-water taken night and morning will at once cause the cessation of this morbid symptom.

LITHIUM (symb. L; equiv. 6·4; sp. gr. 0·5936) is the metallic base of the alkali *lithia*, and derives its name from the Greek word *lithos*, a stone. The metal is of a white silvery appearance, and is much harder than sodium or potassium, but softer than lead. It admits of being welded at ordinary temperatures, and of being drawn out into wire, which, however, is inferior in tenacity to leaden wire. It fuses at 356°. It is the lightest of all known metals, its specific gravity being little more than half that of water; it decomposes water at ordinary temperatures. It burns with a brilliant light in oxygen, chlorine, and the vapours of iodine and bromine. It is easily reduced from its chloride by means of a galvanic battery. Lithium forms two compounds with oxygen, viz., lithia (known also as lithion or lithon), which is the oxide of lithium, and a peroxide of lithium whose formula has not been determined.

Lithia, in a pure and isolated state, cannot be obtained. Hydrate of lithia (LO,HO) occurs as a white translucent mass, which closely resembles the hydrates of potash and soda. The salts of lithia are of sparing occurrence in nature. The minerals petalite, triphane, lepidolite, and tourmaline contain lithia in combination with silicic acid, while triphylite and amblygonite contain it as a phosphate; it is also present in small quantities in many mineral waters.

Carbonate of lithia (LO,CO₂) is precipitated when carbonate of ammonia is added to a strong

solution of chloride of lithium, and occurs as a white mass with a slight alkaline reaction. At a dull red heat, it melts into a white enamel. It requires 100 parts of water for its solution, but is more soluble in water charged with carbonic acid. The solution of the salt has been strongly recommended in cases of gout and gravel, in consequence of the solvent power which it exerts on uric acid. The sulphate, phosphate, and nitrate of lithia are of no special importance. Chloride of lithium (LCl+4 aq.) is readily prepared by dissolving the hydrate of lithia in hydrochloric acid, and evaporating. It crystallises in octohedra, and is one of the most deliquescent salts known. It is of importance as being the source from whence lithium and carbonate of lithia are obtained.

Lithia was discovered in 1817 by Arfvedson. The metal lithium was first obtained in 1822 by Brande, but nothing was known regarding its properties until 1855, when Bunsen and Matthiessen discovered the present method of obtaining it, and carefully investigated its physical and chemical characters.

LITHOGRAPHY (Gr. *lithos*, a stone), the art of printing from stone, was invented by Aloys Senefelder, at Munich, about the end of the 18th century. It consists, first, in writing and drawing on the stone with the pen and brush, with the graver, and with the crayon or chalk; or in transferring to the stone writings and drawings made with the pen or brush on transfer-paper, or impressions from copper, steel, and pewter plates, taken on a coated paper, and then in printing off from the stone the writings or drawings thus made upon it. The principles of the art are these: an unctuous composition having been made to adhere to a calcareo-argillaceous stone, those parts covered by it—i. e., the writing or drawing—acquire the power of receiving printing-ink, whereas those parts not containing the writing or drawing are prevented from receiving ink from the inking-roller by the interposition of water; and lastly, an absorbent paper being laid on the stone, and subjected to strong pressure, copies are obtained.

The best *lithographic stones* are found at Kelheim and Solenhofen, near Pappenheim, on the Danube, in Bavaria; but they have been found also in Silesia, England, France, Canada, and the West Indies. These stones are composed of lime, clay, and silicious earth, and are of various hues, from a pale yellowish-white to a light buff, reddish, pearl-gray, light-gray, blue, and greenish colour. Those of uniform colour are the best. The yellow-buff ones, being soft, are adapted for lettering and transfer; the pearl-gray ones, being harder, for chalk-drawings and engraving. They are found in beds, commencing with layers of the thickness of paper, till they reach the dimensions of one, and several inches in thickness, when they are easily cut, being yet soft in the quarries, to the sizes required for printing purposes. The stones are ground plane with sand, and, when required for the pen, the brush, the graver, or transfer, they are polished with pumice and water-of-Ayr stone; and for chalk-drawings and graduated tints, an artificial grain is given by ground glass or fine sand.

When any writing or drawing has been finished on stone, it then requires to be etched, thus: a mixture of 2 parts of nitric acid, and from 40 to 60 parts of dissolved gum-arabic, is poured over the stone once or several times, according to the nature of the work. The etching changes the surface of the stone, raising the work on it to a degree scarcely perceptible to the naked eye. The writing or drawing, which has been effected by greasy ink or chalk, remains protected from the

action of the acid, and those protected parts retain the natural property of the stone, which is the qualification of receiving printing-ink; and, when the printer wets the stone before applying the inking-roller, the water enters only those parts of the stone which have been affected by the acid, while the ink adheres only to those parts, however fine, on which the acid could not operate, owing to the unctuous composition of the ink or chalk with which the drawing or writing has been done, and which, being greasy, rejects the water. Thus it is called *chemical printing*.

The *chemical ink*, for *writings and drawings in line*, is composed of 2 parts of white wax, 2 shell-lac, 1 hard soap, $\frac{1}{2}$ tallow, $\frac{1}{2}$ carbonate of soda, and 1 of powdered lamp, or better, Paris black. The chemical chalk (crayon) is made of 3 parts of white wax, 2 hard soap, 1 shell-lac, $\frac{1}{2}$ 'drops of' mastic, 1 tallow, $\frac{1}{2}$ old lard, $\frac{1}{2}$ Venetian turpentine, $\frac{1}{2}$ Brunswick black, $\frac{1}{2}$ carbonate of soda, and $1\frac{1}{2}$ of Paris black, properly melted and burned together.

When the *drawing or writing with ink* on a polished stone is completed, the etching is proceeded with, and a portion of the etching composition allowed to dry on the stone. The printer then adjusts his stone in the press, washes off the dried gum, removes the whole drawing or writing with turpentine, wets the stone with a sponge or damping canvas, then applies his roller containing the printing-ink, and rolls it several times over the stone till the lines appear again. When sufficient ink has been applied to the lines, the paper is laid on the stone, drawn through the press, and the impression effected. The damping and inking of the stone are renewed for every impression.

Chalk-drawings are done on the grained stone with the chemical chalk, with the stump and scraper, and sharp lines with ink; so that, if boldly and systematically treated, by giving the effect first, and detail afterwards, there will be produced richness and softness of appearance and freedom of manipulation, and a great many impressions will be yielded.

Tinted drawings, chromo-lithography, and coloured maps require as many stones—grained or polished, as the case may be—as there are various tints or colours, one stone being printed after the other, and so fitted and blended together as to produce, when complete, the effect desired.

Great Britain is famed for *writings, plans, and drawings*, done with transparent quills, steel-pens, and small camel-hair brushes, on *yellow transfer paper*, prepared as follows: 1 part best flake-white, 1 isinglass or gelatine, with a little gamboge to give it colour, are dissolved in water over a slow fire, then sifted through double muslin, and spread *once*, in a very warm state, with a large, flat camel-hair brush on one side of good-sized, smooth, thin paper, which, when dry, requires to be passed frequently over a heated stone, through the press. The paper being drawn or written upon with lithographic ink, is, when finished, put for a few minutes between damp blotting-paper; a warmed stone is put in the press, the sheet is placed with the coated side upon it, and then passed several times through the press; the back of the paper, now adhering to the stone, is then sponged with water; the stone is turned, and passed several times again through the press in the opposite direction, after which the sheet is softened with water, and rubbed with the fingers until it can be easily removed from the stone. Some gum is then put upon it, and a linen rag, dipped in printing-ink, and, with the aid of a little water, passed in all directions over the lines till they appear black and clean. The stone is then allowed to cool, inked up with the roller,

then very slightly etched, and, after being cleaned, is ready for use.

Autography is the name given to a writing or drawing done with the chemical ink on one side of any plain—not coated—paper, for example, bankers' circulars; the transfer is done in the same manner as already described, with the difference, that the sheet, when laid on the stone, is passed only *once* through the press.

Transferring of any writings, maps, drawings in line or music, done on copper, steel, and pewter-plates, and retransferring of any line-work, already on the stone, form a very important part of lithography, as an unlimited number of impressions can be produced at a very moderate expense without wearing out the original plates or stones, and as parts of various plates, stones, and letterpress can be transferred to, and printed from, the same stone. The best *transfer-paper for this purpose* is the following: mix 3 parts of shoemakers' paste (without alum) with 1 part of best ground plaster of Paris, a little dissolved patent glue, and some tepid water; strain the mixture through double muslin in a common jar, and, when cooled, spread it with a large, flat camel-hair brush over half-sized thickish paper. The *ink for taking transfers* is a composition of two table-spoonfuls of printing varnish, $1\frac{1}{2}$ parts of tallow, 3 brown hard soap, 4 brown wax, 5 shell-lac, 5 black pitch, and $2\frac{1}{2}$ parts of powdered lampblack. The various ingredients are melted for 25 minutes, and fire set to the mass for other 15 minutes—afterwards formed in sticks. When the impressions have been made on this coated paper with this transfer-ink, the transfer is accomplished on the stone as already described.

With regard to *engraving and etching on stone, photo-lithography, the application of electrotyping to lithography, the working of the ruling-machine for skies and ornaments, the lithographic steam-press, &c.*, we must refer the reader to special works treating on Lithography.

It may not be out of place to mention, that in the field of lithography Germany occupies the first place for careful execution, France for rich and artistic effect, Britain for transferring, tint-printing, and chromo-printing.

Strixner, Hohe, Hanfstängl, Piloty, Loehle, Locillot, Auer, Leon Noel, Moulleron, Engelmann, Sabatier, Calame, Lasalle, Haghe, Ghémar, Hullmandel, Day, Hanhart, Brooks, Lemerrier, may be mentioned, from among many others, who have helped to perfect lithography.

LITHOLOGY (*lithos*, a stone) is that division of geology which considers the constitution and structure of rocks, apart from their relations in time or position to each other. See GEOLOGY.

LITHOMARGE, an earthy mineral, sometimes called *Mountain Marrow* (Ger. *Steinmark*), consisting chiefly of silica and alumina, with oxide of iron and various colouring substances. It is soft, greasy to the touch, and adheres strongly to the tongue. It is generally white, yellow, or red, often exhibiting very beautiful colours. It is found in Germany, Russia, &c., also in the tin-mines of Redruth in Cornwall.

LITHONTRIPTICS (from the Greek words *lithos*, a stone, and *trido*, I wear out) is the term which is applied to those remedies which, whether taken by the mouth, or injected into the bladder, act as solvents for the stone.

Various medicines have at different times been recommended and employed as solvents for the stone. Rather more than a century ago, limewater and soap, when swallowed in sufficient quantities, had a high reputation as solvents for urinary calculi. These were the only active ingredients in Miss

Stephens's *Receipt for the Stone and Gravel*, which was reported on so favourably by a committee of professional men, that parliament, in 1739, purchased the secret for £5000. The treatment doubtless afforded relief; but there is no evidence that any calculus was actually dissolved, for in the bladder of each of the four persons whose cure was certified in the report, the stone was found after death! At present, no substance, which, taken by the mouth, has the power of dissolving calculi, is known; but as Dr Prout remarks in his well-known treatise, *On the Nature and Treatment of Stomach and Urinary Diseases*, remedies of this class are to be sought 'among harmless and unirritating compounds, the elements of which are so associated as to act at the same time, with respect to calculous ingredients, both as alkalies and acids.' Solutions of the super-carbonated alkalies containing a great excess of carbonic acid—as, for example, the natural mineral waters of Vichy—approach most nearly to what is required. The relief which, in many instances, has followed the administration by the mouth of substances supposed to be lithontriptics, has been derived not from the solution of the calculi, but from the diminution of pain and irritation in the bladder.

On the other hand, considerable success has been obtained by the direct injection of solvents into the bladder, especially when the nature of the calculus is suspected; weak alkaline solutions having apparently caused the disappearance of uric acid calculi, while phosphatic calculi have unquestionably been dissolved by the injection of very weak acid solutions. It is reported that a weak galvanic current has been recently found successful in the hands of an Italian surgeon.

LITHOPHAGIDÆ (Gr. stone-eaters), a term sometimes applied to the molluscs which bore holes for their own residence in rocks. See PHOLAS.

LITHOPHANE (Gr. *phanos*, clear, transparent), a peculiar style of ornamental porcelain chiefly adapted to lamps and other transparencies; it consists of pretty pictures produced on thin sheets of white porcelain by stamping the porcelain, whilst still soft, with raised plaster-of-Paris casts of the pictures intended to be produced. By this means, an intaglio impression is obtained; and when the sheet of porcelain has been hardened by fire, the impression gives a picture, owing to the transparency of the porcelain, which has the lights and shadows correctly shewn, if viewed by transmitted light. Lithophane pictures are common in Germany, where the art has been more favourably received than in France, its native country. They are usually employed to form the sides of ornamental lamps and lanterns, and are sometimes inserted in decorative windows.

LITHOTOMY (Gr. *lithos*, a stone; *tōmē*, the act of cutting), the technical name for the surgical operation popularly called *cutting for the stone*.

As most of the symptoms of stone in the bladder (which are noticed in the article CALCULUS) may be simulated by other diseases of the bladder and adjacent parts, it is necessary to have additional evidence regarding the true nature of the case before resorting to so serious an operation as lithotomy. This evidence is afforded by *sounding* the patient—a simple preliminary operation, which consists in introducing into the bladder, through the natural urinary passage (the urethra), a metallic instrument, by means of which the stone can be plainly felt and heard.

Lithotomy has been performed in various ways at different times. The earliest form of lithotomy is known as *cutting on the gripe*, or *Celsus's method*. It

received the former name from the stone, after being fixed by the pressure of the fingers in the anus, being directly cut upon and extracted; and the latter, from its having been first described, so far as is now known, by Celsus, although it had probably been practised from time immemorial. At a later period, this operation received from Marianus the name of the *apparatus minor* (from a knife and hook being the only instruments used), to distinguish it from his own method, which he called the *apparatus major*, from the numerous instruments he employed. The *Marian method* was founded on the erroneous idea, that wounds of membranous parts would not heal, while their dilatation was comparatively harmless. The object was to do as little as possible with the knife, and as much as possible with dilating instruments; and the necessary result was laceration and such other severe injury, that this became one of the most fatal operations in surgery. Nevertheless, it was the operation mainly in vogue for nearly 200 years, till Frère Jaques, in 1697, introduced what is essentially the method now in use.

The *lateral operation*, so called from the lateral direction in which the incision is made into the neck of the bladder, in order to avoid wounding the rectum, is that which, with various minor modifications, is almost universally employed at the present day. Frère Jaques, a priest, seems to have learned the method from a provincial surgeon named Pierre France, and to have practised it with much success; and, in 1697, he came to Paris in order to make it publicly known. The advantage of this operation, by which a free opening, sufficiently large for the extraction of a stone, can be made into the bladder without laceration of the parts or injury to the rectum, was immediately recognised by the leading surgeons of the time, and the Marian process was at once universally given up.

We can only very briefly indicate the leading steps of the operation. The patient being laid on the table, and chloroform being administered, an instrument termed a curved staff, with a deep groove, is passed into the bladder. An incision is then made on the left side of the mesial line, about an inch and three-quarters in front of the anus, and extending downwards to midway between the anus and the tuberosity of the left ischium. The incision should be sufficiently deep for the operator, on introducing a finger of the left hand, to feel the groove of the staff. The knife, directed by this finger, is now fixed in the groove, and sliding along it towards the bladder, divides the membranous portion of the urethra, the edge of the prostate, and the neck of the bladder. The knife is now withdrawn, as also is the staff, and the surgeon introduces the forceps over the finger of the left hand into the bladder, feels for the stone, and draws it out.

It is unnecessary to enter into any of the details of the after-treatment. At first, the urine escapes through the wound, but in favourable cases it is voided by the natural passage in a week, and the wound heals in the course of a month.

From the shortness of the female urethra and the extent to which it can be dilated, and, additionally, from the comparative rarity of calculous affections in women, the operation of lithotomy is exclusively restricted to the male sex.

The danger of the operation seems to vary with the age of the patient. Out of 186 cases collected by Mr Hutchinson of the London Hospital, 137 were under the age of 20, and of these, 123, or nearly 90 per cent., recovered; while of the 49 who were over 20 years of age, 26, or more than 53 per cent., died.

LITHOTRITY (Gr. stone-crushing), the surgical operation of breaking up a stone in the bladder into

such small fragments that they may readily be expelled by the urethra. Although the importance of such an operation has been recognised from the earliest time, a French surgeon, Civiale, who commenced his researches in 1817, but did not perform his first operation till the beginning of 1824, is entitled to be regarded as the discoverer of lithotripsy. The instrument by which the disintegration of the stone is effected, is introduced in the same manner as a catheter or sound into the bladder, and, after catching the stone, either bores, hammers, or crushes it to pieces.

Crushing is now generally preferred, the stone being grasped by the blades of the instrument shewn in the figure, one blade acting on the other by means of a screw.



The process seems, at first sight, so safe, as compared with the operation of lithotomy, that it is necessary to distinguish those cases in which it may be resorted to, and those in which it is contra-indicated. It may be resorted to when the patient is an adult, and the urethra full-sized and healthy, so as freely to admit the passage of the instrument; when the prostate is not much enlarged, which is very often the case in old men, and when the bladder is not thickened or very irritable: while it must be avoided in children, in consequence of the smallness of the urethra; when there is great irritation and thickening of the bladder; when there is great enlargement of the prostate, which hinders the manipulation of the instrument, and the escape of the broken fragments of stone; when the stone is of large size, as, for example, of a greater diameter than two inches; and when there is reason to believe that the concretion is a mulberry calculus, which, from its extreme hardness, cannot readily be broken. Great care must be taken that no fragment remains in the bladder, as such fragments are almost sure to form the nuclei of fresh calculi.

LITHUANIA, a former grand-duchy, holding of the crown of Poland, which, before the partitions of that country, was composed of three groups of territory: 1. L. proper, or Litva, which formed the governments of Wilna and Troki; 2. The duchy of Samogitia; 3. Russian L., comprising Polesie, Black Russia or Novogrodek, White Russia or Minsk, Meislav, Witebsk, Smolensk, Polotsk, and Polish Livonia. This country contained about 135,000 English square miles, and was partitioned between Russia and Prussia, the latter receiving what is now denominated the government of Gumbinnen, in East Prussia. The Lithuanians, a race to whom belong the Letts of Livonia, the Cours of Courland, and the ancient inhabitants of East Prussia, are probably a Slavonic people, whose original characteristics have been much modified by time and the intermixture of other races. According to Latham, the Lithuanian language approaches nearer to the Sanscrit than any other member of the Aryan group.

L. was at first subject to Russia, but shook off the yoke about the end of the 12th c., and became an independent power. Their rulers, who bore the title of Grand Duke, conquered the neighbouring Russian provinces, and even carried their ravages to the very gates of Moscow. The Grand Duke of L., Jagellon, was in 1386 elected king of Poland, and issued an edict of union between the two countries, and in 1569 the two were declared to be one country.

LITMUS is a well-known colouring matter, which is obtained from several lichens, but chiefly from *Lecanora tartarea*. The lichens are powdered and digested with ammoniacal fluids (urine, for example) till they undergo decomposition. Alum, potash, and lime are then added, and the mixture is allowed to stand till the maximum degree of colour is observed. Sand and chalk are added, to give a due degree of solidity, and the mass is then dried in cubes, and is ready for the market. The exact nature of the changes which ensue is not altogether known; it is, however, certain that the pigment is originally red, and that it only becomes blue on the addition of alkalies or of lime. This blue colour is again changed into a red, on the addition of a free acid.

The use of litmus-paper and tincture of litmus for the purpose of detecting the acidity of fluids, &c., is known to every student of chemistry. See **TEST-PAPERS**.

LITRE, the unit of the present French measures of capacity, both dry and liquid. It is the volume of a cubic decimètre (see **MÈTRE**), and is equal to 0.2200967 British imperial gallon. It is subdivided decimally into the *decilitre*, *centilitre*, and *millilitre* (respectively $\frac{1}{10}$ th, $\frac{1}{100}$ th, and $\frac{1}{1000}$ th of a litre). Ten litres are a *decalitre*; 100, a *hectolitre*; 1000, a *kilolitre*. The *hectolitre* is the common measure for grain, and is equal to 0.3439009 British imperial quarter, or nearly $2\frac{1}{2}$ imperial bushels.

LITTLE FALLS, a village of New York, United States of America, on the Mohawk River, 91 miles north-west of Albany, on the line of the Erie Canal, and New York Central Railway. The Mohawk here passes through a romantic defile of two miles in length, with falls of forty-two feet, giving water-power to four paper-mills, two woollen factories, flouring-mills, &c. The village has nine churches, a bank, newspapers, and manufactures of starch, shoes, &c. Pop. in 1860, 5989.

LITTLE ROCK, the capital of Arkansas, United States of America, is situated on the south bank of the Arkansas River, 300 miles from its mouth, on the first bed of rocks bounding the alluvial valley of the Mississippi. It contains the state capitol, an arsenal, penitentiary, and five churches. Founded in 1820. Pop. in 1860, 3727.

LITTLETON, or **LYTTLETON**, **SIR THOMAS**, a celebrated English jurist, was born early in the 15th c. (the exact year is not known), studied—it is thought probable—at Cambridge, after which he removed to the Inner Temple. Henry VI. appointed him steward or judge of the Court of the Palace, and in 1455 king's serjeant, in which capacity he travelled the northern circuit. In 1466, he was made one of the judges of the Court of Common Pleas; and in 1475, he was created Knight of the Bath. He died August 23, 1481. L.'s fame rests on his work on *Tenures*, which was originally written in Norman-French, and first published about the time of his death. It went through a multitude of editions. The first translation into English was made in 1539, and in the course of the next hundred years it went through no less than 24 editions. The changes in the laws relative to property have greatly diminished its value, and it is now little studied by lawyers; yet it is considered a model on account of the clear and logical manner in which the subject is handled.

LITURGY (Gr. *leitourgia*, a public service), in general, signifies a form of prayer and ceremonial established by ecclesiastical authority, to be used in the public services of the church, but is especially applied to that used in the celebration and administration of the Eucharist. The very earliest historical records of Christianity plainly shew that such forms

were in use in the primitive times, but it seems highly probable that for a considerable period they were not reduced to writing; and hence even those of the extant liturgies which represent the earliest forms differ considerably from each other, if not in the substance of the rite, at least in the arrangement even of those parts which are common to them all. A theological discussion of the subject of the liturgy, though, of course, most important in a doctrinal point of view, and most interesting for the study of Christian antiquities, would be out of place in a popular cyclopædia. The liturgies form the great stronghold of the Catholic controversialists on the subject of the real presence and of the eucharistic sacrifice; but we must confine ourselves to a brief historical account of the various liturgies now extant, and of their connection with the various ancient Christian communities, whether of the East or of the West. Liturgies may, indeed, best be distributed into two classes, those of the East, and those of the West.

1. *Oriental Liturgies.*—The Oriental liturgies are six in number, four of which are derived from the great churches in which they were used; the fifth from the Armenian Church, which early formed a distinct liturgy; and the sixth from the great Syrian sect of Nestorius, by which the liturgy was modified to suit its own peculiar tenets. These liturgies are severally known as the liturgies of Jerusalem, of Antioch, of Alexandria, and of Constantinople, the Armenian liturgy, and the Nestorian liturgy. The diversities of these liturgies, although very great in appearance, yet can hardly be said to be substantial. Certain leading parts are common to them all, and are found in all without substantial variation; but they are arranged in a different order, and, except in the form of the eucharistic consecration, the hymn Trisagion, and a few other details, the form of words is often entirely dissimilar. The liturgy of Jerusalem, although ascribed to St James, is of uncertain origin and date; nor is it well ascertained whether its original language was Syriac or Greek. The latter is the language in which it is now found, and the present liturgy closely corresponds in the main with that which formed the text of St Cyril of Jerusalem in his well-known *Mystagogical Lectures*. The liturgy of Antioch exists in Syriac, but it is evidently only a free translation of the liturgy of Jerusalem. The ancient liturgy of Alexandria is ascribed to St Mark; but the existing liturgy has received numberless additions at later dates, and has been modified by both the great sects of this patriarchate to suit their peculiar doctrines. Several other liturgies are in use among the Copts, under the name of St Basil, St Gregory, and St Cyril; and the Abyssinian Christians have no fewer than ten, which are distinct, at least in name. The church of Constantinople has two different liturgies, both of great antiquity, that of St Basil, and that of St Chrysostom. These, however, are not indiscriminately used, each being employed on special occasions or on certain defined festivals. The liturgy of Constantinople is the original of the Slavonic liturgy, which is used in the Russian and Russo-Greek Church, and in its various branches. The Armenian liturgy dates from the introduction of Christianity into Armenia under Gregory the Illuminator. It is in most respects derived from that of St Chrysostom. The Nestorians have three liturgies—the liturgy of the Apostles, the liturgy of Theodorus of Mopsuestia, and the liturgy of Nestorius. These, however, are all combined into one, each being assigned to a particular season, or used on special occasions. The language of all is Syriac.

2. *Western Liturgies.*—The liturgies of the West present much less variety, and indeed are all derived

either from the eastern liturgies or from a common source. The Catholic liturgies may be reduced to four—the Roman, the Milanese or Ambrosian, the Gothic or Mozarabic, and the Gallic liturgies. The oldest forms of the Roman liturgy are to be found in three so-called sacramentaries—that of Leo, that of Gelasius, and that of Gregory the Great. It is the last that has left its impress most clearly on the modern Roman missal, which was brought to its present shape by a commission ordered by the Council of Trent, after a careful revision and collation of all the liturgical forms in use in the West in the 16th century. The first revision took place under Pius V., and two subsequent revisions were made by Urban VIII. and Clement VIII. The Ambrosian liturgy is used only in the diocese of Milan, and is popularly traced to St Ambrose. It bears a close analogy to the Roman liturgy, but it has many peculiarities, some of which are highly interesting, as illustrating the history of the details of Christian worship. Its ceremonial, which is observed with great solemnity in the cathedral of Milan, is in some parts highly striking and characteristic. The Gothic or Mozarabic is of still more limited use, being now confined to a single chapel at Toledo, founded and endowed for the purpose by the celebrated Cardinal Ximenes. It is the old liturgy of the Gothic Church of Spain; and after the infusion of the Arabic element, which followed the Moorish invasion, it was called by the name of Mozarabic, a word of disputed etymology. This liturgy is certainly of Oriental origin; but its history, and the time and circumstances of its introduction into Spain, have furnished matter for much speculation. Some parts of the rite are exceedingly curious, especially those which accompany the breaking of the host. The Gallican liturgy has no precise modern representative, and is only known from ancient forms, more or less complete, which have been edited by Mabillon, and recently by Mone. The older Gallican forms bespeak an Oriental origin, and are probably derived from the Greek Christian colony which settled at Marseille, Lyon, and the other churches of the south. The later forms approximate more to the Roman. Neither of these, however, is to be confounded with the more modern missals in use in several of the French dioceses, which do not differ from the Roman except in minor details, and most of which have now been displaced by the Roman missal. Of Protestant communities, the Anglican Church alone professes to follow the ancient liturgical forms (see COMMON PRAYER, BOOK OF). See Renaudot's *Orientalium Liturgiarum Collectio*, 1740, 2 vols.; Assemani's *Bibliotheca Orientalis*; Palmer's *Antiquities of the English Liturgy*; Binterim's *Denkwürdigkeiten der Christ-Katholischen Kirche*.

LITURGY, JEWISH, in the narrower sense of a ritual of fixed prayers, chiefly for public worship. The Mosaic records contain an ordinance respecting the 'confession of sins' (Lev. v. 5; xvi. 21), without, however, prescribing a distinct form for the purpose. Three formulas only are fixed—the benediction of the priests (Num. vi. 24–26), the prayer of thanksgiving on the occasion of the first offering (Deut. xvi. 5–10), and that which was to accompany the offering up of the third year's tithe, beginning: 'I have brought away the hallowed things out of my house' (ib. 13–15). Although prayers are often mentioned before the Exile, yet they do not seem, except in the cases mentioned, to have been introduced as yet as a regular element into the service of the Temple. The songs of the Levites (1 Chr. xvi. 4; xxiii. 3), and occasional prayers, such as are to be found in the Psalms, or like that of Solomon at the inauguration of the Temple, are all we find recorded. Private devotions

were common (cf. 1 Kings, viii. 30, &c.; Is. i. 15), but every one prayed when his heart prompted him in the words inspired by his joy or sorrow. Not before the time of Daniel is a fixed institution of three daily prayers mentioned (Dan. vi. 11). The task of compiling a liturgy proper, and of fixing the times and seasons of prayer, was probably first undertaken by the men of the Great Synagogue. Two chief groups around which, as time wore on, an enormous mass of liturgical poetry has clustered, are distinctly discernible—the one, the *Shemah*, ('Hear, Israel, &c.'), being a collection of the three biblical pieces (Deut. vi. 4—9; xi. 13—21; Num. xv. 37—41) expressive of the unity of God and the memory of His government over Israel, strung together without any extraneous addition; the second, the *Tefillah*, or Prayer, by way of eminence (adopted into Islam as *Salawat*, Sur. ii. 40; cf. v. 15), consisting of a certain number of supplications with a hymnal introduction and conclusion, and followed by the priestly blessing. The single portions of this prayer gradually increased to eighteen, and the prayer itself received the name *Shemonah Ezer* (Eighteen). The first additions to the *Shemah* formed the introductory thanksgiving for the renewed day, in accordance with the ordinance that every supplication must be preceded by a prayer of thanks, called *Jozer* (Creator of Light, &c.), to which were joined the *three Hodies* (*Ofan*), and the supplication for spiritual enlightening in the divine law (*Ahaba*). Between the *Shemah* and the *Tefillah* was inserted the *Golah* (Liberation), or praise for the miraculous deliverance from Egypt and the constant watchings of providence. A *Kaddish* (Sanctification), and certain psalms, seem to have concluded the service of that period. This was the order of the *Shaharith*, or morning prayer; and very similar to this was the *Maarib*, or evening prayer; while in the *Minha*, or afternoon prayer, the *Shemah* was omitted. On new moons, Sabbath and feast days, the general order was the same as on week days; but since the festive joy was to overrule all individual sorrow and supplication, the intermediate portion of the *Tefillah* was changed according to the special significance and the memories of the day of the solemnity, and additional prayers were introduced for these extraordinary occasions, corresponding to the additional sacrifice in the temple, and varying according to the special solemnity of the day (*Mussaf*, *Nellah*, &c.). The first compilation of a liturgy is recorded of Amram Gaon (870—880 A. D.); the first that has survived is that of Saadja Gaon (d. 942 A. D.). These early collections of prayers generally contained also compositions from the hand of the compiler, and minor additions, such as ethical tracts, almanacs, &c., and were called *Siddurim* (Orders, Rituals), embracing the whole calendar year, week-days and new moons, fasts and festivals. Later, the term was restricted to the week-day ritual, that for the festivals being called *Machzor* (Cycle). Besides these, we find the *Selichoth*, or Penitential Prayers; *Kinoh*, or Elegies; *Hoshanah*, or Hosannahs (for the seventh day of the Feast of Tabernacles); and *Bakashoth*, or Special Supplications, chiefly for private devotion.

The public prayers were for a long time only said by the public reader (*Chazan*, *Shekach Zibbur*), the people joining in silent responses and amens. These readers by degrees—chiefly from the 10th c.—introduced occasional prayers (*Piutim*) of their own, over and above those used of yore. The materials were taken from Halacha (q. v.) as well as from Haggada (q. v.); religious doctrine, history, saga, angelology, and mysticism, interspersed with biblical verses, are thus found put together like

a mosaic of the most original and fantastic, often grand and brilliant, and often obscure and feeble kind; and the pure Hebrew in many cases made room for a corrupt Chaldee. We can only point out here the two chief groups of religious poetry—viz., the Arabic on the one, and the French-German school on the other hand. The most eminent representative of the Pajtanic age (ending c. 1100) is Eleazar Biribi Kalir. Among the most celebrated poets in his manner are Meshulam b. Kalonymos of Lucca, Solomon b. Jehuda of Babylon, R. Gerson, Elia b. Menahem of Mans, Benjamin b. Serach, Jacob Zom Elem, Eliezer b. Samuel, Kalonymos b. Moses, Solomon Isaaki. Of exclusively Spanish poets of this period the most brilliant are—Jehuda Halevi, Solomon ben Gabirol, Josef ibn Abitur, Isaac ibn Giat, Abraham ibn Ezra, Mose b. Nachman, &c. When, however, in the beginning of the 13th c., secret doctrine and philosophy, casuistry and dialectics, became the paramount study, the cultivation of the *Piut* became neglected, and but few, and for the most part insignificant, are the writers of liturgical pieces from this time downwards.

According to the different countries, the order and even the contents of the cycle differed, since not all liturgical pieces had been incorporated uniformly. We have thus—to name a few out of many—the rituals of Germany (Poland), of France, Spain, and Portugal (Sefardim), Italy (Rome), the Levant (Romagna), and even of some special towns, like Avignon, Carpentras, Montpellier. The rituals of Barbary (Algiers, Tripoli, Oran, Morocco, &c.) are of Spanish origin. The Judæo-Chinese liturgy, it may be observed by the way, consists only of pieces from the Bible. The Jewish liturgy has, in its various forms, very frequently been commented upon, and has been translated into nearly every modern language.

We may add, in conclusion, that Liturgy forms at this moment the centre of a great contest within the pale of Judaism. The 'reformers' of more or less advanced tendencies are intent upon shortening the prayers, and principally upon abrogating the greater part of the *Piut*, as an artificial excrescence hurtful to true devotion.

LIUTPRAND, or LUTPRAND, an author to whom we owe much of our knowledge of the history of the 10th c., was born in Italy about the year 922. He was educated at the court of King Hugo, and entered into the service of his successor, Berengarius; but falling into disgrace at court about 955, resided for some years at Frankfurt-on-the-Maine, followed the Emperor Otto I to Italy in 961, and was made Bishop of Cremona, and afterwards sent on an embassy to Constantinople. He died about 970. His *Antapodosis* treats of the period from 886 to 948. He wrote also *De Rebus Gestis Ottonis Magni Imperatoris*, and *De Legatione Constantinopolitana*. The best edition of his works is that in the third volume of the *Monumenta Germaniæ Historica* (Hanov. 1839). Compare Köpke, *De Vita et Scriptis Liutprandi* (Berl. 1842).

LIVADIA, the name given under the Turkish régime to the ancient Hellas (q. v.) or Greece (q. v.) north of the Mores.

LIVADIA (ancient, *Lebadeia*), a town of Greece, nomarchy of Attica and Boeotia, is situated on the little stream Hercyna, about 60 miles north-west of Athens, and three miles west of the Copaic Lake. Pop. 5000. Here are the famous cave and oracle of Trophonius, and the fountains of Lethe and Mnemosyne.

LIVER, THE, is the largest gland in the body; it weighs from three to four pounds, and measures

LIVER.

about twelve inches from side to side, and six or seven inches from its anterior to its posterior border. It is situated in the right hypochondriac region, and reaches over to the left; being thick and indented behind, where it crosses the convex bodies of the vertebrae; convex on its upper surface, where it lies in the concavity of the diaphragm; and concave below, where it rests against the stomach, colon, and right kidney. This lower surface presents a fissure dividing the organ into a right and a left lobe.

The liver is retained in its position by five ligaments. Besides the right and left lobe, there are

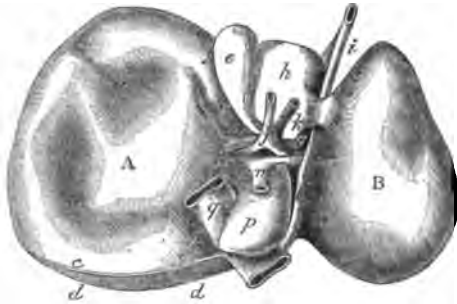

The Liver:

A, right lobe; B, left lobe; a, depression for colon; b, depression for right kidney and capsule; cc, coronary ligament, inferior layer; dd, surface uncovered by peritoneum; e, gall-bladder; ff, fissure for gall-bladder; gg, transverse fissure; h, lobulus quadratus; i, umbilical vein; j, hepatic duct; k, hepatic artery; l, ductus venosus; mm, fissure for ductus venosus; n, vena portae; o, lobulus caudatus; p, lobulus Spigelii; q, inferior vena cava; r, fissure for inferior vena cava; ss, longitudinal fissure.

three smaller lobes. The great bulk of the organ is, however, made up of the right lobe, which is six times as large as the left.

The vessels of the liver are the hepatic artery, which comes off from the Cœliac Axis (q. v.), and supplies the organ with nutrient blood; the Portal Vein, which conveys to the liver the venous blood of the intestines, spleen, and stomach, and from which (after the vessel has ramified like an artery) the bile is secreted;* the hepatic veins, which convey the blood from the liver into the inferior vena cava; the hepatic duct, which carries off the bile from the liver; and the lymphatics.

The liver, both on its surface and internally, is of a dark reddish tint, which is so well known that the term *liver-coloured* is universally recognised. The substance of the organ is composed of lobules held together by extremely fine areolar tissue, and ramifications of the minute branches of the various hepatic vessels. Each lobule is composed of a mass of hepatic cells, of a plexus of biliary ducts, of a portal plexus (from the contents of which the cells obtain the biliary matters that are found in their interior), of a branch of the hepatic vein, and of minute arteries. The exact mode in which the bile formed in the cells makes its way into the origin of the ducts, is not known with certainty. The numberless minute ducts gradually run into one another, until, as they emerge from the lower surface of the liver, they are reduced to two large trunks, which soon unite (see fig.) to form the hepatic duct. Into the hepatic duct, the cystic

* Recent investigations throw doubt on this view, and there are reasons for believing that the bile is secreted from the capillaries of the hepatic artery, while the portal blood contributes the material from which the liver-sugar or glycogen is formed or secreted.

duct from the neck of the gall-bladder (presently to be described) enters, and the two combine to form the common duct (*Ductus communis choledochus*), which opens into the duodenum (see DIGESTION). This common excretory duct of the liver and gall-bladder is about three inches in length, and of the diameter of a goose-quill.

The chemical composition of the liver has been studied by Dr Beale, who finds that the organ in health contains 68·6 per cent. of water, and 31·4 per cent. of solid constituents—of which 3·8 are fat, 4·7 albumen, while the rest is made up of vessels, salts, and extractive matters. (In the diseased condition known as fatty degeneration of the liver—which, by the way, is artificially induced in the geese which contribute to the formation of Strasburg Pie, or *pâté de foie gras*—the fat is enormously increased; in one remarkable case analysed by Dr Beale, it amounted to 65·2 per cent. of the whole weight of the organ.) Sugar, varying in amount from 1 to 2 per cent., is also found; and inosite, uric acid, sarcine, xanthine, and leucine usually occur in traces.

The gall-bladder may be regarded as a *diverticulum* or offshoot from the hepatic duct. It has somewhat the shape of a pear, and lies in a depression on the under surface of the liver. Its use seems to be to serve as a reservoir for the accumulation of the bile, when its flow into the intestine is interrupted, as it is always found full after a long fast, and empty when digestion is going on. That the gall-bladder is not an essential appendix to the liver, is shewn by the fact that it is absent in many genera of mammals. Thus, it is present in the ox, sheep, and goat, but absent in the horse and many other herbivora.

It was formerly believed that the liver served merely for the separation of the biliary secretion from the blood; but there is now abundant evidence that the blood itself is changed by its means, in such a way as to shew that this gland possesses an *assimilating* as well as a *depurating* action. Thus, the albuminous matter contained during digestion in the blood of the veins which pass from the intestine to the portal vein (the mesenteric veins), is very different from the albuminous matter contained in the hepatic veins; the blood, before reaching the liver, containing a crude albuminous product, while the hepatic veins contain only true blood-albumen. That the liver possesses an assimilating power on albuminous substances is also shewn by the experiments of Claude Bernard, who found that if a solution of egg-albumen be injected into any part of the systemic circulation, albumen speedily appears (like other soluble substances which are foreign to the body) in the urine, and is eliminated as an extraneous matter; but if it be injected into the portal vein, it does not appear in the urine, but becomes a normal constituent of the blood (blood-albumen), through the agency of the liver. It is now also known, that if the liver does not secrete a true sugar, as Bernard supposed, it at all events secretes a substance closely allied to, and readily convertible into sugar—viz. Glycogen (q. v.)—which must be regarded as a respiratory or heat-forming food. Further, it appears from Bernard's researches that fatty matters are elaborated in the liver—the blood of the hepatic veins which leave the liver containing considerably more fat than that of the portal vein which enters it. Some of this fat is doubtless burned off in the lungs; but if a deficient supply should be introduced by the lacteals, some of it would doubtless be applied to the formative processes. Lastly, during the last three days of incubation of the chick, the liver is made bright-yellow by the absorption of the yolk, which enters

LIVER—LIVERPOOL.

the branches of the portal vein, and is then converted partly into *blood-corpules*, which enter the circulation, and partly into bile, which is discharged into the intestine. Hence, there is distinct evidence, from several points of view, that the liver is an *assimilating* organ. The *depurating* action of this organ is exhibited in the secretion of Bile (q. v.), by which the hydro-carbonaceous portion of the effete matters of the blood is removed, just as the nitrogenous portion is eliminated by the kidneys. The use of the bile in the digestive process is sufficiently explained in the article DIGESTION.

Our limited space does not allow of our noticing at any length the comparative anatomy of this important gland, which first shews itself in the form of yellowish-brown cells in the polypes, and gradually becomes more concentrated and developed in the echinoderms, annelides, nudibranchiate gastropods, insects, crustaceans, air-breathing molluscs, cephalopods, fishes, reptiles, birds, and mammals. Till we arrive at the vertebrated classes, it consists of tubes or follicles containing cells, which stand to them in the relation of an epithelium, and its structure is easily made out; but when, as in the vertebrata, it is mainly composed of a solid parenchyma, made up of lobules, each of which is composed of aggregations of cells surrounded by the alternate ramifications of the ducts and other vessels, it presents an anatomical complexity which it is almost impossible to unravel.

LIVER, DISEASES OF THE. *Congestion* of the liver is one of the most frequent of its morbid conditions. It is most commonly caused by obstruction to the passage of the blood from the hepatic veins, arising from thoracic disease impeding the circulation through the right side of the heart. The congestion may be relieved at this stage, or may, by its obstructive action, cause congestion of the portal branches, in which case we have the liver much enlarged, the complexion dusky, the urine high coloured, sedimentary, and scanty, and often more or less dropsy of the abdomen or lower extremities. The treatment must be left entirely to the physician.

Inflammation of the liver has been already noticed in the article HEPATITIS.

Another important affection of the liver is that which is known by the name of *Cirrhosis* (Gr. *kirrhos*, yellowish). It begins as an inflammatory affection, in which lymph (see INFLAMMATION) is effused in the areolar tissue surrounding the branches of the portal vein. The smaller branches become obliterated by the pressure, and as the lymph subsequently contracts, larger branches of the veins and ducts become strangulated, and the surface of the organ assumes the uneven or bossed appearance known as *hob-nailed*. In this affection, the liver is at first somewhat enlarged, but as the contraction of the effusion goes on, it at length becomes considerably smaller than the natural size. The ordinary cause of this disease is spirit-drinking, and it is popularly known as *the gin-drinker's liver*. The obstruction to the portal circulation occasions the effusion of serum into the peritoneal cavity; and this effusion often goes on so rapidly as soon to force up the diaphragm and impede respiration. The lower extremities soon become anasarous, but the arms and face are never affected. The portal obstruction often also gives rise to hæmorrhage from the bowels or stomach.

In a fully developed case of cirrhosis, the liver is so altered in structure that palliative treatment is all that can be attempted. This must be directed to the relief of the dropsy, and if medicines fail to remove or diminish it, temporary relief may be obtained by tapping. The disease is at best a very hopeless one.

Amongst the other affections of this organ are the *fatty liver*. The liver in this case is much enlarged, of a white colour, and rounded at the edges; it is most commonly found associated with phthisis. Closely allied to this is the *lardaceous* or *waxy* liver, in which the deposited matter is not fat, but something between fat and albumen; it chiefly occurs in scrofulous young persons. Tubercle, different forms of cancer, and Hydatids (q. v.) are not unfrequently found in this organ. In connection with the present subject, the reader is referred to the article JAUNDICE.

LIVERPOOL, situated on the north bank of the Mersey, Lancashire, is, after London, the largest town in the United Kingdom, and, taken in connection with Birkenhead, on the opposite side of the Mersey, it ranks in maritime importance before the metropolis itself—a circumstance due to its position on the west coast of England, not only as a port for the adjacent manufacturing districts, but for the traffic with America. It is situated at one hour's distance by railway from Manchester, six hours from London and Edinburgh, and eight hours by steam from Dublin. The rise of Liverpool is remarkable. In the middle of the 14th c., it contained only 840 inhabitants and 168 cottages; whilst in 1561 its population was only 690. It was not until 1647 that it was made a free port (having been subject down to that date to the Chester officers); whilst its distinct individuality as a parish was not declared until 1697, when its population numbered about 5000 souls, and its shipping about 80 vessels. Between 1710 and 1760, its population increased from 8160 to 25,780; and its commercial navy from 84 vessels to 1245 vessels. In 1700, its first regular dock was built, on the site where the Custom-house stands at the present day. From 1760 to 1800, the population advanced from 25,700 to 77,700 inhabitants; the shipping from 1200 vessels to 5000 vessels; and the amount of dock dues collected, from £2300 to £28,300; nearly two-thirds of the increase taking place during the last 15 years of the period. The rapid progress of the cotton trade was the chief cause of this almost sudden improvement. Simultaneously with the mechanical revolution brought about by Hargreaves, Arkwright, Crompton, and others, there came an increased foreign trade, and an augmented inland business, owing to the opening of the Bridgewater Canal in 1773. About the same period, too, a great start was given to the ship-building trade of the port, by several extensive orders received from the government: some 15 vessels of war being launched between 1777 and 1782, of very considerable tonnage, and ranging between 16 and 50 guns. By this time, L. had far outstripped Bristol in commercial importance: the trade of the latter port being in process of rapid transference to the former. The following statement will shew how far L. was benefited by the cotton trade:

Years.	Raw Cotton.		Cotton Manufactures.	Population.	Vessels.	Dock Duties Collected.
	Imported. lbs.	Exported. lbs.	Exported. £		No.	£
1781	5,198,778	96,788	365,000	35,000	2300	5,000
1791	31,447,805	363,442	1,875,000	50,000	4800	10,000
1800	43,378,378	4,416,610	6,040,000	77,000	5000	28,000

LIVERPOOL.

But this progress, important as it was, has been far exceeded by the subsequent increase of business, and at the present time L. stands at the head of British commercial ports, and has no equal in the world. Its rapid growth will be seen from the following table :

Years.	Population.	Vessels.	Tonnage.	Dock Dues.
1801	77,708	5,080	450,719	£22,365
1831	305,573	13,537	1,502,436	183,465
1861	443,938	21,095	4,977,373	444,417

The following table will shew that the export trade of L. is nearly equal to the entire trade of the remaining ports of the United Kingdom :

DECLARED REAL VALUE OF BRITISH AND IRISH PRODUCE AND MANUFACTURES EXPORTED IN 1860.

	Total.	Per Cent. of Whole.
From Liverpool,	£65,419,723	43·14
London,	30,537,688	22·69
Hull,	14,328,787	10·87
Glasgow,	5,480,308	4·05
Hartlepool,	4,831,328	3·40
Southampton,	3,682,076	2·86
Newcastle,	1,803,498	1·40
Cardiff,	1,695,631	1·25
Leith,	1,050,680	·77
Folkstone,	1,044,484	·77
All others,	6,798,977	5·09
Total from the United Kingdom,	135,691,237	100·00

This gigantic trade has given being to a magnificent system of docks, extending along the margin of the river for a distance of about 5 miles, containing 48 docks and basins, covering an area of over 700 acres, and having nearly 17 miles of quay space. The whole of these docks have, with the exception of the Salthouse, King's, part of the George's, and part of the Queen's, been built since 1812. They were erected chiefly under the superintendence of the late Jesse Hartley, Esq., and are considered by all who have seen them to be one of the greatest engineering triumphs of the present century. Several of the docks are enclosed with large warehouses: the erection of those round the Albert Dock cost £358,000, and the dock itself £141,000. In addition to the usual pier approaches there are two large floating landing-stages, one of which is 1002 feet in length, 82 feet in width, and 4500 tons in weight. In the general traffic of L., that carried on by large steam-vessels with New York, Boston, Halifax, and other ports on the American continent, has deservedly attained celebrity, and draws large numbers of passengers to the town.

The approaches to the town on the land sides are the Lancashire and Yorkshire, East Lancashire, London and North-Western, and Great Northern Railways. There are three tunnels under the town in connection with the London and North-Western Railway, taking different directions, varying from a mile and a half to two miles and a half in length. The passenger stations in Lime Street and Tithebarn Street are large and handsome buildings; the latter is raised on arches at a considerable elevation from the level of the town.

The architecture of the town has been wonderfully improved within the past quarter of a century, and especially during the last ten years of the period, and it now possesses many fine thoroughfares, thronged with numerous splendid edifices. There are several large and elegant squares in the east, or fashionable part of the town, and a number of thoroughfares, lined with the private residences of the merchants and tradesmen; whilst the outskirts of the town are studded with the mansions of the commercial aristocracy. Of what may be termed the official buildings—the Town Hall, St

George's Hall, Custom-house, Sailors' Home, Police-offices, Workhouses, Baths and Wash-houses, Water-works, and Gas Offices, are the most noteworthy; next follow the various literary and educational edifices, such as the Free Library and Museum, presented to the town by Sir William Brown, at a cost of something like £40,000; Botanic and Zoological Gardens, Observatory, the Collegiate Institution, Queen's College, Medical Institute, Royal Institution, the various schools attached to the national and other churches, Society of Fine Arts, Academy of Fine Arts, Egyptian Museum, the Exchange, Lyceum, and Athenæum, newsrooms and libraries, and numerous associations devoted to commercial, political, and religious affairs. That the inhabitants are not niggardly, is proved by the fact that there are no less than 96 charitable institutions in the borough devoted to the alleviation of the various evils that flesh is heir to. Amongst the more prominent are the Royal Infirmary, Northern and Southern Hospitals, Industrial Schools, Blue Coat Orphan Schools, Male, Female, and Infant Orphan Asylums and Church; School, Workshops, and Church for the Blind; Deaf and Dumb, and Eye and Ear, Institutions; Homœopathic and other dispensaries; Lying-in and other hospitals. Visitors will find no lack of hotel accommodation, with such immense establishments as the Adelphi, Washington, Waterloo, Queen's, Grand Junction, Royal, Angel, and a score or two of minor importance. The buildings dedicated to amusements are quite in keeping with the other characteristics of the town. Under this head, there are the Philharmonic Hall, capable of accommodating 3000 people; the Amphitheatre, calculated to hold 5000; the two concert-rooms of St George's Hall, before alluded to, the larger of which is acknowledged to be one of the finest rooms in the kingdom; the Theatre-Royal; Prince of Wales' Theatre; Adelphi Theatre; Hengler's Circus, &c. The religious wants of the community are supplied by about 150 churches and chapels, of which 48 belong to the Established Church, 14 to Roman Catholics, 21 to Presbyterians, 16 to Wesleyans, 15 to Independents, 11 to Baptists, and 25 to miscellaneous Nonconformists, including 3 Unitarian, 2 Jewish, 1 German, and 1 Greek. There are eight cemeteries, one only of which is situated within the town, namely, St James's, Duke Street, the remainder being laid out in the suburbs.

The buildings devoted to commercial pursuits are also very fine and numerous, and not the least interesting to the stranger. Amongst these are the Exchange, the Albany, Apsley, Brown's, Richmond, Hargreaves (the last three recently erected by Sir William Brown), Liverpool and London Insurance Chambers, Royal Insurance, and Queen Insurance buildings (all local companies), Royal Bank, Walmer, Drury, Tower, India, and Brunswick buildings, and many others. There are 13 banks in the town, besides two or three others just started, and several of them are possessed of very large and handsome business premises. Amongst these may be named the branch of the Bank of England, and the Royal, Liverpool, Union, District, Commercial, and North and South Wales banks. In the principal streets there are also several very extensive trade establishments, second to none out of London, and devoted to every department of business, wholesale and retail. Of monuments the chief are those of Nelson, Wellington, Huskisson, and William IV., besides several in the Town Hall, St George's Hall, Free Library, and parks. The parks are two in number, the Prince's in Toxteth, and the Botanic, Wavetree.

The stated market days are Wednesday and Saturday, for general agricultural produce, and

Tuesday and Friday for corn. The fairs for horses and cattle are held July 25th and November 11th. The corn trade transacts its business in the Corn Exchange, Brunswick Street, and there is an extensive market for the cattle-dealers in Kensington. For edibles of all kinds there are St John's Market, 183 yards long, 43 yards wide, and lighted by 136 windows; St James's, Gill Street, and St Martin's markets; there is also a fish market, and several fancy bazaars.

There are 4 daily and 9 weekly newspapers, besides the *Daily Telegraph* and *Bill of Entry*, exclusively devoted to shipping matters, and two weekly literary periodicals.

In general industry, there are several extensive ship and boat-building yards, iron and brass foundries, chain-cable and anchor smithies, steam-engine workshops, tar and turpentine distilleries, rice and flour mills, saw-mills, cigar manufactories, breweries, sugar refineries, soap manufactories, roperies, glass works, alkali works, chronometer and watch manufactories.

LIVERY, in English Law, denotes the act of giving or taking possession. It is most frequently used in the phrase 'livery of seisin,' corresponding to the Scotch infestment or sasine.

LIVERY (from Lat. *liberatio*), a word applied in its origin to the custom which prevailed under the Merovingian and Carlovingian kings, of delivering splendid habits to the members of their households on great festivals. In the days of chivalry, the wearing of livery was not, as now, confined to domestic servants. The duke's son, as page to the prince, wore the prince's livery, the earl's son bore the duke's colours and badge, the son of the esquire wore the livery of the knight, and the son of the gentleman that of the esquire. Cavaliers wore the livery of their mistresses. There was also a large class of armed retainers in livery attached to many of the more powerful nobles, who were engaged expressly to use the strong hand in their masters' quarrels. By the colours and badge of the retainer was known the master under whom he served. The livery colours of a family are taken from their armorial bearings, being generally the tincture of the field, and that of the principal charge, or the two tinctures of the field are taken instead, where it has two. They are taken from the first quarter in case of a quartered shield. These same colours are alternated in the Wreath (q. v.) on which the crest stands. The royal family of England have sometimes adopted colours varying from the tinctures of the arms. The Plantagenets had scarlet and white; the House of York, murrey and blue; white and blue were adopted by the House of Lancaster; white and green by the Tudors; yellow and red by the Stuarts, and by William III.; and scarlet and blue by the House of Hanover. An indispensable part of the livery in former times was the Badge (q. v.). The Church of Rome has its liveries for apostles, confessors, martyrs, virgins, and penitents.

The freemen of the 91 guilds or corporations which embrace the different trades of London, are called liverymen, because entitled to wear the livery of their respective companies. In former times the wardens of the companies were in use yearly to deliver to the Lord Mayor certain sums, twenty shillings of which was given to individuals who petitioned for the money, to enable them to procure sufficient cloth for a suit, and the companies prided themselves on the splendid appearance which their liveries made in the civic train. The common-councillors, sheriffs, aldermen, and some other superior officers of the city, are elected by the liverymen of London; and down to the passing of

the Reform Bill in 1832, they had the exclusive privilege of voting at the election of the members of parliament for the City.

LIVINGSTONE, DAVID, African traveller and missionary, is a native of Scotland, and was born at Blantyre, in Lanarkshire, in the year 1817. At the age of ten he became a 'piccer' in a cotton-factory, and for many years was engaged in hard work as an operative. An evening school furnished him with the opportunity of acquiring some knowledge of Latin and Greek, and, finally, after attending a course of medicine at Glasgow University, and the theological lectures of the late Dr Wardlaw, professor of theology to the Scotch Independents, he offered himself to the London Missionary Society, by whom he was ordained as a medical missionary in 1840. In the summer of that year he landed at Port Natal in South Africa. Circumstances made him acquainted with the Rev. Robert Moffat, himself a distinguished missionary, and whose daughter he subsequently married. For 16 years L. proved himself a faithful and zealous servant of the London Missionary Society. The two most important results achieved by him in this period were the discovery of Lake Ngami (August 1, 1849), and his crossing the continent of South Africa, from the Zambesi (or Leambye) to the Congo, and thence to Loando, the capital of Angola, which took him about 18 months (from January 1853 to June 1854). In September of the same year he left Loando on his return across the continent, reached Lanzasanti (in lat. 18° 17' S., and long. 23° 50' E.), the capital of the great Makololo tribe, and from thence proceeded along the banks of the Leambye to Quilimane on the Indian Ocean, which he reached May 20, 1856. He then took ship for England, where he arrived December 12th of the same year. The reception accorded him by his countrymen was most enthusiastic. Probably no traveller was ever more affectionately honoured. This was owing not merely to the importance of his discoveries—though it would be difficult to overestimate such—but to the thoroughly frank, ingenuous, simple, and manly character of the traveller. In 1857, L. published his *Missionary Travels and Researches in South Africa*, a work of great interest and value. 'In all his various journeys,' said Sir Roderick Murchison, at a meeting of the Royal Geographical Society, held shortly after L.'s return, 'he had travelled over no less than 11,000 miles of African territory. . . . By his astronomical observations he had determined the sites of numerous places, hills, rivers, and lakes, nearly all of which had been hitherto unknown, while he had seized upon every opportunity of describing the physical features, climatology, and geological structure of the countries which he had explored, and had pointed out many new sources of commerce as yet unknown to the scope and the enterprise of the British merchant.' In 1858, the British government appointed him consul at Quilimane, whither he returned in the course of the year. A portable steam-boat has been constructed for his use in this country, and L., with several scientific associates, and a crew of natives, started a few years ago up the Zambesi, with the view of making discoveries in the unexplored territory south of the equator. Accounts of his progress are occasionally received—the latest dating June 20, 1863, from which it appears that L. was (on February 27) near Murchison Falls, on the Zambesi, bent on the further exploration of the great Lake Nyassa.

LIVIVS, TITUS, the most illustrious of Roman historians, was born at Patavium (Padua), in 61

B. C., according to Cato, but, according to Varro, in 59 B. C., the year of the great Cæsar's first consulship. We know nothing of his early life, except that for some time he practised as a rhetorician, and wrote on rhetoric. There is internal evidence, well handled by Niebuhr, which makes it probable that he did not commence his great historical work till he was drawing near middle age. He had ample time to finish it, for he lived to see his eightieth year; and having been born under the republic, died under Tiberius. His fame was so thoroughly established and widely spread, even during his lifetime, that a Spaniard travelled from Gades to Rome only to see him. Quintilian, in claiming for the Romans equal merit in the department of history with the Greeks, compares L. to Herodotus, and there is no doubt that his countrymen regarded him as their greatest historical writer. The story that Asinius Pollio pretended to discover a certain provincialism or *Patavinity* in his style, is probably false; but even if it be true, modern criticism is unable to discover in what the peculiarity consisted; for L.'s work is one of the greatest masterpieces of Latin, or of human composition. Originally, the Roman history of L. was comprised in 142 books, divided into *tens* or *decades*; but only 30 books, with the greater part of 5 more, now exist. Instead of a complete narrative from the foundation of the city to the historian's own time, we have detailed portions, the most valuable of which are the first decade, containing the early history, and the third containing the wars with Hannibal. Among the surviving fragments of what is lost, is a character of Cicero, preserved in the *Suasoria* of Seneca, the execution of which makes us deeply regret that time has not spared L.'s account of the transactions of his own period.

In classing L. in his proper place among the great historians of the ancient and modern world, we must not think of him as a critical or antiquarian writer—a writer of scrupulously calm judgment and diligent research. He is pre-eminently a man of beautiful genius, with an unrivalled talent for narration, who takes up the history of his country in the spirit of an artist, and makes a free use of the materials lying handiest, for the creation of a work full of grace, colour, harmony, and a dignified ease. Professor Ramsay has remarked, that he treats the old tribunes just as if they were on a level with the demagogues of the worst period; and Niebuhr censures the errors of the same kind into which his Pompeian and aristocratic prepossessions betrayed him. But this tendency, if it was ever harmful, is harmless now, and was closely connected with that love of ancient Roman institutions and ancient Roman times which at once inspired his genius, and was a part of it. And the value of his history is incalculable, even in the mutilated state in which we have it, as a picture of what the great Roman traditions were to the Romans in their most cultivated period. The literary talent most conspicuous in L. is that of a narrator, and the English reader perhaps derives the best idea—though it is but a faint one—of his quality, from the histories of Goldsmith, or the *Tales of a Grandfather* of Sir Walter Scott. He does not rival Tacitus in portraiture or in tragic power, but no writer has ever surpassed him in the art of telling a story; and the speeches which, according to the antique fashion, he puts into the mouths of his historic characters, are singularly ingenious, pointed, and dramatically real. There is also something in a high degree winning and engaging about what we may call the moral atmosphere of L.'s history, which nobody can read without feeling that the historian had a kindly tender disposition—a large, candid, and generous

soul. The *editio princeps* of L., which did not contain all that we now have of the work, was published at Rome about 1469, and MSS. of parts of L. were existing in that century which have since disappeared. The most celebrated editions are those of Gronovius, Crevier, Drakenborch, and Ruddiman; and, in recent times, esteemed recensions of the text have been issued by Madvig, Alschefski, and Weissenborn.

LIVIVS ANDRONICUS, the father of Roman dramatic and epic poetry, was a Greek by birth, probably a native of Tarentum, and flourished about the middle of the 3d c. B. C. He translated the *Odyssey* into Latin Saturnian verse, and wrote tragedies, comedies, and hymns after Greek models. Mere fragments are extant, of which a collection may be found in Bothe's *Poetæ scenici Latini* (vol. 5, Halberst., 1823); and Düntzer's *Livii Andronici Fragmenta Collecta et Illustrata* (Berlin, 1835).

LIVNY, an ancient district town of Great Russia, in the government of Orel, in lat. 52° 25' N., long. 37° 37' E. Pop. 10,838, who carry on an extensive trade in corn, cattle, and honey.

LIVONIA, one of the three Baltic provinces of Russia, to which belong also the islands of Oesel, Man, and Runo, contains an area of 17,688 square miles, with a population of 883,681. The country is mostly flat, and one-fourth of it is covered with wood. The soil is only of moderate fertility; but nevertheless agriculture, and cattle and sheep breeding, are brought to a high degree of perfection. L. has many extensive factories and distilleries belonging to the government, also some cloth manufactories, one of which, situated near Pernau, is very extensive. The inhabitants of the country are of Finnish and Lettish descent; those in the towns are chiefly Germans, with a slight sprinkling of Russians, Poles, and Jews. L., up till the 17th c., included the three modern Baltic provinces of Courland, Livonia, and Esthonia.

LIVRE, the name of an ancient French coin, derived from the Roman *Libra*, or *As* (q. v.). There were livres of different values, the most important being the *Livre Tournois* (of Tours), which was considered the standard, and the *Livre Parisis* (of Paris), which was equal to $\frac{4}{5}$ ths of a livre Tournois. In 1795, the livre was superseded by the franc (80 francs = 81 livres Tournois).—LIVRE was also the ancient French unit of weight, and was equal to 17.267 oz. avoirdupois; the kilogramme (see GRAMME) has taken its place.

LIXIVIATION (Lat. *lix*, ashes), a term employed in chemistry to denote the process of washing or steeping certain substances in a fluid, for the purpose of dissolving a portion of their ingredients, and so separating them from the insoluble residue. Thus, wood-ash is lixiviated with water to dissolve out the carbonates of soda and potash from the insoluble parts. The solution thus obtained is called a *lixivium*, or *ley*.

LIZARD (*Lacerta*), a genus of saurian reptiles, the type of a numerous group, in which *Monitors* (q. v.), &c., are included, and to which the *Megalosaurus* and other large fossil saurians are referred. The name L. is indeed often extended to all the saurian reptiles; but in its more restricted sense it is applied only to a family, *Lacertida*, none of which attain a large size, whilst most of them are small, active, brilliantly coloured, and bright-eyed creatures, loving warmth and sunshine, abounding chiefly in the warmer parts of the Old World. They have a long, extensile, forked tongue; the body is generally long, and terminates in a rather long tail; the feet have each five toes, furnished with claws;

the upper parts are covered with small imbricated scales; the scales of the under parts are larger; a collar of broad scales surrounds the neck; the bones of the skull advance over the temples and orbits; the back part of the palate is armed with two rows of teeth. They feed chiefly on insects. Britain produces only two well-ascertained species; the SAND L. (*L. agilis* or *L. stirpium*), about seven inches long, variable in colour and marking, but generally



1, Viviparous Lizard; 2, Sand Lizard.

sandy-brown on the upper parts, blotched with darker brown, and having a lateral series of black, rounded spots, each of which has a yellowish-white dot or line in the centre; and the COMMON L., or VIVIPAROUS L. (*Zootoca vivipara*), smaller, more slender, very variable in colour, a dark-brown generally prevailing on the upper parts. The former species is comparatively rare; it inhabits sandy heaths: the latter is abundant in dry moors and sand-banks. They differ remarkably in the former being oviparous, the latter, viviparous, or, more strictly speaking, ovoviviparous. Both are harmless creatures, as are all the rest of this family. Larger species are found in the more southern parts of Europe. Some of the lizards are quite susceptible of being tamed. They are remarkable for the readiness with which the end of the tail breaks off; the flinging of a glove or handkerchief on one when it is trying to make its escape, is often enough to cause the separation of this portion, which lies wriggling, whilst the animal hastens away. The lost portion is afterwards reproduced. Lizards become torpid in winter.

LIZARD, in Heraldry, means either—1. The reptile usually so called; or, 2. A beast somewhat resembling the wild-cat, and said to be found in several countries of Northern Europe, represented with brown fur, and large spots of a darker shade.

LIZARD POINT. See CORNWALL.

LLAMA. See LAMA.

LLANDA'FF (*Llan Taff*, the place of a church on the Taff), a city of South Wales, in the county of Glamorgan, is situated on the right bank of the Taff, 3 miles above Cardiff, in a district remarkable for its beauty. It is the seat of a bishopric, the revenue of which is £4200. Pop. about 700.

LLANDU'DNO, a watering-place of rising importance in the county of Caernarvon, North Wales, is situated between the Great and Little Orme's Heads, 40 miles west-south-west of Liverpool. The air is described as 'delicious,' and there is every facility for sea-bathing. Pop. (1861) of parish, 2316.

LLANE'LLY, a parliamentary borough, manufacturing town, and seaport of South Wales, in the county of Caermarthen, and 16 miles south-east of the town of that name. The mineral wealth of the vicinity, and the easy access to the sea, have raised the town to considerable commercial importance. The Cambrian copper-works employ a great number of the inhabitants; but there are also silver, lead, iron, and tin works, and a pottery. Coal is largely exported. In 1862, 5745 vessels of 417,289 tons entered and cleared the port. Pop. (1861) of parliamentary borough, 11,446.

LLANGO'LLEN, a small town of North Wales, in the county of Denbigh, picturesquely situated on the right bank of the river Dee, 22 miles south-west of Chester. It is visited by tourists on account of the beauty of the famous Vale of L., and for its antiquities, among which is the fragment of the round inscribed Pillar of Elisay.

LLA'NIDLOES, a municipal and parliamentary borough of North Wales, in the county of Montgomery, 19 miles west-south-west of the town of that name. Its church is one of the most beautiful in Wales. Considerable manufactures of flannel and other woollen fabrics are carried on. L. unites with several other boroughs in sending a member to parliament. Pop. (1861), 3127.

LLA'NOS are vast steppes or plains in the northern portion of South America, partly covered with tall luxuriant grass, and partly with drifting sand, and stocked with innumerable herds of cattle. They resemble the more southern Pampas (q. v.), and the North American Savannahs (q. v.). The inhabitants, a vigorous race of shepherds, are called Llaneros.

LLORENTE, JUAN ANTONIO, a Spanish historian, was born at Rincon del Soto, near Calahorra, March 30, 1760. He was educated by his maternal uncle, and received orders in 1779. He took his degree in canon law, and was named successively advocate of the Council of Castile in 1781, vicar-general of Calahorra (1782), and finally secretary of the Inquisition in 1789. L. was from an early period attached to the liberal party. On the fall of Jovellanos, he was deprived of his employments, and remained in disgrace till 1805, when he recovered favour as the reward of a literary service of a very questionable character which he rendered to Godoy, by a historical essay against the liberties of the Basque Provinces. On the intrusion of the Napoleon dynasty, L. became a zealous partizan of the French, and an active instrument of the French policy, to which he lent all his support at the press, as well as in office; and being obliged to fly, on the restoration of Ferdinand, he fixed his residence in Paris, where he published the work to which his celebrity is chiefly due—his *Critical History of the Inquisition*. This work, which professes to be founded on authentic documents, although throwing much light on a subject previously inaccessible, has, in the judgment of impartial historians, as Prescott, Ranke, and others, lost most of its value by its plainly partizan character, and by the exaggerations in which it abounds. See INQUISITION. Written by L. in Spanish, it was translated into French, under the author's eye, by Alexis Pellier (Par. 1817—1818), and has been translated into most of the European languages. L. published, during his residence in Paris, several other works, some literary, as his *Critical Observations on Gil Blas*; some polemical, as his *Portraits Politiques des Papes*; and others, it is alleged, of a more questionable character in a moral point of view. His work on the popes led to his being compelled to quit Paris

in 1822, and a few days after he reached Madrid he died, February 5, 1823. He was also the author of *Memoirs of the Spanish Revolution*, 3 vols. 8vo, 1819, and an *Essay on a Religious Constitution*, 1819. Most of his works were published both in Spanish and in French.

LLOYD'S, a set of rooms on the first floor of the Royal Exchange, London, frequented by merchants, ship-owners, underwriters, &c., for the purpose of obtaining shipping intelligence, and transacting marine insurances. One large room, with small rooms attached to it, is set apart for the use of the *underwriters*, and there two enormous ledgers lie constantly open, the one containing a list of vessels *arrived*, the other recording disasters at sea. In the same series of rooms there is a self-registering anemometer and anemoscope for the use of the underwriters; also a valuable collection of charts for consultation. See INSURANCE, MARINE. The extent of business transacted here may be imagined when we consider that the amount annually insured amounts to about £40,000,000. None but members of L. who have duly paid the fees, are allowed to transact business there either as insurance-brokers or underwriters. The shipping intelligence is furnished by agents appointed for the purpose, and there is scarcely a port of consequence where one is not stationed. The agent receives no salary, his labour being amply compensated by the advantages he derives from the connection. The intelligence contained in the ledgers is also diffused over the country every afternoon by the publication of *Lloyd's List*. There are two other rooms—the *Reading Room*, which is merely an extensive news-room; and the *Captains' Room*, where auctions of ships are carried on, and where captains and merchants can meet together in a sociable manner. The society of L. is managed by a committee of twelve, selected from among the members, who also appoint the agents and officials of the establishment. The expenses are defrayed by fees and annual subscriptions.

Lloyd's Register of British and Foreign Shipping is a volume published annually, and containing information respecting vessels, their age, materials, repairs, owners, captains, &c. This information is supplied by salaried agents at the different ports. The office of the *Register* is quite distinct from L. of the Exchange.

The name *Lloyd's*, which is now generically applied, arose from the circumstance that the headquarters of the London underwriters was originally Lloyd's coffee-house.

LLOYD'S, AUSTRIAN, an association for general, commercial, and industrial purposes, was founded in Trieste by Baron Bruck in 1833, to supply the want experienced by the maritime insurance companies of that port, of a central administration to attend to their common interests. This association, like its London prototype, has agents in all the principal foreign ports, whose duty it is to collect all information of a nature to affect the commerce and navigation of Trieste, and to keep a list of all entrances and clearances of ships at their respective ports. This information is published in the *Giornale del Lloyd Austriaco*. This company has established regular communication between Trieste and all the important seaports in the Adriatic and Levant, by means of a large fleet of steamers, which also carry the Austrian mails. The society of A. L. includes three sections: the first is composed of insurance companies, the second of steam-boat companies, while the third or scientific department (established in 1849), has a printing-press, an engraving-room, and an artistic

establishment for the perfecting of engraving on copper and steel. This last section has issued a great number of journals and periodicals of a literary and scientific description.

LOACH (*Cobitis*), a genus of fishes of the family *Cyprinida*, having an elongated body, covered with small scales, and invested with a thick mucous secretion; a small head, a small toothless mouth surrounded with 4–10 barbules; small gill-openings, and three branchiostegous rays. One species, the COMMON L. (*C. barbata*), called in Scotland the *Beardie*, is common in rivers and brooks in Britain. It seldom exceeds four inches in length; is yellowish-white, clouded, and spotted with brown; feeds on worms and aquatic insects; and is highly esteemed for the table. It generally keeps very close to the bottom of the water.—The LAKE L. (*C. fossilis*) of the continent of Europe, is sometimes a foot long, with longitudinal stripes of brown and yellow. It inhabits the mud of stagnant waters, coming to the surface only in stormy weather. The flesh is soft and has a muddy flavour.

LOADSTONE, or MAGNETIC IRON ORE, a mineral consisting of a mixture of peroxide of iron and protoxide of iron; sometimes occurring in grains, as *Iron Sand*, in trap rocks, sometimes in beds in primitive rocks, as in Scandinavia, where it is a valuable ore of iron. It is remarkable for its highly magnetic quality; and indeed magnetism was first known as belonging to it. It is of a black colour; and occurs in concretions, and crystallised in octahedrons and rhomboidal dodecahedrons.

LOAM (Ger. *Lehm*, allied to Lat. *limus*, mud, and to *lime*, *slime*), a term much employed by agriculturists and others, to designate a soil consisting of a mixture of clay, sand, and lime, with animal and vegetable matters in a state of intimate mixture. The clay varies from 20 to 50 per cent.; the proportion of lime is generally not more than 5 per cent. Loamy soils are among the best and most fertile of soils. They are not stiff and tenacious like clay soils, and they are much more fertile than sandy soils. Even in mere *mechanical* properties, they are superior to both. The 'clay' used for making bricks is often really a loam in which the proportion of true clay is large. In Italy, France, and other countries, walls are made of L. beaten down between planks placed at the requisite width; and these walls become very solid, and last for centuries.

LOAN OF MONEY is an implied contract, by which B, the borrower, agrees to repay L, the lender. There are various modes by which B gives an acknowledgment for a loan, as by giving a bond or a promissory-note, or L. O. U. (q. v.), the last of which requires no stamp. But no writing is necessary to constitute the contract, which may be proved by parol, and often is proved by the lender's oath, confirmed by circumstantial evidence or letters of the borrower. The debt must in general be sued for in six years in England and Ireland. In Scotland, a borrower is much more favoured, for there are only two ways of proving the loan if it exceeds £8, 6s. 8d., viz., by some writing of the borrower, or by staking the truth as to whether the money is really due on the borrower's oath. Hence, if a hundred witnesses saw the loan advanced, but there was no writing, or the borrower, when put to it, denied it on oath, he can escape liability entirely.

LOANGO, a maritime kingdom of South-West Africa, extends on the coast from Cape Lopez, in lat. 0° 44' S., to the river Congo or Zaire, which separates it on the south from the country of Congo.

Forests cover a great portion of the country, which is mountainous towards the south-east. On the coast the surface is level and fertile; the interior is not yet well known. Formerly, the chief trade was in slaves; ivory and wax now form the chief exports. The inhabitants are skilful in the manufacture of baskets, variously-dyed mats, grass-cloth, wooden spoons, figures, &c. At the town of Kabinda, near the north bank of the Congo (pop. from 10,000 to 18,000), boats and canoes, the former almost equal to those of English make, are built. Trade is free to all nations. The king is considered a divinity, and the government is an absolute despotism. Polygamy prevails, and a man's wives are, at his death, handed down by inheritance, like the rest of his goods. The religion is an idolatrous superstition. Loango, the chief town, is situated 130 miles north of the mouth of the Congo River, near the coast. The pop., including the villages in the vicinity, amounts to about 20,000.

LOASACEÆ, a natural order of exogenous plants, natives of America, and chiefly from the temperate and warmer parts of it. There are about seventy known species, herbaceous plants, hispid with stinging hairs. They have opposite or alternate leaves, without stipules, and axillary 1-flowered peduncles. The calyx is 4-5-parted; the petals 5, or, by an additional inner row, 10; often hooded. The stamens are numerous, in several rows, sometimes in bundles. The ovary is inferior, 1-celled; the fruit capsular or succulent.—Some of the species are frequently to be seen in hothouses and flower-gardens. The genus *Loasa* sometimes receives the popular name of **CHILI NETTLE**.

LOBELIA, a genus of exogenous plants of the natural order *Lobeliaceæ*. This order is nearly allied to *Campanulaceæ*, one of the most conspicuous differences being the irregular corolla. It contains almost 400 known species, natives of tropical and temperate climates, abounding chiefly in damp woods in America and the north of India. They are



Indian Tobacco (*Lobelia inflata*).

generally herbaceous or half-shrubby, and have a milky juice, which is often very acrid, and often contains much caoutchouc. A poisonous character belongs to the order, and some are excessively acrid, as *Tupa Fuillei*, a Chilean and Peruvian plant, of which the very smell excites vomiting; yet the succulent fruit of one species, *Centropogon Suri-*

namensis, is eatable.—The genus *Lobelia* is the only one of this order of which any species are British. The **WATER L.** (*L. Dortmanna*) is frequent in lakes with gravelly bottom, often forming a green carpet underneath the water with its densely matted, sub-cylindrical leaves. The flowers are blue, the flowering stems rising above the water.—To this genus belong many favourite garden-flowers, as the beautiful **CARDINAL FLOWERS** (*L. cardinalis*, *L. fulgens*, and *L. splendens*) and the **BLUE CARDINAL** (*L. syphilitica*), natives of the warmer parts of North America, perennials, which it is usual to protect during winter in Britain. To this genus belongs also the **INDIAN TOBACCO** of North America (*L. inflata*), an annual, with an erect stem, a foot high or more, with blue flowers, which has been used as a medicine from time immemorial by the aborigines of North America, and was introduced into this country, in 1829, by Dr Reesee. Both the flowering-herb and the seeds are imported. It is the former, compressed in oblong cakes, which is chiefly employed. The chemical constituents of *L.* are not accurately known. A liquid alkaloid, *Lobeline*, and a peculiar acid, to which the term *Lobelic acid* has been applied, have been obtained from it.

In small doses, it acts as diaphoretic and expectorant; in full doses (as a scruple of the powdered herb), it acts as a powerful nauseating emetic; while in excessive doses, or in full doses, too often repeated, it is a powerful acro-narcotic poison. It is the favourite remedy of a special class of empirics, and consequently deaths from its administration are by no means rare. Physicians seldom prescribe it now, except in cases of asthma.

In a case of poisoning by this drug, the contents of the stomach should be withdrawn as speedily as possible. If the stomach-pump is not at hand, an emetic of sulphate of zinc or of mustard should be administered.

LOBIPEDIDÆ, a family of birds of the order *Gralla*, nearly allied to *Rallidæ* (Rails, Crakes, Gallinules, &c.), but differing in having the toes separately margined on both sides with a scolloped membrane, thus forming an interesting connecting link with the web-footed birds, or order *Palmipedeæ*. The general appearance of many of the *L.* also approaches to that of the *Anatidæ*. Coots and phalaropes are examples of this family. They are all aquatic, some of them frequenting fresh, and others salt water; some often found far out at sea on banks of sea-weed.

LOBLOLLY-BOY, the name applied on board ship to the man who assists the medical officers in the 'sick-bay,' or hospital.

LOBSTER (*Homarus*), a genus of Crustaceans, of the order *Decapoda*, sub-order *Macrourea* (see **CRAYFISH**), differing from Crayfish (*Asiacus*), to which, in general form and characters, they are very similar, in having the *rostrum* in front of the carapace not depressed, but straight, and armed with many teeth on each side, and the last ring of the thorax not movable, but soldered to the preceding one. The **COMMON L.** (*H. vulgaris*), found in great plenty on rocky coasts of Britain and most parts of Europe, is too well known to require description. It sometimes attains such a size as to weigh twelve or fourteen pounds, when loaded with spawn, although a lobster of one pound weight, or even less, is deemed very fit for the market. It is needless to say how highly the *L.* is esteemed for the table. It is in best season from October to the beginning of May. Its beautifully clouded and varied bluish-black colour changes to a nearly uniform red in boiling. It is found in greatest abundance in clear water of no great depth, and displays great activity in retreating from danger, using its powerful tail-fin for

swimming, or almost springing through the water, and thrusting itself into holes of the rocks which seem almost too small to admit its body. The claws are powerful weapons of defence; one is always larger than the other, and the pincers of one claw are knobbed on the inner edge, those of the other are serrated. It is more dangerous to be seized by the serrated than by the knobbed claw. Lobsters are sometimes caught by the hand, which requires dexterity; but they are more frequently taken in traps of various kinds, sometimes made of osier twigs, sometimes a kind of nets, sometimes pots, but always baited with animal garbage. Vast quantities of lobsters are sent to market, chiefly to London, from the coasts of all parts of Britain, including the utmost Shetland Isles and Hebrides. Lobsters are very voracious; they are also very pugnacious, and have frequent combats among themselves, in which limbs are often lost; but the loss is soon repaired by the growth of a new limb, rather smaller than the old one. Like crabs, they frequently change their shelly covering, and, for a short time before their moulting, are very languid and inert. Their growth takes place during the time when the shell is soft, and with extraordinary rapidity.—The AMERICAN L. (*H. Americanus*) has claws much larger in proportion than the common lobster.—The NORWAY L. (*Nephrops Norvegicus*) is frequently taken on the British coasts, and appears in the markets.



Norway Lobster (*Nephrops Norvegicus*).

The eyes are kidney-shaped, and not round, as in the common lobster. The claws have also a more slender and prismatic form, and the colour is a pale flesh colour. It is said by some to be the most delicate of all the crustaceans; by others, to be inferior to the common lobster.—The SPINY L., or SEA CRAYFISH (*Palinurus vulgaris*), is not uncommon on the rocky coasts of Britain, particularly in the south. It is believed to be the *Karabos* of the Greeks, and the *Locusta* of the Romans. It attains a length of about eighteen inches. The shell is very hard, and the whole body is rough with short spines. The antennæ are very long, much longer than those of the common lobster. There are no claws or pincers, the first pair of feet being very similar to the others. The Spiny L. is brought to market in London and elsewhere, but is inferior to the common lobster.—Other species of these genera are found in other parts of the world.

LOCHABER AXE, an axe with a curved handle, and very broad blade. It was the ancient weapon of the Highlanders, and was carried by the old City Guard of Edinburgh.

LOCHES, a picturesque town of France, in the department of Indre-et-Loire, on the left bank of the Indre, 25 miles south-east of Tours. Pop. 5191. The castle of L. (now a ruin) acquired a fearful reputation during the reign of Louis XI., as the scene of those deeds of cruelty which were so horrible that they had to be done in utter darkness and secrecy. At a later period, James V. of Scotland was married in this castle to Magdalen of France; and still later, Francis I. received here, in splendid state, the Emperor Charles V., on his way from Spain to Ghent.

LOCK of a gun is that apparatus by which the powder is fired. Muskets, in their earliest use, were fired by the hand applying a slow match to the touch-hole. Towards the end of the 14th c., the first improvement appeared in the *matchlock*.

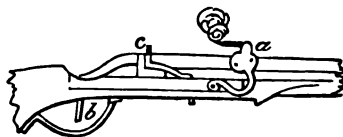

Matchlock.

This consisted of a crooked iron lever, *a*, in the end of which the match was fixed. By a pin-gear of a simple nature, pressure on the trigger, *b*, brought the match accurately down on the powder-pan, of which the lid, *c*, had previously been thrown forward by the hand. This mode of firing involved the carrying of several yards of slow match, usually wound round the body and the piece; rain extinguished the match, and wind dispersed the powder in the pan, so that the matchlock, clumsy withal, was but an uncertain apparatus.

Superior to the matchlock was the *wheel-lock*, introduced at Nürnberg in 1517, in which fire was produced by friction between a piece of flint or iron pyrites and a toothed wheel. The mechanism which generated the sparks simultaneously uncovered the pan, so that the dangers from wind and rain were averted; but before firing, the apparatus required to be wound-up like a clock, and therefore the discharges could not be frequent. The wheel-lock continued for a long period to be used in Germany, and partially in France. In the Spanish dominions, however, its place was supplied by the simpler contrivance called the *Snaphaunce*, *Snapphahn*, or *Asnaphan lock*, of nearly contemporaneous invention, which acting by means of a spring outside the lock-plate, produced fire through the concussion of a flint against the ribbed top of the powder-pan. Its positions of half and full cock were obtained by the insertion of a pin to stay the operation of the main-spring. In the middle of the 17th c., the *flint-lock* was invented, combining the action of the wheel-lock and the snaphaunce, while it was incontestably superior to either. After combating much prejudice, it was universally adopted in the armies of Western Europe by the commencement of the 18th century. Muskets embracing it obtained the name of 'fusils,' a French adaptation of the Italian word *focile*, a flint. With successive improvements, the flint-lock continued in general use until the introduction of the *percussion-lock* almost in our own day; and among eastern and barbaric nations, the flint-lock is still in common demand. Its great superiority over the snaphaunce consisted in the 'tumbler' (of which

presently) and the 'scaer,' appliances still retained in the percussion-lock, which enabled the positions of half and full cock to be taken up without the intervention of pins, always uncertain in their action.

The principle of the percussion-lock is the production of fire by the falling of a hammer upon detonating powder, the explosion of which penetrates to the charge in the barrel of the gun. The first practical application of this principle to fire-arms is due to the Rev. Mr Forsyth of Belhelvie, in Aberdeenshire. Various forms in which to ignite the detonating powder have been devised, but that now generally accepted is the copper cap, fitting tightly on the nipple of the gun, charged with a detonating compound, and exploded by the hammer falling upon it. The percussion-lock, with the latest improvements, is shewn in the annexed figure. A is the lock-plate; B, the main-spring, communicating, through the swivel C, with the

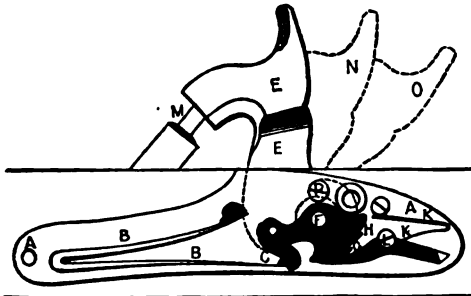

Percussion-lock.

tumbler D, which concentrically with the hammer, E, moves on the tumbler-nail F. In the figure, the hammer has delivered its stroke, and its further progress in the direction required by the spring B, is barred by the nipple M. On pulling back the hammer, E, to the position of half-cock N, the tumbler turns with it, and the pointed end of the scaer I (which moves on the scaer-nail L as centre), influenced by the scaer-spring K, falls into the notch G, in the tumbler. This notch has such a depth that no action of the trigger can release the tumbler from the stoppage caused by the scaer. On forcing back the hammer to full-cock O, however, the scaer will move down to the shallower notch H; and on the lever end of the scaer being raised by the trigger until the pointed end clears the tumbler, the latter, acted on by the main-spring, flies round to the position delineated, and brings down the hammer with a heavy blow on the cap. To keep the works of the lock firmly in their several places, a metal shield, called the 'bridle,' is screwed over them by the screws at L and P, and includes the pin, F, in its width. The percussion-lock was generally adopted in the British army about the year 1840; it is now frequently applied to cannon as well as small-arms.

LOCK, on a river or canal, is an arrangement of two parallel floodgates, by which communication is secured between two reaches of different levels. When locks were first introduced, is not known within a hundred years, nor is it clear whether Holland or Italy can claim the distinction of having first employed them. This much, however, can be affirmed with certainty, that at the beginning of the 17th c., locks existed in both countries, and it is probable that they were arrived at gradually by successive improvements in the mode of rendering shallow rivers navigable. Obviously, the first

step would have been to dam the stream across at intervals, leaving gates in the dams for the passage of vessels. This measure would have divided the river into reaches or steps, each, as the source was approached, being higher above the sea than the one last passed. But the passage up or down—and especially up—such a stream must be extremely slow, as at each dam a vessel must wait until the gate has been opened, and the level equalised in the reach it is in, and that on which it is proposed to enter. Where the reaches were far apart, a large body of water would require to be raised or lowered, and the process could not but be tedious. The medieval engineers next tried to place the dams as near together as possible, but expense limited this. The course then was to build two dams, with floodgates, just far enough apart to allow a vessel to float within. Under this arrangement, only the section between the dams had to be raised or lowered. The cost of thus doubly damming a wide river, however, was very great, and it was an easy transition of idea to remove the passage from the main stream altogether, and construct a lock with double gates, which should open at one end above, and at the other below the dam or weir. The economy of money in building, and of time and water in working, was obvious; and on

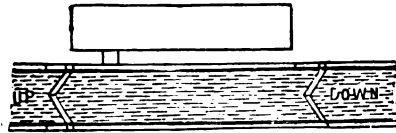

Canal-lock—seen from above.

this principle all locks are now made, wherever there is traffic of any importance. The arrangement consists of two pairs of gates, opening up the stream, and offering, when shut, a salient angle to the stream or upper pressure. The effect is that the weight above only tends to close the gates still tighter. When a vessel is to be brought from one level to the other, it is floated into the 'pound,' as the space between the upper and lower gates is called. The gates are then shut, and a sluice in the lower part of the upper gate raises the surface of the pound, or the sluice in the lower gate depresses it, in a few minutes to the level of the upper or



Vertical Section of a Thames Lock.

lower reach, as the case may be. These sluices are worked by racks in the gates, and the ponderous gates themselves are moved with the aid of long and heavy levers. Of course, one pair of gates must always be shut, or the two reaches would speedily assimilate their levels. In the engraving, the boat has just entered from the lower part of the river.

On canals where water is scarce, a reservoir, equal in size to the lock, is formed at its side. When the pound is to be emptied, the water is run into the reservoir until it and the lock are at the same level, which will be half height. The

reservoir is then closed, and the remaining water in the lock run off through the lower sluices in the usual way. On refilling the lock, before opening the upper sluices, one quarter the quantity required can be obtained from the reservoir, thus effecting a saving of many tons of water at each filling.

On rivers, advantage is taken of islands for the formation of Weirs (q. v.) and locks. On the Thames, the locks are from two to three miles apart, and the river is locked by upwards of 50 locks from Teddington to Lechlade. On canals, to economise superintendence, the locks are usually constructed in 'ladders' of several close together, like a flight of steps. As the pressure on lock-gates is very great, and varies with the height of water above, the rise in one lock is rarely more than 8 or 9 feet, although in some instances 12 feet have been accomplished, and in a very few cases even more.

LOCK, a contrivance for securely fastening the door of a building, the lid of a box, &c. Amongst the early Egyptians, Greeks, and Romans, locks were used, but their construction evinced little skill, and they were usually made of hard-wood; in fact, they were little more than wooden bolts, requiring only the hand to unfasten them. The first advance upon this was a remarkable one, invented by the ancient Egyptians; it contained

the principles of the modern tumbler-lock; but although still in use amongst the modern Egyptians and Turks, it has never, in their hands, made any advance. This lock consists of a case, fig. 1, A, which is nailed to the door; through the case

passes a large wooden bolt, fig. 1, B, the end of which, E, enters the staple, whilst the opposite end is left exposed. In the lower part of the bolt B, is a square groove C, which has certain round or square holes, as seen in fig. 2, f, which gives the open view of the lock. When the bolt is pushed home into the staple, these holes come exactly under corresponding little cavities in the case

which is placed an upright wooden pin, with a knob, which prevents its falling too low: these little pins consequently fall into the holes in the bolt when it is pushed far enough, and the door is locked. In order to unlock it, the bar of wood,

fig. 3, is passed into the groove C, in the bolt, and on the bar there are the same number of pins of wood placed upright as there are holes in the bolt, and loose pins in the chambers of the case; and these upright pins are placed so as to correspond exactly in size and position to the holes; therefore, when the pins reach the holes, they slip into them, and push up the loose pins into their respective cavities, and the bolt is then easily pulled back by means of the bar or key. This is simple and ingenious, but it is very clumsy, and, as usually made in Turkey, is

not secure. Nevertheless, it has been in use longer than any other form of lock in existence.

During the middle ages, very complicated and ingenious locks of various kinds were made, and as much artistic taste was expended upon the ornamentation of their external metal-work as there was skill in the interior mechanism. Such locks, however, were not adapted to general use, and they were only found on the caskets of the wealthy. The ordinary ward and spring locks were the only ones commonly employed up to the beginning of the present century, even for important purposes, and this kind of lock is still in very common use. It consists of a bolt of metal, to which a spring is attached, and it is moved backward or forward by means of a key, which, by raising the bolt, compresses the spring in the slot, through which it works, and so lets it pass on until out of the range of the key's action, which, turning on a pivot, is regulated by the length of its wards, and the depth of a curve cut in the under side of the bolt. In order to prevent any key of the same size opening all such locks, little ridges of iron are placed in circles or parts of circles, and wards are cut in the keys, so as to correspond with them; hence, only the key which has openings or wards which will allow the ridges to pass through them, can be used. This will be better seen by the sketch, fig. 4. A, is the bolt, having at the end

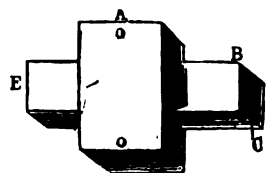

Fig. 1.



Fig. 2.



Fig. 3.

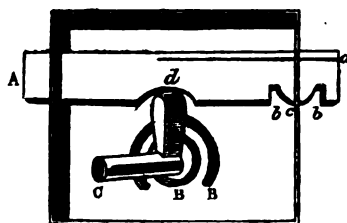

Fig. 4.

opposite to that which enters the staple a small piece slit, bent outwards, and tempered hard; this forms the spring a; below, are two notches b, b, divided by a curved piece of the bolt c; there is another notch d, which, if the key enters, and is turned round, it draws the bolt forward or backward in locking or unlocking, and the spring makes the end of the bolt either drop into one of the notches b, b, or rise up the curve c, according to the distance to which it is pulled. The ridges B, B are so placed as to allow the wards of the key, C, to move freely, and to prevent the entrance of another key of different arrangement.

The tumbler-lock is the type of another class, and is an advance upon the last; the two principles are, however, in most cases combined. The principle of the tumbler-lock will be readily seen by reference

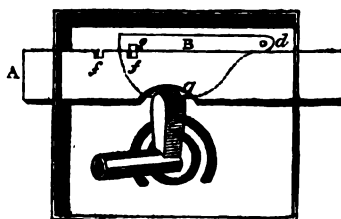

Fig. 5.

to fig. 5. In this, a lock nearly alike the former has been chosen, and the simplest form of tumbler added. It will be seen that the bolt, A, has neither

the spring-piece nor the notches and curves on the under side, as in fig. 4; but it has two notches on the upper side, which are exactly as far apart as the distance moved by the bolt in locking or unlocking. Behind the bolt, partly seen only—the covered parts being indicated by dotted lines—is the tumbler B, a small plate moving on the pivot *d*, and having projecting from its face a small square pin *e*, which, when the bolt is locked or unlocked, falls exactly into one or the other of the small notches *f, f*. It will also be seen that there is in the key a notch *g*, which corresponds to the outline of the tumbler, as indicated by the dotted lines. This acts upon the tumbler when the key is turned, and raises it so as to lift the pin out of the notch in the bolt, and allow the latter to be moved freely forward until the other notch comes under the pin, when the latter falls into and immediately stops its further progress, and the action of the key must be reversed in order to relieve it again. This very simple application of the tumbler is sufficient to explain the principle which may be, and is varied to an almost endless extent. Chubb's justly celebrated lock carries it out most fully, the bolt itself being only a series of tumblers, with a notch on the key for each. Bramah's lock, patented in 1788, has enjoyed immense reputation, chiefly for cabinets, desks, and other similar applications; it is very different in principle from those before mentioned, consisting of a number of movable slides or interior bolts working in an internal cylinder of the lock, and regulated by the pressure upward or downward of the key acting on a spiral spring. For ordinary purposes, it is very secure; but when the most perfect security is required, the beautiful lock invented by Mr Cotterill of Birmingham, and the still more ingenious one of Mr Hobbs of America, must be preferred. These beautiful and complicated pieces of mechanism cannot be described within the limits of this article; but ample information upon them and others can be found in Mr Denison's *Treatise on Locks*, and in *The Rudimentary Treatise on the Construction of Locks*, by Charles Tomlinson.

LOCK, or **GOWPEN**, in Scotch Law, is the perquisite paid by custom to the miller's man for grinding corn. See **THRILAGE**.

LOCK-UP HOUSES, the name given to the houses of bailiffs of the sheriff, to which debtors arrested for debt are first taken, until it is seen whether they will settle their debt without being taken to the ordinary jail. See **EXECUTION**; **IMPRISONMENT**.

LOCKE, JOHN, was born at Wrington, near Bristol, on the 29th of August 1632. His father was steward to Colonel Popham, and served under him as captain in the Parliamentary army during the Civil War. L. was sent for his education to Westminster School, where he continued till 1651, when he was elected a student of Christ-Church, Oxford. There he went through the usual studies, but seemed to prefer Bacon and Descartes to Aristotle. His tendency was towards experimental philosophy, and he chose medicine for his profession. In 1664, he went to Berlin, as secretary to the British envoy, but soon returned to his studies at Oxford. In 1666, he made the acquaintance of Lord Ashley, afterwards Earl of Shaftesbury, and on his invitation went to live at his house. In 1672, when Shaftesbury became Lord Chancellor, L. was appointed Secretary of Presentations, a post which he afterwards exchanged for that of Secretary to the Board of Trade. He was employed to draw up a constitution for the American province of Carolina, but his articles on religion were deemed too liberal, and

the clergy got a clause inserted, giving the favour of the state exclusively to the established church. In 1675, he took up his residence at Montpellier for the benefit of his health. He had all his life an asthmatic tendency, which at that time threatened to pass into consumption. At Montpellier, he formed the acquaintance of the Earl of Pembroke, to whom his *Essay* is dedicated. In 1679, he rejoined the Earl of Shaftesbury in England; but in 1682 the earl fled to Holland, to avoid a prosecution for high treason. L. bore him company, and so far shared with him the hostility of the government of James, as to have his name erased, by royal mandate, from the list of students of Christ-Church. Even in Holland, he was demanded of the States-general by the English envoy; but he contrived to conceal himself till the English court ceased to trouble itself on his account. In 1687, his *Essay on the Understanding*, begun seventeen years before, was finished; and an abridgment of it was published in French (1688), by his friend Le Clero, in his *Bibliothèques*, in which L. had published two years before his *Method of a Commonplace Book*. In 1689 appeared (also in Holland) his first letter on *Toleration*. But in 1688, the year of the Revolution, he came back to England in the fleet that conveyed the Princess of Orange. He soon obtained from the new government the situation of Commissioner of Appeals, worth £200 a year. He took a lively interest in the cause of toleration, and in maintaining the principles of the Revolution. In 1690, his *Essay on the Understanding* was published, and met with a rapid and extensive celebrity; and also a second letter on *Toleration*, and his well-known *Treatises on Government*. In 1691, he was engaged upon the momentous question of the restoration of the coinage, and published various tracts on the subject. In 1692, he brought out a third letter on *Toleration*, which, as well as the second, was a reply to the attacks made on the first. In 1693 was published his work on *Education*. In 1695, King William appointed him a Commissioner of Trade and Plantations. In the same year he published his treatise on *The Reasonableness of Christianity*, which was written to promote William's favourite scheme of a comprehension of all the Christian sects in one national church. He maintained a controversy in defence of this book; he had another controversy in defence of the *Essay on the Understanding*, against Stillingfleet, the Bishop of Worcester. His feeble health now compelled him to resign his office of Commissioner of Plantations, and to quit London; and he spent the remainder of his life at Oates, in Essex, at the seat of Sir Francis Maaham. His last years were very much occupied with the study of the Scriptures, on which he wrote several dissertations, which, with his little work, entitled *On the Conduct of the Understanding*, were published after his death. He died 28th October 1704.

Great as were L.'s services to his country, and to the cause of civil and religious liberty, his fame rests on the *Essay on the Understanding*, which marks an epoch in the history of philosophy. His purpose was to inquire into the powers of the human understanding, with a view to find out what things it was fitted to grapple with, and where it must fail, so as to make the mind of man 'more cautious in meddling with things exceeding its comprehension, and disposed to stop when it is at the utmost extent of its tether.' This purpose led him to that thorough investigation of the constitution of the human mind, resulting in the most numerous and important contributions ever made by one man to our knowledge on this subject. He institutes a preliminary inquiry, in the subject of

the First Book, as to the existence of innate ideas, theoretical and practical, on which the philosophical world has been so much divided. See COMMON SENSE. L. argues against the existence of these supposed innate conceptions, or intuitions, of the mind with a force and cogency that appear irresistible. Having thus repudiated the instinctive sources of our knowledge or ideas, he is bound to shew how we come by them in the course of our experience. Our experience being twofold, external and internal, we have two classes of ideas—those of Sensation, and those of Reflection. He has therefore to trace all the recognised conceptions of the mind to one or other of these sources. Many of our notions are obviously derived from Experience, as colours, sounds, &c.; but some have been disputed, more especially such as Space, Time, Infinity, Power, Substance, Cause, mere Good and Evil; and L. discusses these at length, by way of tracing them to the same origin. This is the subject of Book Second, entitled 'Of Ideas.' Book Third is on language considered as an instrument of truth, and contains much valuable material. The Fourth Book is on the nature, limits, and reality of our knowledge, including the nature of demonstrative truth, the existence of a God, the provinces of faith and reason, and the nature of error.

LOCKED JAW. See TETANUS.

LOCKHART, JOHN GIBSON, was born at Cambusnethan, in Scotland, in 1794. His father was a minister of the Established Church of Scotland. L. received the first stages of his education at Glasgow, and afterwards proceeded to Oxford, where, in 1813, he took first-class honours. In 1816, he became an advocate at the Scotch bar. He appears, however, to have wanted the qualifications necessary for success in this profession, and besides, the bent of his mind was more toward literature than law. He and Wilson were long the chief supporters of *Blackwood's Magazine*. Here he began to exhibit that sharp and bitter wit that was his most salient characteristic, and made him the terror of his enemies. It was this connection which led to his acquaintance with Sir Walter Scott. In 1819, appeared *Peter's Letters to his Kinfolk*. In 1820, he married Miss Scott, eldest daughter of Sir Walter. In 1821, he published *Valerius*, and in 1822, *Adam Blair*. Both of these works, especially the latter, shew him to have possessed, at least, a thorough acquaintance with the rules of art in fiction-writing. In 1823 appeared his *Reginald Dalton*, a tale of English university life, and in 1824 his *Ancient Spanish Ballads*—perhaps the most popular of all his writings. In the same year he published his last novel, *History of Matthew Wald*. From 1826 to 1853, he edited the *Quarterly Review*. From 1837 to 1839, appeared his *Life of Scott*, a work of undoubted merit, but which has given rise to much bitter controversy. In 1837, his wife died, having been predeceased by their eldest son Hugh. His second son died at a later period. In 1843, L. was appointed Auditor of the Duchy of Cornwall, with a salary of £600 a year. In 1847, his only remaining child, a daughter, the sole surviving descendant of Sir Walter Scott, married J. R. Hope, Esq. She died in 1858 leaving an only daughter, who inherited the estate of Abbotsoford. L. died 25th November 1854.

LOCKPORT, a village of New York, U. S., on the Erie Canal, and the Rochester and Niagara Falls Railway, 55 miles west of Rochester. The canal here falls 60 feet, with 5 combined double-locks, and its surplus water gives power to 5 flouring-mills, 7 saw-mills, 5 stove and shingle factories, machine-shops, and foundries. There are

13 churches, 4 banks, 2 daily and 3 weekly newspapers, and tanneries, manufactories of agricultural implements, glass, &c. Pop. in 1860, 13,523.

LO'CLE, a frontier town of Switzerland, canton of Neuchâtel, and 10 miles north-west of the town of that name. Pop. 8514, who are engaged chiefly in watch-making. In 1851, no less than 83,684 watches were manufactured.

LOCO, in Music, indicates that the notes are to be played exactly as they are written.

LOCUS, in Geometry, denotes the line or surface traversed by a point, which is constrained to move in accordance with certain determinate conditions. Thus, the locus of a point which must always preserve the same uniform distance from a fixed point, is the surface of a sphere; but if the motion be at the same time confined to a plane, the locus in this case will be a circle: this is an illustration of the division into *solid* and *plane* loci which prevailed among the ancients. The Greek geometers made their geometrical analysis depend much upon the investigation of loci, but no specific records of their progress in this branch of geometry now exist. What would appear to have been their method was restored by Dr Simson of Glasgow, whose work, *De Lociis Planis* (1749), is a model of elegance. In modern Geometry, plane loci are treated under the name of CURVES (q. v.).

LOCUS DELICTI, the place where a crime was committed, is a phrase used in criminal law.

LOCUS PENITENTIÆ, the time to withdraw from a bargain—a phrase often used in Scotch law. The general rule is, that until the contract is finally settled, either party may retract; but if *rei intervenus* has intervened, i. e., if some act has been done by the other party on the faith of the agreement, and by which his position has been altered, the *locus penitentiæ* is barred. Much depends on the circumstances of each case as to the application of the rule.

LOCUST (*Locusta* of some entomologists, and *Acrydium* of others), the type of a family (*Locustidae* or *Acrydidae*) of the order *Orthoptera*, and section *Saltatoria* (see GRILLUS). Locusts differ from grasshoppers and crickets in their short antennæ, and in the greater robustness of their bodies and limbs. The head is large, with two projecting oval compound eyes, and three stemmatic eyes on its summit. The wings, when folded, meet at an angle above the back; the abdomen is conical, and compressed. Their hind-legs are large, and they possess a great power of leaping. They make a stridulant noise by the friction of the rough hind-legs against the wing-covers. The wing-covers are leathery, narrower than the wings, but equal to them in length; the wings are large, reticulated, fold like a fan, and are often beautifully coloured—red, pink, brown, green, or blue. The power of flight of locusts has been the subject of much dispute, some asserting that they can fly to great distances, others that they have little power of flight, and are merely carried before a gale of wind. The truth seems to be between these extreme opinions: locusts fly well, but they are sometimes wafted by winds where their power of flight would never have carried them. Their food consists of the leaves and green stalks of plants; the mandibles and maxillæ are strong, sharp, and toothed, and in eating, they use their fore-feet to bring their food to their mouth. They generally quite consume any stalk of grass or other green thing which they have selected and cut. The terrible ravages of locusts are owing to the vast numbers in which they appear, filling the air like flakes of snow—

LOCUST TREE—LODGINGS.

darkening the sky, so that objects cast no shadow—seeming, in the distance, like a thick smoke—advancing with a sound like the rushing of chariots or of waters, or, in the words of the prophet Joel, 'like the noise of a flame of fire that devoureth the stubble;' whilst, as he also says, 'the land is as the garden of Eden before them, and behind them a desolate wilderness.' They eat up every green thing, and after the grass and leaves, they devour



Locust (Locusta migratoria).

in their hunger the bark of trees and shrubs. Ripe grain, however, may escape, as being too hard and dry. These multitudinous swarms of locusts do not appear annually; it is only after the lapse of a number of years that they are again so great and so destructive; and particular years are marked in the history of some countries as years of their extraordinary abundance, and of consequent famine and pestilence. When driven by a strong wind into the sea, they have sometimes been flung back on the beach in such quantities as to produce a stench intolerable to a great distance.

Locusts are found in almost all parts of the world except the coldest regions, but they abound chiefly in tropical and subtropical countries, and most of all, in Arabia and Africa. The eastern and southern parts of Europe are occasionally visited by their destructive hosts, and in the south of France, rewards are paid for the collection of locusts and of their eggs. The eggs are found cemented together in little masses in the ground. The insects themselves are taken by means of a stout cloth, the edge of which is made to sweep over the surface of the ground, and the locusts thus thrown together are quickly gathered into sacks. A similar mode of diminishing the nuisance is adopted in North America; but before an invasion such as districts of Asia and Africa are occasionally subjected to, all human effort fails.

Locusts are eaten in many countries, roasted, or fried in butter. They are also preserved in brine, or dried in the sun. They thus appear in the markets of Arabia, Syria, Egypt, Madagascar, &c., and are even exported as an article of commerce.

The most noted species is *Locusta migratoria* (or *Acrydium migratorium*); about 2½ inches in length, greenish, with brown wing-covers, marked with black. It is this species which is most frequently seen in Europe. It is a rare visitant of Britain. Other species belong to other parts of the world. Some of them, forming the genus *Truxalis*, and inhabiting the warmest countries, are remarkable for their elongated conical head.

The little chirping 'grasshoppers' most common in Britain, differing from true grasshoppers in their short antennæ, belong to the genus *Tetrix*, and family *Locustidae*.

LOCUST TREE, a name given in different parts of the world to different trees of the natural order *Leguminosæ*.—The Carob Tree (*Ceratonia siliqua*) is often so called in the countries bordering on the

Mediterranean, and its pods are the locust beans of our shops. See CAROB. A kind of effervescing beer, made from locust or carob pods, was last year sold in London.—The LOCUST TREE of America (*Robinia pseudacacia*), also called the FALSE ACACIA, or THORN ACACIA, and on the continent of Europe and in Britain, very generally the ACACIA, is a valuable and extremely beautiful tree. See ROBINIA. The wood, known as *Locust Wood*, is useful for all

purposes in which great strength, and especially toughness, is required; this latter quality, which it possesses pre-eminently, makes it very valuable for trenails used in ship-building, and large quantities are imported for this purpose. It is also valuable for making the cogs of wheels.—The HONEY LOCUST (q. v.) TREE of America is a *Gleditschia*.—The LOCUST TREE of the West Indies is *Hymenæa courbaril*, a gigantic tree, whose pods also supply a nutritious matter, a mealy

substance in which the pods are imbedded. It is sweet and pleasant, but apt to induce diarrhoea when recently gathered, which property, however, it loses when kept for a short time. A decoction of it, allowed to ferment, makes a kind of beer. The bark of the tree is anthelmintic; it yields a kind of resin called ANIME (q. v.), and it is valuable as a timber-tree, the timber (also known as *Locust Wood*) being close-grained and tough, and in request in England for trenails. It is very generally imported in the form of trenails.

LODE, a miner's term for Veins (q. v.) in which minerals occur. They are crevices, more or less vertical, produced by contraction, or the mechanical disturbance of the rock, which have subsequently been filled with metallic ores.

LODÈVE (ancient *Luteva* in *Gallia Narbonensis*), a town of Southern France, in the department of Hérault, situated on the Ergue, in a beautiful valley, 32 miles north-west of Montpellier. It is enclosed by walls, has a cathedral, and a pop. of 12,765, with manufactures of woollen cloths. L. is the birthplace of Cardinal Fleury.

LODGED, in Heraldry. A beast of chase, as a stag, is said to be lodged when lying down with its head erect; a beast of prey in the same position is said to be couchant.

LODGING-MONEY is an allowance, in the British army, granted to officers and others, for whom suitable quarters cannot be provided in barracks. Married sergeants and private soldiers who are married 'with permission,' are entitled to lodging-money at various rates up to 8s. a week, when separate rooms in barracks cannot be spared for the accommodation of each couple. The total charge for lodging-money in the army estimates of 1863—1864 amounts to about £100,000.

LODGINGS, or the use of part of another person's house, when occupied, constitute the relation of landlord and tenant between the parties. Lodgings being generally taken by the week, or month, or quarter, it is not necessary that the contract should be by writing, though it is expedient, especially where any particular stipulations are made. But where a furnished house is let, and a written agreement or lease is used, it is absolutely necessary that there should be a stamp on such writing, which must be cancelled by the parties under a penalty of £5 besides stamp-duty; and house-agents who let furnished houses above £25 for hire, must now take

out an annual licence, and pay duty. In England, the chief points of law which arise are as follow: One of the risks which the lodger runs is, that if his landlord, L, is himself a tenant to A, somebody else, then, if L's rent is in arrear, the lodger's goods may be taken by A to pay this, for the rule is, that all goods found on the premises, to whomsoever belonging, may be seized to pay arrears of rent, and it is immaterial whether the landlord A, who distrains, knows they are not L's, but the lodger's goods. The only remedy in such a case for the lodger is to deduct the amount of loss from the next rent he pays to L for lodgings. Hence, in order to learn whether the above risk is impending, a lodger frequently inquires beforehand at the landlord of the house, A, and the tax-collectors, whether rent, &c., is in arrear. A lodging-house keeper, even where he keeps a boarding-house, which nearly resembles an inn, is not liable for the safe custody of the lodger's goods. He is merely liable for ordinary care; but he does not warrant at all hazards that the goods will not be stolen, as an Innkeeper (q. v.) does. Even if the lodger's goods are stolen by a servant of the house, the lodging-house keeper is not liable. The notice to quit depends on how the lodgings were taken. If they were taken by the week, a week's notice is sufficient; if by the month, a month's; and if by the quarter, a quarter's notice, unless some other agreement was made. Hence, if the lodger quit without notice, he is liable for one week's, or month's, &c. rent, even though the landlord put a notice in the window. The lodging-house keeper may distrain the lodger's goods for unpaid rent. When a lodger refuses to quit the lodgings after a notice has expired, he cannot be put out by force, but in many cases a summary remedy is given for recovering possession. In Scotland, the lodger's goods cannot be taken by the landlord of the lodging-house keeper for rent. A lodger, whatever rent he pays, yet not being rated to the poor, &c., is not entitled to vote for members of parliament; though it is said that in Scotland a different practice prevails in some places (Burton's *Law of Scotland*, 38). *Common lodging-houses*, where poor people lodge by the night, have recently been subjected to state interference; and by statutes 14 and 15 Vict. c. 28, and 16 and 17 Vict. c. 41, the keepers of such lodging-houses must register them. They are liable to be inspected by an officer of the Board of Health for sanitary purposes, and the keepers are bound, on notice, to report to the local authority every person who resorted to their houses during the preceding day or night. The keepers are bound to thoroughly cleanse all the rooms, stairs, &c., as often as by-laws shall direct, and to keep a proper supply of water. If fever break out, notice must be given to the local authority. These duties are enforced by means of penalties. These statutes were extended to Ireland by the statutes 23 and 24 Vict. c. 26.

LODI, chief town of the delegation of Lodi, in the province of Lombardy, stands on the right bank of the Adda, 19 miles south of Milan, on a gentle slope in the midst of a highly fertile district, and contains 20,000 inhabitants. It is protected by walls and a strong castle, erected by the Visconti, but lately appropriated as a military hospital. L. is a bishop's see and the seat of a college, and contains many fine buildings. Its chief manufactures are linens, silks, chemical products, and Majolica porcelain, for which it is famous. Its great trade is in cheese, especially the famous species known as Parmesan, which, instead of being manufactured at Parma, as one might infer from the name, is exclusively made in the vicinity of L., where 30,000 cows are kept for the purpose. —LODI VECHIO, or Old Lodi, is a ruined village

about five miles west of the modern town; it was founded by the Boii, and colonised by the father of Pompey the Great, hence its name, *Laus Pompeia*, which was gradually corrupted into the modern name of *Lodi*. L. is celebrated for the victory of the French, under Bonaparte, over the Austrians, on 10th May 1796, when the long and narrow bridge was carried by the French columns, notwithstanding a tremendous fire from the Austrian batteries.

LO'ESS, a loamy deposit of Pleistocene age, occurring in the valleys of the Rhine and the Danube. It consists of a pulverulent loam of a yellowish-gray colour, made up principally of argillaceous matter, combined with a sixth part of carbonate of lime, and a sixth of quartzose micaceous sand. In the Rhine, it apparently once covered the whole valley and its tributaries, reaching to a considerable height up the bounding mountains. It has subsequently been greatly abraded, a fringe only of the deposit being left on the mountain-sides, and occasionally some outliers in the widest parts of the valley; the materials have been carried down by the river, and rearranged, as a newer loess or alluvium, in Belgium and Holland. This continuous deposit of fine sediment suggested the notion to the original observers of an enormous lake, whose barrier was at the narrow gorge of the Rhine at Bingen. But the loess occurs further down; besides, the contained fossils are not lacustrine, but those of land-animals (*Elephas* and *Rhinoceros*), and land-shells (*Helix*, *Pupa*, and *Succinea*). It is now believed to be the moraine mud of the Alpine glaciers, which was spread out gently in the valleys of the Rhine and Danube, as the land gradually emerged from the sea. The loess is generally from 30 to 50 feet in thickness, though sometimes as much as 200 feet. Fossils are not generally distributed in the strata, but they are sometimes locally abundant. They consist chiefly of land-shells of species now inhabiting the same region.

LOFODEN, LOFFODEN, or LOFOTEN, a chain of islands on the north-west coast of Norway, between lat. 67° and 69° 15' N., and stretching south-west and north-east for 175 miles. The largest of the islands are Hindöe, Andöe, and Langöe, Ost Vaagen, West Vaagen, and Flagstadöe. All of them are rugged and mountainous; indeed, some of the eminences in Vaagen attain an altitude of 4000 feet, and are covered with perpetual snow. The glens near the coast possess a temperature mild enough to allow of the cultivation of oats, barley, and potatoes. The permanent population is estimated at 4000. The islanders chiefly depend upon the fishery which was established some time previous to the 11th c., and has always attracted a large number of the inhabitants of the mainland. The average number of boats is 4000, manned by 20,000 fishermen; and the produce of the cod-fishery is estimated at 9000 tons of dried fish, 22,000 barrels of oil, and 6000 barrels of roe. After the cod-fishery has terminated (in April), the herring-fishing season comes on, and continues throughout the summer, forming also an important branch of national industry. Several other kinds of fish are caught, and lobsters and oysters in abundance. The fishing is attended with considerable danger, on account of the sudden and violent storms from the west, and of the strong currents which set in between the islands. See MARLSTROM. The inhabitants are a mixed race, partly of Scandinavian, partly of Lappish descent.

LOG is the instrument by which a ship's rate of motion through the water is measured. Its simplest form is a triangular piece of light wood, leaded so as to swim vertically; this is connected with the

log-line so that its flat surface is at right angles to the ship's course. When thrown out—attached to the log-line (see *KNOR*)—the log meets with such resistance that it theoretically remains stationary in the water, and the log-line passing freely out shews the speed of the vessel. There are, however, many improved logs, which have complicated apparatus, for marking the way made, changes of direction, &c. The log and line are known to have been used as early as 1570 A.D., and were alluded to by



Log.

Bourne in 1577. Computing by the log is an uncertain operation, allowance having to be made for numberless contingent circumstances. In ships of war, it is usual to heave the log every hour; in merchantmen, every two hours. The *log-board* is a board on which the hourly results of the log-heaving are recorded in chalk, with the wind's direction, and other particulars, for the guidance of the officer in charge. The contents of the log-board are entered daily in the *log-book*, with all particulars essential to the history of the voyage, as ships spoken, icebergs seen, land sighted, &c. The *log-book* thus becomes a rough journal; and it is compulsory upon every master of a vessel to keep it properly, and to have it ready for inspection by any ship of war of his own nation whose captain may require its production.

LOGANIA'CEÆ, a natural order of exogenous plants, consisting of trees, shrubs, and herbaceous plants, with opposite entire leaves, and usually with stipules, which adhere to the footstalks, or form sheaths. The calyx is 4–5-partite; the corolla hypogynous, regular or irregular, 4–5 or 10-cleft. The stamens arise from the corolla. The ovary is generally 2-celled; there is one style. The fruit is a capsule, a drupe, or a berry. A few species of this order occur in Australia and in the temperate parts of North America; the rest are all tropical or sub-tropical. There are about 162 known species. No natural order of plants is more strongly characterised by poisonous properties. It includes the genus *STRYCHNOS* (q. v.), of which *NUX VOMICA* (q. v.) is one of the products, and another is the *Woorall* (q. v.) poison. *Strychnine* (q. v.) is a prevalent and peculiar characteristic principle of the Loganiaceæ. Some of the order, however, are of use in medicine, as certain species of *SPIGELIA* (q. v.).

LOGARITHMIC or LOGISTIC CURVES are curves whose abscissæ are proportional to the logarithms of the corresponding ordinates; consequently, if the abscissæ increase in arithmetical progression, the ordinates will increase in geometrical progression. The equation to these curves being

$$x = a \log. y \quad (a \text{ being constant}), \quad y \frac{dy}{y} = a, \text{ shewing}$$

that the subtangent has the same value for all points of the curve, and is the Modulus (q. v.) of the system of logarithms represented by the particular curve. This curve has another remarkable property—viz, that the area contained between any two ordinates is equal to the difference of the ordinates multiplied by the constant subtangent.

LOGARITHMIC or LOGISTIC SPIRAL is a curve described by a point which moves uniformly along a uniformly revolving straight line. This

curve has several remarkable properties, some of which are analogous to those possessed by the logarithmic curve. Its involute and evolute are the same with itself. Newton shewed that if the force of gravity had varied inversely as the cube of the distance, the planets would have shot off from the sun in logarithmic spirals. The equation to the curve is $r = ca^x$.

LOGARITHMS, a series of numbers having a certain relation to the series of natural numbers, by means of which many arithmetical operations are made comparatively easy. The nature of the relation will be understood by considering two simple series such as the following, one proceeding from unity in geometrical progression, the other from 0 in arithmetical progression:

Geom. series, 1, 2, 4, 8, 16, 32, 64, 128, 256, 512, &c.
Arith. series, 0, 1, 2, 3, 4, 5, 6, 7, 8, 9, &c.

Here the ratio of the geometrical series is 2, and any term in the arithmetical series expresses how often 2 has been multiplied into 1 to produce the corresponding term of the geometrical series; thus, in proceeding from 1 to 32, there have been 5 steps or multiplications by the ratio 2; in other words, the ratio of 32 to 1 is compounded five times of the ratio of 2 to 1. It was this conception of the relation that led to giving the name of *Logarithms* to the arithmetical series, the word *logarithm* (Gr. *logon arithmos*) meaning 'the number of the ratios.' As to the use that may be made of such series, it will be observed that the sum of any two logarithms (as we shall now call the lower series) is the logarithm of their product; e. g., 9 (= 3 + 6) is the logarithm of 512 (= 8 × 64). Similarly, the difference of any two logarithms is the logarithm of the quotient of the numbers; a multiple of any logarithm is the logarithm of the corresponding number raised to the power of the multiple, e. g., 8 (= 4 × 2) is the logarithm of 256 (= 16²), and a submultiple of a logarithm is the logarithm of the corresponding root of its number. In this way, with complete tables of numbers, and their corresponding logarithms, addition is made to take the place of multiplication, subtraction of division, multiplication of involution, and division of evolution.

In order to make the series above given of practical use, it would be necessary to complete them by interpolating a set of means between the several terms, as will be explained below. We have chosen 2 as the fundamental ratio, or base, as being most convenient for illustration; but any other number (integral or fractional) might be taken; and every different base, or *radix*, gives a different system of logarithms. The system now in use has 10 for its base; in other words, 10 is the number whose logarithm is 1.

The idea of making use of series in this way would seem to have been known to Archimedes and Euclid, without, however, resulting in any practical scheme; but by the end of the 16th c., trigonometrical operations had become so complicated that the wits of several mathematicians were at work to devise means of shortening them. The real invention of logarithms is now universally ascribed to John Napier (q. v.), Baron of Merchiston, who in 1614 printed his *Canon Mirabilis Logarithmorum*. His tables only give logarithms of sines, cosines, and the other functions of angles; they also labour under the three defects of being sometimes + and sometimes –, of decreasing as the corresponding natural numbers increase, and of having for their *radix* (the number of which the logarithm is 1) the number which is the sum of

$$1 + 1 + \frac{1}{1.2} + \frac{1}{1.2.3} +, \text{ \&c. These defects were,}$$

LOGARITHMS.

however, soon remedied: John Speidell, in 1619, amended the tables in such a manner that the logarithms became all positive, and increased along with their corresponding natural numbers. He also, in the sixth edition of his work (1624), constructed a table of Napier's logarithms for the integer numbers, 1, 2, 3, &c., up to 1000, with their differences and arithmetical complements, besides other improvements. Speidell's tables are now known as *hyperbolic logarithms*. But the greatest improvement was made in 1615, by Professor Henry Briggs (q. v.), of London, who substituted for Napier's inconvenient 'radix,' the number 10, and succeeded before his death in calculating the logarithms of 30,000 natural numbers to the new radix. Briggs's exertions were ably seconded; and before 1628, the logarithms of all the natural numbers up to 100,000 had been computed. Computers have since chiefly occupied themselves rather in repeatedly revising the tables already calculated, than in extending them.

Construction of Tables.—The following is the simplest method of constructing a table of logarithms on Briggs's system. The log. of 10 = 1; the log. of 100 (which is twice compounded of 10) = 2; the log. of 1000 = 3, &c.; and the logarithms of all powers of 10 can be found in the same manner. The intermediate logarithms are found by continually computing geometric means between two numbers, one greater and the other less than the number required. Thus, to find the log. of 5, take the geometric mean between 1 and 10, or 3.162..., the corresponding arithmetic mean (the log. of 1 being 0, and that of 10 being 1) being .5; the geometric mean between 3.162... and 10, or 5.623..., corresponds to the arithmetic mean between .5 and 1, or .75; the geometric mean between 3.162... and 5.623..., or 4.216..., has its logarithm = $\frac{1}{2}(.75 + .5)$ or .625; this operation is continued till the result is obtained to the necessary degree of accuracy. In this example, the twenty-first result gives the geometric mean = 5.000,003, and the corresponding arithmetic mean = .698,970, which is in ordinary calculations used as the logarithm of 5. Since division of numbers corresponds to subtraction of logarithms, and since $2 = \frac{1}{\frac{1}{2}}$, the log. of 2 = log. 10 - log. 5 = 1 - .698970 = .301030. The logarithms of all prime numbers are found in the same way as that of 5; those of composite numbers are obtained by the addition of the logarithms of their factors; thus, the log. of 6 = log. 2 + log. 3 = .301030 + .477121 = .778151. This method, though simple in principle, involves an enormous amount of calculation; and the following method, which depends on the modern algebraic analysis, is much to be preferred. According to this method, logarithms are considered as indices or powers of the radix; thus, $10^0 = 1$, $10^{-.301030} = 2$, $10^{-.477121} = 3$, $10^2 = 100$, &c.; and the laws of logarithms then become the same as those of indices. Let r represent the radix, y the natural number, x its logarithm; then $y = r^x$, or, putting $1 + a$ for r , $y = (1 + a)^x$; and it is shewn by the binomial and exponential theorems (see the ordinary works on Algebra) that $y = 1 + Ax + \frac{A^2x^2}{1.2} + \frac{A^3x^3}{1.2.3} + \dots$, where $A = r - 1 - \frac{1}{2}(r - 1)^2 + \frac{1}{6}(r - 1)^3 - \dots$, &c., the former equation expressing a number as the sum of different multiples of its logarithm and the radix. If $\frac{1}{A}$ be substituted for x , then

$$y = r^{\frac{1}{A}} = 1 + 1 + \frac{1}{1.2} + \frac{1}{1.2.3} + \dots = 2.71828182\dots$$

which, as before mentioned, is Napier's radix, and is generally called e ; then $r^{\frac{1}{A}} = e$, or $r = e^A$, or A

is the logarithm of r to the base or radix e . Then, referring to the above-mentioned value of A , we have, log. r (i. e., log. of r to the base e) = $r - 1 - \frac{1}{2}(r - 1)^2 + \frac{1}{6}(r - 1)^3 - \dots$, or, as before, putting $1 + a$ for r , log. $(1 + a)$

$$= a - \frac{a^2}{2} + \frac{a^3}{3} - \dots; \text{ a series from which log. } (1 + a) \text{ cannot be found, unless } a \text{ be fractional.}$$

However, if we put $-a$ for a , log. $(1 - a) = -a - \frac{a^2}{2} - \frac{a^3}{3} - \dots$; and subtracting this expression from the former, log. $(1 + a) - \log. (1 - a)$ or

$$\log. \left(\frac{1+a}{1-a} \right) = 2(a + \frac{a^3}{3} + \frac{a^5}{5} + \dots), \text{ and, for the sake of convenience, putting } \frac{u+1}{u} \text{ for } \frac{1+a}{1-a}, \text{ in}$$

which case, $a = \frac{1}{2u+1}$, we finally obtain log. $\frac{u+1}{u} = 2 \left\{ \frac{1}{2u+1} + \frac{1}{3(2u+1)^3} + \frac{1}{5(2u+1)^5} + \dots \right\}$, or

$$\log. (u+1) = \log. u + 2 \left\{ \frac{1}{2u+1} + \frac{1}{3(2u+1)^3} + \frac{1}{5(2u+1)^5} + \dots \right\}. \text{ If 1 be put for } u \text{ in this}$$

formula, the Napierian logarithm of 2 is at once obtained to any degree of accuracy required; if 2 be put for u , the Napierian logarithm of 3 can be calculated, &c. Now, as logarithms of any system have always the same ratio to one another as the corresponding logarithms of any other system, no matter what its base, if a number can be found, which, when multiplied into the logarithm of a certain number to one base, gives the logarithm of the same number to another base, this multiplier will, when multiplied into any logarithm to the first base, produce the corresponding logarithm to the other base. The multiplier is called the *Modulus* (q. v.), and for the conversion of Napierian into common or Briggs's logarithms, is equal to .4342944...; so that, to find the common logarithm of any number; first, find the Napierian logarithm, and multiply it by .4342944...

As in Briggs's system, the logarithm of 10 is 1, and that of 100 is 2, it follows that all numbers between 10 and 100 have, for their logarithms, unity + a proper fraction; in other words, the integer portion of the logarithms of all numbers of two figures is unity; similarly, the integer portion of the logarithms of numbers between 100 and 1000 is 2, and, in general, the integer portion of the logarithm of any number expresses a number less by unity than the number of figures in that number. This integer is called the *characteristic*, the decimal portion being designated as the *mantissa*.

As the logarithm of 1 = 0, the logarithms of quantities less than unity would naturally be negative; thus, the logarithm of $\frac{1}{2}$ would be -.30103, but, for convenience in working, the mantissa is kept always positive, and the negative sign only affects the characteristic; the logarithm of $\frac{1}{2}$ or $\bar{5}$ would thus be $\bar{1}.69897$, the characteristic in this and similar cases, expressing, when the fraction is reduced to a decimal, the number of places the first figure is removed from the decimal point; thus, the logarithm of .0005 is $\bar{4}.69897$.

Directions for the use of Logarithms in calculation will be found prefixed to any set of Tables. The history of the discovery is given in the preface to Dr Hutton's Tables.

The tables most distinguished for accuracy are

those of Callet (who edited Gardener's edition of *Sherwin's Tables*, making several additions and improvements), to seven places of decimals (Paris, 1821); Lalande, to five places (Paris, 1831); Hutton, to seven places (1849), issued in a more convenient form, with improvements, by Messrs W. and R. Chambers; the most accurate of all, however, are supposed to be those which Mr Babbage has produced with the aid of his ingenious calculating machine.

LOGGIA, an Italian word signifying an open arcade, enclosing a passage or open apartment. It is a favourite class of building in Italy and other warm countries. The Loggia de' Lanzi at Florence is one of the finest examples extant; and the Loggie of the Vatican, which are arcaded passages round the interior of the cortile of the palace, ornamented with beautiful paintings and arabesques by Raphael and his pupils, are well-known specimens.

LOGIC. This name denotes the science connected with the forms and methods of reasoning, and the establishment of truth by evidence. The science has come down to us from the Greeks, obtaining in great part the shape that we find it in from Aristotle, although he did not apply to it the name 'Logic.' This name, signifying originally both Thought and the Expression of Thought, must have been applied soon after the time of Aristotle. The most ancient name was 'Dialectic,' meaning literally, 'conversation,' 'colloquy,' or 'dispute.' (Hamilton's *Logic*, lect. 1.) 'But it appears that Aristotle possessed no single term by which to designate the general science of which he was the principal author and finisher. *Analytic*, and *Apodictic* with *Topic* (equivalent to *Dialectic*, and including *Sophistic*), were so many special names by which he denoted the particular parts or particular applications of logic.'

The definition of logic has never been, till lately, a matter of serious controversy. There was formerly a substantial unanimity, with some variations in the form of the phraseology employed. We find it called usually the Art of Reasoning, or the Science of Reasoning, or both the one and the other. And by reasoning has been always understood *formal* reasoning, that is, inferences stated in such general language that they apply to all kinds of matter alike, as when in arithmetic we say three times four is twelve, without considering what the numbers are numbers of. A modification of this view has been adopted by Sir W. Hamilton: he calls logic the 'Science of the Laws of Thought as Thought.' The introduction of the larger word 'Thought' is considered requisite, because 'Reasoning' is somewhat too limited, there being processes included in logic, and necessary to the establishment of truth, which that word does not cover; such, for example, are Conception—the forming of general notions—and Judgment, the statement of propositions (see JUDGMENT). But the word 'Thought' having an acceptation co-extensive with all Intelligence, including Memory, Imagination, &c., as well as the operations concerned about truth, must be held to its narrower meaning, by which it simply includes the three great operations, constituting the distinct stages or divisions of logic, Conception, Judgment, and Reasoning.

Mr John Stuart Mill has propounded a radical innovation in the definition and province of this subject. According to him, logic 'is the science of the operations of the understanding which are subservient to the estimation of evidence; both the process itself of proceeding from known truths to unknown, and all other intellectual operations in so far as auxiliary to this. It includes, therefore, the operation of Naming; for language is an instrument

of thought, as well as a means of communicating our thoughts. It includes also Definition and Classification.'

This definition has the merit of setting distinctly forth the end of the science, which is the essential point in every *practical* science, as logic is. That end is the *estimation of evidence*, in other words, it is not the ascertainment of *all* truth, but of those portions of truth that are authenticated by means of other truths, or by *inference*. The proper conduct of the operation of inferring one thing from another is the final end of the whole science. And in laying down the true criteria of inference, a certain amount of study has to be bestowed upon some of the operations of the human understanding, not to the extent of converting logic into a system of mental philosophy, but simply so far as will conduce to the purpose in view. It is not, therefore, the 'laws of thought, as thought,' but the laws of thought as bearing upon the arts of inference, that Mr Mill would esteem the matter of the science.

But Inference is admitted on all hands to be of two kinds—Deductive or Formal Inference, and Inductive or Real Inference. In the one, no more is inferred than is already contained in the premises; for example, 'All men are mortal, therefore, the present generation of Englishmen will die,' is a formal inference; the conclusion is within, or less than, the premises. This is the kind of inference treated of in the Deductive or Syllogistic Logic, which was till lately the whole of the science. In the other kind of inference, a conclusion is drawn wider than the premises, so that there is a real advance upon our knowledge: from certain things directly ascertained we infer other things that have not been ascertained by direct experiment, and which, but for such inference, we should have had to determine in that manner. Thus, 'This, that, and the other piece of matter, in which actual observations have been made, gravitates,' therefore, 'all inert matter existing everywhere, known and unknown, gravitates,' is an inductive inference. Of this last class of inferences, all the inductive sciences, including Physics, Chemistry, Physiology, Mental Philosophy, &c., are made up. Accordingly, Mr Mill treats this as coming within the province of logic, no less than the Deductive, Formal, Syllogistic, or Necessary inference, which previous logicians had confined themselves to exclusively.

Sir W. Hamilton, in his system, admits the consideration of Induction under what he terms 'Modified Logic,' in contradistinction to 'Pure Logic,' or Formal Inference; and it has not been unusual for writers on the science to devote a chapter to Induction, after expounding the laws of the syllogism. But Mr Mill has given to the inductive part the predominance over the other, as being the more fundamental, as well as practically the more important of the two. Making logic co-extensive with Proof, he endeavours to shew that the establishment of the *premises*, from which the formal logician takes his start, is, after all, the main point, and that the other is subsidiary and subordinate, although still important to be attended to, and susceptible of being well or ill done. He further shews that there are rules, or methods of procedure, which may be set forth and followed in the inductive operation; that mankind often break those rules from ignorance or inadvertence (as well as from other causes); and that good may be done by explicitly calling attention to them, and making them a branch of education, as the old logic has for a long time been. See INDUCTION, SYLLOGISM.

LOGOGRAM (Gr. *logos*, a word, and *gramma*, a letter) is simply a complicated or multiplied form of the Anagram (q. v.), where the puzzle-monger,

instead of contenting himself with the formation of a single new word or sentence out of the old, by the transposition of the letters, racks his brain to discover all the words that may be extracted from the whole or from any portion of the letters, and throws the whole into a series of verses in which synonymic expressions for these words must be used. The puzzle lies in ascertaining what the concealed words are, and, through them, what is the primary word out of which they have all been extracted. A specimen is given in Henry B. Wheatley's book on *Anagrams* (1862), in which, out of the word 'curtains,' no less than 93 smaller ones are framed.

LOGOGRAPHERS, a name by which the Greeks designated their historians previous to Herodotus. The logographers described in prose the mythological subjects and traditions which had been treated of by the epic poets, supplementing them by traditions derived from other quarters, so as to form, at least in appearance, a connected history; their works, however, seeming to be intended rather to amuse their readers, than to impart accurate historical knowledge. The term was also applied to those orators who composed judicial speeches or pleadings, and sold them to those who required them.

LOGOMANIA, or DISEASE OF THE FACULTY OF LANGUAGE. It frequently happens that, while the idea is clear and distinct, all trace of its representative sound has disappeared; or another sign, or one conveying the converse of what is intended, is used. Such a condition is often associated with organic disease of the nervous structure, as in paralytics. In certain cases, there is an irresistible rapidity of utterance, or, apparently, an involuntary utterance of certain words or phrases foreign to the character of the individual. In another class of cases, memory appears to be chiefly at fault; there may be the oblivion of all words; the forgetfulness of certain classes of words, such as substantives, while others are recollected and correctly applied; the forgetfulness of particular words, as of the individual's own name; or of parts of words, as occurs in general paralysis, where the last or penultimate syllable escapes attention, and is generally omitted; or there may be confusion as to orthography, and this has been observed when limited to a single letter. Dr Graves, Dublin, mentions a farmer who retained a knowledge of all parts of speech except nouns and proper names; but even of these he recollected the initial letter: he carried a pocket-dictionary, and when about to use such words as 'Cow' or 'Dublin,' turned to the letters 'C' and 'D,' and then recalled what he wished. Patients are found who impose upon themselves a mutism as to certain phrases, and limit their vocabulary to particular expressions. In others, there is invariably a transposition of words; such as when, in place of saying, 'The rose is beautiful,' a paralytic recasts the sentence, 'Beautiful rose is,' and all other sentences in a similar fashion. Fever, in Mezzofanti, is said to have swept away, in an hour, his vast acquisitions in sixty languages; in other cases, it has recalled dialects forgotten for half a century; and mere excitement seems capable of inventing or inspiring a vast number of sounds assuming the aspect, and even the relations of a language so closely as to suggest doubts as to whether they are creations such as those of Psalmanazar, which deceived the linguists of the Royal Society, or those ebullitions of devotional feeling designated 'unknown tongues.' In other forms of disease, the cries of animals or natural signs are resorted to in place of words; or

the ordinary language is sung or chanted, or used rhythmically; or a foreign language may be employed or imitated. The bearing of such alterations upon the philosophy of mind, and upon any theory as to the origin of language, must be obvious; but they possess a still more intimate connection with the amount of intelligence and responsibility predicable in every case of disease of the nervous system.—Calmiel, *De la Paralyse considérée chez les Aliénés*; *Phrenological Journal*, No. 47; Coleridge, *Biographia Literaria*, vol. i. p. 112.

LOGOS (Gr. from *lego*, 'I speak') denotes the act of speaking; that which is spoken; the natural process gone through for the purpose of the formation of speech; the reasoning powers themselves:—all the attributes and operations of the soul, in fact, as manifested by the spoken word. It thus occurs in the classical writers under the manifold significations of word or words, conversation, oration, exposition, command, history, prose, eloquence, philosophical proposition, system, reason, thought, wisdom, and the like. Theologically, the word *logos*, as occurring at the beginning of the gospel of St John, was early taken to refer to the 'second person of the Trinity, i. e., Christ.' Yet what was the precise meaning of the apostle, who alone makes use of the term in a manner which allows of a like interpretation, and only in the introductory part of his gospel; whether he adopted the symbolising usage in which it was employed by the various schools of his day; which of their widely differing significations he had in view, or whether he intended to convey a meaning quite peculiar to himself:—these are some of the innumerable questions to which the word has given rise in divinity, and which, though most fiercely discussed ever since the first days of Christianity, are far from having found a satisfactory solution up to this moment. The fact, however, is, that the notion of a certain manifestation or revelation out of the centre of the Godhead, as it were— which manifestation, as a more or less personified part of the Deity, stands between the realms of the infinite and the finite, of spirit and matter—has from times immemorial been the common property of the whole East, and is found expressed in the religions of the primitive Egyptians, as well as in those of the Hindus and Parsees. This notion of an embodiment of divinity, as '*Word*' or '*Wisdom*,' found its way, chiefly from the time of the Babylonian exile, into the heart of Judaism, which in vain endeavoured to reconcile it with the fundamental idea of the Divine Unity. The apocryphal writers chiefly pointed to the '*Wisdom*'—of which Solomon (Prov. viii. 22) says that it had dwelt with God from the beginning, and Job (xxviii. 20), that it had assisted in the creation—as the emanation of God, which emanation was supposed to be bodily to a certain, however minute, degree. Thus, Sirach (xxiv. 1, 23) understands the '*Spirit of God*' (Gen. i. 2) to be a kind of veil or mist, and speaks (i. 1, 9) of the '*wisdom that is of the Lord and is with the Lord, everlasting*,' and that '*it was created before all things, and known unto Him*' (ib.).

This *Wisdom*, or *Word* of creation, which, according to Sirach's view, formed and developed the chaos, further manifested itself—visibly—by a direct and immediate influence upon one select people, Israel, through which it wished further to influence all mankind. A nearer acquaintance with this doctrine in all its bearings at once solves the old riddles of certain Targumic interpretations, which have puzzled a host of investigators. Thus versions like that of Targum Jerushalmi to Gen. i. 1, 'With *Wisdom*, God created heaven and earth,' and the constant use of the term *Memra* (Word) instead of

God or Jehovah, become clear at once (see TARGUM, VERSIONS). No less must many passages in the Talmud and Midrash assume an entirely different aspect, if that prevalent mode of thought and speech is taken into consideration.

In the earlier Platonic schools, again, Logos, soil, of God, was the common term for 'Plan of the Cosmos' or 'Divine Reason,' inherent in the Deity. The later schools, however, more prone to symbol and allegory in philosophical matters, called Logos a 'Hypostasis of Divinity,' a substance, a divine corporeal essence, as it were, which became outwardly visible—a separate Being, in fact, which, created out of the Creator, became 'the Son of the Creator.'

But above all, we have, for the proper consideration of the usage in the days of the apostles, to examine the Judeo-Alexandrine views on this point. Philo, who is their best representative, makes the Logos the all-comprising essence of spiritual powers (Daimons, Angels), which alone acts upon the universe. In this sense, the Logos stands as the *Divine Reason*, the *Power of all Powers*, the *Spirit of God*, and His *Representative*, between Him and all else. Nay, he goes so far as to call it the *Archangel*, who executes the behests of God to man; the *High-priest*, who prays for man, and interferes on his behalf, before the throne of the Almighty; and he finally speaks of Logos as 'the second God' (*De Somn.* i. 655), and the 'Providence' (Fate, Fortune) which watches over the destinies of mankind and separate nations (*Quod Deus*, i. 298). These conceptions, which, he says, came to him in a trance, he does not allow, however, to be in the least derogatory to the strictest belief in the oneness, invisibility, and pure spiritualness of God, such as it is taught in the Jewish creed.—This characterises sufficiently the general vagueness and haziness of philosophical and theological parlance and speculation in the Alexandrine schools, which, obviously unconscious of the palpable contradictions uttered in one breath, mixed up pure thought and visions, Scripture with eastern and western philosophy and theosophy, monotheism and polytheism, heaping systems upon systems, and dreams upon dreams.

If the apostle did not himself, to a certain degree, stand under the influence of some of the popular ideas connected with the term under consideration, it would, at any rate, seem most natural that he made use of it, as of one conveying a certain vague, yet commonly recognised transcendental notion of a divine emanation to the minds of his contemporaries. This opinion, however, is far from being unanimously adopted. Thus, some investigators hold that John, irrespective of the parlance of his day, used the word Logos for *Logomenos*, i. e., He of whom it has been spoken, the Promised one; others identify it with 'doctrine;' while a third notion (held among others by Calvin and Luther) would make it equal to monologue, conversation.

For the person of the Logos as the mediator (*Æon*, *Demiurgos*, &c.), and the respective relation between him and the other persons of the divine trias, we must refer to the articles CHRIST, Gnostics, TRINITY.

LOGROÑO (Lat. *Julia Briga*), a town of Spain, capital of the province of Logroño, is situated on the Ebro, 60 miles east of Burgos. It is surrounded by walls, has several churches, convents, a theatre, college, some manufactures, and a good trade in rural produce. Pop. 10,466.

LOGWOOD, the dark red solid heart-wood of *Hæmatoxylon Campechianum*, a tree of the natural order *Leguminosæ*, sub-order *Casalpinizæ*. This tree grows in Mexico and Central America, and is

perhaps a native of some of the West India Islands; but is said to have been introduced into Jamaica in the beginning of the 18th c., although it is now naturalised there. It is the only known species of its genus. It grows to a height of 20—50 feet; the leaves are pari-pinnate; the racemes many-flowered, and longer than the leaves. The sapwood is yellowish, and being worthless, is hewed off with the bark. The heart-wood is heavier than water, close-grained, but rather coarse. It has a slight smell resembling that of violets, a sweetish taste, is astringent, and contains a distinguishing crystalline principle, called *Hæmatoxyline* (q. v.).

No dye-wood is imported in such large quantities as L.; nearly 50,000 tons are annually sent to Great Britain. It was first introduced in the reign of Queen Elizabeth, but the colour was found to wash out, and the dyers not knowing how to fix it, much dissatisfaction was occasioned by the sale of cloths dyed with it, and an act of parliament was passed prohibiting its use. This act was repealed in 1661, since which time it has been constantly in use, science having shewn means for fixing. L. is imported in large billets or logs, usually about 4 feet in length, 18 inches in diameter, and of very irregular shape; the larger they are, the greater their value; the colour is a dark blood-red, becoming almost black after long exposure. The infusion of the wood is also blood-red, which colour it yields readily to boiling water; it is changed to light red by acids, and to dark purple by alkalis. In dyeing with L., an alum mordant gives various shades of purple and violet—with the solution of tin, it gives violet, red, and lilac; with the sulphate or acetate of iron, it gives a black; but this is greatly improved in depth and softness, if gall-nuts are also used, which is generally the case. It is also one of the ingredients in both black and red ink; but Brazil-wood is usually preferred for the latter.

LOIR-ET-CHER, a department of France, lying on both sides of the river Loire, and formed of part of the old province of Orléannois, comprises the arrondissements of Blois, Vendôme, and Romorantin. Area, 1,568,677 square acres; pop. (1862) 269,029. The department is almost a uniform plain, broken only by vine-hills of trifling elevation. The northern part is more fertile than the south, three-fourths of which is occupied by marshes, heaths, and forests—the last of which, indeed, cover one-sixth of the entire surface. The chief products are corn, fruits, hemp, wine, and vegetables of all sorts. The rearing of sheep, poultry, and bees, is carefully attended to, and there are also manufactures of woollens, cottons, leather, glass, &c. Principal towns, Blois, Romorantin, and Vendôme.

LOIRE (ancient *Liger*), the longest river in France, has its source in the Cevennes Mountains, near Gerbier-des-Joncs, in the department of Ardèche, at an elevation of 4550 feet, flows in a north-north-western direction through the centre of France as far as Orleans, where it bends round to the south-west as far as Tours, and thence follows, in general, a western course to its embouchure in the Bay of Biscay. Entire length, 530 miles. It becomes navigable a little above Roanne, at a distance from the sea of 450 miles. At one time, the depth of the water at its mouth was 18 feet at ebb-tide; now, it is only from 6 to 9 feet. The lower course of the L. is adorned by wooded islets. In the lower part of its course, large dikes or *levées* have been built, to protect the surrounding country from inundations, from which, however, they sometimes suffer terribly. It receives about 40 affluents, of which the principal are, the Loir, on the right;

and the Allier, the Cher, the Indre, and the Vienne, on the left.

LOIRE, a department in the south-east of France, formerly part of the province of Lyonnais, comprises the arrondissements of Montbrison, Roanne, and St Etienne. Area, 1,178,234 English acres; pop. (1862) 517,603. The basin of the Loire, which flows through this department, is a rather unfruitful valley, but the mountains are rich in iron and lead, and the coal-fields of the department are the richest in France. L. is also noted for the rearing of silkworms, and for the excellence of its silk manufactures. The weaving of hemp and linen is also largely carried on. Its mineral springs are in great repute, especially those of St Alban, Sail-sous-Couzan, and St Galmier. The chief towns are St Etienne, Roanne, Rive-de-Gier, and Montbrison.

LOIRE, HAUTE, a central department of France, bounded on the south by the departments of Lozere and Ardèche. Area, 1,212,160 square acres; pop. (1862) 305,521. The surface is mountainous; covered by the Cevennes, the Cantal Mountains, and the Margaride chain, whose slopes are clothed with forests, and whose peaks are during about half the year covered with snow. Chief rivers the Loire and the Allier. The soil of the plains is fertile, and the agricultural produce of the soil consisting of the usual crops with fruits is abundant. The climate is very various, owing to the irregularity of the surface. The arrondissements are Le-Puy, Yssengeaux, and Brioude; the capital, Le-Puy.

LOIRE-INFÉRIEURE, a maritime department in the west of France, formed out of the southern portion of the old province of Brittany, and comprising the arrondissements of Nantes, Ancenis, Paimbeuf, Châteaubriant, and Savenay, lies on both sides of the river Loire. Area, 1,697,979 English acres; pop. (1862) 580,207. In the south of the department lies Grand-Lieu, the largest lake in France. The interior is, on the whole, flat, but the north-east and south-east are slightly hilly. The soil is fertile, producing wheat, rye, and barley, and forming in some parts rich pasturage. There are also some fine forests. Salt marshes are numerous in the west. The vineyards yield annually about 32 million gallons of wine. Ship-building is carried on extensively at Nantes. The coast-fisheries and general export trade of the department are extensive. Capital, Nantes; none of the other towns are large.

LOIRET, a central department of France, formed out of the eastern portion of the old province of Orléannois, and comprising the arrondissements of Orleans, Montargis, Gien, and Pithiviers, lies on both sides of the river Loire. Area, 1,670,984 English acres; pop. (1862) 352,757. The country is, for the most part, an elevated and fruitful plain, abounding in corn and wine—known as the plateau of Orleans; but the district along both banks of the Loire, called the *Sologne*, is a barren, sandy tract. L. contains several large forests. Cattle, sheep, and bees are extensively reared, and mineral springs are numerous.

LO'JA, a town of Spain, in the province of Granada, is situated on the slope of a hill near the left bank of the Xenil, 31 miles west of Granada, and 41 north-north-east of Malaga. Pop. 14,700. L. is a thriving place, with 21 woollen factories, 3 paper-mills, and two hospitals, and was once of great military importance, being the key to Granada. The summit of the slope on which the town is built is crowned with the ruins of a Moorish castle.

LOKEREN, a town of Belgium, province of East Flanders, on the Durme, 12 miles east-north-east of Ghent. It is a station on the Ghent and Antwerp Railway. Pop. 17,100. L. is a well-built town, with numerous schools, benevolent institutions, important manufactures of linen, cotton, and woollen goods, and large bleach-fields.

LOKI, a demi-god in the Scandinavian mythology. He did not belong to the race of the Aesir (see *ÆSES*), but to an older dynasty. Still, we find him from the very first on terms of intimacy with Odin, and received among the Aesir. His appearance is beautiful, and he is possessed of great knowledge and cunning. He often brings the new gods into difficulties, from which, however, he again extricates them. Hence he is to be regarded as the principle of strife and disturbance in the Scandinavian mythology; the 'Spirit of Evil,' as it were, mingling freely with, yet essentially opposed to, the other inhabitants of the Norse heaven, very much like the Satan of the Book of Job. By his artful malice, he caused the death of Balder (q. v.), and was in consequence visited by the Aesir with most terrible punishments. He is sometimes called *Asa-Loki*, to distinguish him from *Utgarda-Loki*, a king of the giants, whose kingdom lies on the uttermost bounds of the earth; but these two are occasionally confounded. It is quite natural, considering the character of L., that at a later period he should have become identified with the Devil of Christianity, who is called in Norway, to the present day, *Laake*.

LOKMAN (*ABU AMAN*?), a fabulous personage; the supposed author of a certain number of Arabic fables. He is by some Arabic writers called a nephew of Job or Abraham; by others, a councillor of David or Solomon; others, again, identify him with Balaam, whose name signifies, like that of L., the *Devourer*. Equal uncertainty reigns respecting his native place and occupation. Thus, he is variously held to have been an Ethiopian slave, conspicuous for his ugliness; a king of Yemen; an Arabic tailor; a carpenter; a shepherd; and the like. Most probably, the circumstances and sayings of several men living at different periods have been fathered upon L., of whom Mohammed (Surah 31) says that to him 'has been given the *Wisdom*.' There is also a great likeness to be recognised between himself and his fables and *Æsop* and those current under the latter's name. According to the Arabic writers, to L., as the Ideal of Wisdom, the kingdom of the world was offered, but was by him declined—provided this was no offence against piety—because he felt much happier as he was; and that when asked what was the secret of the goodness and wisdom of all his deeds, he replied: 'It is this: I always adhere to the truth; I always keep my word; and I never mix myself up with other people's affairs.'

The fables that go by L.'s name are for the most part Indian apologues, which were first rendered into Greek, thence into Syriac, and finally into Arabic. They are, in this last form, of a comparatively recent date, and thus unknown to all the classical writers. The language is very corrupt, and it is highly to be regretted that the book, for want of anything better, still holds its rank as an elementary book for Arabic students. Its first redaction is, according to a note to a manuscript in the Imperial Library in Paris (Suppl. No. 58), due to an Egyptian Christian, Barsuma, who probably lived towards the end of the 13th century. The first edition, with a Latin translation, by Erpemiua, appeared at Leyden (1615). The book has been frequently translated into European languages—into French, by Tanneguy, Schier, &c.; into Spanish, by

Miguel Garcia Ascensio, &c.; into Danish, by Rask; into German, by Olearius, Schaller, &c. Recent editions are by Bernstein (Gött. 1817), Causain de Perceval (Paris, 1818), Freytag (Bonn, 1823), Rödiger (Leip. 1830, &c.), Schier (Dres. 1831), Rasch (Copenh. 1832), Derenburg (Berl. 1850), &c.

A book, *Amthal* (Parables), ascribed to L., and supposed to contain more than a thousand apologies, maxims, parables, sentences, &c., has never been discovered. L.'s supposed grave is shewn at Ramlah, near Jerusalem.

LOLIUM. See DARNEL and RYE-GRASS.

LOLLARDS, or **LO'LLHARDS,** a semi-monastic society, the members of which devoted themselves to the care of the sick and of the dead. It was first formed about the year 1300 in Antwerp, where some pious persons associated themselves for the burial of the dead. They were called from their frugal life, and the poverty of their appearance, *Matemans*; also, from their patron saint, *Brethren of Saint Alexius*; and, on account of their dwelling in cells, *Fratres Cellitis*; whilst they acquired the name L. from their practice of singing dirges at funerals—the Low-German word *lollen*, or *lullen*, signifying to sing softly or slowly. They soon spread through the Netherlands and Germany, and in the frequent pestilences of that period, were useful, and everywhere welcome. The clergy and the begging-friars, however, disliked and persecuted them, classing them with the heretical *Beghards* (see *BEGUINES*), till Gregory XI. took them under his protection in 1374. Female Lollard societies were formed in some places. The L. having been reproached with heresy, their name was afterwards very commonly given to different classes of religionists, sometimes to the truly pious, sometimes to the worst pretenders; and in England, it became a designation of the followers of Wicliffe (q. v.), and thus extended into Scotland, where the *L. of Kyle* (in Ayrshire) attracted attention, and became the objects of persecution in the end of the 15th century.

LOMBARD, PETER (rather, Peter the Lombard), one of the most famous of the Schoolmen, was born at a village near Novara, in Lombardy. He was a pupil of Abelard, afterwards became a teacher of theology in Paris, and in 1159 was appointed Bishop of Paris. Bayle says that he was the first who obtained the title of Doctor of Theology in the university of Paris. He died at Paris in 1164. He was very generally styled *Magister Sententiarum*, or the *Master of Sentences*, from his work *Sententiarum Libri IV.*, an arranged collection of sentences from Augustine and other Fathers, on points of Christian doctrine, with objections and replies, also collected from authors of repute. It was intended as a manual for the scholastic disputants of his age, and as may be inferred from what has just been said, is a compilation rather than an original work. It was the subject of many commentaries down to the time of the Reformation. The works of Peter L. were edited by Aleaume (Louvain, 1546).

LOMBARD ARCHITECTURE is the style which was invented and used by the Gothic invaders and colonists of the north of Italy, from about the age of Charlemagne till it was superseded by the importation of the pointed style from France in the beginning of the 13th century. The architecture of the Lombards was derived from the Romanesque (q. v.), or debased Roman style which they found in the country—the general plan of the churches, and the general form of the pillars, arches, &c., being almost identical with that of the Roman Basilicas (q. v.). But in detail, there is no such resemblance; the Roman traditions are entirely abandoned, and instead of

the debased acanthus leaves and fragments of entablatures, so characteristic of the Romanesque style, the Lombards adopted a freer imitation of natural forms in their foliage, and covered their buildings with representations of the fights and hunting-expeditions in which they delighted. On their first arrival in Italy, they used Italian workmen; but when their own people became more numerous, they also laid aside the sword for the trowel. Accordingly, wherever in North Italy the Lombards were numerous, their style prevailed; and where the Romans predominated, the Romanesque prevailed. The north of Italy belonged naturally, at the time of Charlemagne, to the great German empire, and thus we find nearly the same style of architecture in Lombardy and in Germany as far north as the Baltic. See *RHENISH ARCHITECTURE*. Few early examples of Lombard architecture exist. In the unruly times when the style originated, the buildings were no doubt frequently destroyed by fire; this seems to have led to the desire to erect fireproof structures, and thus the earlier as well as almost all the later examples are vaulted with stone, whereas the Romanesque basilicas are generally roofed with wood. This stone roof seems to have been the great desideratum in the new style. The earliest example is a small chapel at Friuli, built probably during the 8th c., and it is covered with an intersecting vault. Examples of this date are rare in Italy; but in Switzerland, where the style is almost identical, several interesting specimens of early architecture remain, such as the churches of Romain-Motier, Granson, Payerne, &c., in which the transition from the Romanesque to the round arched Gothic is very clearly traceable. We there find the peculiar arch-ornament so characteristic of Lombardy and the Rhine (fig. 1), and we can trace the timid steps by which the



Fig. 1.

Goths advanced in the art of vaulting. The vaulting is the leading feature of Lombard architecture, and from it spring the other distinguishing forms of the style. Thus, the plain, round pillars, with a simple base and capital, which served to support the side-walls and roof of a basilica, are changed for a compound pier, made up of several shafts, each resting on its own base, and each provided with a capital to carry the particular part of the vaulting assigned to it. This change is deserving of particular notice as the first germ of that principle which was afterwards developed into the Gothic Style (q. v.). Buttresses are also introduced for the first time, although with small projection.

The *Cathedral of Novara* is one of the most striking examples of Lombard architecture. It belongs to the 11th century. The plan (fig. 2) shews the arrangement common at this epoch all over the German empire. It is derived from the old basilican type, having at the west end an open atrium, with arcade around, from which the church is entered by a central door. The interior is divided into central and side aisles, with vaulted roof, and terminated with an apsidal choir. At the end of the atrium opposite the church, is situated the baptistery. At Asti, there is an interesting example of the early Lombard Baptistery. The same general arrangement of plan afterwards became common in the German churches, the atrium being roofed over and included in the nave, and the baptistery forming the western apex of the double-apsed churches. The elevation of Novara is ornamented with those arcades and arched

string-courses so common in Lombard and Rhenish architecture (fig. 1).

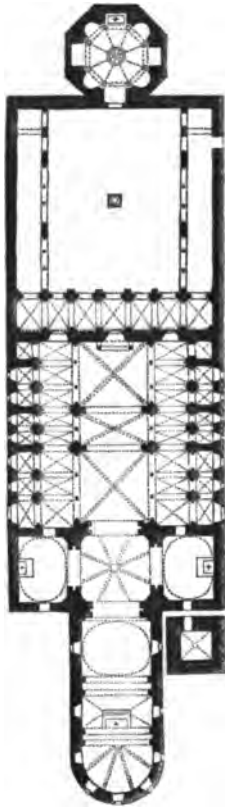

Fig. 2.—Plan of the Cathedral of Novara (copied from Ferguson's *Handbook*):
Scale, 1 in. = 100 feet.

San Michele at Pavia, and San Ambrogio at Milan, are also good early examples of this style. In both, the grouping of the piers into vaulting shafts, wall-arch shafts, &c. (fig. 3), is complete, and that beautiful feature of the style, the arcade round the apse (fig. 4), is fully developed. The

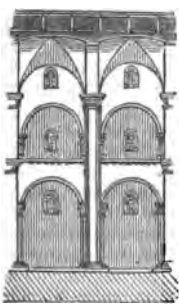

Fig. 3.

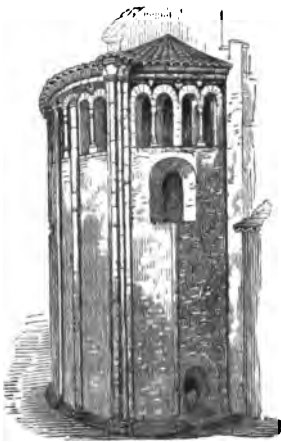

Fig. 4.

atrium and west front of San Ambrogio form one of the finest groups of Lombard architecture.

Lombard architecture is important as forming

a link between the Romanesque of Italy and the Gothic of the Cisalpine countries. On the one hand, its origin can be traced back to the Roman basilicas; while on the other it embodied those principles from the development of which sprang the great Gothic style of the middle ages.

LOMBARDS, a German people of the Suevic family, not very numerous, but of distinguished valour, who played an important part in the early history of Europe. The name is derived from *Longobardi*, or *Langobardi*, a Latinised form in use since the 12th c., and is generally supposed to have been given with reference to the long beards of this people; although some derive it rather from a word *parta*, or *barte*, which signifies a battle-axe. About the 4th c., they seem to have begun to leave their original seats (on the Lower Elbe, where the Romans seem to have come first in contact with them about the beginning of the Christian era), and to have fought their way southward and eastward, till they came into close contact with the eastern Roman empire on the Danube, adopted an Arian form of Christianity, and after having been for some time tributary to the Heruli, raised themselves upon the ruins of their power, and of that of the Gepidæ, shortly after the middle of the 6th c., to the position of masters of Pannonia, and became one of the most wealthy and powerful nations in that part of the world. Under their king Alboin (q. v.), they invaded and conquered the north and centre of Italy (568—569). The more complete triumph of the L. was promoted by the accession of strength which they received from other German tribes following them over the Alps—Bulgarians, Sarmatians, Pannonians, Norici, Alemanni, Suevi, Gepidæ, and Saxons—for the numbers of the L. themselves were never very great.

The L., after the example of the Romans themselves in the conquests of former times, were for the most part contented with a third of the land or of its fruits. One of their kings, Authari (584—590), assumed the title of Flavius, which had been borne by some of the later Roman emperors, and asserted the usual claims of a Roman ruler; whilst the administration of the Lombard kingdom was soon so superior to that which then prevailed in other parts of Italy, that to many the change of masters was a positive relief from unjust and severe exactions. Whilst the higher nobility, however, in general retained some portion of their former wealth and greatness, the possessors of small properties became fewer in number, and sunk into the class of mere cultivators, to whom it was comparatively indifferent whether they acknowledged a Roman or a Lombard superior. The rights of the municipal corporations also, although acknowledged, were gradually abridged, partly through the encroachments of the Lombard dukes, and partly through those of the higher clergy, till few relics of their ancient self-government remained. These few, however, were the germs from which, at a subsequent period, the liberties of the independent Italian cities were developed.

The conversion of the Arian L. to the orthodox faith was brought about by the policy of Gregory the Great and the zeal of Theodolinda, wife of Authari, and subsequently of his successor, Agilulf (590—615).

Theodolinda persuaded Agilulf to restore a portion of their property and dignities to the Catholic clergy, and to have his own son baptized according to the Catholic rites. She also built the magnificent Basilica of St John the Baptist at Monza, near Milan, in which in subsequent times was kept the Lombard crown, called the *Iron Crown* (q. v.). The L. were

LOMBARDY—LOMBOK.

erelong fully united to the Roman Catholic Church. The contests of the dukes prevented the firm consolidation of the kingdom, or any very considerable extension of its boundaries. The *Edict* of the Lombard king, Rothari (638—654), declaring the laws of the L., promulgated 22d November 643, is memorable, as having become the foundation of constitutional law in the Germanic kingdoms of the middle ages. It was revised and extended by subsequent Lombard kings, but subsisted in force for several centuries after the Lombard kingdom had passed away. The L., however, gradually became more and more assimilated to the former inhabitants of the land of which they had made themselves lords; their rudeness was exchanged for refinement, and the Latin language prevailed over the German, which they had brought with them from the other side of the Alps. But of the original Lombard language little is known, nothing remaining to attest its certainly German character except a few words and names, the very ballads in which the stories of Lombard heroes were recorded having only come down to us in Latin versions.

Liutprand (713—744), raised the Lombard kingdom to its highest prosperity. He quelled with strong hand the turbulence of the nobles, gave the finishing blow to the exarchate of Ravenna, and sought to extend his dominion over all Italy. But the popes now entered upon that Machiavellian policy which they long incessantly pursued, of labouring to prevent a union of all Italy under one government, in order to secure for themselves the greater power in the midst of contending parties. This, with the disputes which arose concerning the succession to the Lombard throne, led to the downfall of the Lombard kingdom within no long time after it had reached its utmost greatness. The popes allied themselves with the Frankish kings, and Pepin, who had been anointed by Stephen II. to the 'patriciate,' i. e., the governorship of Rome, invaded Italy (754), and compelled the Lombard king Aistulf (749—754), who cherished the same ambitious designs as Liutprand, to refrain from further conquests, and even to give up some of the cities which had already yielded to his arms, which Pepin (755) bestowed upon the Roman Church and commonwealth. New causes of hostility between the Frank and Lombard monarchs arose when Charlemagne sent back to her father his wife, the daughter of the Lombard king Desiderius (754—774), and Desiderius supported the claims of the children of Carloman, Charlemagne's brother. In the autumn of 773, Charlemagne invaded Italy; and in May of the following year, Pavia was conquered, and the Lombard kingdom, after an existence of 206 years, was overthrown. In 776, an insurrection of some of the Lombard dukes brought Charlemagne again into Italy, and the dukedoms were broken down into counties, and the Lombard system, as far as possible, supplanted by that of the Franks. In 803, a treaty between Charlemagne, the western, and Nicephorus, the eastern emperor, confirmed the right of the former to the Lombard territory, with Rome, the Exarchate, Ravenna, Istria, and part of Dalmatia; whilst the eastern empire retained the islands of Venice and the maritime towns of Dalmatia, with Naples, Sicily, and part of Calabria. Compare Türk's *Die Longobarden und ihr Völkerrecht* (Bost. 1836); and Flegler's *Das Königreich der Longobarden in Italien* (Leip. 1851).

LOMBARDY, the name given to that part of Upper Italy which formed the 'nucleus' of the kingdom of the Lombards (q. v.). It consisted of the whole of Italy north of the peninsula, with the exceptions of Savoy and Venice, and after the fall of the Lombard kingdom, in 774, was incorporated

in the Carolingian empire. In 843, it was created a separate kingdom, but was not entirely severed from the Frankish monarchy till 888. From this time it was ruled by its own kings till 961, when it was annexed to the German empire. Out of the wrecks of the old independent kingdom now arose a number of independent duchies, as Friuli, Mantua, Susa, Piedmont, &c., and soon afterwards the republics of Venice, Genoa, Milan, and Pavia. These republics consisted of one sovereign town, surrounded by, in many cases, a large extent of dependent territory. The Lombard cities declared themselves independent towards the commencement of the 12th c., and in 1167 were joined by their less powerful neighbours in the 'first Lombard league,' for the maintenance of their liberties, against Frederic Barbarossa, whom they severely defeated in 1176. In 1225, they were compelled to form the 'second Lombard league' against Frederic II., and with similar success. About this time, petty tyrants arose in most of the cities, and the country was distracted by internal dissensions, which were carefully fostered by France and Germany. These two great powers and Spain strove for the possession of Lombardy. The last succeeded in obtaining it in 1540, and held possession till about 1706, when after another dispute, the duchies of Milan and Mantua (the country bounded by the Ticino, Po, Mincio, and Switzerland), which alone now retained the name of L., came into the hands of Austria, and were designated 'Austrian Lombardy.' In 1796, it became part of the Cisalpine republic, but in 1815 was restored to Austria, and annexed politically to the newly-acquired Venetian territory under the name of the Lombardo-Venetian Kingdom. This union was dissolved in 1859 by the Italian war; L. was given up to the new kingdom of Italy, Austria, however, retaining her Venetian territory. There is now no official division called L., the country having been parcelled out into the provinces of Bergamo, Brescia, Como, Cremona, Milan, Pavia, and Sondrio. Its total area was 8264 English square miles, with a population (1858) of 3,039,055.

The northern districts of L. are alpine in character, but the rest of the country is of extraordinary fertility, induced chiefly by the universal practice of irrigation. The country is celebrated for the products of its pasture-land, and as much as 50,000,000 lbs. of cheese is annually produced in the dairies of Lombardy. Agriculture is here in a more advanced state than in any other part of Italy, wheat, rice, and maize being the principal crops; melons, gourds, oranges, figs, citrons, pomegranates, peaches, plums, and other fruits of excellent quality, are largely produced. The numerous mulberry plantations form another prominent feature, and vines are extensively cultivated, though the wine produced from them is of inferior quality. Various kinds of marble, some of them of great beauty, form the chief item in the mineral products of L.; a few iron mines exist in Como and Bergamo. The chief manufactures are silk, cotton, and woollen goods, flax, paper, glass, and pottery; the annual value of the silk exceeds £3,000,000. Education is very generally diffused among the people, and they are well supplied with newspapers and scientific and literary journals.

LOMBOK, an island in that crescent group in the Malayan Archipelago known as the Sunda Islands. It lies between Bali on the west, and Sumbawa on the east; lat. from 8° 12' to 9° S., long. from 115° 44' to 116° 40' E. Area estimated at 1480 square miles; pop. at 200,000, who are all Mohammedans. The north and south coasts are each traversed by a chain of mountains, some of which are volcanic, but

the interior is a fertile valley. Rice and cotton are largely cultivated, 20,000 tons of the former being exported annually. The capital is Mataram, the principal seaport, Ampanam.

LOM'ENTUM. See **LEGUME.**

LO'MOND, LOCH, the largest of the Scottish lakes, lies between Dumbartonshire on the west, and the counties of Stirling and Perth on the east. It is 24 miles long, is 7 miles broad at the southern extremity, though the northern half is only about a mile in width, and has an area of 45 square miles. Its depth varies from 60 to 600 feet, and its surface is only about 22 feet above the level of the sea. The waters of the loch are swelled by the contributions of many streams, the chief of which is the Endrick, from the south-east; the surplus waters are carried off by the Leven, an affluent of the Clyde. The lower portion of the loch is surrounded by a hilly but well-cultivated and finely wooded country, and the character of the scenery is in the highest degree rich and beautiful. Around the northern portion of the loch are piled high, wild, and picturesque masses of mountains—Ben Lomond on the east, and the Arrochar hills on the west. The surface is dotted over with numerous islands, which are finely diversified in their general appearance, and contribute greatly to the exquisite beauty of the scene. Several steamers ply on the lake.

LO'MZA, a district town in the government of Angustovo, in Poland, on the left of the Narev, a tributary of the Vistula, and 85 miles north-east of Warsaw, played a prominent part in the history of Poland, but has never recovered from its sufferings during the Swedish wars. L. has a college, a gymnasium, an arsenal, and several paper-mills, and cloth and linen factories in its neighbourhood. Pop. 6043.

LO'NDON, the capital of the British empire, stands on both banks of the Thames, about 60 miles from the sea. The dome of St Paul's is in lat. 51° 30' 48" N., and in long. 5° 48' W. The river here varies from 900 to 1200 feet in width.

London, under the names *Londinium*, *Londinum*, and *Augusta*, was one of the chief stations of the Romans in Britain. They encircled a portion of what is now the City with a wall, which was rebuilt and extended in later ages. In Stow's time, the remains of the Norman or Anglo-Norman wall were about two miles in extent, from the Thames at the Tower to the Thames at Blackfriars. The great fire of 1666, and continual reconstructions in later ages, have nearly obliterated all traces of the old wall. The seven gates which pierced it are entirely gone, *Temple Bar* being merely one of the outer bars or suburban gates.

It is almost impossible to say what is the size of L., because there is no definite number of surrounding villages and parishes included within it. 'London within the walls,' the original City, comprises only 370 acres; 'London without the walls' comprises 230 acres; then there are the city of Westminster and the borough of Southwark; the 'Tower Hamlets,' comprising Bethnal Green, Whitechapel, Stepney, Mile End, Poplar, &c.; the northern suburbs of Marylebone, Pancras, Hampstead, Islington, Hackney, &c.; the western suburbs of Kensington, Chelsea, Fulham, Paddington, &c.; many parishes in the centre, but westward of the City; Bermondsey, Lambeth, Newington, Wandsworth, Rotherhithe, &c., in Surrey; and Deptford, Greenwich, and Lewisham, in Kent. The *Post-office* L. is larger than the *Parliamentary* L.; and the *Police* L. is larger than either. It is usual, however, now to take, as the limit of L., the area under the operation of the 'Metropolis Local Government Act,'

which is also adopted by the Registrar-general for the Census, and which is nearly identical with the area under the control of the Metropolitan Board of Works. This area contained, in 1851, 305,933 inhabited houses, and 2,362,236 inhabitants; and in 1861, 330,237 inhabited houses, and 2,803,034 inhabitants. In round numbers, the dimensions may be estimated at about 13 miles from east to west, and 9 from north to south; but the shape is very irregular; all that can be said relates to the area, which is 117 square miles. For *Parliamentary* purposes, L. constitutes eight boroughs—viz., City of London, Westminster, Southwark, Marylebone, Finsbury, Tower Hamlets, Lambeth, and Greenwich; the first sending four members, and the others two each. The Tower Hamlets alone contained 570,898 inhabitants in 1861. For *Poor-law* purposes, L. is divided into 40 unions, in some cases single parishes, in others groups of parishes. The 'Metropolitan Buildings Act' of 1855—which gives some kind of official control over the ranging of houses in streets, the removal of projections and sheds, the management of rebuilding and repairs, the compulsory repair of houses in a dangerous condition, &c.—divides the metropolis into 56 districts, of which 4 are in the City of L., 5 in the City of Westminster, 30 in other parts of the metropolis north of the Thames, and 17 south of the Thames. Each of these has a district officer and a district surveyor.

The Thames at L. is crossed by the following *Bridges*, now (August 1863) either built or building: London Bridge, South-eastern Railway City Bridge, Southwark Bridge, Chatham and Dover Railway Bridge, Blackfriars Bridge, Waterloo Bridge, Charing Cross Railway and Foot Bridge, Westminster Bridge, Lambeth Bridge, Vauxhall Bridge, Pimlico Railway Bridge, Chelsea Bridge, Battersea Bridge, West London Railway Bridge, Putney Bridge, and Hammersmith Bridge. (The bridges at Barnes, Kew, and Richmond can scarcely be said to be within metropolitan limits.) Near and between these bridges are about 20 *Steam-boat piers*, for the accommodation of river-passengers. The *Thames Tunnel* forms a footway under the river, 1200 feet long, about two miles below London Bridge. For the accommodation of such shipping as cannot conveniently load and unload in the river, *St Katharine's Docks*, *London Docks*, *Limehouse Docks*, *West India Docks*, *East India Docks*, and *Victoria Docks*, have been formed on the northern shore; and the *Commercial* and *Grand Surrey Docks* on the southern. The part of the Thames just below London Bridge, called the *Pool*, is the great rendezvous for coal-ships; below that, as far as Blackwall, is the *Port*, occupied by ships of greater burden. Of *Canals*, the Paddington, Regent's, and Grand Surrey are the chief.

In matters of government, L. is under very varied jurisdiction. The lord mayor and corporation exercise peculiar powers in the City, in reference to tolls, dues, markets, the administration of justice, police, drainage, lighting, paving, and a variety of other matters. The City is divided into 25 *Wards*, each represented by an alderman; the aldermen are chosen for life, and are magistrates by virtue of their office. The *Common Council* consists of 206 members, who, with the lord mayor and aldermen, form a kind of parliament for the management of City affairs. The *Mansion House* and *Guildhall* are the chief buildings for the transaction of corporate business. The *Metropolitan Commissioners of Police*, and the *Metropolitan Board of Works*, have control over the whole metropolis except the City. Westminster and Southwark are each under local authorities, but only in minor matters. The *Drainage* is managed

by two Boards of Works, one for the City, and one for the rest of the metropolis; and is now being improved by a vast and costly system of sewerage, paid for by the householders. Nearly all the drainage and sewage, after the year 1866, will enter the Thames at points 12 miles below London Bridge, instead of in London itself; the expense of the new sewers will exceed £4,000,000. The Gas supply is in the hands of joint-stock companies; and so is the Water supply: the water being obtained from the Thames, and from the New River, one of its affluents. In Police jurisdiction, the City of L. is entirely distinct from the rest of the metropolis. In 1863, an attempt was made by the government to bring all under one jurisdiction; but the opposition of the citizens was so strong, that the attempt failed. The City police, about 650 in number, are in 6 divisions, and have 7 stations; there are 2 police-offices or justice-rooms, one at the Mansion House, and one at Guildhall. All the rest of the metropolis is under the Commissioners of Metropolitan Police, with head-quarters at Whitehall. There are 18 divisions, all but one (the Thames Police) denoted by letters of the alphabet; the full force, officers and men, is about 7000. There are 15 police-offices, attended by 27 police magistrates, for taking cognizance of offences within the metropolis, but outside the City.

The Streets of L. depend mainly for their direction on the course of the Thames; the principal of them being nearly east and west. One line of route extends from Hammersmith to Mile End and Bow, through Piccadilly, Strand, and Cheapside; another, beginning in the Uxbridge Road, passes through Oxford Street and Holborn, and joins the former at Cheapside. There is still a deficiency of wide thoroughfares for the City traffic; but a new street about to be made from Blackfriars Bridge to the Mansion House will open a new and useful avenue—in connection with an important *Thames Embankment*, which is to extend from Blackfriars Bridge to Westminster Bridge, on the north bank of the river. Most of the new streets formed within the last few years are far superior in all respects to those formed fifty or a hundred years ago—except those at the outskirts, which are mostly poor and slight. Regent Street and the Quadrant form the finest street in London, for general effect; but the most palatial street is Pall-Mall, owing to the number of *Club-houses* situated there, most of which are fine buildings. Of the 50 principal club-houses in L., the *Army and Navy, Guards, University, Carlton, Reform, Travellers, Athenæum, United Service, and United University*, are in this one street. Perhaps the wealthiest range of shops in the world is that which lies on the route from Charing Cross to Cornhill.

Among the buildings in L. belonging to the crown or to the nation, the following are the principal: *St James's Palace*, an irregular and inelegant cluster of buildings, used for court purposes, but not as the Queen's residence. *Buckingham Palace*, the Queen's London residence, a large but low quadrangular mass, with very inadequate court accommodation. *Marlborough House*, lately refitted and furnished as a residence for the Prince and Princess of Wales. *Kensington Palace*, occupied not by royalty, but by recipients of court-favour. *Houses of Parliament*, a vast structure, which has cost £3,000,000; perhaps the finest, and certainly the largest, Gothic building in the world applied to civil purposes; the river-front is 900 feet long. *Westminster Hall*, a noble old structure, of which the main hall is 290 feet by 68, and 110 high. *Somerset House*, a quadrangular structure with a river-frontage of 600 feet; it is mostly occupied by government offices. The *Admiralty*, noticeable chiefly for the

screen in front of the courtyard. The *Horse Guards*, the official residence of the commander-in-chief, with an arched entrance to St James's Park. The *Treasury*, the *Home Office*, the *Privy Council Office*, and the *Board of Trade*, occupy a cluster of buildings in Whitehall. The *Foreign, Colonial, India, and Exchequer Offices* are being rebuilt. The *War Office*, in Pall-Mall, a large but plain brick building. The *British Museum* (q. v.). The *National Gallery*, one half devoted to a portion of the national pictures, and the other to the Royal Academy. The *Museum of Economic Geology*, in Jermyn Street, a small but well-planned building. The *South Kensington Museum*, a medley of buildings more remarkable for convenience than for beauty, and filled with a miscellaneous but valuable collection. The *Custom House*, with a long room 190 feet by 66, is finely situated on the river-side. The *General Post-office*, a noble mass in St Martin's-le-Grand, has a central hall 80 feet by 60, and 53 high, with a vast number of offices all around it. The *Mint*, on Tower Hill, is a cluster of buildings in which the gold and silver coinage is managed. The *Tower of London* is a confused mass of houses, towers, forts, batteries, ramparts, barracks, armouries, storehouses, and other buildings, included within a boundary of about 900 feet by 800, at the extreme eastern verge of the City.

L. is the seat of a bishopric, which comprises about 320 benefices. The income of the bishop is £10,000 a year. St Paul's is the cathedral for the diocese; it is situated at the east end of Ludgate Hill, extending to Cheapside, and was built by Sir Christopher Wren (1675—1710) at a cost of £748,000. It is built in the form of a cross, is 514 feet long, by 236 wide; the cross, which surmounts the ball over the dome, is 356 feet above the marble pavement below. St Paul's contains many monuments to illustrious persons. *Westminster Abbey*, also cruciform, is 530 feet in extreme outer length, by 203 in width; the west towers are 225 feet high. Henry VII.'s Chapel, at the east end, is a beautiful example of enriched Gothic. The Abbey has no special connection with the see of London, but is intimately connected with some of the court and parliamentary ceremonials. It was originally a Benedictine Monastery, and is said to have been founded by Sebert, king of the East Saxons (circa 616); enlarged by King Edgar and Edward the Confessor; and rebuilt, nearly as we now see it, by Henry III. and Edward I. Here the kings and queens of England have been crowned, from Edward the Confessor to Queen Victoria; and here many of them have been buried. The *Poet's Corner* is a well-known spot of the Abbey. *St Saviour's*, in Southwark, is the third in importance of the L. churches. The largest Roman Catholic Church is in St George's Fields. The largest Dissenting Chapel is Mr Spurgeon's Tabernacle. There are in L. about 850 places of worship; those open for service in the closing months of 1862 may be thus classified: Church of England, 335; do. chapels, 71; Independent, 100; Baptist, 89; Wesleyan, 104; Methodists, various, 43; Roman Catholic, 31; English Presbyterians, 11; Friends' Meeting-houses, 8; Jews' Synagogues, 10; Catholic and Apostolic (Irvingite), 6; Scotch, 7; various denominations, 36.

Of *Schools* of all kinds, there are in L. about 1200 *private*, and 600 *public*—the latter including Free, Parochial, National, and British Schools. The chief educational establishments are *King's College, University College, Gordon College, Regent's Park College, New College, Wesleyan College, Hackney College, Training Colleges* belonging to the National, British and Foreign, and Home and Colonial School Societies, *Westminster School, St Paul's School,*

LONDON.

Charter House School, Christ's Hospital, or the Blue Coat School, the Gray and Green Coat Schools, Merchant Taylor's School, Mercer's Grammar-school, City of London School, and two Ladies' Colleges.

There are about 70 almshouses in London. The societies, associations, and institutions, of a more or less permanent character, maintained for other than money-making objects, are not less than 600 in number. Of the *Hospitals*, the chief are *Guy's*, the *London*, the *Westminster*, the *Charing Cross*, *St George's*, *Middlesex*, *King's College*, *University College*, the *Small-pox*, the *Consumption*, the *Lock*, and the *Royal Free Hospitals*. *St Thomas's Hospital* (near London Bridge), owing to the extension of the South-eastern Railway, has been pulled down; it is to be rebuilt on another site. *St Luke's* and *Bethlehem* (for insane persons), and the *Foundling Hospital*, are special in their objects. Of the 600 institutions above alluded to, about 200 are hospitals, dispensaries, infirmaries, and asylums; while the remaining 400 are religious, visiting, or benevolent institutions.

There are 7 courts of equity, 3 courts of common law, 5 sheriffs' courts, and 10 county courts—besides various courts coming under other designations. There are five sessions-houses (Old Bailey, Guildhall, Clerkenwell, Westminster, and Horse-monger Lane). The prisons have undergone many changes within the last few years, partly owing to the decay of old buildings, and partly to changes in the law of imprisonment. At present, the buildings actually used as prisons are 12 in number—viz., Newgate, Holloway, Pentonville, Cold Bath Fields, Whitecross Street, Milbank, Tothill Fields, Clerkenwell, Brixton, Fulham, Horse-monger Lane, and Wandsworth. The chief buildings in L. connected with law and justice are the following: the *Westminster Hall Courts of Law and Equity*; the *Lincoln's Inn Courts of Equity*; the *Guildhall Courts*; the *Central Criminal Court* in the Old Bailey; *Ecclesiastical* and other special courts at *Doctors' Commons*, &c. What are called the *Inns of Court* are in some sense colleges for practitioners in the law; they comprise the *Inner Temple*, the *Middle Temple*, *Lincoln's Inn*, and *Gray's Inn*; and there are others called *Inns of Chancery*, comprising *Thavies'*, *Furnival's*, *Staple*, *Barnard's*, *Clifford's*, *Clement's*, *Lyon's*, *New*, and *Sergeant's Inns*. Connected incidentally with legal matters is the *Record Office*, a large depository for official papers in Fetter Lane. The legal practitioners in L., besides judges, &c., comprise about 3900 solicitors and attorneys, and 1900 barristers.

In connection with the shipping of L., and the import and export trade, the *Docks* above-named contain 273 acres of water space, and 106,000,000 cubic feet of warehouse, shed, and vault accommodation—besides warehouses in various parts of the city, away from the docks. In 1860 (1861 and 1862 were exceptional years, owing to the disturbance of trade occasioned by the civil war in America) the number of ships that entered or left the docks was 5819, with a tonnage of 1,996,438 tons—averaging a little over 300 tons each. This almost entirely excluded the colliers; for nearly all the sailing-vessels which come to L. laden with coal, instead of entering docks to unload their cargoes, lie in the stream of the river, and transfer their coal to lighters, which convey them to the yards of coal-merchants, situated either on the banks of the river itself, or of the canals which run into it. The shipping of the port of L., in 1860, comprised 2943 vessels, of 919,591 tons burden, giving an average, as in the above-named case, of a little over 300 tons each. One-fourth of the whole tonnage of England belonged to

London. The number was made up of 2516 sailing-vessels and 527 steamers. The port of L. owned more than half the large steamers in England. Of the 29,542 ships that entered the port of L. in 1860, there were 18,365 engaged in the *coasting* trade, 8949 in the *foreign*, and 2628 in the *colonial*; they had an aggregate tonnage of 6,151,291 tons, and nearly all came with cargoes. About the same number of vessels left the port; but many of these, especially the coal-ships, were in ballast. With regard to *kind*, 24,204 of the total number were sailing-vessels; the rest steamers. With regard to *country*, 24,666 were British; the rest foreign. In 1860, the declared real value of all the merchandise exported from the port of L. was £30,837,688, nearly one-fourth of that of the exports for the whole United Kingdom.

The imports of wheat, flour, cotton, dye-stuffs, palm-oil, copper ore, lard, saltpetre, molasses, and alpaca, are greater into Liverpool than into L.; while Hull takes the lead in flax, flax-seed, and iron; and Southampton in silk and cochineal. But in the greater number of articles L. takes precedence; and in many of them the proportion borne to the whole imports into the United Kingdom is very remarkable. The following figures refer to 1860:

	Into London.	Into whole of United Kingdom.
Live-stock,	341,282	387,219
Coffee,	72,784,354	82,787,746 lbs.
Cocoa,	6,678,631	9,009,800 "
Tea,	83,711,066	88,946,532 "
Sugar,	4,845,132	8,817,276 cwt.
Oats,	1,645,901	2,290,951 qrs.
Butter,	437,942	840,112 cwt.
Cheese,	292,506	563,283 "
Bacon and hams,	149,236	326,103 "
Salt meat,	241,835	434,268 "
Dried fruit,	624,737	998,185 "
Oranges and lemons,	511,111	1,184,410 bush.
Rice,	799,392	2,534,640 cwt.
Pepper,	10,533,319	12,810,040 lbs.
Mahogany,	22,590	44,710 tons.
Leather,	1,990,411	4,707,272 lbs.
Hemp and jute,	682,645	1,609,175 cwt.
Cocoa-nut oil,	187,870	194,309 "
Rum,	5,171,894	7,319,673 gals.
Brandy,	1,547,624	2,342,543 "
Wine,	8,629,323	11,795,000 "

The customs duties in the port of L. in that year amounted to £11,781,819.

The principal markets of L. are the *Cattle Market* at Pentonville, *Covent Garden* (vegetable) *Market*, *Billingsgate* (fish) *Market*, *Newgate* and *Leadenhall* (meat and poultry) *Markets*. The establishments for wholesale dealings are, of course, stupendous in character; of coal alone, L. now requires more than 4,000,000 tons annually. The whole number of distinct trades or occupations in L. is about 2000. There are about 80 *Trade Guilds* or *City Companies* in L., many of which possess large revenues; but they do not now exert much influence on the actual course of trade and manufactures; the chief among them, called the *Twelve Great Companies*, are the *Mercers'*, *Grocers'*, *Drapers'*, *Fishmongers'*, *Goldsmiths'*, *Skinners'*, *Merchant Taylors'*, *Haberdashers'*, *Salters'*, *Ironmongers'*, *Vintners'*, and *Clothworkers'* Companies, all of which have *Halls*, in which banquets are held. The *Goldsmiths'*, *Apothecaries'*, and *Stationers'* Companies still exercise some active control over those trades. The *Banks* in L., either private or joint-stock, are about 90 in number, many of which have two or more banking-houses. There are 95 *Insurance Offices*; some for life only, some for fire only, some for life and fire. The buildings for these banks and insurance offices are among the best in London. The *Bank of England*, one of Sir John Soane's most successful works, gives employment to

about 1000 clerks, &c. The *Royal Exchange* is noticeable chiefly for Sir R. Westmacott's sculpture in the pediment. The *Corn Exchange* and the *Coal Exchange* are convenient for their purposes. The *Stock Exchange*, near the Bank, is nearly hidden from view. The great warehouses for foreign and colonial produce lie chiefly eastward of the city; while the wholesale establishments for textile goods occupy enormous buildings in the neighbourhood of Cheapside and St Paul's Churchyard. Most of the large manufacturing establishments lie either eastward or southward, the centre and the west of the metropolis being engaged in selling rather than in making.

In relation to literary activity, as represented by periodicals printed and published in L., the following is an approximate estimate: L. morning newspapers, 12; L. evening newspapers, 7; L. weekly newspapers, 130; other L. newspapers, 55; periodicals of all kinds, other than newspapers, about 500. The printers, binders, publishers, and sellers of all kinds of books, newspapers, and pamphlets, comprise about 2200 L. firms.

The *Passenger and Goods Traffic* in L. requires vast resources. There are 10 railway companies, having the termini of their lines in L., besides 5 minor lines, more or less under the control of those companies. In addition to 10 large passenger-stations now open, 4 others are being constructed; while of smaller stations there are upwards of 60 north of the Thames, and 50 south of the Thames, within the limits of the metropolis. There is not at present any railway or system of railways going through the heart of L., but there are several boundary lines and links at the outskirts. The Metropolitan or Underground Railway, from Paddington to Farringdon Street, will probably make a junction with the Chatham and Dover line at the last-named point, and will thus complete a route entirely through the metropolis from north-west to south-east. The nature of the local railway traffic in L. may be illustrated by the fact, that on the Metropolitan Railway (3½ miles) there are more than 1000 trains per week, each accommodating 7 stations. There are in L. about 120 *Booking-offices* connected with inns, having relation to passenger and carrier traffic. For water-traffic, there are about 50 *wharfs and quays* on the Thames, besides a considerable number on the Regent's and other canals. There are about 1500 omnibuses, and 5000 cabs. It has been ascertained that, on an average day, 1000 vehicles per hour pass through Cheapside; and on an average day of 24 hours, 170,000 persons and 20,000 vehicles have been counted crossing London Bridge.

Of the open places in the metropolis, the *Parks* are the most important. *Hyde Park, St James's Park, the Green Park, Regent's Park, Victoria Park, Kensington Park, and Battersea Park*, all belong to the nation, and are purposely kept out of the builders' hands; they are most valuable as 'lungs' to London. *Primrose Hill* may be included in the number. The *Zoological Gardens, Horticultural Gardens, and Botanic Gardens* are beautiful places, belonging to private societies. The *Cemeteries*, substitutes for the old churchyards, are at Highgate, Finchley, Stoke Newington, Mile End, Kensal Green, Bethnal Green, Brompton, Colney Hatch, Camberwell, Norwood, &c. Of places of amusement, there are 2 opera-houses, about 20 theatres, 12 music-halls of large dimensions, a much larger number of smaller size, and very numerous exhibition-rooms of various kinds. Of public *Columns and Statues*, in open places, L. contains a smaller number than is due to its size. The chief are the following: The *Monument*, Fish Street Hill;

Nelson Column, Trafalgar Square; *Wellington Statue*, Hyde Park Corner; *Achilles' Statue*, Hyde Park; *Guards' Memorial*, Pall Mall; *Crimean Monument*, Westminster; *York Column*, Waterloo Steps; *Havelock's and Napier's statues*, Trafalgar Square; *Peel's Statue*, Cheapside, &c. Of *Fountains*, there are scarcely any except in Trafalgar Square; but *Drinking Fountains* are becoming very numerous. There are about 60 *Baths* in L., of which 12 are cheap *Public Baths and Wash-houses*.

[Unless otherwise mentioned, the figures in this article refer to the close of the year 1862.]

LONDON, chief city of the county of Middlesex, Canada West, is situated at the junction of the two branches of the river Thames; about 114 miles west-south-west from Toronto, with which it is connected by the Great Western Railway. The situation, whose fitness for a town was recognised by General Simcoe as early as 1784, only began to be cleared and laid out in 1825; but such has been the rapidity of the city's growth, that, in 1852, the population had risen to 7124; in 1857, to 16,000; and although it had fallen at the census of 1861 to 11,555, it is now again on the increase. When the city was called L., the river, which had formerly been known by an Indian name, received that which it now bears, a Westminster and a Blackfriars Bridge were thrown over it; and the names given to the principal streets and localities, still seem to indicate a desire to make the westernmost city of Canada a reproduction, as far as possible, of the capital of England. The Thames will probably be made navigable as far as L., to give it a communication by water with the lakes, and it has already an outlet by railway to every part of the American continent. The centre of a rich agricultural district, L. carries on a large trade in the produce of the country, while there are also 2 foundries, 2 tanneries, 2 breweries, 6 printing-offices, issuing as many newspapers; and several other branches of manufacture are conducted on a similar scale. In 1861, the value of the exports was £76,000; of the imports, £176,400; and the amount of duties collected, £29,188 sterling.

LONDON, CUSTOM OF, in English Law, is peculiar in several respects, and the laws there differ in those respects from the rest of the country. Thus, in the City (and by the City is meant only the City proper, or a small portion of the metropolis), a law of foreign attachment exists, which resembles the Scotch law of arrestment, by which a creditor may attach or seize the goods or debts of his debtor, in the hands of third parties, to abide the result of an action to be brought. The City of London also had a custom until recently which resembled the Scotch law of *Legitim* (q. v.) and *Jus Relictæ* (q. v.), by which a person at death could not by will disinherit his children, or leave his wife destitute. This custom was abolished by the stat. 19 and 20 Vict. c. 94. There is also a peculiar custom by which the common council elect their own sheriffs, instead of the crown electing them. There are also several other customs relating to local offences of minor importance.

LONDON CLAY, or LOWER EOCENE STRATA (q. v.), are a series of beds occupying the lower basin of the Thames from Hungerford to Harwich and Herne Bay; and also an extensive triangular region in Hampshire and the neighbouring counties, whose base extends along the coast from Dorchester nearly to Brighton, while its apex reaches to Salisbury. The beds are arranged in three sections: London Clay Proper and Bognor Beds, maximum thickness, 480 feet; Plastic and Mottled Clays and Sands, maximum thickness, 160

feet; Thanet Sands, maximum thickness, 90 feet: total, 730 feet.

The London Clay Proper consists of tenacious dark-gray and brown clay, with layers of septaria, which occur in sufficient quantity in the beds near Harwich and along the coast of Harwich to be used for the manufacture of Roman cement. In Hampshire, the clays are bluish, and have running through them bands of sand, sometimes compacted into hard stone, called Bognor Rock. In both basins, the clay rests on a thin bed of variously coloured sand and flint pebbles. The London Clay is rich in fossils. Many palm and other fruits have been described by Bowerbank from the island of Sheppey: masses of wood, often bored by the teredo, are not unfrequent. The mollusca belong to genera which now inhabit warmer seas than those of Britain, such as cones, volutes, nautilus, &c. About fifty species of fish have been described by Agassiz from Sheppey, among which are a sword-fish and a saw-fish. The remains of several birds and pachydermatous animals tell of the neighbourhood of land; and the numerous turtles, with the crocodiles and gavials, whose remains are associated with them, no doubt infested the banks of the great river which floated down the Sheppey fruits.

The Plastic Clays, or Woolwich and Reading series of Prestrich, are very variable in character, consisting chiefly of clays and argillaceous sands, which are used, as their name implies, in the manufacture of pottery. They contain a mixture of marine and fresh-water shells, shewing that they have been deposited in estuaries. They attain their maximum thickness of 90 feet in the Isle of Thanet, and thin out westward, till at Windsor they are only four feet thick—beyond this, they entirely disappear.

LONDON CONFERENCES. The first diplomatic meeting so designated was held in 1826 and the following years, for the regulation of the affairs of Greece; the next one was held in 1830, to arrange terms of agreement or of separation between Belgium and Holland. The terms of agreement proposed not being accepted by the disputants, Holland made an appeal to arms; but the capture of Antwerp by the French, and the blockade of their coast by the English and French fleets, brought the Dutch to agree to a treaty of definitive separation, 21st May 1833. A third conference was held in 1840, on the Turko-Egyptian question, in which France refused to take part. In 1851, a protocol was signed in London by the representatives of all the Great Powers, declaring the indivisibility of the Danish monarchy (inclusive of Slesvig and Holstein).

LONDON UNIVERSITY. When University College, London, was first established (in 1825), it was known as L. U., although a mere joint-stock undertaking. A change took place in 1836, when it received a charter as *University College*. At the same time, by another charter, L. U. was established—not a building for teaching, nor a body of teachers and scholars, but a body of persons empowered to examine candidates and confer degrees. As this second charter was only valid during 'royal will and pleasure,' it required to be renewed at the death of William IV., and the accession of Victoria; and a new charter was accordingly granted, December 5, 1837. Additional powers were given, July 7, 1850; and a wholly new charter was signed April 9, 1858, instituting many changes in the functions and arrangements of London University. *University College, London*, is still carried on in Gower Street, the original spot; but the *University of London*, or L. U., occupies apartments

granted by the government in Burlington House. The body consists virtually of a Chancellor, Vice-chancellor, 36 Fellows, and an indefinite number of Graduates. The *Chancellor* is appointed for life, or during royal pleasure, by the crown. The *Vice-chancellor* was named by the crown in the new charter of 1858, but is since annually elected by the Fellows from among their own body. The 36 *Fellows* were named by the crown in that charter, for life; but as vacancies occur, the crown and the university fill them up in a mode that gives some control to each. The *Graduates* are those who, at any time since 1836, have had degrees (*Bachelor, Master, or Doctor* of certain faculties) conferred upon them by this university. The *Senate* is composed of the Chancellor, Vice-chancellor, and Fellows, and has the power of making the whole of the by-laws for the government of the university—within certain limits prescribed by the charter, and with the approval of the Secretary of State. The *Convocation* is composed of all the graduates, except those who have taken the lower degrees only a few months; it meets occasionally, to vote and decide upon several minor matters, such as do not touch upon the higher functions intrusted to the senate. It gives the graduates a certain *esprit de corps*; but the charter seems to confine all real power to the senate.

When the new charter was given, in 1858, there were 47 colleges and collegiate schools in connection with L. U.—two in the colonies, and the rest in the United Kingdom. The number has since been considerably increased. The Secretary of State and the senate have the power of deciding what additional establishments shall be included. All these are regarded as *schools*, at which youths have gone through a good course of education; and certificated scholars from these schools may go up to L. U. to be examined, as a preliminary to the attainment of degrees. *Examiners* for this purpose are appointed by the senate, which also defines the extent and mode of examination. By the charter of the university, theology is entirely excluded. The degrees obtainable are those of *Bachelor and Master of Arts, Bachelor and Doctor of Medicine, Bachelor and Doctor of Laws*, and (since 1859) *Bachelor and Doctor of Science*. In each faculty, the degree of Doctor (or Master) is the result of a second and higher examination of those who are already Bachelors. Students also, under defined conditions, can try for *certificates of competency*, independent of degrees, which certificates are an important aid during the competitive examinations now adopted in reference to the public service.

From a 'Return of the General Fee Fund' of the L. U. presented to parliament in 1863, it appears that in the year April 1862—March 1863, the university received about £8500, of which £5000 was the annual grant from parliament, and £3500 fees. Of this income, about £5500 was paid in salaries, and £2000 in exhibitions, scholarships, medals, and prizes.

LONDONDERRY, ROBERT STEWART, second MARQUIS OF, born at Mount Stewart, Down County, Ireland, June 18, 1769, eldest son of Robert, first marquis, who represented the county of Down many years in the Irish parliament. Educated at the Grammar-school, Armagh, and at St John's College, Cambridge, he entered the Irish parliament in 1789, although then under age. In 1796 he became Viscount Castlereagh; and in 1798 he was made Chief Secretary for Ireland. It was the year of the insurrection and the French invasion, and some allowance must be made for the terrible

LONDONDERRY.

severities employed by the Irish government. Yet the cruel part he acted or tolerated in Ireland, in the suppression of the rebellion, and effecting the union, always weighed upon his reputation. In 1802, he was appointed President of the Board of Control, in the Addington administration. In 1805, he was promoted to the seals of the War and Colonial department, but resigned, with the whole of the cabinet, on Pitt's death in 1806. In the following year, he resumed the office of War Minister, when he organised the disastrous Walcheren expedition. Mr Canning, then Foreign Secretary, attacked Lord Castlereagh on this account with much acrimony and personality. The result was that both resigned, and a hostile meeting took place between them (21st September 1809), in which Canning was wounded. In 1812, after the assassination of Mr Perceval, Lord Castlereagh became Foreign Secretary, a post which he held during the period illustrated by the military achievements of the Duke of Wellington. By this time the general direction of British policy was unalterably fixed by circumstances, and Lord Castlereagh has at least the merit of having pursued this fixed course with a steadiness, and even obstinacy, which nothing could abate. He was the soul of the coalition against Bonaparte, and it was only by his untiring exertions, and through his personal influence, that it was kept together. He represented England at the Congress of Vienna in 1814, at the treaty of Paris in 1815, and at the Congress of Aix-la-Chapelle in 1818. While his foreign policy was favourable to the principles and policy of the 'Holy Alliance' abroad, he constantly recommended arbitrary and despotic measures at home. As the leader of the Liverpool government in the Lower House, he carried the suspension of the Habeas Corpus Act in 1817, and the 'Six Acts,' or 'the Gagging Bills,' as they were called, of 1819—measures which will for ever stamp his name with infamy. The retirement of Canning from the ministry, rather than be a party to the prosecution of Queen Caroline (1820), threw the whole weight of business on Lord Castlereagh. By the death of his father in 1821, he became Marquis of Londonderry; but his mind became deranged, and he died, by his own hand, at his seat at Foot's Cray, Kent, August 12, 1822. The populace witnessed the funeral procession in silence; but when the coffin entered the walls of Westminster, a loud and exulting shout rent the air, which penetrated into the abbey, and broke upon the stillness of the funeral ceremony. This statesman, looked upon by one party as a paragon of perfection, has been characterised by the other party as 'the most intolerable mischief that ever was cast by an angry Providence on a helpless people.'

LONDONDERRY, a maritime county of the province of Ulster, in Ireland, 40 miles in length by 24 in breadth, bounded N. by the Atlantic, E. by the county Antrim, and in part by Lough Neagh, S. by Tyrone, and W. by Donegal. Its area is 810 square miles, or 522,350 acres, of which 318,282 are arable. The population in 1861 was 184,137, of whom 83,428 were Catholics, 30,871 Protestants of the Established Church, 66,014 Presbyterians, and the rest Protestants of other denominations. The surface of L. is irregular. From the eastern boundary, it rises gradually towards the west, for a distance of about 10 miles, where commences an elevated district, rising in several points to a considerable height; Sawell, on the southern border, being 2236 feet high. On the western side, the surface falls gradually towards Lough Foyle. The coast-line along the Atlantic is generally bold and precipitous. The shore of Lough Foyle is in most places an unvarying

plain. The county may be divided longitudinally into two great geological districts, separated from each other by the river Roe. In the western, which is mountainous, the mica-slate prevails, accompanied in some places by primitive limestone. In the eastern, the mica-slate is overlaid by a succession of varying beds, capped, as in the adjacent Antrim district beyond the Bann, by a vast area of basalt, the dip of which, however, is the reverse of that on the opposite side of the river, and increasing in thickness towards the north, where in one place it reaches a depth of 900 feet. Many of the strata contain iron, and the ironstone of the mountain called Slieve Gallion was formerly worked, but the mining operations have been abandoned, from the failure of fuel. The soil is of a very mixed character, the greater part, with the exception of the alluvial spots on the banks of the several rivers, and of a considerable open district which stretches southward to Tyrone, being ill suited for wheat, or indeed for any cereal crop. In the year 1862, 197,239 acres were under crops of all kinds. The number of cattle was 93,902; of sheep, 26,285; of pigs, 23,214. The total value of live-stock, in 1851, was £817,108. The system of agriculture has been materially improved under the impulse given by the London society upon the large estates which it holds in the county. The principal rivers are the Foyle, the Faughan, the Roe, and the Bann. The first is navigable as far as L. for ships of 800 tons burden. The Bann, besides being a great source of motive-power for the staple manufacture of Ulster, that of linen, is also celebrated for its salmon-fisheries, which are of great value. The chief towns are Londonderry City (q. v.), Coleraine, Newtown-Limavady, and Magherafelt. L. was in ancient times the seat of the great sept of O'Loughlin and O'Neill, and of their tributary sept of O'Cahan, or O'Kane. At the immediate period of the invasion, the English, under John de Courcy, attempted a settlement, but were forced by the O'Neills to withdraw. A small garrison within their colony was established near the Antrim border, at Coleraine, upon the river Bann; but from the 14th till the 16th c., their tenure was little more than nominal; and although a number of forts, with a considerable garrison, were erected upon the river Foyle in 1600, it was not till the flight of the celebrated Tyrone and O'Donnell that the English occupation of the district was consummated, their forfeited lands being granted by the crown to the corporation of London, who still retain them, the management being vested in a body, 26 in number, who are elected by the common council, one half retiring each year. The incorporation, by charter, of this body, in 1619, led to the formation of the county, called, from this circumstance, Londonderry. Portions of the county were assigned to the several city companies, the unassigned portions being held by the society. The memory of the confiscation long rankled, and perhaps still lingers, in the minds of the dispossessed Irish and their descendants; but in material prosperity the district underwent a rapid and marked improvement. The agriculture is in a condition considerably in advance of the majority of Irish counties, and the domestic manufacture of linen, in former times, added materially to the comfort of the population. Of late years, however, this manufacture, in all its branches, has been transferred for the most part to large establishments. There is considerable export and import trade at the ports of Derry and Portrush, which is the seaport of Coleraine. The former has become a port of call for the Canadian steamers, which touch on their outward and homeward passage at the entrance of Lough Foyle. The number of national schools is

L., in the year 1861, was 388, attended by 20,696 pupils, of whom 11,439 were males, 9257 females. L. returns two members to the imperial parliament.

LONDONDERRY, CITY OF, a seaport, and a corporate and parliamentary borough, capital of the above county, situated on the river Foyle, and distant from Dublin 144 miles, north-north-west. Pop., in 1861, 20,493; of whom 11,954 were Roman Catholics, 4498 Presbyterians, 1538 Protestants of the Established Church, and the rest Protestants of other denominations. It returns one member to parliament. L. arose under the shadow of a monastery founded here in the 6th c. by St Columba. It was pillaged more than once by the Danes, and was occupied, but with many vicissitudes, by the English at the invasion. The town formed part of the escheated territory granted to the London companies, and under their management the city arose to some importance, and was strongly fortified. In the Irish war of the Revolution, L. threw itself earnestly into the cause of William of Orange, and closed its gates against James II. The siege of L. is one of the most celebrated events in modern Irish history, and its memories are among the most stirring of the occasions of party animosity. Since that date, the city has steadily grown in extent and prosperity. It is beautifully situated on the left bank of the Foyle, upon a hill which overlooks the river. The walls are still preserved, and form an agreeable promenade. The left bank of the river is connected by a wooden bridge (in part a draw-bridge) more than 1000 feet in length, with an extensive suburb called Waterside. The cathedral dates from 1633. A handsome Roman Catholic cathedral has been recently erected. The court-house also is a building of some pretensions, and the historical events above alluded to are commemorated by a triumphal arch erected in 1789, and a column erected in honour of the Rev. George Walker, who was governor of the city during the memorable defence, of which he was himself the great organiser and inspirer. There are several important educational foundations, one of which, Gwyn's School, has an income of £1870. Most of the foundations are due to the London companies. The arrangements and appliances of the port are on a good scale. Vessels of 500 tons can discharge at the quays, and there is a patent slip capable of receiving vessels of 800 tons. Steamers ply to Liverpool, Glasgow, and Belfast; and there is railway communication with Dublin and Belfast, as well as a considerable advance towards direct communication with the western coast. The custom-duties of the port amounted, in 1852, to £116,799. The chief manufactures are flax-spinning, distilling, brewing, rope-making, and tanning. There is also an extensive salmon-fishery.

LONG, GEORGE, M.A., a distinguished classical scholar, was born at Poulton, in Lancashire, in 1800, educated at Trinity College, Cambridge, where he obtained the Craven scholarship in 1821. L. became Chancellor's Medallist in 1822, and subsequently fellow of his college. In 1824, he accepted the Professorship of Ancient Languages in the university of Virginia, United States; but returned to England in 1826, to become Professor of the Greek Language and Literature in the London University. This office he resigned in 1831, when he commenced to edit the *Journal of Education*, published by the Society for the Diffusion of Useful Knowledge; but probably the greatest labour—the *magnum opus*—of his life was his editing for eleven years (from 1832 to 1843) the *Penny Cyclopædia*, to which he was also one of the most valuable contributors. At the conclusion of the 27th volume,

honourable mention is made by the Society, and by the publisher, Mr Charles Knight, of L., 'by whose learning, unwearied diligence, and watchfulness, unity of plan has been maintained during eleven years, and error, as far as possible, avoided.' In the midst of these arduous duties, L. joined the Inner Temple, and was called to the bar in 1837. In 1846, he was chosen by the Benchers of the Middle Temple to deliver a three years' course of lectures on jurisprudence and civil law. In 1849, he became Professor of Classical Literature in the Proprietary College at Brighton. L. is one of the best classical editors that England has produced; he is also one of the first authorities on Roman law. His merits as a translator are no less great, as evinced in his *Selections from Plutarch's Lives*, published under the title of *Civil Wars of Rome*. L. has contributed extensively to Smith's Classical Dictionaries; and besides editions of Cicero's *Orations*, and Caesar's *Gaulic War*, he has published an *Analysis of Herodotus, France and its Revolutions*, and other works.

LONG, LOCH, a well-known loch in the west of Scotland, extends northward from the Firth of Clyde for about 24 miles, between the counties of Argyle and Dumbarton. It has an average breadth of about a mile; and its banks, consisting, for the most part, of steep acclivities, abound in striking and picturesque scenery.

LONG-BOAT, a strong and seaworthy boat, formerly the largest carried by a ship, but now generally superseded by the Launch (q. v.).

LONG ISLAND, an island which forms three counties of the state of New York, United States of America, between lat. 40° 33'—41° 6' N., and long. 72°—74° 2' W., bounded N. by Long Island Sound, E. and S. by the Atlantic Ocean, and W. by the bay and harbour of New York. It is 140 miles long, and 12 miles in average width, with an area of 1682 square miles. On its south shore is a bay 100 miles long, and from 2 to 5 miles wide, separated from the ocean by a narrow beach of sand, with several inlets. On this shore are several light-houses, and 30 life-boat stations. A line of hills runs along the northern portion of the island, but the centre is a plain, sloping to the sea. Villages, watering-places, and fertile farms line the coasts, but the interior is mostly waste land and forest. The principal towns are Brooklyn (opposite New York), Flushing, Jamaica. The shores are lined with watering-places for summer resort. This island was once inhabited by 13 Indian tribes. August 22, 1776, Sir Henry Clinton landed on L. I. with 9000 British troops, defeated General Putnam, and compelled Washington to evacuate the island. Pop. about 400,000.

LONG ISLAND SOUND, a body of water between Long Island and New York and Connecticut, United States of America, 110 miles long, and from 2 to 20 miles wide, commencing narrow at New York City, which it separates from Brooklyn, and where it is called East River, and opening at its eastern extremity into the Atlantic Ocean, by a passage called 'the Race.' It is navigated by an immense number of coasting-vessels and steamers, and is strongly fortified at Throgs Point, near New York. It receives the Connecticut, Naugatuck, Thames, and Mystic rivers on its northern shore.

LONG VACATION, a period of the year in England when suits cannot be carried on, but are for some purposes suspended—viz., from 10th August to 24th October at common law, and to 28th October in Chancery in every year. Hence it is called the lawyer's holiday.

LONGAN (*Nephelium Longan*), one of the finest of fruits, of the same genus with the Litchi (q. v.), but reckoned superior to it. The tree which produces it is a native of China, and of other eastern countries, at least as far west as the mountainous regions on the eastern frontier of Bengal. It is much cultivated in China. The leaves are pinnate, with few leaflets, the leaflets oblong, the flowers in lax panicles. The fruit is globose, or nearly so. It is imported into Britain in a dried state. It has been produced in Britain by the aid of artificial heat.

LONGFELLOW, HENRY WADSWORTH, an American poet, was born at Portland, Maine, on February 27, 1807. At the age of 14, he entered Bowdoin College, Brunswick, and graduated there with high honours in 1825. For a short time he studied law in his father's office; but a professorship of modern languages having been founded in the Bowdoin College, and offered him, he accepted it, and proceeded to Europe to qualify himself for the discharge of his new duties. He returned to America in 1829, and entered upon his professorial work. His first substantive work, *Outre Mer*, appeared in 1835; and in the same year he was appointed to the chair of Modern Languages and Literature at Harvard University. He again spent a year in Europe, and made himself acquainted with the Danish and other northern literatures—an acquaintance which he has turned to noble account. In 1839, he published *Hyperion*, a prose romance, and *The Voices of the Night; Ballads and other Poems*, in 1841; *Poems on Slavery*, in 1842; *The Spanish Student*, in 1843; his *Poets and Poetry of Europe*, in 1845; *Belfry of Bruges*, and other poems, 1846; *Evangeline*, in 1847; *Kavanagh*, in 1849; *The Seaside and the Fireside*, in 1850; *The Golden Legend*, in 1851; *Hiawatha*, in 1855; and *Miles Standish*, in 1858.

Of the American poets, L. is the most popular in England, and, at the same time, he is the most national. If his countrymen have not a national epic, *Evangeline* or *Hiawatha* is as yet the nearest approach to it. Some of his shorter lyrics are almost perfect in idea and expression, and are to be found in every book of poetical extracts. His poetry is somewhat deficient in force, but it is full of picturesqueness; and a certain quaintness of fancy is one of its most delightful attributes.

LONGFORD, an inland county of the province of Leinster, Ireland, lying between Leitrim and Cavan on the N., Westmeath on the E. and S., and Roscommon on the W.; 29 miles long from north to south, and 22 miles from east to west. Its area is 269,409 acres, of which 191,823 are arable; population in 1861, 71,592, of whom 64,810 are Roman Catholics, 6114 Protestants of the Established Church, the rest Protestants of other denominations. The surface is for the most part moist and flat, with the exception of a slightly elevated central range, the greatest elevation of which is only 912 feet. Many small lakes pervade the county, and the river Shannon, or its nursing lakes, connect L. with the county and city of Limerick. Its navigation is also connected with Dublin by the Royal Canal; and the Midland Western Railway has a branch from Mullingar traversing the county. The south of the county forms part of the central limestone district of Ireland. The north is a continuation of the clay-slate which prevails in Cavan, the two districts being separated by a belt of yellow sandstone and conglomerate, which projects from the east of Leitrim. Deep beds of marl are found in many of the boggy districts. Marble of good quality

is also found, and ironstone, with coal, shale, and lead, of good quality, but not in remunerative quantity. The limestone district of the south is suited to tillage, and produces excellent wheat. The north is chiefly devoted to pasture. The number of acres under crop in 1862 was 82,260. In the same year, there were 43,926 cattle, 28,638 sheep, and 13,775 pigs. The chief towns are **LONGFORD** (q. v.), Granard, and Ballymahon. L. returns two members to parliament. The number of national schools, in 1861, was 88, attended by 10,392 pupils, of whom 5575 were males, 4817 females. L. anciently formed part of the kingdom of Meath, and as such was included in Henry II.'s grant to Hugh de Lacy. It was erected into a county in 1564, but in the rebellion of 1641 it was recovered for a brief period by the O'Farrells, and, on the suppression of this rising, almost the entire county was distributed, as confiscated lands, to a new race of colonists. The antiquities, although not striking, are of much interest. The islands of Lough Ree are especially rich in monastic remains.

LONGFORD, capital of the above county, 75 miles west-north-west from Dublin by the Midland Western Railway, on a small river called the Camlin. Pop. (1861) 4535, of whom 3908 were Roman Catholics, 508 Protestants of the established church, and the rest Protestants of other denominations. It is a well-built town. The Roman Catholic cathedral, recently erected, is a very spacious, and indeed a magnificent building, of the Ionic order. The chief commerce of L. is in the agricultural produce of the district. No manufacture of any importance exists in the town. It is connected with Dublin and with Sligo by the Midland Western Railway, as also with the former by the Royal Canal.

LONGICORNES, a family of tetramerous coleoptera, containing a vast number of species, among which are many of the largest and most splendid beetles. They are remarkable for the length of their slender antennæ, which are often longer than the body. They all feed on vegetable food, some on leaves, some on roots, and are mostly inhabitants of forests; the females depositing their

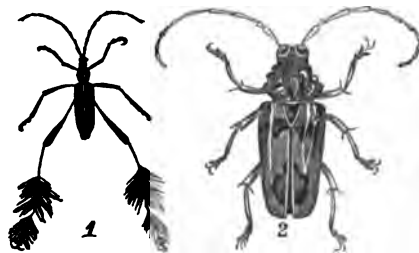

Longicornes :

1, *Cerambyx hirtipes*; 2, *Traehyderes rigrofaciatus*.

eggs, by means of a long, strong, horny ovipositor, beneath the bark of trees, on the wood of which the larvae feed. The L. abound chiefly in warm countries, and particularly in South America; the number of British species, however, is considerable, but some of those so reckoned have probably been imported from foreign countries in the larva state, in timber, to which they often do great injury.

LONGINUS, DIONYSIUS CASSIUS, a Platonic philosopher and famous rhetorician, was born, according to some, at Emesa, in Syria, and according to others, at Athens, about 213 A. D. In his earlier years, he travelled a great deal in the

company of his parents, and made the acquaintance of many celebrated scholars and philosophers. He studied Greek literature at Alexandria, where he was for a considerable time the pupil of Ammonius and Origen, and subsequently settled as a teacher of rhetoric in Athens, where he soon acquired a great reputation. His knowledge was immense: he was called 'a living library' and a 'walking museum,' but his taste and critical acuteness were no less wonderful. He was probably the best critic of all antiquity. In an age when Platonism was giving place to the semi-oriental mysticism and dreams of Neo-Platonism, L. stands out conspicuous as a genuine disciple of the great master. Clear, calm, rational, yet lofty, he despised the fantastic speculations of Plotinus, who consequently would not admit that L. was a philosopher, but—since he stooped to criticise the diction and style of Plato—pronounced him a mere philologist. In the latter years of his life, he accepted the invitation of Zenobia to undertake the education of her children at Palmyra; but becoming also her prime political adviser, he was beheld as a traitor, by command of the Emperor Aurelian, 273 A.D. L. was a heathen, but a generous and tolerant heathen. Of his works, the only one extant (and even that one only in part) is a treatise, *Peri Hypsous* (On the Sublime). There are many editions of L.'s treatise, of which those by Morus (Leip. 1769), Toupius (Oxf. 1778, 2d ed. 1789, 3d ed. 1806), Weiske (Leip. 1809), and Egger (Paris, 1837), are among the best. See also Rhunken's *Dissertatio de Vita et Scriptis Longini*.

LONGIPE'NNES, in Cuvier's ornithological system, that section of the order *Palmipedes* characterised by long wings and great power of flight. The wings are often very narrow. They are all sea-birds, and many of them venture to a great distance from shore. Their hind-toe is small and free, or wanting. They cannot dive and pursue their prey under water, but they swim well, and their movements in the air are very graceful. Petrels, shearwaters, gulls, terns, noddies, skimmers, and albatrosses, are examples.

LONGIROSTRES, a tribe of birds of the order *Gralla*, having generally a long, slender, feeble bill, and inhabiting sea-shores and marshy places, where they seek worms and other food in the mud or ooze. To this tribe belong snipes, woodcocks, curlews, godwits, sandpipers, &c.

LONGITUDE. See **LATITUDE**.

LONGIGO, a town of the Italian states, in the province of Vicenza, situated in a valley 12 miles south-west of the city of that name. It is protected by three strong towers, the antiquity of which is attested by the inscription they bear. The inhabitants, 6786 in number, are chiefly devoted to agricultural and commercial industry.

LONS-LE-SAULNIER, a town of Eastern France, in the department of the Jura, at the confluence of the Seille, Vallière, and Solman, about 55 miles south-east of Dijon. It is situated in a beautiful valley, surrounded by vine-clad hills, and was founded as long ago as the 4th c., when its salt-springs were discovered, from which 20,000 quintals of salt are yearly extracted. Pop. 9456. Rouget de Lisle, the composer of the *Marseillaise*, was born here.

LOO-CHOO, more accurately, **LU-TCHU**, the Chinese name of a group of islands, 92 in number, called by the natives *Lieu-Khiu*, situated in the Pacific Ocean, between Formosa and Japan, and about 400 miles off the coast of China, lat. 24°—29° N., long. 127°—129° E. The largest and most

southern, called Great Lu-tchu, or Okinawu, is about 65 miles long and 13 broad. Its shores have a beautiful appearance; fields and forests are clothed with a living green, pine-woods crown the summits of the hills, and gardens and cornfields adorn their slopes. In loveliness and variety of landscape, as in the careful attention paid to agriculture, especially in the southern part of Great Lu-tchu, which looks like one vast enchanting garden, few places anywhere could surpass these islands. The principal products of the group are rice, millet, sugar, cotton, tobacco, indigo, and tea; of less importance, bananas, pine-apples, oranges, peaches, and plums. Domestic animals are very numerous—ducks, geese, swine, goats, cattle, and horses. The chief minerals are iron, coal, and sulphur, probably also copper and tin. Sugar, and a liquor called *saki*, distilled from rice, are exported to Japan. The manufacturing industry of the inhabitants is as great as the agricultural. They make paper, cloths, coarse linens, earthen and lackered wares, bricks, tobacco-pipes, and baskets.

The people appear to be a mixture of Japanese and Chinese, the former greatly predominating, although the literature and customs of the islanders are Chinese. The population is dense; but its number has not been ascertained. Their religion is a mixture of the doctrines and practices of Confucius with those of Buddha. The government, as in China, appears to be in the hands of an aristocracy of learned men; and the king is said to be related to the imperial family of Japan. The natives pay tribute to both China and Japan. Since 1851, a Christian mission has existed here, founded by Dr Bettelheim, a German physician, who has introduced vaccination.

LOODIA'NA, a district of British India, is separated by the Sutlej from the Julinder Doab, the most easterly section of the Punjab. It lies in the 77th degree of E. long., extending in N. lat. from 30° 34' to 31° 2'; and, with an area of less than 750 square miles, it is said to contain 121,000 adult males—surely an exaggeration of the truth.

LOODIA'NA, the capital of a district of the same name in British India, takes its name from the Lodi tribe of Afghans, and is situated 1102 miles north-west of Calcutta, in lat. 30° 55' N., and long. 75° 54' E. It stands on a navigable nullah or stream, which joins the Sutlej from the east, about 15 miles below the town. It contains about 20,000 inhabitants, mostly weavers. The principal manufactures are cotton-cloth and Cashmere shawls, the latter, however, being decidedly inferior in quality to those made in Cashmere itself. Situated on the high-road between Delhi and the Punjab, L. is a military station of some importance.

LOOF, the after-part of a ship's bow, or that portion where the planks incurvate towards the cut-water. The guns mounted in this portion of the vessel are styled 'loof-pieces.'

LOOKING-GLASS. See **MIRROR**.

LOOM, the machine by which weaving is effected. The art of weaving is coeval with civilisation, therefore the loom may be reckoned amongst the earliest of man's inventions; yet, notwithstanding its vast age, very little improvement was effected in it until the invention of Dr Cartwright in 1787, who, without ever having seen a loom in his life before, constructed one to work by machine-power. In its simplest form, the loom is worked by hand; and notwithstanding the wonderful improvements which have been effected in the power-loom since its invention, there are still many fabrics manufactured by hand-looms in this and other countries.

In India, which most probably is the native country of the loom, and where silks of almost

LOOM.

unrivalled beauty are made, the natives continue to use this machine in its most primitive form; two trees growing near together form their standing frame, and a few pieces of bamboo, together with some pieces of string, furnish all they want besides.

As the use of the loom will be fully explained in the article WEAVING, the construction only will be given here; but it is necessary, in order to make this clear, to explain the principle of weaving, in order to shew the work the loom has to do. In its simplest sense, weaving consists in passing one set of threads transversely through another set, divided into two series, working alternately up and down, so as to receive the transverse threads in passing, and interlock them, forming thereby a united surface out of the threads. The loom is made to assist the weaver in this operation after the manner shewn in fig. 1: A A A A is the frame of the loom, and is of no other use than to hold the working-parts in their proper position. The native of India supplies this usually by selecting, as before stated, two near-growing tree-stems, usually palms, in consequence of their straightness; these, with

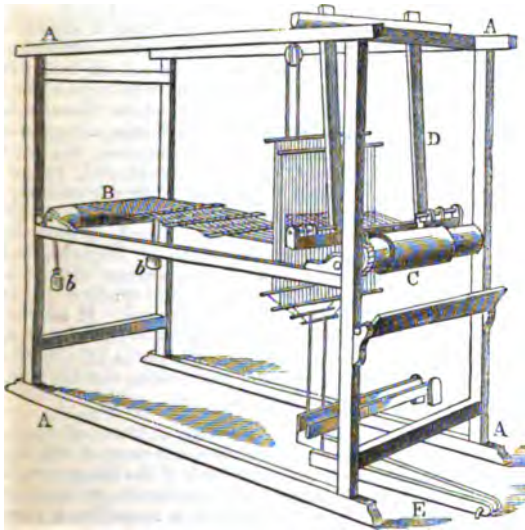

Fig. 1.

four stakes to support his warp, and two or three pegs to fix his heald-ropes, complete his arrangements.

At each end of the frame, two rollers are placed, B, C, so that they will readily turn on their axes; and from one to the other, the threads of the warp are attached, and kept tight by the weights *b, b*. The warp-threads are wound round the roller B, which

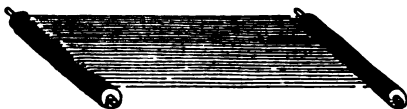

Fig. 2.

is called the *beam* or *yarn-roll*, only as much of each thread being left unwound as will reach to the other roller, C, which is the *cloth-beam*, to which the ends are fastened, and upon which the cloth is wound as it is woven. The warp so stretched is seen in fig. 2.

The next step is to divide the warp-thread into

two equal sets by raising up every alternate one, and inserting between them a smooth rod of wood,

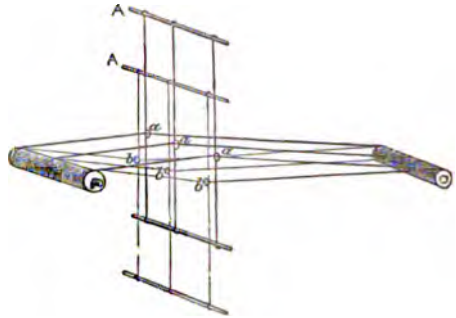

Fig. 3.

to prevent them entangling or returning to their former position. This separation takes place before the final fixing of the ends of the threads to the *cloth-beam*, because, previous to that, each thread must be passed through a small loop in a perpendicular thread called the *heald*, which hangs down from the rod A in fig. 3 (in which only six heald-threads and six warp-threads are shewn, for the sake of rendering the action clearer). There are always two sets of healds in the simplest form of loom, often many more; and in the case of plain weaving, the threads of the warp are divided alternately by the loops of each heald, so that if one heald is raised, it lifts every alternate thread of the warp, and if the other is depressed, it pulls down the opposite set of threads; thus, in fig. 3, the three threads of the warp are seen to pass through the three upraised threads of one heald by the loops *a, a, a*, and the three remaining threads of the warp pass through the depressed healds by their loops *b, b, b*; the united action of the two healds opens a space between the two sets of warp-threads similar to that shewn in fig. 4. This space is called the *shed*, and through it is thrown the shuttle which carries the thread of the weft; when the weft has passed through, the healds are reversed, and the lower warp-threads now become the upper ones. The threads, after each intersection, are driven up tight by the reed, which is a

narrow frame with transverse wires set sufficiently far apart for a single thread of warp to pass through each; it hangs to the frame called the *batten*, fig. 1, D. The movement of the batten is produced by



Fig. 4.

the hand of the weaver, whilst that of the healds is readily effected by the treadles E.

Many improvements have been made in this the simplest form of loom, but the chief has been in replacing the weaver's hand in the necessary operation of throwing the shuttle by a mechanical arrangement. Without this, the *power-loom* would not have succeeded. The shuttle (fig. 5) is usually made of box or some other hard wood; and the blunt points are covered with iron. Formerly, when used entirely by the hand, it was made much lighter and smaller than at present. Those now in use are

about a foot in length, and rather more than an inch square in the middle. The middle part is hollowed out into a small box, open on the upper

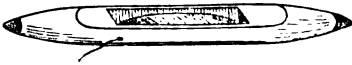

Fig. 5.

side. In this box the bobbin, on which the yarn or thread is wound, is placed, with its two ends on pivots, admitting of its being turned by the slightest strain on the yarn; the end of the yarn passes through a hole in the side of the shuttle, as seen in fig. 5; and as it is thrown backwards and forwards, the thread unwinds from the enclosed bobbin, and easily runs through the hole.

In the improved looms for power, and even in those still worked by hand, in special cases the

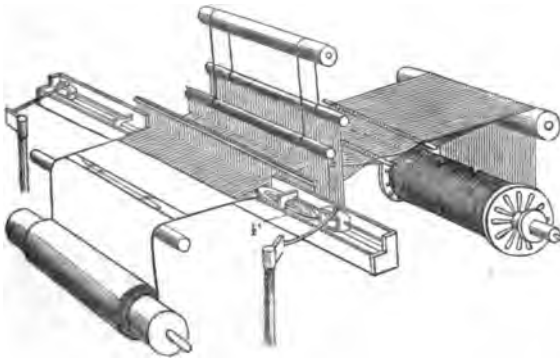

Fig. 6.

arrangement for projecting the shuttle backwards and forwards is very simple. On each side of the loom, exactly in a line with the *shed*, is a groove of about eighteen inches, in which the shuttle lies free; and there is a very simple arrangement by which a piece of leather and a strap are made to act like a sling on each side; and the grooves or *shuttle-races*, as they are called, guide the movement with such precision that the shuttle is sent flying through the shed from side to side with unerring exactness. This arrangement will be seen by reference to fig. 6, F, which is given to shew the great simplicity and compactness now attained in the power-loom, three of which can stand in the space occupied by one of the cumbersome machines formerly in use. There are few machines in use which have had more mechanical ingenuity displayed in their improvement than the loom; but as it is not the object of this article to do more than give the general principles upon which the machine works, the reader is referred for fuller information to the thick volume of the *Abstract of Patents for Weaving*, published by the Patent Commissioners.

LOON. See DIVER.

LOOPHOLES, in Fortification, are small apertures in the walls, through which sharpshooters may fire. The loophole should widen towards the outside, that the shooter may have a sweep with his rifle; and it is of importance, on that account, so to fashion the sides that

a bullet may not penetrate, unless fired straight into the centre. For this purpose, the stones are

generally laid stepwise, as in the figure, although other forms are frequently resorted to. The lines in the diagram are intended to shew how large a proportion of the hostile shots would prove fruitless against the sharpshooters within.

LOPE-DI-VEGA. See VEGA.

LOPHIADÆ. See ANGLER.

LOPHOBANCHII, an order of osseous fishes, having the ultimate divisions of the gills not pectinated, but arranged in small tufts in pairs along the branchial arches. There is nothing like this in any other fishes. The fishes of this order are few, mostly of small size, angular form, and peculiar aspect. See HIPPOCAMPUS and PTFE-FISH. The gill-cover is large, and the gill-opening is a small hole. The snout is elongated and tubular.

LOQUAT (*Eriobotrya Japonica*), an esteemed Chinese and Japanese fruit, of the natural order Rosaceæ, sub-order Roseæ, and of a genus closely allied to *Mespilus* (Medlar). It has been introduced into Australia, and is now abundant there, and is sold in large quantities, and at a cheap rate, in the markets of Sydney and other towns. The tree or shrub which produces it attains a height of 20 or 30 feet, but in cultivation is seldom allowed to exceed 12 feet. It is a beautiful evergreen, with large oblong wrinkled leaves, and white flowers in terminal woolly panicles, having a fragrance like that of hawthorn-blossom; the fruit is downy, oval, or pear-shaped, yellow, and about the size of a large gooseberry. The seeds have an agreeable flavour, which they impart to tarts. The L. lives in the open air in the south of England, and produces fruit; but a warmer climate is required for fruit of fine quality. It is not unfrequent in hothouses. It may be

grafted on any species of *Mespilus*.—The species of *Eriobotrya* are all evergreen. THE CUTLA (*E. elliptica*) is a native of Nepal, and produces an eatable fruit.

LORANTHA'CEÆ. See MISTLETOE.

LORCA (ancient *Eliocroca*), a town of Spain, province of Murcia, 40 miles south-west of the city of that name, on the right bank of the Sangonera, is picturesquely situated on an eminence crowned by a fortified castle commanding a magnificent view. Next to Murcia, L. is the most flourishing town in the province, possessing substantial houses, 8 churches, 9 monasteries, many oil and flour mills, saltpetre and powder works, lead-mines, and manufactures of cotton, &c. Pop. 31,000.

LORD (Saxon *hlaford*, from *hlaf*, loaf of bread, and *ford*, to give, *quasi*, one who feeds the people), a title given in Great Britain to persons either noble by birth or by creation. Peers of the realm are so styled, including such archbishops or bishops as are members of the House of Lords, who are Lords Spiritual. By courtesy, the title Lord is given to the eldest sons of dukes, marquises, and earls, prefixed to an inferior title of the peerage, and to the younger sons of dukes and marquises, prefixed to their Christian name and surname. The following official persons bear the title lord in virtue of their employments—the Lord-lieutenant of Ireland and Lord-lieutenant of counties (see LIEUTENANT, LORD), the Lord Chancellor (see CHANCELLOR), Lord Privy Seal (see PRIVY SEAL), Lords of the Treasury (see TREASURY) and of the Admiralty (see ADMIRAL), the Lord High Admiral, Lord Great Chamberlain, and Lord Chamberlain (see CHAMBERLAIN, LORD), Lord High Constable (see CONSTABLE), Lord High Almoner (see ALMONER), Lord High Steward (see STEWARD),

Lord Steward of the Household, Lords in Waiting, Lords of the Bedchamber (see BEDCHAMBER, LORDS OF THE), Lords Justices (see JUSTICES, LORDS), the Lord Chief Baron of Exchequer (q. v.), the Lord Chief-Justice (see JUSTICE, LORD CHIEF), the Lord Lyon (see LYON KING AT ARMS), the Lord Mayor of London, York, and Dublin (see MAYORS), and the Lords Provost of Edinburgh and Glasgow (see PROVOST). The committee of the Scottish parliament by whom the laws to be proposed were prepared, were called Lords of the Articles. The favoured beneficiaries, who, after the Scottish Reformation, obtained in temporal lordship the benefices formerly held by bishops and abbots, were called Lords of Erection. Persons to whom rights of regality were granted in Scotland (see REGALITY), were termed Lords of Regality. The representative of the sovereign in the General Assembly of the Church of Scotland (see ASSEMBLY, GENERAL), is called the Lord High Commissioner. The judges of the Courts of Session and Juciciary in Scotland have the title 'Lord' prefixed to their surname or some territorial designation assumed by them; and throughout the three kingdoms, judges are addressed 'My Lord' when presiding in court.

LORD ADVOCATE OF SCOTLAND. See ADVOCATE.

LORD OF THE MANOR, the owner of a manor having copyhold tenants. See MANOR.

LORD ORDINARY. See COURT OF SESSION.

LORDS, HOUSE OF. See PARLIAMENT.

LORD'S-DAY, in point of law, has been made the subject of several statutes. The chief statute in England is the *Lord's-day Act*, 29 Ch. II. c. 7, which enacted that no tradesman, artificer, workman, or labourer should exercise the worldly labour, business, or work of his ordinary calling upon the Lord's-day (works of necessity and charity only excepted), nor any person should publicly cry, or expose to sale, wares, fruit, herbs, &c.; but nothing in the act was to extend to prohibiting the dressing of meat in families or inns, cook-shops or victualling houses, nor the selling of milk within certain hours. To these exceptions, selling mackerel and baking bread were added subsequently. These statutes have been construed strictly by the courts on the ground that they restrain the liberty of the subject, for, without a statute, ordinary work would be as competent on the Sunday as on any other day. Hence, unless a case comes within the strict letter of the statute, there is no disability. Thus, a horse may be sold on Sunday by one who is not a horse-dealer, for then it is not part of the seller's ordinary calling. So a farmer may hire a servant on that day; indeed, the statute does not apply to farmers, attorneys, surgeons, and those not included in the above statutory description, and therefore those parties can do their work on Sunday as on other days. Irrespective of any statute, it has been the immemorial course of practice in courts of law not to do legal business on Sunday, and not to recognise the service of writs, warrants, &c., of a civil nature, if made on Sunday. Thus, no debtor can be arrested for debt on Sunday, and hence he may walk at large that day, free from molestation of bailiffs. But if any crime has been committed, the party can be arrested on Sunday as well as other days. There is a special provision by statute as to ale-houses, beer-houses, and refreshment-houses being open on Sundays, the general effect of which is only to close these places during church hours. If any game is pursued on Sunday, whether by poachers or not, a penalty is incurred. There is also a statute of 1 Ch. I. prohibiting sports or pastimes of certain descriptions. Except as above mentioned, there is no difference made as to the

validity of acts done on Sunday, though it is an erroneous popular impression that deeds or wills, bills of exchange, &c., dated or executed on Sunday are invalid.

In Scotland, the law varies in some respects from that of England on this matter. There also contracts made on Sunday are not null at common law, but numerous statutes have passed prohibiting contracts, whether made in the course of one's ordinary business or not, and whether made by workmen, artificers, &c., or not. But there is an exception of works of necessity and mercy. It is, however, doubtful how far these old statutes are in deatude or not, and judges have said they only apply to public not private acts done on Sunday. In Scotland, the rule is acted on, that the enforcement of decrees and warrants, poindings, and other process or diligence in civil matters, are void; but it is otherwise in criminal matters. It is singular that there is no distinct penalty imposed in Scotland, as there is in England and Ireland, by the Game Acts, on persons sporting on Sunday. But Scotland outstrips England and Ireland in the stringency with which public-houses are prohibited from being open on that day. See PUBLIC-HOUSES.

LORD'S SUPPER, THE, is one of the sacraments of the Christian religion (see SACRAMENT). It is so called from its being instituted at supper by Jesus Christ, whom his disciples styled the Lord or Master. It receives also the names of Eucharist and Communion (q. v.). With the exception of the Quakers, all sects of Christians, however different their views as to its nature, agree in celebrating it as one of the most sacred rites of religion. The present article is written from the point of view of those who admit more or less the idea of a historical development of the doctrines connected with the Lord's Supper; the views of Roman Catholics, who hold that the doctrines of their church on the subject were delivered by our Lord and his apostles, and have from the first centuries been taught in substance in the church, will be found under other heads. See MASS; TRANSUBSTANTIATION.

The circumstances of sorrow amid which it was instituted, and its intimate relation to the crowning work of Jesus, his death, had, at the very outset, made a deep impression upon the early church. Not only was the solemnity, in conformity with its original institution, repeated daily in conjunction with the so-called *Agape* (q. v.) (love-feasts), and retained as a separate rite when these feasts were set aside; but from the very first it was believed to possess a peculiar efficacy, and soon ideas of the wonderful and mystical became associated with it. The Lord's Supper was celebrated on every important occasion of life—when entering on marriage, when commemorating departed friends and martyrs, &c.; to those that could not be present at the meeting of the congregation, such as prisoners, sick persons, and children, the indispensable food of heaven was carried by the deacons, and in some churches—those of Africa, for instance—the communicants took part of the materials of the feast home with them, that they might welcome the gift of a new day with consecrated food. Heathens also and unworthy persons were excluded from this holy mystery. As early as the 2d c., Ignatius, Justin Martyr, and Irenæus advance the opinion, that the mere bread and wine became, in the Eucharist, something higher—the earthly, something heavenly—without, however, ceasing to be bread and wine. Though these views were opposed by some eminent individual Christian teachers, such as Origen (died 254), who took a figurative conception of the sacrament, and

depreciated its efficacy; yet both among the people and in the ritual of the church, more particularly after the 4th c., the miraculous or supernatural view of the Lord's Supper gained ground. After the 3d c., the office of presenting the bread and wine came to be confined to the ministers or priests. This practice arose from, and in turn strengthened the notion which was gaining ground, that in this act of presentation by the priest, a sacrifice, similar to that once offered up in the death of Christ, though bloodless, was ever anew presented to God. This still deepened the feeling of mysterious significance and importance with which the rite of the Lord's Supper was viewed, and led to that gradually increasing splendour of celebration which under Gregory the Great (590) took the form of the mass. See MASS. As in Christ two distinct natures, the divine and the human, were wonderfully combined, so in the Eucharist there was a corresponding union of the earthly and the heavenly.

For a long time there was no formal declaration of the mind of the church on the presence of Christ in the Eucharist. At length, in the first half of the 9th c., a discussion on the point was raised by the Abbot of Corvei, Paschasius Radbertus, and Ratramnus, a learned monk of the same convent; they exchanged several violent controversial writings *De Sanguine et Corpore Domini*, and the most distinguished men of the time took part in the discussion. Paschasius maintained that the bread and wine are, in the act of consecration, transformed by the omnipotence of God into that very body of Christ which was once born of Mary, nailed to the cross, and raised from the dead. According to this conception, nothing remains of the bread and wine but the outward form, the taste and the smell; while Ratramnus would only allow that there is some change in the bread and wine themselves, but granted that an actual transformation of their power and efficacy takes place. The greater accordance of the first view with the credulity of the age, its love of the wonderful and magical, as well as with the natural desire for the utmost possible nearness to Christ, in order to be unfailingly saved by him, the interest of the priesthood to add lustre to a rite which enhanced their own office, and the apparently logical character of the inference, that where the power, according to universal admission, was changed, there must be a change also of the substance; the result of all these concurring influences was, that when the views of Ratramnus were in substance revived by Berengarius, Canon of Tours, in opposition to Lanfranc, Bishop of Canterbury, and Cardinal Humbert, the doctrine of Transubstantiation, as it came to be called, triumphed, and was officially approved by the Council of Rome in 1079. In the fourth Lateran Council at Rome, 1215, under Innocent III., Transubstantiation was declared to be an article of faith; and it has continued to be so held by the Roman Catholic Church to the present day. The Greek Catholic Church sanctioned the same view of Transubstantiation at the Synod of Jerusalem in 1672.

The Reformation of the 16th c. again raised the question on the nature of the Eucharist. The Lutheran Church rejected from the first the Catholic doctrine of Transubstantiation, as well as of the mass, i. e., the constant renewal of the sacrifice of Christ, and merely taught that, through the power of God, and in a way not to be explained, the body and blood of Christ are present in, with, and under the unchanged bread and wine. In opposition to this doctrine, it was laid down by Zwingli, that the Lord's Supper is a mere commemoration of the death of Christ, and a profession of belonging to his church, the bread and wine being only symbols: a view which is

adopted in substance by the Socinians, Arminians, and German Catholics. Luther bitterly opposed the symbolical view, especially towards the latter part of his career; Zwingli's doctrine was more repugnant to him than the deeper and more mystic Catholic doctrine. See IMMANATION.

Calvin sought to strike a middle course, which has been substantially followed by the Reformed churches. According to him, the body of Christ is not actually present in the bread and wine, which he also holds to be mere symbols. But the 'faithful' receiver is, at the moment of partaking, brought into union with Christ, through the medium of the Holy Spirit, and receives of that heavenly power (efficacy) which is always emanating from his glorified body in heaven. Melancthon, in this controversy, was inclined to the views of Calvin; but he thought a union might be effected by adopting the declaration that Christ in the Eucharist is 'truly and really' present (not merely in faith). The endeavours of Melancthon and his party, by arbitrary alterations of the Augsburg Confession and other means, to effect a public reconciliation, only served to rouse among the partisans of Luther a furious theological storm, and the result was the establishment of the peculiar views of Luther, and the final separation of the Lutheran and Reformed churches.

The whole controversy relates to the *mode* in which the body and blood of Christ are present in the Lord's Supper; for it was agreed on all hands that they are present in some way. The Reformed theologians argued that *presence* is a relative term, opposed not to distance, but to absence; and that presence, in this case, does not mean local nearness, but presence in efficacy. Here they parted company both with the Roman Catholic Church and with the Lutherans. They were willing to call this presence 'real' ('if they want words,' as Zwingli said), meaning true and efficacious, but they would not admit corporal or essential presence. But while the Reformed churches were at one in holding, that by receiving the body and blood of Christ, is meant, receiving their virtue and efficacy, there is some difference in their way of expressing what that efficacy is. Some said it was their efficacy as broken and shed—i. e., their sacrificial efficacy; others, in addition to this, speak of a mysterious supernatural efficacy flowing from the glorified body of Christ.

With regard to the Reformed churches, it may be remarked that their Confessions on this point were mostly formed for the express purpose of compromise, to avoid a breach with the Lutherans. Hence the language of these Confessions contains more of the mystical element, than the framers of them seem, in other parts of their writings, to favour. And it is remarkable that the Anglican Confessions, which were framed under different circumstances, lean more to the symbolical view of Zwingli than those of any other of the Reformed churches. The Thirty-nine Articles, after laying down that 'to such as with faith receive the same, it is a partaking of the body of Christ,' repudiate the notion of Transubstantiation; and add: 'The body of Christ is given, taken, and eaten in the Supper only after an heavenly and spiritual manner. And the mean whereby the body of Christ is received and eaten in the Supper is faith.'

The Presbyterian Church of Scotland adopted substantially the views of Calvin. The words of the Westminster Confession are: 'That doctrine which maintains a change of the substance of bread and wine into the substance of Christ's body and blood (commonly called Transubstantiation) by consecration of a priest, or by any other way, is repugnant not to scripture alone, but even to

common sense and reason. . . . Worthy receivers, outwardly partaking of the visible elements in this sacrament, do then also inwardly by faith, really and indeed, yet not carnally and corporally, but spiritually, receive and feed upon Christ crucified, and all benefits of his death: the body and blood of Christ being then not corporally or carnally in, with, or under the bread and wine; yet as really, but spiritually, present to the faith of believers in that ordinance, as the elements themselves are to their outward senses.'

This variety of dogmatical opinion as to the Eucharist naturally gave rise to variety in the ceremonials of its observance. The Catholic notion of a mysterious transformation, produced the dread of allowing any of the bread and wine to drop, and led to the substitution of wafers (*hostie, oblata*) for the breaking of bread. The doctrine of the 'real union,' which declares that in the bread as well as in the wine, in each singly and by itself, Christ entire is present and tasted—a doctrine which was attested by wafers visibly bleeding—caused the cup to be gradually withdrawn from the laity and non-officiating priests; this practice was first authoritatively sanctioned at the Council of Constance, 1415. All the Reformed churches restored the cup: in the Greek Church it had never been given. From the same feeling of deep reverence for the Eucharist, the communion of children gradually came, after the 12th c., to be discontinued. The Greek Church alone admits the practice. Grounded on the doctrine of Transubstantiation, the Greek and Roman Catholic Churches hold the 'elevation of the host' (*hostia, victim or sacrifice*) to be a symbol of the exaltation of Christ from the state of humiliation; connected with this is the 'adoration of the host,' and the carrying it about in solemn procession. The use of leavened bread in the Greek Church, and of unleavened in the Roman Catholic and Lutheran, of water mixed with wine in the Roman Catholic and Greek Churches, and of unmixed wine in the Protestant Churches, are trifling differences, mostly owing their origin to accidental circumstances; yet, once magnified into importance by symbolical explanations, they have given occasion to the hottest controversies. The greater part of the Reformed churches agree in breaking the bread and letting the communicants take it with the hand (not with the mouth); and this practice is owing to the original tendency of those churches to the symbolical conception of the Eucharist, in which the breaking of the bread and the pouring out of the wine are essential elements.

Although the great divisions of the Christian world have continued as churches to adhere to those doctrines about the Lord's Supper which were fixed and stereotyped in Acts of Council and Articles and Confessions about the time of the Reformation, we are not to suppose that the opinions of individuals within those churches continue equally uniform and fixed. Even Roman Catholic theologians, like Bossuet, have sometimes endeavoured to understand the doctrine of the church in a philosophical sense; and in the Lutheran Church, the greatest variety of opinion prevails. Some uphold unmodified the dogmas of Luther; others accept them with explanation; Hegel even undertook to ground them on speculative reason. Others, as Schleiermacher, would have recourse to the views of Calvin as a means of reconciliation with the Reformed churches. Even all 'supernatural' theologians do not adhere strictly to the formulas of the church; while rationalism in all its phases tends to the pure symbolism of Zwingle.

The Anglican Church is divided on this, as on several kindred topics, into two parties: with one, the symbolical view of the rite is predominant; the

other party reprobate this view as 'low,' and maintain an *objective* 'mystical presence' of the thing signified, along with the sign. Notwithstanding the 'higher' doctrine of the Scotch Confession, the tendency in Scotland seems to be more the other way; from the pulpit, the rite is oftener spoken of in its commemorative character, and the signs as means of working upon the mind and feelings subjectively, than as the vehicle of any objective, mystically operating grace.

LORETTO (properly, LORETO), a city of the province of Macerata, in the kingdom of Italy, although of some architectural pretensions, and containing 8000 inhabitants, is chiefly noticeable as the site of the celebrated sanctuary of the Blessed Virgin Mary, called the *Santa Casa*, or Holy House. The *Santa Casa* is reputed to be the house, or a portion of the house, in which the Virgin lived in Nazareth, which was the scene of the Annunciation, of the Nativity, and of the residence of our Lord with his mother and Joseph; and which, after the Holy Land had been finally abandoned to the infidel on the failure of the Crusades, is believed to have been miraculously translated, first, in 1291, to Fiume in Dalmatia, and thence, December 10, 1294, to Recanati, whence it was finally transferred to its present site. Its name (Lat. *Domus Lauretana*) is derived from Laureta, the lady to whom the site belonged. It would be out of place in a work like this to enter into any polemical discussion of this legend. Although numberless pilgrims resort to the sanctuary, and although indulgences have been attached by Julius II., Sixtus V., and Innocent XII. to the pilgrimages, and to the prayers offered at the shrine; yet the truth of the legend is no part of Catholic belief, and Catholics hold themselves free to examine critically its truth, and to admit or to reject it according to the rules of historical evidence. The church of the *Santa Casa* stands near the centre of the town, in a piazza which possesses other architectural attractions, the chief of which are the governor's palace, built from the designs of Bramante, and a fine bronze statue of Pope Sixtus V. The great central door of the church is surmounted by a splendid bronze statue of the Madonna; and in the interior are three magnificent bronze doors filled with bas-reliefs, representing the principal events of scriptural and ecclesiastical history. The celebrated Holy House stands within. It is a small brick-house, with one door and one window, originally of rude material and construction, but now, from the devotion of successive generations, a marvel of art and of costliness. It is entirely cased with white marble, exquisitely sculptured, after Bramante's designs, by Sansovino, Bandinelli, Giovanni Bolognese, and other eminent artists. The subjects of the bas-reliefs are all taken from the history of the Virgin Mary in relation to the mystery of the Incarnation, as the Annunciation, the Visitation, the Nativity, with the exception of three on the eastern side, which are mainly devoted to the legend of the Holy House itself and of its translation. The rest of the interior of the church is rich with bas-reliefs, mosaics, frescoes, paintings, and carvings in bronze. Of this material, the finest work is the font, which is a master-piece of art. The Holy House having been at all times an object of devout veneration, its treasury of votive offerings is one of the richest in the western world. It suffered severely in the French occupation of 1796, but it has since received numerous and most costly accessions. The frescoes of the Treasury Chapel are among the finest to be found outside of Rome.

L'ORIENT, a seaport of France, department of

Morbihan, situated at the confluence of the Scorff and Blavet, in lat. 47° 48' N., and long. 3° 25' W. Pop. 28,412. It is a well-built town, but rather dull-looking. The harbour, dockyard, and arsenal are among the best and largest in France, and the place ranks as a fortress of the third class; but its commerce received a blow at the Revolution in 1789, from which it has never recovered. L. has a communal college, a school of navigation, and another of marine artillery. The inhabitants are engaged chiefly in ship-building and the allied occupations. The only important manufacture is that of hats.

L. owes its origin to the French East India Company, which built an establishment here in 1666, for the purpose of trading to the East (whence the name of the town).

LORIMER (Fr. *lormier*, from Lat. *lorum*, a thong), a maker of bits, spurs, stirrup-irons, metal mountings for saddles and bridles, and generally of all articles of horse-furniture. In London, the lorimers, who had previously formed part of another guild, were incorporated by letters-patent in 1712; in the Scottish burghs, they have been comprehended as a branch of the corporation of Hammermen. Cutlers, locksmiths, and brass-founders have been considered as in the exercise of branches of the lorimer art, and therefore bound to enter with the corporation. The Court of Session, in 1830, held it to be a violation of the exclusive privileges of the lorimer craft to manufacture bits, stirrup-irons, and other metallic articles of horse-furniture, with a view to silver-plating them before selling.

LORIS, a genus of *Lemuridae*, differing from the true lemurs in having a round head and short muzzle, very large eyes, and no tail. The two species known are both natives of the East Indies. The largest species, *L. tardigradus*, is not so large as a cat; the other, *L. gracilis*, is much smaller.



Loris (*L. gracilis*).

They are nocturnal animals, and spend the day generally sleeping attached to a branch, which they grasp firmly with all their four hands, the body rolled up into a ball, and the head hidden among the legs. Their fur is rich and soft. Their motions are slow, and they advance stealthily and noiselessly on the insects and birds on which they prey. They feed, however, partly on fruits and other vegetable food; in confinement, they readily eat rice and milk, and are very fond of eggs.

LORRAINE, originally a portion of the German empire. Its history dates from 855, when Lotharius II. obtained (see CARLOVINGIANS) the lands between

the Scheldt, Rhine, Meuse, and Saône, called the Kingdom of Lotharius (*Lotharii Regnum*), or Lotharingia, or Lorraine. The district now known as Rhenish Prussia was separated from L. in the 10th c., and the remainder was divided in 1044 into two duchies, *Upper* and *Lower* Lorraine. The latter, after many vicissitudes, came into the possession of Austria, and now forms one half of the kingdom of Belgium, and the provinces of Brabant and Gelderland, in Holland. Upper L. continued to be governed by its own dukes till 1736, when it was given to Stanislas, ex-king of Poland, and on his death in 1766 was united to France, forming the province of Lorraine. It is now subdivided into the departments of the Meuse, Moselle, Meurthe, Vosges, and some of the cantons of the Lower Rhine. The inhabitants are of German origin, but speak the French language, with the exception of the district lying between Metz and the Vosges, which is called *German Lorraine*.

LORRAINE, CLAUDE. See CLAUDE LORRAINE.

LORY (*Lorius*), a genus of birds of the parrot family (*Psittacidae*), natives chiefly of the south-east of Asia and the Eastern Archipelago. They have a dense soft plumage, exhibiting the most rich and mellow colours; the tail is rounded or graduated, generally not long; the bill is feeble than in many of the parrots, and the upper mandible much arched. They are very active and lively, even in confinement, and are also of very gentle and affectionate disposition. Red, scarlet, crimson, and yellow are the prevailing colours of their plumage; but the name L. is often extended to some Australian birds of the same family, in which much more of a green colour appears, and which have a stronger bill and a much less gentle disposition. The true lories feed much on the softest and most juicy fruits; the Australian birds so called are very troublesome as robbers of the fields of ripening maize.

LOSSINI (Ger. *Lussin*), an island in the Gulf of Quarnero, Adriatic Sea, forming part of the Austrian Küstenland, lies immediately south-west of Cherso (q. v.). Length, 21 miles; breadth, from 1 to 3 miles. The principal place on the island is L. Piccolo, or Little L., with 7100 inhabitants, a fine harbour, and an active trade.

LOST PROPERTY. In point of law, the finder of lost property is entitled to keep it until the owner is found; but there are certain circumstances in which the keeping of it will be construed by a jury to amount to larceny. The rule which seems to be laid down in recent cases in England which have been fully discussed, is, that if the finder find the property in such circumstances that he either knows the owner, or has ready means of discovering him, then the taking of the property with intent to keep it will be larceny. If, for example, a servant find a sovereign in her master's house, and keep it, that would be larceny. So it was held to be larceny where the prompter on the stage of a theatre picked up a £50 note which had been dropped by one of the actors. On the other hand, if there be no reasonable probability of ever discovering the true owner, then there is no larceny. The all important point of time for the jury to inquire into is, when the finder picked up the article; for if, on examination, he did not then know who the owner was, nor had the means of ascertaining, he will not become guilty merely because he afterwards, on hearing of the owner, nevertheless keeps it. It has also been decided that the mere keeping of a lost article, in hopes of getting a reward for giving it up, and though the owner be known, does not amount to larceny. There is also no obligation on the finder of lost

property to incur expense in advertising for the owner; indeed, the owner would not be bound in England to repay such expense, though it might be different or doubtful in Scotland; and it is to be borne in mind that the real owner is not divested of his property by the loss, but can demand it from whoever is in possession of it. But there are some peculiarities on this subject as regards lost bills of exchange and notes, which, though originally lost, yet, if transferred without notice, become the property of the transferee. Moreover, the loser of a bill or note payable to bearer cannot sue the party liable, at least without giving an indemnity. There is an exception to the rule, that the finder of lost property is entitled to it, where the property consists of gold, silver, &c., hidden in the earth, in which case the treasure-trove belongs not to the finder, but to the crown; and the finder is bound to give notice thereof to the crown, under a penalty.

LOST TRIBES. See BABYLONIAN CAPTIVITY.

LOT (ancient *Ollis*), a river of Southern France, one of the largest tributaries of the Garonne, rises at Mount Lozère, in the Cevennes. It flows in a generally western direction through the departments of Lozère, Aveyron, Lot, and Lot-et-Garonne, joining the Garonne from the right at Aiguillon, after a course of 270 miles. It is navigable for about 170 miles.

LOT, a department in the south of France, formed out of the province of Guienne, and comprising the arrondissements of Cahors, Gourdon, and Figesac, is watered by the Dordogne, and the Lot, with its tributary, the Sellé. Area, 984,062 English acres; pop. (1862) 295,542. A range of hills, broad, but not very high, and containing some iron, runs through the centre of the department from east to west, in the form of a semicircle. The valleys yield corn, hemp, tobacco, and fruits, and the hill-sides are clothed with vines. Flax-mills are numerous. Capital, Cahors (q. v.).

LOT-ET-GARONNE, a department in the south-west of France, formed out of the province of Guienne, and comprising the arrondissements of Agen, Villeneuve, Marmande, and Nérac, is watered principally by the Garonne and the Lot. Area, 1,320,531; pop. (1862) 332,065, among whom are a considerable number of French Protestants. The department is level, except in the south, where spurs of the Pyrenees make their appearance, and extremely fertile in the basins of the large rivers; but the east is chiefly composed of barren wastes, and the south-west of sandy and marshy tracts termed *Landes*. The principal products are corn, wine, excellent hemp, fruits (of which the *prunes d'agen* are particularly celebrated), tobacco (considered the best manufactured in France), anise, and coriander. Pine, cork, and chestnut woods are numerous; domestic animals, especially poultry, are reared in great numbers for exportation. The chief metal is iron, and the department has ten ironworks, besides various manufactures more or less important.

LO'THIANS. See SCOTLAND.

LOTIONS, or **WASHES**, are remedies of a liquid, but not of an oily nature, which are applied to circumscribed portions of the surface of the body. Amongst the lotions most commonly employed are the *mariate of ammonia wash*, which consists of a solution of sal ammoniac in water or in vinegar with or without the addition of spirit; it is much used in contusions, where there is no wound of the skin, in chronic tumours, in enlarged joints, &c. *Chloride of soda wash*, consisting of solution of chlorinated soda diluted with from ten to twenty times its volume of

water, useful as a gargle in ulceration of the mouth and throat, and as a wash for foul ulcers generally. The *chloride of lime wash*, consisting of one or two drachms (or more) of chloride of lime in a pint of water, used for the same purposes as the preceding wash; and *black wash*, prepared by adding calomel to lime-water (generally a drachm of the former to a pint of the latter), most extensively used in venereal sores, and of service in many forms of intractable ulcers.

LOTOPHAGI (Gr. Lotus-eaters), a name applied by the ancients to a peaceful and hospitable people inhabiting a district of Cyrenaica, on the north coast of Africa, and much depending for their subsistence on the fruit of the lotus-tree, from which they also made wine. According to Homer, they received Ulysses hospitably, when, in the course of his wanderings, he visited them along with his companions, on whom, however, the sweetness of the lotus-fruit exercised such an influence, that they forgot all about their native country, and had no desire to return home. This feeling of happy languor has been expressed with marvellous felicity by Tennyson in his poem on the Lotus-eaters.

LOTTERY, a game of hazard, in which prizes are drawn by lot. Usually, a lottery comprises a specified quantity of tickets, each numbered, every ticket-holder having a right to draw from a box a prize or blank, as the case may happen to be, and thus gain or lose. Lotteries are, of course, got up for the sake of the profit which they may yield to their proprietors; for the aggregate sum expended in prizes always falls short of the aggregate purchase-money for tickets. Whatever be the actual form of the lottery, it is indisputably a gambling transaction, the risks and losses of which are now acknowledged to be demoralising. Lotteries are said to have been first employed by the Genoese government as a means of adding to the revenue of the country, and the bad example was soon followed by the governments of other nations. The first lottery in England appears to have been in the year 1569, and the profits went to the repair of harbours and other public works. The same means was frequently afterwards resorted to for additions to the revenue, or for particular objects, under control or by sanction of the government, the mode of conducting the lottery, and the conditions, being from time to time varied. In the early years of the present century, the *state lottery*, as it was usually called, was one of the regular institutions of the country. Usually, the number of tickets in a lottery was 20,000, at a value of £10 each in prizes. At this valuation they were offered to the competition of contractors, and ordinarily assigned at an advance of £5 or £6 per ticket. The contracting party sold them to the public at a further advance of £4 to £5 per ticket; and thus the value was about doubled. The contractor devised the scheme of prizes and blanks—there being always a few prizes of large amount, to tempt purchasers. To accommodate persons with moderate means, certain tickets were divided into halves, and others into quarters, eighths, or sixteenths. A common price for a sixteenth was £1, 11s. 6d. In the event of the number which it bore being drawn a prize of £20,000, a sixteenth part of that sum was paid, and so on with other prizes. The dexterity of the contractors consisted in drawing up 'schemes,' which in all varieties of placards and hand-bills were issued in profusion through the means of agents all over the country. The drawing took place on a specified day or days in a public hall in London, before certain commissioners, and was in this wise. Two machines, called 'wheels,' were appropriated, one

for the numbers, and the other for the prizes and blanks. On a number being drawn, its fate was determined by the billet which next afterwards came out. Two boys were the operators, one at each wheel. On the grounds of injury to public morals, lotteries were altogether abolished by act of parliament in 1826. Persons advertising or circulating tickets for foreign lotteries may be sued for a penalty by the Attorney-general, or Lord-advocate, or the Commissioners of Stamps. It required a special statute, therefore, to legalise art-unions, which are only lotteries under a specious form; but owing to their supposed good effects in encouraging art, they were exempted from penalties by the statute 9 and 10 Vict. c. 43, and a similar voluntary association was excepted by the statute 21 and 22 Vict. c. 102. In France, the abolition of lotteries took place in 1836, and in Hesse-Darmstadt in 1852. The other German states, however, continue the use of them; and in 1841, Prussia derived from them a revenue of more than 900,000 thalers, Austria, of 3,600,000 florins. In Rome and the Papal territory, they survive in full vigour. Few worse ways of supplying the exchequer of a country have almost ever been imagined; and the only excuse urged is, that the gambling spirit exists, and will find some means of gratification, even if lotteries were abolished. It was found, however, in France that the abolition of lotteries was immediately followed by an increase of savings-bank deposits; and it has been everywhere observed, that the purchasers of lottery-tickets have been to a great extent persons belonging, not to the wealthiest classes of society, but to those in which economy and prudence are most necessary to the comfort of families and the general welfare of the state.

LOTUS. The name *Lotos* (Lat. *Lotus*) was given by the Greeks to a number of different plants whose fruit was used for food. One of the most notable of these is the *Zizyphus Lotus*, a native of the north of Africa and the south of Europe, belonging to the



Nymphaea Lotus.

natural order *Rhamnæa*. See **JUJUBE**. It is a shrub of two or three feet high, and its fruit, which is produced in great abundance, is a drupe of the size of a wild plum, with an almost globose kernel. This fruit is somewhat farinaceous, and has a pleasant, sweetish, mucilaginous taste. It is called by the Arabs *Nabk* or *Nabka*; and has, from the earliest times, served as an article of food to the inhabitants of the north of Africa, where it is still a principal part of the food of the poor. Probably it was on this fruit that Homer's *Lotophagi* (q. v.) lived.—The fruit of the *Diospyrus Lotus*, or Date Plum, was sometimes called the lotus. See **DATE**

PLUM.—The name *L* was also given to several beautiful species of Water-lily (q. v.), especially to the **BLUE WATER-LILY** (*Nymphaea cœrulea*) and the **EGYPTIAN WATER-LILY** (*N. lotus*), and to the **NELUMBO** (q. v.) (*Nelumbium speciosum*), which grow in stagnant and slowly running water in the south of Asia and north of Africa. The *Nymphaea lotus* was called by the Egyptians *Shinin* or *Seshin*, and is called by the Arabs *Beshnin*, the Coptic name with the masculine article. It grows in the Nile and adjacent rivulets, and has a large white flower. The root is eaten by the people who live near the lake Menzaleh. The rivulets near Damietta abound with this flower, which rises two feet above the water. It was the rose of ancient Egypt, the favourite flower of the country, and is often seen made into wreaths or garlands, placed on the foreheads of females, or held in their hands, and smelled for its fragrance. It frequently appears in the hieroglyphs, where it represents the Upper Country or Southern Egypt, and entered largely into works of art—the capitals of columns, prows of boats, heads of staves, and other objects being fashioned in its shape. In the mythology, it was the special emblem of *Neser Atum*, the son of Ptah and Bast; the god Harpocrates is seated upon it; and there was a mystical *L* of the sun. In the mythology of the Hindus and Chinese, the *L* plays a distinguished part. It is the *Nelumbo*. The Hindu deities of the different sects are often represented seated on a throne of its shape, or on the expanded flower. The colour in Southern India is white or red, the last colour fabled to be derived from the blood of Siva, when Kamadeva, or Cupid, wounded him with the love-arrow. Lakshmi, also, was called the 'lotus-born,' from having ascended from the ocean on its flower. It symbolised the world; the *Meru*, or residence of the gods; and female beauty. Among the Chinese, the *L* had a similar reputation and poetic meaning, being especially connected with Fuh, or Buddha, and symbolising female beauty, the small feet of their women being called *kin leen*, or 'golden lilies.'

Wilkinson, *Mann. and Cust.*, iii. 187, 200, iv. 44, 63, v. 264, 269; Jomard, *Descr. de l'Ég.*, t. 1, p. 5; Homer, *Il.* xii. 238, iv. 171, *Od.* ix. 92; Herodotus, ii. 96, iv. 177; *Diod. Sic.* i. 34; Coleman, *Mythology of the Hindus*.

LOUDON, JOHN CLAUDIUS, a distinguished botanist and horticulturist, born April 8, 1783, at Cambuslang, in Lanarkshire. He became a gardener, and in 1803 published *Observations on Laying out Public Squares*, and in 1805, a *Treatise on Hot-houses*; and afterwards became the author of a number of works on botany, mostly of a somewhat popular character, which have contributed much to extend a knowledge of that science and a taste for horticulture. Amongst these are the *Encyclopædia of Gardening* (1822); and of *Agriculture* (1825); the *Green-house Companion* (1825); the *Encyclopædia of Plants* (1829); and the *Arboretum et Fruticetum Britannicum* (8 vols. 1838), containing a very full account of the trees and shrubs, indigenous or introduced, growing in the open air in Britain. This last is his great work; but the expense attending the publication, owing chiefly to the number of plates, involved him in pecuniary difficulties. He died at Bayswater, December 14, 1843. *L* established four different magazines, which he edited simultaneously with his *Arboretum*.—His widow is the authoress of a number of pleasing popular works, chiefly on subjects connected with botany and gardening.

LOU'GHBOROUGH, a manufacturing and market-town of England, in the county of Leicester, 12 miles north-north-west of the town of

that name. The chief educational institution in the town is the Burton Foundation (dating from 1495), with an annual income from endowment of £1742, 16s. With this Foundation, five distinct schools are connected, each pupil having to pay a small sum. L. carries on extensive manufactures of patent Angola hosiery, of other woollen and cotton goods, elastic webs, net-lace, and shoes. Pop. (1861) 10,830.

LOUGHREA, a market-town of Ireland, in the county of Galway, about 20 miles east-south-east of the town of that name. It stands on the north bank of Lough Rea, a beautiful little lake four miles in circumference. It contains a Roman Catholic chapel, with a Carmelite friary and nunnery, and the remains of a Carmelite abbey founded in 1300. Manufactures of narrow linen and coarse diapers; brewing and tanning are carried on. Pop. (1861) 3063.

LOUIS (properly **LUDWIG**) **THE GERMAN**, the third son of Louis le Débonnaire, was born about 805, and by the treaty at Verdun, in 843, L. obtained Germany, and became the founder of a distinct German monarchy. He died at Frankfurt, 28th August 876. His kingdom was divided amongst his three sons: Carlmann obtaining Bavaria, Carinthia, and the tributary Slavonic countries; Louis obtaining Franconia, Thuringia, Saxony, and Friesland; Charles the Fat obtaining Swabia, from the Maine to the Alps. See **CARLOVINGIANS**.

LOUIS I. See **CARLOVINGIANS**.

LOUIS IX., or **SAINT LOUIS**, king of France, born in Poissy, April 25, 1215, succeeded his father, Louis VIII., in 1226. His mother, Blanche of Castile, a woman of great talent and sincere piety, was regent during his minority, and bestowed on him a strictly religious education, which materially influenced his character and policy. When L. attained his majority, he became involved in a war with Henry III. of England, and defeated the English at Taillebourg, at Saintes, and at Blaye in 1242. During a dangerous illness, he made a vow that, if he recovered, he would go in person as a Crusader, and accordingly, having appointed his mother regent, he sailed, in August 1248, with 40,000 men to Cyprus, whence, in the following spring, he proceeded to Egypt, thinking, by the conquest of that country, to open the way to Palestine. He took Damietta, but was afterwards defeated and taken prisoner by the Mohammedans. A ransom of 100,000 marks of silver procured his release on May 7, 1250, with the relics (6000 men) of his army. He proceeded by sea to Acre, and remained in Palestine till the death of his mother (November 1252) compelled his return to France. He now applied himself earnestly to the affairs of his kingdom, united certain provinces to the crown on the lapse of feudal rights or by treaty, and made many important changes, the general tendency of which was to increase the royal power. A code of laws was brought into use, known as the *Etablissements de St Louis*. L. embarked on a new Crusade, July 1, 1270, and proceeded to Tunis; but a pestilence breaking out in the French camp, carried off the greater part of the army and the king himself. He died August 25, 1270; and his son, Philip III., was glad to make peace and return to France. Pope Boniface VIII. canonised him in 1297. For an interesting picture of the religious side of L.'s character, consult Neander's *Kirchengeschichte*. Bohn, vol. vii. pp. 416—418.

LOUIS XI., king of France, the eldest son of Charles VII., born at Bourges, July 3, 1423, was from his boyhood eminently cruel, tyrannical, and perfidious. He made unsuccessful attempts against

his father's throne, was compelled to flee to Brabant, and sought the protection of Philip the Good, Duke of Burgundy, with whom he remained till his father's death in 1461, when he succeeded to the crown. The severe measures which he immediately adopted against the great vassals, led to a coalition against him, at the head of which were the great Houses of Burgundy and Bretagne. L. owed his success more to his artful policy than to arms; and the war threatening to break out anew, he invited Charles the Bold, Duke of Burgundy, to a friendly conference at Péronne, in October 1468. His agents, meanwhile, had stirred up the people of Liege to revolt against the duke, upon the news of which occurrence, Charles made the king a prisoner, and treated him roughly. On the death of the Duke of Burgundy in 1477, who left an only daughter, L. claimed great part of his territories as male fiefs lapsed to the superior, and wished to marry the young duchess to his eldest son, a boy of seven years. On her marriage with the Archduke Maximilian, he flew to arms; but a peace was concluded at Arras, December 25, 1482, by which the daughter of Maximilian was betrothed to the dauphin (afterwards Charles VIII.), and the counties of Burgundy and Artois were handed over to France. L. was also successful—after the use of means far from honourable—in annexing Provence to the crown as a lapsed fief. He greatly increased the power of the French monarchy. The latter years of his reign were spent in great misery, in excessive horror of death, which superstitious and ascetic practices failed to allay. He died August 30, 1483. It was calculated that he put about 4000 persons to death in the course of his reign, mostly without form of trial. Yet he was a patron of learning, and is said to have been the author of *Les cent Nouvelles nouvelles*, a sort of imitation of the *Decameron*, and of the *Rosier des Guerres*, a book of instruction for his son. He also materially advanced the civilisation of France by encouraging manufactures, commerce, and mining. He improved the public roads and canals, established several printing-presses, and founded three universities.

LOUIS XIII., king of France, son of Henri IV. and Marie de' Medici, born at Fontainebleau 27th September 1601, succeeded to the throne on the death of his father, 14th May 1610, his mother becoming regent. She entered into close alliance with Spain, and betrothed the king to Anne of Austria, daughter of Philip III. of Spain, upon which the Huguenots, becoming apprehensive of danger, took up arms; but peace was concluded at St Menchould, on 5th May 1614; and the king, who was now declared of age, confirmed the Edict of Nantes, and called an Assembly of the States, which was soon dismissed, because it began to look too closely into financial affairs. See **MARIE DE' MEDICI**. The suppression of Protestantism and liberty in Bearn led to the religious war, in which the Protestants lost almost all their places of security, and which ended in 1622. After the death of De Luynes, in 1624, Richelieu, afterwards Cardinal and Duke, became the chief minister of Louis. His powerful mind obtained complete control over that of the weak king, and his policy effected that increase of monarchical power, at the expense of Protestants, nobles, and parliaments, which reached its consummation in the reign of Louis XIV. The overthrow of the Huguenots was completed by the capture of Rochelle, 20th October 1628, at the siege of which the king took part in person. In 1631, his brother, the Duke of Orleans, having left the court, assembled a troop of Spaniards in the Netherlands, and entered France to compel the dismissal of Richelieu, whom he hated,

and whom the king also secretly disliked; but the duke was completely defeated by Marshal Schomberg at Castelmandary. Richelieu now led L. to take part in the Thirty Years' War, openly supporting Gustavus Adolphus and the Dutch against the Spaniards and Austrians. The latter years of L.'s reign were signalled by the acquisition of Alsace and of Roussillon. L. died 14th May 1643, a few months after his great minister. His queen, after having been 23 years married, bore a son in 1638, who succeeded to the throne as Louis XIV.; and in 1640, a second son, Philip, Duke of Orleans, from whom the present House of Orleans is descended.

LOUIS XIV., king of France, born at St Germain-en-Laye 16th September 1638, succeeded his father, Louis XIII., in 1643. His mother, Anne of Austria, became regent, and Mazarin (q.v.) her minister. During the king's minority, the discontented nobles, encouraged by Spain, sought to shake off the authority of the crown, and the civil wars of the *Fronde* (q.v.) arose. Peace was concluded in 1659; and in the following year L. married the Infanta Maria Theresa, a princess possessing neither beauty nor other attractive qualities. Little was expected from the young king; his education had been neglected, and his conduct was dissolute; but on Mazarin's death, in 1661, he suddenly assumed the reins of government, and from that time forth carried into effect with rare energy a political theory of pure despotism. His famous saying, '*L'état c'est moi*' (I am the state), expressed the principle to which everything was accommodated. He had a cool and clear head, with much dignity and amenity of manners, great activity, and indomitable perseverance. The distress caused by the religious wars had created throughout France a longing for repose, which was favourable to his assumption of absolute power. He was ably supported by his ministers. Manufactures began to flourish under the royal protection. The fine cloths of Louviers, Abbeville, and Sedan, the tapestries of the Gobelins, the carpets of La Savonnerie, and the silks of Tours and Lyon acquired a wide celebrity. The wonderful talents of Colbert (q.v.) restored prosperity to the ruined finances of the country, and provided the means for war; whilst Louvois (q.v.) applied these means in raising and sending to the field armies more thoroughly equipped and disciplined than any other of that age.

On the death of Philip IV. of Spain, L., as his son-in-law, set up a claim to part of the Spanish Netherlands; and in 1667, accompanied by Turenne (q.v.), he crossed the frontier with a powerful army, took many places, and made himself master of that part of Flanders since known as French Flanders, and of the whole of Franche Comté. The *triple alliance*—between England, the States-general, and Sweden—arrested his career of conquest. The treaty of Aix-la-Chapelle (1668) forced him to surrender Franche Comté. He vowed revenge against the States-general, strengthened himself by German alliances, and purchased with money the friendship of Charles II. of England. He seized Lorraine in 1670; and in May 1672 again entered the Netherlands with Condé and Turenne, conquered half the country in six weeks, and left the Duke of Luxembourg to lay it waste. The States-general formed an alliance with Spain and with the Emperor, but L. made himself master of ten cities of the empire in Alsace; and in the spring of 1674, took the field with three great armies, of which he commanded one in person, Condé another, and Turenne a third. Victory attended his arms; and notwithstanding the death of Turenne, and the retirement of the Prince of Condé from active service, he continued in subsequent years, along with

his brother, the Duke of Orleans, to extend his conquests in the Netherlands, where, by his orders, and according to the ruthless policy of Louvois, the country was fearfully desolated. The Peace of Nimeguen, in 1678, left him possession of many of his conquests. He now established *Chambres de Réunion* in Metz, Breisach, and Besançon, pretended courts of law, in which his own will was supreme, and which confiscated to him, as feudal superior in right of his conquests, territories which he wished to acquire, seignories belonging to the Elector Palatine, the Elector of Treves, and others. He also, on 30th September 1681, made a sudden and successful attack on Strasburg, a free German city, the possession and fortification of which added greatly to his power on the Rhine. The acquisition thus made, a treaty in 1684 confirmed to him.

L. had now reached the zenith of his career. All Europe feared him; his own nation had been brought by tyranny, skilful management, and military glory, to regard him with Asiatic humility, admiring and obeying; all remnants of political independence had been swept away; no Assemblies of the States or of the Notables were held; the nobles had lost both the desire and the ability to assert political power; the municipal corporations no longer exercised any right of election, but received appointments of officials from the court; the provinces were governed by *intendants*, who were immediately responsible to the ministers, and they to the king, who was his own prime minister. Even the courts of justice yielded to the absolute sway of the monarch, who interfered at pleasure with the ordinary course of law, by the appointment of commissions, or withdrew offenders from the jurisdiction of the courts by *Lettres de Cachet* (q.v.), of which he issued about 9000 in the course of his reign. He asserted a right to dispose at his pleasure of all properties within the boundaries of his realm, and took credit to himself for gracious moderation in exercising it sparingly. The court was the very heart of the political and national life of France, and there the utmost splendour was maintained; and a system of etiquette was established, which was a sort of perpetual worship of the king.

It was a serious thing for France and the world when L. fell under the control of his mistress, the Marquise de Maintenon (q.v.), whom he married in a half-private manner in 1685, and who was herself governed by the Jesuits. One of the first effects of this change was the adoption of severe measures against the Protestants. When it was reported to L. that his troops had converted all the heretics, he revoked the Edict of Nantes in 1685, and then ensued a bloody persecution; whilst more than half a million of the best and most industrious of the inhabitants of France fled, carrying their skill and industry to other lands. Yet L. was by no means willing to yield too much power to the pope; and quarrelling with him concerning the revenues of vacant bishoprics, he convened a council of French clergy, which declared the papal power to extend only to matters of faith, and even in these to be dependent upon the decrees of councils.

The Elector of the Palatinate having died in May 1685, and left his sister, the Duchess of Orleans, heiress of his movable property, L. claimed for her also all the allodial lands; and from this and other causes arose a new European war. A French army invaded the Palatinate, Baden, Wurtemberg, and Treves in 1688. In 1689, the Lower Palatinate and neighbouring regions were laid waste by fire and sword. This atrocious proceeding led to a new coalition against France. Success for a time attended the French arms, particularly in Savoy and at the battle of Steinkerck. Reverses, however, ensued;

the war was waged for years on a great scale, and with various success; and after the French, under Luxembourg, had gained, in 1693, the battle of Neerwinden, it was found that the means of waging war were very much exhausted, and L. concluded the peace of Ryswick on 20th September 1697. The navy destroyed, the finances grievously embarrassed, the people suffering from want of food, and discontentment deep and general, L. placed the Count D'Argenson at the head of the police, and established an unparalleled system of espionage for the maintenance of his own despotism. The power of Madame de Maintenon and her clerical advisers became more and more absolute at the court, where scandals of every kind increased.

When the death of Charles II. of Spain took place on 1st November 1700, it was found that L. had obtained his signature to a will by which he left all his dominions to one of the grandsons of his sister, who had been L.'s queen. L. supported to the utmost the claim of his grandson (Philip V.), whilst the Emperor Leopold supported that of his son, afterwards the Emperor Charles VI. But the power of France was now weakened, and the war had to be maintained both on the side of the Netherlands and of Italy. One bloody defeat followed another; Marlborough was victorious in the Low Countries, and Prince Eugene in Italy; whilst the forces of L. were divided and weakened by the employment of large bodies of troops against the Camisards in the Cevennes, for the extinction of the last relics of Protestantism. On the 11th April 1713, peace was concluded at Utrecht, the French prince obtaining the Spanish throne, but France sacrificing valuable colonies. A terrible fermentation now prevailed in France, and the country was almost completely ruined; but the monarch maintained to the last an unbending despotism. He died, after a short illness, 1st September 1715. He was succeeded by his great-grandson, Louis XV. His son, the Dauphin, and his eldest grandson, the Duke of Bretagne, had both died in 1711. Louis had a number of natural children, and he had legitimized those of whom Madame de Montespan was the mother; but the parliament, which made no objection to recording the edict when required by him, made as little objection to annulling it when required by the next government. The 'works' of Louis XIV. (6 vols. Paris, 1806), containing his Instructions for his sons, and many letters, afford important information as to his character and the history of his reign. The reign of Louis XIV. is regarded as the Augustan age of French literature and art, and it can hardly be doubted that France has never since produced poets like Corneille and Racine in tragedy, or Molière in comedy; satirists like Boileau, or divines like Bossuet, Fenelon, Beudaloue, and Massillon.

LOUIS XV., king of France, the great-grandson of Louis XIV., born at Versailles 15th February 1710, succeeded to the throne 1st September 1715. The Duke of Orleans, as first prince of the blood, was regent during the minority of the king, whose education was intrusted to Marshal Villeroi and Cardinal Fleury. The country was brought to the verge of ruin during the regency, by the folly of the regent and the financial schemes of the celebrated Scotchman, Law (q. v.). When L. was fifteen years of age, he married Maria Leszcynski, daughter of Stanislas, the dethroned king of Poland. Fleury was for a long time at the head of affairs, and by parsimony succeeded in improving the condition of the finances. It was his policy also to avoid war, in which, however, L. was involved in 1733, in support of his father-in-law's claim to the throne of Poland; the result

being that L. obtained Lorraine for his father-in-law, and ultimately for France. Notwithstanding the vigour with which this war was conducted, the character of L. now became completely developed as one of the utmost sensuality, selfishness, and baseness. He surrounded himself with the vilest society, utterly forsook his queen, and lived, as he continued to do to the end of his life, in extreme debauchery, such as has rendered his name a proverb. In 1740, the war of the Austrian Succession broke out, in which the French arms were by no means very successful, and during which Fleury died. The king was present, in 1745, at the great victory of Fontenoy, and shewed plenty of courage. In the preceding year, during a dangerous illness, he had made vows of reforming his life, and dismissed his mistresses; but on recovering health, he presently relapsed into vice. The peace of Aix-la-Chapelle, in 1748, was very much due to the entreaties of Madame de Pompadour, whose influence the Empress Elizabeth of Russia secured by bribes and flatteries. France gained nothing by this war; but her people were ruined, and her navy destroyed.

The king now sank completely under the control of Madame de Pompadour, who was both concubine and procuress, and to whom he gave notes on the treasury for enormous sums, amounting in all to hundreds of millions of livres. War broke out again with Britain concerning the boundaries of Acadia (Nova Scotia), and was for some time prosecuted with considerable vigour. In 1756, an extraordinary alliance was formed between France and Austria, contrary to the policy of ages, and chiefly through the influence of Madame de Pompadour; but as she disposed of the command of the French armies at her pleasure, success did not attend their operations. The state of the finances, the dispirited condition of the army, and the outcry of the distressed people, were not sufficient to induce the king to make peace; but governed by his mistress, he obstinately persevered in war, even after the terrible defeat of Minden in 1759; whilst the British conquered almost all the French colonies both in the East and West Indies, with Cape Breton and Canada. A peace, most humiliating to France, was at last concluded in 1763.

L., although indifferent to the ruin of his people, and to everything but his own vile pleasures, was reluctantly compelled to take part in the contest between Madame de Pompadour and the Jesuits, the result of which was the suppression of the order in 1764. See JESUITS. The parliaments, emboldened by their success in this contest, now attempted to limit the power of the crown, by refusing to register edicts of taxation; but the king acted with unusual vigour, maintaining his own absolute and supreme authority, and treating the attempt of the parliaments to unite for one object as rebellious. The Duke of Choiseul was now displaced from office; a new mistress, Madame Du Barry, having now come into the place of Madame de Pompadour; and a ministry was formed under the Duke d'Aiguillon, every member of which was an enemy of the parliaments, and an object of popular detestation. The councillors of the parliament of Paris were removed from their offices, and banished with great indignity; and an interim parliament was appointed (January 1771), which duly obeyed the court. The princes of the blood protested against this arbitrary act, which deeply moved the popular indignation. The king, when told of the ruin of the country, and the misery and discontent of the people, only remarked that the monarchy would last as long as his life; and continued immersed in sensual pleasures and trifling amusements. He boasted of being the best cook in

France, and was much gratified when the courtiers ate eagerly of the dishes which he had prepared. His gifts to Madame Du Barry, notwithstanding the embarrassment of the finances, in five years amounted to 180 millions of livres. At last, L., who had for some time suffered from a disease contracted through vice, was seized with small-pox, the infection of which was communicated by a young girl who had been brought to him, and on 10th May 1774 he died, so far from being regretted that his funeral was a sort of popular festival, and was celebrated with pasquils and merry ballads. His death-bed was one of extreme misery. He was succeeded by his grandson, Louis XVI.

LOUIS XVI., AUGUSTE, king of France, born 23d August 1754, was the third son of the Dauphin, Louis, only son of Louis XV. He was styled Duke de Berry, until, by the death of his father and his elder brothers, he became Dauphin. He had a vigorous frame, was fond of hunting and manly exercises, took great pleasure in mechanical labours, and shewed an aptitude for geometry, but none for political science. In the midst of the most corrupt of courts, he grew up temperate, honest, and moral. He was married on 10th May 1770, to Marie Antoinette, the youngest daughter of the Empress Maria Theresa.

When L. ascended the throne, misery and discontentment prevailed throughout France. He had not the vigour and judgment necessary for circumstances full of difficulty, and was conscious of his own weakness. He made Maurepas, an old courtier, his prime minister; but among his ministers were Malesherbes, Turgot, and other men of known patriotism; and his accession was signalled by the remission of some of the most odious taxes, the abolition of the last relics of serfdom, the abolition of the torture in judicial investigations, a reduction of the expenditure of the court, and the foundation of institutions for the benefit of the working-classes. He was, for a time, extremely popular; but deeper reforms were rendered impossible by the opposition of the privileged classes. In June 1777, when the state of the finances seemed nearly desperate, Necker (q. v.) was called to the office of General Director of them, and succeeded in bringing them to a more tolerable condition, without any very radical change; but from the interference of France in the American war of independence, he was obliged to propose the taxation of the privileged classes, hitherto exempted. Their resistance compelled him to resign; and Joly de Fleury succeeded him; but the general discontentment induced the king, in 1783, to appoint Calonne (q. v.) comptroller-general, who found money for a time by borrowing, much to the satisfaction of the courtiers. But the indignation of the people increasing, Calonne found it necessary to recommend the convening of an Assembly of the Notables. On 1st May 1787, the Archbishop Loménie de Brienne became Finance Minister. He obtained from the Notables some concessions and some new taxes. But the parliament of Paris refused to register the edict of taxation, as oppressive to the people; and the extravagance of the court and the queen began to be freely spoken of. The convening of the States-general now began to be demanded from every corner of France. The king registered the edicts in a *lit de justice*, and banished the councillors of parliament to Troyes; but ere long found it necessary to recall them, and experienced from them even a stronger opposition than before. On 8th May 1788, he dissolved all the parliaments, and established a new kind of court (*Cour Plénière*) instead; but this act of despotism set the whole country in flames. Matters became still worse, when on

16th August appeared the famous edict, that the Treasury should cease from all cash payments except to the troops. Brienne was compelled to resign, and Necker again became minister. An Assembly of the States of the kingdom was resolved upon; and by the advice of Necker, who wished a counterpoise to the influence of the nobility, clergy, and court, the Third Estate was called in double number.

The subsequent history of L. is given at length under the head FRANCE. All readers of history are familiar with the melancholy incidents of his life, from the opening of the Assembly of the States (5th May 1789) down to his tragic execution. At ten o'clock in the morning of the 21st of January 1793, he died by the guillotine, in the Place de la Révolution. Great precautions were taken to prevent any rescue. As the executioner bound him, Louis tore himself free, and exclaimed: 'Frenchmen, I die innocent; I pray that my blood come not upon France.' The rolling of drums drowned his voice. Ere the guillotine fell, the Abbé Edgeworth, his confessor, cheered him with the words: 'Son of St Louis, ascend to heaven!'

LOUIS XVII., CHARLES, second son of Louis XVI. of France, born at Versailles, 27th March 1785, received the title of Duke of Normandy, till, on the death of his brother in 1789, he became Dauphin. He was a promising boy. In the earlier days of the Revolution, he was sometimes dressed in the uniform of the National Guard, and decorated with the tricolor, to gratify the populace. After the death of his father, he continued in prison—at first with his mother, but afterwards apart from her—in the Temple, under the charge of a coarse Jacobin shoemaker, named Simon, who treated him with great cruelty, and led him into vicious excesses, so that he became a mere wreck both in mind and body. After the overthrow of the Terrorists, he was—perhaps intentionally—forgotten, and died 8th June 1795. A report spread that he was poisoned, but a commission of physicians examined the body, and declared the report unfounded.

LOUIS XVIII., STANISLAS XAVIER, the next younger brother of Louis XVI., born at Versailles, 17th November 1755, received the title of Count de Provence. In 1771, he married Maria Josephine Louisa, daughter of Victor Amadeus III. of Sardinia. After the accession of Louis XVI. to the throne, he assumed the designation of *Monsieur*, and became an opponent of every salutary measure of the government. He fled from Paris on the same night with the king, and was more fortunate, for, taking the road by Lille, he reached the Belgian frontier in safety. With his brother, the Count d'Artois, he now issued declarations against the revolutionary cause in France, which had a very unfavourable effect on the situation of the king. The two brothers for some time held a sort of court at Coblenz. L. joined the body of 6000 emigrants who accompanied the Prussians across the Rhine in July 1792, and issued a manifesto even more foolish and extravagant than that of the Duke of Brunswick. After the death of his brother, Louis XVI., he proclaimed his nephew King of France, as Louis XVII., and in 1795 himself assumed the title of king. The events of subsequent years compelled him frequently to change his place of abode, removing from one country of Europe to another, till at last, in 1807, he found a refuge in England, and purchased a residence, Hartwell, in Buckinghamshire, where his wife died in 1810, and where he remained till the fall of Napoleon opened the way for him to the French throne. He landed at Calais on 26th April 1814, and entered Paris, after twenty-four years' exile, on 3d May; and the nation received

the constitutional charter from his hands on 4th June. See FRANCE.

The conduct of the government, however, was far from being constitutional or liberal. The nobles and priests exercised an influence over the weak king, which led to severe treatment of the Imperialists, the Republicans, and the Protestants. Then followed Napoleon's return from Elba, when the king and his family fled from Paris, remained at Ghent till after the battle of Waterloo, and returned to France under protection of the Duke of Wellington. He issued from Cambrai a proclamation in which he acknowledged his former errors, and promised a general amnesty to all except traitors. Again, however, he followed in many things the counsels of the party which detested all the fruits of the Revolution. But the Chamber of Deputies, elected with many irregularities, was fanatically royalist, and the king, by advice of the Duke de Richelieu, dissolved it; whereupon arose royalist plots for his dethronement, and the abolition of the charter. Bands of assassins were collected by nobles and priests in the provinces, who slew hundreds of adherents of the Revolution and of Protestants, and years elapsed ere peace and good order were in any measure restored. L. died, 16th September 1824.

LOUIS NAPOLÉON, whose full name is CHARLES LOUIS NAPOLÉON BONAPARTE, and his titular designation, *Napoléon III., Emperor of the French*, was born at Paris, in the palace of the Tuileries, 20th April 1808. He is the third son of Louis Bonaparte, brother of the first Emperor. See BONAPARTE FAMILY. His birth was celebrated with great rejoicings throughout France, as that of an heir to the imperial throne, for by the law of succession (dated 26th Floreal, year 12, and 5th Frimaire, year 13), the crown, in default of direct descendants of the Emperor himself—and he at that time had none—could be inherited only by the children of two of his brothers, Joseph and Louis. But Joseph was also childless, and the sons of Louis, in consequence, became heirs-apparent. After the restoration of the Bourbons, the ex-queen Hortense, mother of L. N., went into exile, carrying with her her two sons, Napoléon Louis and Louis Napoléon. Since 1810, she had been separated from her husband. L. received his early education in the castle of Arenberg, on the shores of Lake Constance, where his mother resided. He was furnished with the best tutors that could be got, and was far from proving a slothful pupil. At the gymnasium of Augsburg, he displayed quite a passion for history and the exact sciences. His love of athletic sports was equally conspicuous; he was one of the best fencers, riders, and swimmers in the whole school. In Switzerland, his inclination and aptitude for military strategy, especially in artillery and engineering, was first developed. He even served for some time as a volunteer in the federal camp at Thun, and at a later period in his life wrote a *Manuel d'Artillerie* (Zürich, 1836). In 1830, when an insurrection broke out in the pontifical states, L. N. and his brother took part in it. The latter died at Forlì, and L. N. himself fell dangerously ill at Ancona, and was only saved by the tender devotedness of his mother. The Austrian occupation of Ancona forced them to quit the city secretly; they proceeded to France, but their incognito being betrayed, they were expelled by Louis Philippe, after a few days, and crossed over to England, whence they soon returned to Switzerland. Such, however, was the charm of N.'s name, that the chiefs of the Polish insurrection offered him, in 1831, the command of their legions, 'as the nephew of the greatest captain of all ages,' and also the crown of Poland.

The capture of Warsaw by the Russians, however, put a stop to further proceedings in this matter, and L. N. once more turned to his silent and sombre studies. The death (22d July 1832) of the Duke of Reichstadt, sometimes called *Napoléon II.*, only son of the first Emperor, opened the future to his ambitious hopes; and even his supporters admit that, from this date forward, his whole life, speculative and practical, was devoted to the realisation of what now became his 'fixed idea;' viz., that he was destined to be the sovereign of France. Between 1832 and 1836, he published several works, which not only kept him prominently before the French public, but evoked a considerable amount of political and intellectual sympathy. We may mention his *Réveries Politiques, Projet de Constitution, Deux Mots à M. de Chateaubriand sur la Duchesse de Berri* (in verse), and *Considérations Politiques et Militaires sur la Suisse*. In 1836, believing in the instability of the throne of Louis Philippe, and in the general disaffection of the *bourgeoisie*, encouraged also by the proofs of vivid attachment to his person displayed by nearly the whole of the democratic party, but, above all, confiding in the grandeur of those memories which his name recalled, he, with a few associates, among whom was the Comte de Persigny, since better known, made his famous attempt at a *coup d'état* at Strasbourg. It was, as all the world knows, a ludicrous failure. L. N. was taken prisoner under humiliating circumstances, and after some days conveyed to Paris; but the government of Louis Philippe was afraid to bring a Bonaparte to trial—as in such a case it could not rely upon the impartiality of a French jury—and in consequence shipped him off to America. The illness of his mother soon caused him to return to Europe. He found her dying; two months later, he received her last sighs (3d October 1837). Although the affair of Strasbourg had naturally enough caused many people to doubt the talent and particularly the judgment of L. N., still Louis Philippe, who was, politically speaking, an extremely timid monarch, dreaded some new conspiracy, and, in consequence, the French government demanded of Switzerland the expulsion of the obnoxious prince from its territories, M. Molé actually enjoining the French ambassador to request his passports, in case of a refusal. Switzerland was violently agitated, and was almost on the point of going to war for the distinguished refugee (who was, in fact, a Swiss citizen), when the latter resolved to prevent a rupture by leaving his adopted country. He now proceeded to England, and settled in London. With certain members of the British aristocracy, he came to live on a footing of considerable intimacy, and there can be no doubt that he was also an object of languid wonder and interest to the community generally, but he impressed nobody with a belief in his future and his genius; nay, Englishmen erred so far as to suppose that the 'silent man' was merely 'dull.' In 1838, he published in London his *Idées Napoléoniennes*, which, read in the light of subsequent events, are very significant. Europe generally regarded them as idle dreams; but in France the book went through numerous editions. In 1839, L. N. was in Scotland, and took part in the celebrated Eglinton tournament. Next year (1840), taking advantage of the sentiment aroused by the bringing home of the ashes of his uncle from St Helena, he made another attempt on the throne of France at Boulogne. It was as grotesque a failure as the one at Strasbourg, and undoubtedly provoked a certain feeling of contempt for its author in the mind of the general public. Captured on the shore, while endeavouring to make his escape to the vessel that had brought him from England, L. N. was

again brought to trial, and condemned to perpetual imprisonment in the fortress of Ham. Here he composed several works, *Aux Mânes de l'Empereur*; *Fragments Historiques*; *Analyse de la Question de Suisse*; *Réponse à M. de Lamartine*; and *Extinction du Paupérisme*, wrote political articles for the democratic journals, and actually took part in editing the *Dictionnaire de la Conversation*, a valuable French encyclopædia. After an imprisonment of more than five years, he made his escape (25th May 1846), by the help of a Dr Conneau, in the disguise of a workman, and gained the Belgian frontier, whence he returned to England. The revolution of February (1848) caused him to hurry back to France, where he professed himself devoted to the views of the Provisional Government; the latter, however, requested him to leave the country. This he promised to do; but being elected deputy for Paris and three other departments, he took his seat in the Constituent Assembly, 13th June 1848. A stormy debate followed, and on the 15th he resigned his seat, and, either from policy or patriotism, left France. Recalled to France in the following September by a quintuple election, he once more appeared in the Assembly, and at once, through the agency of his zealous associates, commenced his candidature for the presidency. The masses were—rightly or wrongly—thoroughly in his favour. Out of seven and a half million of votes, 5,562,834 were recorded for Prince L. N.; General Cavaignac, who was nearest to him, obtaining only 1,469,166. This fact is declared by the partisans of the emperor to be an absolute proof of his popularity, for at this period he had neither power nor money to force or bribe opinion. On the 20th December, he took the oath of allegiance to the republic. For a few days, concord seemed to be re-established between the different political parties in the Assembly; but the beginning of the year 1849 witnessed the commencement of a series of struggles between the president and his friends on the one side, and the majority of the Assembly on the other—the latter being profoundly penetrated with the conviction that L. N. was not devoted to the interests of the republic, but to his own. The French expedition to Italy and the siege of Rome were, above all, the causes of violent discussion in the chambers. This anarchic condition of things, in which, however, the president tenaciously held his ground, was summarily put a stop to by the famous or infamous (for opinions differ) *coup d'état*, 2d December 1851. The principal actors in this midnight deed were the president himself, M. de Morny, M. de Maupas, and General St Arnaud. The circumstances that marked it were of necessity odious, and even atrocious; and there cannot be the shadow of a doubt that it has engendered in the mind of Europe a distrust of the honesty of L. N., which it is not likely will ever be wholly removed. His success was certainly magnificent, but the cost has also been enormous. The feeble attempts at an armed resistance in Paris were put down by the military, who were favourable to the president, and under the command of his accomplices. A rigorous system of repression was put in force both in Paris and in the departments, and the deportation to Cayenne and Algeria became painfully familiar to the European public. France, as a whole, however, whether wearied of the incompetent democrats, or (as Kinglake supposes) 'cowed' by the terrible audacity of the president, appeared to acquiesce in his act; for when the vote was taken upon it on the 20th and 21st of the same month, he was re-elected president for ten years, with all the powers he demanded, by more than 7,000,000 suffrages. His enemies affirm they were obtained

by terrorism, and of course the same value cannot be placed upon this as on the previous expression of national confidence. L. N. was now emperor in fact; nothing was wanting but the name. This was assumed exactly a year after the *coup d'état*, in accordance, as it appeared, with the actual wish of the people. The principal political events of his reign since then have been the conspiracies against him (1853), the attempts at assassination (by Pianori, 1855, and Orsini, 1858), the Anglo-French alliance and the Crimean war (1854—1856), and still more recently the Franco-Italian war (1859), in which the French and Sardinians wrested Lombardy from Austria, and the overthrow of the Mexican republic (1863). On the 30th January 1863, the emperor married Eugénie Marie, Countess of Montijo, a Spanish lady of distinguished beauty; from this union has sprung one child, the prince imperial, born 16th March 1856. Different opinions are entertained in regard to the *régime* of Louis Napoléon. The apologists of the emperor can, however, point to the immense strides which French trade has made under his rule; to the enlightened principles of commercial intercourse which he has adopted, in spite of the ignorance of his subjects; to the vast extension of railways, the magnificence of the public buildings, and the uniform desire which he has shewn to ascertain and carry out the real wishes of the French people.

LOUIS PHILIPPE, King of the French, born at Paris, 6th October 1773, was the eldest son of Louis Philippe Joseph, Duke of Orleans. He received at his birth the title of Duke of Valois, and afterwards that of Duke of Chartres. His education was intrusted to the care of the celebrated Madame de Genlis. He entered the National Guard, and became a member of the Club of Friends of the Constitution, afterwards that of the Jacobins. Along with his father, he renounced his titles, and assumed the surname of Egalité. He shewed both courage and capacity in the war; but his situation became very dangerous after the unsuccessful battle of Neerwinden, in which he commanded the centre. He was included in the order for arrest issued against Dumouriez, and on the 4th April 1793 escaped along with him into the Austrian territory. He sought in Switzerland a place of security for his sister Adelaide, wandered about amongst the mountains for four months, and accepted a situation as teacher of geography and mathematics in a school at Reichenau, near Chur, assuming the name of Chabaud-Latour. He afterwards wandered for some time in the north of Europe, and then went to North America. In 1800, he took up his abode at Twickenham, near London, with his two younger brothers, both of whom soon after died. In 1809, he married Marie Amélie, daughter of Ferdinand I. of the Two Sicilies. On the fall of Napoleon, he hastened to Paris, where he was received with distrust by Louis XVIII. After the second Restoration, he recovered his great estates, which the imperial government had sequestered. Disliked by the court, he was very popular in Paris. He kept aloof, however, from political intrigues; and the three bloody days of the revolution of 1830 were nearly over ere he was brought forward, the banker, Lafitte, proposing in the provisional committee his appointment as lieutenant-general of the kingdom, from which he proceeded to the acceptance of a constitutional throne, 9th August 1830. He defended his conduct towards the elder Bourbons by protesting that he acted for the welfare of France. He cultivated peaceful relations with foreign powers, sought to strengthen his throne by gaining the support of the middle classes, and repressed all the extreme parties by what became known as the *Juste-milieu* (q. v.)

policy. The extreme democrats hated him, and frequent attempts were made on his life, by *infernal machines* and otherwise. The country prospered under his government, but a demand for reform in the electoral system became loud and general, and was unwisely opposed by the king and the Guizot (q. v.) ministry; whilst the conduct of the former in the matter of the marriages of the queen of Spain and her sister, manifesting a disregard of every consideration but the interests of his own family, excited a strong feeling of indignation throughout Europe. The French nation became much excited; 'reform banquets' began to be held; the government attempted to prevent them by force; insurrectionary movements ensued in the streets of Paris on 22d February 1848; and the 'Citizen King' saw with alarm that the National Guard could not be expected to support him. On 24th February, he abdicated in favour of his grandson, the Count de Paris; but the Chamber of Deputies refused to acknowledge the boy as king. L. P., deserted by his courtiers, fled to the coast of Normandy along with his queen, concealed himself for some days, and at length found opportunity of escaping in a British steam-boat to Newhaven under the name of Mr Smith. The brief remainder of his life was spent in England. He died at Claremont, 26th August 1850.

LOUIS-D'OR (i. e., *Golden Louis*), a gold coin which was introduced into France in 1641, and continued to be coined till 1795. It was introduced in consequence of the prevalent custom of clipping and otherwise defacing the then coins of the realm, from which malpractices it was thought to be in some measure secured by its border. The old coins were called in. The louis-d'or ranged in value from about 16s. 7d. to 18s. 9½d. sterling. Some louis-d'ors bear special names, chiefly derived from the figure exhibited on the obverse side.—In some parts of Germany, the larger gold pieces, of five thalers or thereby, are often popularly called *louis-d'or*, and the name is also occasionally applied to the French *napoleon* or 20-franc piece.

LOUISIANA, one of the United States of America, bounded on the south by the Gulf of Mexico; and on the west by the state of Texas. It is 290 miles from east to west, and 200 from north to south, having an area of 41,255 square miles, or 26,403,290 acres. The principal rivers are the Mississippi—which has a course of 800 miles in this state, and whose delta traverses its southern half—Red River and the Washita, and their branches. The principal towns are New Orleans, and Baton Rouge, the capital, on the Mississippi. The coastline, a portion of the shore of the Gulf of Mexico, is 1256 miles in length. The surface is flat, rising nowhere more than 200 feet, and of alluvial formation. A large portion of the state is below the high-water level of the rivers, and is protected by dikes, called *levees*, from inundations. The land is generally of great richness, producing sugar-cane, cotton, rice, maize, tobacco, oranges, bananas, figs, peaches, &c. In the forests are several kinds of oak, hickory, locust, saasafra, mulberry, &c. The state has produced in a year 300,000,000 lbs. of sugar, 268,000 bales of cotton, 10,000,000 bushels of maize. The commerce of the state through New Orleans is very extensive. There are 6 colleges, 143 academies, 664 public schools, 307 churches, 55 periodicals, 10 public libraries. L. was settled by the French in 1699; in 1716, it was granted to John Law, who based upon his grant the famous Mississippi Company; ceded to Spain in 1762; re-ceded to Napoleon I. in 1800; purchased in 1803 by the United States, for 15,000,000 dollars,

and admitted as a state in 1812. Invaded by the British troops in 1814, under General Paakenham, New Orleans was successfully defended by General Jackson. The population, largely of French descent, called Creoles, was in 1860, free, 376,280; slave, 333,010—total, 709,290.

LOUISVILLE, a city of Kentucky, United States of America, on the Falls of the Ohio, 130 miles below Cincinnati. It is handsomely built, with broad streets, on a level plain. Main Street is three miles long. The city is supplied with water from the Ohio, and by artesian wells, one of which has a depth of 2086 feet, a three-inch bore, and supplies 330,000 gallons of water in 24 hours, which rises to a height of 170 feet. The court-house cost 1,000,000 dollars. There is a fine custom-house, jail, marine asylums, 8 orphan asylums, 60 churches, 2 synagogues, 5 daily, and 12 weekly papers, 8 pork-packing establishments, employing 1200 men, large hemp and tobacco factories, and a commerce of 100,000,000 dollars per annum. Steamers pass over the rapids of the Ohio at high water, but at other times pass through a canal and locks. Pop. in 1860, 69,740.—It was named L. (1780) in honour of Louis XVI. of France, whose troops were then assisting the Americans in the war of independence.

LOUSE (*Pediculus*), a genus of insects, the type of a very numerous family, which forms the order *Parasita* or *Anophura*. The body is flattened, almost transparent; the segments both of the thorax and abdomen very distinct; the mouth is small and tubular, enclosing a sucker; there are no wings; the legs are short, and are terminated by a claw adapted for taking hold of hairs or feathers. The eyes are simple, one or two on each side of the head. All the species are small, and live parasitically, on human beings, terrestrial mammals, and birds. They deposit their eggs on hairs or feathers, to

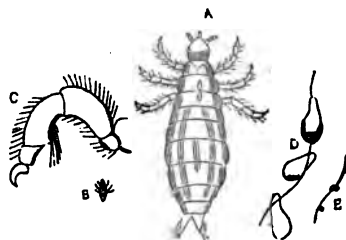

Louse:

A, louse, magnified; B, louse, natural size; C, one of the legs, magnified; D, eggs, magnified; E, eggs, natural size.

which they attach them by a glutinous substance; and they multiply with astonishing rapidity. The young cast their skin several times before they reach their maturity, which in the best known species is said to be about eighteen days after they are hatched, but, from the first, they are very similar to their parents. Animals of different kinds are infested by different species of L. peculiar to them; those which are found on birds exhibiting characters considerably different from those of man and mammals. The same species is rarely found on different species of animals, unless very nearly allied; but some animals have more than one of these parasites. Three infest the human race: one confined to the head, the COMMON L. (*P. capitis*); another, the BODY L. (*P. vestimenti s. corporis*), very similar to it, but of a larger size; a third, the CRAB L. (*Phthirus pubis*), sometimes

found in the eyebrows, but more frequently in the pubic region, and chiefly in persons of licentious habits; having the body broader, and other characters considerably different from the other two. The common or head L. is a very common parasite. The symptoms which the bites of these insects produce are a troublesome itching, and a more or less apparent eruption upon the scalp, the eruption being usually accompanied by small incrustations of blood produced by scratching off the epidermis. On examining the head, in addition to the insects, numerous eggs called *nits* are found, which are of a pyriform shape, and adhere firmly to the hairs. In six days, the young escape from the egg; at the age of eighteen days, these are again ready to lay eggs; and the female lays fifty eggs in all; so that the rapid augmentation of these insects is easily accounted for. When only a few lice are present, they may be removed by careful combing, or may be killed by the free application of oil or pomatum to the head; but when they are abundant, the scalp should be sprinkled with the Persian insect-powder (*Pyrethrum caucaseum*), which, according to Küchenmeister, soon kills them, or rubbed with white precipitate ointment, which is the most common remedy in this country.

The body L. causes most irritation on those parts of the skin which correspond with the folds and seams of the clothing about the neck and round the waist where the clothes are fastened to the body. The irritation is of the same character as that caused by the preceding species, and the treatment is similar. It is said that the clothes may be purified by burying them in hay for several weeks, but the safer plan is to destroy them. The irritation caused by the crab L. is greater than that caused by the other species. It may be destroyed by one or two applications of an essential oil (oil of rosemary, for example), or of white precipitate ointment.

Whether the *Pediculus tabescentium*, or L. occurring in the *Lousy disease*, is or is not a distinct species, is still an open question. Indeed, the fabulous element enters so largely into most of the recorded cases of this disease—as, for example, when *Amatus Lusitanus* relates that two slaves were incessantly employed in conveying to the sea in baskets the lice which appeared on the body of their master—that the question is of comparatively little importance.

An interesting question has been raised with regard to the lice infesting human beings, it being alleged, by those who desire to establish the essential diversity of certain races, and particularly by Americans anxious to make out the widest possible difference between the European race and negroes, that the lice found on different races are specifically different. The subject has been examined with great care by Mr Murray of Conland, and with evident impartiality; the result being, as appears from his paper in the *Transactions of the Royal Society of Edinburgh*, 1860—1861, that the differences among these parasites are like those among the races of men themselves, easily observed, but not certainly specific.

LOUTH, a maritime county of the province of Leinster, in Ireland, bounded N. by Armagh and by the Lough of Carlingford, E. by the English Channel, S. by the Boyne and the county of Meath, and W. by Meath and Monaghan. Pop. (1861) 75,140, of whom 69,100 were Roman Catholics, 4998 Protestants of the Established Church, the rest Protestants of other denominations. Its total area is 315 square miles, or 201,434 acres. The surface is flat, with the exception of the lofty range on the north, which stretches east and west, and terminates, at a height of 1935 feet, in Carlingford

Mountain, overlooking the bay of that name. This range consists of a granite nucleus, supporting limestone and clay-slate on its flanks. The soil of the level districts is extremely fertile, and eminently suited for wheat-crops. The total acreage under crop in 1862 was 109,998. The cattle in the same year numbered 29,648; sheep, 45,805; pigs, 13,466. The chief rivers are the Boyne (its boundary on the south), the Fane, the Glyde, and the Dundalk River. The chief towns are Drogheda, Dundalk, and Ardea. The chief occupations are agricultural. L. anciently formed portion of the territory of Oriel or Or-gial, but was occupied by De Courcy, and formed into a county by King John in 1210. It was early apportioned among the military adventurers who accompanied De Courcy and De Lacy; but most of these original settlers have been displaced by later confiscations and apportionments of territory, especially after 1641 and 1690. It abounds with Celtic antiquities, some of which, in the neighbourhood of Dundalk, are of great interest. The ecclesiastical antiquities are very striking. There are two round towers, at Monaster-boyce and at Dromiskin. At Mellifont are the remains of a beautiful abbey. In Drogheda, several ruined abbeys are still visible, as also at Louth and Carlingford. But the most interesting of all the relics of antiquity in L. are the celebrated sculptured crosses of Monaster-boyce, of which the larger is 18 feet in height. The county of L. returns two members to the imperial parliament.

LOUTH, a large market-town and municipal borough of England, in the county of Lincoln, 25 miles east-north-east of the city of that name, on the Ludd. It contains a recently erected mansion house, with a court-house and assembly-room; a beautiful parish church of the latter part of the 14th c., with a rich octagonal spire 300 feet in height; and a grammar-school, with an endowed annual income of £620 a year. Iron foundries, tanneries, oil-cake mills, and carpet factories are in operation. By means of the canal, extending between L. and Tetney Haven on the estuary of the Humber, considerable traffic in corn and coal is carried on. Pop. (1861) 10,560.

LOUVAIN (Ger. *Löwen*, Flemish, *Leuven*), a city of Belgium, in the province of Brabant, on the Dyle, 16 miles east-north-east of Brussels. It is of considerable extent, but great part of the ground is occupied with fields and gardens. Pop. 30,765. It was at one time much larger. During the 14th c., when it was the capital of the duchy of Brabant, it contained 200,000 inhabitants, and 4000 cloth manufactories. The citizens, however, endeavouring, in the latter part of the 14th c., to assert their independence, along with those of other towns of Flanders, were defeated; and many of the weavers from whose industry the city had in a great measure derived its wealth and importance, took refuge in England, and thus contributed not a little to the prosperity of that country. L. has never recovered from the blow which it then received. It is not now a place of much manufacturing or commercial activity, but has very large breweries, and some tobacco and lace manufactories, &c. The university, founded in 1426 by Duke John of Brabant, was, in the 16th c., regarded as the greatest in Europe, particularly excelling in the department of Roman Catholic theology. It had more than 6000 students. It was suppressed for some time, in consequence of the French Revolution, but restored by the Dutch government in 1817. The state relinquished it again in 1834, but the Roman Catholic clergy restored it at their own expense in 1835.

It has a large library and a botanic garden. The students in 1850 amounted to 612.

LOUVIERS, a town of France, dep. of Eure, on the navigable river Eure, 60 miles north-west of Paris. It has a cathedral, and celebrated cloth-manufactures, the annual value of which is between three and four million francs. Pop. 10,600.

LOUVOIS, **FRANÇOIS MICHEL LETELLIER**, **MARQUIS DE**, the war-minister of Louis XIV., was born in Paris, 18th January 1641. His father was Chancellor and Secretary of State in the war department, and purchased for him the reversion of this office. L. displayed great administrative ability; but his desire of power was insatiable, and he was willing to involve the whole world in the horrors of war, that he himself might be indispensable to the king. His war-policy was also ruthless. He caused the Palatinate to be wasted by fire and sword in 1674. For some time, he was, after the king himself, the most powerful man in France. After the death of Colbert, financial affairs came under his control, and the system of extortion and borrowing which he pursued was amongst the causes of the Revolution. He partially lost favour with the king by counselling him against the marriage with Madame de Maintenon; but afterwards instigated the persecution of the Protestants, and involved France in the long war with the German empire, 1688—1697. In 1689, with the alleged view of securing the confines of the kingdom, he again caused the Palatinate to be desolated. Madame de Maintenon directed the attention of the king to these atrocities, who thereupon forbade the burning of Treves; but L. declared that, to save trouble to the king's conscience, he had already issued orders for reducing that city to ashes. The king, upon hearing this reply, seized the tongs from the chimney, and would have struck his minister with that ready weapon, if Madame de Maintenon had not stepped between. Such scenes were repeated from time to time, and the health of the vain and ambitious minister gave way. He died suddenly, 16th July 1691. Louis is said to have rejoiced at his death.—The first two volumes of an elaborate history of L.'s administration, from original documents in the archives of the Dépôt de la Guerre, by Camille Rousset, appeared in 1862 (Paris, Didier).

LOUVRE (Fr. *Louvert*, the opening), an ornamental opening of a turret shape, placed on the

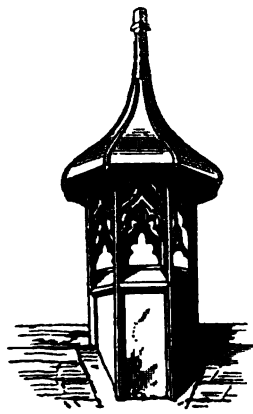

Louvre.

roof, to allow the smoke or foul air to escape from large apartments, such as halls, kitchens, &c. These were particularly required in ancient times, when the fire was placed in the centre of the room, and there was no chimney to carry off the smoke. They are frequently used as ornaments where not required for use, and are then glazed and made into Lanterns (q. v.). The sides of the louvre were lined with horizontal overlapped boarding, with a space between the boards, which let out

the smoke without

admitting the rain. Hence, this sort of boarding, frequently used for the windows of bell-towers, &c., acquired the name of *louvre-boarding*.

LOVAGE (*Ligusticum*), a genus of plants of the natural order *Umbellifera*, allied to *Angelica*, the fruit elliptical, each carpel with five sharp somewhat winged ribs, and many vittæ in the interstices.—**COMMON L.** (*L. officinale*, or *L. Levisticum*) is a native of the south of Europe, with ternate compound leaves, and obovate-wedge-shaped leaflets. It is sometimes cultivated in gardens, and notwithstanding its strong and peculiar odour, is used as a salad plant. Its roots and seeds are aromatic, acrid, and stimulant, and are used to cure flatulency and to excite perspiration. A liqueur called *Lovage* is made from them.—Very similar in appearance and qualities is the only British species, **SCOTTISH L.** (*L. Scoticum*), a native of the sea-coasts in the northern parts of Britain. It is eaten, both raw and boiled, by the Shetlanders. The flavour is aromatic, but acrid, and very nauseous to many who are unaccustomed to it.

LOVAT, a river of Russia, rises in the Witebsk marshes, and flows through the governments of Pskov and Novgorod into Lake Ilmen. Its total length is 267 miles, and it is navigable for barges of fifty tons as far up as Kholm, more than eighty miles from its mouth.

LOVAT, **SIMON FRASER**, **LORD**, was born about the year 1676, and was the second son of Thomas Fraser, fourth son of Hugh, ninth Lord Lovat. His mother was Sybilla, daughter of the chief of the Macleods. The Frasers, a family of Norman origin, had obtained Highland territories, in the county of Inverness, in the 13th c., and had established themselves as the patriarchal chiefs of the Celtic inhabitants within these territories, rather than as landlords, in the feudal acceptation of the term. The first settler—or, more probably, the first who gained renown—was named Simon, and hence his descendants were called sons of Simon, or M'Shime. The descendant here commemorated had little hope of succeeding to the estates and honours, until the prospect opened to him under a settlement by his cousin, Lord Lovat. The succession was not indisputable, but until a much later period in the Highlands, influence with the clan often superseded direct hereditary descent. Simon at an early period gained their hearts. His first adventure was an effort to get forcible possession of the young sister of the late lord, who had more legal claims, as heiress to the Fraser estates. Baffled in this, he, for a reason which has defied all attempts to discover, seized on the widow of the late lord, a lady of the Athole family, and compelled her to marry him. As this was not only a crime, but an offence to a powerful family, Simon could only protect himself from punishment by force, and thus he kept up a petty rebellion for some years. On the accession of Queen Anne, when his opponents became all-powerful, he fled to the continent. He was at the bottom of the affair called the Queensberry Plot in 1703, in which he professed to reveal the policy of the exiled court, and a plan for a rising in their favour among the Highlanders. On the discovery that he had hoaxed Queensberry and other statesmen, and was playing a deep game of his own, he escaped with difficulty to France. Of the method of his existence there during twelve years, there are only mysterious rumours, by one of which he was reputed to have taken orders as a Romish priest. He had been outlawed for his outrages, and another enjoyed his estates by the letter of the law; but he was still the darling of his clan, and on the breaking out of the insurrection of 1715, they sent a sort of ambassador to bring him over. What followed is remarkable, as shewing that the Highlanders were led by the politics of

their chiefs, not by their own prepossessions. The holder of the estates having joined the insurrection, Simon found it his interest to take the government side. His clan at once left the insurgents; and for this good service he was invested with the estates, not only by the votes of his clan, but by the law. His life, for the ensuing thirty years, was active with local intrigues calculated to strengthen his influence. In the insurrection of 1745, he tried to play a double game—sending forth his clan, under the command of his son, to fight for the Pretender, and deeply plotting for that cause, while he professed to be a loyal subject. He was a special object of the vengeance of the government, and after a trial by his peers, was beheaded on the 9th of April 1747. He was remarkable as a type of that class of Highland chiefs who professed to be led by policy as sovereigns, rather than by the laws of the country or its social system, and who were ashamed of no turpitude, fraud, or violence, if it tended to the aggrandisement of themselves and their clans.

LOVE-APPLE. See TOMATO.

LOVE-BIRD (*Psittacula*), a genus of birds of the parrot family (*Psittacidae*); a group of beautiful and very small species, natives of the warm parts of America, of Africa, and Australia. They receive their name from the affection which they manifest towards one another, whether in a wild state or in a cage. An Australian species, about the size of a sparrow, is now common as a cage-bird in Britain. They are lively birds, and fond of being caressed. They feed on the seeds, &c., on which canaries are fed, and are very fond of chickweed and other plants, with seeds ripe or nearly so.—Anatomically, this genus is remarkable in the parrot tribe for having no *furcula* (merrythought bone).

LOVE-FEASTS. See AGAPE.

LOVICZ, an ancient town of Poland, on the Baura, a tributary of the Vistula, 45 miles west-south-west of Warsaw, is mentioned in history as early as 1136. About 1355, it became a favourite residence of the primates of Poland. It has taken a prominent part in the political revolutions of the country. Pop. 5825. Six fairs are held here annually.

LOWE, SIR HUDSON, was born at Galway, 28th July 1769. His childhood was spent in the West Indies, where his father held a military appointment. L. returned to England when in his twelfth year. Having entered the army, he served for some time in Corsica, subsequently at Lisbon and in Minorca. On the renewal of the French war, after the Peace of Amiens, he was appointed to the chief military command in the island of Capri. He was here unsuccessful, being obliged to surrender to the French, 16th October 1808. He served for some time in the north of Europe, and in Germany under Blücher. On the 23d August 1815, he was appointed governor of St Helena, with the rank of lieutenant-general. Previous to leaving England, he married, in January 1816, Susan, widow of Colonel William Johnson. He arrived in St Helena on 14th April 1816, Napoleon having been landed there on the 17th October of the previous year. It is impossible to conceive a situation in which the adequate discharge of a public duty more surely involved a heavy amount of private care and public obloquy than that which had fallen to Lowe. Had he for a single hour relaxed the necessary vigilance, his own impeachment and another European war might have been the consequence. On the other hand, the due exercise of this vigilance entailed upon him every kind of annoyance which the peevish and irritable

captive had it in his power to give. Even were it true that he exercised a needless severity in guarding Napoleon, this might readily be excused when we consider how often it must have been utterly impossible for him to know what was unnecessary and what was not, and of how little consequence was the convenience of one man, who had already broken his parole, compared with the security of the whole world. On the death of Bonaparte, L. returned to England, where his eminent services met with a very ungrateful return. In 1825, he was appointed military commander in Ceylon, from whence he returned to England, in order to refute the charges brought against him by O'Meara and others. He died at London in very poor circumstances, in the 65th year of his age, 10th January 1844.

LOWELL, JAMES RUSSELL, an American poet, was born in Boston in 1819. He was educated at Harvard University, and took his degree there. He afterwards devoted himself to legal studies, but does not seem ever to have practised. In 1841, he published a volume of miscellaneous poems, and his *Legend of Brittany* appeared in 1844. In 1845, he published a prose work entitled *Conversations on some of the Old Poets*. His best works are: *A Fable for Critics*, in which the American writers are passed in review, and *The Biglow Papers*, a collection of political poems, racy with Yankee humour and dialect. A second series, full of 'Union' sentiments, was published in 1862. His works are known in England, where they have been republished.

LOWELL, a city of Massachusetts, United States of America, on the Merrimac River, 25 miles north-west of Boston. Here the Pawtucket Falls, of 30 feet, afford water-power for the factories which have given to this town the name of the 'Manchester of America.' The canal is owned by a company, which erected extensive machine-shops, and has built the factories for eleven 'corporations,' manufacturing cotton goods, prints, woollens, carpets, &c., consuming 25,000,000 lbs. of cotton per annum. L. was incorporated in 1826. The operatives were for years gathered from the rural districts fifty or a hundred miles round, and lived in boarding-houses built and owned by the corporations, and kept under strict management. Foreign emigration has brought a large resident manufacturing population. L. has several banks, daily and weekly newspapers, literary institutions, about thirty churches, and extensive educational establishments. Pop. in 1860, 36,827.

LOWESTOFT, a seaport and bathing-place, in the county of Suffolk, is situated on a height sloping gradually to the sea, 25 miles south-east of Norwich. There are here two light-houses, one on the height or cliff, the other to the south of the town, in a lower locality. A profitable fishery is carried on: soles, mackerel, and herrings being caught in great numbers. The harbour of L. is spacious. Ropes and twine are manufactured. Pop. (1861) 10,663. L. is the most easterly town of England.

LOWTH, ROBERT, D.D., an English prelate, son of the Rev. William Lowth, rector of Buriton, in Hampshire, was born November 27, 1710. He was educated at Winchester School, whence, with a reputation both as a scholar and poet, he passed to New College, Oxford, in 1730. Here he continued to distinguish himself, took his degree of M.A. in 1737, and only four years after, was appointed professor of poetry. In 1750, Bishop Hoadley conferred on him the archdeaconry of Winchester, and in 1753, the rectory of East Woodhay, in Hampshire. During the same year, he published in Latin his excellent *Lectures on Hebrew Poetry* (*De Sacra Poesi*

Hebraeorum Protectiones Academicæ). It was greatly admired both in England and on the continent, where the celebrated Michaelis republished it with notes and emendations. These were incorporated by L. himself in a second edition, 1762. A new edition was published by Rosenmüller (Leip. 1815). In 1754, L. received from the university of Oxford the degree of D.D., became Prebendary of Durham and Rector of Sedgfield in 1755, a Fellow of the Royal Societies of London and Göttingen in 1765, Bishop of St Davids in 1766, of Oxford a few months after, of London in 1777, and died November 3, 1787. Besides his lectures, his two principal works are *Life of William of Wykeham* (1758) and *Isaiah, a new Translation, with a Preliminary Dissertation, and Notes, Critical, Philological, and Explanatory* (1778; German edition, by Koppe, Gött. 1779; third edition in English, 1842); a work rather too elegant and ornate as a version, but of great value as a means of correcting the numerous blunders of the 'Authorised Version,' and of exhibiting how thoroughly literary and artistic is that section of Hebrew poetry which we call prophecy.

LOXODROMIC LINES (Gr. *loxos*, oblique, and *dromos*, course) are curves of double curvature on the surface of a sphere or spheroid, which have the property of cutting all meridians at the same angle. The course of a ship which is sailing in an oblique direction always to one point of the compass, is a loxodromic line, or, in nautical phrase, a *rumb line*. These lines appear as straight lines on *Mercator's Projection* (see MAP). A ship sailing obliquely to the direction of the north pole (say, two points off) would wind round it in infinite circuits, always approaching nearer, but never reaching it. In this property, as well as in others, the loxodromic line is analogous to the common logarithmic spiral.

LOYOLA, IGNATIUS DE (INIGO LOPES DE RECALDE), the youngest son of Bertram de Loyola and Marina Salex de Baldi, was born in the year 1491 at his ancestral castle of Loyola, in the Basque Provinces. After the scant training of that age in letters, he was received as a page in the court of Ferdinand; but the restraint and inactivity of court-life were distasteful to his enthusiastic mind, and, under the auspices of his relative, Don Antonio Manriquez, Duke of Najara, he embraced the profession of arms. The details of his career as a soldier are of little importance in his history, although they display in a very marked way both the excellency and the irregularities of his ardent temperament, thrown undirected among the temptations as well as the duties of a military life. Of his bravery and chivalrous spirit, many remarkable instances are recorded, and one of these proved the turning-point of his career. In the defence of Pampeluna, he was severely wounded in both legs, one being fractured by a cannon-ball, and the other injured by a splinter, and having been taken prisoner by the French, was by them conveyed to his paternal castle of Loyola, where he was doomed to a long and painful confinement. After a very painful operation, the results of which had well-nigh proved fatal, he eventually recovered; and with his returning strength he appears to have resumed his old thoughts and his habitual levity, for, in order to remove a deformity which had resulted from the first setting of his wounded limb, he consented to the painful remedy of having it re-broken in order to be re-set. After this operation, his convalescence was even more slow; and the stock of romances, by which he was wont to relieve the tedium of confinement, having been exhausted, he was thrown upon the only other available reading, that of the *Lives of the Saints*.

The result was what might be expected in so ardent a temperament—the creation of a spiritual enthusiasm equally intense in degree, although in kind very different from that by which he had hitherto been drawn to feats of chivalry. The spiritual glories of St Francis or St Dominic now took, in his aspirations, the place which had been before held by the knights of mediæval romance. With souls like his there is no middle course: he threw himself, with all the fire of his temperament, upon the new aspirations which these thoughts engendered. Renouncing the pursuit of arms, and with it all other worldly plans, he tore himself from home and friends, and resolved to prepare himself for the new course which he contemplated by a pilgrimage to Jerusalem. With a view to his immediate preparation for this holy task, he retired in the garb of a beggar to the celebrated monastery of Montserrat, where, on the vigil of the Feast of the Annunciation, in 1522, he hung up his arms, as at once a votive offering significative of his renunciation of the works of the flesh, and an emblem of his entire devotion to the spiritual warfare to which he was from that moment vowed. From Montserrat he set out bare-footed on his pilgrimage, the first step of which was a voluntary engagement which he undertook to serve the poor and sick in the hospital of the neighbouring town of Manresa. There his zeal and devotion attracted such notice that he withdrew to a solitary cavern in the vicinity, where he pursued alone his course of self-prescribed austerity, until he was carried back, utterly exhausted, to the hospital in which he had before served. To this physical exhaustion succeeded a state of mental depression, amounting almost to despair, from which, however, he arose with spiritual powers renewed and invigorated by the very struggle. From Manresa he repaired by Barcelona to Rome, whence, after receiving the papal benediction from Adrian VI., he proceeded on foot, and as a mendicant, to Venice, and there embarked for Cyprus and the Holy Land. He would gladly have remained at Jerusalem, and devoted himself to the propagation of the gospel among the infidels; but not being encouraged in this design by the local authorities, he returned to Venice and Barcelona in 1524. Taught by his first failure, he now resolved to prepare himself by study for the work of religious teaching, and with this view, was not ashamed to return, at the age of 33, to the study of the very rudiments of grammar. He followed up these elementary studies by a further course, first at the new university of Alcalá, and afterwards at Salamanca, in both which places, however, he incurred the censure of the authorities by some unauthorised attempts at religious teaching in public, and eventually he was induced to repair to Paris for the completion of the studies thus repeatedly interrupted. Here, again, he continued persistently to struggle on without any resources but those which he drew from the charity of the faithful; and here, again, he returned to the same humble elementary studies. It was while engaged in these studies, and among the companions of them, that he first formed the pious fraternity which resulted in that great organisation which has exercised such influence upon the religious, moral, and social condition of the modern world. From the close of his residence in Paris, L.'s history has been told in the history of his order. See JESUITS. From the date of his election as the first general of his society, he continued to reside in Rome. To him are due not alone in the general spirit, but even in most of their details, all its rules and constitutions; from him also originated several works of general charity and benevolence, the germs of great institutions still maintained in

Rome; but the great source of his influence upon the spiritual interests of the world is his well-known *Exercitia Spiritualia*, of which an account has been already given. He died at Rome, it may well be believed, prematurely, being worn out by his long-continued austerities, July 31, 1556. His name was admitted to what is known in the Church of Rome as the preliminary step of beatification, in the year 1609, and he was solemnly canonised as a saint by Gregory XV. in 1622. His life has been written in almost every European language. The biographies of Ribadaneira, of Maffei, of Bartoli, and Bouhours are the best known and the most popular among Roman Catholics.

LOZENGE, in Heraldry, a charge generally enumerated among the sub-ordinaries, in the shape of a rhombus placed with the acute angles at top and bottom. The horizontal diameter must be at least equal to the sides, otherwise, it is not a lozenge, but a Fusil (q. v.) The term *lozenzy* is applied

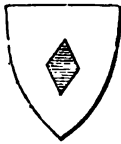

to a field divided by diagonal lines crossing one another at regular intervals, so as to form a diamond pattern, the compartments being of alternate tinctures.

LOZENGES are employed in medical practice in those cases in which it is desired that the remedy should pass gradually into the stomach, in order to act as much and as long as possible upon the pharynx and the laryngeal opening; as, for example, in cases of relaxed or inflamed states of the tonsils and uvula, in chronic coughs, &c. According to Dr Paris (*Pharmacologia*, 9th ed. p. 555), lozenges should be composed of several demulcent substances, such as farinaceous matter, sugar, gum, and isinglass, since such a mixture retards as long as possible their solution. Lozenges are flat and circular or oval in form, and the chief difference between lozenges and the closely allied substances known as *drops*, is, that in the latter the sugar is rendered fluid by means of heat, while in the former the ingredients are combined without the aid of heat.

LOZÈRE, a department in the south of France, derives its name from Mount Lozère, one of the summits of the Cevennes (q. v.), and is formed out of the province of Languedoc. It comprises the arrondissements of Mende, Florac, and Marvejols. Area, 1,276,756; pop. (1862) 137,367, among whom are many Protestants. The department is mountainous, the central mass of the Cevennes, here called the Margeride Mountains, occupying the whole of the east and south-east portions. In the mountains, the climate is severe and variable, and little grain is produced; but the slopes on the southern side of the Cevennes, looking towards the valley of the Rhone, are clothed with the mulberry, the olive, and the vine. Wolves abound in the forests, which are extensive. Cattle, sheep, and mules are reared and exported in considerable numbers; but the real prosperity of the department arises from its mines, which yield iron, antimony, lead, copper, silver, and some gold. Capital, Mende.

LÜ'BECK, one of the four remaining free cities of Germany, is situated on the river Trave, about 40 miles north-east of Hamburg, and 14 from the Baltic. It is built on a rising ground, and its appearance with its walls and ramparts still partly standing, its great gates, its proud towers, its Gothic churches, and its antique gabled houses is still almost medieval. Its principal buildings are St Mary's Church (*Die Marienkirche*), one of the most beautiful

specimens of Gothic architecture in the north of Europe, finished in 1304, with three naves, the central one 119 feet in length, and two towers, 382 feet high; the town-house, containing the Hanseatic archives and a public library of 50,000 volumes, built of red and black glazed tiles; the cathedral, built 1170—1341; the monastery church, also a masterpiece of Gothic; the exchange, and the banks. L. is rich in educational establishments of all kinds, religious and secular—the number within the city amounting to 54, while in the suburbs there are no less than 37, in all 91. The provision for the poor is excellent, on account of the large bequests that citizens have made at different periods for this purpose, the largest benevolent institution being the Hospital of the Holy Ghost. The industrial activity of L. is considerable. Ship-building and engineering are carried on; there are also about 60 breweries and important cigar-manufactories; yet in the old days when the Hanseatic League was flourishing, the Merchant Company or College could reckon 5000 members, while in 1859 it had only 471. In 1860, 1134 ships (of which more than 300 were steamers) entered the harbour, and 1151 cleared, of which about 60 belong to the Lübeckers themselves. The chief imports are wine, silks, cottons, earthenware, pigments, colonial products, and timber from Sweden and Finland; the chief exports are grain, cattle, iron, and wool. The harbour lies 16 or 17 miles down the river, at Travemünde, a bathing-place, although the river has of late years been so much deepened, that the largest ships can come up to Lübeck. Pop. of town and suburbs (in 1857), 30,717; of the scattered spots of territory in the duchy of Holstein, under the jurisdiction of L., 18,765. In 1860, both its revenue and expenditure amounted to £68,847.

L. has existed since the 11th c., and received important privileges from the German emperors in the 12th c., which were confirmed by the Danes, into whose power it fell in 1201. It was declared a free city of the empire in 1226, and thereafter maintained its independence against the Danes, and joined the other commercial towns in the great Hanseatic League (q. v.). With the decline of the Hanseatic League, L. lost its historic importance, but continued a flourishing and independent commercial city, till it was taken and plundered by the French, November 6, 1806. Its trade suffered also grievously from the French Continental System. In 1810 it was incorporated with the French empire. It recovered its independence in 1813, and is now a member of the German Confederacy. Its trade has also revived; and the railway connection with Hamburg, and lines of steamers to ports of the Baltic, have contributed much to the increase of its prosperity.

Constitution.—The constitution, which was anciently aristocratic, has been democratic since 1669. The government is intrusted to a senate, which consisted, till 1851, of twenty members; but since that year, of only fourteen, who, in legislative and also in certain administrative functions, require the concurrence of the municipality or council of citizens, a body comprising 120 members. The supreme court of appeal for the free cities is in L., and Lübeck Law (*Lübisches Recht*) is of acknowledged authority in many questions.

L'UBLIN, the capital of the Polish government of the same name, on the left bank of the Bistritz, a feeder of the Wieprz, a branch of the Vistula, is 96 miles south-east of Warsaw. L. dates from the 10th c., and among the objects of interest which it presents to tourists, the church of St Nicholas (founded in 986 A. D.) and the ruins of a royal castle are worth notice. It was formerly

fortified. The chief buildings are the town-hall, the Sobieski palace, cathedral, Jews' synagogue, Piarist college, and several schools and hospitals. It has several manufactories of woollen and linen goods, in which, as well as in corn and Hungarian wine, it carries on an extensive trade. Pop. 19,054. Three large fairs, each lasting one month, are held here annually.

LUCANUS, M. ANNÆUS, the chief Roman poet of the Silver Age, was born at Corduba (the modern *Cordova*), in Spain, 38 A. D., and brought to Rome in his infancy by his father, who was a younger brother of the philosopher Seneca. He received an education of the best kind, was a school-fellow of Persius, and a friend of the Emperor Nero, and entered on life with the most brilliant prospects. He became *quaestor* and *augur*, and declaimed and recited in public with the highest applause. But his prosperity and himself were equally short-lived. He lost the favour of Nero, who was jealous of his poetry and his fame, and who desired to keep down both. Under the sting of this annoyance, he joined the conspiracy against Nero's life in 65 A. D. It is painful to read in Tacitus, that when arrested with others after the betrayal of the plot, he tried to save his life by accusing his mother of complicity. But the emperor did not spare him for the sake of this additional crime; he was compelled to destroy himself by having his veins opened, and he died in this way, and with a certain ambitious composure, at 27 years of age. Whatever the faults of L.'s character—and in the brief notices we have of him, both his vanity and levity are apparent—he holds a conspicuous place among the poets of Rome. The only work of his that has come down is the *Pharsalia*, an epic, in 10 books, on the civil war between Caesar and Pompey. As an epic, it is, as Niebuhr somewhat quaintly says, an 'unfortunate' performance, for it proceeds in the manner of annals, and wants the comprehensiveness, unity, and learning of the greatest works of its class. Nor is its style, generally speaking, good, for it is often turgid and obscure, and marked with those defects of taste which belong to poems inspired by a rhetorical age and school of writing. But when every deduction has been made, the *Pharsalia* affords ample proof that L. was a man of real and powerful genius. There is an eye for the sublime both in the moral and physical worlds, constantly present in it; there is all the vigour of poetic oratory in its declamations; and there are felicities of epigram which have secured to many a line a constant freshness of life, as part of the familiarly remembered literature of the world. L. was very popular in the middle ages; and in modern times, his poem has been a particular favourite among the lovers of political freedom—especially among that school of classical republicans now nearly extinct in Europe, after having played a most important part in it. There is a well-known English translation of L. by Rowe, which Dr Johnson thought one of the best translations in the language.

LUCANUS AND LUCANIDÆ. See **STAG BEEBLE**.

LUCARIS, CYRIL, a Greek theologian, was born in the island of Candia in 1572, studied first at Venice, and afterwards at Padua, and subsequently visited Germany, where he formed intimate relations with the Protestant doctors, and carried back into Greece their spirit and their dogmas. Ordained a priest, he rose, in the course of years, to the highest dignity in the Greek Church, being elected Patriarch of Constantinople in 1621. He still cherished his Protestant opinions, and endeavoured even to promulgate them in the church over which

he ruled; but his conduct excited violent opposition among the clergy, and L. was in consequence banished to Rhodes. Through the influence of the English ambassador, however, he was soon reinstated in his office. Unluckily, a confession of faith he had got printed, quite heretical—i. e., Protestant—in its character, fell into the hands of his adversaries, and he was once more involved in difficulties. In 1636, he was banished to the isle of Tenedos, and though recalled after a few months, in June 1637 he was seized in Constantinople, hurried on board a vessel, and it was never properly ascertained what became of him. According to some, he was strangled in the ship which bore him off; according to others, he suffered this fate in a castle on the shores of the Black Sea. His doctrines have been repeatedly condemned by Greek synods.

LU'CARNE, a Dormer Window (q. v.). The name *lucarne* is generally applied to the small dormers in church spires.

LU'CCA, **DUCHY OF**, formerly a small independent state, now a province of Central Italy, was bounded on the N. by Modena, on the E. and S. by Tuscany, and on the W. by the Gulfs of Genoa and Massa. Area, 512 square miles; pop. 264,478. The surface of the country is very diversified; the largest stream is the Serchio. L. is famed for the extreme fertility of its soil, and the superiority of its agriculture, which serves as a model to the whole Italian peninsula. The principal products are grapes, olives, grain, mulberries, chestnuts, and vegetables. The marshy flats on the coast afford excellent pastures for cattle. The manufactures are silks, oil (esteemed the best in Italy), glass, paper, linens, cottons, &c.; the principal export is oil. The *Luchesi* are a frugal, shrewd race; numbers leave home in search of employment, and they form a large proportion of the itinerant figure-venders, organ-grinders, and stucco-workers of Europe.

L. (anciently called *Luca*) was made a Roman colony in 177 B. C. It was erected into a duchy by the Lombards, and recovered its liberty in 1055, when the chief town, Lucca, became a free city. In 1327 it was a duchy, and was ruled by the celebrated *Castruccio Castracani*. In 1370 it became an independent republic, was erected into a principality in 1805 by Napoleon, for his sister *Elisa Bacciocchi*, and passed to *Maria Louisa of Spain* in 1815. Her son, *Duke Carlo Luigi*, ceded it to Tuscany in 1847, on obtaining possession of Parma and Piacenza; and in 1860 it was annexed to *Sardinia*. It now forms one of the Tuscan provinces in the new kingdom of Italy.

LUCCA, chief town of the Italian province of Lucca, is situated in a fine plain, bounded by picturesque hills, and irrigated by the Serchio, 12 miles north-east of Pisa. Pop. 22,536. The commercial activity of its inhabitants obtained for it the name of 'Lucca l'Industriosa.' Its great trade is in olive-oil and silk, and it was the first place in Italy where the production and manufacture of silk were successfully introduced. The town is surrounded by ramparts, which form a delightful promenade, and command a fine view of the whole valley of the Serchio; the streets are mostly narrow and crooked, but well paved; the private dwellings are commodious, and the public edifices numerous and interesting. The cathedral contains several fine paintings. A splendid aqueduct, planned during the reign of the Princess *Elisa Bonaparte*, and executed later, supplies the town with water, and is highly deserving of inspection. The environs of L. abound in delightful villas. In a charming valley, 15 miles from the town, are situated the famous mineral baths of

Lucca, whose temperature varies from 96° to 136° F. The waters are exported to all parts of Italy.

LUCENA, a town of Spain, province of Cordova, and 40 miles south of the city of that name, is picturesquely situated between two hills. Pop. 13,100. The neighbouring territory is famous for its apricots and its breed of horses. L. is historically interesting, as the scene of the capture (April 21, 1483) of Boabdil, king of Granada.

LUCERA (ancient *Luceria*), a town of Italy, in the Neapolitan province of Capitanata, is situated on an eminence 10 miles west-north-west of Foggia. It contains a college, a good museum, a cathedral, and a splendid episcopal palace. A large trade in cheese and cattle is carried on by the inhabitants. Pop. 13,464. Numerous inscriptions and fragments of ancient sculpture have been found here.

LUCERNE, a canton in the centre of Switzerland, with an area of about 474 square miles, and a population (in 1860) of 130,504, shewing a slight decrease since 1850. The soil is generally fruitful, and much grain and fruit are produced. In the more mountainous parts, the rearing of cattle is carried on to a greater extent than anywhere else in Switzerland. The highest elevation attained by the Alps in this canton is 6900 feet. The principal stream is the Reuss, the principal lake that of Lucerne. The inhabitants are mostly of German race and language, and all belong to the Roman Catholic Church, except about 1600 Protestants, to whom the free exercise of their religion was first accorded in 1828. The constitution of L. is a representative democracy; 100 deputies form the Great Council, whose president bears the title of *Schultheiss* (Judge).

LUCERNE, capital of the canton of the same name, is situated on the Reuss, where it issues from the north-west extremity of the Lake of Lucerne. Near the lake, rising from the middle of the Reuss, is an old tower, which is said to have been once a light-house (*Lucerna*), whence the name of the town. The arsenal is one of the most important in Switzerland, containing many old weapons used at the battle of Sempach. L. has a theatre, a public library, with a collection of natural history, manufactures of silks, cottons, flax, hemp, gloves, &c. Pop. (1860) 11,522.

LUCERNE, LAKE OF, called also the *Lake of the Four Forest Cantons* (Uri, Unterwalden, Schwyz, and Lucerne), because its shores are formed by these, is one of the most beautiful sheets of fresh-water in Switzerland or Europe. Length from Lucerne to Flüelen, about 22 miles; average breadth, about 1½ mile. The chief places on its banks are Lucerne, Küssnacht, and Alpnach, at the north-west, and Flüelen near its south-west extremity. It is navigated by several steam-boats.

LUCERNE (*Medicago sativa*), a species of Medick (q. v.), one of the most valuable of the leguminous plants cultivated for the supply of green food to cattle. It is a native of the south of Europe, and has been cultivated there from an unknown antiquity. It is partially naturalised in some parts of Britain. It is not very largely cultivated in Britain, although in some places very successfully, chiefly in the south of England; but the climate of Scotland is not too cold for it, and the different results obtained by farmers who have tried it seem to depend chiefly on differences of soil and management. It is largely cultivated in some parts of North and South America, and in Peru with great success both on the coast, in all the heat of a tropical climate, and on the mountains to a height

of more than 11,000 feet above the sea; flourishing, however, only during the moister part of the year in the former situation. It endures great droughts, its roots penetrating very deep into the ground; but loves a rich and calcareous soil, and never succeeds on damp soils or tenacious clays. It is a perennial, and affords good crops for a number of years. It is sown in rows, at 12 or 14 inches apart, and may be mown several times in a year, growing very quickly after being mown. The quantity of produce is very great, and no other forage-plant is ready for use so early in spring. L. has a rather erect stem, leaves with three obovate-oblong toothed leaflets; purplish blue or sometimes yellow flowers in many-flowered racemes, and pods twisted two or three times round. It ought to be mown before it comes into flower, as it then becomes more fibrous, and less succulent and nutritious.

LUCIA, St, one of the windward division of the Caribbees (see LEeward ISLANDS), lies about 30 miles to the south of Martinique, having its southern extremity in lat. 13° 41' N., and long. 61° W. The island is of volcanic origin, and the crater of the *Soufriere*, or *Sulphur Mountain*, is still in energetic operation. St L. is remarkable for its picturesque and romantic scenery. Much of the surface is covered with hills, generally well wooded, and occasionally rising to the height of nearly 3000 feet. Area, 300 square miles, or 192,000 acres, of which, in 1860, 9028 acres were under crops; pop. (1860) 27,141, of whom only 720 were whites. As the coast abounds in secure, commodious, and defensible harbours—all the more valuable from their comparative scarcity in the neighbourhood—the island has been, perhaps, to an unexampled extent, an object of contention between France and England. In the hands of the latter, however, it has remained since 1803. From official returns for 1860, are drawn the following statistics. The island contained 18 schools, attended by 1470 scholars. Its revenue was £13,603; its expenditure, £12,151; its public debt, £18,000. 396 vessels, of 25,212 tons, entered and cleared its ports. The imports amounted to £97,900, and the exports to £106,947. The principal exports were 7,968,165 lbs. of sugar, 212,482 lbs. of cocoa, 29,221 gallons of rum, and 122,400 gallons of molasses.

LUCIAN, a classic satirist and humorist of the first merit, was born at Samosata, in Syria, in the earlier part of the 2d c., though the exact year is matter of conjecture. He himself tells us, in a piece called *The Dream*, that his parents were poor, and could not afford him a learned education. He was, in consequence, apprenticed to an uncle who was a statuary, in order that he might learn that trade; but he soon abandoned it, and betook himself to the study of letters. For a long time he led a somewhat vagrant and unsettled life, visiting the most of Greece, Italy, and Gaul, in the last of which countries he practised with great success as a teacher of rhetoric. He is thought to have returned to his native country when about forty years of age, after which time all his master-pieces were composed. The last thing we know about him is, that he was made a procurator of part of Egypt by the Emperor Commodus. He died probably about the end of the 2d century. The statement of Suidas, that L. was torn to pieces by mad dogs on account of his impiety, finds no credence with modern scholars; neither does that of Volaterranus, that he was an apostate from Christianity. The dialogue entitled *Philopatris*, long attributed to L., certainly shews an intimate knowledge of Christianity; but no critic now believes it to be a production of

that writer. The fact is, L. was one of that class of men who do not readily embrace any form of religion—men whose sharp critical eyes see too many flaws to make it easy for them to acquire a pious or reverential spirit. In philosophy, as well as in religion, he called no man master. Philosophers are indeed the constant subjects of his humorous ridicule and pungent wit, aided by all the resources of a richly inventive fancy. His writings have been classified under seven heads. 1. The Rhetorical; 2. The Critical; 3. The Biographical; 4. Romances; 5. Dialogues; 6. Miscellaneous; 7. Poema. Of these, the most celebrated are his Dialogues, the principal of which are—*The Sale of Lives; Dialogues of the Gods; The Fisherman, or the Revenant; The Banquet, or the Lapiths; Timon the Misanthrope; Dialogues of the Dead; and Icaro-Memippus, or Above the Clouds*. The best of his romances, and a work of Rabelaisian humour, is his *True Histories*. The *editio princeps* of L. appeared at Florence in 1496; the best of the later editions is that commenced by Hemsterhuis in 1730, and finished by Reitz (Amst. 1743). L. has always been a great favourite with scholars, and has been translated into most of the European languages. The best English version (incomplete however) is that of Dr Franklin (2 vols. Lond. 1780, and 4 vols. Lond. 1781).

LUCID INTERVAL. What intermission is to certain fevers, a lucid interval is to certain forms of mental disease. Those forms in which it occurs are characterized by exaltation or perversion, and not by impairment of the faculties or feelings. There may thus be a cessation or suspension of the fury in mania; there cannot be repair or enlightenment of the obscurity in idiocy or senile dementia. It may consist in the mere substitution of clearness and calmness for violence and confusion; in the occasional recognition of his actual condition and external relations by the lunatic; or in the re-establishment of intelligence and natural feeling so perfect and complete as to differ from sanity solely in the want of permanence. The duration is likewise sometimes so considerable and regular as to divide the mental and moral life of the individual into two halves. It has been believed that even in such cases the interval is a part or link of the disease, and that there invariably exists an under-current of unsoundness. It is found to be extremely difficult to distinguish this state from real and trustworthy restoration to reason, except by reference to duration. Practically and legally, these conditions have been held to be identical. A will executed during a lucid interval, although that was extremely transitory, and although the testatrix unloosed the straps by which her hands had been confined, in order to execute the document, has been held to be valid; all that appears to be required, under such circumstances, is to prove that the conduct of the individual bore the aspect of rationality and health. It has been observed that, immediately before death, a small proportion of the insane regain lucidity, and, after years of extravagance and absurdity, die in possession of comparative sense and serenity. This change is supposed to depend upon the failing powers of the circulation.—Burrows, *On Insanity*; Shalford, *On Law of Lunatics*, p. 239.

LUCIFER MATCHES. See MATCHES.

LUCIFNA, a genus, and **LUCINIDÆ**, a family of Lamellibranchiate mollusca, allied to *Venerida* (see *VERUS*). The shell is orbicular, or nearly so, and bears a very long impression of the anterior muscle. The animal has a long, generally cylindrical foot. The species are numerous, are found in almost all

seas, and at all depths in which life is known to exist, burrowing in the sand or mud. There are also many fossil species in the more recent formations.

LU'CKENWA'LDE, a town of Prussia, government of Potsdam, and capital of a circle of the same name, is situated on the river Nuthe, 30 miles south-south-west of Berlin. Pop. 8513. One of its suburbs, called Little Gera, is inhabited by Russian colonists. Its cloth manufactories are among the largest in Prussia. L. is a station on the Berlin and Anhalt Railway.

LUCKNOW, the capital of Oude, in British India, stands on the right or south-west bank of the Gumti, by which it has a navigable communication upwards for many miles, and downwards all the way to the Ganges. It is in lat. 26° 52' N., and long. 81° E., is 360 feet above the sea, and is 610 miles from Calcutta. The place is connected with the opposite side of the river by three bridges, one of stone, another of boats, and a third of iron. Though L. does not appear to contain any very ancient buildings, it is yet understood to be older than any one of the other great cities of India, claiming to have been founded by Lakshmana, brother of Rama. The middle portion, which may be said to represent the original town, contains, with the exception of a few brick-houses, little but mud walls and straw roofs. On either side of these central hovels are the handsomer sections of L., generally dating, however, no further back than 1775. The population has been estimated at 300,000. As an illustration at once of manners and of government, all classes, down to the annexation of Oude in 1856, were wont to go fully armed, the very shopkeepers being equipped with swords and shields. In connection with the mutiny of 1857, L. stood foremost in point of interest, surpassing every spot in the energy and obstinacy of its defence against the insurgents, and almost equalling Delhi itself in the grandeur and brilliancy of the operations, which recovered it, after a temporary abandonment, from the rebels.

LUCRETIVS, TITUS CARUS. Of the life of L. we know almost nothing with certainty, as he is mentioned merely in a cursory manner in contemporary literature. Hieronymus (340—420 A. D.), in his translation of the Chronicle of Eusebius (264—340 A. D.), gives the date of his birth as 95 B. C. (according to others, 99); but he does not specify the source from which his statement is derived. It is alleged, further, that he died by his own hand, in the 44th year of his age, having been driven frantic by a love-potion which had been administered to him; that he composed his works in the intervals of his madness; and that these works were revised by Cicero. Donatus (*Life of Virgil*), on the contrary, affirms that his death occurred in 55 B. C., on the very day on which Virgil assumed the *togæ virilis*. The stories of the philtre, the madness, the suicide, and the revision of the works by Cicero, rest on very insufficient authority, and must be received with extreme caution. The peculiar opinions advanced by L. would render him specially obnoxious to the early Christians, and it is possible that the latter may have been too easily led to attribute to him a fate which, in its mysterious nature and melancholy termination, was deemed but a due reward for the bold and impious character of his teachings. The great work on which the fame of L. rests is that entitled *De Rerum Natura*, a philosophical didactic poem in six books. It is dedicated to C. Memmius Gemellus, and was published about 56 B. C. L. was a reverent follower of the doctrines of Epicurus (q. v.), and his poem is in large measure an exposition of the

physical, moral, and religious tenets of that philosopher. The great aim of the poet was to free his fellow-countrymen from the trammels of superstition, and to raise them above the passions and the weaknesses of our natural condition. With his master, Epicurus, L. adopted the atomic theory of Leucippus, which taught that certain elementary particles, existing from all eternity, and governed by fixed laws, combined to form the universe of matter; that the existence and active interference of a supreme overruling deity was not necessary to be supposed in order to account for the marvellous and abnormal in nature; and that whatever appeared to be miraculous, was in reality not so, but was merely the result of certain fixed laws, which operated with unerring precision, and in a natural process. Regarded merely as a literary composition, the work of L. stands unrivalled among didactic poems. The clearness and fulness with which the most minute facts of physical science, and the most subtle philosophical speculations, are unfolded and explained; the life and interest which are thrown into discussions in themselves repulsive to the bulk of mankind; the beauty, richness, and variety of the episodes which are interwoven with the subject-matter of the poem, combined with the majestic verse in which the whole is clothed, render the *De Rerum Natura*, as a work of art, one of the most perfect which antiquity has bequeathed to us. For a fuller estimate of L. and his poetry, see Professor Sellars's essay in *The Roman Poets of the Republic* (Edin. 1863). The *editio princeps* of L. was published at Brescia about 1473; only three copies are known to exist. The best editions of L. are by Wakefield (Lond. 1796, 3 vols. 4to, and Glas. 1813, 4 vols. 8vo); by Forbiger (Leip. 1828, 12mo); and by Lachmann (Berlin, 1850, 2 vols.). The *De Rerum Natura* has been translated into English verse by Thomas Creech (Lond. 1714, 2 vols. 8vo); and by John Mason Good (Lond. 1805—1807, 2 vols. 4to); into English prose by the Rev. J. S. Watson, M.A. (Lond. Bohn's Classical Library, 1851, post 8vo). To this last the poetical version of Good is appended.

LUCULLUS, L. LICINIUS, a very distinguished Roman general, born, it is conjectured, about 110 B.C. In the first Mithridatic war, he commanded the fleet as legate of Sulla. In 77 B.C., he filled the office of prætor, and immediately after, held the administration of the province of Africa. In 74 B.C., he was chosen consul along with Marcus Aurelius Cotta, and got Cilicia for his province, whilst Cotta had Bithynia. Both consuls arrived in Asia about the close of 74 B.C. Cotta was soon after utterly defeated by Mithridates, who had burst into Bithynia at the head of 150,000 troops, forced to take refuge in Chalcedon, and there was besieged by the victor. L., however, advanced to his relief at the head of 35,000 men, compelled Mithridates to raise the siege, and almost annihilated his army on its retreat. In 71 B.C., Pontus became subject to the Romans. The measures which L. now introduced in the government of the province of Asia, to secure the provincials against the fearful oppressions and extortions of farmers of the taxes and usurers, especially his fixing a uniform and moderate rate of interest for all arrears, shew that he was a just, wise, and humane administrator; but though the cities of Asia were grateful for his clemency, the equestrian order in Rome (who had the farming of the taxes) became implacably hostile to him, and his own troops grew disaffected on account of the strictness of his discipline. For some time, however, things seemed to go on well enough. In the spring of 69 B.C., he marched into Armenia with a small force of 12,000 foot and 3000

horse, and gained a complete victory over Tigranes, at the head of an army of 220,000 men. In the following year, he gained another great victory at the river Arsianus over a new army led against him by Tigranes and Mithridates; but the mutinous spirit of the legions—in spite of these splendid triumphs—daily increased. L. now wanted to besiege Artaxata, the capital of Armenia, but the soldiers refused to advance further. After this, he could do nothing; not a soldier would serve under him. At last, he was superseded by Pompey, and left Asia 66 B.C. The cabals of his enemies so much prevailed against him, that he was three years in Rome before he obtained his triumph. In conjunction with the aristocratical party, he attempted to check the increasing power of Pompey, and the attempt caused the coalition known as the first triumvirate. But he was ill fitted to act as leader against such unscrupulous men, and soon withdrew altogether from political affairs. During his public career, he had acquired (but not unfairly) prodigious wealth; and he spent the remainder of his life surrounded by artists, poets, and philosophers, and exhibiting in his villas at Tusculum and Neapolis, and in his house and gardens at Rome, a luxury and splendour which became proverbial. A single supper—on particularly grand occasions—would cost him 50,000 denarii (£1770). Towards the close of his life, his faculties began to decay, and his property was placed under the management of his brother. He died about 57 B.C. L. was a man of great military talent, humanity, liberality, and love of justice; his great fault was his love of pleasure; not exactly vicious pleasure, for he was an epicure rather than a profligate; yet so purely sensual, that it seems to have made people—certainly his soldiers—believe him to be grossly selfish and unsympathetic.

LUDLOW, a municipal and parliamentary borough of England, in the county of Salop, at the confluence of the Corve and Teme, 25 miles south-south-east of Shrewsbury. It is an old and very interesting town; its parish church dates from the reign of Edward III.; its free school, founded by Edward IV., has an annual income of £350. The castle, now a magnificent ruin, was at one time one of the most important strongholds against the Welsh. Here Arthur, eldest son of Henry VII., celebrated his marriage with Catharine of Aragon, afterwards the wife of Henry VIII.; and here, in 1634, Milton's masque of *Comus* was performed for the first time. Since the reign of Edward IV., two members have been returned to parliament for the borough. Pop. (1861) of parliamentary borough, 6033.

LUDLOW FORMATION, the uppermost division of the Silurian Strata (q. v.), consists of an extensive series of indurated argillaceous beds, with bands of dark-gray argillaceous limestone. The town of Ludlow stands upon the higher strata of this formation.

LUDWIG I., KARL AUGUST, King of Bavaria, the eldest son of King Maximilian Joseph, born 25th August 1786. In 1810, he married the Princess Theresa of Saxe-Hildburghausen. As crown-prince, he took little part in politics, but devoted himself to science and the fine arts, and lived very economically, in order that he might be able to spend large sums in forming a magnificent collection of masterpieces of sculpture, known as the Glyptothek. He succeeded to the throne on 13th October 1825, and commenced his reign by granting some reforms. His reign was distinguished by the encouragement of the fine arts, and the erection of magnificent public buildings; he also inaugurated the first railway

that Germany possessed—that from Nuremberg to Furth—and executed the fine canal, called *Ludwigskanal*, which unites the Danube and the Main. But it was no less characterised by the prevalence of ultramontane influence, intolerance towards all who did not belong to the Church of Rome, and contempt of constitutional rights and forms, whilst the king's conduct gave great occasion of scandal, particularly in his connection with the dancer Lola Montez (created Countess of Landsfeld). On account of the revolutionary disturbances in February and March 1848, L. resigned the crown in favour of his eldest son, Maximilian.

LUDWIGSBURG, a town of Würtemberg, about 8 miles north of Stuttgart. It was founded in 1706 by Duke Eberhard Ludwig, in consequence of a quarrel with the Stuttgarters, and is the second royal residence. L. was laid out with painful regularity, and has an artificial and lifeless look. It is the principal dépôt for soldiers in Würtemberg, not less than 4000 being stationed here, whence it has got the name of the Swabian Potsdam, and has an arsenal, a cannon-foundry, a military academy, and a royal castle, with splendid picture-gallery and gardens. Pop., including military, 10,979.

LUFF, in Nautical parlance, is to bring a ship's head to the wind, preparatory to tacking, or otherwise. The *luff* of a vessel is the roundest part of her bow.

LUGANO, a town in the canton of Ticino, Switzerland, stands on the north-west shore of the lake of the same name. It is entirely Italian in character, with dingy and dirty arcaded streets; but its environs display all the richness of Italian scenery. L. contains several factories for throwing silk, and is the seat of a flourishing transit trade between Switzerland and Italy. From *Monte Salvatore*, in the vicinity, a magnificent view may be obtained. Pop. 5140.

LUGANO LAKE, is situated in the south of the canton of Ticino, Switzerland, three of its arms reaching into the Italian territory. Its greatest length is about 20 miles; but from its exceedingly irregular shape, it is nowhere more than $1\frac{1}{4}$ mile broad. The character of its scenery, though perhaps as beautiful, is more rugged than that of Lakes Como and Maggiore.

LUGANSK, a market-town in the government of Ekaterinoslav, European Russia, situated on the Lugan, a branch of the Donetz, 100 miles north-north-west of Taganrog, is the seat of the only ironworks in the south of Russia. The ore was formerly brought from the Ural Mountains, but is now found in sufficient quantity in the neighbourhood. L. has also a cannon-foundry and coal-mines, and, during the Crimean war, supplied the Russian fleet with coal and ammunition.

LUGGAGE of travellers, though, in a certain sense, attached to the person, and under one's immediate care, and not paid for separately, is nevertheless protected by the contract; and carriers of all kinds are bound to carry luggage safely, and if it is lost, must pay damages for it. Owing to the established rule, that luggage is not paid for separately, it has often been attempted by travellers to abuse this privilege, and carry merchandise as part of and mixed up with their luggage, in order to escape any separate and extra payment. Most railway companies, accordingly, by their by-laws fix a limit as to weight for this luggage, and it is presumed that luggage consists only of wearing-apparel or things for personal use, and not articles of trade intended for sale. Though carriers or railway companies cannot get rid of liability for this luggage by giving any notice or making a by-law to that

effect, yet it is competent for all carriers to specify certain articles of merchandise, which, whether they are mixed up with luggage or not, must be separately paid for, otherwise they will not be responsible. Such are gold or silver in a manufactured state, jewellery, watches, clocks, trinkets, stamps, maps, writings, title-deeds, paintings, pictures, glass, china, silks, furs, and lace, provided these exceed in value £10. Unless notice of such articles being included in the luggage is given to the carriers or company, and an increased rate paid, they will not be responsible for the loss. Except, therefore, these excepted articles, the carrier is bound to receive, carry securely, and deliver the luggage of travellers, notwithstanding the traveller has it in his personal charge. Thus, a railway porter, on the arrival of the train, having carried a traveller's luggage to a cab and lost it in the way, the railway company was held responsible. A carrier has a lien on the luggage for the fare, if not paid, and can keep it till such fare is paid; but as prepayment is now the universal practice, this remedy is seldom resorted to.

LUGGER, a small vessel carrying two or three masts, with a lugsail (see below) on each, and occasionally a topsail. The rigging is light and simple, and the form of the sails enables a lugger to beat close up to the wind. Among English boats, the



Lugger.

lug-rig rarely extends beyond the larger class of fishing-vessels, though there are some very elegant lugger-yachts in the different clubs. In the French service, however, it is a favourite rig, and is used for vessels of sizes as large as British schooners.

LUGSAIL, a quadrilateral sail used in luggers and open boats. It is bent, by the upper side, upon a straight yard, which is slung on the mast in an oblique position, one-third to windward, two-thirds on the leeward side of the mast.

LUGO (the *Lucus Augusti* of the Romans), a town in the north-west of Spain, capital of the province of the same name, is situated on the left bank of the Miño, 50 miles east-north-east of Santiago. It is the seat of a bishop, has a cathedral of the 12th c., and several other churches, and manufactures of silk and leather. It was celebrated in the time of the Romans for its warm sulphur-baths. Pop. 8246.

LUG-WORM, or **LOB-WORM** (*Arenicola piscatorum*), one of the *Dorsibranchiate Annelida*, extremely abundant on the British shores, and very valuable as bait to fishermen. It inhabits the sand, on the surface of which, after the tide has retired, innumerable coils are always to be seen, the *casts* of this worm. It is larger than the earthworm,

sometimes a foot long, is destitute of eyes, has no distinct head, but is much thicker at the extremity where the mouth is situated than at the other. The mouth has no jaws, nor teeth, nor tentacles. There are two rows of bristles along the sides, organs of locomotion, by means of which the L. works its way through the sand. About the middle, it has on each side six tufts of gills. (For fig., see ANNELIDA.) When touched, it exudes a yellowish fluid; and an exudation from its body slightly agglutinates the particles of sand, so as to form a tube through which it passes and repasses. It is one of the annelids most remarkable for the red colour of the blood, which imparts a fine crimson to the gill-tufts.

LUINI, or LOVINO DA LUINI, BERNARDINO, born about 1460 at Luini, near the Lago Maggiore, a celebrated painter of the Lombard school. He is generally stated to have been the principal pupil of Leonardo da Vinci, but it rather appears that he was educated under Stefano Scotto; and though, from having attended the Academy of the Fine Arts founded at Milan by Ludovico il Moro, of which Leonardo was director, he may be styled a pupil of that great artist, yet it is not proved that he received any direct instruction from him. Though L. occasionally imitated the style and execution so closely as to deceive experienced judges, his general manner had a delicacy and grace sufficiently original and distinct from that of Leonardo. Still the works of the former are often attributed to the latter, in order to increase their value. He executed numerous works at Milan in oil and fresco. His frescoes at Legnano, Saronno, and Pavia, are justly admired. The date of his death is not exactly known, but he was alive in 1530.—He had a brother, AMBROGIO, who imitated his style, and several sons who also were painters.

LUISE, AUGUSTE WILHELMINE AMALIE, queen of Prussia, was born, 10th March 1776, at Hanover, where her father, the Duke Karl of Mecklenburg-Strelitz, was then commandant. She was married to the Crown-prince of Prussia, afterwards Frederick William III., on 24th December 1793. After his accession to the throne, she became exceedingly popular, her great beauty being united with dignity and grace of manners, and with much gentleness of character and active benevolence. This popularity increased in consequence of her conduct during the period of national calamity which followed the battle of Jena, when she displayed not only a patriotic spirit, but no little energy and resolution. She was unexpectedly taken ill, and died when on a visit to her father in Strelitz, 19th July 1810. Her memory is cherished in Prussia, and the Order of Luise in that kingdom was founded in honour of her.

LUKE (LUCAS), the author of one of the gospels, and of the Acts of the Apostles, was born, according to the accounts of the church Fathers, at Antioch in Syria, and is said to have been a physician. He was probably by descent a Hellenistic Jew. We learn from Scripture that he was the associate of Paul in his second evangelistic expedition (52 A. D.); but that is all we know; whatever else is asserted concerning him is doubtful. That he was a painter, is one of the things for which tradition vouches; and in the church of St John Lateran at Rome a picture of our Saviour is shewn, which is ascribed to L., but is believed to be a work of the 13th century. The churches of Padua, Venice, and Rome also possess many pretended relics of this evangelist. His festival is commemorated by the Roman Catholic Church on the 18th of October.—The Gospel of St Luke, addressed to a certain Theophilus, is generally believed to have been written before the destruction of Jerusalem. Rénan, however, in his

Vie de Jesus (1863), considers its composition subsequent to that event. The time and place of its origin are unknown. See Schleiermacher's *Die Schriften des L.* (Berlin, 1817). The apocryphal writings ascribed to L. are, *Acts Pauli*, *Baptismus Leonis*, and *Liturgia XII. Apostolorum*.

LULLY, RAYMOND, 'the enlightened doctor,' one of the most distinguished men of the 13th c., was born at Palma, in Majorca, in 1234. In his youth, he led a dissolute life, and served for some time as a common soldier; but a complete revulsion of feeling taking place, he withdrew to solitude, and gave himself up to ecstatic meditations and the study of the difficult sciences. This sudden change of life produced in L. a fervid and enthusiastic state of mind, under the influence of which he formed the project of a spiritual crusade for the conversion of the Mussulmans, an idea he never afterwards abandoned. In pursuance of this project, he commenced an earnest study of theology, philosophy, and the Arabic language; and, after some years, published his great work, *Ars Generalis sive Magna*, which has so severely tested the sagacity of commentators. This work is the development of the method of teaching known subsequently as the 'Lullian method,' and afforded a kind of mechanical aid to the mind in the acquisition and retention of knowledge, by a systematic arrangement of subjects and ideas. Like all such methods, however, it gave little more than a superficial knowledge of any subject, though it was of use in leading men to perceive the necessity for an investigation of truth, the means for which were not to be found in the scholastic dialectics. L. subsequently published another remarkable work, *Libri XII. Principiorum Philosoph. contra Averroistas*, and, full of the principles which he had developed in this book, he went to Tunis, at the end of 1291, or the beginning of 1292, to argue with his opponents, face to face. He drew large crowds of attentive hearers, and held disputations with learned Mohammedans, who, however, were as anxious to convert him as he to convert them, and the result, as might have been expected, was that little impression was made by either of the parties. Finally, however, L. was thrown into prison, and condemned to banishment. After lecturing at Naples for several years, he proceeded to Rome; thence to his native island of Majorca, where he laboured for the conversion of the Saracens and Jews; thence to Cyprus and Armenia, zealously exerting himself to bring back the different schismatic parties of the oriental church to orthodoxy. In 1306—1307, he again sailed for Africa, entered the city of Bugia (then the capital of a Mohammedan empire), and undertook to prove the truth of Christianity. A tumult arose, in which L. nearly lost his life. He was again thrown into prison, and treated with great severity; yet so high an opinion was entertained of his abilities, that the chief men of the place were anxious that he should embrace Mohammedanism, and promised him if he did so the highest honours. But to L., whose intellect and feelings were both enlisted in the cause of Christianity, this was impossible. After some time he was again banished from the country, and landed (after being shipwrecked) near Pisa. He subsequently went to Paris, and lectured against the principles of Averroes; he also induced the pope to establish chairs for the Arabic, Chaldee, and Hebrew languages in all cities where the papal court resided, and also at the universities of Paris, Oxford, and Salamanca. But his missionary zeal could only be satiated by martyrdom. In 1314, he sailed once more for Africa, and proceeded to Bugia, where he threatened the people with divine judgments if they

refused to abjure Mohammedanism. The inhabitants were furious, dragged him out of the city, and stoned him to death, 30th June 1316. The *Mayence* (10 vols. 1721—1742) edition of his works includes several books on alchemy, of which there is not the slightest reason to suppose L. was the author. Compare Neander's *Kirchengeschichte*, Bohn's translation, vol. vii. pp. 83—96.

LUMBAGO is a rheumatic affection of the muscles in the lumbar region, or in the small of the back. It is often first recognised by the occurrence of a sharp stabbing pain in the loins upon attempting to rise from the recumbent or sitting position. It is sometimes so severe as to confine the patient to bed and in one position, from which he cannot move without intense suffering; but in milder cases he can walk, although stiffly and with pain, and usually with the body bent more or less forward. It may be distinguished from inflammation of the kidneys by the absence of the peculiar direction of the pain towards the groin, as also by the absence of the nausea and vomiting which usually accompany the disease of the kidney.

The causes of lumbago are the same as those of sub-acute rheumatism generally. The complaint may arise from partial exposure to cold, especially when the body is heated, and violent straining will sometimes induce it. In persons with a strong constitutional tendency to rheumatism, the slightest exciting cause will bring on an attack of lumbago.

The treatment must vary with the intensity of the affection. In most cases, a warm bath at bedtime, followed by ten grains of Dover's powder, will speedily remove it; and as local remedies, a mixture of chloroform and soap-liniment, or the application of the heated hammer (an instrument sold by Coxeter, surgical-instrument maker, London), will be found serviceable. The writer of this article has frequently seen the disorder completely disappear after one application of the hammer, which should be heated in a spirit-lamp to somewhat about 200°, and then be rapidly brought in contact with points of the skin over the painful parts at intervals of about half an inch. Each application leaves a red spot, but blisters seldom occur, if the operation is properly performed.

LUMINOUSITY OF ORGANIC BEINGS. Many organic beings, both vegetables and animals, possess the property of emitting light.

In cryptogamic plants, it has been observed on the filaments of *Schistostegia osmundacea*, one of the order of Hepaticæ; in *Rhizomorpha subterranea*, belonging to the order of Fungi (which is not uncommon on the walls of dark, damp mines, caverns, &c., and occasionally emits a light sufficiently clear to admit of reading ordinary print); in certain species of *Agaricus* (belonging to the same order); and in *Thelaphora cerulea* (also a fungus), to which decayed wood owes its phosphoric light.

An emission of light, chiefly in flashes, has been observed in the case of a few phanerogamic plants, among which may be mentioned the garden nasturtium and marigold, the orange lily, and the poppy. In these instances, the light has been emitted by the flowers; but cases are also recorded in which the leaves, juice, &c., of certain plants have evolved light. The emission of light from the common potato, when in a state of decomposition, is sometimes very striking. Dr Phipson, in his work *On Phosphorescence*, mentions a case in which the light thus emitted from a cellular of these vegetables was so strong as to lead an officer on guard at Strasburg to believe that the barracks were on fire. The phosphorescence in this case is probably due to the same cause as that of decayed wood.

Before proceeding to notice the principal cases in which living animals have been observed to emit light, we shall briefly refer to the emission of light by dead animal matter. The bodies of many marine animals shine after death, but in none is the phenomenon so vivid or continuous as in the well-known boring mollusc the *Pholas*. The luminosity of this animal after death was known to Pliny, who said that it shone in the mouths of persons who ate it; and has been made the subject of special investigation by Réaumur, Beccaria, and others. Among other results, they found that a single *Pholas* rendered seven ounces of milk so luminous that the faces of persons might be distinguished by it; and that, by placing the dead animal in honey, its property of emitting light, when plunged into warm water, lasted more than a year.

It is universally known that certain kinds of dead fish, especially mackerels and herrings, shine in the dark. From a careful study of the body of a dead stock-fish in a luminous condition, Dr Phipson finds that the phenomenon is due to a grease which shines upon the fish, and which (as it neither contains phosphorus nor minute fuagi, by which the light might have been caused) contains some peculiar organic matter, which shines in the dark like phosphorus itself.

Several cases are on record in which ordinary butcher's meat has presented the phenomenon now under consideration, but their occurrence is so rare that we need not specially notice them. It may be observed that phosphorescent light is not unfrequently observed on the dead human body by persons who visit dissecting-rooms by night. The occasional evolution of light by living human beings will be presently referred to.

The living animals which possess the property of emitting light are extremely numerous, decided cases of phosphorescence having been frequently observed, according to Dr Phipson, 'in infusoria, rhizopoda, polypes, echinoderms, annelides, medusæ, tunicata, mollusca, crustaceans, myriapodes, and insects.' Following the arrangement here laid down, we shall mention a few of the organisms in which the phenomenon in question is most remarkable. Among the rhizopoda, the *Noctiluca miliaris*, a minute animal very common in the English Channel, stands pre-eminent. Dr Phipson relates that he has found it 'in such prodigious numbers in the damp sand at Ostend, that on raising a handful of it, it appeared like so much molten lava.' It is the chief cause of the phosphorescence of the sea, which is so often observed. Among the annelides, earthworms occasionally evolve a shining light like that of iron heated to a white heat. Among the tunicata, a minute animal common in some of the tropical seas, the *Pyrosoma Atlantica*, resembles a minute cylinder of glowing phosphorus, and sometimes occurs in such numbers, that the ocean appears like an enormous layer of molten lava or shining phosphorus. Among the myriapodes, certain centipedes—viz., *Scolopendra electrica* and *S. phosphorea*—present a brilliant phosphoric appearance. There is reason to believe that the former will not shine in the dark, unless it has been previously exposed to the solar rays. Luminosity in insects occurs in certain genera of the Coleoptera and Hemiptera, and possibly in certain Lepidoptera and Orthoptera. Among the Coleoptera, must be especially mentioned the genus *Lampyris*, to which the various species of Glowworms (q. v.) belong, and the genus *Elater*, to which the Fireflies (q. v.) belong. In the Hemiptera, there is the genus *Pulgora*, or Lantern-flies (q. v.), some species of which are highly luminous.

The evolution of light from animals belonging to the vertebrates is extremely rare. Bartholin, in

his treatise *De Luce Hominum et Brutorum* (1647), gives an account of an Italian lady, whom he designates as 'mulier splendens,' whose body shone with phosphoric radiations when gently rubbed with dry linen; and Dr Kane, in his last voyage to the polar regions, witnessed almost as remarkable a case of human phosphorescence. A few cases are recorded by Sir H. Marsh, Professor Donovan, and other undoubted authorities, in which the human body, shortly before death, has presented a pale luminous appearance.

It is very difficult to give a satisfactory explanation of the above facts. The light evolved from fungi is most probably connected with chemical action, while that emitted in sparks and flashes from flowers is probably electrical. In some luminous animals, a phosphorescent organ, specially adapted for the production of light, has been already detected, and as anatomical science progresses, the same will probably be found in all organisms endowed with luminous or phosphorescent properties. For full details on the subject of this article, the reader is referred to Dr Phipson's work, *On Phosphorescence* (London, 1862).

LUMPSUCKER, or LUMPFISH (*Cyclopterus*), a genus of fishes of the family *Discoboli* (q. v.), having the head and body deep, thick, and short, the back with an elevated ridge, the fins rather small, and the ventrals united by a membrane so as to form a sucking disc.—One species (*C. lumpus*) is common on the coasts of Britain, particularly in the northern parts, and is still more plentiful in the seas of more northern regions. It has a grotesque

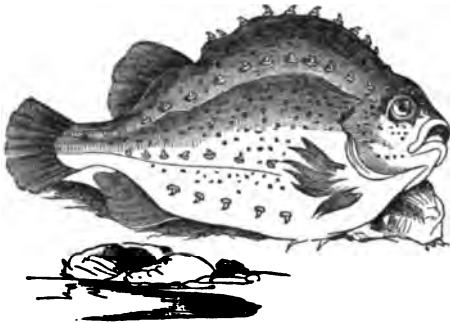

Lumpsucker (*C. lumpus*).

and clumsy form, but its colours are very fine, combining various shades of blue, purple, and rich orange. It attains a pretty large size, sometimes weighing seven pounds. The L. preys on smaller fishes. Its sucker is so powerful that a pail containing some gallons of water has been lifted when a L. contained in it was taken by the tail. Its flesh is insipid at some seasons, but very fine at others, and is much used for food in northern regions. It is often brought to the Edinburgh market. It is known in Scotland as the *Cock Paille*.

LUNACY. By the law of England, as well as of all other countries, the presumption is in favour of a man's sanity, even though he be born deaf, dumb, and blind; and if the fact is disputed, it always lies on the party alleging it to prove it. Sometimes a person in a state supposed to be that of a lunatic makes a contract, and is sued upon it; in such a case, he may set up as a defence that he was a lunatic, and the proof will consist of his conduct and actions at and previous to the time in question. If, however, the other party did not know of the

lunacy, and took no advantage, the lunatic will not be allowed to recover back moneys which have been paid by him in pursuance of his contract. Though the presumption is in favour of the sanity of a person, yet, when once insanity has existed, the presumption is reversed, and then the law presumes no lucid interval or restoration to sanity until it is proved; and it is extremely difficult to prove a lucid interval, for the law requires very clear and conclusive proof of that fact, and all the circumstances must be carefully scanned. It is difficult or impossible to define in words what is insanity or lunacy, it being a negative state, and merely an inference from the acts, conduct, and bodily condition of the person. An idiot is said to be a person who was born with a radical infirmity of mind, and whose state is one of perpetual infirmity, incapable of cure or restoration; whereas a lunatic is one who is sometimes of good and sound mind, and sometimes not; he has lucid intervals, and is assumed to be more or less capable of restoration to sanity. A person is said to be, in legal phraseology, of unsound mind, who is not an idiot, nor a lunatic, nor yet of a merely weak mind, but, by reason of a morbid condition of intellect, is as incapable of managing his affairs as if he were a lunatic. Though it is difficult to define lunacy or insanity, there are various tests which are more or less accepted in everyday life as strong evidence. Idiocy is accompanied by a vacant look, &c., while insanity is accompanied by some frenzy or extravagant delusion. The physiology of idiocy and lunacy is a separate subject of investigation, and is part of medical jurisprudence, to which a few medical men confine their attention, and their assistance is often required by courts of law when inquiring into this state of mind, though their theories are jealously scrutinised. As a general rule, an idiot or a lunatic is subject to civil incapacity. He cannot enter into contracts or transact general business, and what he does is a nullity. Thus he cannot make or revoke a will, or enter into marriage, or act as an executor or administrator, or become a bankrupt, or be a witness in a court of justice, or vote at elections, and such like. But, as a general rule, a lunatic is liable in damages for committing a wrong, such as a trespass, and he is liable for necessities supplied to him, and he may be arrested for debt, and his property may be taken in such cases, as in the case of sane persons. With regard to criminal responsibility, the law was fully considered in the case of M'Naughton, who, in 1843, shot Mr Drummond at Charing Cross by mistake for Sir Robert Peel, and the English judges were called on by the House of Lords to state their opinion as to the right mode of putting the questions to a jury when the defence of insanity is raised. The judges said that a person labouring under an insane delusion as to one subject is liable to punishment, if at the time of committing the crime he knew he was acting contrary to law. In general cases, to establish want of responsibility, it must be proved that the party accused was labouring under such a defect of reason, from disease of mind, as not to know the nature and quality of the act he was doing, or, if he did know it, that he did not know he was doing what was wrong. Where the party is labouring under an insane delusion as to existing facts, and commits a crime in consequence thereof, it depends on the nature of the delusion whether he is excused. Thus, if he insanely believes that A intended to kill him, and he kills A, as he supposes, in self-defence, he would be exempt from punishment. But if his delusion was that A had inflicted a serious injury to his character and fortune, and he killed A in revenge for such supposed injury, then he would be liable to punishment. When a person is acquitted of crime

on the ground of insanity, he is liable to be confined in prison during her Majesty's pleasure.

So long as a person is not actually declared insane or an idiot, he has a right to manage his own affairs; and the only way, in England, in which he can be deprived of such right used to be by a writ *de lunatico inquirendo*, issuing out of Chancery, which authorised the empanelling of a jury to decide whether he was a lunatic or not. The custody and care of lunatics were vested in the crown; and the Lord Chancellor, as the depositary of this jurisdiction, issued the writ on petition. The practice has now been considerably altered by various statutes, but, as a general rule, it is still the law, that, unless a person has been officially declared a lunatic, either by the verdict of a jury, or by a certificate of a master in lunacy, he is still entitled to manage his own affairs. In England and Ireland, there is no intermediate state called imbecility or weakness of mind, with which the law interferes, as there is in Scotland (see INTERDICTION, IMBECILITY), and hence, if a weak person is imposed on, it is treated merely as a case of fraud, the weakness forming an element of such fraud; but there is no machinery for restraining the natural right, even of weak-minded persons, to do what they like with their property. As regards idiots and lunatics, the mode in which they are judicially declared to be so, is as follows: There are certain persons called masters in lunacy, whose business it is to conduct the inquiries which are necessary, and preside over the jury, and they also visit lunatics in certain cases. The commissioners of lunacy form a Board, which supervises generally the lunatic asylums and licensed houses for reception of lunatics. The incapacity of a lunatic or idiot is conclusively established by the verdict of a jury under an inquisition *de lunatico inquirendo*, held before a master in lunacy; or, if the case is too clear for a jury, and where the party has not mental capacity to declare his wish on the subject, by a certificate of a master in lunacy. The Lord Chancellor may direct the trial to take place before one of the common-law judges, and the evidence is to be confined to the lunatic's conduct during the previous two years only. The costs of the trial are in the Lord Chancellor's discretion. If the party has property, the Lord Chancellor then appoints, on petition, a committee of the estate or of the person of the lunatic, and the visitors in lunacy must visit such lunatic at least once a year, unless the lunatic is in a private house unlicensed, in which case he must be visited four times each year. The lunatic is thus kept under the immediate control of the Court of Chancery, which manages his property through the agency of the committee and of the visitors in lunacy. But as many lunatics have no property, or property of a trifling nature, it has long been found necessary to provide asylums and registered houses for the reception of lunatics, all which are more or less under control of the commissioners in lunacy. Houses kept for the reception of lunatics are either provided by the counties, and called county asylums, or they are hospitals founded by charitable donors, or they are mere private houses, kept for purposes of profit by individuals. County asylums were first established in 1808 (see LUNATIC ASYLUM). The justices of every county are bound to provide such an asylum, or to join with some other parties in keeping one, the expense being defrayed out of the county rates, and a committee of justices being appointed as visitors, to see that the statute is complied with. The object of the county asylum is to receive the lunatic paupers of the county. As a general rule, it is incumbent on the parish officers of each

parish to report to the neighbouring justices any case of a lunatic pauper being in their parish. In some cases of a harmless description, such paupers may be kept in the workhouse; but in other cases, on the matter being reported to the justices, the latter order the paupers to be brought before them for examination, and then send them to the county asylum; the parish to which the pauper belongs—i. e., in which he is legally settled—being liable to defray the maintenance; but if the parish which is legally bound to support the pauper cannot be discovered, then the expense is to be charged to the county. If the pauper cannot be examined by the justices, the medical officer and a clergyman may sign a certificate, which is taken to be evidence of the lunacy. As to private houses, no person is allowed to receive two or more lunatics, unless such house has been previously licensed by the commissioners in lunacy, which licence is only given after inspection, and a report as to its sanitary arrangements and other items of management. No person can be legally received into such licensed house without a written order from the person sending him, and the medical certificates of two physicians, surgeons, or apothecaries. The keepers of such houses are liable to visitation by the commissioners, and to render regular reports as to all particulars concerning the admission, death, removal, discharge, or escape of patients. The commissioners have power to visit at unexpected times, and to receive reports from other visitors. The commissioners may discharge persons who seem to be detained without sufficient cause.

In Scotland, the law differs in several respects from the above. Idiots and lunatics are often called fatuous and furious persons respectively; and there is an intermediate state called imbecility or weakness of mind, upon evidence of which the relations may apply to the Court of Session for Judicial Interdiction (q. v.), which has the effect of protecting the imbecile from squandering his heritable property. The care and custody of lunatics and idiots belong to the Court of Session, which may appoint a *curator bonis* or judicial factor to take charge of the estate, and a curator or tutor dative to take charge of the lunatic's person. A party is cognosed as a fatuous or furious person by a jury presided over by the sheriff. The recent statutory provisions concerning Scotch lunatics are contained in the statutes 20 and 21 Vict. c. 71, 21 and 22 Vict. c. 89, and 25 and 26 Vict. c. 64. There is also a Board called the Commissioners in Lunacy for Scotland, who may grant licences for private asylums. They may also give special licences to occupiers of houses for the reception of lunatics, not exceeding four in number, subject to rules and regulations. Counties and parishes may contract for accommodation of their lunatic paupers. Minute provisions are contained in these statutes as to the mode of treatment and visitation of lunatics, which, in leading points, resemble those regulating the practice in England.

LUNAR CAUSTIC is the term applied to the fused nitrate of silver, when cast into small cylinders. It is, when freshly prepared, of a whitish striated appearance; but on exposure to the air, the outer surface becomes decomposed, and blackens.

The uses of lunar caustic in surgery as a caustic are numerous. It is a useful application to punctured, and especially to poisoned wounds. When applied to large indolent ulcers, it acts as a stimulant, and restores a more healthy action. It is used to remove and keep down spongy granulations (popularly known as proud-flesh) in wounds and ulcers, and to destroy warts. It has been applied with good effect to the pustules in small-pox, in order to cut

short their progress and to prevent pitting. It is of great service as a local application in inflammatory affections and ulcerations of the mucous membrane of the mouth and throat. In fissured or excoriated nipples, its application gives great relief. It should be insinuated into all the cracks, and the nipple afterwards washed with tepid milk and water. It is also extensively employed in diseases of the eye, of the genito-urinary organs, and in some forms of skin-disease.

LUNAR THEORY, a term employed to denote the *a priori* deduction of the moon's motions from the principles of gravitation. See **MOON**.

LUNATIC ASYLUM. The first hospitals for the insane of which history or tradition makes mention, were the sacred temples in Egypt. In these, it is said, the disease was mitigated by agreeable impressions received through the senses, and by a system resembling and rivalling the highest development of moral treatment now practised. Monasteries appear to have been the representative of such retreats in the medieval Christian times; but restraint and rigid asceticism characterised the management. Out of conventual establishments grew the Bethlems, or Bedlams, with which our immediate ancestors were familiar (see **BEDLAM**). But apart from such receptacles, the vast majority of the insane must have been neglected; in some countries, revered as specially God-stricken; in others, tolerated, or tormented, or laughed at, as simpletons or buffoons; in others, imprisoned as social pests, even executed as criminals. In a few spots, enjoying a reputation for sanctity, or where miraculous cures of nervous diseases were supposed to have been effected, such as Gheel and St Szaire, communities were formed, of which lunatics, sent with a view to restoration, formed a large part, and resided in the houses of the peasants, and partook of their labour and enjoyments. Asylums, properly so called, date from the commencement of the present century; and for many years after their institution, although based upon sound and benevolent views, they resembled jails both in construction and the mode in which they were conducted, rather than hospitals. Until very recently, a model erection of this kind was conceived necessarily to consist of a vast block of building, the centre of which was appropriated to the residence of the officers, the kitchen and its dependencies, the chapel, &c., from which there radiated long galleries, in which small rooms, or cells, were arranged upon one or both sides of a corridor or balcony, having at one extremity public rooms, in which the agitated or non-industrial inmates, as the case might be, spent the day, while the more tractable individuals were withdrawn to engage in some pursuit, either in workshops, clustered round the central house, or in the grounds attached, which were surrounded by high walls, or by a ha-ha. The population of such establishments, when they were appropriated to paupers, ranged from 100 to 1400 patients. These were committed to a staff composed of a medical officer, matron, and attendants, to whom were directly intrusted the management, discipline, and occupation of the insane, in accordance with regulations or prescriptions issued by the physician. A gradual but great revolution has taken place in the views of psychologists as to the provisions and requirements for the insane during seclusion. As a result of this change, asylums, especially for the wealthy classes, are assimilated in their arrangements to ordinary dwelling-houses; while it is proposed to place the indigent in cottages in the immediate vicinity of an infirmary, where acute cases, individuals dangerous to themselves

or others, or in any way untrustworthy, could be confined and actively treated, as their condition might require. In all such establishments, whether now entitled to be regarded as cottage asylums or not, the semblance and much of the reality of coercion has been abolished; the influence of religion, occupation, education, recreation; the judicious application of moral impressions; and the dominion of rational kindness and discriminating discipline, have been superadded to mere medical treatment, and substituted for brute force, terror, and cruelty.—Esquirol, *Des Maladies Mentales*, t. ii.; Guislain, *Sur l'Aliénation Mentale*; Browne on *Asylums*, &c.; Conolly on *Construction of Asylums*.

LUND (*Londinum Gothorum*), a city of Gothland, in the extreme south of Sweden, and in an extensive and fertile plain 30 miles south-east of Helsingborg. At present, it has only about 7300 inhabitants, but was once much larger, when it was the chief seat of the Danish power in the Scandinavian peninsula, and for a long period the capital of the Danish kingdom. The principal building is the cathedral, the lower part of which is as old as the 11th century. It has manufactures of cloth, tobacco, and leather. L is one of the oldest towns in Scandinavia; in 920, it was taken and plundered by a band of Vikings; it was the see of a bishop from the time of the introduction of Christianity, and from 1104 its archbishop long exercised jurisdiction over all Denmark, Sweden, and Norway. L has a university, founded in 1623, which has now 25 professors and about 500 students, a library of 50,000 volumes, and some thousands of manuscripts, an excellent zoological museum, and a botanic garden.

LÜNEBURG, a town of Hanover, in the province of the same name, is situated on the river Ilmenau, 24 miles south-east of Harburg by railway. It is mentioned as early as the age of Charlemagne, and was formerly an important Hanseatic town. It is surrounded with high walls and towers, and possesses many ancient buildings. The trade is considerable. In the immediate vicinity of L is the salt-work of Sulza, discovered in the 10th c., and still very productive. Close by is a hill 200 feet high, with rich seams of lime and gypsum. Pop. 12,600. It was at L that the first engagement took place in the German war of liberation, 2d April 1813. About 16 miles to the south-west of the town, in the Lüneburg Heath, lies the Gührde, a beautiful forest, with a royal hunting-lodge.

LÜNEBURG, formerly a principality in Lower Saxony, now a province of the kingdom of Hanover. Area, 4293 square miles; pop. (1861) 367,669, mostly Protestants. The Elbe forms its northern boundary. Great part of the country is occupied by the *Lüneburg Heath*. See **HANOVER**.

LUNEL, a town in the south of France, department of Hérault, 14 miles east-north-east of Montpellier, has a population of about 6000, and a considerable trade in Muscatel wine and raisins. Near it is a cave, important for the fossil bones found in it.

LUNETTE, in Fortification, is a small work beyond the ditch of the ravelin, to supply its deficiency of saliency, and formed at the re-entering angle made by the ravelin and bastion. The lunette has one face perpendicular to the ravelin, and the other nearly perpendicular to the bastion. See **FORTIFICATION**.

LUNÉVILLE, a town in the department of Meurthe, in France, at the confluence of the Meurthe and the Venouse, is a regularly built

LUNGS—LUPUS.

and unwall'd town of 12,164 inhabitants. It was formerly a frequent residence of the Dukes of Lorraine, and their palace is now used as a cavalry barracks. L. has manufactures of cotton and worsted goods, embroidery, and earthenware. It is one of the largest cavalry stations in France. The town has a historic celebrity from the Peace of Lunéville, concluded here on February 9, 1801, between Germany and France, on the basis of the Peace of Campo-Formio (q. v.).

LUNGS. See RESPIRATION, ORGANS OF.

LUNGWORT, or OAK-LUNGS (*Sticta pulmonaria*), a lichen with a foliaceous leathery spreading thallus, of an olive-green colour, pale brown when dry, pitted with numerous little cavities and netted, much lacerated; the shields (apothecia) marginal, reddish brown with a thick border. It grows on trunks of trees in mountainous regions, in Britain and other European countries, sometimes almost entirely covering them with its shaggy thallus. It has been used as a remedy for pulmonary diseases. It is nutritious, and, when properly prepared, affords a light diet, capable of being used as a substitute for Iceland Moss; yet it is bitter enough to be used as a substitute for hops. It yields a good brown dye.—The name *Lungwort* is also given to a genus of phanerogamous plants (*Pulmonaria*), of the natural order *Beraginea*. The common L. (*P. officinalis*) is a rare and rather doubtful native of Britain, although common in some parts of Europe. It has ovate leaves and purple flowers, and was formerly employed in diseases of the lungs, but seems to have been recommended chiefly by a fancied resemblance to the lungs in its spotted leaves. It is mucilaginous, and slightly emollient. It contains nitre in considerable abundance. It is used in the north of Europe as a pot-herb.

LUPERCALIA, a festival among the ancient Romans, held on the 15th of February, in honour of *Lupercus*, the god of fertility. When Rome began to seek a Grecian origin for its religious ceremonies, *Lupercus* was identified with *Lycean Pan*, and his worship was said to have been introduced by *Evander*, the Arcadian. Modern scholars place no value on such statements. *Lupercus* is believed by them to have been one of the oldest pastoral deities of Italy, and everything that is known regarding him and his rites favours this view. These rites were of the rudest and most primitive character, and indicate a high antiquity. Goats and dogs were sacrificed; afterwards, the priests (called *Luperci*) cut up the skins of the victims, and twisted them into thongs, with which they ran through the city striking every one who came in their way (which women used to do) in hopes that the god of fertility would be propitious towards them. As the festival is believed to have been at first a shepherd one, this running about with thongs is understood to have been intended as a symbolical purification of the land. The place where the festival was held was called the *Lupercal*, and was situated on the Palatine Hill. It contained an image of *Lupercus*, covered with a goat's skin. L. were also held in other cities of Italy.

LUPINE (*Lupinus*), a genus of plants of the natural order *Lepidifera*, sub-order *Papilionaceae*, mostly annuals, but some of them perennial herbaceous plants, some half-shrubby; and generally having digitate leaves, with rather long stalks. The flowers are in racemes or spikes, the calyx two-lipped, the keel beaked, the filaments all united at the base. The species of L. are numerous, and are chiefly natives of the countries near the Medi-

terranean Sea, and of the temperate parts of North and South America. The **WHITE L.** (*L. albus*), a species with white flowers, has been cultivated from time immemorial in the south of Europe and in some parts of Asia, for the sake of the seeds, which are farinaceous, and are used as food, although, when raw, they have a strong, disagreeable, bitter taste, which is removed by steeping in water and boiling. They were a favourite kind of pulse amongst the ancient Greeks and Romans, and still are so in some parts of the south of Europe, although generally disliked by those who have not been accustomed to them. They are used in many countries for feeding cattle, particularly draught-oxen.—The **YELLOW L.** (*L. luteus*), so called from its yellow flowers, and the **EGYPTIAN WHITE L.** (*L. termis*), which has white flowers tipped with blue, are also cultivated in the south of Europe, Egypt, &c., for their seeds, which are similar in their qualities to those of the white lupine.—In many countries, lupines, and particularly the white lupine, are cultivated to yield green food for cattle, and also to be ploughed down for manure. They grow well on poor and dry sandy soils, which by this process of *green-manuring*, are fitted for other crops. Many species of L. are cultivated in our flower-gardens, having beautiful white, yellow, pink, or blue flowers. The flowers of some species are fragrant. No L. is a native of Britain. *L. perennis* adorns sandy places from Canada to Florida with its fine blue flowers.

LUPULINE. See HOPS.

LUPUS is a chronic disease of the skin, in which dull or livid tubercles are developed, which have a tendency to destroy or seriously to affect the adjacent tissues, with or without ulceration, and commonly ending in indelible cicatrices. It was formerly known as *noli me tangere*. The disease usually attacks the face, especially the ale of the nose and the lips, but is sometimes met with elsewhere. It is a terrible disease, but is happily of rare occurrence. It derives its name from the Latin word for a wolf, in consequence of its destructive nature.

Lupus usually commences with the appearance of one or two circular or oval, dull-red, somewhat translucent tubercles, about two lines in diameter. After a time, these tubercles increase in number and size, and take on new characters. They may ulcerate, constituting the variety known as *Lupus exedens*, in which case the ulceration may pursue a superficial or a deep course. Scabs are formed over the ulcers; and as these scabs are thrown off, the ulcer beneath is found to have increased in extent, till great destruction of the soft parts and (in the case of the nose) of the cartilages is effected. The ulcer of lupus has thick red edges, and exudes a fetid, ichorous matter in considerable quantity. When they do not ulcerate, the tubercles are softer than in the previous variety, and form patches of considerable extent, the intervening skin and cellular tissue also swelling and exhibiting here and there dull-red points, which are the summits of the imbedded tubercles. The lips become much enlarged, the nostrils closed with the swelling, the eyelids everted, and the whole face hideous. This variety is known as *Lupus non exedens*.

The progress of lupus is usually slow, and the sufferings of the patient less than might be expected, in consequence of the sensibility of the parts being diminished from the first. The complaint may continue for years, or even for life, but is seldom fatal. Its causes are not well known, but it is thought that a scrofulous habit and intemperance predispose to the disease. Both sexes are liable to

it, but it seems most common in women. It is not contagious.

The internal treatment consists in the administration of cod-liver oil and the preparations of iodine, especially Donovan's solution, while locally strong escharotics should be applied. The disease is, however, so serious, that whenever there is a suspicion of its nature, professional aid should be sought.

LURCHER, a kind of dog, somewhat resembling a greyhound, and supposed to derive its origin from some of the old rough-haired races of greyhound crossed with the shepherd's dog. It is lower, stouter, and less elegant than the greyhound, almost rivals it in fleetness, and much excels it in scent. It is covered with rough wiry hair, is usually



Lurcher.

of a sandy red colour, although sometimes black or grey, and has half-erect ears and a pendent tail. It is the poacher's favourite dog, possessing all the qualities requisite for his purposes, in sagacity rivalling the most admired dogs, and learning to act on the least hint or sign from its master. Of course, it is detested by gamekeepers, and destroyed on every opportunity.

LURGAN, a thriving town of Ireland, in the county of Armagh, a station on the railway from Belfast to Armagh, 20 miles south-west from the former town. It is unusually neat and clean in appearance, and carries on manufactures of damasks and diapers. Pop. 7766.

LURLEI, or **LORELEI**, the name of a steep rock on the right bank of the Rhine, about 430 feet high, a little way above St Goar, celebrated for its echo, which is said to repeat sounds fifteen times. Near it is a whirlpool, and still nearer, a rapid, called the *Bank*, formed by the river rushing over a number of sunken rocks—visible, however, at low water. In consequence, the navigation of the Rhine by rafts and boats is rather dangerous at this point, which circumstance, in connection with the *echo*, has undoubtedly given rise to the legend of the beautiful but cruel siren who dwelt in a cave of the L., and allured the passing voyagers to approach by the magic melody of her song, until she wrecked and sank them in the whirlpool. The legend has been a great favourite with the German poets, but none has treated it so exquisitely as Heine.

LUSA'TIA (*Lausitz*), a region in Germany, now belonging in part to Saxony and in part to Prussia. It was formerly divided into Upper and Lower L., which constituted two independent margravates, including an area of about 4400 square miles, and a population of about half a million, and bounded on the S. by Bohemia, on the W. by Misnia and the Electorate of Saxony, on the N. by Brandenburg, and on the E. by Silesia. In 1319, L. was given to Bohemia, but was obtained by

Matthias Corvinus in 1478, and was finally transferred to Saxony in 1635; but, by the Congress of Vienna, the whole of Lower L. and the half of Upper L. was ceded to Prussia. The portion left to Saxony now forms the circle of Bautzen.

LU'STRUM (from *luere*, to purify or expiate), the solemn offering made for expiation and purification by one of the censors in name of the Roman people at the conclusion of the Census (q. v.). The animals offered in sacrifice were a boar (*sus*), sheep (*ovis*), and bull (*taurus*), whence the offering was called *Suovtaurilia*. They were led round the assembled people on the Campus Martius before being sacrificed. As the census was quinquennial, the word *lustrum* came to signify a period of five years.

LUTE (Lat. *lutum*, clay), in Chemistry, denotes a substance employed for effectually closing the joints of apparatus, so as to prevent the escape of vapour or gases, or for coating glass vessels so as to render them more capable of sustaining a high temperature, or for repairing fractures. For ordinary purposes, lutes made of common plastic clay or pipeclay with an admixture of linseed-meal or almond-powder, or, for common stills, linseed-meal and water made into a paste, are quite sufficient; for more delicate experiments, *Fat Lute* (q. v.), covered over with moistened bladder, is used. Lutes for coating glass vessels are generally composed of Stourbridge clay or Windsor loam, mixed with water; but the most simple method is to brush the glass retort over with a paste of pipeclay and water, dry it quickly, and repeat the operation till a sufficient thickness of coating is obtained. Other lutes in frequent use are *Willis's lute* (a paste composed of a solution of borax in boiling water, with slaked lime), various mixtures of borax and clay, of lime and white of egg, *iron cement* (see **CEMENTS**), moistened bladder, paper prepared with wax and turpentine, and caoutchouc. The use of the last-named lute has, on account of its flexibility, and consequent non-liability to accident, been rapidly extending.

LUTHER, **MARTIN**, the greatest of the Protestant reformers of the 16th c., was born at Eisleben on the 10th November 1483. His father was a miner in humble circumstances; his mother, as Melancthon records, was a woman of exemplary virtue (*exemplar virtutum*), and peculiarly esteemed in her walk of life. Shortly after Martin's birth, his parents removed to Mansfeld, where their circumstances ere long improved by industry and perseverance. Their son was sent to school; and both at home and in school, his training was of a severe and hardening character. His father sometimes whipped him, he says, 'for a mere trifle till the blood came,' and he was subjected to the scholastic rod fifteen times in one day! Scholastic and parental severity was the rule in these days; but whatever may have been the character of L.'s schoolmaster at Mansfeld, there is no reason to believe that his father was a man of exceptionally stern character. While he whipped his son soundly, he also tenderly cared for him, and was in the habit of carrying him to and from school in his arms with gentle solicitude. L.'s schooling was completed at Magdeburg and Eisenach, and at the latter place he attracted the notice of a good lady of the name of Cotta, who provided him with a comfortable home during his stay there.

When he had reached his eighteenth year, he entered the university of Erfurt, with the view of qualifying himself for the legal profession. He went through the usual studies in the classics and the schoolmen, and took his degree of Doctor of

Philosophy, or Master of Arts, in 1505, when he was twenty-one years of age. Previous to this, however, a profound change of feeling had begun in him. Chancing one day to examine the Vulgate in the University Library, he saw with astonishment that there were more gospels and epistles than in the lectionaries. He was arrested by the contents of his newly-found treasure. His heart was deeply touched, and he resolved to devote himself to a spiritual life. He separated himself from his friends and fellow-students, and withdrew into the Augustine convent at Erfurt.

Here he spent the next three years of his life—years of peculiar interest and significance; for it was during this time that he laid, in the study of the Bible and of Augustine, the foundation of those doctrinal convictions which were afterwards to rouse and strengthen him in his struggle against the papacy. He describes very vividly the spiritual crisis through which he passed, the burden of sin which so long lay upon him, 'too heavy to be borne;' and the relief that he at length found in the clear apprehension of the doctrine of the 'forgiveness of sins' through the grace of Christ.

In the year 1507, L. was ordained a priest, and in the following year he removed to Wittenberg, destined to derive its chief celebrity from his name. He became a teacher in the new university, founded there by the Elector Frederick of Saxony. At first, he lectured on dialectics and physics, but his heart was already given to theology, and in 1509 he became a Bachelor of Theology, and commenced lecturing on the Holy Scriptures. His lectures made a great impression, and the novelty of his views already began to excite attention. 'This monk,' said the rector of the university, 'will puzzle our doctors, and bring in a new doctrine.' Besides lecturing, he began to preach, and his sermons reached a wider audience, and produced a still more powerful influence. His words, as Melancthon said, were 'born not on his lips, but in his soul,' and they moved profoundly the souls of all who heard them.

In 1510 or 1511, he was sent on a mission to Rome, and he has described very vividly what he saw and heard there. His devout and unquestioning reverence, for he was yet in his own subsequent view 'a most insane papist,' appears in strange conflict with his awakened thoughtfulness and the moral indignation at the abuses of the papacy beginning to stir in him.

On L.'s return from Rome, he was made a Doctor of the Holy Scriptures, and his career as a Reformer may be said to have commenced. The system of indulgences had reached a scandalous height. The idea that it was in the power of the church to forgive sin, had gradually grown into the notion, which was widely spread, that the pope could issue pardons of his own free will, which, being dispensed to the faithful, exonerated them from the consequences of their transgressions. The sale of these pardons had become an organised part of the papal system. Money was largely needed at Rome, to feed the extravagances of the papal court; and its numerous emissaries sought everywhere to raise funds by the sale of 'indulgences,' as they were called, for the sins of frail humanity: the principal of these was John Tetzel, a Dominican friar, who had established himself at Jüterboch, on the borders of Saxony. L.'s indignation at the shameless traffic which this man carried on, finally became irrepressible: 'God willing,' he exclaimed, 'I will beat a hole in his drum.' He drew out 95 theses on the doctrine of indulgences, which he nailed up on the gate of the church at Wittenberg, and which he offered to maintain in the university against all

impugners. The general purport of these theses was to deny to the pope all right to forgive sins. 'If the sinner was truly contrite, he received complete forgiveness. The pope's absolution had no value in and for itself.'

This sudden and bold step of L. was all that was necessary to awaken a widespread excitement. The news of it spread rapidly far and wide. It seemed 'as if angels had carried it to the ears of all men.' Tetzel was forced to retreat from the borders of Saxony to Frankfurt-on-the-Oder, where he drew out and published a set of counter-theses, and publicly committed those of L. to the flames. The students at Wittenberg retaliated by burning Tetzel's theses. The elector refused to interfere, and the excitement increased as new combatants—Hochstratten, Prierias, and Eck—entered the field. Eck was an able man, and an old friend of L.'s, and the argument between him and the Reformer was especially vehement.

At first, the pope, Leo X., took little heed of the disturbance; he is reported even to have said when he heard of it, that 'Friar Martin was a man of genius, and that he did not wish to have him molested.' Some of the cardinals, however, saw the real character of the movement, which gradually assumed a seriousness evident even to the pope; and L. received a summons to appear at Rome, and answer for his theses. Once again in Rome, it is unlikely he would ever have been allowed to return. His university and the elector interfered, and a legate was sent to Germany to hear and determine the case. Cardinal Cajetan was the legate, and he was but little fitted to deal with Luther. He would enter into no argument with him, but merely called upon him to retract. L. refused, and fled from Augsburg, whither he had gone to meet the papal representative. The task of negotiation was then undertaken by Miltitz, a German, and envoy of the pope to the Saxon court, and by his greater address, a temporary peace was obtained. This did not last long. The Reformer was too deeply moved to keep silent. 'God hurries and drives me,' he said; 'I am not master of myself: I wish to be quiet, and am hurried into the midst of tumults.' Dr Eck and he held a memorable disputation at Leipzig, in which the subject of argument was no longer merely the question of indulgences, but the general power of the pope. The disputation, of course, came to no practical result; each controversialist claimed the victory, and L. in the meantime made progress in freedom of opinion, and attacked the papal system as a whole more boldly. Erasmus and Hutten joined in the conflict, which waxed more loud and threatening.

In 1520, the reformer published his famous address to the 'Christian Nobles of Germany.' This was followed in the same year by a treatise *On the Babylonish Captivity of the Church*. In these works, both of which circulated widely, and powerfully influenced many minds, L. took firmer and broader ground; he attacked not only the abuses of the papacy, and its pretensions to supremacy, but also the doctrinal system of the Church of Rome. 'These works,' Ranke says, 'contain the kernel of the whole Reformation.' The papal bull was issued against him; the dread document was burned before an assembled multitude of doctors, students, and citizens at the Elster Gate of Wittenberg. Germany was convulsed with excitement. Eck (who had been the chief agent in obtaining the bull) fled from place to place, glad to escape with his life, and L. was everywhere the hero of the hour.

Charles V. had at this time succeeded to the

empire, and he convened his first diet of the sovereigns and states at Worms. The diet met in the beginning of 1521; an order was issued for the destruction of L.'s books, and he himself was summoned to appear before the diet. This was above all what he desired—to confess the truth before the assembled powers of Germany. He resolved to obey the summons, come what would. All Germany was moved by his heroism; his journey resembled a triumph; the threats of enemies and the anxieties of friends alike failed to move him. 'I am resolved to enter Worms,' he said, 'although as many devils should set at me as there are tiles on the house-tops.' His appearance and demeanour before the diet, and the firmness with which he held his ground, and refused to retract, all make a striking picture. 'Unless I be convinced,' he said, 'by Scripture and reason, I neither can nor dare retract anything, for my conscience is a captive to God's word, and it is neither safe nor right to go against conscience. There I take my stand. I can do no otherwise. So help me, God. Amen.'

On his return from Worms, he was seized, at the instigation of his friend, the Elector of Saxony, and safely lodged in the old castle of the Wartburg. The affair was made to assume an aspect of violence, but in reality it was designed to secure him from the destruction which his conduct at Worms would certainly have provoked. He remained in this shelter for about a year, concealed in the guise of a knight. His chief employment was his translation of the Scriptures into his native language. He composed various treatises besides, and injured his health by sedentary habits and hard study. His imagination became morbidly excited, and he thought he saw and heard the Evil One mocking him while engaged in his literary tasks. On one occasion, he hurled his inkstand at the intruder, and made him retreat. The subject of the personality and presence of Satan was a familiar one with L., and he has many things about it in his *Table-talk*.

The disorders which sprang up in the progress of the Reformation recalled L. to Wittenberg. He felt that his presence was necessary to restrain Carlstadt and others, and defying any dangers to which he might still be exposed, he returned to the old scene of his labours, rebuked the unruly spirits who had acquired power in his absence, and resumed with renewed energy his interrupted work. He strove to arrest the excesses of the Zwickau fanatics, and counselled peace and order to the inflamed peasants, while he warned the princes and nobles of the unchristian cruelty of many of their doings, which had driven the people to exasperation and frenzy. At no period of his life is he greater than now in the stand which he made against lawlessness on the one hand and tyranny on the other. He vindicated his claim to be a Reformer in the highest sense by the wise and manly part which he acted in this great social crisis in the history of Germany.

His next act of importance was by no means so commendable. Although he had been at first united in a common cause with Erasmus, estrangement had gradually sprung up between the scholar of Rotterdam and the enthusiastic reformer of Wittenberg. This estrangement came to an open breach in the year 1525, when Erasmus published his treatise *De Libero Arbitrio*. L. immediately followed with his counter-treatise, *De Servo Arbitrio*. The controversy raged loudly between them; and in the vehemence of his hostility to the doctrine of Erasmus, L. was led into various assertions of a very questionable kind, besides indulging in wild abuse of his opponent's character. The quarrel was an unhappy one on both sides; and it must be

confessed there is especially a want of generosity in the manner in which L. continued to cherish the dialike which sprang out of it.

In the course of the same year, L. married Catharine von Bora, one of nine nuns, who, under the influence of his teaching, had emancipated themselves from their religious vows. The step rejoiced his enemies, and even alarmed some of his friends like Melancthon. But it greatly contributed to his happiness, while it served to enrich and strengthen his character. All the most interesting and touching glimpses we get of him henceforth are in connection with his wife and children.

Two years after his marriage, he fell into a dangerous sickness and depression of spirits, from which he was only aroused by the dangers besetting Christendom from the advance of the Turks. Two years later, in 1529, he engaged in his famous conference at Marburg with Zwingli and other Swiss divines. In this conference, he obstinately maintained his peculiar views as to the sacrament of the Lord's Supper (q. v.; see also *IMPANATION*); and as in the controversy with Erasmus, distinguished himself more by the inflexible dogmatism of his opinions, than by the candour and comprehensiveness of his arguments, or the fairness and generosity of his temper. Aggressive and reforming in the first stage of his life, and while he was dealing with practical abuses, he was yet in many respects essentially conservative in his intellectual character, and he shut his mind pertinaciously after middle life to any advance in doctrinal opinion. The following year finds him at Coburg, while the diet sat at Augsburg. It was deemed prudent to intrust the interests of the Protestant cause to Melancthon, who attended the diet, but L. removed to Coburg, to be conveniently at hand for consultation. The establishment of the Protestant creed at Augsburg marks the culmination of the German Reformation; and the life of L. from henceforth possesses comparatively little interest. He survived sixteen years longer, but they are years marked by few incidents of importance. He died in the end of February 1546.

L.'s character presents an imposing combination of great qualities. Endowed with broad human sympathies, massive energy, manly and affectionate simplicity, and rich, if sometimes coarse humour, he is at the same time a spiritual genius. His intuitions of divine truth were bold, vivid, and penetrating, if not comprehensive; and he possessed the art which God alone gives to the finer and abler spirits that He calls to do special work in this world, of kindling other souls with the fire of his own convictions, and awakening them to a higher consciousness of religion and duty. He was a leader of men, therefore, and a Reformer in the highest sense. His powers were fitted to his appointed task: it was a task of Titanic magnitude, and he was a Titan in intellectual robustness and moral strength and courage. It was only the divine energy which swayed him, and of which he recognised himself the organ, that could have accomplished what he did.

Reckoned as a mere theologian, there are others who take higher rank. There is a lack of patient thoughtfulness and philosophical temper in his doctrinal discussions; but the absence of these very qualities gave wings to his bold, if sometimes crude conceptions, and enabled him to triumph in the struggle for life or death in which he was engaged. To initiate the religious movement which was destined to renew the face of Europe, and give a nobler and more enduring life to the Saxon nations, required a gigantic will, which, instead of being crushed by opposition, or frightened by

hatred, should only gather strength from the fierceness of the conflict before it. To clear the air thoroughly, as he himself said, thunder and lightning are necessary; and he was well content to represent these agencies in the great work of Reformation in the 16th century. Upon the whole, it may be said that history presents few greater characters—few that excite at once more love and admiration, and in which we see tenderness, humour, and a certain picturesque grace and poetic sensibility more happily combine with a lofty and magnanimous, if sometimes rugged sublimity.

L's works are very voluminous, partly in Latin, and partly in German. Among those of more general interest are his *Table-talk*, his *Letters* and *Sermons*. De Wette has given to the public a copious and valuable edition of his *Letters*, which, along with his *Table-talk*, are the chief authority for his life. Many special lives of him, however, have been written, by Melancthon, Michelet, Audin, and others.

LUTHERANS, a designation originally applied by their adversaries to the Reformers of the 16th c., and which afterwards was distinctively appropriated among Protestants themselves to those who took part with Martin Luther against the Swiss Reformers, particularly in the controversies regarding the Lord's Supper. It is so employed to this day, as the designation of one of the two great sections into which the Protestant Church was soon unhappily divided, the other being known as the *Reformed* (q. v.). To the end of Luther's life, perfect harmony subsisted between him and his friend Melancthon; but already there were some who stood forth as more Lutheran than Luther, and by whom Melancthon was denounced as a *Crypto-Calvinist* and a traitor to evangelical truth. After Luther's death, this party became more confident; and holding by Luther's words, without having imbibed his spirit, changed his evangelical doctrine into a dry scholasticism and lifeless orthodoxy, whilst extreme heat and violence against their opponents were substituted in the pulpit itself for the zealous preaching of the gospel. The principal seat of their strength was in the university of Jena, which was founded in 1557 for this very object, and maintained their cause against Wittenberg. The utmost illiberality characterised this party; and in so far as governments came under their influence, extreme intolerance was manifested, the measures adopted against those who differed from them being not unfrequently of a persecuting nature. No controversy was ever conducted with more bitterness than the *Sacramentarian Controversy* (q. v.).

Towards the end of the 17th c., the Lutherans of Germany found a new object of hostility in the *Pietists* (q. v.), against whom they stirred up the passions of the multitude, and instigated the governments to severity.—In the 18th c., they came into conflict with *Rationalism* (q. v.), which may be regarded as a consequence of the state of things existing in Germany during the previous period of unprofitable theological strife.—When, after the wars of the French Revolution were over, the Prussian government formed and carried into execution a scheme for the union of the Lutheran and Reformed churches into one national church (see PRUSSIA), an active opposition arose on the part of those who now began to be known as *Old Lutherans*. Separate congregations were formed, and an attitude of open hostility to the government was assumed by some; whilst others, more moderate, but holding the same theological opinions, continued to maintain these opinions within the *United Evangelical Church*. Amongst the latter are some of the most eminent divines in

Germany, as Hengstenberg, Olshausen, Guericke, and Tholuck. The separatists were for some time severely dealt with by the government, and consequently many left their native country to found Old Lutheran communities in America and Australia. This took place chiefly about the year 1837. After that time, greater toleration was practised, and now the Old Lutherans form a legally recognised ecclesiastical body in Prussia. For some time after the political excitement of 1848, those who held the Lutheran doctrines within the national or United Evangelical Church of Prussia, exhibited considerable uneasiness, and a strong desire for a position more consistent with their ecclesiastical traditions; but more recently this feeling seems to have been considerably allayed.

Lutheranism is the prevailing form of Protestantism in Saxony, Hanover, and the greater part of Northern Germany, as well as in Würtemberg; it also prevails to a considerable extent in other parts of Germany. It is the national religion of Denmark, Sweden, and Norway; and there are Lutheran churches in Holland, France, Poland, &c. Amongst the Lutheran symbolical books, the *Augsburg Confession* (q. v.) holds the principal place; but the supreme authority of the Holy Scriptures is fully recognised. The chief difference between the Lutherans and the Reformed is as to the *real presence* of Christ in the sacrament of the Supper; the Lutherans holding the doctrine of *consubstantiation*, although rejecting *transubstantiation* (see LORD'S SUPPER; IMPANATION; and TRANSUBSTANTIATION); whilst some of their more extreme theologians have asserted not only the presence of the human nature of Christ in the Lord's Supper, as Luther did, but the absolute omnipresence of his human nature. Other points of difference relate to the allowance in Christian worship of things *indifferent* (*adiaphora*); and many of those things at first retained as merely tolerable by Luther and his fellow-reformers, have become favourite and distinguishing characteristics of some of the Lutheran churches—as images and pictures in places of worship, clerical vestments, the form of exorcism in baptism, &c. Amongst the Old Lutherans of Prussia, particularly the separatists, a strong tendency to exaggeration in these distinctive peculiarities has manifested itself.

In many of the Lutheran churches, the doctrines of Luther, and of their symbolical books, have long given place, in a great measure, to Arminianism, and to a system of religion very inconsistent with Luther's doctrine of justification by faith. In some quarters, particularly in Norway and Sweden, a reaction has of late years appeared; and many of the Lutheran divines of Germany are strenuous supporters of the 'evangelical' doctrines of the Reformers.

In its constitution, the Lutheran Church is generally *unepiscopal*, without being properly *presbyterian*. In Denmark and Sweden there are bishops, and in Sweden an archbishop (of Upsal), but their powers are very limited. Where Lutheranism is the national religion, the sovereign is recognised as the supreme bishop, and the church is governed by consistories appointed by him, and composed both of clergymen and laymen. The members of congregations possess almost no rights.

LUTON, a market-town and parish of England, county Bedford, situated 30 miles north-north-west of London, on the river Lea, which rises in the parish. It is connected with the London and North-western and the Great Northern Railways by branch-lines from Leighton Buzzard to Hatfield. Staple trade, straw-hat manufacture. Pop. of town, 15,329. The parish church, an ancient and noble

LÜTZEN—LUXEMBURG.

structure, contains an elegant, and perhaps unique, baptismal font.

LÜTZEN, a small town of 2509 inhabitants, in the Prussian province of Saxony, famous for two great battles fought in its vicinity. The first took place on 4th November 1632. Gustavus Adolphus, who had moved in the direction of Bavaria, being recalled from his designs of conquest there by the advance of Wallenstein on Saxony, united his forces with those of Duke Bernard of Saxe-Weimar, and attacked the Imperialists at Lützen. The fortune of the day was very various; but notwithstanding the death of Gustavus Adolphus, victory remained with the Swedes, and Wallenstein was compelled to resign to them the field of battle. About 9000 men were killed and severely wounded.

The *Battle of L.*, on 2d May 1813, was fought somewhat further to the south, at the village of Groszgrüchen. It was the first great conflict of the united Russian and Prussian army with the army of Napoleon in that decisive campaign. The allies gained at first great successes, but the French were left in possession of the field at the close of the day; their superiority in numbers securing them the victory, although they lost about 12,000 men, and the allies only 10,000. By this battle, the French regained possession of Saxony and the Elbe.

LUXEMBOURG, FRANÇOIS HENRI DE MONTMORENCY, DUKE OF, Marshal of France, a famous general of Louis XIV., born at Paris 8th January 1628, was the posthumous son of François de Montmorency, Count of Bouteville, who was beheaded on account of a duel. His aunt, the mother of the Great Condé, brought him up as a companion of her son, with whom he took part in the disturbances of the Fronde, signalling himself in the battles then fought. Being afterwards received into favour by Louis XIV., he served as a volunteer under Turenne in Flanders (1667), in Franche Comté as the lieutenant-general of Condé, and in the Netherlands, where the battles of Grool, Deventer, Zwoll, &c., greatly increased his reputation. He had, however, the misfortune to embroil himself in a quarrel with the all-powerful Louvois, the results of which were disastrous to his prospects for a time. He assumed the title of L. on marrying the heiress of that house. Some of his military exploits were very daring, and were executed with great skill; his retreat from Holland, in particular, being executed in such a masterly manner, that it placed him among the foremost generals of his age; but he largely participated in the savage burning of towns, and desolating of conquered districts, which disgraced the French arms at that period, though it is believed that in this he only carried out the positive instructions which he received from Louvois (q. v.). In the campaign of 1677, he defeated the Prince of Orange at Mont-Cassel, took St Omer, and compelled the prince to raise the siege of Charleroi. After the Peace of Nimeguen, Louvois attempted to accomplish his destruction by means almost incredible. Having got possession of a contract between L. and a wood-merchant, he caused it to be changed so that it became a contract with the devil. Upon this, L. was summoned before the *Chambre Ardente*, and obeyed the citation, although his friends advised him to leave the country. He was thrown into the Bastille, and there confined in a dark dungeon. After fourteen months, he was acquitted and released, but banished to one of his domains, where he lived forgotten for ten years, at the end of which time, the king appointed him to the command of the army in Flanders. On the 1st

July 1690, he gained a victory over the Prince of Waldeck at Fleurus; on 4th August 1692, and 29th July 1693, over William III. of England, at Steenkirk and at Neerwinden. He took Charleroi 12th October 1693. He died 4th January 1695. L. was crooked in shape and feeble in body, but possessed an inexhaustible activity of spirit.

LUXEMBURG, an old German county, and afterwards a duchy, which, about the 12th c., came into possession of the Counts of Limburg, who assumed the title of Counts of Luxemburg. It was next acquired by Burgundy, and in this way came into the hands of Austria. By the Peace of Campo Formio (q. v.), it was ceded to France in 1797. In 1814, it was elevated to the rank of a grand duchy of the German Confederation, and given to Holland in compensation for the loss of Nassau. In 1830, when Belgium formed itself into an independent kingdom, L. was divided between it and Holland—the latter, however, retaining little more than the fortress of Luxemburg, till 1839, when, by a treaty signed in London, a new division was made more favourable to Holland.—BELGIAN L., or LUXEMBOURG, the largest province of Belgium, forming the south-east corner of the country, contains an area of 1690 English square miles, with a population (1861) of 202,080. It is traversed from south-west to north-east by a branch of the Ardennes, which nowhere exceed 2000 feet in height. The surface is in general extremely rugged, much covered with woods and morasses. The soil is poor. About a third of the arable land is devoted to pasture, great numbers of cattle, sheep, and horses being reared for export. The horses are a strong, hardy breed, much prized both for agricultural and military purposes. The mineral wealth of the country consists of iron, lead, copper, marble, freestone, slate, gypsum, &c. The chief manufactures are cloth, tulle, earthenware, leather, nails, and potash; and the principal articles of export are hemp, flax, oak-bark, timber, iron, leather, cheese, &c. The capital of the province, Arlon, has a pop. of 4200.—DUTCH L., which is not incorporated with the kingdom of Holland—the king of that country being only grand-duke of L.—ranks as a duchy in the Germanic Confederation. It lies east of the Belgian province of the same name, and quite apart from the other provinces of Holland. It has an area of 979 English square miles, with a pop. of (1861) 196,804, the most of whom are engaged in agriculture, which, notwithstanding, is in a very backward condition, owing to the unkindly nature of the soil. The chief products are wine, corn, hops, hemp, and flax; mines of iron in the eastern districts yield annually about 9000 tons after smelting, and the quarries of lime and slate are extensive. The inhabitants are mostly Walloons, and the remainder chiefly Germans. The capital of the province is Luxemburg (q. v.). L., united with Limburg, occupies the 11th place in the Germanic Confederation, furnishes a contingent of 2706 men to the federal army, and possesses 3 votes in the *plenum*. See GERMANY.

LUXEMBURG, the capital of Dutch Luxembourg, is situated on the Else or Alsette, 76 miles south-by-east from Liege, and possesses a pop. of about 11,000. Its situation has often been compared to that of Jerusalem, being, like the latter, surrounded by escarped rocks, which, excepting the west side, average 200 feet in height. The Spaniards, Austrians, French, and Dutch, who successively held possession of the town, so increased and strengthened its fortifications that in the beginning of the 19th c. it was considered to be, with the exception of Gibraltar, the strongest fortress in Europe. Another portion of L., called the 'low town,'

is situated at the foot of the precipice, along the banks of the river. It possesses a fine cathedral, various handsome buildings and public institutions. It has also manufactures of wax, distilleries, breweries, tanneries, and an extensive general trade. It is one of the federal fortresses, and is garrisoned by Prussian troops.

LUZON, the largest and most northerly of the Philippine Islands (q. v.).

LYCANTHROPIA (Gr. *lycos*, a wolf; *anthropos*, a man), wolf-madness. There has been in various countries and times a popular superstition and dread that men had been transmuted into wolves by Satanic agency, and roamed through forests and desert places actuated by the same appetites as the wild beast whose aspect or name they bore. The panic thus inspired may have suggested the delusion now under consideration, where the process of transformation was purely subjective, and the transforming power disease. Many instances occur, and may be encountered in every asylum, in which the insane conceive themselves dogs (*Cynanthropia*) and other animals, and even inanimate objects; but these are solitary cases, whereas this hallucination has appeared epidemically, and lycanthropes have literally herded and hunted together in packs. In 1600, multitudes were attacked with the disease in the Jura, emulated the destructive habits of the wolf, murdered and devoured children; howled, walked, or attempted progression upon all-fours, so that the palms of the hands became hard and horny; and admitted that they congregated in the mountains for a sort of cannibal or devil's Sabbath. Imprisonment, burning, scarcely sufficed to check what grew into a source of public danger. Six hundred persons were executed on their own confession. Cases in which the sufferer boasts of being a wolf, creeps like a quadruped, barks, leaps, bites, and which in other respects are closely allied to these, still happen in sufficient frequency to suggest the lesson, that we are chiefly protected from the prevalence of such a moral pestilence by education, the greater diffusion of knowledge and sound principle, and by attention to the laws of health.—Calmiel, *De la Folie*; Arnold, *On Insanity*.

LYCAON, a genus of *Canidae*, in dentition and general osteological structure nearly agreeing with dogs, but resembling hyenas in the form of the head and in having only four toes on each foot. The best ascertained species, *L. venaticus*, the WILD DOG, HYENA DOG, or HUNTING DOG of the Cape of Good Hope, is rather smaller than a mastiff, and has a tall, gaunt form. It is gregarious, and still infests even the neighbourhood of Cape Town, committing great depredations on flocks of sheep. It is found over great part of Africa, from the Cape of Good Hope to the valley of the Nile.

LYCAONIA, in ancient geography, a country in Asia Minor, bounded on the E. by Cappadocia, on the N. by Galatia, on the W. by Pisidia, and on the S. by Isauria and Cilicia. Its capital was Iconium (q. v.).

LYCEUM (Gr. *Lukeion*), originally the name of a place in the immediate neighbourhood of Athens, consecrated to *Apollo Lyceus*, and noted for its shady wood and beautiful gardens, but particularly for its gymnasium, in which Aristotle and the Peripatetics taught, and from which the Romans borrowed the same name for similar institutions. In more modern times, the name *L.* was given in honour of Aristotle to the higher Latin schools in which the Aristotelian philosophy formed a principal branch of education; and at the present day, the name is variously applied to educational and literary institutions.

LYCH-GATE (Ang.-Sax. *lic* or *lice*, a body, corpse), or CORPSE-GATE, a churchyard gate covered with a roof. It is very common in many parts of England. The bodies of persons brought

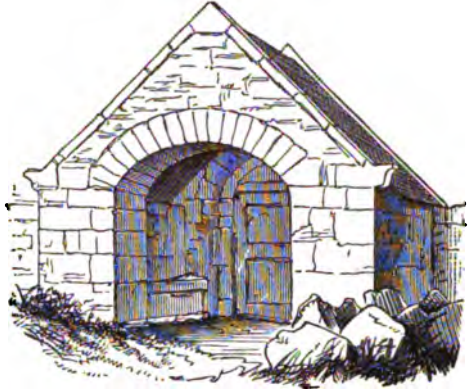

Lych or Corpse Gate.

for burial are set down under the shelter of the roof while the service is read. Lych-gates are very rare in Scotland. There is one at Peebles; the illustration represents one at Blackford Church, in Perthshire.

LY'CHNIS, a genus of plants of the natural order *Caryophyllaceae*; having a tubular 5-toothed calyx; corolla twice as long as the calyx, with a spreading wheel-shaped limb, crowned at the mouth of the tube, and generally divided at the border; ten stamens, and five styles. The species are herbaceous plants, generally perennial, natives of temperate countries. Several are found in Britain. The RAGGED ROBIN (*L. flo-cuculi*) is one of the most frequent ornaments of meadows and moist pastures; the GERMAN CATCHFLY (*L. viscaria*), very rare, and generally found growing on almost inaccessible precipices; the RED CAMPION (*L. diurna*), and the WHITE CAMPION (*L. vespertina*), abound in fields, hedges, and the borders of woods. The last two are dioecious, and, strangely enough, the female of the first and the male of the second are very common, while the male of the first and female of the second are rather rare. The flowers of *L. vespertina* are usually fragrant in the evening. The SCARLET L. (*L. Chalcadonica*), a native of Asia Minor, is a frequent and brilliant ornament of flower-borders. Some of the species have saponaceous properties.

LY'CIA, a country on the south coast of Asia Minor, extending towards Mount Taurus, and bounded on the W. by Caria, on the N. by Phrygia and Pisidia, and on the E. by Pamphylia. The most ancient inhabitants are said to have been two Semitic races called the *Solyms* and *Termila*, the former of whom were driven from the coast to the mountains in the north by adventurers from Crete, under the command of Sarpedon, a brother of Minos, who first gave the country the name of Lycia. To what race the invaders belonged, is not certain; they were, however, not of Hellenic origin. The Lycians are prominent in the Homeric legend of the Trojan war. It shared the vicissitudes of the other states of Asia Minor, becoming subject to the Persian and Syrian monarchies, and then to Rome. During the time of its independence, it consisted of 23 confederate cities, of which the principal were Xanthus, Patara, Pinara, Olympus, Myra, and Tlios; and at the head of the whole confederation was a president or governor called the Lyciarch. Many

monuments and ruined buildings (temples, tombs, theatres, &c.), exquisite sculptures, coins, and other antiquities, testify to the attainments of the Lycians in civilisation and the arts, in which they rival the Greeks themselves. These antiquities, however, had received little attention, till Sir Charles Fellows, about twenty years ago, pointed out their interesting character. Since that time, they have been very assiduously explored and studied. A beautiful collection of Lycian sculptures, made by Sir Charles, is now to be seen in the British Museum. The most interesting of all the antiquities of L. are, however, the inscriptions in which a peculiar alphabet is used, nearly allied to the Phrygian, and the language of which appears to be an Indo-Germanic language mingled with Semitic words. Grotefend, Sharpe, Daniell, and others, have spent much labour in deciphering these inscriptions.

LYCOPERDON. See PUFF-BALL.

LYCOPODIA'CEÆ, a natural order of acrogamous or cryptogamous plants, somewhat resembling mosses, but of higher organisation, and by many botanists included amongst ferns as a sub-order. They have creeping stems and imbricated leaves. The axis consists entirely, or in great part, of annular vessels; the leaves are narrow and 1-nerved. The *theca*, or spore-cases, are axillary, sessile, 1-3-celled, opening by valves, or not at all, and often of two kinds, the one containing minute powdery matter, the other sporules of much larger size, which are capable of germinating. The powdery particles have by some been regarded as *antheridia* (see ANTHERIDIUM), but the question of their nature is still involved in uncertainty.—The L. are most abundant in hot humid situations, especially in tropical islands, although some are found in very cold climates. About two hundred species are known.—The only British genus is *Lycopodium*, of which six species are natives of Britain. The most abundant, both in Britain and on the continent of Europe, is the common CLUB-MOSS (*L. clavatum*), which creeps upon the ground in heathy pastures, with branching stems, often many feet long. A decoction of this plant is employed by the Poles to cure that frightful disease the *plica polonica*. The yellow dust or meal which issues from its spore-cases, and from those of *L. Selago*, is collected and used for producing the lightning of theatres, being very inflammable, and kindling with a sudden blaze when thrown upon a candle, the combustion taking place so



Club Moss (*Lycopodium clavatum*).

rapidly that nothing else is liable to be kindled by it. It is called *Lycopode* and *Vegetable Brimstone*, and by the Germans, *Lightning-meal* and *Wüch-meal* (*Blitz-mehl* and *Hexen-mehl*). It is used for rolling up pills, which, when coated with it, may be put into water without being moistened. It is sprinkled upon the excoorations of infants, and upon parts affected with erysipelas, herpetic ulceration, &c. It is even used, although rarely, as a medicine in diseases of the urinary organs. The powder of other species is also regarded in Brazil and other countries as possessing power over the urinary and generative organs. The stems and leaves of

L. clavatum are emetic, those of *L. Selago* cathartic; a South American species, *L. catharticum*, is violently purgative, and is administered in cases of elephantiasis. *L. Selago* is employed by the Swedes to destroy lice on swine and other animals. *L. alpinum* is used in Iceland for dyeing woollen cloth yellow, the cloth being simply boiled with a quantity of the plant and a few leaves of the bog whortleberry. *L. complanatum* is used for the same purpose in Lapland, along with birch-leaves.—Many of the L. are very beautiful plants, and are much cultivated in hot-houses, green-houses, and fern-cases, in which they grow very luxuriantly.

LYOUREGUS, a celebrated Spartan lawgiver, whose history and legislation are involved in so much obscurity, that many modern critics have suspected them to be mythical. The account usually given is as follows: L., who flourished about 880 B. C. (or, according to others, about 1100 B. C.), was descended from the old Doric family of the Proclids. His brother, Polydectes, king of Sparta, died, leaving his widow with child. This ambitious woman proposed to L. that he should marry her, in event of which she promised to destroy the fruit of her womb. L. was shocked, but feigned consent in order to save his brother's offspring. As soon as the child, who was named Charilans, was born, he proclaimed him king, and became his guardian. At this time, Sparta is represented as being in a state of great disorder and demoralisation—the different sections of the community quarrelling among themselves for political supremacy. L. after some years left his native country, and travelled through many foreign lands—Crete, Asia Minor, India, Egypt, Libya, and Iberia—examining and comparing the political constitutions of the different countries, and finally returned to Sparta, full of knowledge fitting him to become one of the greatest legislators in the world. During his absence, things had got much worse in Sparta, and he had no sooner arrived than the entire community requested him to draw up a constitution for them. To this he consented, and having induced them to solemnly swear that they would make no change in his laws till he came back, he again left Sparta, and was never more heard of. By this mysterious self-expatriation, he hoped to make the Spartan constitution eternal. The people now saw that he was a god; a temple was erected in his honour, and annual sacrifices were ever afterwards offered to him. No critical scholar considers such a geography historical; the most that can be assumed as probable is, that a certain L. may have once existed, who at some critical juncture in Spartan affairs may have been selected, probably on account of his wisdom and reputation, to draw up a code of laws for the better government of the state. To represent the entire legislation of Sparta as invented (so to speak) by L., and imposed upon the people as a novelty, is simply incredible; the only theory worth a moment's consideration is that which supposes him to have collected, modified, improved, and enlarged the previously existing institutions of Sparta (q. v.).

LY'DIA, anciently, a country of Asia Minor, bounded on the W. by Ionia, on the S. by Caria, on the E. by Phrygia, and on the N. by Mysia. It is said to have been originally inhabited by a people called Mæonians (whether of Semitic or Indo-Pelaëgic origin is much disputed by modern ethnographers), who were subdued or expelled by the Lydians (about 720 B. C.), a Carian race. The country was mountainous in the south and west—the principal range being that of Tmolus. It was celebrated for its fruitful soil, and for its mineral

wealth, particularly for the gold of the river Pactolus and of the neighbouring mines, but was infamous for the corruption of morals which prevailed amongst its inhabitants, and especially in Sardis (q. v.), its capital. L. attained its highest prosperity under the dynasty of the Merminades (circa 700—546 a. c.). The first of this dynasty was the half-mythical Gyges (q. v.)—the last was the famous Croesus (q. v.), celebrated for his prodigious wealth. The subsequent history of L. is unimportant. Its antiquities have not yet been sufficiently explored. Compare Niebuhr's *Lectures on Ancient History*; Hamilton's *Researches*, and Menke's *Lydiaca, Dissertatio Ethnographica*.

LYDIAN MODE, one of the ancient Greek authentic modes in music, which was retained as one of the old church modes, the notes being F, G, A, B, C, D, E, F, the same as in our modern diatonic scale. Since the Reformation, the melodies in the Lydian mode have entirely disappeared, and the Lydian mode is used only occasionally in modulation from other modes.

LYDIAN STONE, a variety of flinty slate, but less hard than common flinty slate, and not of a slaty structure. It occurs in Britain and in many other countries, but was first brought from Lydia. It is generally grayish black, or quite black and velvet-like. It is polished, and employed as a touchstone for trying the purity of gold and silver by comparison of colours.

LYE, a term sometimes used to denote all solutions of salts, but more generally appropriated to solutions of the fixed alkalis, potash and soda, in water. The solutions of caustic potash and soda are called caustic lyes; those of their carbonates, mild lyes. The fluid which remains after a substance has been separated from its solution by crystallisation, is called the *Mother Lye*.

LYELL, SIR CHARLES, an eminent living geologist, is the eldest son of the late Charles Lyell, Esq., of Kinnordy, Forfarshire. He was born in 1797, and after receiving his early education at Midhurst, in Sussex, was entered at Exeter College, Oxford, where he graduated as B.A. in 1819. Here he attended the lectures of Buckland, and thus acquired a taste for the science he has since done so much to promote. After leaving the university, he studied law, and in due time was called to the bar; but his circumstances not rendering a profession necessary for a livelihood, he soon abandoned the law, and devoted himself to the prosecution of geology. To extend his knowledge in this department of science, he made geological tours in 1824, and again in 1828—1830, over various parts of Europe, and published the results of his investigations in the *Transactions of the Geological Society* and elsewhere. The first volume of his great work, *The Principles of Geology*, appeared in 1830, the second in 1832, and the third in 1833. A third edition of the whole work, in four volumes, appeared in 1834, a fourth in 1835, and a fifth in 1837. This work was divided into two parts, which have been subsequently published as two distinct works—viz., *The Principles of Geology; or the Modern Changes of the Earth and its Inhabitants, as illustrated by its Geological Monuments*, of which the sixth edition is now in the press. L. has also pub-

lished *A First and Second Visit to North America, Canada, Nova Scotia, &c., with Geological Observations*, in four volumes, which has reached a second edition; and *The Geological Evidences of the Antiquity of Man, with Remarks on Theories of the Origin of Species by Variation*, 1863; besides a very large number of important geological papers in the *Proceedings and Transactions of the Geological Society*, the *Reports of the British Association*, &c.

L. was one of the early members of the Geological Society; and on the opening of King's College in 1832, he was appointed Professor of Geology, an office which he soon resigned. In 1836, he was elected President of the Geological Society, and was re-elected in 1850. He received the honour of knighthood, on account of his scientific labours, in 1848; and in 1855, the university of Oxford conferred on him the title of D.C.L.

LYLY, JOHN, an English dramatist, born in Kent about 1554, studied at Magdalen College, Oxford, and took his degree of M.A. in 1575. Of his career, nothing is known, except that he lived in London, and supported himself by his pen. He died early in the 17th century. L. wrote nine plays, most of which are on classical subjects—as *Sappho and Phaon*, *Endymion*, *Midas*, *Galathea*, and the *Maid's Metamorphosis*—the lyrics of which frequently display a sweet and graceful fancy; but the two works which have chiefly perpetuated his name are *Euphues, or the Anatomy of Wit*, and *Euphues and his England*. They are written in prose, and are marked by great affectation, bombast, and pedantry in the language and imagery; yet L. is said to have intended them for models of elegant English, and such the court of Elizabeth at least undoubtedly thought them. According to L.'s editor, Blount, 'that beauty at court which could not parley euphuism, that is to say, who was unable to converse in that pure and reformed English which he had formed his work to be the standard of, was as little regarded as she which now there speaks not French.'

LYME GRASS (*Elymus*), a genus of grasses, the species of which are natives of the temperate and colder regions of the northern hemisphere. The spikelets grow in pairs from the joints of the rachis, and each has 2—4 fertile florets, and two awnless glumes, both on the same side.—The SEA L. G. (*E. arenarius*) is frequent on the sandy shores of Britain and other parts of Europe. It is a coarse, grayish grass, often three or four feet high, with spiny-pointed leaves and upright close spikes; a perennial with creeping roots, very useful in binding the sand. On this account, it is much sown on the shores of Holland, and also to some extent on those of Britain. In Iceland and other countries, it is used for thatch. The seed, which is large, is collected in Iceland, and ground into meal, which is made either into porridge or into soft thin cakes, and is esteemed a great delicacy.—A closely allied species* or a variety, called GIANT L. G. (*E. giganteus*), is often sown in Holland, being preferred for its more vigorous growth.—Various expedients are adopted to secure the growth of L. G. seeds in very loose sands, as the laying down of pieces of turf, a gradual advancement from the margin of the sand, &c.

LYME REGIS, a seaport, municipal and parliamentary borough and watering-place of England, in Dorsetshire, is situated at the mouth of a rivulet called the Lym, 26 miles west of Dorchester. It received its first charter in the middle of the 13th c., and was a port of considerable importance during the reign of Edward III., for whom it provided three ships to assist in the siege of Calais in 1346. Its pier,

* This work has hitherto been published under the title of *Manual of Elementary Geology*. The title given in the text is that which is given by Lyell himself in the fly-leaf to his *Antiquity of Man*, 1863.

called the *Cobb*, is semicircular in form. It returns one member to the House of Commons. In 1862, 516 vessels of 21,395 tons entered and cleared the port. Pop. (1861) of parliamentary borough, 3215.

LYMINGTON, a seaport, market-town, and municipal and parliamentary borough of England, in the county of Hants, at the mouth of a river of the same name, and on a creek communicating with the Solent, 18 miles south-south-west of Southampton. Salt has long been manufactured; some of the salt-works being of great antiquity, and possibly of British origin. L. is also of some importance as a watering-place. It commands fine prospects of the Isle of Wight and the English Channel, and its vicinity abounds in charming scenery. L. returns two members to parliament. Pop. (1861) of parliamentary borough, 5179.

LYMPH (Gr. *lymphe*, water) is the term applied by physiologists to the fluid contained in the **LYMPHATICS** (q. v.). It is a colourless or faintly yellowish red fluid, of a rather saltish taste, and with an alkaline reaction. It coagulates shortly after its removal from the living body, and forms a jelly-like, semi-solid mass, which continues for some time to contract, so that at last the clot is very small, in proportion to the expressed serum. On microscopic examination, the lymph is seen to contain corpuscles which do not in any respect differ from the colourless blood-cells, molecular granules, fat globules, and occasionally blood corpuscles. The chemical constituents of lymph seem to be precisely the same as those of blood, excepting the substance peculiar to the red corpuscles.

From experiments on animals, it has been inferred that upwards of 28 lbs. of fluid (lymph and chyle) pass daily into the blood of an adult man.

The lymph seems to owe its origin to two distinct sources—viz., to the ultimate radicles of the lymphatic system, which contribute the homogeneous fluid portion, and the lymphatic glands, which contribute the corpuscles, granules, &c., seen under the microscope.

The uses of the fluid are twofold: in the first place, to convey from the tissues to the blood effete matters, to be afterwards excreted by the skin, lungs, and kidneys; and secondly, to supply new materials for the formation of blood.

LYMPHATICS, the vessels containing the Lymph (q. v.), are also called *Absorbents*, from the property which these vessels possess of absorbing foreign matters into the system, and carrying them into the circulation. The lymphatic system includes not only the lymphatic vessels and the glands through which they pass, but also the **Lacteals** (q. v.), which are nothing more than the lymphatics of the small intestine, and only differ from other lymphatics in conveying Chyle (q. v.) instead of lymph during the latter part of the digestive process.

The lymphatics are minute, delicate, and transparent vessels, of tolerable uniformity in size, and remarkable for their knotted appearance, which is due to the presence of numerous valves, for their frequent dichotomous divisions, and for their division into several branches before entering a gland. They collect the products of digestion and the products of worn-out tissues, and convey them into the venous circulation near the heart. (See the diagram in the article **LACTEALS**.) They are found in nearly every texture and organ of the body, excepting the substance of the brain and spinal cord, the eyeball, cartilage, tendon, and certain foetal strictures, and possibly also the substance of bone.

The lymphatics are arranged in a superficial and a deep set. The superficial vessels on the surface of the body lie immediately beneath the skin, and join

the deep lymphatics in certain points through perforations of the deep fascia; while in the interior of the body they lie in the sub-mucous and sub-serous areolar tissue. They arise in the form of a net-work, from which they pass to lymphatic glands or to a larger trunk. The deep lymphatics are larger than the superficial, and accompany the deep blood-vessels; their mode of origin is not known with certainty. The structure of the lymphatics is similar to that of veins and arteries.

The lymphatic or absorbent glands are small, solid, glandular bodies, varying from the size of a hemp-seed to that of an almond, and situated in the course of the lymphatic vessels. They are found in the neck (where they often become enlarged and inflamed, especially in scrofulous subjects), in the axilla, or arm-pit, in the groin (where, when inflamed, they give rise to the condition known as *Bubo*), and in the ham; while deep ones are found abundantly in the abdomen and the chest.

The lymph of the left side of trunk, of both legs, of the left arm, and the whole of the chyle, is conveyed into the blood by the Thoracic Duct (q. v.); while the lymph of the right side of the head, neck, and trunk, and of the right arm, enters the circulation at the junction of the axillary and internal jugular veins on the right side, by a short trunk, guarded at its opening by valves.

LYNCH LAW, the name given in the United States of America to the trial and punishment of offenders in popular assemblies without reference to the ordinary laws and institutions of the country. This barbarous mode of administering justice has always more or less prevailed in every country in times of great popular excitement, and has been necessarily resorted to in countries newly settled, where the power of the civil government is not yet sufficiently established. The name is derived by Webster from a Virginian farmer.

LYNCHBURG, a city of Virginia, United States of America, on the James River, 120 miles west-south-west of Richmond, remarkable for picturesque situation and scenery. It has 9 churches, a college, female academy, 70 tobacco-factories, 4 iron-foundries, 3 flouring-mills, 3 printing-offices. It is connected by a canal with navigable waters, and by lines of railway with the east, north, and south-west. Pop. in 1860, 9853.

LYNDHURST, LORD (JOHN SINGLETON COPLEY), English lawyer and statesman, was the son of J. S. Copley, R.A., painter of the 'Death of Chatham,' and other esteemed works. The Copleys were an Irish family, the painter's grandfather having emigrated from the county of Limerick, and settled at Boston, United States, where L. was born, May 21, 1772. While he was yet an infant, his father removed to England for the practice of his art. L. was educated at Trinity College, Cambridge, where he was Second Wrangler and Smith's Prizeman in 1794, and a Fellow in 1797. Called to the bar at Lincoln's Inn in 1804, he chose the Midland Circuit, and soon obtained briefs. In politics, he was at first Liberal, and long expressed sentiments hostile to the ministry of the day. He ably defended Watson and Thistlewood on their trial for high treason in 1817, and obtained their acquittal. Some surprise was therefore expressed when, in 1818, he entered parliament for a government borough. In 1819, he became Solicitor-general in the Liverpool administration, and in 1823 was promoted to the rank of Attorney-general. It was much to his credit that, unlike his predecessors, he instituted no *ex officio* informations against the press. In 1826, he became Master of the Rolls. When Mr Canning was charged to form a ministry in

1827, he offered the Great Seal to L. (then Sir John Copley), who was raised to the Upper House, and remained Lord Chancellor from 1827 to 1830. In 1831, he became Lord Chief Baron of the Exchequer, which office he exchanged for the woolstack during the brief administration of Sir R. Peel in 1834. In 1835, he led the opposition to the Melbourne ministry in the Upper House, in speeches of great power and brilliancy. L.'s orations and annual reviews of the session did much to reanimate the Conservative party, and pave the way for their return to power in 1841. He then became Lord Chancellor for the third time, and held the Great Seal until the defeat of the Peel government in 1846. After that time, he took little part in home politics; but his voice has often been heard on matters of foreign policy, and in denunciation of tyranny in Italy and elsewhere. He died in London, October 12, 1863. L.'s high attainments as a lawyer have never been questioned, and his judgments—of which that in the great case of *Small v. Attwood* may be particularly cited—have never been excelled for clearness, method, and legal acumen. In the House of Peers, he had few equals among his contemporaries. So lately as 1860, when he was 88 years of age, he maintained, with great force and ability, the right of their lordships to reject the Paper Duties Bill—an act which the Lower House resented as a breach of its privileges.

LYNN, a city of Massachusetts, United States of America, nine miles north-east of Boston, in which nearly the whole population is engaged in the manufacture of boots and shoes, leather, lasts, and works connected with this manufacture, which amounts to 5,000,000 dollars per annum, employing 11,000 women and 4500 men. A large portion of this manufacture has been for the Southern States. L. has 18 churches, 40 schools, 3 banks, 3 weekly newspapers. Pop. in 1860, 19,083.

LYNN, LYNN REGIS, or KING'S LYNN, a seaport, municipal, and parliamentary borough of England, in the county of Norfolk, is situated about three miles from the mouth of the Great Ouse, and 41 miles west-north-west from Norwich. It was formerly fortified, and the old moat still forms the eastern boundary of the town, and portions of the walls remain. The Grammar-school, with an annual income from endowment of £75, has six exhibitions for Cambridge. Ropes are manufactured here, and ship-building is carried on. Great numbers of shrimps are caught in the vicinity, and sent to London. The imports are corn, oilseed cake, cork, sulphur, wine, coal, and timber. In 1862, 1870 vessels, of 157,497 tons, entered and cleared the port. It returns two members to parliament. The pop. was 16,170 in 1861.

LYNX, a genus of *Felidæ*, having a less elongated form than many others of that family, the body elevated at the haunches, long fur, a short tail, and the ears tipped with tufts or pencils of hairs. They are less courageous than other *Felidæ* of similar size, and prey on small quadrupeds and birds. In pursuit of birds, they climb trees. They are generally of a sullen and suspicious temper, and not easily tamed. To this genus belongs the Caracal (q. v.), which is probably the L. of the ancients. The species are pretty numerous, and widely distributed, but the distinctions of species and varieties are somewhat uncertain. The EUROPEAN L. (*L. virgatus*) is common in many parts of Europe and Asia, chiefly in mountainous and wooded districts. Its colour is variable, but generally of a dark reddish gray, spotted with reddish brown, the belly whitish. It is about three feet long. It is proverbial for acuteness of sight. It is hunted in winter for its

fur, which is always in demand in the market; but many of the L. skins imported from the north of Asia probably belong to other species: those of North America, and probably also many of those of the north of Europe and of Asia, are the skins of the CANADA L. (*L. Canadensis* or *L. borealis*), which



European Lynx (*L. virgatus*).

is generally of a hoary-gray colour, a broad space along the back blackish brown. It is rather larger than the European L., and more clumsy in form.—The BAY L. (*L. rufus*) is found in more southern parts of North America, both in mountainous and in swampy districts, and often makes great havoc among poultry. It is commonly called in America the wild cat.

LYON, the second town of France in respect of population, and the first with regard to manufactures, is the capital of the department of the Rhone, and stands at the confluence of the river of that name with the Saône, 316 miles by railway south-south-east of Paris, 218 north-north-west of Marseille, and 100 west-south-west of Geneva. It is situated partly on a low-lying peninsula between the two rivers, and partly on hills surrounding them, in a beautiful district covered with gardens, vineyards, and villas. It is the seat of an archbishop, and is the *chef-lieu* of the seventh military division. Many of the public buildings are interesting at once for their architecture, extent, and antiquity. Of these, the cathedral and church of St Nizier, the Hôtel-de-Ville (town-hall), the finest edifice of the kind in the empire, the hospital, the public library with 130,000 volumes, and the Palais des Beaux Arts, are perhaps the most notable among numerous and important institutions. There are also a university-academy, an imperial veterinary school—the first founded in the country, and still the best—schools for agriculture, medicine, and the fine arts, &c. There are more than 20 printing-offices, the principal journals being the *Courrier de Lyon*, *Gazette de Lyon*, and *Salut Public*. The two rivers are crossed by 19 bridges; 12 over the Saône, and 7 over the Rhone. The quays, 28 in number, are said to be the most remarkable in Europe. The principal are St Clair, St Antoine, and Orleans. There are several large and important suburbs—La Guillotière, Les Brotteaux, La Croix-Rousse, &c.; several fine squares, of which the *Place Bellecour* is one of the largest in Europe. The fortifications extend in a circle of 13 miles round the city. From its situation on two great rivers, and on the Paris and Marseille and other railways, L. has become the great warehouse of the south of France and of Switzerland. The principal manufactures of L. are silk stuffs of all kinds, which have long been held in the highest esteem. An immense number of establishments, giving employment directly or indirectly to 100,000 hands, are engaged in the manufacture of silk fabrics. Nets, cotton goods, blankets, hats, gold

LYON—LYON COURT.

and silver lace, chemical products, drugs, liquors, earthenware, are also important articles of manufacture. The trade of L. is chiefly in its own manufactures and in the products of the vicinity; the arms and silk ribbons of St Etienne, and the wines of Côte-Rôtie, Hermitage, and St Peray, Pop. (1862) 318,803.

L., the ancient *Lugdunum*, was founded in the year 43 B.C. by *Munatius Plancus*, Under *Augustus* it became the capital of the province *Gallia Lugdunensis*, possessed a senate, a college of magistrates, and an *atheneum*, and became the centre of the four great roads that traversed Gaul. In 58 A. D., it was destroyed in one night by fire; but was built up again by *Nero*, and embellished by *Trajan*. In the 6th c., it was one of the principal towns of the kingdom of *Burgundy*; and in the 11th and 12th centuries, it had risen to great prosperity. To escape the domination of the lords and archbishops, the inhabitants placed themselves under the protection of *Philippe-le-Bel*, who united the town to France in 1307. After the Revolution (1789), L., which had at first supported the movement with great enthusiasm, eventually became terrified at the acts of the central power, and withdrew from the revolutionary party. The result of this was, that the Convention sent against L. an army of 60,000 men, and after a disastrous siege, the city was taken, and almost totally destroyed. It rose again, however, under the first *Napoleon*; and though, since then, it has frequently suffered much from inundations (1840 and 1856) and from the riots of operatives (1831 and 1834), it is now (1863) in a high state of prosperity.

LYON COURT, the Heralds' Court for Scotland, presided over by the Lord Lyon King-at-arms (q. v.). Attached to the Lyon Court are six Heralds (see **HERALD**), and six Pursuivants (q. v.), all appointed by the Lyon. Though the heralds were at one time conjoined with the Lord Lyon in the exercise of jurisdiction over armorial bearings, the powers of the Lyon Court have long been exercised by the king-at-arms alone, the duties of heralds and pursuivants being almost exclusively confined to attendances at royal proclamations and public solemnities. The Lyon has, for more than a century, discharged the greater part of the duties of his office by a deputy known as the Lyon Depute, who is generally a member of the bar or writer to the signet. Among the officials of his court are a clerk, called the Lyon-clerk, who is also keeper of records; the Lyon-clerk depute; the Procurator Fiscal, or public prosecutor; a herald painter; and a messenger-at-arms, who acts as mace. The jurisdiction of the Lyon Court is regulated by two acts of the Scottish parliament, 1592 c. 127, and 1672 c. 21. These statutes authorise the Lord Lyon to inspect the ensigns armorial of all noblemen and gentlemen in Scotland, and oblige all persons who, by royal concession or otherwise, had previously a right to arms, to matriculate or register them in the Lyon's books. The Lyon is empowered to inquire into the relationship of younger branches of families having right to arms, and to 'assign suitable differences to them, without which the arms cannot lawfully be borne.' The later act establishes the now existing register of the Lyon Court as the 'true and unrepeatable rule of all arms and bearings in Scotland,' and authorises the Lord Lyon to 'give arms to virtuous and well-deserving persons,' not hitherto entitled to bear them. The unlawful bearing of arms subjects the delinquent to a fine, and confiscation of all the movable goods and gear on which the said arms are engraven or otherwise represented. Both acts are in full force: the differencing of cadets and granting of new coats are matters of

daily practice in the Lyon Office. Questions have been raised as to how far the decisions of the Lyon Court can be reviewed by the Court of Session, and it seems now to be held that they are subject to review only where the Lyon is alleged, in granting arms, to have invaded the rights of others.

Right to bear arms is acquired either by descent or by grant. 1. In the former case, only the representative or head of the family can use the undifferenced coat; but a cadet, on presenting a petition to the Lord Lyon, and establishing his relationship, has, by a matriculation, the family coat assigned to him, with such a difference as, according to the rules of heraldry, appropriately sets forth his relationship to the head of the family and to other cadets already matriculated. The mere fact of one's bearing the same surname with a family entitled to arms, confers no sort of right to wear these arms differenced or undifferenced. 2. Where no hereditary right exists or can be proved, an original grant of arms may be bestowed by the Lord Lyon. As in the case of a matriculation, a petition is presented to the Lyon Court, which, in this case, need be accompanied with no evidence of pedigree; and in granting new coats, it is the duty of the Lyon to conform to the rules of good heraldry, and be observant of the rights of other parties. With these reservations, the wishes of the applicant are consulted as to the arms which he is to bear. The fees payable for a matriculation, where relationship is proved, are about £14; for an original grant, £42—in both cases much below the fees of the English College of Arms. An additional charge is made for Supporters (q. v.), which are only given to those persons who are entitled to them by the heraldic practice of Scotland.

In strictness, the use of a crest on one's plate or seal without authority, is a transgression of the above-mentioned acts; but practically, prosecutions have generally been confined to cases of open and public assumption of a shield of arms. The offender is cited before the Lyon Court by precept at the instance of the Procurator Fiscal; the statutory fine and confiscation have occasionally been enforced, but they have oftener, particularly of late, been avoided by a timely submission. Though these statutes have doubtless to some extent checked the illegal assumption of arms, it is believed that a considerable number of transgressors are yet to be found. In this commercial country, there are not a few persons whose social status would entitle them to the use of arms, but who, not having inherited a coat, instead of acquiring the privilege in a legal way, have a sham coat invented for them by some coach-painter or 'finder' of arms. According to *Mr Seton (Law and Practice of Heraldry in Scotland, 1863)*, the Lyon Office has latterly been rather remiss in dealing with such persons; and now, when heraldry is recovering from the neglect under which it lay, and its usefulness is becoming daily more apparent to the critical student of history, 'there seems no reason whatever why the statutory penalties should not be more strictly enforced.' These penalties are a check not on an act of unmeaning folly, but on a direct falsification of history. A heraldic shield is a record whose nice distinctions state, to all who understand its language, a variety of particulars regarding the descent of the owner of it; and the measure of the utility of such a record is of course its truthfulness.

The Register of Genealogies is a department of the Lyon Office unconnected with heraldry, where evidence is taken of the pedigree of applicants, irrespectively of noble or humble lineage, and recorded for preservation.

Besides his functions, heraldic and genealogical,

the Lord Lyon has a jurisdiction connected with the executive part of the law: he appoints all messengers-at-arms, superintends them in the execution of their duty, takes cognizance of complaints against them, and fines, suspends, or deprives them for malversation.

LYON (or **LORD LYON**) **KING-AT-ARMS**, the chief heraldic officer for Scotland, whose title is derived from the lion rampant in the royal escutcheon. The Scottish King-at-arms has, unlike his brother-kings of England, from an early period exercised jurisdiction independently of the constable and marshal, holding office directly from the sovereign by commission under the Great Seal. In early times, he was occasionally designated the *Lord Lyon*; but the now prevalent custom of so calling him, seems to have arisen from the circumstance that, since 1793, the office has been held by a peer. According to Nisbet, the Lyon has precedence of all knights and gentlemen not being officers of state, or senators of the College of Justice. Since the Union, he has ranked next to Garter; Clarencieux and Norroy follow; then Ulster; but it has sometimes been maintained that, within Ireland, Ulster has place next after Lyon. The regalia of the Lyon, worn on solemn occasions, consist of a crown of gold, an embroidered crimson velvet robe with the national arms, a triple row of gold chains, with a medal, exhibiting the royal bearing on the one side, and St Andrew's Cross on the other. At other times, the badge is worn suspended by a broad green ribbon.

The official arms of the Lyon King-at-arms are argent, a lion sejant full-faced gules, holding in the dexter paw a thistle slipped vert, and in the sinister an escutcheon of the second, on a chief azure a saltire of the first. Lyon is king-at-arms to the order of the Thistle (q. v.). See **LYON COURT**.

LYONNAIS, a former province of France, was bounded on the W. by Auvergne, and on the S. by Languedoc. Its territory coincides nearly with the present departments of Rhone, Loire, Haute-Loire, and Puy-de-Dôme.

LYRE, the oldest stringed instrument of the Egyptians and Greeks. There are many different kinds and sizes of the lyre, each having its own peculiar name, such as the Lyre da Braccio, Lyre da Gambe, Lyre Guitare, &c.

LYRE-BIRD, or **LYRE-TAIL** (*Menura*), a genus of birds, of which the best known species (*M. superba*) is a native of New South Wales, where it is generally called the **LYRE PHEASANT**. The proper place of this genus has been much disputed by ornithologists, some placing it among the *Incessores*, near to thrushes and wrens, others among Gallinaceous Birds, with megapodes. The large feet and habit of scraping, ally the L. with the latter; the form of the bill, the bristles at the base of the bill, and above all, its musical powers, connect it with the former, to which it was unhesitatingly referred by Cuvier. It is a bird about the size of a pheasant, frequenting the brush, or sparsely-wooded country, in the unsettled parts of New South Wales, but retreating from the more inhabited districts. It is extremely shy and difficult to approach. It is by far the largest of all song-birds. It possesses the power of imitating the song of other birds. The tail of the male is very remarkable and splendid, the twelve feathers being very long, and having very fine and widely separated bars; whilst, besides these, there are two long middle feathers, each of which has a vane only on one side, and two exterior feathers, curved like the sides of an ancient lyre. The L. makes a domed nest.—A second species (*M. Alberti*), also

Australian, has recently been discovered, and has been named in honour of the late Prince Albert.



Lyre-Bird (*Menura superba*).

The lyre-shaped feathers of the tail are comparatively short.

LYRIC (from the Gr. *lyra*, a lyre), the name given to a certain species of poetry, because it was originally accompanied by the music of that instrument. Lyric poetry (see **EPIC POETRY**) concerns itself with the thoughts and emotions of the composer's own mind, and outward things are regarded chiefly as they affect him in any way. Hence it is characterised as *subjective*, in contradistinction to epic poetry, which is *objective*. Purely lyrical pieces are, from their nature, shorter than epics. They fall into several divisions, the most typical of which is the *song*, which is again subdivided into *sacred* (hymns) and *secular* (love-songs, war-songs, comic songs, &c.).

LYS, or **LEYE**, a tributary of the Scheldt, rises in France near the little town of Lybourg, in the department of Pas-de-Calais, and flows in a north-eastern direction, joining the Scheldt at Ghent in Belgium after a course of 100 miles. The L. once formed the boundary between France and Germany.

LYSANDER, a famous Spartan warrior and naval commander, of extraordinary energy and military skill, but not less remarkable for the cunning, revenge, and ambition by which he was characterised. He spent part of his youth at the court of Cyrus the Younger, and in 407 B. C. was appointed to the command of the Spartan fleet, from which time he constantly prosecuted the design of overthrowing the Athenian power, in order to exalt that of Sparta. He defeated the Athenian fleet at the promontory of Notion; and being again intrusted with the management of the fleet, after the defeat of his successor, Callicratidas (405 B. C.), he was again victorious. He swept the southern part of the Ægean, and made descents upon both the Grecian and the Asiatic coasts. He then sailed north to the Hellespont, and anchored at Lampsaous. An immense Athenian fleet soon made its appearance at Ægospotami, on the opposite side of the straits, amounting to 180 ships. Of these, 171 were captured by L. a few days after.

The blow to Athens was tremendous. Everywhere, her colonial garrisons had to surrender, and Spartan influence predominated. Finally, in 404 B.C., he took Athens itself. His popularity now became so great, especially in the cities of Asia Minor, that the Spartan ephors dreaded the consequences, especially as they knew how ambitious he was. Every means was taken to thwart his designs, until finally it would appear that he had resolved to attempt the overthrow of the Spartan constitution; but this scheme was prevented by his death at the battle of Haliartus in the Boeotian war (395 B.C.).

LYTHRA'OEÆ, a natural order of exogenous plants, consisting of herbaceous plants, with a few shrubs; the branches frequently four-cornered. The leaves are generally opposite, entire, and sessile. The flowers are solitary or clustered, regular or irregular, and either axillary, racemose, or spiked; the calyx tubular, the petals inserted into the calyx, very deciduous, sometimes wanting. The stamens are inserted into the tube of the calyx below the petals, sometimes equal to them in number, sometimes twice or thrice as many. The ovary is superior, generally 2—6-celled. The fruit is a membranous capsule with numerous seeds.—There are about 300 known species, natives of tropical and temperate, or even of cold climates. Some of them are occasionally applied to medicinal uses, upon account of astringent, narcotic, or febrifugal properties. Among those thus employed is the **PURPLE LOOSESTRIFE** (*Lythrum salicaria*), a common British plant, growing in moist places and about the margins of ponds and streams, with beautiful leafy spikes of purple flowers; a decoction of either the root or the dried leaves of which is sometimes advantageously used in diarrhoea. The Henna (q. v.) of Egypt is produced by *Lawsonia inermis*, a plant of this order. The leaves of another (*Pemphis acidula*) are said to be a common pot-herb on the coasts of the tropical parts of Asia. The leaves of *Ammania vesicatoria*, an East Indian aquatic plant, are very acrid, and are sometimes used as blisters.

LYTTLETON, GEORGE LORD, son of Sir Thomas Lyttleton of Hagley, in Worcestershire, was born in 1708—1709, and educated at Eton and Christchurch, Oxford. He entered parliament in 1730, held several high political offices, was raised to the peerage in 1759, and died in 1773. L. had once a considerable reputation as an author. His best known works are *Observations on the Conversion and Apostleship of St Paul* (1747), *Dialogues of the Dead* (1760), and *History of Henry II.* (1764).—He had a son, **THOMAS, LORD LYTTLETON**, who died young, and who was as conspicuous for profligacy as his father for virtue.

LYTTON, SIR EDWARD GEORGE EARLE LYTTON BULWER, Bart., the youngest son of General Bulwer of Woodalling and Haydon Hall, Norfolk, was born in 1805, and received his education at Cambridge, where he graduated B.A. in 1826, and M.A. in 1835. He is distinguished as an English writer and as a politician, and his achievements in these diverse fields may be noticed separately.

His first publication was a poem on *Sculpture*, which gained the Chancellor's prize for English versification at Cambridge in 1825. In 1826, he published a collection of miscellaneous verse, entitled *Weeds and Wild Flowers*, and in the year following, a tale in verse with the title *O'Neill, or the Rebel*. In 1827, his first novel, *Falkland*, was published anonymously. Next year, he published *Pelham*, which astonished the critics by its cynicism and its icy glitter of epigram. *The Disowned*, *Devereux*, and *Paul Clifford* followed in rapid succession. In 1831, he broke into more passionate and tragical regions in *Eugene*

Aram, and after that ceased for a period to convulse the libraries. About this time, he succeeded Campbell as editor of *The New Monthly Magazine*, and contributed to its pages a series of papers which were afterwards collected under the title of *The Student*. In 1833, he produced his *England and the English*. In 1834, he returned to fiction, and published in an illustrated form *The Pilgrims of the Rhine*. This was followed by *The Last Days of Pompeii*, a work of a higher class than any of his former productions. *Rienzi* followed in the same splendid vein, and received the same admiration. His next work was a play in five acts, *The Duchess of La Vallière*, which was put on the stage in 1836, and failed. *Ernest Maltravers* came the year after, which, as containing his views on art and life, has ever been a favourite with his more thoughtful readers. In the same year, he published *Athens; its Rise and Fall*, full of research and splendid rhetoric. *Leila* and *Calderon* appeared in 1838. His next efforts were in the difficult walk of the drama, in which he had formerly failed. He produced *The Lady of Lyons* and *Richelieu*, both of which remain among the most popular of modern English plays.

L.'s next important work was *Zanoni*, which was published in 1842, and in the same year appeared his poem entitled *Eva*, which is little read now. Other poems were issued about this time—*The Neo Timon* in 1846, and *King Arthur* in 1848, neither of which has been successful, although in the former there are couplets turned with the grace and art of Pope; and the latter contains noble passages of sentiment, and much glittering description. His next novels were *The Last of the Barons*, *Harold*, and *Lucretia*; and thereafter he adopted a new walk of fiction, and achieved in it his greatest triumphs.

The Caxtons, a domestic novel, appeared originally in *Blackwood*, and gave the world the crowning proof of L.'s versatility. This work was followed by *My Novel*, which is in several respects the finest thing he has done. Since then, he has published, also in the first instance in *Blackwood*, *What will He do with It?* a novel, in which his earlier style is reverted to; and a clever poem entitled *St Stephen's*. In 1861, *A Strange Story* appeared in *All the Year Round*, and at present (1863) he is contributing to *Blackwood* a series of essays under the title of *Caxtoniana*.

At the age of 26, L. entered parliament as member for St Ives, and attached himself to the Reform party. In 1832, he was returned as member for Lincoln, and held that seat till 1841. In 1835, he received his baronetcy from the Melbourne administration ostensibly for brilliant services rendered to his party as a pamphleteer. In 1844, he succeeded, on the death of his mother, to the Knebworth estates, and sought to return to parliament; in 1847, he contested Lincoln unsuccessfully; and in 1852, he was returned as member for the county of Herts, and attached himself to the party headed by Lord Derby. During the late Derby administration, he held the post of Colonial Secretary. He does not shine as a debater, but several of his parliamentary speeches have been eloquent and telling.

Of living English men of letters, L. is perhaps the most versatile, and has been the most generally successful. He has written novels, dramas, criticism, history, poems, political pamphlets, and each of these he has written well, several supremely well. If he has failed at all, he has failed as a poet, and his failure may be accounted for to some extent from his having chosen models which ran counter to the prevailing taste. On his novels, however, his reputation must ultimately rest. These have become part and parcel of English literature, and may now be considered as among its permanent glories.

M



THE thirteenth letter of the English alphabet, is the labial letter of the class of liquids. See LETTERS. Its Hebrew name is *Mem*, i. e., 'water,' and its original form was probably a waving line representing water.

M is liable to many changes, and often disappears altogether. The Greek *molubdos* corresponds to Lat. *plumbum*; an old form of Lat. *bonus*, *benus*, or *delus*; was *masus*, which probably accounts for the comparative *melior*. See B. Final *m* in Latin was pronounced with such a weak, undecided sound, that it was proposed to write it with half the letter; hence also, before the spelling of the language had become fixed, it had in many cases been altogether dropped, as in *lego* for *legom*. See INFLECTION. The nasal sound of final *m* in French seems to be a relic of the Roman pronunciation.

MAAS (Lat. *Mosa*, Fr. *Meuse*), a large affluent of the Rhine, rises in France, in the department of Haute-Marne, near the village of Meuse, flows in a northerly direction through France, Belgium, and Limburg, and then eastward through Holland to the German Ocean. From its junction with the Waal, a branch of the Rhine, to the mouth of the Yssel, it is called the *Merve*. At Dordrecht, it divides into two branches, enclosing the island of *Ysselmonde*—of these, the northern is called the *Nieuwe Maas* (New Maas), the southern the *Oude Maas* (Old Maas). These branches unite on the eastern side of the island of *Rozenburg*, after which the river falls into the North Sea, in long. 4° 8' E. Its entire course is 552 miles in length, for 430 miles of which (from *Verdun*, in the department of *Vosges*, France, to the mouth of the river) it is navigable. The area drained by the M. is estimated at 19,000 square miles. Its principal affluents are the *Sambre* and the *Dieze*, on the left; and the *Ourthe*, the *Roer*, and the *Niers*, on the right. Of the important towns on the banks of the M., the principal are *Namur*, *Liège*, *Maastricht*, *Gorkum*, *Dort*, and *Rotterdam*.

MAA'STRICHT, or **MAESTRICHT** (called by the Romans *Trajectum ad Mosam*, to distinguish it from *Trajectum ad Rhenum*, now *Utrecht*), is a very old and important fortified town, capital of the province of *Limburg*, kingdom of the Netherlands. Pop. in 1861, 27,905. M. is on the left bank of the river *Maas*, which separates it from the town of *Wijk*, the connection being maintained by a stone bridge, 500 feet in length, resting on nine arches, and defended by small fortified islands. The town was founded in the 5th c., the seat of the bishop being transferred thither after *Attila* had plundered *Tongres*, in 451. It is 15 miles north of *Liège*, 18 west of *Air-la-Chapelle* (*Aken*), and pleasantly situated in a hilly district. The streets are broad, and the houses regularly and well built, giving an air of beauty and respectability

to the town. There are many paintings and a select public library in the Town-house, a large square stone building, ornamented with a tower, and standing on the great market. M. has one Lutheran, three Dutch Reformed, and six Roman Catholic churches; three hospitals, two orphan-houses, an Athenæum, and other public buildings. The plains are shaded with trees and refreshed by fountains. A broken *Brabant* dialect, mingled with *German* and *Walloon*, is the language commonly spoken; but in all respectable families, French is chiefly used. M. has a very considerable trade with *Bois-le-Duc* and other places. Leather, woollen stuffs, stockings, blankets, flannels, starch, madder, pines, &c., are manufactured; soap-boiling, gin-distilling, sugar-refining, iron-founding, and other branches of industry, adding also to the prosperity of the town.

M. has often felt the scourge of war, and the evils incident to a frontier fortified town. It is surrounded by broad and deep canals, which contribute to its defensive strength. It is commanded by the hill of *St Pierre*, formerly called *Mons Hunnorum*, a soft calcareous mountain, which has been very extensively mined, forming a cavernous labyrinth of several leagues in length. Among other fossils, have been found in these workings two heads of the gigantic *Mosassaurus*.

MABILLON, **JEAN**, a learned Benedictine, born 23d November 1632, at *St Pierre*mont, in *Champagne*. He studied at the *Collège de Reims*; assisted *D. Luc d'Achery* in his labours upon his vast historic *recueil*, entitled *Spicilegium*; undertook an edition of the works of *St Bernard*; and in 1668, published the first volume of the *Acta Sanctorum Ordinis S. Benedicti*, of which the last part appeared in 1702. His classical work *De Re Diplomatica* appeared at *Paris* in 1681. Colbert offered him a pension of 2000 livres, but he declined it. In 1683, Colbert sent him to *Germany*, to collect documents relative to the history of *France*, and he was afterwards sent to *Italy* for a similar purpose. He died in *Paris*, 27th December 1707. His *Vetera Analecta* (4 vols. *Par.* 1675—1685), and *Musæum Italicum, seu Collectio Veterum Scriptorum ex Bibliothecis Italicis eruta* (2 vols. *Par.* 1687—1689), contain part of the fruits of his laborious and erudite researches.

MAC, or **M'**, a Gaelic prefix occurring frequently in *Scottish* names, means 'son,' and is probably allied to the Gothic *magus*, a son, a boy, the feminine of which is *magaths* (*Ger. magde*, a maid). The root is probably the *Sanscrit mah*, to grow (see *G*). In *Welsh*, *magu* means to breed. The *Welsh* form of *Mac* is *Map*, shortened into 'ap' or 'p,' as *Ap Richard*, whence *Pritchard*.

MACADAM, **JOHN LOUDON**, was born in *Scotland* in 1756, and passed his youth in the *United States*. On his return, he was appointed manager of a district of roads in *Ayrshire*, and originated and successfully practised the system of roadmaking now known by his name. In 1819, he was summoned to *England*, and was appointed by parliament

to superintend the roads in the Bristol district, which were in a most deplorable condition. In 1827, he was appointed general surveyor of the metropolitan roads; and in reward of his exertions to render them efficient, received a grant of £10,000 from government. His system rapidly became general throughout England, and was also introduced into France with great success. M. died at Moffat, in Dumfriesshire, in 1836. The principles of his system, which is known as *Macadamising*, are as follow: 'For the foundation of a road, it is not necessary to lay a substratum of large stones, pavement, &c., as it is a matter of indifference whether the substratum be hard or soft; and if any preference is due, it is to the latter. The metal for roads must consist of broken stones (granite, flint, or whinstone is by far the best); these must in no case exceed 6 ounces each in weight, and stones of from 1 to 2 ounces are to be preferred. The large stones in the road are to be loosened, and removed to the side, where they are to be broken into pieces of the regulation weight; and the road is then to be smoothed with a rake, so that the earth may settle down into the holes from which the large stones were removed. The broken metal is then to be carefully spread over it; and as this operation is of great importance to the future quality of the road, the metal is not to be laid on in shovelfuls to the requisite depth, but to be scattered in shovelful after shovelful, till a depth of from 6 to 10 inches, according to the quality of the road, has been obtained. The road is to have a fall from the middle to the sides of about 1 foot in 60, and ditches are to be dug on the field-side of the fences to a depth of a few inches below the level of the road.' This system, which at one time threatened to supersede every other, is calculated to form a hard and impermeable crust on the surface, thus protecting the soft earth below from the action of water, and so preventing it from working up through the metal in the form of mud. Strange to say, it has succeeded admirably in cases where a road had to be constructed over a bog or morass, but in some other circumstances, it has been found deficient. See **ROADS**.

MACAO', a Portuguese possession on the coast of China, in lat. 22° 15' N., and long. 113° 40' E., on the western part of the estuary of the Canton or Pearl River, Hong-kong being about 40 miles distant, on the opposite side of the same estuary. The settlement, which is about eight miles in circuit, is on a small peninsula, projecting from the south-eastern extremity of the large island of Hiang-shan. Its position is very agreeable, nearly surrounded with water, and open on every side to the sea-breezes, having a good variety of hill and plain, and a large island adjacent, on which are pleasant rambles, to be reached by equally pleasant boat-excursions. It is one of the most salubrious parts east of the Cape of Good Hope, and during the monopoly of the East India Company, it was a favourite place of resort for Englishmen from India. The population is about 30,000, 5000 of whom are Portuguese and other foreigners. The Portuguese obtained their footing in 1560, under the pretext of erecting sheds for drying goods, introduced under the appellation of tribute, and alleged to have been damaged in a storm. These sheds gradually gave way to substantial edifices, and finally to forts. Thus the first foreign colony in China was established. The Chinese, however, held, until recently, a lien upon the place, requiring of the Portuguese 500 taels ground-rent, retaining also jurisdiction over their own people. The privileges obtained by England through the treaty of Nankin, were subsequently extended to the Portuguese, who,

by successive aggressions, have become wholly independent of the Chinese. The Typa anchorage lies between two small islands about three miles off the southern end of the peninsula. Large vessels cannot approach nearer the shore than six miles. There is an inner harbour on the west of the town, the resort of small vessels and junks. After the rise of Hong-kong, the commerce of M. almost entirely disappeared; but the authorities have of late been doing what they can to revive the prosperity of the place, by making it a free port, and by the pursuance of a liberal policy generally.

MACARONI (originally lumps of paste and cheese squeezed up into balls; from It. *maccare*, to bruise or crush), a peculiar manufacture of wheat, which for a long time was peculiar to Italy, and, in fact, almost to Genoa; it is now, however, made all over Italy, and at Marseille and other places in the south of France. Strictly speaking, the name macaroni applies only to wheaten paste in the form of pipes, varying in diameter from an ordinary quill up to those now made of the diameter of an inch; but there is no real difference between it and the fine threadlike vermicelli, and the infinite variety of curious and elegant little forms which, under the name of *Italian pastes*, are used for soups.

Only certain kinds of wheat are applicable to this manufacture, and these are the hard sorts, which contain a large percentage of gluten. At present, the Italian manufacturers prefer the wheats of Odessa and Taganrog; but they also employ those of their own country grown in Sicily and in Apulia. The wheat is first ground into a coarse meal, from which the bran is removed—in that state it is called *Semola* (see also *SEMOLINA*); during the grinding, it is necessary to employ both heat and humidity, to insure a good semola. The semola is worked up into a dough with water; and for macaroni and vermicelli, it is forced through gauges, with or without mandrels, as in wire and pipe-drawing; or for *pastes*, it is rolled out into very thin sheets, from which are stamped out the various forms of stars, rings, &c.

The manufacture of this material is of great importance to Italy, where it forms a large article of home consumption, and is exported to all parts of the world. In Genoa alone, nearly 170,000 quintals of wheat are annually consumed in this manufacture. The finest qualities of macaroni are those which are whitest in colour, and do not burst or break up in boiling; it should swell considerably, and become quite soft; but if it does not retain its form when boiled, it has not been made of the best wheat. Some makers flavour and colour it with saffron and turmeric, to suit certain tastes, but this is limited to very few. The use of macaroni and its varieties is rapidly increasing in Great Britain, where it is employed in soups, in puddings, and for making the favourite dish of macaroni and cheese.

MACARONIC VERSE is properly a kind of humorous poetry, in which, along with Latin, words of other languages are introduced with Latin inflections and construction; but the name is sometimes applied to verses which are merely a mixture of Latin and the unadulterated vernacular of the author, of which a very clever specimen are the lines of Porson on the threatened invasion of England by Bonaparte, entitled *Lingo drawn for the Militia* (see Wheatley's *Anagrams*, &c.). Teodilo Folengo, called Merlino Coccagio, a learned and witty Benedictine, who was born at Mantua in 1494, and died in 1544, has been erroneously regarded as the inventor of macaronic poetry; but he was the first to employ the term, selected with reference to the mixture of ingredients in the dish

called macaroni. His *Macarones* (Tusculanum, 1821, and many editions) is a long satiric poem, in which Latin and Italian are mingled. Fortunately, macaronic poetry has not been very extensively cultivated, although specimens of it may be found in the literature of almost all European countries. The idea of it was probably first suggested by the barbarous monkish Latin. There is a history of macaronic poetry, and a collection of the principal works of this kind by Gemthe (Halle, 1829).—Compare also Octave Delapierre's *Macaroneana* (Paris, 1852), and his *De la Littérature Macaronique et de quelques Variétés Bibliographiques de ce Genre* (vol. ii., *Miscellanies of Philobiblon Society*, Paris, 1856).

MACAROON (from the same root as Macaroni), a favourite kind of biscuit, made with the meal of sweet almonds, instead of wheaten or other flour. The most esteemed formula for making macaroons is either prepared almond-meal dry, or, what is still better, almonds just blanched and beaten into a paste, one pound, thoroughly incorporated with a pound and a half of refined sugar in powder, an ounce of the yellow part of fresh lemon-peel grated fine, and the whites of six eggs. When thoroughly mixed, the paste is made into the shape of small oval biscuits, and placed on sheets of water-paper, and baked; afterwards, the superfluous water-paper is trimmed off, and the macaroons are ready for use.

MACARTNEY COCK (*Euplocamus ignitus*), a splendid gallinaceous bird, also called the **FIRE-BACKED PHEASANT**, a native of Sumatra and other islands of the same part of the world. It was first described in the account of Lord Macartney's embassy to China. The entire length of the adult male is about two feet. The sides of the head are



Macartney Cook (*Euplocamus ignitus*).

covered with a bluish-purple skin. The crown of the head has an upright crest of feathers with naked shaft, and a number of slender spreading barbs at the tip. The tail, when depressed, is forked; when erect, it is slightly folded, as in the common fowl. The general colour is a deep black, with blue metallic reflections; the middle of the back, brilliant orange; the tail, bluish green, orange, and white. The female is smaller, and almost entirely of a rich brown colour. The head is not crested, as in the male, but the hind feathers are lengthened.—The genus *Euplocamus* is allied both to *Gallus* (Fowl) and *Phasianus* (Pheasant), and perhaps still more nearly to *Lophophorus*

(Impeyan). Two or three splendid East Indian species are referred to it.

MACA'SSAR, the most southern portion of Celebes (q. v.), lies in lat. 4° 38'—5° 50' S., and long. 119° 25'—120° 30' E.; and is traversed by a lofty chain of mountains. M. was formerly the greatest naval power among the Malay states, but is now divided into the Dutch possessions and M. Proper, which is of little importance, and governed by a native king, who pays tribute to the Netherlands. The natives are among the most civilised and enterprising, but also the most greedy, of the Malay race. They carry on a considerable trade in tortoise-shell and edible nests, grow abundance of rice, and raise great numbers of horses, cattle, sheep, and goats; fishing is also extensively carried on. The Macassars are chiefly Mohammedans; the mosques are built of palm-wood. They are warlike, spirited, and impatient of a blow—their laws allowing them to avenge it by the death of the offender, if within three days.

MACASSAR, the chief town, is the capital of all the possessions of the Netherlands in Celebes, and the residence of the governor and officials. It is situated on the Strait of Macassar, which separates Celebes from Borneo, in 5° 10' S. lat., and 119° 20' E. long.; and is built upon a high point of land, watered by two rivers and other smaller streams, surrounded by palisades, and further defended by Fort Rotterdam. Pop. about 12,000. The harbour is safe and convenient, but difficult to enter. Climate healthy, and all kinds of provisions plentiful. The exports consist of the various products of Celebes, which are brought from the settlements to Macassar for shipment. The chief of these are rice, sandal-wood, ebony, tortoise-shell, gold, spices, &c. The imports from China are principally silk fabrics and porcelain; from the Netherlands, cotton and linen goods, firearms, opium, spirits, &c. A very large proportion of the export and import trade is carried on between Macassar and the free port of Singapore, about a third part being with Java. In 1857, the imports amounted to £382,288, and the exports to £385,010 sterling. No import or export duties are charged.

The Portuguese first formed a settlement in M., but were supplanted by the Dutch, who, after many contests with the natives, gradually attained to supreme power. In 1811, M. fell into the hands of the British, who, in 1814, defeated the king of Boni, and compelled him to give up the regalia of Macassar. In 1816, it was restored to the Dutch, and continues to enjoy a fair share of the mercantile prosperity of the Netherlands' possessions in the Eastern Archipelago.

MACASSAR OIL—so called from the district of Macassar, in the island of Celebes, whence it is exported—is a species of vegetable butter, of an ashen-gray colour, and rancid odour.—This name has also been given in Britain to a patent preparation used for promoting the growth of the hair and preventing its decay. It is composed of olive oil, or oil of almonds, coloured with Alkanet root, and mixed with perfumes.

MACAULAY, THOMAS BABINGTON, LORD, son of Zachary Macaulay, a West India merchant and eminent philanthropist, and grandson of the Rev. John Macaulay, a Presbyterian minister in the west of Scotland, was born at Rothley Temple, Leicestershire, 25th October 1800. He entered Trinity College, Cambridge, at the age of 18, where he acquired a brilliant reputation both as a scholar and debater. He twice won the Chancellor's medal—first in 1819, for a poem on *Pompeii*, and again in 1820, for another on *Evening*, both of which were

published. In 1821, he obtained the second Craven scholarship, took the degree of B.A. in 1822, was shortly after elected a Fellow of Trinity, and then began to devote himself zealously to literature. The periodical to which he first contributed was *Knight's Quarterly Magazine*; for this he wrote several of his ballads, e. g., *The Spanish Armada*, *Moncontour*, and *The Battle of Ivry*, besides essays and critiques. In 1825, he took the degree of M.A., and in the same year made his appearance in the columns of the *Edinburgh Review* by his famous essay on Milton, the learning, eloquence, penetration, brilliancy of fancy, and generous enthusiasm of which, quite fascinated the educated portion of the public. For nearly 20 years he was the popular, perhaps also the most distinguished, contributor to the 'Blue and Yellow.' In 1826, he was called to the bar at Lincoln's Inn, but it does not appear that he practised. The tide of political agitation was beginning to rise high, and M. was borne along with the current. There can be no doubt that M. was an immense accession to the Whig party; for he believed in Whiggism with a profound sincerity that has never been questioned; and he was able to present the grounds of his belief in a manner so powerful and attractive, that his very opponents were charmed, and almost convinced. In 1830, he entered parliament for the pocket-borough of Calne (which was placed at his service by the Marquis of Lansdowne) just in time to take part in the memorable struggle for Reform, in favour of which he made several weighty and effective speeches. When the first reformed parliament assembled in 1832, M. sat as member for Leeds, and at once took a prominent position in the House. He was now made Secretary of the Board of Control for India; and in the following year, went out to India as a member of the Supreme Council. Here he remained till 1838. His chief labour was the preparation of a new Indian penal code. A conspicuous feature of this code was the humane consideration it displayed for the natives (which drew down upon its author the hostility of the Anglo-Indians); but in spite of the high ability shown in framing it, it was found on the whole unworkable, and was abandoned. On his return to England, he resumed his political career, and was elected M.P. for the city of Edinburgh in 1839. In 1840, he was appointed War-secretary. While holding this office, he composed, appropriately enough, those magnificent martial ballads, the *Lays of Ancient Rome* (1842); and in the following year, published a collected series of his *Essays*, in 3 vols. In 1846, he was made Paymaster-general. M. had always been one of the most courageous and unflinching advocates of religious freedom: accordingly he had defended the Roman Catholic Relief Bill; his first speech in the House of Commons was in support of the bill to repeal the Civil Disabilities of the Jews, and now he supported the Maynooth grant. At this period, unfortunately for M., Edinburgh was the arena of great ecclesiastical fermentation; and because he advocated a measure intended to moderate the natural discontent of Roman Catholics, he was ousted from his seat at the general election in 1847. Five years later (1852), Edinburgh did what it could in the way of reparation, by re-electing M. without a single movement made by him on his own behalf. In 1848, appeared the first two volumes of his *History of England from the Accession of James II.*, the popularity of which must have made even successful novelists envious; next year, he was chosen Lord-rector of the university of Glasgow, on which occasion he received the freedom of the city. When the third and fourth volumes of his *History* were published in 1855, they occasioned a

furor of excitement among publishers and readers, 'to which,' it is said, 'the annals of Paternoster Row hardly furnish any parallel.' In 1857, the French Academy of Moral and Political Sciences made him a foreign associate; and in the course of the same year, he was raised to the peerage of Great Britain under the title of Baron M. of Rothley. His health, however, had long been failing, and on the 28th of December 1859, he expired somewhat suddenly at his residence, Holly Lodge, Campden Hill, Kensington, London. He was buried in Westminster Abbey. A collection of his Miscellaneous Writings was published at London, in 2 vols. (1860).

M. was indisputably a man of splendid talent. His scholarship—in the strictly classical sense of the term—was admirable; his miscellaneous literary acquisitions were something prodigious; his knowledge of modern European, and especially of English history from the age of Henry VIII. down to his own, was unsurpassed—we might with safety say, unequalled; in addition, he had a sagacity and swiftness of understanding that enabled him to comprehend and rapidly methodise his vast array of facts; and what is perhaps more wonderful than all, his style is not in the least affected by the immensity of his attainments. He 'wears all his load of learning lightly as a flower.' In ease, purity, grace, force, and point, he rivals those who have made felicity of style their chief study. He has been accused of partiality, of exaggeration, and of gratifying his passion for epigram at the expense of truth; his *History* has been termed a 'huge Whig pamphlet;' and strong exception has been taken to particular passages, where his views appear to some to be biased by personal antipathies, such as his description of Scotland, the Highlands, the massacre of Glencoe, Marlborough, Penn., &c.; but the essential truth and accuracy of his narrative, as a whole, has never been disproved.

MACAW (*Macrocercus*), a genus of the parrot family (*Psittacidae*), distinguished by a very long wedge-shaped tail, long and pointed wings, large strong feet, the sides of the head naked, the bill short and very strong, the upper mandible greatly arched, and having a long sharp tip, the lower mandible much shorter, and of massive thickness. The species are among the largest and most splendid of the parrot race; they are all natives of tropical America. They do not readily learn to articulate, their attainments seldom exceeding one or two words, but are easily domesticated, and become much attached to those with whom they are well acquainted. Their natural notes are hoarse and piercing screams. They are more or less gregarious, and the appearance of a flock of macaws in bright sunshine is wonderfully brilliant. They breed twice a year, and lay their eggs—generally two—in the hollows of decayed trees. They feed chiefly on fruits and seeds; and often commit great depredations on fields of maize. One of the flock is set to watch on some elevated situation, and on the approach of danger, gives the alarm by a cry. In domestication, macaws readily eat bread, sugar, &c.—The GREAT SCARLET M. (*M. aracana*) is sometimes more than three feet in length, including the long tail.—The GREAT GREEN M. (*M. militaris*) and the BLUE AND YELLOW M. (*M. ararauna*) are rather smaller. These are among the best known species. The other species are numerous.—Allied to the macaws, but approaching to the parakeets, are the species forming the genus *Psittacara*, all of them also natives of the New World. The cheeks are feathered, and the bill less arched than in the true macaws.—Allied to them also are the Araras, of which one, the CAROLINA ARARA, or CAROLINA

MACAW-TREE—MACCABEES.

PARROT (*Arara Carolinensis*), extends much further north in America than any other of the parrot family. It is about fourteen inches long, gay with



Macaw.

green and gold, is gregarious, and commits great depredations in orchards and maize-fields. It cannot be taught to articulate words, but readily becomes very familiar.

MACAW-TREE, GREAT (*Acrocomia sclerocarpa*), a palm of the same tribe with the cocoa-nut, a native of the West Indies, and of the warm parts of America. It is called *Macoya* in Guiana, and *Macahuba* in Brazil. It is from twenty to thirty feet high, with pinnated leaves, from ten to fifteen feet long. The fruit yields an oil, of a yellow colour, of the consistence of butter, with a sweetish taste, and an odour of violets, used, in the native regions of the tree, as an emollient in painful affections of the joints, and extensively imported into Britain, where it is sometimes sold as *Palm Oil*, to be used in the manufacture of toilet-soaps.

MACBETH (or **MACBEATHAD MACFINLEGH**, as he is called in contemporary chronicles), a king of Scotland, immortalised by the genius of Shakespeare. From his father Finlegh, the son of Ruadhri, he inherited the rule of the province of Moray; and he became allied with the royal line by his marriage with Gruoch MacBoedhe, the granddaughter of King Kenneth MacDuff. In the year 1039, he headed an attack upon King Duncan MacCrinan, at a place called Bothgouanan (the 'Smith's Bothy'), where the king was mortally wounded, but survived to be carried to Elgin, in Moray. M. now ascended the throne, and his reign of 17 years is commemorated in the chronicles as a time of plenty. He made grants to the Culdees of Loch Leven, and in the year 1050, went in pilgrimage to Roma. Malcolm MacDuncan, or Ceanmore, the eldest son of King Duncan MacCrinan, had fled to England on his father's death; and, in the summer of 1054, his kinsman, Siward, Earl of Northumberland, led an English army into Scotland against Macbeth. That king was defeated with great slaughter, but escaped from the field, and still kept the throne. Four years afterwards, he was again defeated by Malcolm MacDuncan, and

fleeing northwards across the mountain-range since called the Grampians, he was slain at Lumphanan, in Aberdeenshire, on the 5th of December 1056. His followers were able to place his nephew, or step-son, Lulach, on the throne; and his defeat and death at Essie, in Strathbogie, on the 3d of April 1057, opened the succession to Malcolm, who, three weeks afterwards, was crowned at Scone. This is all that is certainly known of the history of Macbeth. The fables which gradually accumulated round his name were systematised in the beginning of the 16th c. by the historian Hector Boece, from whose pages they were transferred to the Chronicle of Hollinshed, where they met the eye of Shakespeare. Nearly half a century before his great play was written, Buchanan had remarked how well the legend of M. was fitted for the stage.

MA'CCABEES, a word of uncertain meaning and origin. The founder of the Maccabean dynasty, Matithjahu (Assamoniaos, Chashmonaj), a priest (not, as generally supposed, a high-priest, nor even of the family of high-priests), was the first who made a stand against the persecutions of the Jewish nation and creed by Antiochus Epiphanes. At the beginning of the troubles, he had retired, together with his five sons, Jochanan (Gaddes—Kaddish), Simon (Tassi—Mathes), Jehudah (Makkabi), Eleazar (Avaran—Syr. Chavin), Jonathan (Apphus), to Modiin, a small place between Jerusalem and Joppa, to mourn in solitude over the desolation of the holy city and the desecration of the temple. But the Syrians pursued him thither. He being a person of importance, Apelles, a Syrian captain, endeavoured to induce him, by tempting promises, to relinquish his faith, and to embrace the Greek religion. He answered by slaying with his own hand the first renegade Jew who approached the altar of idolatry. This gave the sign to a sudden outbreak. His sons, together with a handful of faithful men, rose against the national foe, destroyed all traces of heathen worship, already established in Modiin and its neighbourhood, and fled into the wilderness of Judah. Their number soon increased; and not long after, they were able to make descents into the adjacent villages and cities, where they circumcised the children, and restored everywhere the ancient religion of Jehovah. At the death of Mattathiah (166 B. C.), which took place a few years after the outbreak, Judah Makkabi (166—161 B. C.) took the command of the patriots, and repulsed the enemy, notwithstanding his superior force, at Mizpah (6000 against 70,000), Bethsur (10,000 against 65,000), and other places, reconquered Jerusalem, purified the temple (Feast of Reconsecration—Chanuka), and reinaugurated the holy service (164 B. C.). Having further concluded an alliance with the Romans, he fell in a battle against Bacchides (161 B. C.). His brother Jonathan, who succeeded him in the leadership, renewed the Roman alliance, and taking advantage of certain disputes about the Syrian throne, rendered vacant by the death of Antiochus, acquired the dignity of high-priest. But Tryphon, the guardian of the young Prince Antiochus Theos, fearing his influence, invited him to Ptolemais, and had him there treacherously executed. Simon, the second brother, was elected by the Jewish commonwealth to assume the reins of the national government, and was formally recognised both by Demetrius, Tryphon's antagonist, and by the Romans as 'chief and ruler of the Jews.' He completely re-established the independence of the nation, and the year after his succession (141 B. C.) was made the starting-point of a new era. The almost absolute power in his hands he used with wise moderation; justice and righteousness flourished in his

days, and 'Judah prospered as of old.' But not long (seven years) after his accession to the supremacy, he was foully murdered (136 B.C.) by his own son-in-law, Ptolemy, who vainly hoped to succeed him. For the subsequent history of this family, see **Jews**; **HYRCANUS**; and **HEROD**. The Feast of the Maccabees—i. e., both of the sons of Mattathiah, and of the seven martyr children (2 Macc. 7)—is found in the Roman martyrology under the date of the first of August.

MACCABEES, **BOOKS OF**, certain apocryphal writings of the Old Testament, treating chiefly of the history of the Maccabees (q. v.). They are usually divided into four parts, or books; the first of which—the most important—comprising the period 175—135 B.C., relates the events which took place in Judaea, Antiochus IV. Epiphanes' misdeeds against the temple, the city, and the nation (ch. i.—ii.); the rising of Mattathiah and his sons against the oppressor, the heroic deeds of Judah Maccabeus (iii.—ix.), of Jonathan (ix.—xii.), and Simon, until the election of Johannes Hyrcanus to the dignity of high-priest. The account, which bears the aspect of strict truthfulness, proceeds chronologically after the Seleucidian era. According to Origen and Jerome, this book was originally written in Hebrew. The author, probably a Palestinian, composed it partly from traditions, partly from official documents, after the death of Simon, during the high-priesthood of Johannes Hyrcanus, and it was shortly afterwards translated into Greek, Syriac, and Latin. The second book contains—1. Two letters from the Palestinian to the Egyptian Jews, inviting them to celebrate the feast of the Reinauguration of the Temple (Chanukah), (i.—ii.); and 2. An extract, with introduction and epilogue, from the five Books of the Maccabees, by Jason of Cyrene. This second portion begins with the spoliation of the temple by Heliodorus, under Seleucus Philopator, and ends with the death of Nicanor; thus embracing the period 176—161 B.C. The two letters are spurious, and of a late date; and the extract from Jason's work—to a great extent, only an embellished repetition of the first Book of the M., of a partly moralising, partly legendary nature—contains many chronological and historical errors, and bears altogether the stamp of being written for merely religious and didactic purposes. The date both of the original and the extract are very uncertain, but the latter does not seem to have been made before the middle of the first c. B.C.

These two Books (*Sifre Chashmonaim*) are the only ones received in the Vulgate, and declared canonical by the councils of Florence and Trent, and translated by Luther. The third and fourth, however, appear to have been altogether unknown to the western church. The former of these treats of an ante-Maccabean incident: the miraculous salvation of the Jews in Egypt whom Ptolemaeus Philopator (221—204 B.C.) tried to force into idolatry. The style and general contents of this book point to an Alexandrine Hellenist as the author or compiler (about 200 B.C.); some investigators (Ewald, Grimm), however, are of opinion that the whole is a poetical invention, intended as a typical description of the circumstances of the Jews under Caligula. The fourth book, wrongly supposed to be identical with Josephus's *Supremacy of Reason*, contains, chiefly, the martyrdom of Eleazar and the seven brothers, and is probably also the work of an Alexandrine Jew living in Egypt—perhaps at the time of Herod the Great—and belonging to the Stoic school. Declamations, dialogues, monologues, and the like, are of frequent occurrence, and impart to the book the character of

a most artificial and strained composition. There is also a so-called fifth book of M. to be found in the Polygot, but only the Arabic and Syriac versions, not the Greek original—the unique MS. of which is supposed to have perished—are extant. See **APOCRYPHA**, **BIBLIA**.

MACCHIAVELLI, **NICCOLÒ DE BERNARDO DEL**, born of an ancient but decayed family at Florence, in 1469, and a pupil of the celebrated scholar, Marsilio Ficino, was employed in public affairs from a very early age, and may be regarded as the literary representative of the political life of the important period to which he belongs. From a subordinate post in the office of the chancellor of Florence, which he held at that critical period of the republic which succeeded the expulsion of the Medici in 1493, he rose, in 1498, to the place of secretary of the 'Ten,' which, in the Florentine constitution of that day, may be regarded as the ministry of foreign affairs. M.'s duties were almost entirely diplomatic; he was employed in a great variety of missions, the instructions and correspondence connected with which may almost be said to contain the secret political history of Italy during his time. The culminating-point of M.'s reputation as a diplomatist was his mission to the great master of treachery and dissimulation, Caesar Borgia, Duke of Valentino, in 1502, of which an account is preserved in 52 letters written during the course of the negotiation, not surpassed in dramatic interest by any series of state-papers which has ever been produced. In the complicated external relations which Italy had now assumed, and which have remained with few changes to the present day, M. is found in communication with all the great foreign powers, as he had hitherto been with the Italian principalities. In 1507, he was sent to the Emperor Maximilian; and in 1510, he undertook a mission to France (the third time he had visited that country in a diplomatic capacity), which had a most important bearing on the relation of France with Italy, and the results of which will be best understood by comparing the league of Cambrai with the subsequent alliance for the expulsion of the French out of Italy. On the restoration of the Medici in 1512, M. was involved in the downfall of his patron, the Gonfaloniere Soderini. He was arrested on a charge of conspiracy in 1513. On being put to the torture, he disclaimed all knowledge of the alleged conspiracy; but, although pardoned, in virtue of the amnesty ordered by Leo X., he was obliged for several years to withdraw from public life, during which period he devoted himself to literature. It was not till the death of Lorenzo de' Medici, in 1519, that M. began to recover favour. He was commissioned in that year, by Leo X., to draw up his report on a reform of the state of Florence; and in 1521, and the following years, he resumed his old official occupation, being employed in various diplomatic services to several of the states of Italy. On his return to Florence in May 1527, he was taken ill, and having trusted to his own treatment of himself, the malady assumed a very formidable character, and in the end proved fatal, on June 22, 1527, just as M. had completed his 58th year. Some difference of opinion has existed as to his religious belief, and as to his sentiments during his last hours; but it seems certain that his death was marked by sentiments of religion, and accompanied by the ordinary ministrations of his church. His last years, however, were comparatively neglected. He was buried in the family vault in the church of Santa Croce; but it was only in 1787, and then through the munificence of a foreigner, the Earl Cowper, that a monument was raised to his memory.

M.'s writings are very numerous, filling 6 vols. 4to (Florence, 1783), or 10 vols. 8vo. Besides his letters and state-papers, which, as we have seen, are of the highest interest, his historical writings also comprise *Florentine Histories*, extending from 1215 to 1492, with a fragmentary continuation to 1499; *Discoveries on the First Decade of Titus Livius*; a *Life of Castruccio Castracani* (unfinished); a *History of the Affairs of Lucca*. His literary works comprise comedies, an imitation of the *Golden Ass* of Apuleius, an essay on the Italian language, and several minor compositions. He also wrote *Seven Books on the Art of War*, which has been much admired by the learned in military science. But the great source of his reputation, for good or for evil, is the celebrated book *De Principibus*, or, as it has since been called, *Del Principe*, some account of which is indispensable, in order to a just appreciation of the author. The main question discussed in this world-famed book is: 'How principalities may be governed and maintained?' In resolving this question, various cases are supposed, for each of which, appropriate rules, principles, and suggestions are laid down, and all are illustrated both by contemporary examples and by a wealth of historical learning which it is difficult to overrate. The 7th chapter, in which he details, and with evident admiration, the system of Cæsar Borgia, and the 18th, in which he discusses 'the duty of princes as to the obligation of keeping faith,' are perhaps those which have most contributed to draw upon the author the odious reputation of which his very name has become the symbol; but, in truth, these chapters are only more precise and more formal than the rest, from their heaping together statements which are elsewhere insinuated or supposed; the broad scheme of the book being everywhere the same, viz., that, for the establishment and maintenance of authority, all means may be resorted to; and that the worst and most treacherous acts of the ruler, however unlawful in themselves, are justified by the wickedness and treachery of the governed. Such being the moral of the book, a question has arisen as to the intention of the writer, and a favourite theory for a time prevailed, that *The Prince* was but a satire upon absolutism, and was designed to serve the cause of liberty, of which M. was an ardent friend, by making arbitrary power odious and contemptible. This theory, however, besides being utterly irreconcilable with the tone of the work, is completely disproved by a letter of M. to his friend Vettori, 1513, which was only discovered in 1810, and which shews that *The Prince* was written by M. in all seriousness, in order to recommend himself to the Medici (for whose private perusal it was designed, and not for publication) as a master in the art of government. In his ardour for the liberation of Italy from the rule of foreigners, M. had become convinced that strong native governments, even though absolute, must be endured; and, having accepted that of the Medici for Florence, he was content to use all means for its security and consolidation. *The Prince* was published, after M.'s death, at Rome, in 1532; and if any doubt should be entertained as to the seriousness of the author, it need only be compared with the commentary which is furnished by every page of his *Legazioni*, or the reports of his diplomatic missions, which are also contained in his collected works. Of the many criticisms and rejoinders to which *The Prince* has given occasion, the most remarkable is that of Frederick the Great, *Antimacchiavelli, ou Examen des Prince de Macchiavelli*, 1740. It may be added that *The Prince* was condemned by Pope Clement VIII.

MA'CCLESFIELD, an important manufacturing town of Cheshire, England, is situated on the river Bollin, on the western base of a range of low hills, 15 miles south-south-east of Manchester. It contains a fine old church, St Michael's, founded in 1278; and a grammar-school, endowed in 1502, and having an annual revenue of £1500. Within the present century, M. has advanced rapidly as a seat of manufactures. Silks, embracing the finest varieties, are the principal fabrics made; cotton goods and small-wares are manufactured, and there are dye-works and breweries. In the vicinity, coal, slate, and stone are obtained. M. returns two members to the House of Commons. Pop. (1861) 36,101, shewing a decrease of 2937 since 1851.

MACCULLOCH, JOHN, a geologist and physician, born in Guernsey, of a Scottish family, 6th October 1778. He studied and took the degree of doctor of medicine in Edinburgh, and was appointed assistant-surgeon to an artillery regiment. In 1811, he was employed by the government in geographical and scientific researches in Scotland. In 1820, he was appointed physician to Prince Leopold of Saxe-Coburg, now king of the Belgians; and in the latter years of his life, was Professor of Chemistry and Geology in the East India Company's military school at Addiscombe. He died at Penzance, Cornwall, 21st August 1835, in consequence of an amputation rendered necessary by an accident. His most important works are a *Description of the Western Islands of Scotland* (3 vols. Lond. and Edinb. 1819); *A Geological Classification of Rocks, with Descriptive Synopses* (Lond. 1821); *A System of Geology, with a Theory of the Earth* (Lond. 1831); *Malaria—an Essay on the Production and Propagation of this Poison* (Lond. 1827); and *An Essay on the Remittent and Intermittent Diseases* (2 vols. Lond. 1828).

MACDONALD, ETIENNE JACQUES JOSEPH ALEXANDRE, Duke of Taranto, Marshal and Peer of France, was born 17th November 1765, at Sancerre, in the department of Cher. He was descended from a Scotch family which followed James II. to France. M. embraced the cause of the Revolution, entered the army as a lieutenant, and rapidly rose to high military rank. In 1793, he was intrusted with the government of the Roman States, but was compelled to evacuate them by the superior force of the enemy. In 1799, he defeated the Austrians at Modena, and was defeated on the Trebbia by a superior Austrian and Russian force under Suwarrow. As commandant of Versailles, he rendered very important service to Bonaparte in the revolution of 18th Brumaire; and in 1800 and 1801, he chased the Austrians from Switzerland and the Tyrol; but after honourably filling some important political posts, he lost the favour of Bonaparte by his honest support of the cause of Moreau. In 1809, he was summoned by the emperor to take the command of the right wing of the army of Italy under Eugène Beauharnais, and took Laibach. He greatly distinguished himself at the battle of Wagram, and on the field of battle became reconciled to Napoleon, who, for his services on that day, created him marshal and duke. He held a command in Spain in 1810, afterwards in the Russian campaign; in 1813, he defeated the Prussians at Museburg, and contributed to the success of the battles of Lutzen and Bautzen, but was subsequently defeated by Blücher at the Katzbach. After the battle of Leipzig, he was employed in covering the retreat of the French army, and saved himself only by swimming the Elster. In the subsequent struggles on French ground, between the Marne and Seine, M. made desperate efforts;

but when he saw that further resistance was hopeless, he advised the emperor to abdicate. The Bourbons made him a peer, and gave him the command of a military division; and on Napoleon's return from Elba, it fell to his lot to oppose his progress to Paris. All his troops went over to Napoleon, but he himself accompanied Louis XVIII in his flight; and although he returned to France, he refused to serve during the Hundred Days. After the second Restoration, he was continually loaded with honours of every kind, but consistently maintained, in the Chamber of Peers, the principles of constitutional liberty. He died at his seat of Courcelles, near Guise, 24th September 1840.

M'CLELLAN, GEORGE B., American general, was born at Philadelphia in December 1826. In his 16th year, he was sent to the United States Military Academy at West Point, where he graduated with high honours in 1846, and joined the army as second lieutenant of engineers, to take an active part in the Mexican war, where he distinguished himself under General Scott, in the battles of Contreras, Churubusco, Molino del Rey, and Chapulapaec, and was promoted to a captaincy. At the end of the war, he was appointed to a professorship at West Point, and wrote a Manual on the Art of War. He built Fort Delaware, commenced a topographical survey for the Pacific Railway, and was one of three American officers sent to observe the campaign in the Crimea. On his return to America, he resigned his commission in the army, and became technical director of the Illinois Central Railway. At the commencement of the War of Secession, 1861, he was appointed major-general of the Ohio militia, but, by the advice of General Scott, he was tendered by President Lincoln the position of major-general of the army. After a successful campaign in Western Virginia, he was made commander-in-chief, and reorganised the army of the Potomac, defeated at Bull Run, July 21, 1861. In the summer of 1862, he invaded Virginia, by the peninsula of James River, and advanced near to Richmond, but was defeated in a series of battles in July, and compelled to retreat, and finally to evacuate the peninsula. After the defeat of General Pope, in the second battle of Bull Run, August 29, 1862, which was followed by a Confederate invasion of Maryland, he reorganised the army at Washington, marched rapidly north, met the forces of General Lee at Antietam, and, after a severe action, compelled him to recross the Potomac. He followed the Confederates into Virginia, but, moving with caution, and being opposed to the policy of the extreme war-party, he was superseded by General Burnside. Retiring to New York, he was honoured by the Democratic party, and is considered a prominent candidate for the presidency in 1864.

M'GULLOCH, JOHN RAMSAY, born at Isle of Whithorn, Wigtonshire, in 1789, a distinguished political writer, and the foremost among our political economists, first became known in connection with the *Scotman* newspaper and the *Edinburgh Review*. He came forward as a contributor to the former, soon after its establishment in 1817; and for a considerable time was its editor. He made his *début* in the latter in 1818, by contributing to it an article on Ricardo's *Principles of Political Economy*, and continued for about twenty years to write pretty regularly for the *Review*, having contributed almost all the economical articles that appeared in it during that period, with a few on other subjects. M., however, is best known by his numerous works published in the course of his life, which are remarkable for the scientific spirit in which they are written, their practical good sense, and the clear-

ness and directness of their style. By these he has done more to establish and popularise the doctrines of political economy than perhaps any other writer. His principal publications comprise: *A Discourse on the Rise, Progress, Peculiar Objects, and Importance of Political Economy; The Principles of Political Economy, with some Inquiries respecting their Application, &c.; The Literature of Political Economy, &c.; Treatises and Essays on Money, Exchange, Interest, the Letting of Land, Absenteeism, &c.; A Treatise on the Succession to Property vacant by Death, including Inquiries into the Influence of Primogeniture, Entails, &c.; A Treatise on the Circumstances which determine the Rate of Wages and the Condition of the Labouring Classes; A Dictionary, Practical, Theoretical, and Historical, of Commerce and Commercial Navigation; Statistical Account of the British Empire; Geographical Dictionary; A Treatise on Taxation and the Funding System, &c.* Most of these works have gone through several editions. A third edition of the work on Taxation, which appeared in 1863, was the last work of the author, and was nearly re-written. M. also published various occasional tracts and notices, some of which have had a very wide circulation. His edition of the *Wealth of Nations*, with an Introductory Discourse and Notes, and his Collected Edition of the Works of Ricardo, deserve to be ranked among the most important services which he rendered to his favourite science. Towards the close of his life, he edited two volumes of scarce economical tracts for the Political Economy Club, and four volumes of the same class of tracts for Lord Overstone. In 1828, M. was chosen Professor of Political Economy in University College, London; but having resigned that chair, he was subsequently (1838) appointed Comptroller of H.M. Stationery Office, a situation which he held till his death, and in which he is understood to have effected various important reforms. M. was a Foreign Associate of the Institute of France; and he enjoyed a pension of £200 a year, conferred upon him by the late Sir Robert Peel. He died November 1864.

M'GULLOCH, HORATIO, a Scottish landscape-painter, was born in Glasgow in 1806, and named after Lord Nelson. His first intention was to fit himself for being a manufacturer, but finally he devoted himself entirely to art. He exhibited for the first time in 1829. In 1836, he was elected an Associate of the Scottish Academy, and next year he fixed his residence at Hamilton, and made enthusiastic studies of the oaks in Cadzow Forest. Two years afterwards, when he was elected a member of the Royal Scottish Academy, he removed to Edinburgh, where he lived till his death in 1867. M. headed the roll of the contemporary Scottish landscape-painters. He painted the Highlands with unrivalled truth, breadth, and imagination. Among his principal pictures are 'Highland Loch,' 'Loch-an-Eilan,' 'View in Cadzow Forest,' 'Dream of the Forest,' 'Misty Corries,' 'Dear Forest, Isle of Skye,' 'Loch Achray,' 'Mist Rising off the Mountains,' 'Kilchurn Castle, Loch Awe,' and 'Bothwell Castle, on the Clyde.'

MACE, a strong short wooden staff, with a spiked metal ball for a head. It was a favourite weapon with knights, with the cavalry immediately succeeding them, and at all times with fighting priests, whom a canon of the church forbade to wield the sword. No armour could resist a well-delivered blow from the mace. The mace is now borne before magistrates as an ensign of authority.

MACE, the Aril (q. v.) of the Nutmeg (q. v.). In the fruit, it is situated within the fleshy part, and envelops the nut. It is a lacerated membrane, blood-red and somewhat fleshy when fresh. It is

prepared for the market by drying for some days in the sun, and flattening. It has a peculiar, strong, agreeable smell and taste, and contains a clear, yellow, volatile oil, and a red, buttery, fixed oil. The volatile oil is obtained from it by distillation. The buttery oil, obtained by expression, mixed with the volatile oil and other substances, is known as *Nutmeg Balsam*. Mace is used as a spice, and has much of the flavour of the nutmeg, but with a slight difference, which to many tastes makes it more agreeable. It is of a bright orange-yellow colour, and has a peculiar wax-like texture. It is imported chiefly from Penang and Singapore, where it is received from the Spice Islands. Small quantities are sent also from the West Indies, where its cultivation receives some attention. About 120,000 lbs. are annually imported into Britain, of which 90,000 lbs. are re-exported.—The aril of species of *Myristica*, different from the true nutmeg, but coarse and very inferior, sometimes appears in commerce as mace.

MACEDO'NIA, anciently, the name of a country lying north of Thessaly. It was originally of small extent, embracing only the district called Emathia, but gradually extended until, in the time of Philip, father of Alexander, it reached, on the N., the Scardian Mountains, a portion of the Hæmus (mod. Balkan) range; on the W., the frontiers of Epirus and Illyria; on the E., the river Nestos (mod. Karasu); and on the S., Thessaly. The country is on the whole mountainous, especially in the south and west, but there are several large plains of great fertility. The principal rivers were called the Strymon, the Axios, and the Haliacmon. M. was famous among the ancients for its gold and silver mines, and its productiveness in oil and wine. It contained a number of flourishing cities, of which the names are well known in ancient history, particularly Pella, the capital, Pydna, Thessalonica, Potidæa, Olynthos, Philippi, and Amphipolis. The Macedonians are believed by some to have been originally an Illyrian race, but this is not probable. Their language, though different from, was yet allied to that of Greece. The singular fact, however, that it employed words not used by the Greeks, but preserved in Latin, would lead us to infer that the ethnological connection between Greece Proper and Macedon belonged to an extremely remote period. The Macedonians were certainly not pure *Hellenes*, nor did the ancients so consider them; but we may regard them as ruder members of the Grecian nation, whose early development had been hindered by unknown obstacles. The history of M. is involved in much obscurity till about 490 B.C., when the Persians subdued it, so that the Macedonian king, Alexander I. was compelled to take part with Xerxes in his invasion of Greece. On the retreat of the Persians after the battle of Platæa in 479 B.C., M. again recovered its independence. Under the wise and vigorous reign of Archelaus, who died 399 B.C., it greatly increased in prosperity and power; but after his death, a period of civil wars and contests for the throne ensued, which ended in the accession of Philip II. (359 B.C.), who not only seated himself firmly on the throne, but knew how to develop the resources of his kingdom, and so to direct the warlike spirit of his subjects as greatly to extend his dominions. His son, Alexander III., surnamed Alexander the Great (q. v.), brought half the then known world under his empire; but after his death, the Macedonian empire was broken up, and at the end of a period of twenty-two years of incessant wars, formed into four principal kingdoms under his greatest generals. M. itself fell to the lot of Antipater, after whose death ensued another period of civil wars and contests for the

throne, of which the Greeks endeavoured to take advantage for the recovery of their ancient independence. But the Athenians having called in the assistance of the Romans against Philip V. of M., by whom their city was besieged, the Macedonians were defeated by the Romans in the great battle of Cyncephalæ (197 B.C.), and both Greece and M. became subject to the Roman power. Perseus, the successor of Philip, was finally defeated at Pydna (168 B.C.), and adorned the triumph of Æmilius Paulus. An attempt of the Macedonian nobles to shake off the oppressive yoke of the Romans having been also defeated, and the nobles driven into exile, M. became (148 B.C.) a Roman province, in which Thessaly and part of Illyria were included. After the time of Constantine, the country was ravaged by Slavic tribes; by the 7th c., the old semi-Greek Macedonians were extinct; and in the later ages of the Byzantine empire, their place was supplied by colonies from Asia, many of them of Turkish descent.—See Finlay's *Medieval Greece*.

MACEDONIANS, a party which arose towards the close of the Arian controversy, and took their name from Macedonius, who became Patriarch of Constantinople in 341. Their distinctive doctrine was the denial of the divinity of the Holy Ghost. In the early stage of the Arian question, the subject of the Holy Ghost attracted no special notice, being equivalently involved in the great subject of dispute regarding the Son. But when it came to be discussed, the same division of opinions was elicited regarding the Holy Ghost which had already arisen about the Second Person of the Trinity. Macedonius taught that the Holy Ghost was 'subordinate to the Father and to the Son, unlike to them in substance, and a creature.'—Socrates, *Eccl. Hist.* ii. 46. He had himself been a member of the semi-Arian party, and as such, had been deposed by the Arians in 360. His party was a considerable one, no fewer than 36 bishops having appeared attached to it at the council of Constantinople in 381. His doctrine, nevertheless, was condemned in that council, in which also was added to the Nicene Creed the special clause by which the divinity of the Holy Ghost is defined. The M. subsisted as a distinct party so late as the time of Theodosius.—They are also called *Pneumatomachi*, or 'Adversaries of the Spirit.'

MACERA'TA, a walled town of Central Italy, and capital of the province of the same name (formerly a delegation). Pop. 19,000. It is finely situated in the midst of hills, on a lofty eminence, 22 miles south-west of Ancona, and commands picturesque views of the sea and the Apennines. The streets are straight and well paved, and there are some fine public edifices, including a cathedral with some good paintings, six other minor churches, and numerous conventual establishments. The Palazzo Comunale, or town-hall, is a beautiful building of the 13th century. M. has a university of high repute, and is a centre of intellectual and social Italian life. The province contains a population of (1863) 239,411.

MACERS are officers attending the supreme courts in Scotland, appointed by the crown. Their duty is to keep silence in the court, and execute the orders of the courts, if addressed to them. They hold their office for life, and are paid by salary.

MACGILLYCUDDY REEKS, the highest mountains in Ireland, forming a group in the west of the county Kerry, and rising from the western shores of the Lakes of Killarney, to the beauty of which their lofty heath-covered summits add an element of grandeur. The Reeks cover an area of

about 23 square miles; and Carran-tual, the loftiest peak, is 3404 feet in height.

MACHICOLATIONS, the apertures between the corbels supporting a projecting parapet. The machicolations are for the purpose of allowing projectiles to be hurled at an enemy when he approaches near the wall, as in scaling, undermining, &c. Such defences are very common in castellated architecture, especially over gateways, towers, &c.

MACHINE AND MACHINERY. See **MECHANICAL POWERS.**

MACHINE-ENGRAVING has within the last few years been introduced for the purpose of superseding, in whole or in part, the manual operations of the engraver. The first step in this direction was the invention of the ruling-machine by Wilson Lowry for the purpose of engraving plain backgrounds, skies, or any other portions where the work was purely mechanical. The saving of labour effected by this instrument was very great, and as its work was performed in a most satisfactory manner, it soon came into very general use. But what is properly denominated machine-engraving is executed wholly by machinery. This department consequently excludes all artistic work, and is generally restricted to the engraving of patterns, bank-notes, &c. For the engraving of bank-notes, several machines have been invented, but their mechanism cannot here be described, as, besides being very complex, it is, for obvious reasons, kept secret as far as possible. The Americans have particularly distinguished themselves in this branch of engraving, and, in fact, it is to one of that nation, Mr Perkins, that the introduction of the bank-note engraving-machine is due. The latest and most perfect machine for engraving is that invented by Wagner of Berlin, and called by him the 'Universal Rose Engine, or Guilloche Machine,' which consists of a number of machines capable either of separate or of combined action, the number of distinct apparatus being co-extensive with the number of species of lines composing the pattern. The number and arrangement of the different apparatus can be so varied, that a practically unlimited number of patterns may be obtained, and the correctness and delicacy of these patterns is such as can hardly be surpassed.

MACHINERY, POLITICAL ECONOMY OF. It has never been questioned that machinery has added greatly to the productive power and the possessions of mankind, and has thus tended to place the poor more nearly on a par with the rich, by enabling them to obtain, at a cheap rate, articles of comfort and luxury of so good a quality as not to be capable of improvement by increase of expenditure. A mischievous fallacy has, however, often taken possession of the uninstructed, to the effect that machinery has a tendency to dispense with hand-labour, and so to benefit the consumer at the expense of the workmen. To clear away this fallacy, it is only necessary to remember, that machinery itself must be made with hands; that the capital of a country will not be diminished by the employment of machinery; and that such capital must continue to be employed in paying wages, as of old. It is true that there is a shifting of the parties to whom the wages are paid. When the power-loom was invented, much of the capital that went to hand-weaving was spent on iron and wood for the construction of power-looms. It is a speciality of machinery that it is apt to train the hands to do but one thing, and that thing is liable to fluctuations. The remedy for this is in the working-man not supposing, as he too often does,

that he has a right to be employed all his days in one special form of work, but in learning a variety of occupations, or rather learning the faculty possessed by intelligent people of turning the hand to a new function when that is necessary. It is of the more importance to keep this in view, that some kinds of manufacture accumulate in certain districts where they can be best executed, and in these there arises a sort of monopoly in the manufacture for the time being, but this monopoly is liable to be broken and affected by many accidents. Thus, the war with America has lately in this way powerfully affected the cotton manufacture, and driven a large body of people either to find another occupation, or to become paupers.

MACKENZIE, SIR GEORGE, an eminent Scottish lawyer and politician, son of Simon Mackenzie, brother of the Earl of Seaforth, was born at Dundee in 1636, studied Greek and philosophy at St Andrews and Aberdeen, and civil law at Bourges, in France, then—as he himself calls it—'the Athens of Scottish lawyers.' In 1661, he acted as counsel for the Marquis of Argyll, then tried by a commission of parliament for high treason. About the same time, he was made a justice-depute, and among his other duties we find him, in 1661, appointed to repair 'once in the week at least to Musselburgh and Dalkeith, and to try and judge such persons as are ther or therabout delated of witchcraft.' He was soon after knighted, entered the Scottish parliament in 1669 as member for Ross-shire, and in 1677 was named king's advocate. Up to this point, his career had been marked by a decidedly patriotic spirit, and he was even one of the most popular men in the country. In the midst of his professional labours, he prosecuted literature with great assiduity. In 1663 appeared his *Religio Stoici, or a Short Discourse upon several Divine and Moral Subjects*; in 1665, his *Moral Essay upon Solitude*; and in 1667, his *Moral Gallantry*. He also composed some poetry. His style is admirable for the time in which he lived; he was among the first Scotchmen who wrote the English language purely. M. cultivated the friendship of the great English writers of his day, and his own taste appears to have been excellent. Dryden, in his *Discourse on the Origin and Progress of Satire*, alludes to him as 'that noble wit of Scotland.' Unhappily, in the popular mind he is better known as criminal prosecutor in the memorable days of the Covenant, in which capacity he earned for himself the ugly name of the 'bluidy Mackenzie;' nor, we fear, can it be disproved—in spite of his liberal antecedents—that he became a willing instrument of despotism. He has, however, written a defence of himself, entitled *A Vindication of the Government of Charles II.* In 1678 appeared his *Discourse on the Laws and Customs of Scotland in Matters Criminal*; in 1684, his *Institutions of the Laws of Scotland*; and shortly after, he took the leading part in founding the Advocates' Library. He then retired to Oxford, and died in London, 2d May 1691.

MACKENZIE, HENRY, a British novelist, was born in Edinburgh in 1745, received his education at the university of his native city, and practised as an advocate there. In 1804, he was appointed comptroller of taxes for Scotland. He died 14th January 1831, at the advanced age of 86. His *Man of Feeling* (1771), *Man of the World* (1783), and *Julia de Rouvigné*, won him rather a high place among the authors of his time. There is in all of these works something of the minuteness of Richardson, with a peculiar soft and sentimental tone, partly derived from Sterne, but without much evidence of high genius. In 1778, M. began to edit a periodical called

MACKENZIE RIVER—MACKINTOSH.

the *Mirror* (modelled after the *Spectator*), which lasted for 17 months, and was followed by the *Lounger* in 1785, which lasted for two years. His contributions to these display a greater manliness of style than his fictions, and a considerable measure of wit and humour. He had the credit of being the first to direct public attention, by an article in the *Lounger*, to the merits of the poems of Burns. He afterwards entered into the controversy concerning the poems of Ossian, the authenticity of which he denied, and also wrote political pamphlets in support of Pitt's administration.

MACKENZIE RIVER, an important river of British North America, discovered and first navigated by Alexander Mackenzie—from whom it derives its name—in 1789, has its origin under the name of *Athabasca River* (q. v.), in Mount Brown, and after a north-north-east course of 687 miles falls into Lake Athabasca. Emerging from this lake as the *Slave River*, it receives the *Peace River* (q. v.), and after another course of 210 miles falls into Great Slave Lake (q. v.). It now assumes the name of *M. R.*, and conveys the waters of the Great Slave Lake to the Arctic Ocean at Mackenzie Bay, after a final course of 876 miles, making a total of 1773 miles. In many places it is more than a mile in width, and it is navigable for steam-boats throughout the greater part of its course from Great Slave Lake. There is only one obstruction, and that not a material one, occurring near Fort Hope, in lat. about 66° N. Its chief affluent is the Liard, which rises on the west side of the Rocky Mountains, and after a course of 380 miles, forces its way through a pass, and after flowing first east and then north, joins the *M. R.* after a total course of 690 miles. The mouth of the river is closed from October to June by ice. See *ATHABASCA* and *GREAT SLAVE LAKE* and *RIVER*.

MA'CKEREL (*Scomber*), a genus of fishes of the family *Scomberida* (q. v.); having a spindle-shaped body; the tail becoming very slender, and slightly ridged or keeled on each side. Some of the species have, and some have not, air-bladders.—One species, the **COMMON M.** (*S. scomber*), is plentiful on the coasts of Britain, and of Europe, from the Mediterranean to the furthest north, also on those of Greenland, and on the American side of the North Atlantic Ocean. It is a very beautiful fish, of brilliant green and blue, the males having nearly straight dark transverse bands, the females having the bands elegantly undulated. The tail is crescent-shaped. The *M.* is said sometimes to attain a length of 20 inches, but is usually about 14 or 16 inches long, and about 2 lbs. in weight. It is highly esteemed for the table, and the *M.* fisheries of the south of England and of the southern parts of Europe are very important. *M.* is readily caught by bait, and particularly by any kind of bait moving swiftly through the water—a long slice cut from one of its own kind, or even a slip of red leather, or a piece of scarlet cloth. Boats engaged in *M.* fishing are therefore often under sail, and a smart or 'mackerel' breeze is preferred. But the greatest quantities of *M.* are taken by nets; seine-nets wrought by two boats, and enclosing shoals of fish, or drift-nets—20 feet deep by 120 feet long—well corked at the top, and without lead at the bottom. *M.*, after being taken, must be sent very quickly to market, as they very soon cease to be quite fresh. Fast-sailing boats are employed for this purpose, which purchase from the fishing-boats, and often employ the aid of steam. In France and some other parts of Europe, *M.* are often salted.—It was formerly supposed that great migrations of *M.* took place; but it is now believed, as in regard to

herring, that they merely leave the deep water and approach the coast for the purpose of spawning. The time when they appear varies in different latitudes: in the south of England, the *M.* season is in the end of spring and beginning of summer; in Orkney, it is in the end of summer.—Another species, the **SPANISH M.** (*S. colias*), which attains the weight of 4 or 5 lbs., and is more obscurely banded, is sometimes caught on the southern coasts of Britain, but is little esteemed. It has an air-bladder, which the common *M.* has not.—The **SCAD** (q. v.) is sometimes called **HORSE-MACKEREL**.—The **MACKEREL-MIDGE**, a very small fish, is a species of **Rockling** (q. v.), of the family *Gadida*.

MA'CKINAW, or **MICHILIMA'CKINAC**, a village, on an island of the same name, in the north-west part of Lake Huron, belonging to Michigan, United States of America, 320 miles west-north-west of Detroit, is an old French trading-post, now a fashionable summer resort. Fort Mackinaw, on a bluff 150 feet high, commands the village and harbour. It has extensive fisheries, and is a stopping-place for steamers plying between the lower and upper lakes. Pop. about 2000.

MACKINTOSH, Sir JAMES, a philosopher and politician, was the son of Captain John Mackintosh of Kellachie, in Inverness-shire, and was born at Aldourie in that county, October 24, 1765. He studied at King's College, Aberdeen, where his most intimate companion was Robert Hall, afterwards the celebrated Baptist preacher. From King's College he proceeded to Edinburgh in 1784, for the purpose of studying medicine; and after obtaining his diploma, settled in London, and for some time supported himself by writing for the newspapers. The first work that brought him into notice was his *Vindicia Gallica* (1791), in reply to Burke's *Reflections on the French Revolution*. In sober philosophic thought, sound feeling, and common sense, it greatly surpassed the splendid philippic against which it was directed, and was enthusiastically lauded by the Liberal party; Burke himself thought highly of it. Fox, Sheridan, and other leading Whigs sought the author's acquaintance; and when the 'Association of the Friends of the People' was formed, he was appointed secretary. About this time, he began to turn his attention to the legal profession, and was called to the bar in 1795, and attained high eminence as a forensic lawyer. In 1799, he delivered a course of lectures on the Law of Nature and of Nations, before the benchers of Lincoln's Inn, which were attended by audiences of the most brilliant description. His defence of Peltier (February 21, 1803), charged with a libel on Bonaparte, was superb. It was translated into French by Madame de Stael, and scattered broadcast over Europe. In 1804, he was appointed recorder of Bombay, for which place he sailed in the beginning of the year, arrived there in May, was appointed judge of the Admiralty Court in 1806, and remained till 1811. His Indian career was highly creditable to his capacity and honourable to his character. After his return to England, he entered parliament as Whig member for Nairn (1813), accepted the professorship of law in the college of Haileybury in 1818, and in 1830 became a member of the Board of Control under the Grey ministry, and spoke in favour of the Reform Bill. This was his last great political effort. He died not long after, on the 22d of May 1852. Every one now will regret that Sir James M. ever turned aside to a political life. He was essentially a literary moralist and philosopher, and might have won a far higher and more enduring reputation than he has, if he had resolutely prosecuted the calling for which nature

intended him. His *Dissertation on the Progress of Ethical Philosophy*, written for the *Encyclopædia Britannica*, although very incomplete, and lacking that precision and profundity that can only be acquired by rigorous and extensive research, shews the admirable powers of the author, his breadth of view, tolerance, impartiality, love of truth and virtue, and his gift of calm and measured eloquence. For Lardner's *Cyclopædia*, he wrote a brief but excellent survey of the History of England. An historical fragment (intended to form portion of a large work) entitled *History of the Revolution in England in 1688*, appeared after his death, and was pronounced by Macaulay to be the best history of the reign of James II. A collection of his miscellaneous works, including his contributions to the *Edinburgh Review*, was published at London, in 3 vols. See *Memoirs* of his life by his son, 2 vols. (Lond. 1835).

MACKNIGHT, Dr JAMES, an eminent divine of the Church of Scotland, was born at Irvine, in Ayrshire, 17th September 1721; studied at Glasgow University, and afterwards at Leyden, in Holland; and in 1753 was ordained minister of the parish of Maybole. In 1769, he was translated to Jedburgh, and thence to Edinburgh in 1772, where he died, 13th January 1800. M. was a superior scholar, a liberal, wise, and prudent ecclesiastic, and one of the most respectable writers that the Church of Scotland has produced. His principal works are—*Harmony of the Four Gospels* (1756); *The Truth of the Gospel History* (1763); and *A New Translation of the Apostolical Epistles, with Commentary and Notes* (1795).

MACLAURIN, COLIN, an eminent mathematician, was born, in 1698, at Kilmodan, in Argyleshire, Scotland. He was educated at Glasgow University, where he took the degree of M.A. in 1713; and after four years of close study obtained, in 1717, after a severe competitive trial, the professorship of Mathematics in Marischal College, Aberdeen. In 1719, he visited London, and was received as member of the Royal Society, at the same time making the acquaintance of many eminent men, Newton among the rest. Here he published his *Geometria Organica* (1720), an elaborate treatise on the 'description' of curves. He afterwards visited France in the capacity of tutor to a son of Lord Polwarth, and while there, wrote a dissertation on the impact of bodies, which gained the prize of the Academy of Sciences in 1724. The following year, he was appointed assistant to James Gregory, Professor of Mathematics in the university of Edinburgh, and soon after succeeded him in the chair. He died in 1746. His writings, distinguished for their originality, profundity, clearness, and elegance of style, gave a strong impetus to the study of mathematical science in Scotland. His works, besides those above mentioned, are—*A Treatise of Fluxions* (Edinburgh, 1742), a work written in defence of Newton's discoveries, against the attack of Berkeley, and the first in which the principles of fluxions were logically arranged; *A Treatise on Algebra* (1748), left incomplete by the author; *An Account of Sir Isaac Newton's Philosophical Discoveries* (Lond. 1748), also incomplete and posthumous, which contains explanations of all Newton's discoveries, the optical ones excepted; and a number of papers which were published in the *Edinburgh Philosophical Transactions*. His most important scientific investigations related to the 'form of the earth,' the 'tides,' and the action of the wind on the sails of ships and wind-mills. His memoir on the tides was, in 1740, presented in competition for the prize offered by the Academy of Sciences; but three other competitors, Euler, Daniel

Bernoulli, and Father Cavalleri, having appeared, the Academy, after consideration, shared the prize among them.

MACLE, a term employed in mineralogy to designate what are also called *twin crystals*, which are crystals united according to some precise law, yet not having their faces and axes parallel, so as to render the one a mere continuation of the other. In some macles, the axes are parallel; in some, they are inclined at an angle. Crystallisation in macles is very characteristic of some minerals.

MACLE is also the name of a mineral, also called **CHIASTOLITE**, a silicate of alumina, containing a little magnesia and oxide of iron. It occurs in crystals, of a dirty or pale gray colour, or yellow or red, imbedded in clay-slate, in Cumberland, Wicklow, Brittany, the Pyrenees, &c. The crystals are rhombic prisms, remarkable for presenting, in the section perpendicular to the axis, a dark cross on a light ground. Although it is of very dull lustre, M. has therefore been much used for making beads for rosaries, &c. Polished slabs present a curious appearance, like Hebrew writing. M. is the armorial bearing of the great French House of Rohan.

MACLISE, DANIEL, R.A., an eminent painter of Scotch extraction, was born at Cork, in Ireland, January 25, 1811; entered the Royal Academy, London, in 1828, and acquired a high reputation as a student. In 1833, he exhibited his first picture at the British Institution, 'Mokanna unveiling his Features to Zelica;' and in the same year, 'All-Hallow Eve,' and 'A Love Adventure of Francis I. with Diana of Poitiers,' at the Royal Academy. Since then, among his principal works may be mentioned—'Chivalrous Vow of the Ladies and the Peacock' (1835); 'Robin Hood and Richard Cœur-de-Lion,' and 'Merry Christmas in the Baron's Hall' (1838); 'The Banquet Scene in Macbeth,' and 'Scene from Twelfth Night' (1840); 'The Sleeping Beauty,' and 'Hunt the Slipper at Neighbour Flam-borough's' (1841); 'Play Scene in Hamlet' (1842); 'Sabrina releases the Lady from the Enchanted Chair' (1844); 'Ordeal by Touch' (1846); 'Chivalry of the Reign of Henry VIII.,' and his design of 'Shakspeare's Seven Ages' (1848); 'The Gross of Green Spectacles' (1850); 'Caxton's Printing-office' (1851); and 'The Marriage of Strongbow with the Princess Eva' (1854). For some years, he has been engaged on a series of cartoons, to be painted in fresco in the Royal Gallery of the Houses of Parliament, illustrative of the glories of England in war. M. is regarded as a thoroughly original artist. His imagination is extremely rich, his power of composition great, and his colouring fine.

MÁCON (ancient, *Matisco*), a town of France, capital of the department of Saône-et-Loire, on the right bank of the Saône, over which there is a bridge of 13 arches, 38 miles north of Lyon. On the river-side are ranges of handsome quays, with two commodious harbours, and a line of fine houses. In general, however, the streets are crooked, narrow, and dirty. It contains several noteworthy churches, and the ruins of a cathedral, almost wholly destroyed during the first Revolution. M. carries on an extensive trade in the excellent wines grown in the vicinity (known as Macon), as well as in corn, cattle, &c.; leather, blankets, earthenware, cloaks, and watches are manufactured. Pop. 16,550. M. has some Roman antiquities, among which are remains of a triumphal arch and of a temple of Janus.

MÁCON, a city of Georgia, United States of America, at the head of the navigation, and on both sides of the river Ocmulgee, 190 miles west-north-west

from Savannah, on the Central Georgia Railway. It has many elegant public buildings, among which are a court-house, market, nine churches, seven banks, academy, blind asylum, Wesleyan female college, &c. M. has six newspapers, and carries on a large business. Pop. (1860) 8247.

MACPHERSON, JAMES, a person who has obtained a remarkable notoriety in literature, was born in 1738, at Ruthven, in Inverness-shire. After finishing his studies at King's College, Aberdeen, he became a schoolmaster in his native village, published a poem entitled *The Highlander* in 1758, contributed about the same time verses to the *Scots Magazine*, and in the following year, having met with the Rev. Dr Alexander Carlyle, minister of Inveresk, and John Home, the author of *Douglas*, he shewed them some fragments of Gaelic verse, of which he also gave them 'translations.' These 'translations' (16 in number) appeared in 1760, and were so much relished, that the Faculty of Advocates in Edinburgh raised a subscription to enable M. to make a tour through the Highlands for the purpose of collecting more of the same. M. was very zealous and successful in the 'discovery' of literary treasures. Where he made his discoveries, however, no man knows. He found ancient MSS. in regions where no one before had suspected their existence, and where no one since has been fortunate enough to obtain them. The result was the appearance at London, in 1762, of the so-called 'Poems of Ossian,' under the title of *Fingal, an Epic Poem, in Six Books*; and in 1763, of *Temora, an Epic Poem, in Eight Books*. A storm of controversy soon arose in regard to their genuineness, which has hardly yet subsided, but on the whole, we may safely say the verdict is unfavourable to Macpherson. See OSSIAN, POEMS OF. These poems were, however, the making of him in a worldly point of view. He was appointed surveyor-general of the Floridas (in 1764) with a salary for life, and agent to the Nabob of Arcot—a very lucrative office—in 1779; entered parliament in the following year as member for Camelford, sat for ten years, and then retired to an estate which he had purchased in Inverness-shire, where he died February 17, 1796. His body was brought back to England, and was actually interred (at his own request and expense) in Westminster Abbey. M. wrote in the latter half of his life a variety of historical compilations, pamphlets, &c., and translated Homer's *Iliad* into prose.

MACQUARIE, a river of East Australia, rises about 80 miles west of Sydney, in the county of Westmoreland, and has a north-west course of 280 miles. Its waters are lost in marshes, whence issue tributaries of the Darling, of which river the M. may be said to be one of the head waters.

MACQUER, PIERRE JOSEPH, born at Paris in 1718, of a family originally Scotch, has acquired a reputation as a chemist and physician. He died 15th February 1784. M.'s principal works are *Éléments de Chimie théorique* (Par. 1741); *Éléments de Chimie pratique* (Par. 1761); and a *Dictionnaire de Chimie* (Par. 1776). See GASES.

MACREADY, WILLIAM CHARLES, an English tragedian, whose father was the manager of a provincial company, was born in London, 3d March 1793, educated at Rugby, and made his first appearance as Romeo at Birmingham in 1809. For four years he was connected with his father's company, and for two years thereafter he sustained leading parts in the provinces. In September 1816, he made his first appearance before a London audience, and gained the applause of Kean, who was one of his auditors. His progress in the higher walks of the drama was slow, principally, it is

understood, from professional jealousies. In 1819, he made a hit in the character of Richard III., and he afterwards adventured on other of Shakespeare's characters with success. In 1826, he made a tour in the United States, and he visited Paris in 1828. He became lessee of Covent Garden Theatre in 1837, and relinquished it two years thereafter. He afterwards undertook the management of Drury Lane, but gave it up after encountering considerable pecuniary loss. In 1849, he visited America for a second time, and barely escaped with his life from a riot which took place in the theatre at New York, caused by the jealousy of Mr Forrest, an American actor. On his return home, he was engaged at the Haymarket, and his theatrical career was brought to a conclusion on February 3, 1851. He took his benefit at Drury Lane on the 26th of the same month. Shortly afterwards, the Macready Banquet was celebrated, attended by a host of friends distinguished in literature and art, and at which a sonnet, composed by Mr Tennyson—taking a grateful farewell of the great actor—was read.

M. was a fine and impressive actor, but he was more indebted for his success to art than to nature. He succeeded best in the graver characters of the drama. He inherited more of the stateliness of Kemble than the fire of Kean.

M'CRIE, DR THOMAS, a Scottish divine and historian, was born at Dunse, in Berwickshire, November 1772, studied at the university of Edinburgh, and was ordained, in 1795, pastor of an Anti-Burgher congregation in that city. Here he died, 5th August 1835. M.'s works are in the highest degree valuable to the student of Scottish ecclesiastical history. They exhibit a vast amount of minute yet important research, and though they are essentially apologetic, the author is never consciously unfair, and does not misstate facts. He has, however, a way of palliating even the indefensible acts of the Reformers, and a zeal for Presbyterianism, that caused the impartial Hallam to describe his spirit as *Presbyterian Hildebrandism*. M.'s best known works are *The Life of John Knox* (Edin. 1812), and *The Life of Andrew Melville* (1819).

MACROBIUS, AMBROSIUS AURELIUS THEODOSIUS, a Latin grammarian of the 5th century. He appears to have been by birth a Greek, but literally nothing whatever is known of his life. Two of his works remain, entitled *Commentarius ex Cicero in Somnium Scipionis*, and *Saturnaliorum Convivialium Libri Septem*. The former is the best known, and was much read during the middle ages; the latter is in the form of a dialogue, and contains many valuable historical, mythological, antiquarian, and critical observations. Of a third work, *De Differentiis et Societatibus Græci Latinique Verbi*, we possess only extracts made by one Joannes—thought by Pithou to be Joannes Scotus—in the 9th century. It has been warmly discussed—as if it were of consequence to mankind—whether M. was a Christian or a pagan. The evidence for his being the former is, that he speaks of God as *omnium fabricator* (the maker of all things), which must be reckoned as extremely slender; and of the latter, his great admiration for the piety and wisdom of one Prætextatus, a heathen priest, and his reverence for Greek divinities. The *editio princeps* of M. appeared at Venice in 1472; of later editions, the best is that of Gronovius (Leyden, 1670), reprinted by Zeunius at Leipzig in 1774.

MACTRA, a genus of lamellibranchiate molluscs, having a somewhat triangular shell, broader than long, the valves equal; the animal with the siphons united to the extremity, and a large compressed

foot. They are sometimes called Trough Shells. The species are numerous, and widely distributed; they burrow in the sand and mud of sea-shores, and of the bottom of the sea. The foot enables them also to move with activity, after the manner of



Mactra Stultorum.

cockles. Some of the species have shells of considerable beauty, others are coarse. Several small species are very abundant on the British shores, so that in some places they are gathered for feeding pigs, but not by those who have much regard to the quality of the bacon. The fossil species are few. The genus *M.* is the type of a family, *Mactridæ*.

MACULÆ is the term given by Willan and Bateman, and some other dermatologists, to one of the orders of skin-diseases. The affections included in the term maculæ can, however, hardly be regarded as diseases; they are merely discolorations of the skin, resulting from some change in the production of the colouring matter. The following varieties are recognised.

1. *Lentigo*.—This term is applied to those small yellowish or brownish-yellow irregularly rounded spots which are denominated freckles, and which are most abundant on the parts chiefly exposed to the light, as the face, hands, &c. In some cases, these spots are congenital, while in other cases they seem to be produced by exposure to the sun's rays; and in both cases they chiefly occur to persons of fair complexion with light sandy hair. When patches of a larger size than that of ordinary freckles are produced by exposure to the sun, the affection receives the name of *Ephelis*. Congenital spots cannot be removed by any applications; but those which depend on exposure may be treated with soothing lotions or liniments, as an emulsion of sweet almonds, or a mixture of lime-water with almond oil.

2. *Pigmentary Nevus*.—This is a congenital dark discoloration of the skin, with little or no elevation of the surface, and often covered with hair. It usually occurs in small spots, but sometimes appears in large patches. It is perfectly harmless, and should not be interfered with.

3. *Albinism* or *Leucopathy*.—This affection has been already noticed in the article ALBINOS. When congenital, it may be considered irremediable, but cases of partial albinism, occurring after birth, may sometimes be relieved by local stimulants.

MADAGA'SCAR, an island situated to the south-east of the African continent, and extending over an area larger than the British Isles, and containing a population of upwards of five millions. It is in lat. $11^{\circ} 57' - 25^{\circ} 38' S.$, and long. about $43^{\circ} - 51^{\circ}$; length, 1030 miles; greatest breadth, 350 miles; area estimated at 225,000 square miles. The early history of this interesting island is involved in the deepest mystery. It is supposed to have been known to the ancients, by whom it was generally considered as an appendage to the mainland, and the Phœnicians are probably the navigators to

whom its discovery is due. In the year 1774, the Baron Benyowsky, a Pole by birth, formed a French settlement at Antongil Bay, on the eastern side of the island. This establishment, partly owing to the hostility of the natives, and to the supineness of the French government at home, gradually fell into decay, and was ultimately abandoned. The natives consist of many tribes, of which the Hovas inhabit the centre and northern portion of the island, and are at present so powerful as to hold in subjection most of the others. The features of this section of the inhabitants present a striking resemblance to those of the South Sea Islanders. They are evidently of different extraction to the other and darker tribes, whose features are wholly African. The men are generally well made, having finely proportioned limbs, and usually present a high type of physiological development. The women are well formed and active, but by no means so prepossessing in feature as the other sex. The complexion of the Hovas is a ruddy brown or tawny colour, while that of the other tribes is much darker. Another and very peculiar distinction is the long, straight hair of the former as compared to the woolly growth of their neighbours. The principal article of dress in use among the Hovas is the lamba, a garment very similar to the Roman toga, and made of cotton or linen materials.

In the year 1816, diplomatic and commercial relations were entered into between the British government and Radama, king of the Hovas, who had gradually extended his influence over the greater part of Madagascar. In consideration of his promise of assistance to suppress the slave-trade carried on in the Mozambique, English drill-sergeants were sent to him to discipline the native troops. Missionaries had previously established themselves, and by their aid a few English mechanics found the means of introducing useful arts among the inhabitants. With the ostensible object of carrying out his agreement, Radama was furnished with firearms for his troops, which he quickly, however, made use of in the reduction of such tribes as yet remained in opposition to his supremacy. Upon the death of Radama, he was succeeded by Ranavala Manjaka, a woman, whose reign was marked by every cruelty possible to be practised against the native Christians. She closed the missionary schools, banished the religious instructors, and drove the suffering converts to the shelter of the fastnesses of the country, where they were either hunted down and put to death, or lingered in misery, to bewail their lost relatives and companions. One of the acts of the new queen was to issue an order which banished Europeans from the island, which had the effect of stopping the trade between her dominions and the neighbouring British colony of Mauritius. In consequence of the outrages upon British subjects to which this order gave rise, Sir William Gomm sent H.M.S. *Conway* to Tamatave (1845), the usual trading-port on the eastern coast, with instructions to co-operate with the French from Bourbon in the endeavour to secure a satisfactory issue of the dispute. Failing in this, resort was had to arms. A detachment of French and English seamen was landed from the ships under cover of their guns, and proceeded to attack the fort. Finding the work, however, of far greater strength than had been supposed possible, the allies were compelled to retire without having fully accomplished their purpose. The loss in this affair was disastrous; it consisted of 21 killed and 54 wounded, inclusive of both English and French. On receipt of the news of this engagement in France, an expedition was planned to chastise the Malagash for the outrage;

but the complications then existing in the situation of the French cabinet prevented its accomplishment. In 1862, Queen Ranavala Manjaka died, and her son was proclaimed king under the title of Radama II. This prince, of a weak and vacillating character, at first gave promise of encouragement to the unfortunate native Christians; but his subsequent acts were marked by a favouritism and general maladministration, which, in 1863, procured his destruction, together with his ministry. A conspiracy being formed with the object of overthrowing the government of the king, he was strangled in his palace, his queen being prevailed on to accept the supreme authority, and the government being modified into a constitutional form.

M. presents some remarkable features of interest in its natural aspect. It is traversed throughout its entire length by a mountain-range, rising in several of its summits to 10,000 or 12,000 feet in height, and sending off branches toward the shores, which, however, are generally low. From this range numerous rivers flow to the eastern and western shores. Of these many are admirably adapted for commerce, and one, the Betsibuka, is about 400 miles in length. The north-western coast is indented with bays well sheltered from the prevailing winds, and affording secure anchorage for shipping. The country is covered with luxurious verdure, and the climate is agreeable for at least six months during the year; the prevalence of low fever, however, renders it very undesirable as a residence for Europeans. Throughout the island, an abundant supply of timber would be obtainable, did roads exist by which to convey it to the coast. The exports of M. are horned cattle and a small quantity of rice, shipped principally to Mauritius and Bourbon. The island is rich in iron, but the present means of working it are very deficient; indeed, so abundant is the supply, that the natives seldom take the trouble to excavate beyond a few feet. The Malagash are excellent smiths, and their forges, though rude, are capable of producing most of the implements employed by them in husbandry, and such mechanical arts as are practised. At present, the only mode of travelling is in palanquins, borne on the shoulders of men; and the paths by which this simple method of journeying is performed are often so bad as to cause much delay. The country being covered, for the most part, with forest, the making of roads would be a work of many years; and the natives know too well the importance of keeping the interior of their beautiful island inaccessible to the advance of an enemy, to hazard the attempt. The capital and seat of government is Antananarivo (the 'City of a Thousand Towns') (q. v.). It was visited in 1862 by an embassy from the British at the Mauritius, and there are now consuls established there. Both the flora and the fauna of M. are peculiar, and comprise many species, and even many genera nowhere else to be found. Even of the quadrupeds, many are peculiar; and in this department of zoology, the number and variety of the *Lemuridae* is a prominent characteristic. Orchidaceous plants and ferns are very numerous and beautiful; and among the botanical curiosities of M., are the Traveller's Tree (*Urania speciosa*), and the beautiful Lattice-leaf plant (*Ouvirandra fenestralis*).

MADDALONI, a city of Italy, in the Neapolitan province of Terra di Lavoro, 14 miles north-north-east of Naples. Pop. 17,160. It stands in a finely irrigated and fertile district, and enjoys a most salubrious climate. It is an industrious and thriving place, with several fine palaces and churches. It is now connected by railway with Naples and Gaeta.

MADDER (*Rubia*), a genus of plants of the natural order *Rubiaceae*, very nearly allied to the genus *Galium* or Bedstraw (q. v.), and differing from it chiefly in having a juicy fruit resembling two small berries growing together. The species are found in the tropical and warmer temperate parts, both of the Old and New Worlds, and are important for the colouring matter of their roots. The most important is the COMMON M. or DYER'S M. (*R. tinctorum*), a native probably of the south of Europe as well as of Asia; and now very extensively cultivated in most European countries, and also in the East Indies, China, &c. It is a perennial; with weak stems and whorls of 4–6 elliptic or lanceolate glossy leaves, the stem and leaves rough with sharp prickles; small greenish yellow flowers, and black fruit.—MUNJEET (q. v.), or INDIAN M. (*R. munjista* or *cordifolia*), ranks next to it in importance.—The roots of *R. peregrina* and *R. lucida* are also used in some parts of the Levant. *R. peregrina* is found in the south-west of England, and is called WILD MADDER. It is very similar to *R. tinctorum*. The roots of *R. rebus* and *R. chilensis* are used in Chili and Peru.

There is no material of greater importance to dyers than M. (*R. tinctorum*), not only from the great beauty of the colours obtainable from it, but also from the ease with which it can be worked, and the great variety of its applications. Although the M. plant thrives best in warm climates, it may be, and is successfully cultivated in northern districts. The Dutch province of Zealand has long been celebrated for the large crops of M. produced there; and until about 30 years since, our dyers rarely used any other than Dutch M., which was always sent ground and packed in large casks; but with the improvements in dyeing, it was discovered that the roots grown in warmer localities possessed not only much superior qualities, but could be made to produce other and more beautiful shades of colour. Besides a genial temperature, M. requires a rich, deep soil and careful cultivation. It is usually propagated by cuttings or by shoots from the stocks of old plants; these are set about a foot apart, and in rows, three feet from each other; the planting takes place in spring; and sometimes the roots are lifted at the usual harvest-time for madder (October or November). In France and Germany, the markets are supplied with one year old (called by the Germans *rotbe*), eighteen months old, and three years old, which is the best, and called by the Germans *krapp*, or M. *par excellence*. The roots are carefully raised with forks, to prevent breaking them as much as possible; and after the soil is thoroughly shaken off, they are dried in stoves, and afterwards thrashed with a flail, to remove the loose skins and any remaining soil still adhering; they are then cut, or broken in pieces, and packed for sale, or they are sent to the mills to be ground. In Turkey and Italy, where the solar heat is great, the stove is dispensed with, the roots being dried in the sun. The more the roots are freed from the epidermis, the better the quality of the M.; hence, before it is ground in France, many manufacturers employ mechanical means, chiefly sieves worked by machinery, which rub off and separate the soft, dark-brown skin which covers the roots—this process is called *robage*. One year-old roots cannot be profitably dressed in this way, and are therefore ground with the epidermis. Much of the inferior Dutch M. is also ground without dressing, and such is called *mull* in trade. The grinding is effected in mills with vertical stones, and the meal is passed through sieves of different degrees of fineness, which gives rise to various qualities in the market. These qualities are

MADDER-LAKE—MADEIRA.

numerous, and have special marks to distinguish them, well known to merchants, but are of no general interest. The M. from Turkey and from India never comes to us ground, the roots are merely broken up into pieces an inch or two in length, and packed in bales. Very small quantities of M. occasionally reach us from Russia; it is the produce of the government of Baku, on the Caspian Sea, and is said by our dyers to be the finest in the world.

As might be expected of a substance of such vast commercial and manufacturing value, M. has undergone the most elaborate chemical researches. Its dyeing quality has been known for at least two thousand years, and its medicinal qualities are also mentioned by Pliny and Dioscorides. The former writer, referring to its value as a dyeing material, says: 'It is a plant little known except to the sordid and avaricious, and this because of the large profits obtained from it, owing to its employment in dyeing wool and leather.' He further says: 'The madder of Italy is the most esteemed, and especially that grown in the neighbourhood of Rome, where, and in the other provinces, it is produced in great abundance.' The M. of Ravenna was, according to Dioscorides, the most esteemed. Its cultivation in Italy has never been discontinued; and under the present enlightened government, it has received such an impetus that the exports of the Neapolitan provinces alone, last year, exceeded in value a quarter of a million sterling. It was about the beginning of the present century that the colouring matter of M. began to attract very especial attention. It had long before been noticed that cattle which used the green parts of the plant as fodder had a red colour communicated to their bones, which was only removed by discontinuing this kind of food for a considerable time. This shewed the colouring matter to be capable of isolation; dyers also began to suspect that the colour produced was a combination of two—one red, and the other a tawny brown. But Roubiquet, a French chemist, about 1820, demonstrated that M. contains two distinct colours, capable of being isolated and used separately; he called them Alizarine and Purpurine—the former, he asserted, gave the bright red, and the latter the purple red colours. Practically, Roubiquet's statement may be held to be correct; but the recent and more elaborate researches of Dr Schunck, of Manchester, have shewn the composition of M. to be very complicated indeed. At the meeting of the British Association in 1861, he shewed the following chemical principles, all obtained from this remarkable root: 1. Rubianine; 2. Rubianic Acid; 3. Rubianite of Potash; 4. Purpurine; 5. Chlorrubian; 6. Pthalic Acid; 7. Alizarine; 8. Rubiadine; 9. Chlorrubiadine; 10. Rubiafine; 11. Rubiacine; 12. Rubian; 13. Verantine; 14. Ferchlorrubian; 15. Rubiagine; 16. Grape-sugar; and 17. Succine.

Dyers employ M. for giving the celebrated Turkey-red to cotton goods, and for this purpose employ means for developing the alizarine; and for purples, lilacs, and pinks, which are obtained by means of the purpurine. Manchester, Glasgow, Paisley, Alexandria, and other places on the banks of the Clyde, are the chief seats of this industry; and the annual imports of M. into Britain exceed 20,000 tons, amounting in value to nearly a million sterling.

MADDER-LAKE, a painter's colour, made from madder, by boiling it in a solution of alum, then filtering the liquid, and adding sufficient carbonate of soda to cause precipitation of the alizarine or red colouring matter of the madder, which alone has been dissolved by the boiling solution of

alum. This lake is used either as an oil or water colour.

MADEIRA, an island in the North Atlantic Ocean, off the north-west coast of Africa, from the nearest point of which it is 390 miles distant, in lat. 32° 43' N., long. 17° W. It lies 280 miles north of Tenerife, in the Canaries, and 620 miles south-west of Lisbon. M., and the other islands of the group, form a province of Portugal, with an area of 345 square miles, and pop. (1858) 98,620, of whom 300 are English residents, and about the same number visitors, chiefly English. It has been compared, in appearance, to the island of Arran, in the Firth of Clyde, but is wilder and grander. Its coasts are steep and precipitous, rising from 200 to 2000 feet above sea-level, comprising few bays or landing-places, and deeply cut at intervals by narrow gorges, which give to the circumference the appearance of having been *crimped*. From the shore, the land rises gradually to its highest point, the Pico Ruiivo, 6050 feet; there are several other peaks upwards of 4000 feet high. It is remarkable for its deep valleys, the most noted being that of 'Curral,' which from brink to bottom has a depth of 2060 feet. M. is of volcanic origin, and alight earthquakes sometimes, though rarely, occur. The lower portions of the island abound in tropical plants, as the date-palm, plantain, sweet potato, Indian corn, coffee, sugar-cane, pomegranate, and fig. The fruits and grains of Europe are cultivated to an elevation of 2600 feet above the sea-level, and extensive tracts on the lower grounds are devoted to the cultivation of the vine and sugar-cane; above these are found timber (including the chestnut, whose fruit is used extensively by the inhabitants as food), fern, grass, and heath, and the scant herbage of alpine regions. M. produces 80 or 90 plants peculiar to itself, but the flora in its general characteristics resembles that of the countries around the Mediterranean Sea. The grape disease has, within recent years, been almost universal, and wine has not been made in such quantity as formerly. M. has no indigenous mammalia, but the ordinary domestic animals, together with rabbits, rats, and mice, have been introduced by the Portuguese. The climate is remarkable for its constancy. There are only 10° difference between the temperatures of summer and winter, the thermometer in Funchal (the capital of the island) shewing an average of 74° in summer, and of 64° in winter. At the coldest season, the temperature rarely is less than 60°, while in summer it seldom rises above 78°; but sometimes a waft of the *leste*, or east wind, raises it to 90°. The temperate and constant warmth of its climate has made it a favourite resort for invalids affected by pulmonary disease. Besides the English church, there are other places of worship, including a Presbyterian church in connection with the Free Church of Scotland. The educational institutions comprise the Portuguese College and Lancasterian and government schools. Funchal (q. v.), with a population of 25,000, is the port of the island. In 1859, 408 vessels, of 124,108 tons, entered and cleared the port. The imports in 1859, consisting chiefly of cotton, woollen, and linen manufactured goods, iron, flour, earthenware, Indian corn, rice, sugar, and timber, amounted to £187,203; the exports for the same year, consisting of wine, sugar, oranges, lemons, and wicker-work, coal, salt-beef, and hides, amounted to £94,496. The quantity of wine exported in 1859 was 124,180 gallons, value £67,948, more than two-thirds of the whole value of the exports. The trade is chiefly with Great Britain.

The inhabitants of M. are of mixed Portuguese, Moorish, and Negro descent; they are of vigorous

frame, lively and industrious, but totally uneducated. M. was formerly covered with forests, whence its name—the Spanish word *madera* signifying timber. The group to which this island belongs, sometimes called the Northern Canaries, was discovered in 1416, and was shortly afterwards colonised by the Portuguese. Compare White's *Madeira, its Climate and Scenery*.

MADEIRA, or **MADERA**, or **CAYARA**, an important river of Brazil, South America, and an affluent of the Amazon, has its origin in the confluence of several rivers, the chief of which are the Beni, Mamore, Madalena, and Stanez, in lat. about 10° S. It has a north-east course of 700 miles, for the last 500 miles of which it is navigable, the remaining 200 being obstructed by numerous cataracts; and it falls into the Amazon in lat. 3° 25' S., long. 59° 45' W. Including the Mamore, the entire length is about 1500 miles.

MĀDHAVA is an appellation of the Hindu god Viṣṇu (q. v.), one by which he is very frequently designated in Hindu mythology and in Sanscrit poetry.

MĀDHAVĀCHĀRYA (i. e., *Mādhava*, the Achārya, or spiritual teacher) is one of the greatest Hindu scholars and divines that graced the mediæval literature of India. He is famed for his numerous and important works relating to the Vedic, philosophical, legal, and grammatical writings of the ancient Hindus, and also for his political connection with the history of some renowned kings of the Deccan. His learning and wisdom were so eminent, that he was supposed to have received them from the goddess Bhuvanēswarī, the consort of Śiva, who, gratified by his incessant devotions, became manifest to him in a human shape, conferred on him the gift of extraordinary knowledge, and changed his name to Vidyāraṇ'ya (the Forest of Learning), a title by which he is sometimes designated in Hindu writings. All the traditions about M., however differing from one another, agree in ascribing the origin of Vijayanagara to Mādhava. His birthplace is said to have been Pampa, a village situated on the bank of the river Tungabhadra; and as all the accounts of his life admit his having been the prime-minister of Sangama, the son of Kampa, whose reign at Vijayanagara commenced about 1336, and to have filled the same post under King Bukka I, who succeeded Harihara I. about 1361, and as he died at the age of ninety, the date of his birth coincides probably with the beginning of the 14th century. Amongst his works, the principal are his great commentaries on the Rīg-, Yajur-, and Sāma-veda (see VEDA); an exposition of the Mīmāṃsā philosophy; a summary account of fifteen religious and philosophical systems of Indian speculation; some treatises on the Vedānta philosophy; another on salvation; a history of Śankara's (q. v.) polemics against multifarious misbelievers and heretics; a commentary on Parāśara's code of law; a work on determining time, especially in reference to the observation of religious acts; and a grammatical commentary on Sanscrit radicals and their derivatives. The chief performance of Mādhava is doubtless the series of his great commentaries on the Vedas, for without them no conscientious scholar could attempt to penetrate the sense of those ancient Hindu works. In these commentaries, Mādhava labours to account for the grammatical properties of Vedic words and forms, records their traditional sense, and explains the drift of the Vedic hymns, legends, and rites. That in an undertaking almost unparalleled, in the literary history of any nation, for its magnitude and difficulty, Mādhava

should have committed sundry inaccuracies—the remedy against which, however, is really always afforded by himself—can surprise no one; but when modern Sanscrit philology affords the spectacle of writers haughtily exaggerating these shortcomings, and combining with their would-be criticisms the pretence of establishing the true sense of the Vedas without the assistance of Mādhava, a mere comparison of the commentary of the latter with what the European public is called upon to accept as its substitute, adds a new testimony to the vast superiority of the Hindu scholar over his European antagonists. See VEDA. Some of Mādhava's works seem to have been lost.

MADHU'CA. See BASSIA.

MĀDIA (*Madia*), a genus of plants of the natural order *Compositæ*, sub-order *Corymbifera*, having seeds without pappus, the outer ones situated between the leaves of the involucre, the flowers yellow, the exterior ones rather shortly ligulate, those of the disk tubular. The plants of this genus are annual, of upright habit, rough with glandular hairs, and very viscid; they are important on account of the utility of the seeds as a source of vegetable oil. *M. sativa*, a native of Chili, is there called *Madi* or *Melosa*, and is generally cultivated as an oil-plant. It is 3–5 feet high, has ovato-lanceolate, entire leaves; the flowers terminal, and crowded upon the leafy branches. It has been known in Europe since the beginning of the 19th c., but first began to be cultivated in fields as an oil-plant in 1839. The results of experiments in its cultivation have not, however, in most cases been so favourable as was expected; yet it deserves attention, as it is only annual, does not suffer from frost, does not demand a very good soil, and produces an excellent oil. *Madia* oil is richer than poppy oil, almost entirely inodorous, of a bland, agreeable taste, and very suitable for oiling machines, as it does not freeze even at a cold of 10° F. The oil-cake is a good food for cattle. The straw and chaff have poisonous properties. It is, however, a great disadvantage that the flowers ripen gradually in succession, so that the first are already fallen off, when the last are not yet ripe. The cultivation of *Madia sativa* has not yet been attempted on a considerable scale in Britain.—Another species, *M. elegans*, is cultivated in flower-gardens.

MADISON, JAMES, American statesman, and fourth President of the United States, was born at King George, Virginia, March 16, 1751. His father, James Madison of Orange, was of English ancestry. He graduated at Princeton, N. J., in 1771, and studied law. In 1776, he was a member of the Virginia Convention, and though too modest for an orator, his life from this time was devoted to politics, and he became one of the most eminent, accomplished, and respected of American statesmen. He was elected to the Federal congress in 1779; in 1784 to the legislature of Virginia, in which he supported the measures of Mr Jefferson in the revision of the laws, and placing all religious denominations on an equality of freedom without state support. As a member of the Convention of 1787, which framed the Federal constitution, Mr Madison acted with Jay and Hamilton, and with them wrote the *Federalist*. He did as much as any man, perhaps, to secure the adoption of the constitution, but opposed the financial policy of Hamilton, and became a leader of the Republican or Jeffersonian party. He declined the mission to France, and the office of Secretary of State, but in 1792 became the leader of the Republican party in congress, and wrote the Kentucky Resolutions of 1798, which contain the basis of the state-rights

doctrines. Virginia, in the adoption of the constitution, declared her right to withdraw from the confederation, and at this early period established two state arsenals and made other preparations to resist the encroachments of a centralising power. In 1801, Mr Jefferson having been elected President, Mr Madison was made Secretary of State, which post he held during the eight years of his administration. In 1809, he was elected President. The European wars of that period, with their blockades and orders in council, were destructive of American commerce. The claim of the English government to impress seamen from American vessels was violently resisted. Mr Madison vainly endeavoured to avoid a war with England, which was declared in 1812, and continued for two years, at a cost of 30,000 lives and 100,000,000 dollars. He was one of the four presidents elected for a second term, during which he approved the establishment of a national bank as a financial necessity—a measure he had opposed and vetoed. In 1817, he retired to his seat at Montpelier, Virginia, where he continued to serve his country as a rector of the university of Virginia, and a promoter of agriculture and public improvements. Without being a brilliant man, he was a statesman of eminent ability and purity of character. He died at Montpelier, January 28, 1836.

MADISON, a city of Indiana, United States of America, on the Ohio River, founded in 1803, lies 100 miles west-south-west of Cincinnati. It is finely situated on an elevated plateau, with a background of hills; has a court-house, 2 markets, 3 banks, 18 churches, cotton, woollen, and iron factories, several flouring-mills, large pork-packing establishments, and a flourishing trade. Pop. (1860) 8133.

MADISON, the capital of Wisconsin, United States of America, founded in 1836, is beautifully situated on an isthmus between two lakes, 80 miles west of Lake Michigan, and the same distance east of the Mississippi River. It contains the state capitol, university (founded in 1851), lunatic asylum, historical society, five banks, two daily, and seven weekly papers, two of the latter being in the Norwegian language. It is the centre of a fertile and salubrious country, and has a large trade. Pop. in 1850, 1525; in 1860, 6811.

MADOC, son of Owen Gwynnedd, a Welsh prince, is believed by his countrymen to have discovered America about 300 years before Columbus. Compelled, it is said, by civil strife to abandon his native land, he sailed westward in 1170 with a small fleet, and after a voyage of several weeks, reached a country whose productions and inhabitants were quite unlike those of Europe. Here he lived for a long time; then returning to Wales, he gave an account of the new land that he had discovered, equipped another fleet, set sail again, and was never more heard of. The story of M. will be found in the *Historie of Cambria, now called Wales, a part of the famous Yland of Brytaine, written in the Brytish Language above 200 years past by Caradoc; translated into English by H. Lloyd, gent.; corrected, augmented, and continued by David Powel* (London, 1584). See also Owen's *British Remains* (1777). There is considerable reason for suspecting the genuineness of this Welsh tradition; and even if true, the Northmen have a prior claim to the discovery of America, for it is beyond doubt that Greenland and the New England States were visited, if not colonised, by Icelanders or Norwegians at a much earlier period. Southey has chosen the story of M. as the subject of one of his so-called 'epics.'

MADONNA, an Italian word signifying *My Lady*, and specially applied to the Virgin Mary. It has

now become common in other languages, particularly in reference to works of art. The earliest Christian art, however, did not attempt any representation of the mother of Christ; such representations first make their appearance after the 5th c., when the Virgin was declared to be the 'Mother of God.' The face of the mother is generally full, oval, and of a mild expression; a veil adorns the hair. At first, the lineaments of the Virgin's countenance were copied from the older pictures of Christ, according to the tradition which declared that the Saviour resembled his mother. A chronological arrangement of the pictures of the Virgin would exhibit in a remarkable manner the development of the Roman Catholic doctrine on this subject. The Madonna has been a principal subject of the pencils of the great masters. The grandest success has been achieved by Raphael, in whose pictures of the Madonna there prevails now the loving mother, now the ideal of feminine beauty, until in that of St Sixtus he reaches the most glorious representation of the 'Queen of Heaven.' Among symbolical representations may be mentioned Mary with the white mantle, i. e., the mantle of love under which she receives the faithful; and the Virgin with the half-moon or with the globe under her feet, according to the meaning put upon the twelfth chapter of Revelation. The Virgin was never represented without the Child until comparatively recent times.—For further information, the reader should consult Mrs Jameson's delightful work, *Legends of the Madonna* (Lond. 1852).

MADOQUA (*Antelope Saltiana*, or *Neotragus Saltianus*), a species of antelope, abundant in Abyssinia; one of the smallest, if not the very smallest of horned animals, being scarcely the size of a hare. Its legs are long and slender; its tail very short; its horns short and conical, the males alone having horns; the general colour is gray, the fore-parts reddish.

MADRAS, one of the three presidencies of the Indian empire, occupies the greater part of the south of the peninsula of Hindustan. It may be considered as consisting of the following five divisions: 1. The north division, comprising the provinces of Ganjam, Vishákkpattan, Rájámahendri, and Machlipattan; 2. The central division, including Gunthúr, Nellúr, Chengalpatt, North Arkat, and South Arkat; 3. The south division, including Salem, Koimbatúr, Trichinapalli, Tanjúr, Madura, Tinneveli, and the territory of the Rájáh of Travancúr; 4. The Maisúr (Mysore) division, including Maisúr, Malabar, and Kanara; 5. The ceded districts, Kadapa, Bellári, and Karnúl. Besides these, Nágpúr and the Nizám's territory are under the government of Madras. Area, including the Nizám's territory and Nágpúr, 355,846 square miles. Pop. 43,538,265. The physical features, industry, &c., are given under the several districts.

MADRAS (called by the natives *Chennapattanam*, 'the city of Chennappa,' an Indian prince), a maritime city of British India, capital of the presidency of the same name, is situated on the Coromandel coast, the western shore of the Bay of Bengal, in lat. 13° 5' N. No commercial centre of equal size and importance is so unfortunate in its site. The roadstead is open to every wind, except that from the west, and in the case of a sudden gale, vessels are obliged to run for the open sea. The city is not built on a navigable river; the soil of the vicinity is but moderately productive; and during the hot months, the thermometer, even in a well-appointed room, rises to 96°. In calm weather, the surf breaks 300 feet from the shore, and its wave is 3 feet in height; during

a storm, it breaks 1000 feet from shore, with a wave 14 feet high, and at such a time any attempt to land, even in the boats of the natives built for this purpose, is most dangerous. The seasons are distinctively marked by the monsoons, the north-east lasting from October to February, and the south-west from May to October. The force of the latter, however, is so much broken by the Ghats that its influence is hardly felt. During the hot months, the climate of M. is pleasantly modified by a sea-breeze, called by the residents 'the doctor,' which sets in at noon, and lasts till night. The city, with its suburbs, which are nine in number, extends along the coast for 9 miles, and has an average breadth of $3\frac{1}{4}$ miles. On the coast, and midway between the north and south extremities of the city, is Fort St George, strongly fortified, and garrisoned usually by a regiment of European troops and two companies of artillery; there are also, however, three regiments of native infantry generally stationed here. Within the fort are comprised the council-house and a number of civil and military offices. The district of Black Town, north from the fort, lies low, in some places being only 6 inches above sea-level at spring-tides. It is defended, like the fort, from the encroachments of the sea by a strong stone bulwark. In Black Town are the Seven Wells, the water of which, filtered through a bed of fine sand, is exceedingly pure and wholesome. The principal buildings and institutions are Government House, a handsome edifice, though much inferior to the similar establishments in Calcutta, and even in Bombay; the Light-house, to the north of the fort, 128 feet above sea-level, and having a light, said to be one of the most brilliant in the world; the Scotch Church of St Andrew, founded in 1818, a stately and beautiful edifice; the University, with three European professors, and numerous teachers, both European and native, and containing a valuable museum and a library; St George's Cathedral, from which a magnificent view of the city and its vicinity may be obtained, and containing several monuments by Chantrey (including one of Bishop Heber), and some figures by Flaxman. There are also military male and female orphan asylums, a medical school, a branch of the Royal Asiatic Society, the Madras Polytechnic Institution, the Government Observatory, a mint, eight established Episcopal churches, numerous dissenting places of worship, and the Madras Club, to which members of the Bengal and Bombay clubs are admitted as honorary members. Madras stucco, or *chunam*, is largely employed in the decoration of public buildings. When laid upon walls, pillars, &c., dried and polished, it has the appearance of the finest Parian marble.

The first British settlement on this coast was at Armagon, 60 miles north of M.; but the seat of the present fort being granted by a native prince in 1639, a removal took place, and the nucleus of the present city was at once formed. M. is now the residence of the government of the presidency, including the governor, the members of council, &c., and of the judges of the Supreme Court. The table of the European is supplied from the well-stocked markets with beef, mutton, veal, kid, fowls, turkeys, geese, fish, &c., and with the familiar potato, turnip, carrot, cabbage, &c., combined with the mangoes, plantains, pine-apples, guavas, &c., of the country. Pop. 720,000, 1600 of whom are European, and the great body of the remainder Hindus. Nine newspapers are published here. In 1857, 6241 vessels, of 652,146 tons, besides 1438 square-rigged vessels, and 4803 native craft, entered the port. Imports, valued at 40,563,828 rupees (£3,760,605 nearly); exports at 40,060,656 rupees (£3,713,967 nearly).

MADRAS SYSTEM. See **MUTUAL INSTRUCTION.**

MAD'REPORE (*Madrepora*), a genus of zoophytes (*Anthozoa*), the type of a family, *Madreporida*, in which the polypes have twelve short tentacles, and the polypidom is stony. The name, however, is often more extended in signification, and popularly



Madrepore (*Astraea ananas*).

is not clearly distinguished from CORAL. The polypidom is sometimes arborescent and branched, sometimes spread out in a leaf-like form. The cells in the true madrepores are isolated and lamellated, spread over the surface of the polypidom like little stars. The variety of forms among the madrepores is very great, and many of them are very beautiful. They are all found in the seas of warm parts of the world. The *Astraeas* are generally in large convex masses, the surface hollowed with crowded stars. They increase with great rapidity, as do some of the other madrepores, and are often found in huge masses, composing some of the most recently formed rocks.

MADRID, the capital city of Spain, in the province of the same name in New Castile (see CASTILE), is situated near the centre of the country, on the left bank of the Manzanares, a small stream whose waters join those of the Jamara, an affluent of the Tagus. It is built on a hilly, barren, and ill-watered plateau, 2060 feet above sea-level, offering, on the one hand, no protection against the bitter north winds from the snowy peaks of the Guadarrama Mountains, and on the other, open to the *Solano*, the south-eastern wind, which, aided by a glaring sun, often raises the temperature to 90° and even to 105° in the shade. In winter, the temperature sometimes falls to 18°. Summer, however, is the most trying period. During this season, the sunny and shady sides of the same street may differ 20° in temperature. Not without justice has the climate of M. been proverbially described as *tres meses de invierno y nueve del infierno* (three months of winter and nine months of hell). The rate of mortality is 1 in 30 to 34. The city is circular in shape, and is surrounded by low walls pierced by 16 gates. Besides other ecclesiastical edifices, it contains 32 churches, none of which are worthy of special mention; 18 nunneries (44 monasteries were suppressed in 1836), 17 hospitals, 14 barracks, 94 elementary schools (besides several academies), 1 university, 8 theatres, 25 daily newspapers, and numerous literary and artistic institutions. The number of palaces is great. The principal architectural feature is the Royal Palace (*Palacio Real*), a splendid edifice, built of granite, and of a stone resembling white marble. It is a square 470 feet in length on each side, and 100 feet in height, and encloses a court 240 feet square. There are two libraries, the public and the private royal libraries: the former, containing 200,000 vols., is well kept and tended; the latter, with 100,000 vols., is rapidly falling to decay. The royal armoury is one of the finest in the world; the Toledo blades, the artistic armour, and shields from Augsburg and Milan, are superb. The armoury contains relics of the greatest Spanish epochs, and furnishes in itself a realisation of Spanish history. The *Museo*, said to be one of the finest picture-galleries in the

world, besides specimens of many other famous painters, contains 10 of Claude, 22 of Van Dyck, 16 of Guido, 46 of Murillo, 21 of N. Poussin, 10 of Raphael, 62 of Rubens, 52 of Teniers, 43 of Titian, 27 of Tintoretto, 62 of Velasquez, 24 of Paul Veronese, and 10 of Wouvermans. Of all these pictures, the most wonderful are those by Velasquez, whose finest work is here, and who, indeed, can here only be studied to advantage. The general aspect of M. is that of a new city, with fine houses, streets, and squares. In the squares are numerous statues—as that of Philip IV. (in the *Plaza de Oriente*), a splendid equestrian work, 19 feet in height, and weighing 180 cwt.; the statue of Cervantes, &c. In and around the city, also, are numerous public walks. The manufactures of the city are unimportant. The artisans and tradesmen are supported by the court, the nobility, the officials, and the innumerable body of place-hunters. Pop. 475,785.

The first historical mention of M. occurs under Ramiro II., king of Leon, who took this city in 932. In 1083, when M., or, as it was then called, Majerit, was captured by Alfonso VI. of Castile, it was merely a Moorish fortified outpost of Toledo. It rose into some importance in the beginning of the 16th c., when Charles I. (afterwards the Emperor Charles V.) removed his court hither. In 1560, it was declared the only court by Philip II. A number of memorable treaties have been concluded in M., and bear its name, particularly that between Charles V. and Francis I. of France in 1526; that between Spain and Venice in 1617; and that between Portugal and Spain in 1800. In the Spanish War of Succession, it favoured the French party; and in the war of freedom against France, it gave the signal for a general rising by an insurrection against Murat on 2d May 1808, in which 1500 of the citizens of M. lost their lives. From 1809 till 1812, it was held by the French; but in the latter year, the Duke of Wellington entered it, and replaced it in the hands of its legitimate rulers. In the more recent contests between the Carlists and Christinos, the Spanish capital has favoured the cause of the latter.

MADRIGAL, a word of uncertain etymology, denotes a short lyrical poem, adapted to the quaint and terse expression of some pleasant thought, generally on the subject of love. The proper madrigal consists of three verses or strophes, generally bound together by rhymes; but this form is not always adhered to, and the name is sometimes applied to little love-poems of any form. Among the Italians, the best writers of madrigals are Petrarch and Tasso; among the French, Montreuil, Lainez, and Moncrif; among the Germans, Ziegler (the earliest), Voss, Manso, Goethe, and A. W. Schlegel; and among the English, the poets of the Elizabethan and Caroline ages, several of whom, such as Lodge, Withers, Carew, and Suckling, have written verses, sometimes called madrigals, sometimes songs, the grace and elegance of which have never been matched.—The name madrigal is also applied to pieces of vocal music of a corresponding character. The musical madrigal, which originally was a simple song sung in a rich artistic style, but afterwards with an instrumental accompaniment (generally the organ), is believed to have originated with the Flemings, and dates from the middle of the 16th century. It went out of fashion about the beginning of the 18th c., but the later *glee* may be regarded as a similar composition. The English madrigalists are especially famous. Neither Italy nor the Netherlands has produced greater names than Morley, Wilbye, Bennett, Ward, Orlando Gibbons, Dowland, and Ford.

MADURA, an island, separated by a narrow strait from the north-east of Java, about 90 miles long and 24 broad. In 1850, the population amounted to 325,000, of whom 6500 were Chinese, 10,000 Malays, and many other foreigners. From a later census (1858), it appears that the population has increased to 509,829 souls. The natives of M. are active, honest, brave, and industrious. They are mostly Mohammedan, though the remains of Hindu temples still bear testimony to the prevalence of that faith in former times. The rivers are small, and the hills never attain to a great height, Padjoedan, the highest, being 1364 feet above the level of the sea.

M. is a colonial possession of the Netherlands, belongs to the residency of Soerabaya, and is divided into three kingdoms, governed by native princes, under the superintendence of two Dutch assistant-residents. The products of the island, which are included in the trade-returns of Java (q. v.), are sugar, tobacco, indigo, cocoa-nut oil, edible birds' nests, &c.; but owing to the extortions of the princes, agriculture is not flourishing. In 1858, the oil exported had a value of £21,500 sterling, from 40,000 fruit-bearing trees. The stock amounted to 2291 buffaloes, 34,354 head of horned cattle, and 17,276 horses.

MADURA, a maritime district in the south of British India, in the presidency of Madras, is bounded on the E. by the strait which separates Hindustan from the island of Ceylon. It has an area of about 10,700 square miles, and a population of 1,750,000. Eastward from the shore, runs a narrow ridge of sand and rocks, mostly dry, and which almost connects Ceylon with the continent. Cotton is the chief commercial crop; and sugarcane, betel-nut, and tobacco are also grown. The principal town is Madura, on the river Vygat, with several noteworthy public buildings.

MÆANDER (now *Meinder*), the ancient name of a river of Asia Minor, rising near Celsæna, in Phrygia, and flowing in a south-western direction into the Icarian Sea at Miletus. It is noted for its numerous windings—whence the English word *meander*, applied to any stream, signifies to flow in a winding course.

MÆCENAS, C. CILNIUS, a Roman statesman, celebrated for his patronage of letters, was born in the early part of the first century before Christ. His family was of Etruscan origin, and of royal descent (Hor. *Carm.* i. 1), perhaps from Porsena. He received an excellent education, was familiar with Greek and Roman literature, and occasionally did a little in the way of authorship himself. His first appearance in public life dates after the assassination of Julius Cæsar (44 B. C.), when he figures as the friend and adviser of Octavian. He had, it is clear, a talent for private diplomacy, and was employed mainly in that capacity. He 'arranged' a marriage between Octavian and Scribonia, made up (temporarily) the differences between Octavian and Antony, and brought about the peace of Brundisium. In 36 B. C., he was in Sicily, helping Octavian, as usual. Five years later, when the latter was fighting the great and decisive sea-battle of Actium with his rival Antony and the Egyptian princess Cleopatra, M. proved himself a vigilant governor of Rome, by crushing a conspiracy of the younger Lepidus, and thereby preventing a second civil war. When Octavian became emperor under the title of Augustus (a step which he is said to have taken by the advice of M., who was profoundly impressed with the necessity of a 'strong government' to repress the anarchic elements of the period), the latter was appointed administrator of all Italy.

The nature and extent of his official power are not very precisely understood, but they were undoubtedly great, though the influence and authority of M. are to be estimated rather from his intimacy with the emperor than his mere position as a public servant. This intimacy—friendship it might, perhaps, be called—continued uninterrupted for many years; but sometime before 16 A.C., it was ruptured from causes which cannot now be ascertained. No enmity, however, ensued. M. was a thoroughly sincere imperialist. He had a belief in the value of an established government; and when he found that he no longer retained the confidence of his sovereign, he did not lapse into a conspirator; but, as a modern minister might do, retired into the obscurity of private life. Literature and the society of literary men now occupied all his time. He was immensely rich, and kept an open table for men of parts at his fine house on the Esquiline Hill. M.'s intercourse with Horace especially was of the most cordial nature, and equally honourable to both. So far as personal morality went, M. was a thorough pagan—not a bad man in the usual sense of the word, but copiously addicted to sensual delights. His adulteries—if not worse—were the talk of the city; he dressed effeminately, had a passion for theatrical entertainments, paid great attention to cookery, gardening, &c.; and in short, in his theory of life, was an Epicurean of 'the baser sort.' It does not, therefore, surprise us to find that he was a valetudinarian and a hypochondriac, and that he died childless, 8 A.C. He left the bulk of his property to Augustus.

MAELAR, LAKE, one of the largest and most beautiful lakes in Sweden, about 81 miles in length; its average breadth about 13, and its area about 525 square miles. It contains upwards of 1200 islands. Its east end is close by Stockholm, where its waters are poured into the Baltic Sea, the difference of level being scarcely six feet. The banks are very much varied with wood, lawn, and cliffs, and are adorned with many castles, country-seats, and villas. They are generally very fertile and well cultivated, and upon them are situated, besides Stockholm, the towns of Enköping, Westera, Köping, Arboga, Strenghis, Thorshälla, Mariefried, and Sigtuna.

MAESTO'SA, a term in music, meaning with majesty or dignity. It is frequently followed by *con gravità*.

MAESTRICHT BEDS. In Britain, the chalk with flints is covered with Tertiary strata, but at Maastricht in Holland there occurs a thickness of 100 feet of soft yellowish limestone, abounding in the remains of Corals and Bryozoa, sometimes, indeed, entirely made up of them. The fossils are peculiar, and quite distinct from Tertiary species. Yet a considerable interval must have elapsed between the deposition of the Maestricht beds and the underlying chalk, for that has been abraded before the deposition of the newer beds. The most remarkable fossil found in these strata is the gigantic marine reptile *Mosasaurus* (q. v.).

MAFFEI, FRANCESCO SCIPIONE, MARCHESE, an eminent Italian author, was born at Verona, 1st June 1675, and studied in the Jesuit College at Parma. He spent part of his youth in military service, under his brother ALESSANDRO, who greatly distinguished himself in the Spanish War of Succession, and who finally rose to the rank of a field-marshal; but his love of literature prevailed over the desire of military renown, and he devoted himself to literary pursuits. He was for some time one of the editors of a critical journal, intended to promote among the Italians an acquaintance

with foreign literature. His tragedy of *Merope* (Modena, 1713) was received with great approbation, and went through 70 editions in M.'s lifetime. His comedy of *La Ceremonia* soon followed, and was also successful. M. was a zealous promoter of the study of the Greek language and literature in Italy, and bestowed much labour on the examination of ancient manuscripts. His *Verona Illustrata* (Ver. 1731—1732; new ed., 8 vols., Ver. 1792—1793) is a work of much value and learning. He died 11th February 1755. A collective edition of his works was published at Venice in 1790, in 21 vols.

MA'FRA, a small town of Portugal, in the province of Estremadura, 18 miles north-west of Lisbon. Pop. 3250. It is remarkable only for its palace and convent, which form an enormously large and most striking edifice. It is 780 feet in length, and 690 feet in width, contains in all 866 rooms, with 5200 windows, and about as many doors: 10,000 men, it has been said, could be reviewed on its roof. It was built by King John V. (1717—1731), and is splendidly fitted up and decorated. The library contains 30,000 vols., and is 300 feet in length; its pavement consists of white and red marble; and the bookcases are made of the most costly woods.

MAGADO'XO, or **MUKDISHA**, a commercial town on the eastern coast of Africa, on the Somali coast, in lat. 2° 2' N. It was built by the Arabs in 924, for the purposes of trade, and was a flourishing place when the Portuguese first visited it. It now belongs to the Imaum of Muscat, whose flag floats above the town. Pop., inclusive of slaves, about 5000. It exports dhurra, beans, pease, cattle, cotton, spices, &c.

MA'GAZINE (a word derived from the Arabic *Makhzan*), literally means any place where stores are kept; but as a military expression, magazine always means a *powder-magazine*, although arms may at times be kept in it. A magazine may be a dépôt where vast quantities of gunpowder are held in reserve, an entrepôt for the supply of several advanced works, a battery magazine for the wants of a fortress during a siege, or merely an expense magazine for the daily requirements of the special battery in which it may be situated. The last is usually temporary, and hollowed out in the back of the rampart; but the other forms require most careful structure. They must be bomb-proof, and therefore necessitate very thick walls; they must be quite free from damp; and they should admit sufficient daylight to render the use of lanterns within generally unnecessary. Magazines are commonly built of brick, the solid masonry being arched over within, and a thickness of earth sometimes added above the brickwork, to insure impermeability to shells. The entrance is protected by shot-proof traverses, lest an opening should be forced by ricochet shots. Within, a magazine is divided into bins or compartments, and one of these should always be kept empty, in order that the barrels of powder may frequently be moved from one place to another, a process necessary to keep it in good condition. A battery magazine commonly contains 500 rounds for the guns dependent on it. Dépôt magazines should, when possible, be limited to 1000 barrels of powder.

In a ship, the magazine is strongly built in the hold; it is divided by a transparent screen from the *light-room*, in which are kept properly provided lanterns, the introduction of fire in any form into the magazine itself being absolutely forbidden. The explosion of the magazine is, of course, equivalent to the destruction of the ship, and therefore means are devised by which, on the least appearance of

MAGDALEN COLLEGE—MAGDEBURG.

fire in its vicinity, the magazine may be immediately flooded.

The term magazine has been applied to a well-known class of periodical publications, usually issued monthly, and containing miscellaneous pieces in prose and verse, to which at one time was appended a chronicle of public events. The oldest of this class of works is the *Gentleman's Magazine*, begun by Edward Cave in 1731.

MA'GDALEN COLLEGE, Oxford; in full, The College of St Mary Magdalene. William Patten, commonly called Waynflete, from the place of his birth, successively head master of Winchester, master of the Lesser House of St Mary Magdalene, near Winchester, Bishop of Winchester, and Lord High Chancellor, founded the Hall of St Mary Magdalene in 1448. In 1457, he obtained a licence from the king to found a college into which he transferred the president and scholars of the Hall. Magdalene is in many respects the most remarkable college in Oxford, and Wood declares it to be 'the most noble and rich structure in the learned world, that is to say, that if you have regard to its endowment, it excelleth, all things considered, any society in Europe.' There were on the original foundation a president, 40 fellows, 30 scholars called demies, 12 chaplains, and 16 choristers. The fellowships and demyships were confined to certain specified dioceses and counties. By ordinances passed under the powers of 17 and 18 Vict. c. 81, the constitution of the college has been considerably changed. All restrictions on fellowships and demyships are to be abolished. The demyships are to be of the value of £75 per annum, and 10 are to be added to the statutable number. Twenty exhibitions of the same value were at the same time founded. Four professorships—of Moral Philosophy, Chemistry, Mineralogy, and Physical Geography—of the value of £600 per annum, are to take the place of three lectureships—of Divinity, Moral Philosophy, and Natural Philosophy, which were founded by Waynflete. In order to carry out these changes, ten of the fellowships are suspended. By the same ordinance, it is directed that the fellowships are not to exceed £300 per annum, exclusive of rooms. This college is one of great beauty, and, as is well known, is rich in historical associations. It has 39 benefices in its gift.

MAGDALEN HALL, Oxford. This Hall was founded at the same time as Magdalen College. Up to 1602, it was a sort of school for students previous to admission to the college, and was governed by one of the college fellows. It then became an independent Hall, and in 1822 was removed to the seat of the former Hertford College. This Hall presents to one benefice, and possesses 8 scholarships and 4 exhibitions. They are all tenable for three years.

MAGDALEN ISLANDS, a small group near the centre of the Gulf of St Lawrence, 54 miles north-west of Cape Breton Island, and about the same distance north from Prince Edward's Island. They consist chiefly of Coffin, Amherst, and Grindstone Islands, and about 2000 inhabitants, who are supported by the productive cod, herring, and seal fisheries of the neighbouring waters.

MAGDALENA, the principal river of the Granadian Confederation, South America, has its origin in a mountain lake at the south extremity of the Eastern Cordilleras. After a northern course of 900 miles, it falls into the Caribbean Sea, in lat. 11° N., long. 75° W. Of its course, the upper portion is rapid, and interrupted by many cataracts; the lower portion is through a great plain. It is navigable to Honda, 540 miles from its mouth;

chief affluent the Cauca. The area drained by the M. is estimated at 110,000 square miles.

MA'GDALENE, MARY, or MARY OF MAGDALA, so named from a town on the Sea of Galilee, a woman 'out of whom Jesus cast seven devils,' and who believed in him and followed him. She was one of the women who stood by his cross, and one of those who went with sweet spices to the sepulchre. To her he first appeared after his resurrection. In consequence of an unfounded notion identifying her with the woman mentioned in Luke vii. 36—50, who anointed our Lord's feet with ointment, and wiped them with the hairs of her head, Mary M. has been long and generally regarded as a woman whose early life had been very profligate, although of this there is no hint whatever in the narratives of the evangelists; and the Magdalenes, so frequent amongst works of art, represent her according to this prevalent opinion.—The very name Magdalene has come to be applied to women who have fallen from chastity, and institutions for the reception of repentant prostitutes are known as *Magdalene Asylums*.

MAGDALENE COLLEGE, Cambridge, was founded in 1519 by Thomas, Baron Audley of Walden, who left for this purpose the inappropriate parsonage of St Catherine Cree Church, London, and also a considerable part of the city, anciently called Covent Garden, Christ Church. It has eight open fellowships on the foundation. The other fellowships are named after the persons who have made benefactions to the college—Spendluffe, Wray, Drury, and Millington. M. C. has 12 scholarships—3 of £60, 3 of £40, and 6 of £20 each—all of which are likewise named after their founders; besides 13 exhibitions, 6 of which are for scholars from Shrewsbury School, 3 for scholars from Wisbeach School, and 4 for scholars from Leeds, Halifax, and Heversham Schools. There is also an annual benefaction, called the Pepsysian, worth £50, in the gift of the master, and generally bestowed by him upon poor and deserving students. M. C., in 1862, counted 27 undergraduates, 130 members of the University senate, and has the patronage of 7 benefices.

MA'GDEBURG, chief town of Prussian Saxony, is situated in 52° 8' N. lat., and 11° 40' E. long., and has a population of 86,301 (including its suburbs and its citadel), is one of the most strongly fortified and most important commercial towns of Prussia, and the focus of four of the principal lines of railway in Germany. It lies on the left bank of the Elbe, and is surrounded by extensive suburbs, known as Neustadt and Sudenburg, but with the exception of one long and wide thoroughfare, the *Breite Weg* (Broadway), it consists mostly of narrow and crooked streets. M. is the seat of the governmental courts of appeal and administration, and of a superintendent-general of the Evangelical Church. It has two gymnasia, a normal school, institutions for the deaf and dumb and blind; schools of arts, trades, practical mining, medicine, surgery, and midwifery; and is well provided with institutions for the promotion of charitable purposes. Its most remarkable buildings are the cathedral, built between 1208 and 1363, and containing the graves of the Emperor Otho, the founder of the city, and of his first wife, the English princess Editha, and the sarcophagus of Archbishop Ernest, sculptured in 1497 by P. Vischer of Nürnberg; the town-hall, in front of which stands the memorial of Otho the Great, erected, after his death in 973, by the magistracy of M., in grateful remembrance of the favours which he had conferred upon the city; the government house, the barracks, and the theatre. The industrial products of M. embrace

silk, cotton, and woollen goods, gloves, ribbons, and leather, and it has manufactories of tobacco, chicory, lead, sugar, and vinegar, and extensive breweries and distilleries. The transit and commission trade is very considerable; there are annual wool and other markets; and trade is facilitated by rail, and by steam and canal navigation. In 967, M. was raised to the dignity of being selected by Pope John XIII. as the see of the primate of Germany, while it had already acquired the rights of a free city under Charlemagne. During the middle ages, the archbishops and the magistracy were frequently at war; and M. early adopted the Reformed doctrines, and thus brought upon itself the combined wrath of the emperor and the archbishops. Its greatest troubles are, however, connected with the Thirty Years' War, when, after sustaining a siege for 28 weeks against the imperialists under Tilly, the city was taken, sacked, and nearly burned to the ground; the cathedral and about 150 houses being all that remained after the three days' sack to which it had been exposed. Thirty thousand of the inhabitants were slain, and numbers threw themselves into the Elbe, to escape the fury of the invaders. In 1648, the archbishopric was converted into a secular duchy, and conferred upon the House of Brandenburg, in compensation for the loss of Pomerania. In 1806, it was taken by the French, and annexed by them to the kingdom of Westphalia; but finally restored to Prussia, in consequence of the downfall of Napoleon in 1814.

MAGDEBURG CENTURIES, the name given to the first comprehensive work of Protestant divines on the history of the Christian Church. It was so called because it was divided into centuries, each of which occupied a volume, and because it began to be executed at Magdeburg (q. v.). The originator of the work was Matthias Flacius (1552), and the purpose he had in view was to demonstrate the identity of the Protestant doctrines with those held by the primitive church, and the departures of the Roman Catholic Church from the same. Joh. Wigand, Matt. Judex, Basilii Faber, Andr. Corvinus, and Thom. Holzthuter were Flacius's principal fellow-labourers; and several Protestant princes and noblemen defrayed the heavy expense incurred in the preparation of the work. The writers, who are called *Centuriators*, brought their work down only to the year 1300. It was published at Basel (13 vols., 1559—1574); Baumgarten and Semler began a new edition (6 vols., Nürnberg, 1757—1765). The *Magdeburg Centuries* displays great learning, accuracy, and sound judgment. The Roman Catholic historian Baronius (q. v.) wrote his *Annales Ecclesiastici* as a reply to it.

MAGDEBURG HEMISPHERES are two hollow hemispheres, generally made of copper or brass, with their edges accurately fitted to each other, and one of them furnished with a stop-cock. When the edges are rubbed over with grease, pressed tightly together, and the globe thus formed exhausted of air through the cock, the hemispheres, which fall asunder before exhaustion, are now pressed together with immense force; e. g., if they are one foot in diameter, they will, after exhaustion, be pressed together with a force of nearly a ton. This experiment was first performed by Otto von Guericke (q. v.) in 1650, at the imperial diet at Ratisbon, to the astonishment of the Emperor Ferdinand III. and his princes and nobles.

MAGELLAN, or (properly) **MAGALHAENS**, **FERNANDO DE**, a famous voyager, was born in Oporto, of good family, towards the latter half of the 15th century. He served with distinction under Albuquerque in the East Indies; but thinking

his services ill rewarded by the Portuguese court, he went, in 1517, to Spain with his countryman, Ruy Falero, a geographer and astronomer. They laid before Charles V. a scheme for reaching the Moluccas by the west, which was well received by him; and M. sailed on 20th September 1519, with five ships and 236 men, from San Lucar, and proceeding to the mouth of the La Plata, and along the shores of Patagonia, he discovered and sailed through the strait which bears his name; discovered the Southern Pacific Ocean, to which he gave that name upon account of the fine weather which he experienced there; reached the Philippine Isles, and fell in a fight with the chief of the isle of Matan, on 26th April 1521. His ship was safely carried home to Spain, and thus completed, on 6th September 1522, the first voyage ever made round the world. The complete narrative of M.'s voyage was edited by Amoretti (Milan, 1811).

MAGELLAN, or **MAGALHAENS**, **STRAIT OF**, separates South America on the south from Tierra del Fuego. It is 300 miles in length; its breadth varies from 5 to 30 miles; and the navigation is difficult. It was discovered in 1520 by Magalhaens, the Portuguese navigator, and took its name from him.

MAGENDIE, **FRANÇOIS**, an eminent French physiologist and physician, was born at Bordeaux in 1783, and died in Paris in 1855. Through the influence of his father, who practised as a physician in Paris, he became a pupil of Boyer, the celebrated anatomist. At the age of 20, after an examination by Concours, he was appointed professor in the faculty of medicine, and soon afterwards a demonstrator. He was subsequently appointed physician to the Hôtel-Dieu. In 1819, he was elected a member of the Academy of Sciences, and in 1831, succeeded Recamier in the chair of Anatomy in the College of France.

M.'s chief physiological works are: *Précis Élémentaire de Physiologie* (1816), which went through several editions, and was enlarged into the *Elémens de Physiologie*, which was translated into English, and was for many years the best work on physiology in this language; *Leçons sur les Phénomènes Physiques de la Vie* (1836—1842); *Leçons sur le Sang* (1839); *Leçons sur les Fonctions et les Maladies du Système Nerveux* (2 vols. 1839); and *Recherches Philosophiques et Cliniques sur le Liquide Céphalo-rachidien ou Cerebro-spinal* (1842). He was likewise the founder, and for ten years the editor of the *Journal de la Physiologie Expérimentale*, in which are recorded many of the experiments on living animals which gained for him, too deservedly, the character of an unscrupulous vivisector.

He was the first to prove experimentally that the veins are organs of absorption; he gave a more accurate account of the process of vomiting than had been previously given; he pointed out that non-nitrogenous foods are non-nutritious, and that an animal cannot live solely on any one kind of food, however nitrogenous it may be; he investigated the physiological action and therapeutic uses of hydrocyanic acid and strychnine; he performed an important series of experiments on the cause of death when air is admitted into the larger veins; he made numerous experiments to determine the functions of various nerves and of different parts of the brain; and lastly, he shares, with Sir Charles Bell, the honour of having discovered the separate functions of the two roots of the spinal nerves.

MAGENTA, a Lombard town, in the province of Pavia, situated on the high road to Milan, from which it is distant 12 miles. Pop. 3800. The district in which it stands yields excellent wine and

an abundance of mulberries. In the campaign of 1859, M. was the scene of a decisive victory won by the French and Sardinians over the Austrians. It has given its name to one of the recently-discovered colours derived from coal-tar. See DYE-STUFFS.

MA'GEROË, the most northerly of the larger European islands, belongs to Norway, and lies close to the coast of Finmark, in the Arctic Ocean. It terminates towards the north in the North Cape, 970 feet in height, and situated in lat. 71° 10' N., long. 25° 50' E. M. is 22 miles in extreme length, and 15 miles in breadth, is irregular in shape, and deeply indented by bays. It supports a few Norwegian and Lappish families.

MAGGIO'RE, LAGO, one of the largest lakes in Italy, the *Lacus Verbanus* of the Romans, is situated partly in Piedmont, partly in Lombardy, and partly in the Swiss canton of Ticino. It is about 36 miles in length, and its greatest breadth is about 8 miles. It lies 650 feet above the level of the sea, and its depth is in some places not less than 1800 feet. The river Ticino flows through it. In a south-western expansion of the lake, are the Borromean Isles (q. v.). On the north and west, it is surrounded by granitic mountains; on the south and east, by vineyard-covered hills; and its scenery presents a combination of soft beauty with wild grandeur.

MAGGOT, the popular name of the larvæ of many kinds of dipterous insects, particularly those of the great family *Muscidae* (Flies), although it is often also given to those of *Cestridae* (Bot-flies, &c.). It is more commonly given to those larvæ which feed on animal, than to those which feed on vegetable substances, and particularly to those—of which there are very many species—which feed on putrescent animal matter. *Corpse-worms* are the larvæ of *Sarcophaga mortuorum*, a fly which is always ready—at least in Europe—to lay its eggs in human bodies when deposited in open vaults. The maggots of the Flesh-fly (q. v.) are used for feeding pheasants and as a bait for fish, and means are therefore often used to procure them in abundance, by exposing dead bodies of animals to putrefaction in the open air.

MA'GI (variously derived from *mag* or *mog*, Pehlvi: priest; *mikguth*, a man who wears his hair in a particular manner; *mogh*, distinguisher; &c.) is the name of a tribe of the Medians, which, not unlike that of Levi among the Israelites, were set aside for the management of the sacred rites, and for the preservation and propagation of the traditional knowledge. From the Medians, the institution of the magi found its way, under Cyrus, into Persia, and here rose to the very highest importance, while at the same time they now seem to have extended their inner sphere of action. They were not only the 'keepers of the sacred things, the learned of the people, the philosophers and servants of God,' but also diviners and mantics, augurs and astrologers. They called up the dead, either by awful formulas which were in their exclusive possession, or by means of cups, water, &c. They were held in the highest reverence, and no transaction of importance took place without or against their advice. Hence their almost unbounded influence in private as well as in public life, and, quite apart from the education of the young princes being in their hands, they also formed the constant companions of the ruling monarch. Of their religious system itself, the articles GÜEBRES and PARSEES will give a fuller account. Zoroaster (q. v.) (*Zerdusht*) reorganised, in the course of his great religious reform, also the body of the magi, chiefly by reinforcing the ancient laws about their manner and mode of life, which was to be one of the simplest

and severest, befitting their sacred station, but which had become one of luxury and indolence; and by re-instituting the original distinction of the three classes of *Herbeds* (disciples), *Mobeds* (masters), and *Destur Mobeds* (complete masters). The food, especially of the lower class, was to consist only of flour and vegetables; they wore white garments, slept on the ground, and were altogether subjected to the most rigorous discipline. The initiation consisted of the most awful and mysterious ceremonies. Purifications of several months' duration had to precede it, and it was long before the stage of the disciple's 'being led into the realms of the dead' was proceeded with.

Gradually, however, their influence, which once had been powerful enough to raise them to the throne itself (Sassanides), began to wane, and if formerly a number of 80,000 delegates of magi had to decide on the affairs of state and religion, this council, in later times, dwindled down to the number of seven; and from being the highest caste, the priests of God, and the 'pure of mind, heart, and hand,' they fell to the rank of wandering jugglers, fortune-tellers, and quacks, and gave the name to the art of sleight-of-hand and performance of conjuring tricks.

MAGIC (see art. MAGI) is a general name for wonderful effects produced in some mysterious way. Medicine in its early form is intimately allied to magic. It would soon be discovered by accident that certain plants produced powerful effects, both good and bad, upon the bodies of men and animals; and the reverence arising from their real virtues would lead to ascribing to them all manner of imaginary ones. The laws of nature being little known, one thing was not more incredible than another; and effects were assigned to causes in the most arbitrary and accidental way. The Rosicrucian physicians treated a case of wounding by applying the salve to the weapon instead of to the wound itself; and this may be taken as the type of magical, as contrasted with rational medicine. In modern times, drugs are mostly drawn from the mineral and vegetable kingdoms; but while the healing art was in the mystic stage, animal substances were most esteemed. If the juice of a plant could affect the living body, how much more must the life-blood of another animal! And the rarer the kind of blood, so much the rarer the virtue. The blood of an innocent child, or of a virgin, was believed to cure the leprosy; that of an executed criminal, the falling sickness. The hearts of animals, as being the seat of life, were held to be potent drugs. The fat of a hog had been found by experience to benefit a sore; what virtue, then, must there be in human fat, with the solemn mysteries of the grave about it!

In early stages of society, women are the doctors; while the men fight and hunt, the women gather herbs and decoct salves for their wounds; and the art would naturally become a sort of profession in the hands of the older women who had a reputation for superior skill of that kind. Mostly a blind groping—a mystery to themselves as well as others—their operations were looked upon with awe. The 'wise woman' with her kettle, cooking her mysterious broth, adding ingredient after ingredient (for the more, the rarer, the horribler they were, would not the compound be the more efficacious?), inspired not only hope but fear; for the art might be, and doubtless was, used to hurt as well as to heal. Roman matrons were often accused and convicted of poisoning by their decoctions; and during seasons of pestilence, these female druggists were persecuted with indiscriminate fury, as were witches afterwards in Europe. So much was the notion of poisoning uppermost in the Roman mind respecting

them, that *venefica*, literally, 'a poison-maker,' was the general name for a preparer of magic medicines, an enchantress or sorceress—the corresponding character to our witch. See WITCHCRAFT.

The operation of magical medicines was not, as is the case with those of the modern pharmacopœia, confined to physical effects on living bodies to which they were applied; associated with incantations and other ceremonies, as they always were, they could be made to produce almost any desired effect—raise or lay storms; fertilise a field, or blast it; kill or cure a man, absent as well as present; and give the power of predicting future events. How a belief in imaginary virtues of things may grow out of the experience of their real virtues, is indicated by Dr Livingstone, when speaking of the belief in rain-making among the tribes in the heart of Southern Africa. The African priest and the medicine-man is one and the same, and his chief function is to make the clouds give out rain. The preparations for this purpose are various—charcoal made of burned bats; internal parts of animals, as lions' hearts and hairy calculi from the bowels of old cows; serpents' skins and vertebrae; and every kind of tuber, bulb, root, and plant to be found in the country. 'Although you disbelieve their efficacy in charming the clouds to pour out their refreshing treasures, yet, conscious that civility is useful everywhere, you kindly state that you think they are mistaken as to their power; the rain-doctor selects a particular bulbous root, pounds it, and administers a cold infusion to a sheep, which in five minutes afterwards expires in convulsions. Part of the same bulb is converted into smoke, and ascends towards the sky; rain follows in a day or two. The inference is obvious.' The religion of this part of Africa may be characterised as medicine-worship. In a village of the Balonda, Dr Livingstone saw two pots with charms or medicines kept in a little shed, like idols in a niche. For an idol they sometimes take a piece of wood, and carve a human head on it, or simply a crooked stick, when there is no professed carver to be had; but there is nothing divine about it until it is dotted over with a mixture of medicine and red ochre. Packets of medicine are worn as charms about the person, to ward off evils of all kinds. The female chief Manenko was hung all over with such charms; and when she had to cross a river, her travelling-doctor waved medicines over her, and she took some in her hand, to save her from drowning.

During the middle ages, and down almost to the 18th c., magic was greatly studied in Europe, and could boast of distinguished names, who attempted to treat it as a grand and mysterious science, by means of which the secrets of nature could be discovered, and a certain godlike power acquired over the 'spirits' (or, as we should now say, the 'forces') of the elements. The principal students and professors of magic during the period referred to, were Pope Sylvester II., Albertus Magnus, Roger Bacon, Raymond Lully, Pico della Mirandola, Paracelsus, Cornelius Agrippa, Trithemius, Van Helmont, and Jerome Cardan.—See Horst's *Von der Alten und Neuen Magie, Ursprung, Idee, Umfang und Geschichte* (Mentz, 1820); and Ennemoser's *Geschichte der Magie* (2d ed. Leip. 1844; translated into English by W. Howitt, 2 vols. Lond. 1854). For an interesting account of the discipline and ceremonies of the 'art,' consult the *Dogme et Rituel de la Haute Magie* (2 vols. Paris, 1856), by Eliphas Levi—one of its latest adherents.

Some of the different forms which the belief in magic has assumed will be seen under AMULET, AUGURIES AND AUSPICES, DIVINATION, INCANTA-

TION, and WITCHCRAFT, and the allied subjects of ALCHEMY and ASTROLOGY.

MAGIC LANTERN, an optical instrument by means of which magnified images of small pictures are thrown upon a wall or screen. The instrument consists of a lantern containing a powerful argand lamp; in the side of the lantern is inserted a horizontal tube, on a level with the flame, and the light is made to pass through the tube by reflection from a concave mirror placed on the opposite side of the lantern. The tube is furnished with two lenses, one at each end; the inner one is a hemispherical illuminating lens of short focus, to condense a strong light on the picture, which is inserted into the tube, between the lenses, through a transverse slit. The other end of the tube is fitted with a double convex lens, which receives the rays after passing through the picture, and throws them upon the screen or wall. The pictures are formed with transparent varnish on glass slides, and must be inserted into the tube in an inverted position, in order that the images may appear erect. If the screen on which the image is thrown be at too great a distance, the image will become *indistinct* from the lessened intensity of the light, and *distorted* by the increasing spherical and chromatic aberration, though this latter defect may be obviated by the use of a screen of the same curvature as the outside surface of the lens. This instrument is generally used as a toy, but is also occasionally employed to produce enlarged representations of astronomical diagrams, so that they may be well seen by an audience. Phantasmagoria, dissolving views, &c., are produced by a particular manipulation of the same instrument.

MAGIC SQUARES, a species of puzzle which occupied the attention of many celebrated mathematicians from the earliest times down to the 18th century. The magic square is a square divided by lines parallel to the sides into a number of smaller equal squares or cells, in which are inserted numbers which form the terms of one or more progressions (generally arithmetical), in such an order that each line of numbers, whether added horizontally, vertically, or diagonally, shall amount to the same sum. This arrangement is effected in three different ways, according to the number of cells in the side of each square, and can be most easily effected when this number is *odd*, or *evenly even* (divisible by 4), but becomes a problem of considerable difficulty when the number of cells is *oddly even* (divisible by 2, and not by 4). The following are examples of the first two methods:

13	3	2	16
12	6	7	9
8	10	11	5
1	15	14	4

9	2	25	18	11
3	21	19	12	10
22	20	13	6	4
16	14	7	5	23
15	8	1	24	17

The arrangement for the oddly even squares is the same as that for the evenly even ones, with the exception of a few transpositions. The only exception is when the number of squares or cells is four. Dr Franklin invented a similar puzzle to this, called the 'magic circle.' See *Hutton's Recreations in Mathematical Science*, vol. i.

MAGILP, or MEGGELLUP, a composition used by artists in oil-colours as a vehicle for their 'glazes.' It is made of linseed oil and mastic varnish, and is thinned with turpentine as required for the painting.

MA'GILUS, a very curious genus of gasteropodous molluscs, of the order *Tubulibranchiata*, inhabiting the Red Sea and the Indian Ocean. They have, at first, shells of the ordinary form of spiral univalves, and establish themselves in little hollows of madrepores, where they remain, enlarging



Shell of Magilus.

the shell into a long tube as the madrepora grows, and thus preventing themselves from being shut in. The tube is sometimes three feet long, and the animal deserts entirely the spiral part of the shell, and lives in the mouth of the tube, which it closes against danger by an operculum, the upper part being wholly or partially filled up with solid matter.

MAGISTRATE. See JUSTICE OF PEACE.

MAGLIABECHI, ANTONIO DA MARCO, an Italian scholar of extraordinary attainments, and court librarian, born at Florence in 1633, of a respectable but indigent family. From his earliest years, he displayed an inordinate passion for the acquisition of book-knowledge. Having speedily mastered the Greek, Latin, and Hebrew languages, he literally entombed himself among books, of which disorderly piles encumbered every portion of his dwelling, and lay in a heterogeneous litter around his feet. In his daily habits, M. grew regardless of the requirements of social and sanitary life; and such was his avidity of study, that he finally denied himself even the requisite intervals of repose. His memory was prodigious, and not only enabled him minutely to retain the contents of his multitudinous books, but also to supply, on occasion, the most exact reference to any particular page or paragraph, the place of each book being indicated with precision in the midst of their apparent inextricable masses. M. was regarded as the literary prodigy of his times. He was appointed court-librarian by the Grand Dukes of Florence; and the many tributes of respect tendered by royal and distinguished personages to his wonderful erudition, fostered in an inordinate degree his love of fame and praise, which rendered him intolerant of literary merit in others, and involved him in several bitter literary squabbles. He died at Florence on 12th July 1714, in the 81st year of his age, leaving no written record of his immense encyclopaedic knowledge. His valuable library of 30,000 vols. he bequeathed to his native city of Florence, with funds

for its future care and extension; it is now a free library, and bears the name of its collector.

MA'GNA CHARTA, the Great Charter which was granted by King John of England to the barons, and has been viewed by after-ages as the basis of English liberties. The oppressions and exactions of a tyrannical and dastardly sovereign called into existence a confederacy of the barons or tenants-in-chief of the crown, who took up arms for the redress of their grievances. Their demand was for the restoration of the laws of Henry I.; laws which might probably be characterised as an engrafting of Norman feudalism on the 'ancient custom of England,' or previously existing Saxon and Danish free institutions, in which 'ancient custom' were comprehended the laws of Edward the Confessor. A conference between the sovereign and the barons was held at Runnymede, near Windsor, a place where treaties regarding the peace of the kingdom had often before been made. King and barons encamped opposite each other; and after several days' debate, John signed and sealed the charter with great solemnity on June 5, 1215.

The Great Charter reared up a barrier against the abuse of the royal prerogative by a series of provisions for the protection of the rights and obligations of the feudal proprietor. It redressed a variety of grievances connected with feudal tenures, some of them now so long obsolete as to be with difficulty intelligible. There are minute provisions regarding the relief of heirs, wardship, marriage of heirs and of their widows. No scutage or aid is to be imposed without the authority of the common council of the kingdom, except on the three great feudal occasions of the king's captivity, the knighting of his eldest son, and the marriage of his eldest daughter. The liberties of the city of London, and other towns, burghs, and ports, are declared inviolable. Freedom of commerce is guaranteed to foreign merchants. Justice is no longer to be sold, denied, or delayed. The Court of Common Pleas, instead of, as formerly, following the king's person in all his progresses, is to be permanently fixed at Westminster; assizes are to be held in the several counties, and annual circuits are established. Regulations are made for the efficiency of the inferior courts of justice. The protection of life, liberty, and property from arbitrary spoliation is the most important feature of the charter. 'No freeman shall be taken or imprisoned, or be disseised of his freehold, or liberties, or free customs, or be otherwise damaged, nor will we pass upon him, nor send upon him, but by lawful judgment of his peers, or by the law of the land'—a provision which recognised a popular tribunal as a check on the official judges, and may be looked on as the foundation of the writ of Habeas Corpus. No one is to be condemned on rumours or suspicions, but only on the evidence of witnesses. Protection is afforded against excessive amercements, illegal distresses, and various processes for debts and services due to the crown. The fines imposed are in all cases to be proportioned to the magnitude of the offence, and even the villein or rustic is not to be deprived of his necessary chattels. There are provisions regarding the forfeiture of lands for felony. The testamentary power of the subject is recognised over part of his personal estate, and the rest is to be divided between his widow and children. The independence of the church is also provided for.

These are the most important features of that Charter which occupies so conspicuous a place in history, and which establishes the supremacy of the law of England over the will of the monarch. A charter was at the same time granted to mitigate the oppressions of the Forest Laws (q. v.). The

terms dictated by the barons to John included the surrender of London to their charge, and the Tower to the custody of the primate till the 15th of August following, or till the execution of the several articles of the Great Charter. Twenty-five barons, as conservators of the public liberties, were invested with extraordinary authority, which empowered them to make war against the sovereign in case of his violation of the Charter. Several solemn ratifications were required by the barons both from John and from Henry III.; and a copy of the Great Charter was sent to every cathedral, and ordered to be read publicly twice a year. The copy preserved in Lincoln Cathedral is regarded as the most accurate and complete; and a fac-simile of it was engraved by order of the late Board of Commissioners on the public records. The Great Charter and Charter of the Forests are printed with English translations, and prefixed to the edition of the Statutes of the Realm published by the Record Commission.

MAGNA GRÆCIA (Gr. *Hē Megalē Hellas*), the name given in ancient times to that part of Southern Italy which was thickly planted with Greek colonies. When it first obtained this appellation, is unknown, but it must have been at an early period. Polybius says it was so called in the time of Pythagoras. Some writers include under the term the Greek cities in Sicily; others restrict it to those situated on the Gulf of Tarentum, but in general it is used to denote all the Greek cities in the south of Italy, exclusive of those in Sicily. The oldest settlement is believed to have been *Cuma*—though it is doubtful whether it and its colonies, *Dicaearchia* and *Neapolis*, were really embraced under the designation *M. G.*; while the period assigned to its foundation—viz., soon after the Trojan war—is obviously fanciful. If we fix about the 8th or 9th c. before Christ, we will perhaps not be far wrong. Of the other Greek settlements in Italy—most, if not all of which were later than those in Sicily—the earliest was *Sybaris* (founded by the Achæans, 720 B. C.); next, *Croton* (by the Achæans, 710 B. C.); then *Tarentum* (by the Spartans, 708 B. C.), *Locri* (by the Locrians, 708 B. C., according to others, thirty or forty years later), *Rhegium* (by the Chalcidians; date of origin not known, but believed by some to be older than even *Sybaris*), *Metapontum* (by the Achæans, 700—680 B. C.), and *Velia* (by the Phocæans, 540 B. C.). These cities became, in their turn, the parents of many others.

Of the earlier history of *M. G.*, we know almost nothing. The settlements appear to have risen rapidly to power and wealth, partly by the brisk commerce which they carried on with the mother-country, and partly also, it is conjectured, by an amalgamation with the Pelægic (and therefore kindred) natives of the interior. This, we are told by Polybius, actually happened at *Locri*, and most probably elsewhere also. About the year 530 B. C., *Pythagoras* the philosopher arrived at *Crotona*, and soon acquired an influence in *M. G.* which was quite wonderful, though it did not last long. The quarrels between the different cities were often bitter and bloody; and finally, 272—271 B. C., the Romans conquered the whole of Lower Italy. Long before this, several of the cities had disappeared. *Sybaris*, for example, was destroyed by the Crotonians as early as 510 B. C., and now the rest more or less rapidly sunk into decay, and were, in the time of *Cicero*, with a few exceptions, reduced to utter ruin.

MAGNESIA. See **MAGNESIUM.**

MAGNESIAN LIMESTONE. See **DOLOMITE.**

MAGNESIUM (symb. Mg, equiv. 12, sp. gr. 1.74) is placed by most chemists with those metals whose

oxides form the alkaline earths (baryta, strontia, lime), but in many respects it more closely resembles zinc. It is a malleable ductile metal, of the colour and brilliancy of silver. It fuses at about the melting-point of tin (about 442°), and at an extreme heat it may be distilled like zinc. When ignited in dry air or in oxygen gas, it burns with extraordinary brilliancy, and is oxidised into magnesia. In dry air, it undergoes little change, and is much less oxidisable than the other metals of the same group. It does not decompose cold water; but if the water be heated to about 90°, there is a slight evolution of hydrogen; and if the temperature is raised to 212°, hydrogen is given off rapidly and abundantly. When thrown into strong hydrochloric acid, it inflames and becomes converted into chloride of magnesium, while hydrogen is given off.

It is obtained from its chloride either by the action of sodium or potassium, or by simple electrolytic decomposition; but the ordinary processes are difficult, and yield the metal only in minute quantities. A patent has, however, just been taken out by Mr Sonstadt for improvements in its manufacture, by which it can be produced by the pound.

Magnesia (MgO) is the only oxide of magnesium. It is a white bulky powder, devoid of taste or smell, and having a sp. gr. of 3.65; it is infusible, and almost insoluble in water; and when placed on moistened test-paper, is seen to have an alkaline reaction. When mixed with water, it gradually forms a hydrate (MgO.HO), without, as in the case of lime, any sensible elevation of heat, and this hydrate slowly absorbs carbonic acid from the atmosphere. *Magnesia* does not occur native, and is usually obtained by the prolonged application of heat to the carbonate. Hydrate of magnesia occurs naturally in a crystalline form in the mineral *Brucite*.

Magnesia Alba, the common white magnesia of commerce, is a mixture of the hydrate of magnesia and of hydrated carbonate. It is obtained by the precipitation of a hot solution of sulphate of magnesia by a hot solution of carbonate of potash or soda, and by then collecting and drying the deposit.

Of the *magnesian salts*, some are soluble, and some insoluble in water. The soluble salts have a peculiar and very bitter taste, and hence the German name, *Bittererde* (bitter-earth) for magnesia. All the salts which are insoluble in water, except the silicate, dissolve in hydrochloric and nitric acids.

Carbonate of Magnesia occurs native in the mineral *magnesite*, and in association with carbonate of lime in *dolomite*, from which it may be manufactured in a very pure state by Mr Pattinson's process, which consists essentially in the following steps. Finely ground dolomite is exposed for some time to a red heat, by which the carbonate of magnesia is decomposed; the powder is then introduced into a very strong vessel, where it is mixed with water, and carbonic acid gas forced in under heavy pressure till it ceases to be absorbed; the carbonate of magnesia becomes dissolved as bicarbonate, while the carbonate of lime remains unchanged; on boiling the clear liquid, carbonate of magnesia is deposited, and carbonic acid expelled.

Sulphate of Magnesia, or *Epsom Salts* (MgO,SO₄ + 7Aq), is the most important of the magnesian salts. It is obtained from sea-water, or from magnesian limestone (dolomite), or from the mother-liquor of alum-works, by processes into which we have not space to enter, and is a common ingredient in mineral waters (see *EPSOM SALT*). It is soluble in three times its weight of water at 60°, and in less water at a higher temperature, the solution having a bitter, disagreeable taste.

Nitrate of Magnesia (MgO,NO₃ + 6Aq) occurs in

certain mineral waters, but is of no special importance.

A *Phosphate of Magnesia*, having the formula $\text{HO}, 2\text{MgO}, \text{PO}_5, + 14\text{Aq}$, is obtained by the mixture of solutions of sulphate of magnesia and of ordinary phosphate of soda. It occurs either in an amorphous state or in six-sided prisms, according as the solutions are more or less concentrated. This salt is a constituent of the seeds of wheat and the other cereals, of bones, and of various morbid concretions. The *Phosphate of Ammonia and Magnesia*, known also as *Ammoniaco-magnesian Phosphate* and as *Triple Phosphate* ($\text{NH}_4, 2\text{MgO}, \text{PO}_5, + 12\text{Aq}$), is a more important salt than the preceding. It occurs either in minute crystalline grains, or in beautiful transparent four-sided prisms of considerable size, and with a very characteristic appearance. The formation of the salt, which is only slightly soluble in pure water, and is quite insoluble in water containing free ammonia or its hydrochlorate, not only furnishes a very delicate test for the presence of magnesia, but enables us to determine its quantity.

This phosphate of ammonia and magnesia is readily formed by mixing a solution of a magnesian salt with hydrochlorate of ammonia, phosphate of soda, and a little free ammonia. It is an occasional constituent of urinary calculi, and crystallises in beautiful prisms from urine and other animal fluids, when they begin to putrefy. It is also frequently present in the excrements in cases of diarrhoea.

The *silicates of magnesia* are numerous. A large number of minerals are formed either wholly or partly of them, among which may be mentioned Olivine or Chrysolite, Talc, Steatite or Soapstone, Meerschaum, Serpentine, Augite, Hornblende, &c.

The haloid salts of magnesium—the chloride, iodide, and bromide—are of no special interest, except that the chloride of magnesium is, next to chloride of sodium, the most abundant of the salts existing in sea-water.

The compounds of magnesium employed in medicine are magnesia, its carbonate and its sulphate.

Magnesia is presented in small doses (from ten grains to a scruple), as an antacid, in cases of undue acidity of the stomach, heartburn, and abnormal acidity of the urine; in larger doses (from a scruple to a drachm), it produces distinct purgative effects. It is useful, especially when combined with rhubarb and a little ginger (in the form of Compound Rhubarb Powder or Gregory's Mixture), as a purgative for children, in acid conditions of the alimentary canal.

Carbonate of magnesia (*magnesia alba*) acts in the same manner as magnesia, except that it is less active, since more than half of it consists of water and carbonic acid. Dinneford's Solution of Magnesia, and other fluid preparations of the same nature, are made by dissolving this salt in water charged with carbonic acid. A drachm of carbonate of magnesia, the juice of one lemon, and a wine-glassful of water, constitute an agreeable laxative, a citrate of magnesia being thus formed.

Sulphate of magnesia is a purgative in very general use. It is much employed in febrile affections, and when the portal system is congested; but it may be used in almost any case in which a mild but efficient laxative is required. Its dose varies from two to four or six drachms. In combination with the infusion of senna, it forms the ordinary *Black Draught*.

MAGNETISM (said to be derived from the city Magnesia, where the loadstone was first discovered) is the power which the magnet has to attract iron. Under 'Diamagnetism' it is stated that every substance is more or less affected by the magnet, but as iron is *par excellence* magnetic, the term is chiefly used with reference to it. Magnets are of two kinds,

natural and *artificial*. Natural magnets consist of the ore of iron called magnetic, familiarly known as loadstone. Artificial magnets are, for the most part, straight or bent bars of tempered steel, which have been magnetised by the action of other magnets, or of the galvanic current.

Polarity of the Magnet.—The power of the magnet to attract iron is by no means equal throughout its length. If a small iron ball be suspended by a thread, and a magnet (fig. 1) be passed along in front of it from one end to the other, it is powerfully attracted at the ends, but not at all in the middle, the magnetic force increasing with the distance from the middle of the bar. The ends of the magnet where the attractive power is greatest are called its poles. By causing a magnetic needle moving horizontally to vibrate in front of the different parts of a magnet placed vertically, and counting the number of vibrations, the rate of increase of the magnetic intensity may be exactly found. Fig. 2 gives a graphic view of this increase. NS is the magnet; the lines aN,

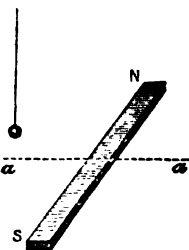

Fig. 1.



Fig. 2.

aa, &c., represents the magnetic intensities at the points N, a, &c., of the magnet; and the curve of magnetic intensity, NaMa'n', is the line formed by the extremities of all the upright lines. It will be seen from the figure that the force of both halves, taking M as the dividing-point, is disposed in exactly the same way, that for some distance on either side of the middle or neutral point there is an absence of force, and that its intensity increases with great rapidity towards the ends. The centres of gravity of the areas MNn' and MSs' are the poles of the magnet, which must therefore be situated near, but not at the extremities.

A magnet has, then, two poles or centres of magnetic force, each having an equal power of attracting iron. This is the only property, however, which they possess in common, for when the poles of one magnet are made to act on those of another, a striking dissimilarity is brought to light. To shew this, let us suspend a magnet, NS, fig. 3, by a band of paper, M, hanging from a cocoon thread (a thread without torsion). When the magnet is left to itself, it takes up a fixed

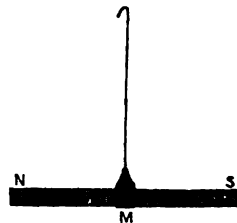

Fig. 3.

position, one end keeping north, and the other south. The north pole cannot be made to stand as a south pole, and *vice versa*; for when the

MAGNETISM.

magnet is disturbed, both poles return to their original positions. Here, then, is a striking dissimilarity in the poles, by means of which we are enabled to distinguish them as *north pole* and *south pole*. When thus suspended, let us now try the effect of another magnet upon it, and we shall find that the pole of the suspended magnet that is attracted by one of the poles of the second magnet is repelled by the other, and *vice versé*; and where the one pole attracts, the other repels. If, now, the second magnet be hung like the first, it will be found that the pole which attracted the north pole of the first magnet is a south pole, and that the pole which repelled it is a north pole. We thus learn, that *each magnet has two poles, the one a north, and the other a south pole, alike in their power of attracting soft iron, but differing in their action on the poles of another magnet, like poles repelling, and unlike poles attracting, each other.*

It might be thought that, by dividing a magnet at its centre, the two poles could be insulated, the one half containing all the north polar magnetism, and the other the south. When this is done, however, both halves become separate magnets, with two poles in each—the original north and south poles standing in the same relation to the other two poles called into existence by the separation. *We can therefore never have one kind of magnetism without having it associated in the same magnet with the same amount of the opposite magnetism.* It is this double manifestation of force which constitutes the polarity of the magnet.

The fact of the freely suspended magnet taking up a fixed position, has led to the theory, that the earth itself is a huge magnet, having its north and south magnetic poles in the neighbourhood of the poles of the axis of rotation, and that the magnetic needle or suspended magnet turns to them as it does to those of a neighbouring magnet. All the manifestations of terrestrial magnetism give decided confirmation of this theory. It is on this view that the French call the north pole of the magnet the south pole (*pôle austral*), and the south the north pole (*pôle boréal*); for if the earth be taken as the standard, its north magnetic pole must attract the south pole of other magnets, and *vice versé*. In England and Germany, the north pole of a magnet is the one which, when freely suspended, points to the north, and no reference is made to its relation to the magnetism of the earth.

Form of Magnets.—Artificial magnets are either bar-magnets or horseshoe-magnets. When powerful magnets are to be made, several thin bars are placed side by side with their poles lying in the same way. They end in a piece of iron, to which they are bound by a brass screw or frame. Three or four of these may be put up into the bundle, and these again into bundles of three and four (fig. 4). Such a



Fig. 4.

collection of magnets is called a *magnetic magazine* or *battery*. A magnet of this kind is more powerful than a solid one of the same weight and size, because thin bars can be more strongly and regularly magnetised than thick ones. Fig. 7 is a horseshoe-magnetic magazine. The central lamina protrudes slightly beyond the other, and it is to it that the armature is attached, the whole action of the magnet being concentrated on the projection. A natural magnet is shewn in fig. 5. It is a parallelopiped of magnetic iron ore, with pieces of soft iron, NN and

SS, bound to its poles by a brass frame encircling the whole. The lower ends of the soft iron bars act as the poles, and support the armature, A. The



Fig. 5.

magnetic needle is a small magnet nicely balanced on a fine point. See COMPASS.

Magnetic Induction.—When a short bar of soft iron, *ns* (fig. 6), is suspended from one end S of the magnet NS, it becomes for the time powerfully magnetic. It assumes a north and south pole, like



Fig. 6.

a regular magnet, as may be seen by using a small magnetic needle; and if its lower end, *s*, be dipped into iron filings, it attracts them as a magnet would do. When it is taken away from NS, the filings fall off, and all trace of magnetism disappears. It need not be in actual contact to shew magnetic properties; when it is simply brought near, the same thing is seen, though to a less extent. If the inducing magnet be strong enough, the induced magnet, *ns*, when in contact, can induce a bar like itself, placed at its extremity, to become a magnet; and this second induced magnet may transmit the magnetism to a third, and so on, the action being, however, weaker each time. If a steel bar be used for this experiment, a singular difference is observed in its action; it is only after some time that it begins to exhibit magnetic properties, and, when exhibited, they are feebler than in the soft iron bar. When the steel bar is removed, it does not part instantly with its magnetism, as the soft iron bar, but retains it permanently. Steel, therefore, has a force which, in the first instance, resists the assumption of magnetism; and, when assumed, resists its withdrawal. This is called the *coercitive force*. The harder the temper of the steel, the more is the coercitive force developed in it. It is this force also, in the load-stone, which enables it to retain its magnetism.

Magnetisation. By Single Touch (Fr. *simple touche*, Ger. *einfacher Strich*).—The steel bar to be magnetised

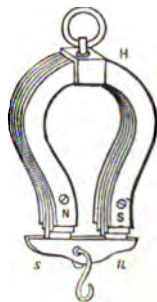

Fig. 7.

MAGNETISM.

is laid on a table, and the pole of a powerful magnet is rubbed a few times along its length, always in the same direction. If the magnetising pole be north, the end of the bar it first touches each time becomes also north, and the one where it is lifted south. The same thing may be done by putting, say, the north magnetising pole first on the middle of the bar, then giving it a few passes from the middle to the end, returning always in an arch from the end to the middle. After doing the same

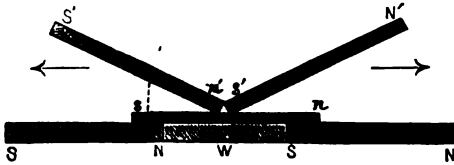

Fig. 8.

to the other half with the south pole, the magnetisation is complete. The first end rubbed becomes the south, and the other the north pole of the new magnet.—By *Divided Touch* (Fr. *touché séparé*, Ger. *getrennter Strich*).—This method is shown in fig. 8. The bar *ns* to be magnetised is placed on a piece of wood *W*, with its ends abutting on the extremities of two powerful magnets *NS* and *SN*. Two rubbing magnets are placed with their poles together on the middle of *ns*, inclined at an angle rather less than

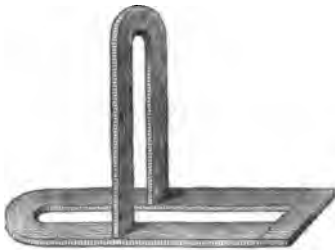

Fig. 9.

30° with it. They are then simultaneously moved away from each other to the ends of *ns*, and brought back in an arch again to the middle. After this is repeated a few times, the bar *ns* is fully magnetised. The disposition of the poles is shown in the figure by the letters *N* or *n*, meaning a north, and *S* or *s*, a south pole. This method communicates a very regular magnetism, and is employed for magnetic needles, or where accuracy is needed.—The magnetisation by *Double Touch* is of less practical importance, and need not here be described. It communicates a powerful, but sometimes irregular magnetism, giving rise to consecutive poles—that is, to more poles than two in the magnet.



Fig. 10.

For horseshoe magnets, Hoffer's method is generally followed. The inducing magnet (fig. 9) is placed vertically on the magnet to be formed, and moved from the ends to the bend, or in the opposite way, and brought round again, in

an arch, to the starting-point. A soft iron armature is placed at the poles of the induced magnet. That the operation may succeed well, it is necessary for both magnets to be of the same width. The same method may also be followed for magnetising bars. The bars (fig. 10) *NS* and *N'S'*, with the armatures *ab* and *cd*, are placed so as to form a rectangle; and the horseshoe-magnet is made to glide along both in the way just described.

Magnetisation by the Earth.—The inductive action of terrestrial magnetism is a striking proof of the truth of the theory already referred to, that the earth itself is a magnet. When a steel rod is held in a position parallel to the Dipping-needle (q. v.), it becomes, in the course of time, permanently magnetic. This result is reached sooner when the bar is rubbed with a piece of soft iron. A bar of soft iron held in the same position is more powerfully but only temporarily affected, and when reversed, the poles are not reversed with the bar, but remain as before. If when so held it receive at its end a few sharp blows of a hammer, the magnetism is rendered permanent, and now the poles are reversed when the bar is reversed. The torsion caused by the blows of the hammer appears to communicate to the bar a coercitive force. We may understand from this how the tools in workshops are generally magnetic. Whenever large masses of iron are stationary for any length of time, they are sure to give evidence of magnetisation, and it is to the inductive action of the earth's poles acting through ages that the magnetism of the loadstone is to be attributed.

Preservation and Power of Magnets.—Magnets, when freshly magnetised, are sometimes more powerful than they afterwards become. In that case, they gradually fall off in strength, till they reach a point at which their strength remains constant. This is called the *point of saturation*. If a magnet has not been raised to this point, it will lose nothing after magnetisation. We may ascertain whether a magnet is at saturation by magnetising it with a more powerful magnet, and seeing whether it retains more magnetism than before. The saturation point depends on the coercitive force of the magnet, and not on the power of the magnet with which it is rubbed. When a magnet is above saturation, it is soon reduced to it by repeatedly drawing away the armature from it. After reaching this point, magnets will keep the same strength for years together if not subjected to rough usage. It is favourable for the preservation of magnets that they be provided with an armature or keeper. For further information, see article *ARMATURE*. The power of a horseshoe-magnet is usually tested by the weight its armature can bear without breaking away from the magnet. Hucker gives the following formula for this weight: $W = a\sqrt{m^2}$; W is the charge expressed in pounds; a , a constant to be ascertained for a particular quality of steel; and m is the weight in pounds of the magnet. He found, in the magnets that he constructed, a to be 12.6. According to this value, a magnet weighing 2 oz. sustains a weight of 3 lbs. 2 oz., or 25 times its own weight; whereas a magnet of 100 lbs. sustains only 271 lbs., or rather less than 3 times its own weight. Small magnets, therefore, are stronger for their size than large ones. The reason of this may be thus explained. Two magnets of the same size and power, acting separately, support twice the weight that one of them does; but if the two be joined, so as to form one magnet, they do not sustain the double, for the two magnets being in close proximity, act inductively on each other, and so lessen the conjoint power. Similarly, several magnets made up into a battery have not a force proportionate to their number. Large magnets in the

same way may be considered as made up of several laminae, interfering mutually with each other, and rendering the action of the whole very much less than the sum of the powers of each. The best method of ascertaining the strength of bar-magnets is to cause a magnetic needle to oscillate at a given distance from one of their poles, the axis of the needle and the pole of the magnet being in the magnetic meridian. These oscillations observe the law of pendulum motion, so that the force tending to bring the needle to rest is proportionate to the square of the number of oscillations in a stated time.

Action of Magnets on each other.—Coulomb discovered, by the oscillation of the magnetic needle in the presence of magnets in the way just described, that when magnets are so placed that two adjoining poles may act on each other without the interference of the opposite poles, that is, when the magnets are large compared with the distance between their centres, their attractive or repulsive force varies inversely as the square of the distance. Gauss proved from this theoretically, and exhibited experimentally, that when the distance between the centres of two magnets is large compared with the size of the magnets, that is, when the action of both poles comes into play, their action on each other varies inversely as the cube of the distance.

Effect of Heat on Magnets.—When a magnet is heated to redness, it loses permanently every trace of magnetism; iron, also, at a red heat, ceases to be attracted by the magnet. At temperatures below red heat, the magnet parts with some of its power, the loss increasing with the temperature. The temperatures at which other substances affected by the magnet lose their magnetism differ from that of iron. Cobalt remains magnetic at the highest temperatures, and nickel loses this property at 662° F.

Ampere's Theory of Magnetism.—This theory forms the link between magnetism and galvanic electricity, and gives a simple explanation of the phenomena of electro-magnetism and magneto-electricity. We shall therefore preface the short discussion of these two subjects by a reference to it. Ampere considers that every particle of a magnet has closed currents circulating about it in the same direction. A section of a magnet according to this theory is shewn in fig. 11. All the separate currents in the various particles may, however, be considered

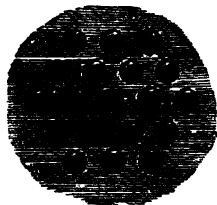

Fig. 11.



Fig. 12.

to be equivalent to one strong current circulating round the whole (fig. 12). We are to look upon a magnet, then, as a system, so to speak, of rings or rectangles, placed side by side, so as to form a cylinder or prism, in each of which a current in the same direction is circulating. Before magnetisation, the currents run in different directions, so that their effect as a system is lost, and the effect of induction is to bring them to run in the same direction. The perfection of magnetisation is to render the various currents parallel to each other. Soft iron, in consequence of its offering no resistance to such a disposition, becomes more powerfully magnetic under

induction than steel, where such resistance exists. Experiment very strongly confirms the truth of this theory. Helices of copper-wire, in which a current is made to circulate, manifest all the properties of a magnet. Such are shewn, in skeleton, in figs. 13 and 14. Each convolution of the spiral



Fig. 13.

may be taken as a substitute for one of the rings above spoken of. In helix (fig. 13), the current, after entering, goes from right to left (contrary to the hands of a watch), and it is hence called left-handed; in fig. 14, it goes with the hands of a



Fig. 14.

watch, and is right-handed. The extremities of both helices act on the magnetic needle like the poles of a magnet while the current passes. The poles are shewn by the letters N and S, and this can be easily deduced from Ampere's rule (see GALVANISM), for, suppose the little figure of a man to be placed in any part of the helix (fig. 13), so that, while he looks towards the axis of the helix, the current enters by his feet, and leaves by his head, the north pole will be at his left hand, as shewn in the figure. In the left-handed helix (fig. 14), the poles are reversed according to the same rule. If either of these helices be hung so as to be capable of horizontal motion, which, by a simple construction, can easily be done, as soon as the current is established, the north and south poles place themselves exactly as those of the magnetic needle would do; or, if they were hung so as to be able to move vertically in the magnetic meridian, they would take up the position of the Dipping-needle (q. v.).

These movements can be still further explained by reference to the mutual action of electric

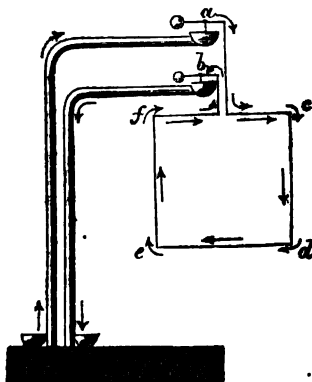

Fig. 15.

currents on each other. It is found that when two currents are free to move, they endeavour to place themselves parallel to each other, and to move in the same direction, and that currents running in opposite directions, repel. The apparatus fig. 15 is intended to prove this. The rectangle *abcd* is movable round the pins, *a* and *b*, resting on two mercury cups.

The arrangement is such that while the rectangle *cdef* is movable about its axis, a current can continue steadily to flow in it. Further description is unnecessary, the diagram explaining itself. If a wire in which a current passes downwards be placed vertically near *cd*, *cd* is attracted by it; but if the current pass upwards, it is repelled, and *ef* attracted. Place, now, the wire below and parallel to *de*. If the current passes in the direction *d* to *e*, no change takes place, as the attraction cannot shew itself; but if the current moves from *e* to *d*, the whole turns round till it stands where *e* was, and both currents run the same way. If the wire be placed at right angles to *de*, the rectangle turns round and comes to rest, when both currents are parallel, and in the same direction.

According to Ampere's theory, the earth, being a magnet, has currents circulating about it, which, according to his rule, must be from east to west, the north pole of the earth being, in our way of speaking, a south pole. A magnet, then, will not come to rest till the currents moving below it place themselves parallel to and in the direction of the earth's currents. This is shewn in fig. 16, where

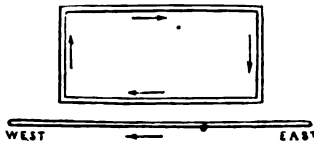

Fig. 16.

a section of a magnet is represented in its position of rest with reference to the earth-current. The upper current being further away from the earth-current, is less affected by it, and it is the lower current that determines the position. A magnetic needle, therefore, turns towards the north to allow the currents moving below it to place themselves parallel to the earth's current. This also is shewn by the rectangle in fig. 15, which comes to rest when *d* and *e* lie east and west.

Electro-magnetism includes all phenomena in which an electric current produces magnetism. The most important result of this power of the current is the electro-magnet. This consists (fig. 17) generally of a round bar of soft iron bent into the horseshoe form, with an insulated wire coiled round its extremities. When a current passes through the coil, the soft iron bar becomes instantly magnetic, and attracts the armature with a sharp click. When the current is stopped, this power disappears as suddenly as it came.



Fig. 17.

Electro-magnets far out rival permanent magnets in strength. Small electro-magnets have been made by Joule which support 3500 times their own weight, a feat immeasurably superior to anything performed by steel magnets. When the current is of moderate strength, and the iron core more than a third of an inch in diameter, the magnetism induced is in proportion to the strength of the current and of the number of turns in the coil. When the bar is thinner than one-third of an inch, a maximum

is soon reached beyond which additional turns of the wire give no additional magnetism; and even when the core is thick, these turns must not be heaped on each other, so as to place them beyond influencing the core. It follows from the above principle, that in the horseshoe-magnet, where the inductive action in the armature must be taken into account, that the weight which the magnet sustains is in proportion to the squares of the strengths of the currents, and to the squares of the number of turns of the wire. This maximum is in different magnets proportional to the area of section, or to the square of the diameter of the core. The electro-magnet, from the ease with which it is made to assume or lay aside its magnetism, or to reverse its poles, is of the utmost value in electrical and mechanical contrivances. The action of the electro-magnet is quite in keeping with Ampere's theory, as the current of the coil, acting on the various currents of the individual molecules, places them parallel to itself, in which condition the soft iron bar acts powerfully as a magnet. The direction of the current and the nature of the coil being known, the poles are easily determined by Ampere's rule.

Electro-magnetic Machines.—These take advantage of the facility with which the poles of an electro-magnet may be reversed, by which attractions and repulsions may be so arranged with another magnet as to produce a constant rotation. The forms in which they occur are exceedingly various, but the description of the apparatus in fig. 18 will suffice to illustrate their principle of working. *NS* is a fixed permanent magnet (it could be equally well an electro-magnet); the electro-magnet, *ns*, is fixed to the axis *ce*, and the ends of the coil are soldered

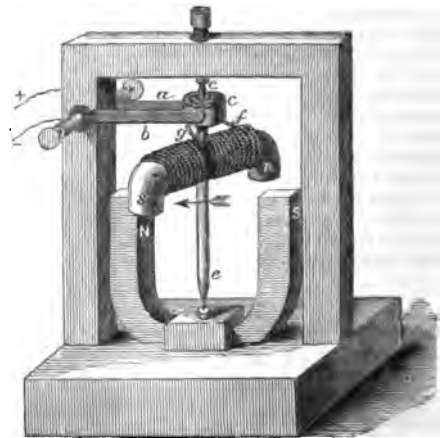

Fig. 18.

to the ring *c*, encircling a projection on the axis. The ring has two slits in it, dividing it into two halves, and filled with a non-conducting material, so that the halves are insulated from each other. Pressing on this broken ring, on opposite sides, are two springs, *a* and *b*, which proceed from the two binding-screws into which the wires, + and -, from the battery are fixed. In the position shewn in the figure, the current is supposed to pass along *a*, to the half of the ring in connection with the end *f*, of the coil, to go through the coil, to pass by *g* to the other half of the ring, and to pass along *b*, in its return to the battery. The magnetism induced by the current in the electro-magnet, makes *s* a south, and *n* a north pole, by virtue of which *N* attracts *s*,

and S attracts *n*. By this double attraction, *ns* is brought into a line with NS, where it would remain, did not just then the springs pass to the other halves of the ring, and reverse the current, making *s* a north, and *n* a south pole. Repulsion between the like poles instantly ensues, and *ns* is driven onwards through a quarter revolution, and then attraction as before between unlike poles takes it through another quarter, to place it once more axially. A perpetual rotation is in this way kept up. The manner in which a constant rotary motion may be obtained by electro-magnetism being understood, it is easy to conceive how it may be adapted to the discharge of regular work. Powerful machines of this kind have been made with a view to supplant the steam-engine; but such attempts, both in respect of economy and constancy, have proved utter failures.

Magneto-electricity includes all phenomena where magnetism gives rise to electricity. Under Induction of Electric Currents (q. v.), it is stated that when a coil, in which a current circulates, is quickly placed within another coil unconnected with it, a contrary induced current in the outer coil marks its entrance, and when it is withdrawn, a direct induced current attends its withdrawal. While the primary coil remains stationary in the secondary coil, though the current continues to flow steadily in the primary, no current is induced in the secondary coil. It is also shewn, that if, while the primary coil is stationary, the strength of its current be increased or diminished, each increase and diminution induce opposite currents in the secondary coil. Change, in fact, whether in the position or current strength of the primary coil, induces currents in the secondary coil, and the intensity of the induced current is in proportion to the amount and suddenness of the change. In singular confirmation of Ampere's theory, a permanent bar-magnet may be substituted for the primary coil in these experiments, and the same results obtained with greater intensity. When a bar-magnet is introduced into the secondary coil, a current is indicated, and when it is withdrawn, a current in a contrary direction is observed, and these currents take place in the directions required by Ampere's theory. A change of position of the magnet is marked by a current, as in the former case. If we had the means of increasing or lessening the magnetism of the bar, currents would be induced the same as those obtained by strengthening

or weakening the current in the primary coil. It is this inductive power of iron at the moment that a change takes place in its magnetism, that forms the basis of magneto-electric machines. The manner in which this is taken advantage of, will be easily understood by reference to fig. 19. NS is a permanent horseshoe-magnet, and let us suppose it to be fixed; CD is a bar of soft iron, with coils A and B wound round its extremities, and may

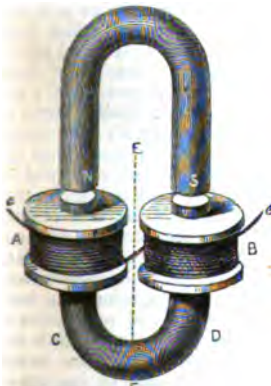

Fig. 19.

be looked upon as the armature of the magnet. CD is capable of rotation round the axis EF. So long as CD remains in the position indicated in the

figure, no currents are induced in the surrounding coils, for no change takes place in the magnetism induced in it by the action of NS. The moment that the poles of CD leave NS, the magnetism of the soft iron diminishes as its distance from NS increases; and when it stands at right angles to its former position, the magnetism has disappeared. During the first quarter-revolution, therefore, the magnetism of the soft iron diminishes, and this is attended in the coil (for both coils act, in fact, as one) by an electric current, which becomes manifest when the ends *e*, *e*, of the coil are joined by a conductor. During the second quarter-revolution, the magnetism of the armature increases till it reaches a maximum, when its poles are in a line with those of NS. A current also marks this increase, and proceeds in the same direction as before; for though the magnetism increases instead of diminishes, which of itself would reverse the induced current, the poles of the revolving armature, in consequence of their change of position with the poles of the permanent magnet, have also been reversed, and this double reversal leaves the current to move as before. For the second half-revolution the current also proceeds in one direction, but in the opposite way, corresponding to the reversed position of the armature. Thus, in one revolution of a soft iron armature in front of the poles of a permanent magnet two currents are induced in the coils encircling it, in opposite directions, each lasting half a revolution, starting from the line joining the poles.

Magneto-electric Machine.—The general construction of a simple magneto-electric machine is shewn in fig. 20. NS is a fixed permanent magnet. BB

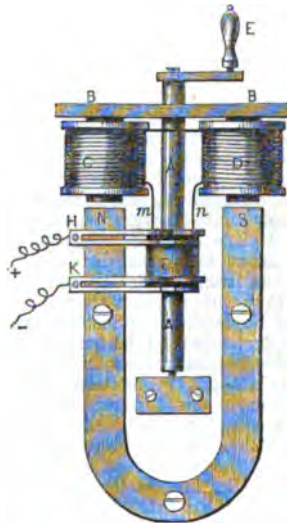

Fig. 20.

is a soft iron plate, to which are attached two cylinders of soft iron, round which the coils C and D are wound. CBBDD are thus the revolving armature, corresponding to CD in fig. 19. AA is a brass rod rigidly connected with the armature, and also serving as the rotating axle. F is a cylindrical projection on AA, and is pressed upon by two fork-like springs, H and K, which are also the poles of the machine. The ends, *m*, *n*, of the coil are soldered to two metal rings on F, insulated from each other. When the armature revolves, AA and F move with it. F, H, and K are so constructed as to act as a commutator, reversing the current at each

semi-revolution. By this arrangement, the opposite currents proceeding from the coil at each semi-revolution are transmitted to H and K in the same direction, so that these, which constitute the poles of the battery, so to speak, remain always of the same name. But for this, the effect of the current derived from one semi-revolution would be neutralised by that proceeding from the next. When the armature is made to revolve with sufficient rapidity, a very energetic and steady current is generated. Compared with the galvanic battery, the magneto-electric machine is a readier, steadier, and cleaner source of electricity, and is, in consequence, extensively used instead of it. Magneto-electric machines may be made of any strength by increasing the number of magnets and the mechanical force employed. For further information on magnetism, consult articles ARMATURE, DECLINATION NEEDLE, DIAMAGNETISM, DIPPING NEEDLE, and ROTATION, MAGNETISM OF.

MAGNIFICAT, a musical composition in the evening service of the Roman Catholic Church, and also of the Lutheran and English Churches. The words are taken from Luke i. 46—55, containing the 'song of the Virgin Mary,' which, in the Vulgate, begins with *Magnificat*. In the Roman Catholic Church, the *Magnificat* is a grand hymn, powerful in melody and harmony, mixed with pompous fugues, and with full instrumentation. In modern times, there have been few attempts in the Roman Catholic service to supersede the older music of the *Magnificat* (by Palestrina); but in the service of the Church of England, where the music is of a less elevated character, new compositions are frequently written for the *Magnificat*, by composers strictly of the English school.

MAGNOLIA, a genus of beautiful trees of the natural order *Magnoliaceae*, having a calyx of three sepals, a corolla of 6—12 petals, and carpels in spikes arranged in cones, and opening at the dorsal suture. They are natives chiefly of North America, the Himalaya Mountains, China, and Japan. The flowers are large and solitary; the leaves large. The wood is in general soft, spongy, and of little value. *M. grandiflora*, sometimes called the BIG LAUREL, has white flowers sometimes a foot in diameter. It is a lofty and magnificent evergreen tree, conspicuous at a great distance, found in the lower districts from North Carolina to the Gulf of Mexico. It succeeds well as an ornamental tree in the south of England, but in Scotland requires a wall and some protection in winter.—*M. tripetala* is found on the Alleghany Mountains, and extends as far north as lat. 43°. From the radiated manner in which its leaves are disposed at the extremities of the branches, it has received the name of UMBRELLA TREE. It has very large white flowers. It is one of the species most commonly cultivated in Britain, but in Scotland it requires a wall.—*M. acuminata* inhabits the same districts, and is a lofty tree with greenish-yellow flowers. It endures the climate of Britain well, but its flowers are not so much admired as those of some of its congeners.—*M. glauca*, a native of Pennsylvania, Virginia, and Carolina, is known by the names of WHITE BAY, BEAVERWOOD, and SWAMP SASSAFRAS. It is a tree or shrub of 15—20 feet in height, with very beautiful and fragrant white flowers.—The YULAN, or Chinese *M. (M. Yulan* or *conspicua*), has been much cultivated in China for more than twelve hundred years, on account of its beautiful and fragrant white flowers, which it produces in great profusion. It is one of the finest ornamental trees we possess, and succeeds well in the south of England, and against a wall in Scotland. It is a deciduous tree, and the flowers

expand before the development of the leaves.—*M. exoniensis*, one of the finest species known, is a predominant tree in some parts of the Himalaya Mountains, at an elevation of 7000—8000 feet, the mountains when it is in blossom appearing as sprinkled with snow.—*M. Campbellii*, another native of the same region, produces great rose-coloured flowers, and is described by Dr Hooker as the most superb of the genus.—Allied to the genus *M.* is *Michelia*, some of the species of which are amongst the most valuable timber trees of Nepal, and very ornamental. The bark of some of them is used medicinally, and the fragrant flowers of a species called Champac are the delight of the people of Hindustan. *Manglietia* is another closely allied genus, to which belong valuable timber trees of Nepal and of the Indian islands.—The natural order *Magnoliaceae* is closely allied to *Ranunculaceae*, differing chiefly in the arborescent habit, and in the large stipules which envelop the young leaves before they open, but soon fall off. The leaves are simple. Aromatic properties are prevalent. To this order belong the *Tulip Tree*, *Star Anise*, and *Winter's Bark*.

MAGNUSSEN, FINN, a distinguished scholar and archaeologist, was born in 1781 at Skabholt, in Iceland, where his family, both on his mother's and father's side, had for many generations been distinguished for learning and integrity. In 1797, M. entered the university of Copenhagen with a view of studying for the law; and although he so far fulfilled the original intention of his education as to practise this profession for some years in Iceland, his strong bent towards archaeological pursuits led him, in 1812, to return to Copenhagen, where he devoted himself with much zeal to his favourite studies under the direction of his distinguished countrymen Thorkelin and Thoriaciuss. In 1815, he obtained a chair of literature in the university; and in 1819, at the solicitation of the Academy of Fine Arts, he gave a course of lectures on ancient northern literature and mythology. From this, or even an earlier period, to the close of his life, M. devoted himself to the elucidation of these subjects with a success that was generally commensurate with the great ability and acute learning which he brought to bear upon it, although in some few instances his zeal led him to adopt too hasty conclusions. Among his earliest and most noteworthy works are his papers on the Aboriginal Home and Earliest Migrations of the Caucasian Races (1818); his contributions to northern archaeology (1820); the indices, glossaries, and lexicon which he compiled for the elucidation of the 2d and 3d of the Arne-Magnussen editions of the Eddas (1818 and 1828); his comprehensive translation of the Elder Edda (*Aldre Edda, oversat og forklaret*, Kopen. 1824); and his exposition of the same work (*Edda læren og dens Opfindelse*, Kop. 1824). Among his later works, his *Eucamo og Runerne* (Kop. 1841) has given rise to much angry discussion; and although many of his interpretations of assumed runes have been proved to be utterly untenable, the learning and acumen which he brought to bear on the subject of runes generally, have thrown great light on this branch of archaeology, both in regard to North American and ancient northern remains. In conjunction with Rafn, M. elucidated the history and antiquities of Greenland in an able work (*Grønland's Historiske Mindesmerker*, Kop. 1838—1842); and he subsequently prosecuted a similar course of inquiry in regard to Russia in *Antiquités Russes* (Cop. 1850—1852). In addition to these works, M. has annotated nearly all the most important remains of old northern literature, as the *Heimskringla*, *Habonarmal*, *Laxdela-Saga*, &c.; and besides numerous monographs on archaeological and historic subjects

of interest, has made many valuable contributions to current Icelandic literature. During his latter years, M. sat in the Danish landthing as deputy for Iceland and the Farøe Isles, in which capacity he gave evidence of considerable political knowledge and patriotic zeal. At his death, in 1847, he held the office of *Geheimarchivar* in the Royal Chamber of Archives.

MAGGO, a common Carthaginian name; no less than 14 different persons bearing it occur in history; of whom the most distinguished is M., the son of Hamilcar Barca, and a younger brother of Hannibal (q. v.) and Hasdrubal.

MAGPIE, or PIE (*Pica*), a genus of birds of the family *Corvidæ* (q. v.), differing from the true crows chiefly in the long and graduated tail. They are also of smaller size and brighter colours, the most prevalent colour being blue with bars of black and white.—The only British species is the COMMON M. (*P. caudata*), the *Kitta* of the Greeks, and *Pica* of the Romans; a common bird in Britain, and almost

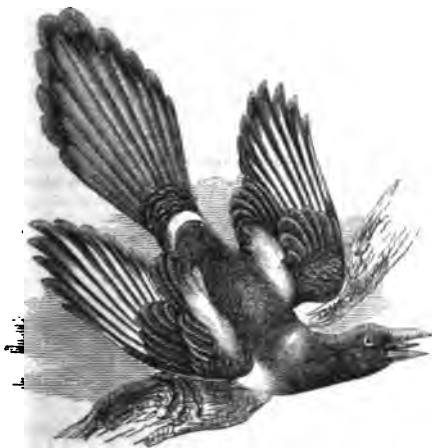

Common Magpie (*Pica caudata*).

all parts of Europe, and too well known to require particular description; its bright but not finely mingled colours—black, white, and blue—making it always conspicuous, and its dissonant harsh cry equally attracting attention. The M. is generally to be seen in pairs throughout the year. It builds its nest in high trees; the outside being formed of thorny sticks strongly interwoven, the inside plastered with earth and lined with fibres and dry grass; the top a dome, and one aperture left on the side for the parent bird. The M. is shy and vigilant in an extreme degree, notable for cunning, both in eluding enemies, and in seeking its own food, as to which it may be said that nothing comes amiss to it, grain being not unacceptable, but eggs or carrion preferable. In Britain, it is persecuted by gamekeepers; in Norway, it is encouraged in the neighbourhood of human habitations, and consequently often makes its nest under the eaves of churches and other buildings. The M. is easily tamed, becomes impudently familiar, and learns to articulate a few words. Both in a wild and tame state, it has a propensity to seize and carry off bright or glittering articles. It abounds in most parts of Europe and the North of Asia, and in the northern parts of America, but is rare in the parts of America near the Atlantic.—The other species are mostly natives of the eastern parts of Asia.

MAGYAR. See HUNGARY.

MAHĀBHĀRATA (from the Sanscrit *mahat*—changed to *mahā*—great, and *Bhārata*) is the name of one of the two great epic poems of ancient India. For the other, see the article RĀMĀYAN'A. As its main story relates to the contest between two rival families, both descendants of a king, Bharata, the word M. probably implies 'the great history of the descendants of Bharata;' for another explanation of the word, which connects it with *bhāra*, weight, was obviously invented merely to convey an idea of the enormous extent of this poem. According to this explanation, it would mean the 'very weighty (poem),' because, 'when weighed, it was found to be heavier than all the four Vedas together with their mystical writings.' However devoid of grammatical value this popular account of the word M. may be, it does not exaggerate the bulk of this epic, which, in its present condition, consists of upwards of one hundred thousand verses, each containing thirty-two syllables; while, if a tradition, reported in the introduction to the work itself, could be trusted, it was formerly known in other recensions of a still greater extent. In its actual shape, it is divided into eighteen parvas or books, the *Harivans'a* (q. v.) being considered as a supplementary part of it. That this huge composition was not the work of one single individual, but a production of successive ages, clearly results from the multifariousness of its contents, from the difference of style which characterises its various parts, and even from the contradictions which disturb its harmony. Hindu tradition ascribes it to *Vyāsa*; but as *Vyāsa* means 'the distributor or arranger,' and as the same individual is also the reputed compiler of the Vedas, Purānas, and several other works, it is obvious that no historical value can be assigned to this generic name. The contents of the M. may be distinguished into the leading story and the episodic matter connected with it. The former is probably founded on real events in the oldest history of India, though in the epic narrative it will be difficult to disentangle the reality from the fiction. The story comprises the contest of the celebrated families called the Kauravas and Pān'davas, ending in the victory of the latter, and in the establishment of their rule over the northern part of India. Kuru, a descendant of Bharata, had two sons, Dhṛitarāsh'tra and Pān'du. The sons of the former, commonly called the *Kauravas*, were a hundred in number, the eldest of them being Duryodhana; those of Pān'du—the *Pān'davas*—were five, Yudhisht'ira, Bhisma, Arjuna, and the twins Nakula and Sahadeva. Pān'du having resigned his throne, Dhṛitarāsh'tra, though blind, assumed the government, and ultimately divided his kingdom between his sons and the sons of Pān'du. The former, however, coveting the territory allotted to the Pān'du princes, endeavoured to get possession of it. A game of dice was the means by which they bound over their cousins to relinquish their kingdom, promising, however, to restore it to them if they passed twelve years in the forests, and a thirteenth year in such disguises as to escape detection. This promise was faithfully kept by the Pān'davas; but the term of their banishment having expired, the Kuru princes refused to redeem their word. A war ensued, ending in the complete destruction of the Kauravas. These are the meagre outlines of the leading story of the M., where, as may be inferred, Duryodhana and his brothers are pictured as the type of all conceivable wickedness, and the Pān'du princes as paragons of virtue and heroism. That the latter are the incarnations of sundry deities—that the gods take an active part in the development of the plot, in short, that Hindu mythology is always interwoven with

these stirring events of semi-historical Hindu antiquity, requires no further remark to any one but slightly acquainted with Hindu poetry. It is necessary, however, to observe that out of the one hundred thousand verses which constitute the great epos, barely a fourth part is taken up by this narrative; all the rest is episodal. The matter thus, as it were, incidentally linked with the main story, may be distributed under three principal heads, passing over such minor additions as fables, genealogical lists, geographical enumerations, and the like. One category of such episodes comprises narratives relating to the ancient or mythical history of India, as, for instance, the episodes of Nala and S'akuntalā; a second is more strictly mythological, comprising cosmogony and theogony; a third is didactic or dogmatic—it refers to law, religion, morals, and philosophy, as in the case of the celebrated Bhagavadgītā, and the principal portions of the 12th and 13th books. By means of this episodal matter, which at various periods, and often without regard to consistency, was superadded to the original structure of the work, the M. gradually became a collection of all that was needed to be known by an educated Hindu; in fact, it became the encyclopædia of India. 'There is no narrative on earth,' the M. says of itself, 'that is not founded on this epos. . . . The twice-born, though knowing the four Vedas and their supplementary sciences, has no wisdom unless he knows this great epos. . . . It is the great manual of all that is moral, useful, and agreeable.' Yet it should be noticed that the Brahmanic authors of the great epos intended it especially as an encyclopædia for the Kahatriya or military caste; for it is chiefly the history, the interests, the religion, and the duties of the second caste which are taught in it, always, of course, with a view of establishing the superiority of the Brahmanic caste. Sectarian religion is for this reason not emphasised in the M., though the later sectarian works (see PURĀNA) have largely drawn, for their purposes, on the mythological material afforded them by the great epic work. The text of the M. has been published in Calcutta in four quarto volumes (1834—1839), to which is added a fifth volume, containing a table of contents. Two other editions are in the course of publication at Bombay. The best researches on the M. are those by Lassen, in his *Zeitschrift für die Kunde des Morgenlandes* (1837, ff.), and in his *Indische Alterthumskunde*. A sort of analysis of the leading story of the M. (not of the episodes) has lately been given by F. G. Eichhoff (*Poésie Hérotique des Indiens*, Paris, 1860), and by Professor Monier Williams (*Indian Epic Poetry*, London, 1863).

MAHĀDEVA ('the great god') is one of the usual names by which the Hindu god S'iva is called. (His consort, Durgā, is similarly styled *Mahādevī*, 'the great goddess.') In Buddhist history, M., who lived 200 years after the death of the Buddha S'ākyamuni, or 343, is a renowned teacher who caused a schism in the Buddhist Church. His adversaries accuse him of every possible crime, but as he is ranked amongst the Arhats, his eminence cannot be matter of doubt. The school founded by him is called *Pāras'aila*. See W. Wassiljew, *Der Buddhismus*, &c. (St Petersburg, 1860).

MAHĀKĀSYAPA, one of the most renowned disciples of the Buddha S'ākyamuni. He arranged metaphysically the portion of the sacred writings of the Buddhists called Abhidharma; and tradition ascribes to him also the origin of the *Sthavira* division of the *Vaiśhāhika* school of Buddhist philosophy. Many legends are connected with his

life.—See E. Burnouf, *Introduction à l'Histoire du Bouddhisme Indien* (Paris, 1844), and his posthumous work, *Le Lotus de la Bonne Loi* (Paris, 1852).

MAHĀNNU'DDY (more accurately, MAHĀN-ADI), a river of India, rises on the south-west border of the presidency of Bengal, in lat. 20° 20' N., long. 82° E. After an eastward course of 520 miles, 300 miles of which are navigable, having divided into several branches at the town of Cuttack, which forms the head of its delta, it flows east and south-east through the district of that name, and falls by several mouths into the Bay of Bengal.

MAHĀSĀNGHIKA is the name of one of the two great divisions of the Buddhist Church which arose about 200 years after the death of the Buddha S'ākyamuni, or about 343, caused, as it seems, by the schism of Mahādeva (q. v.). For the other division, see *STHAVIRA*. Out of the M. school arose, in the course of the next centuries, numerous sects. For the tenets common to all, and for those peculiar to each of these sects, the special student of the Buddhist religion will at present most advantageously consult the work of Professor W. Wassiljew, *Der Buddhismus, seine Dogmen, Geschichte und Literatur* (St Petersburg, 1860).

MAHĀVANSA is the title of two celebrated works written in Pāli, and relating to the history of Lanka, or Ceylon (q. v.), from its earliest period down to the reign of Mahāsena, who died 302 after Christ. The older work was probably composed by the monks of the convent Uttaravihāra at Anurādhāpura, the capital of Ceylon. Its date is uncertain; but it has apparently preceded the reign of Dhātusena (459—477), as that monarch ordered it to be read in public, a circumstance which seems to prove the celebrity it enjoyed already at his time.—The later work of the same name is an improved edition and continuation of the former. Its author, *Mahānāma*, was the son of an aunt of the king Dhātusena, and he brings down the history of Ceylon, like his predecessor, to the death of Mahāsena. A first volume of the text of the latter work, 'in Roman characters, with a translation subjoined, and an introductory essay on Pāli Buddhist literature,' was published by the Hon. George Turnour (Ceylon, 1837). See also Lassen, *Indische Alterthumskunde*, vol. ii. p. 15, ff. (Bonn, 1852).

MAHĀVĪRA (literally, 'the great hero'), also called *Vīra* and *Vardhamāna*, is the 24th or last Jina, or deified saint, of the Jainas (q. v.), described as of a golden complexion, and having a lion for his symbol. His legendary history is given in the *Kalpa-Sūtra* (q. v.) and the *Mahāvīra-Charitra*, two works held in great authority by the Jainas. According to these works, M.'s first birth occurred at a period infinitely remote; it was as Nayasāra, head man of a village, that he first appeared in the country of Vijaya, subject to S'atrumardana. He was next born as *Marichi*, the grandson of the first Jaina saint *P'ishabha*; he then came to the world of Brahmā, was reborn as a worldly-minded Brāhman'a, and after several other births—each being separated from the other by an interval passed in one of the Jaina heavens, and each period of life extending to many hundreds of thousands of years—he quitted the state of a deity to obtain immortality as a saint, and was incarnate towards the close of the fourth age (now past), when 75 years and 8½ months of it remained. After he was 30 years of age, he renounced worldly pursuits, and departed, amidst the applauses of gods and men, to practise austerities. Finally, he became an Arhat or Jina; and at the age of 72 years, the period of his liberation having arrived, 'he resigned his breath,' and his body was

burned by Indra and other deities, who divided amongst them such parts as were not destroyed by the flames, as the teeth and bones, which they preserved as relics; the ashes of the pile were distributed amongst the assistants: the gods erected a splendid monument on the spot, and then returned to their respective heavens. At what period these events occurred is not stated, but judging from some of the circumstances narrated, the last Jina expired about five hundred years before the Christian era. Other authorities make the date of this event about a century and a half earlier. The works above referred to state, with considerable detail, the conversions worked by Mahāvira. Among the pupils were *Indrabhūti* (also called Gautama, and for this reason, but erroneously, considered as the same with the founder of the Buddhist religion), *Agnibhūti*, *Vāyubhūti*—all three sons of Vasubhūti, a Brahman's of the Gotama tribe, and others. These converts to Jaina principles are mostly made in the same manner: each comes to the saint prepared to overwhelm him with shame, when he salutes them mildly, and, as the Jains hold, solves their metaphysical or religious doubts. Thus, *Indrabhūti* doubts whether there be a living principle or not; *Vāyubhūti* doubts if life be not body; *Man'dita* has not made up his mind on the subjects of bondage and liberation; *Achalabhātrī* is sceptical as to the distinction between vice and virtue; and so on. M. removes all their difficulties, and by teaching them the Jaina truth, converts them to the doctrine of his sect. For a summary account of the life of this saint, see H. T. Colebrooke's *Miscellaneous Essays*, vol. ii. p. 213, ff.; H. H. Wilson's works, vol. i. p. 291, ff.

MAHMUD II., Sultan of Turkey, and younger son of Sultan Abdul-Hamid, was born 20th July 1785, and on the deposition of his brother, Mustafa IV., by Bairaktar, Pasha of Ruschuk, was raised to the throne, July 28, 1808. Bairaktar became his grand vizier, and vigorously aided him in his attempts to reform the constitution of the Turkish army. But the Janizaries, emboldened by their successful opposition to the same attempt on the part of Selim III., rose in rebellion, and the murder of the vizier put a stop for the present to the carrying out of any military reforms. M. was also attacked by the rebels, but he secured his life and throne by the destruction of all the other members of the royal House of Osman. The war with Russia now commenced vigorously; but after a conflict of three years' duration, which completely prostrated the strength of Turkey, peace was concluded at Bucharest (q. v.). The daring and energetic M. now applied himself to the subjugation of the semi-independent pashas of the outlying provinces, and to the promotion of radical reforms in all departments of the government. The rebellion of the Wahabis was crushed through the instrumentality of Ibrahim Pasha in 1818, and Ali Pasha (q. v.), the 'Lion of Janina,' was overthrown in 1822. Greece revolted in 1821, and its independence was secured by the battle of Navarino in 1827, but it was not recognised as a separate kingdom by Turkey till April 1830. During the progress of the Greek revolution, M. had been steadily though secretly maturing his plans of military reform, and in May 1826 the success of his schemes was crowned by the destruction of the Janizaries (q. v.). The consequent confusion into which Turkey was thrown was immediately taken advantage of by Russia for obtaining fresh concessions. M., however, despite these interruptions, proceeded with iron resolution in those plans of reform which he judged essential to the stability of the empire; and the disastrous termination of the succeeding war with Russia (1828—1829), far from

interfering with his projects, only stimulated him to renewed exertion. The successful revolt of the Greeks, and the late triumph of the Russians, together with the disaffection manifested by the Christian population of Turkey, excited in the ambitious mind of Mehemed Ali, pasha of Egypt, the desire for independence. See **MEHMED ALLI**. The war which ensued was from first to last in favour of the Egyptians; but the intervention of Russia compelled both parties to agree to a treaty (1833) which was satisfactory to neither. M. was now forced to grant fresh concessions to his 'good friend and ally,' the Czar, by the treaty of Unkiar-Skelessi (q. v.), July 8, 1833, and by another treaty in the following year. He was again at liberty to pursue his reforms in the civil administration, the principal improvements being the modification and readjustment of the more oppressive taxes, the formation of a militia on the principle adopted by England, the establishment of schools of anatomy and painting, increased privileges to Frankish merchants, and the abolition of the export duty on grain, measures of sound policy, which tended largely to consolidate the new-born prosperity of Turkey. In 1838, he concluded with Great Britain a commercial treaty, which both strengthened the connection between the two nations and advanced their mercantile interests. In 1839, he renewed the war with Mehemed Ali, but died before its conclusion, 1st July 1839, after an eventful reign of 31 years.

MAHOGANY, the wood of the trunk of the *Swietenia mahagoni*, a tree of 80—100 feet high, belonging to the natural order *Cedrelaceae*, a native of the West Indies and of South America. It has pinnate leaves with 3—5 pair of leaflets, and panicles of small whitish or yellow flowers, the stamens united into a tube which is toothed at the summit, and set round on the inside with 8—10 anthers. The capsule is 5-celled, about the size of a man's fist, hard, woody, and oval, and the seeds are winged at the apex. It attains an immense size, second to few others, and its timber is generally sound throughout in the largest trees. The slow progress which it is observed to make, clearly indicates that the trees which are cut for use must have attained a great age: 200 years has been assumed as an approximation. It is most abundant on the coast of Honduras and around Campeachy Bay, whence the greater portion of that used in Europe is exported. St Domingo and Cuba also yield a considerable quantity, which is of a finer quality than that obtained from the mainland, which is frequently called Bay Wood, to distinguish it from the Cuba mahogany, usually called Spanish. The occupation of cutting this timber and removing it to the coast for shipment, is exceedingly laborious, and employs a large number of men and oxen. The wood varies much in value, according to the colour and beauty of curl; single logs have occasionally realised as much as £1000, for cutting into veneers, in which state it is very generally used, its great weight and value unfitting it for being always employed solid. It was first introduced into this country by accident in 1597, having been used to repair one of Sir Walter Raleigh's ships at Trinidad; but although the wood so employed was much admired, it did not become an article of commerce until rather more than a century later, when another accidental circumstance brought it into demand, and it became an article of luxury, and has since maintained the highest position as a cabinet-maker's wood. The annual imports into Britain are over 50,000 tons, exceeding half a million sterling in value. The bark has a faint aromatic smell, and a very astringent bitter taste, and in the countries where the

tree grows, is used as a medicine. In England, it has been recommended and used under the name *Mahogany Bark*, or *Amaranth Bark*, as a substitute for Peruvian Bark.—EAST INDIA MAHOGANY is the timber of the *Rohena Tree* (*Soymsida febrifuga*), and AFRICAN MAHOGANY of the *Khaya Senegalensis*, both of the order *Cedrelaceæ*.

MAHONIA. See **BARBERRY**.

MAHRA'TTAS, a people of Hindu race, inhabiting Central India, south of the Ganges, from Gwalior to Goa, and supposed by many to be the descendants of a Persian or North Indian people, who had been driven southwards by the Mongols. They are first mentioned in history about the middle of the 17th c., when they possessed a narrow strip of territory on the west side of the peninsula, extending from 15° to 21° N. lat. The founder of the Mahratta power was Sevaji, a freebooter or adventurer, whose father was an officer in the service of the last king of Bejapûr. By policy or by force, he eventually succeeded in compelling the several independent chiefs to acknowledge him as their leader, and with the large army then at his command, overran and subdued a large portion of the emperor of Delhi's territory. His son and (1680) successor, Sambaji, after vigorously following out his father's policy, was taken prisoner by Aurungzebe in 1689, and put to death. The incapacity of the subsequent rulers who reigned under the title of *Ramrajah* ('great king'), tempted the two chief officers of state, the *Peishwa*, or prime minister, and the Paymaster-general, to divide the empire between them. This was effected about 1749, the former fixing his residence at Poona, and retaining a nominal supremacy over the whole nation of the M.; while the latter made Nagpûr his capital, and founded the empire of the Berar Mahrattas. This paction, of course, required the sanction of the more important among the minor chiefs and officers of state, who gave their consent on condition of receiving a share of the spoil. The ultimate result was the partition of the Mahratta kingdom into a great number of states, more or less powerful and independent; chief among which were, besides the two above mentioned, Gwalior, ruled by the Rao Scindia; Indore, by the Rao Holkar; and Baroda, by the Guicowar. It was to be expected that the usual intestine wars would supervene, and ultimately the East India Company was compelled to interfere. The invasion of the Delhi empire by Nadir Shah afforded these wild and warlike mountaineers an opportunity, of which they eagerly availed themselves, to wrest additional territory from the feeble grasp of the Mogul emperor. From this time they discharged the office of arbiters in the quarrels between the emperor, his vizier, and his rebellious subjects; but the frightful defeat (January 1761) they sustained at the hands of Ahmed Shah Abdali, the ruler of Afghanistan, on the field of Paniput, where they lost 50,000 men, and all their chiefs except Holkar, weakened their power for a time. They still, however, continued to be the hired mercenaries of the Delhi emperor, till the growing influence of the British compelled them to look to their own safety. After many long and bloody contests with the British and their allies, in which sometimes the whole, but more frequently a portion of the M. joined, they were one by one, with the exception of Scindiah, reduced to a state of dependence. This last-mentioned chief, having raised a powerful army, officered by Frenchmen, and disciplined after the European method, continued the contest for a number of years, till his power was finally broken in 1843. The dignity of Peishwa was abolished in 1818, and his territories were occupied by the British, with

the exception of a portion which was made over to another Mahratta chief, the Rajah of Sattara, their faithful ally; Nagpûr and Sattara subsequently reverted to the British government, but the other chiefs still possess extensive dominions, under British protection.

The M. are a vigorous and active race, and though diminutive and ill-formed, are distinguished for their courage. They are of a cruel and perfidious disposition, and have exercised a most disastrous influence upon the inhabitants of the countries they have conquered. Though devout worshippers of Brahma, no distinctions of caste exist among them.

MAI, ANGELO, CARDINAL, a distinguished editor and scholar, was born in the village of Schilpario, in Lombardy, March 7, 1782. He was educated and lived till 1806 in establishments belonging to the Jesuits; but obtained an appointment, first as associate, and ultimately as doctor, in the celebrated Ambrosian Library at Milan. His career as an author dates from this appointment. In 1813, he published a translation and commentary of Isocrates, *De Permutatione*; but his reputation is due much more to his publications of the palimpsests or re-written manuscripts, the first specimens of which he issued at Milan (see **PALIMPSEST**). His earliest publications in that line were fragments of *Cicero's Orations*; of the *Vitularia*, a lost play of Plautus; of *Letters of Fronto*, Marcus Aurelius's preceptor; the *Chronicon* of Eusebius, and other less important works, which, however, were entirely eclipsed by his well-known edition and restoration of the *De Republica* of Cicero, published in 1820. Meanwhile, M. had been invited to Rome by Pius VII., and named to the charge of the Vatican Library, together with other honourable and emolumentary appointments. He at once turned his attention to the unedited MSS. of the Vatican, and after a short examination of this noble collection, undertook, as the mission of his life, the task of publishing those among them which had been overlooked by earlier editors, or had escaped their notice. This task he steadily pursued; and although he was appointed, in 1833, to the onerous office of Secretary of the Propaganda, and, in 1838, to the cardinalate itself, his Roman publications form a collection of an extent and importance almost unexampled in modern times. His first series was in ten 4to vols., entitled *Scriptorum Veterum Nova Collectio, e Vaticanis Codicibus edita* (Rome, 1825). It consists, like the great collections of Mabillon, Montfaucon, D'Achery, and others, of miscellaneous unpublished works, partly sacred, partly profane, and indifferently in the Greek and the Latin languages, comprising an entire volume of palimpsest fragments of the Greek historians, Polybius, Diodorus, Dion, Dionysius, and others. The succeeding collections, viz. *Classici Auctores ex Codicibus Vaticanis* (10 vols. 8vo, 1838), *Spicilegium Romanum* (10 vols. 8vo, 1839—1844), and *Nova Patrum Bibliotheca* (6 vols. 4to, 1853), are all on the same plan, and all equally replete with new and interesting materials. For many years, too, he was engaged in preparing an edition of the celebrated *Codex Vaticanus*, which he had printed, but the publication of which was postponed, awaiting the preparation of his intended preliminary dissertations. He died, however, rather unexpectedly, at Albano, September 3, 1854; and as no trace of the expected preliminary matter was found among his papers, the edition was published (1857) entirely without critical matter. It has, in consequence, disappointed expectation. His library, which he directed to be sold for the use of the poor of his native village, was purchased by the pope for the Vatican Library.

MAIDEN, THE, a name given to a machine for beheading criminals, which was in use in Scotland from about the middle of the 16th c. to nearly the end of the 17th century. It is said to have been introduced into Scotland by the Regent Morton, who had seen it at Halifax, in Yorkshire, and was himself the first to suffer by it, whence the proverb, 'He that invented the Maiden first handselled it.' Morton, for anything that is known to the contrary, may have introduced the Maiden; but he certainly was not its first victim. Fifteen years before he was put to death by it (1581 A. D.), it was employed to behead Thomas Scott of Cambus-michael, one of the murderers of Riccio (1566 A. D.). It would seem at first to have been called indifferently 'The Maiden' and 'The Widow'—both names, it may be conjectured, having their origin in some such pleasantry as was glanced at by one of the Maiden's last victims, the Earl of Argyle (1681 A. D.), when he protested that it was 'the sweetest maiden he had ever kissed.' A frightful instrument of punishment used in Germany in the middle ages was called 'The Virgin.' But it had no resemblance to the Maiden, which was exactly like the French Guillotine (q. v.), except that it had no turning-plank on which to bind the criminal. The Maiden which was used in the Scottish capital is now in the Museum of the Antiquaries of Scotland at Edinburgh. A figure of it is given in the article GUILLOTINE.

MAIDENHAIR (*Adiantum Capillus-Veneris*), a small, delicate, and graceful fern, with bipinnate fronds, alternate obovate and wedge-shaped membranaceous pinnules on capillary stalks, and marginal sori hidden beneath oblong *indusia*; growing on moist rocks and old walls, especially near the sea; rare in Britain, but very abundant in the south of Europe, where it covers the inside of wells and the basins of fountains (as at Vaulcluse) with a tapestry of the most delicate green. Another



True Maidenhair (*Adiantum Capillus-Veneris*).

species of the same genus, *A. pedatum*, a native of North America, with *pedate* leaves, has a sweet, fragrant root-stock, of which *Capillaire* (q. v.) is made. It is supposed that the name *M.* originated in the use of a mucilage made from this fern by women for stiffening their hair. This name is sometimes applied also to some species of Spleenwort (*Asplenium*), as *A. adiantum nigrum* and *A. trichomanes*.

MA'IDENHEAD, a municipal borough and market-town of England, in the county of Berks, is

situated amid beautiful scenery, on the right bank of the Thames, 26 miles west of London. It carries on some trade in meal, malt, and timber, and has a large brewery. Pop. (1861) 3895.

MAIDS OF HONOUR. See **LADIES OF THE QUEEN'S HOUSEHOLD.**

MAIDSTONE (old form, *Medwegston*), the county town of Kent, England, on the right bank of the Medway, 43 miles from London by the South-eastern Railway. It is a municipal and parliamentary borough, and returns two members to parliament. It stands in a noted corn-district; its grain-market is the most important in the county; and in the vicinity are the famous hop-grounds known as 'the middle growth of Kent.' The parish church, built toward the close of the 14th c., in the perpendicular style, contains many interesting tombs. The remains of the College or Hospital of All-Saints, which grew out of a hospital founded in 1260 at the entrance of the town for the benefit of pilgrims travelling to Canterbury, are highly picturesque. *M.* has numerous educational and other institutions. An extensive oil, and several paper mills, hat and blanket manufactories, and several breweries, are in operation. Pop. of parliamentary borough (1861), 23,058.

MAI'GRE (*Sciaena aquila*), a fish of the acanthopterous family *Sciaenidae*, common in the Mediterranean Sea, but a rare visitant of the British shores. It attains a large size, being seldom taken less than three feet, whilst it is sometimes six feet long. In general appearance, it much resembles a large basse, but the head is shorter and more rounded, and the tongue and roof of the mouth are destitute of teeth. The *M.*

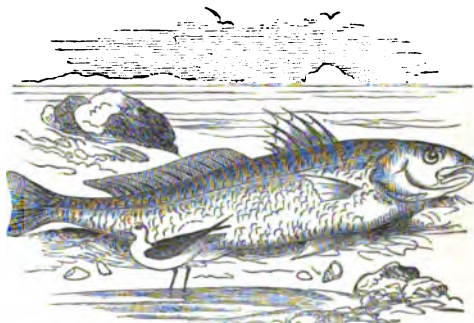

Maigre (*Sciaena aquila*).

is in very high esteem for the table, and the head is a favourite delicacy of epicures. The strength of the *M.* is such that a stroke of its tail will throw down a man; and when it is taken, the fishermen therefore quickly stun it by a blow on the head. It is one of those fishes which emit a peculiar sound, which has been described as a kind of purring or buzzing, and has been heard from a depth of 120 feet. Fishermen have been guided by this sound to let down their nets so as to enclose a number of maigres. The *M.* appears to be the *umbrina* of the Romans, and was highly esteemed by them. The stones of its ears were formerly set in gold, and worn on the neck, imaginary virtues being ascribed to them, particularly in the cure of colic; but it was requisite that they should be obtained as a gift, and not by purchase.

MAIL (Fr. *maille*, It. *maglia*; from the Lat. *macula*, a spot, hole, or mesh of a net) signifies a metal net-work, and is ordinarily applied to such net-work when used as body defensive armour. Well-made mail formed an admirable defence against all

weapons except firearms, and its pliability and comparative lightness gave it favour over the more cumbersome plate-armour.

MAILED CHEEKS (*Sclerogenida* or *Triglidæ*), a family of acanthopterous fishes, distinguishingly characterised by an enlargement of certain bones of the head and gill-covers to form a bony armour for the cheeks. They exhibit great variety of forms; some of them are remarkable for their elegance and for their delicate or splendid hues, others for their extreme ugliness. Gurnards (q. v.) are among the best known and most valuable of this family. To it belong also Bull-heads (q. v.) and *Scorpenas* (q. v.). Sticklebacks (q. v.) are sometimes referred to it. The species are widely distributed in the seas of all parts of the world; a few inhabit lakes and rivers.

MAIMATCH'IN, a trading town on the northern boundary of Mongolia, opposite Kiahta (q. v.).

MAIMING is the shooting, stabbing, or otherwise seriously injuring of a person, and therefore, when treated as a criminal offence, properly belongs to the heads of Assault, Attempt to Murder, and offences against the person generally. Maiming cattle is classed under the head of Malicious Injuries to Property.

MAIMONIDES, or rather **MOSES BEN MAIMON** (**RAMBAM**—**RABBI MOSES BEN MAIMON**) B. **JOSEPH B. ISAAC B. JOSEPH B. OBADJAH**, &c.; Arab. **ABEN AMRAN** (**AMRU**) **MUSA IBN ABDALLAH IBN MAIMON AL-KORTOBI**, was born at Cordova, March 30, 1135. Little is known of his early life, which fell in the troublous period of the Moravide rulers. His first instruction he received at the hand of his father, himself a learned man, and author of several important works in Arabic and Hebrew. Under the guidance of the most distinguished Arabic masters of the time, M. then devoted himself to the study of Greek (Aristotelian) philosophy, the science of medicine, and theology. When, in 1148, Abd-al-Mumen, the successor of Abdallah, in the newly established reign of the Al-Mohads (Unitarians), took Cordova, and, shortly afterwards, subjected all Andalusia, both Jews and Christians residing there were forced either to profess Islam or to emigrate. M.'s family, however, together with many others to whom emigration was well-nigh impossible, outwardly embraced the Mohammedan faith, or rather for the time being renounced the public profession of Judaism, all the while remaining faithful to it in secret, and keeping up a close communication with their co-religionists abroad, an arrangement in which the government readily acquiesced, since it fully answered their purpose. For more than 16 years, M. thus lived together with his whole family under the assumed character of Mohammedans; but when the death of the reigning sovereign brought no change in the system of religious intolerance, they resolved to emigrate. In 1165, they embarked, went to Acco, and, by way of Jerusalem, to Cairo, where M.'s father died. M. settled in Fostât (Old Cairo), where for some time he gained his livelihood by the jewel-trade, until his great medical knowledge procured him the high office of physician to Salah Eddin, the reigning sultan of Egypt. M.'s importance for the religion and science of Judaism, and his influence upon their development, is so gigantic, that he has rightly been placed second to Moses, the great lawgiver, himself. He first of all brought order into those almost boundless receptacles of tradition, and the discussions and decisions to which they had given rise, which, without the remotest attempt at system or method, lie scattered up and down the works

of Haggada and Halacha—Midrash, Mishnah, Talmuda. Imbued with the spirit of lucid Greek speculation, and the precision of logical thought of the Arabic Peripatetics, M., aided by an enormous knowledge, became the founder of rational Scriptural exegesis. The Bible, and all its written as well as implied precepts, he endeavoured to explain by the light of reason, with which, as the highest divine gift in man, nothing really divine could, according to his theory, stand in real contradiction. The miracles themselves, though not always traceable to their immediate cause, yet cannot be wrought in opposition to the physical and everlasting laws in nature. Where literal interpretation seems to jar upon the feelings of reverential awe towards the Highest Being, there an allegorical explanation is to be adopted unhesitatingly. Respecting M.'s philosophical system, we can barely hint in this place at its close similarity with that of Averroes; both drawing from the same classical sources, and arriving independently, and with individual modifications, to nearly the same views on the great problems of the universe. Holding reason in man—if properly developed and tutored by divine revelation—to be the great touchstone for the right or wrong of individual deeds, M. fully allows the freedom of will, and while he urges the necessity, nay, the merit of listening, to a certain degree, to the promptings of nature, he rigorously condemns a life of idle asceticism, and dreamy, albeit pious contemplation. No less is it, according to him, right and praiseworthy to pay the utmost attention to the healthy and vigorous development of the body and the care of its preservation by the closest application to hygienic rules. Providence, M. holds, reigns in a certain—broad—manner over humanity, and holds the sway over the destinies of nations; but he utterly denies its working in the single event that may befall the individual, who, subject above all to the great physical laws, must learn to understand and obey them, and to shape his mode of life and action in accordance with existing conditions and circumstances—the study of natural science and medicine being therefore a thing almost of necessity to everybody. The soul, and the soul only, is immortal, and the reward of virtue consists in its—strictly unbodily—bliss in a world to come; while the punishment of vice is the 'loss of the soul.'

M.'s first work of paramount import (several of his earlier minor writings treat of subjects of general science), begun in his twenty-third year, and finished ten years later, is his Arabic commentary of the Mishnah [translated into Hebrew by Judah Alcharisi, Tibbon (father and son), Sal. ben Jacob, Net. Almâli, Jak. Akkasi, and others], which forms an extensive historical introduction to *Tradition*, or the Oral Law: tracing its development, its divisions, the plan of the Mishnah, and its complements, &c.; and this introduction has now, for more than five hundred years, been deemed so essential a part of the Talmud itself, that no edition of the latter is considered complete without it. This was followed by the *Sefer Hamizwoth*, or Book of the Precepts, in Arabic (translated into Hebrew by Abr. Ibn Chasdai, and, from the author's second edition, by Moses Tibbon), which contains an enumeration of the 613 traditional laws of the Halacha, together with fourteen canons on the principle of numbering them, chiefly directed against the authors of certain liturgical pieces called *Asharoth* (Warnings); besides thirteen articles of belief, and a psychological fragment. This book is to be considered chiefly as an introduction to the gigantic work which followed in 1180, under the title of *Mishne Thorah* (Second

Law), or *Yad Chasabak* (Strong Hand), a Hebrew compendium in 982 chapters, embracing the entire Halacha, even those of its parts no longer in practical use, such as precepts regarding the soil of Judaea and the like, and which, with the most astounding minuteness, lucidity, and precision, places the results of the legal disquisitions gathered from the Talmudical labyrinth systematically arranged before the reader. The summit of his renown, however, M. reached in his grand Arabic work, *Delalath Al-Hairin* (Heb. Moreh Nebuchim, 'Guide of the Erring'), a philosophical exegesis (translated into Hebrew by Samuel Tibbon, edited for the first time in the original by Munk, 1856, &c.), which, while on the one hand it has contributed more than any other work to the progress of rational development in Judaism, has on the other hand also become the arena for a long and bitter fight between orthodoxy and science—carrying out, as it did, to its last consequences the broad principle, that 'the Bible must be explained metaphorically by established fundamental truths in accordance with rational conclusions.' So bitter, indeed, was the contest which broke out between the subsequent spiritualistic Maimonidian and the 'literal Talmudistic' schools, that the fierce invectives were speedily followed by anathemas and counter-anathemas issued by both camps; and finally, about the middle of the 13th c., the decision was transferred into the hands of the Christian authorities, who commenced by burning M.'s books, continued by bringing to the stake all Hebrew books on which they could lay their hands, and followed this decision up by a wholesale slaughter of thousands upon thousands of Jews, men, women, and children, irrespective of their philosophical views. Under these circumstances, the antagonistic parties, chiefly through the influence of David Kimchi and others, came to a reconciliation, and withdrew their mutual anathemas; and, as time wore on, M.'s name became the pride and glory of the nation, who bestowed upon him terms like the 'Great Eagle,' the 'Light of Two Worlds,' &c. Nor was his immense celebrity confined to the narrow pale of his own creed; as early as the 13th c. already, portions of his works, chiefly the *Moreh* (Doctor Perplexorum), became, in Latin versions, the text-books of European universities.

M. himself only witnessed the beginning of the conflict, the proportions and violence of which he certainly never anticipated. At his death, which took place December 13, 1204, the grief at the loss of the 'Light of the Age' was universal in the East as well as in the West. And he has ever since been recognised universally as one of the noblest and grandest men of all times: gifted with the most powerful and brilliant qualities of mind, possessed of the most varied and astounding knowledge, and imbued with deep piety and true religion, borne aloft by undaunted energy and glowing zeal. His body was brought to Tiberias, and his tomb became a place of pilgrimage, even to his early foes.

Of M.'s smaller works, we may enumerate, in conclusion, a translation of Avicenna's *Canon*; an extract from Galen; several medical, mathematical, logical, and other treatises, spoken of with the highest praise by Arabic writers; legal decisions, theological disquisitions, &c. Portions of his great work, *Moreh*, have lately been translated into modern European languages, chiefly into German (Scheyer) and French (Munk).

MAIN (from the Latin *magnus*, great), the name applied on shipboard to the principal mast, and to all the parts belonging or adjacent to it—as, main-topmast, main-yard, main-stay, main-shrouds, main-hatchway, main-chains, &c.

MAIN, a river of Germany, the largest affluent the Rhine receives from the right, is formed by the union of two branches, the White and Red M., four miles below Kulmbach, in Bavaria. The more important of these, the White M., rises in the Fichtelgebirge, 2800 feet above sea-level. The M. has a winding westward course 300 miles in length, to the Rhine, into which it falls at Mainz. It is navigable for the last 220 miles. The principal towns on its banks are Schweinfurt, Würzburg, Aschaffenburg, Offenbach, and Frankfurt; and its chief affluents are, on the right, the Saale, and on the left, the Regnitz. The M. is one of the most picturesque of German rivers; it flows through a beautiful country, where the hill-slopes are frequently covered with vineyards, and surmounted by castles. Its waters communicate with those of the Danube by means of the Ludwigs-Kanal. See **BAVARIA**.

MAINE, one of the ancient provinces of France, immediately south of Normandy, corresponds to the modern departments of Sarthe and Mayenne. Its chief town was Le Mans, now the capital of the department of Sarthe.

MAINE, the most eastern of the five New England states in America, extends from lat. 42° 57' to 47° 32' N., and from long. 66° 52' to 71° 6' W., being 303 miles from north to south, and 212 from east to west, with an area of 31,766 square miles, or 20,330,240 acres. M. is bounded N. by Canada, E. by New Brunswick, S. by the Atlantic Ocean, and W. by New Hampshire and Canada. It has, on the south, a coast-line of 278 miles in a line, but so indented with bays as to make 2486 miles. The largest of these bays are the Penobscot, Machias, Saco, Passamaquoddy, &c. Into these empty the rivers Penobscot, Kennebec, Saco, Androscoggin, &c. Numerous islands stud the coast: the largest, Mount Desert, remarkable for its scenery, contains 60,000 acres. In the northern portions of the state are numerous lakes; the largest, Moosehead, being 35 miles long, and the source of the Kennebec River. The country is hilly, with a range of mountains stretching north-east from the White Mountains of New Hampshire; Mount Katahdin, near the centre of the state, is 5000 feet high. On the coast are fine granite quarries; interior, metamorphic rocks and minerals, limestone and argillaceous slates. The climate ranges from 20° or 30° below to 100° above zero. The forests are rich in pine, spruce, hemlock, maple, &c., and the chief agricultural products, wheat, rye, Indian corn, apples, and pears. The rivers and coast abound in fish. One of the chief exports is lumber; and one-third of all the ships of America are built on the rivers and harbours of this state. The falls of the rivers furnish immense water-power for saw-mills and factories. M. has 600 miles of railway, 68 banks, 4500 public schools, 3 colleges, 1200 churches, and 49 periodical publications. The government consists of a governor, senate, and house of representatives, elected by universal suffrage. M. was settled in 1621, and was a part of Massachusetts until 1820. In its early history it is said that every 20th settler was killed by the Indians. A controversy respecting the north-eastern boundary of M., which threatened to produce war with England, was settled by a compromise of claims in 1842. The chief towns are Portland, Augusta, the capital, Bangor, Bath, Hallowell, &c. Pop. in 1820, 298,335; in 1860, 628,276.

MAINE-ET-LOIRE, an inland department of France, forming a portion of the lower basin of the Loire, is bounded on the W. by the department of Loire-Inférieure, and on the E. by that of Indre-et-Loire. Area, 1,760,874 square acres, of which

1,067,634 acres are arable, 197,748 in meadow, and 95,435 in vineyards. Pop. (1862) 526,012. The surface is gently undulating. The soil is fertile, producing the usual crops, white and green, and a variety of excellent fruits. Wines, red and white, the latter comprising several highly esteemed varieties, are extensively cultivated; 11,000,000 gallons are made annually. Iron and coal mines are worked; and there are numerous mills and factories for the production of cotton, woollen, and linen goods. The department is divided into the five arrondissements of Angers, Baugé, Segré, Beaupréau, and Saumur. Capital, Angers.

MAÏNOTES, the inhabitants of the mountainous district of Maina, a peninsula between the bays of Kolokythia and Koron, forming part of the province of Laconia, in Greece. They have been regarded as the descendants of the ancient Spartans, whose land they now occupy; but more probably they are of Slavonic origin. They number about 60,000, and are a wild and brave race, but superstitious, and addicted to robbery. While the Turks held possession of Greece, the M. were almost completely independent; and when not engaged in a common struggle against the Turks, their chiefs were at war with each other. The M., under their principal chief or bey, took a prominent part in the war for the liberation of Greece; but after the death of Mavromikalis, their last bey, their independence was destroyed.

MAINPRIZE, in English Law, was a term denoting a security by which the bailor or main-porner took the party bailed under his own personal charge or friendly custody, giving security to produce him at the time appointed. The practice is now obsolete, and superseded by Bail (q. v.).

MAINTENANCE is a law-term commonly used to denote an illegal succouring of a person, as by lending money to a stranger in carrying on lawsuits. Contracts are sometimes held to be illegal on this ground.

MAINTENANCE, CAP OF, sometimes called *Cap of Dignity*, a cap of crimson velvet lined with ermine, with two points turned to the back, originally only worn by dukes, but afterwards assigned to various families of distinction. Those families



Cap of Maintenance.

who are entitled to a cap of maintenance place their crests on it instead of on a wreath. According to Sir John Fearn, the wearing of the cap had a beginning from the duke or general of an army, who, having gotten victory, caused the chiefest of the subdued enemies whom he led to follow him in his triumph, bearing his hat or cap after him, in token of subjection and captivity. Most of the reigning dukes of Germany, and various families belonging to the peerage both of England and of Scotland, bear their crests on a cap of maintenance.

MAINTENON, FRANÇOISE D'AUBIGNÉ, MARQUISE DE, was the daughter of Constant d'Aubigné and of Jeanne de Cardillac, and granddaughter of Théodore Agrippa d'Aubigné, well-known for his writings, his attachment to Protestantism, and his energetic character. Françoise was born 27th November 1635, in the prison at Niort, where her father was then imprisoned. On obtaining his release, he went (1639) with his wife and daughter to Martinique in the West Indies, where he died in 1645. After her father's death, Françoise returned, with her mother, to France; and her mother also

dying, her father's sisters took her under their care, and educated her in a convent, where her conversion to the Roman Catholic religion was accomplished at the age of about 14 years—after an obstinate resistance, in which the brave little child, to use her own words, *fateguail les prêtres la Bible à la main*. It is singular to reflect what a zeal she afterwards became. When she was 16, she became acquainted with the poet Scarron (q. v.), who, struck by her beauty, intelligence, and helpless condition, offered her his hand, or, if she should prefer it, a sum of money sufficient for her entrance into a nunnery. Although Scarron was lame and deformed, she chose to marry him, and now lived in the midst of the refined and intellectual society which frequented the house of the poet. On his death, in 1660, she was reduced to great poverty, and proposed to go as a governess to Portugal, when Madame de Montespan (q. v.) obtained her a pension from the king. Four years afterwards, she was intrusted with the education of the two sons whom Madame de Montespan had borne to Louis XIV., and in this capacity displayed a patient tenderness and sleepless care that no mother could have surpassed; and now becoming acquainted with the king, soon fascinated him, so that he bestowed on her 100,000 livres, with which she bought the estate of Maintenon; and at last she succeeded in supplanting Madame de Montespan. It is difficult to describe her relation to the king. She was not, it is believed, his *mistress* in the ordinary sense of the term, but from that time to the end of his life, she exercised an extraordinary ascendancy over him. She had a passion for being thought 'a mother of the church;' but while she confessed the strength of her desire to Romanise the Huguenots, she earnestly denied that she approved of the detestable *dragonnades*. In 1684, about eighteen months after the death of the queen, Louis privately married her. She was much disliked by the people, but the courtiers sought her favour, and her creatures were made ministers and generals. In the midst of splendour, and in the possession of great power, she was confessedly very unhappy. She carefully brought up the children of Madame de Montespan; and it was at her instigation that Louis attempted to legitimise them. When he died in 1715, she retired to the former Abbey of St Cyr, which, at her wish, had been changed, thirty years before, into a convent for young ladies. Here she died, 15th April 1719. She received, to the end of her life, the honours of a king's widow. Her pretended Memoirs are spurious, but her *Lettres* (9 vols. Amst. 1756, &c.) are genuine. By far the best edition is that published by M. Lavallée (1854 et seq.), entitled *Œuvres de Mme de Maintenon publiées pour la première fois d'après les Manuscrits et Copies authentiques, avec un Commentaire et des Notes*.

MAINZ (MAYENCE, ancient *Moguntiacum*), the most strongly fortified city in the German Confederation, is situated in 50° N. lat., and 8' 10" E. long., in one of the most fertile of the wine-bearing districts of Germany, having for its site a gentle slope on the left bank of the Rhine, near the junction of the Main. The population was in 1861 39,702, exclusive of the regular confederate garrison of 10,000. A floating bridge, resting on 49 pontoons, connects M. with the Rhenish village of Castel, which is included within its vast and important system of fortifications. These works, which extend a length of nearly ten miles, consist of 14 principal, and numerous lesser bastions, in addition to the four forts of Castel, Mars, Montebello, and Petersau. In accordance with a decree of the Congress of Vienna, M. was surrendered to the grand duchy of Hesse-Darmstadt in 1814, on condition that it was to constitute a German federal stronghold, and be

garrisoned in common by Austrian, Prussian, and Hessian troops. Austria and Prussia, moreover, take it in turn to appoint the governor, vice-governor, and commandant of the forces, who hold their posts five years, but retire by such a mode of rotation as annually to vary the Austrian and Prussian preponderance. M., which is one of the most ancient cities of Germany, retains many evidences of mediæval taste, and consists principally of narrow crooked streets; but of late years a new town has sprung up on the site of the ancient Roman city, and numerous sanitary improvements have been effected under the joint direction of the grand-ducal and civic authorities. M. has one Protestant and ten Catholic churches, among the latter of which the most noteworthy are that of St Ignacius, with its beautifully painted roof, and the cathedral, a memorable building, which was begun in 978, and after having been six times destroyed by fire, or through war, was restored by Napoleon. It has one great tower, 400 feet in height, and 6 lesser towers, 14 altars, and 20 minor chapels. M. possesses numerous Roman remains, the most remarkable of which are the *Eichstein*—a mass of stones supposed to be a memorial erected in honour of Drusus—and the ruins of a vast aqueduct at Zalbach. M. has a gymnasium, a seminary for priests, a normal school, a picture-gallery, museums, and a public library containing nearly 100,000 volumes. Among the industrial products of M., which include artificial pearls, isinglass, tobacco, vinegar, soap, carriages, musical instruments, furniture, and articles in leather, the first and the last have acquired special reputation. M., from its position, necessarily enjoys a very important transit-trade, both by railway and river steam-navigation; and since the abrogation of many onerous restrictions, it has become one of the great internal ports for the corn and wine trade. The history of M. connects it with Rome from the year 13 B.C., when Drusus built on its site the castle of *Magontiacum*; but although it derives some interest from this circumstance, it owes its real importance to Charlemagne. It has acquired celebrity as the cradle of printing, which is generally believed to have been invented by Gutenberg, a native of the city. In November 1857, the explosion of a powder-magazine occasioned the destruction of many buildings and the loss of many lives.

MAISTRE, COMTE JOSEPH DE, was born 1753, in Chambéry, of a noble French family, which had settled in Savoy. While Savoy was occupied in 1792 by the French, M., who was a member of the senate, withdrew from the country; and when the king of Sardinia, in 1799, was compelled to retreat to the island of Sardinia, M. accompanied his court, and in 1803 was sent as ambassador to St Petersburg. In this post he remained until 1817, when he was recalled to occupy a place in the home government, and continued to reside in Turin till his death, on February 25, 1821. M. was an ardent advocate of legitimacy, and in his later career became one of the most eminent writers of the new (or liberal) conservative school in politics and religion, of which Chateaubriand may be regarded as the head. He had obtained some reputation as a writer at a very early period. His first work of note, *Considérations sur la France*, appeared in 1796. His later works were written either at St Petersburg or after his return to Turin. They are—*Essai sur le Principe Générateur des Constitutions Politiques* (St Petersburg, 1810); *Du Pape* (Lyon, 1821); *De l'Eglise Gallicane* (Paris, 1821—1822); *Soirées de St Petersburg* (2 vols. 1822); and a posthumous work, *Examen de la Philosophie de Bacon* (Paris, 1836).

MAITLAND, the name of a Scottish family, celebrated both in the literary and political history of their country. The first who acquired distinction was SIR RICHARD M. of Lethington, son of William M. of Lethington and Thirlstane, who fell at Flodden, and of Martha, daughter of George, Lord Seaton. He was born in 1496, studied at St Andrews and in France, and on his return to Scotland was successively employed by James V., the Regent Arran, and Mary of Lorraine. About 1551—1552, he received the honour of knighthood, became a lord of the Court of Session in 1561 (before which, however, he had the misfortune to lose his sight), and Lord Privy Seal in 1562. He died 20th March 1586, at the age of 90. M. was one of the best men of his time. In an age of violence, fanaticism, and perfidy, he was honourably conspicuous by his moderation, integrity, and anxiety for the establishment of law and order. He merits consideration not only as an eminent and upright lawyer, but as a poet, a poetical antiquary, and an historian. All his own verses were written after his 60th year, and shew what things he had most deeply at heart. For the most part, they consist of lamentations for the distracted state of his native country, the feuds of the nobles, the discontents of the common people, complaints 'aganis the lang proces in the courts of justice,' and the depredations 'of the border robbers.' A complete edition of M.'s original poems was first published in 1830 (1 4to vol.) by the Maitland Club, a society of literary antiquaries, taking its name from Sir Richard. His collection of early Scottish poetry was a work undertaken, if not completed, before his blindness attacked him. It consists of two MS. vols., the first containing 176, and the second 96 pieces; they are now preserved in the Pepysian Library, Magdalene College, Oxford. M.'s principal historical performance is the *Historie and Cronicle of the Hous and Surname of Seytoun*, &c.

MAITLAND, WILLIAM, better known as 'Secretary Lethington,' was the eldest son of Sir Richard Maitland of Lethington, and was born about 1525. Like his father, he was educated both at St Andrews and on the continent, and quickly displayed great aptitude for a political career. He became a convert to the Reformed doctrines about 1545, but could not have been a very violent partisan, since in 1558 he was appointed Secretary of State by Mary of Guise. In the following year, however, he openly joined the Lords of the Congregation, and was one of the Scotch commissioners who met the Duke of Norfolk at Berwick, to arrange the conditions on which Queen Elizabeth would give them assistance. In 1561, after the arrival of Queen Mary from France, he was made an extraordinary Lord of Session. He strongly objected to the ratification of Knox's *Book of Discipline*, and in 1563 conducted the prosecution raised against Knox for treason: from this time he appears to have split with the Reformers. In 1564, he held a long debate with Knox on the claims of the Reformed Church to be independent of the state. In 1566, he took part in the conspiracy against Rizzio, after whose assassination he was proscribed, and obliged to seek shelter for some months in obscurity. He was, it is believed, cognizant of Bothwell's scheme for the murder of Darnley; yet, when he saw the hopeless nature of Bothwell's designs, he immediately joined the confederacy of the lords. While Mary was still a prisoner at Loch Leven, he is said to have written to her, offering his services, yet he was present at the coronation of King James VI., 1567; and although he secretly aided in the escape of the queen, he fought against her on the field of Langside. In 1568, he accompanied the Regent Moray to the conferences held at York regarding the Scottish queen; but even

here he tried to further her interests, and is said to have been the first to propose to the Duke of Norfolk a union between him and Mary. The Scottish lords now felt that he was a dangerous enemy to the commonwealth, and in 1569 he was arrested at Stirling, but was liberated shortly after by an artifice of Kirkaldy of Grange. After the murder of the Regent Moray, he and Kirkaldy became the soul of the queen's party, in consequence of which he was declared a rebel, deprived of his offices and lands by the Regent Morton, and besieged, along with Kirkaldy, in Edinburgh Castle. After a long resistance, the castle surrendered, and M. was imprisoned in Leith, where he died, 'some,' says Melville, 'supposing he took a drink and died, as the auld Romans were wont to do.' Buchanan has drawn his character with a severe pen in his Scottish tract entitled *The Chameleon*.

MAITLAND, JOHN, DUKE OF LAUDERDALE, grandson of John, first Lord Thirstane, brother of the famous Secretary Lethington, and son of John, first Earl of Lauderdale, and of Isabel, daughter of Alexander Seaton, Earl of Dunfermline and Chancellor of Scotland, was born at the ancient family seat of Lethington, 24th May 1616. He received an excellent education, being skilled, according to Bishop Burnet, in Latin, Greek, Hebrew, history, and divinity, was carefully trained in Presbyterian principles, and entered public life as a keen and even a fanatical Covenanter. In 1643, he attended the Westminster Assembly of Divines as an elder of the Church of Scotland, and was a party to the surrender of Charles I. to the English army at Newcastle. Shortly after, however, he changed his politics altogether, and became a decided royalist. When Charles II. came to Scotland from Holland, Lauderdale accompanied him; but being taken prisoner at the battle of Worcester in 1651, was kept a prisoner for nine years. Set at liberty by General Monk, in 1660 he hastened to the Hague, and was warmly received by Charles. After the removal of Middleton in 1662, and of Rothes in 1667, Lauderdale was practically the sole ruler of Scotland, and for some time displayed a spirit of moderation, and an apparent regard for the religious feelings of his countrymen; but he soon became a bitter persecutor, sent multitudes of the Covenanters 'to glorify God at the Grassmarket,' and repelled in blasphemous language the remonstrances which many distinguished persons ventured to make. In 1672, Charles shewed his appreciation of Lauderdale's character and conduct by creating him Marquis of March and Duke of Lauderdale; two years afterwards, he was raised to the English peerage by the titles of Viscount Petersham and Earl of Guilford, and received a seat in the English Privy Council. He was one of the famous 'Cabal'; but having, by his domineering arrogance, excited the disgust and hatred of his colleagues, as well as of the whole English nation, he fell into disgrace, was stripped of all his offices and pensions in 1682, and died at Tunbridge on the 24th August of the same year. Lauderdale, according to Burnet, 'was in his principles much against popery and arbitrary government,' and his infamy consists in his shameless sacrifice of his convictions to his interests. He was a rude, blustering, passionate man, with what the Duke of Buckingham called a 'blundering understanding.' Burnet has also given us a picture of his appearance. 'He was very big, his hair red, hanging oddly about him. His tongue was too big for his mouth, which made him bedew all that he talked to; and his whole manner was very unfit for a court.'

MAITREYA was, according to the Buddhists, a disciple of the Buddha S'akyamuni and a Bodhi-

sattwa, or a man of pre-eminent virtue and sanctity. He is classed in their mythology amongst the gods called Tushitas, or 'the happy,' and has generally the epithet *Ajita*, or 'unconquered.' The Buddhists believe that he will become incarnate as their future Buddha. In Tibet, he is called Jampa. A faithful representation of this Buddha, surrounded by the (Tibetan) goddesses Dolma, the Mantas or Buddhas of medicine, two ancient priests, and various saints, will be found in the atlas of Emil Schlagintweit's *Buddhism in Tibet* (London and Leipzig, 1863), where an interesting sketch is given (p. 207, f.) of the characteristic types of Buddha images, and of the measurements of Buddha statues made by his brothers in India and Tibet.

MAIZE (*Zea*), a genus of grasses, having monocious flowers; the male flowers forming a loose panicle at the top of the culm; the female flowers in axillary spikes, enclosed in large tough spathes, from which only the extremely long styles—in the common species 6—8 inches long—hang out like tufts of feathers or silken tassels. The grains are large, roundish, compressed, naked, and arranged in parallel rows along the upright axis of the spike.—The COMMON M., or INDIAN CORN (*Z. mays*), is generally believed to be a native of the warmer parts of America, where it was cultivated by the aborigines before the discovery of

America by Columbus. But a representation of the plant found in an ancient Chinese book in the royal library in Paris, and the alleged discovery of some grains of it in the cellars of ancient houses in Athens, have led some to suppose that it is a native also of the East, and has from a very early period been cultivated there, and even that it is the 'corn' of Scripture; although on this supposition, it is not easy to account for the subsequent neglect of it until after the discovery of America, since which the spread of its cultivation in the Old World has taken place with a rapidity such as might be expected from its great productiveness and other valuable qualities. Columbus himself brought it to Spain about the year 1520. It is now in general cultivation in the south of Europe, and supplies a principal part of the food of the inhabitants of many countries of Asia and Africa. It is by far the most productive of all the cereals; in the most favourable situations yielding an increase of eight hundred for one, whilst an increase of three hundred and fifty or four hundred for one is common where irrigation is practised, and even without this the return is large. M. succeeds well in tropical and sub-tropical climates; and, being a short-lived annual, is cultivated also where the heat of summer is intense and of sufficient duration, whatever may be the cold of winter. Thus, its cultivation extends to the northern parts of the United States, and is pretty common in Germany; although the want of sufficient summer heat renders it a very uncertain crop even in the southern parts of Britain. Some of the varieties of M. require



Maize, or Indian Corn
(*Zea mays*).

about five months from the time of sowing for the ripening of their grains; whilst others, which, of course, are preferred in countries having a comparatively short summer, ripen in six weeks, or even less, but they are much less productive. The varieties are very numerous, of taller or humbler growth, from three to ten, or even fourteen feet; with yellow, white, brownish-red, or purple, glass-like, somewhat translucent grains, which vary very much in size. The culm is stout and erect; the leaves from one foot to two feet long, and two or three inches broad; the ears or cobs generally two or three in number, situated below the middle of the stem; in the large varieties, often above a foot long, and thicker than a man's wrist, in the smallest varieties, four or five inches in length. M. succeeds best in light, rich, deep, and rather moist soils; and dislikes shady situations. It is very generally planted in little hillocks raised at intervals, and to each of which five or six seeds are allotted. North American settlers generally make it their first crop on newly cleared and very partially tilled ground. The grains of M. make a very palatable kind of groats, and afford an excellent meal for baking purposes. The meal is not, however, adapted for making bread without a mixture of wheat, flour, or rye, owing to its deficiency in gluten; although, in oily or fatty matter, M. is richer than any other grain, and is very nutritious. M. meal mixed with rye meal forms the common brown bread of New England. M. very coarsely ground and boiled forms the *hominy* of the Southern States of North America. The porridge made of M. meal is called *mush* in North America; and the entire grains are used under the name of *hulled corn* or *samp*. The unripe grains, slightly roasted, burst and turn inside out, assuming a very peculiar appearance; in this state, they are known as *pop-corns*; and in this state are a favourite article of food in America, and have recently become common in shops in Britain. The cobs of M., ripe or unripe, are gathered with the hand. The unripe cobs are often pickled; they are also often boiled for the table. A kind of beer called *Chica* (q. v.) is made from M., also a spirituous liquor, and vinegar. The starch of M. is a good substitute for arrow-root, and is now well known in Britain, under various names, as *Oswego Flour*, &c.—The pith of the culm, before the flowers are produced, abounds in a sweet juice, which, being extracted by pressure, is boiled into an excellent sirup, and has sometimes been employed to furnish sugar; it is also fermented and distilled, and yields a good spirituous liquor. The small young stalks of thickly sown crops are cut over by the Mexicans, as an article for the dessert. In countries where M. does not ripen well, it is sometimes sown to afford food for poultry, or to be mown as green fodder for cattle. Where it is cultivated for its grain, the dried leaves are used as winter fodder. The tops, cut off after flowering, are stored for the same use. The stalks are used for thatch and for fuel, and for making baskets. The fibres of the culm and leaves afford a durable kind of yarn; and the bracts or spathes which surround the ear are elastic, and can be applied to the staffing of chairs, saddles, &c., and to the manufacture of good durable mattresses, which have become a profitable article of trade in Paris and Strasburg. The spathes are also much used for packing oranges and lemons; and in South America for making cigarettes. Good paper has been manufactured from them.—There are few plants of which the uses are more various than M., and few which are of greater importance to man.—For separation of the grains of M. from the ears, a particular kind of thrashing-machine is used.—Another species of M.,

called *CHILI M.*, or *VALPARAISO CORN* (*Z. Curagua*), is distinguished by its serrated leaves. It is a smaller plant, a native of Chili, and has won a superstitious regard, because its grains when roasted split in the form of a cross.

MAJESTY, a title of honour now usually bestowed on sovereigns. Among the Romans, *majestas* was used to signify the power and dignity of the people; and the senatorial, consular, or dictatorial majesty was spoken of, in consequence of these functionaries deriving their power from the people. After the overthrow of the republic, *majestas* became exclusively the attribute of the emperors, *dignitas* being thenceforth that of the magistrates. The *majestas* of the emperors of Rome was supposed to descend to those of Germany as their successors; but the adoption of the attribute by other European sovereigns is of comparatively late date. Its use began in England in the latter part of the reign of Henry VIII., up to which time 'Your Grace' or 'Your Highness' had been the appropriate mode of addressing the sovereign. Henry II. was the first king of France who was similarly styled, and Louis XI. and his successors became entitled, in virtue of a papal bull, to call themselves by the title of 'Most Christian Majesty.' Ferdinand and Isabella of Spain similarly obtained for themselves and their successors the title of 'Most Catholic Majesty;' and Stephen, Duke of Hungary, and Maria Theresa, of 'Apostolic Majesty.' The emperor of Austria is now styled his Imperial Royal Majesty; in German, 'K. K. (abbreviated for 'kaiserliche königliche) Majestät.' Emperors, kings, and queens are now generally addressed as 'Your Majesty,' not including the sultan of Turkey, whose proper style is 'Your Highness.' The sovereign of the United Kingdom is personally addressed as 'Your Majesty;' and letters are addressed to 'The King's' or 'Queen's' 'Most Excellent Majesty.'

In Heraldry, an eagle crowned, and holding a sceptre, is blazoned as an 'eagle in his majesty.'

MAJO'LICA, a name at first given by the Italians to a certain kind of earthen-ware, because the first specimens that they saw came from Majorca; but as subsequently a large manufacture of the same kind of earthen-ware was carried on at Faenza, the name majolica was dropped, and 'Faience' substituted. The term majolica is now used to designate vessels made of coloured clay, and coated with a white opaque varnish, so as to resemble 'faience;' it is of much less value, and is very common in Italy.

MAJOR, a term in Music, applicable to those intervals which are susceptible of being lowered a semitone without becoming false. See **INTERVAL**. Major is chiefly used as applied to the mode, key, or scale, which is said to be in the major when the third above the key-note is a major third—that is, when it is distant from the key-note four semitones; thus,



MAJOR, in the Army, is the second field-officer in a battalion of infantry or regiment of cavalry. He ranks next to the lieutenant-colonel, is mounted, and is responsible, with the adjutant, that the men are properly drilled and equipped. He commands in the absence of the lieutenant-colonel. In action, or on the march, he usually has charge of one wing. The pay of a major ranges from £1, 4s. 5d. a day in the household cavalry, to 16s. a day in the infantry of the line; and the regulation price of his commission in the cavalry and infantry of the line is £3200. There are no majors in the Royal

Artillery, Royal Engineers, or Royal Marines. Used adjectively, the word *major*, in the army, signifies a superior class in a certain rank, as sergeants-major, who are superior sergeants; except in the case of general officers, in which its signification is arbitrarily limited to major-general, the third of the four classes of generals.

MAJORA (Spanish, *Mallorca*), the largest of the Balearic Isles (q. v.), lies 107 miles south-east of the mouth of the Ebro, the nearest point of the Spanish coast, and 171 miles north of Algiers. Its greatest length (from east to west) is 64 miles, and its breadth (from north to south) 48 miles, with an area of about 1386 English square miles. The north-east half of the island is mountainous; the other parts are finely diversified with hills, valleys, and plains. The climate is healthful, the sea-breeze preserving a nearly equable temperature over the whole island. The inhabitants, who much resemble the Catalans in their appearance and manners, number (1857) about 200,000, are hospitable and industrious, and mostly employ themselves in agriculture. The chief products of the island are marble, slate, plaster, the common cereals and legumes, oranges, silk, lemons, oil, wine of excellent quality, olives, and aromatic herbs. The chief town is Palma (q. v.), the capital. The Spanish government makes use of M. as a place of banishment for political offenders.

MAJORITY is the age at which a person in this country acquires the status of a person *sui juris*—i. e., is able to manage his or her own affairs. This age, in the United Kingdom, is 21. Under that age, persons in England and Ireland are called infants, and are more or less subject to guardians, who manage for them their property. In Scotland, young persons are called minors between 12 (if females) or 14 (if males) and 21. It is chiefly with respect to the management of property that the distinction of majority is fixed upon, as it is assumed that persons under that age have not discretion and firmness to enter single-handed into contracts. It is also a common period fixed upon in wills at which to make provisions payable. As far as liability for crime is concerned, majority makes no difference, for all persons are capable of crime, when they have discretion enough to know that particular acts are criminal. A minor can, in Scotland, make a will of movable estate, but cannot do so in England.

MAKALLAH, a seaport on the south coast of Arabia, 300 miles east-north-east of the port of Aden. It has a well-protected harbour, and is much frequented by vessels for the purpose of laying in stores. It exports gum, hides, and senna, and is an extensive slave-market. Pop. about 4500.

MAKIA'N, one of the Moluccas (q. v.).

MAKO', a market-town of Hungary, on the right bank of the Maros, 16 miles east-south-east of Szegedin. Pop. 25,595, many of whom are Jews. The town contains numerous mills, and is famous for its breed of oxen, which are of unusually large size.

MAKRIZI, TAKI ADDIN ABU AHMAD MOHAMMAD, an eminent Arabic historian and geographer, was born in 1360 A. D., in Makriz, near Baalbec. He early devoted himself to the study of history, jurisprudence, tradition, astrology, &c., at Cairo, where also he afterwards held the offices of mohtasib, or inspector of weights and measures, and of khatib and imam at different mosques. The most important of his numerous works are a *Topographical History of Egypt*, a *History of the Mamluk Sultans*, and two treatises on Moslem (Kufic) coins,

weights, and measures, which have been edited and translated by Tychsen (into Latin), and by Silvestre de Sacy (into French). M. also commenced a work *On the Important Personages who had visited Egypt*, intended to fill 80 vols.; but only a small portion of these (one autograph volume is in the Imperial Library at Paris) was really accomplished. He died, at the age of 82 years, in 1442 A. D.

MALABA'R, a maritime district of British India, in the presidency of Madras, is bounded on the E. by the district of Coimbatore, while on the W. its shores are washed by the Arabian Sea; and it extends in lat. from 10° 15' to 12° 18' N. Area, 6050 square miles; pop. 1,514,909; net revenue, £260,478. The surface is occupied in the east by the Neilgherries, and the Western Ghats cover a great portion of the district. The name of this district is applied to the whole south-western coast of Southern India.

MALABATHRUM, a name given by the ancient Greeks and Romans to aromatic leaves, which were in high repute among them, both as a medicine and a perfume, and with which they sometimes flavoured wine. These leaves were brought from India, whence they were often called *Indian Leaves*; and from the value in which they were held, sometimes simply *Leaves*, just as the term *Bark* is now used to designate the medicinal bark of the Cinchona. Many fabulous accounts were current of their origin. They are now pretty certainly known to be the same with the leaves sold in every Indian bazaar under the name of *Tej-pal*, the produce of two nearly allied species of Cinnamon (*Cinnanomum Tamala* and *C. albiflorum*), growing in the dense forests of the Himalayan valleys; and the name M. is regarded as a corruption of *Tamala-putra*, Tamala leaf. They are aromatic, fragrant, and gently stimulant.

MALACCA, a British maritime settlement on the south-west coast of the Malay Peninsula, extends in lat. from 2° to 3° N., and long. from 102° to 103° E. It is 40 miles in length, and, including the district of Naning, about 25 miles broad. Area, about 1000 square miles; pop. estimated at 60,000. Near the coast, which is washed by the Strait of Malacca, the surface is flat and swampy, producing rice. Inland, there are low hills, Mount Ophir rising to 3920 feet. Although little agriculture is carried on, and the greater portion of the country is still in the condition of jungle, the soil is fertile in rice, sago, pepper, fruits, vegetables, rattans, and timber. In the district of Naning are tin-mines of some value. The climate is remarkably salubrious; the land and sea breezes are regular; and the thermometer ranges from 72° to 85°. The town and seaport of M., capital of the district of the same name, is situated in lat. 2° 11' N., long. 102° 16' E., at the mouth of a small river which flows into the Strait of Malacca. It is handsome and well built, and presents a fine appearance from the sea. Its most interesting building is the church of our Lady del Monte, the scene of the labours and supposed miracles of St Francis Xavier, the 'Apostle of the East.' Pop. variously estimated at from 5000 to 15,000.

M. was taken by the Portuguese under Albuquerque in 1509; became a Dutch possession in 1642; fell, in 1795, into the hands of the British, to whom it was finally ceded in 1824. Since September 1851, M., together with Singapore and the Prince of Wales Island, have formed a portion of the government of the presidency of Bengal.

MALACCA, STRAIT OF, separates the Malay Peninsula on the north-east from the island of Sumatra on the south-west. Length, 520 miles;

breadth varying from 25 miles at the south-east to 200 miles at the north-west extremity. In this strait are the British settlements of Singapore, Malacca, and Penang.

MALACHI (probably an abbreviated form of *Malachyah*, meaning 'messenger of Jehovah'; the Seventy and the Vulgate have *Malachias*), the name given to the last canonical book of the Old Testament. Regarding its author, nothing whatever is known. It has even been doubted whether M. is a proper name or only an appellative; the Seventy, the Chaldee, Jerome, and many modern scholars—Vitringa, Hengstenberg, Umbreit, &c.—favour the latter view. The period when the writer of M. composed his prophecies is conjectured to have been during the governorship of Nehemiah, or about 420 B. C. The book exhibits that strict regard for the proper observance of the ceremonial law, and that hatred of foreign marriages, &c., which marked the religious Jews after the return from exile, but has little of the old prophetic fire, freedom, and dramatic force.

MALACHITE, a mineral, essentially a carbonate of copper, of a green colour, often found as an incrustation or stalactitic along with other ores of copper; often in large masses, and often also crystallised in rather oblique four-sided prisms, bevelled on the extremities, or with the beveling planes truncated so as to form six-sided prisms. It is often of a fibrous structure. It is valuable as an ore of copper, although seldom smelted alone, not only because it is found along with other ores, but because the metal is apt to be carried off with the carbonic acid. It is sometimes passed off in jewellery as turquoise, although easily distinguished by its colour and much inferior hardness. It is used for many ornamental purposes; slabs of it—chiefly from the mines of Siberia—are made into tables, mantel-pieces, &c., of exquisite beauty. In 1835, a mass of solid M. was found in the Ural Mountains of more than seventeen feet in length, and weighing about 25 tons.



Crystal of Malachite.

sometimes passed off in jewellery as turquoise, although easily distinguished by its colour and much inferior hardness. It is used for many ornamental purposes; slabs of it—chiefly from the mines of Siberia—are made into tables, mantel-pieces, &c., of exquisite beauty. In 1835, a mass of solid M. was found in the Ural Mountains of more than seventeen feet in length, and weighing about 25 tons.

MALACHY, IMAR, Archbishop of Armagh, in Ireland, and a saint of the Roman Catholic Church, is remarkable not only for his connection with a very important period of Irish church history, but also from the circumstance of his biography having been written by his distinguished contemporary, St Bernard. M. was born, in the end of the 11th c., of a noble family, and having been educated by a hermit named Imar, received orders at an early age from the hands of Celsus, Archbishop of Armagh. His reputation for learning and sanctity was unexampled in that age, and Celsus had early designed M. as his successor in the see of Armagh; but M. protested against it, in consequence of an abuse similar to that of LAY IMPROPRIATION (q. v.), by which the temporalities of the see were held by laymen, called *Coarbs*. In the end, however, he was elected, with the full rights of his see, and soon afterwards, in his capacity of primate, took measures for the reform of the many abuses which prevailed in all the churches of Ireland. He went to Rome during the pontificate of Innocent II., and having in vain sought permission to resign his see, and retire to Clairvaux, returned to Ireland invested with extraordinary powers as legate of the pope. In this capacity, he made a visitation of Ireland, and many of the controversies as to the ancient religious usages of the Irish Church, which would be out of place in this publication, turn upon this period. M. again repaired to France

in 1147, in order to meet the pope, Eugene III., during his visit to that country; but before his arrival, the pope had returned to Rome, and M., during a visit to his friend, St Bernard, at Clairvaux, was seized with an illness which ended in his death in the year 1148. A curious 'Prophecy concerning the Future Roman Pontiffs,' is extant under the name of Malachy. It designates, by a few brief phrases, the leading characteristics of each successive reign, and in some instances these descriptive characteristics have proved so curiously appropriate as to lead to some discussion. The characteristic of Pio Nono, *Crux de Cruce* (cross after cross), was the subject of much speculation. That the prophecy really dates from the time of M., no scholar now supposes; it was unknown not only to St Bernard, but to all others, until the 16th century. It is first noticed in the end of that century, but it may be a sufficient indication of its worth to state that neither Baronius nor any of his continuators deemed it deserving of attention.

MALACOLOGY (Gr. *malakos*, soft), a name now not unfrequently employed to designate that branch of natural history which has *molluscs* (called *malakia* by Aristotle) for its subject. Linnæus, and the naturalists who preceded him, devoted some attention to this study; but until the time of Cuvier, the shells of the shell-bearing molluscs received a disproportionate share of attention, and the animals themselves were little regarded. Conchology (q. v.) has now, however, sunk to a very subordinate place, as a mere part of malacology, and this branch of science has been prosecuted during the present century by many eminent naturalists with great zeal and success. The names of Oken, Savigny, De Blainville, Van Beneden, Milne-Edwards, and Owen, perhaps deserve to be particularly mentioned.

MALACOPTERYGII, MALACOPTERI (Gr. *malakos*, soft; and *pteryx*, a wing), or **MALACOPTEROUS FISHES**, one of the two primary divisions of Osseous Fishes in the system of Cuvier, distinguished by soft or spineless fins, the rays of which are jointed. Spiny rays are occasionally found in the first dorsal and the pectoral fins. Cuvier subdivided the M. into orders according to the position or absence of the ventral fins; *M. abdominales* having the ventral fins beneath the belly, as the salmon and herring; *M. sub-brachiati* having the ventral fins beneath the shoulder, as the cod and haddock; and *M. apodes* wanting ventral fins, as eels. Müller, however—followed in this by Owen and others—has separated from the M. an order of fishes to which he has given the name of **ANACANTHS** (*Anacanthini*; Gr. spineless), differing from acanthopterous fishes merely in the absence of spinous rays in the fins. Among the anacanthus are the important families *Gadida* (Cod, &c.) and *Pleuronectida* (Flat-fish).

MALAGA, a city and seaport of Spain, capital of the modern province of the same name, is situated on the shore of the Mediterranean, 70 miles north-east of Gibraltar. Sheltered on the north and east by mountains, and with a climate of which dryness and constant sunshine are the characteristics, this place is superior as a resort for invalids to any other either of France or Italy. Winter, in the English sense, is here almost unknown. M. is purely a place of commerce, and with the exception of some fine Moorish remains, it contains little that can be called artistic. The sea is here receding, and the Moorish dock-yard and quay are now in the town, while the beautiful *Alameda*, or public walk, was covered with water last century. M. is famous for its sweet Muscatel wines, grown on the heights in the vicinity, and the richest of

which are called *Las Lagrimas*. Of the dry wines made here, about 30,000 butts, each about £10 in value, are exported to England and America. In 1860, the exports, consisting chiefly of wines, oil, figs, almonds, grapes, and raisins, amounted to £805,408; and the imports for the same year, consisting of salt-fish, iron manufactures, and colonial produce, amounted to £1,256,249. Besides its legitimate trade and its manufactures of cloth, ropes, leather, soap, &c., M. carries on an extensive smuggling traffic with Gibraltar and Marseille. Pop. 113,050. M., known to the Romans as Malaca, is a very ancient place. It was founded by the Phœnicians, and has enjoyed a commercial existence and a measure of prosperity for 3000 years.

MALAGA, a modern maritime province of Spain, formed out of the ancient kingdom of Granada (q. v.), is bounded on the S. by the Mediterranean, on the E. by the province of Granada, and on the W. by that of Cadiz. Area, 2786 square miles; pop. 451,406.

MALAGUETTA PEPPER. See GRAINS OF PARADISE.

MALAPTERU'RUS (Gr. *malakos*, soft; *pteron*, a fin; and *oura*, the tail) is the name given to a genus of fishes of the family *Siluridae* (q. v.), in which in place of a true dorsal fin, there is a soft fatty fin near the tail, and to this peculiarity the name is due. Two species are known—viz., *M. electricus* and *M. Beninensis*. See ELECTRICITY, ANIMAL.

MAL'ARIA. See MIASMA.

MALAY APPLE. See EUGENIA.

MALAY ARCHIPELAGO, also called the **INDIAN** or **EASTERN ARCHIPELAGO** and **MALAISIA**, by far the largest, if not also the most important island group, or rather system of island groups in the world, stretches in long. from 95° to about 140° E., and in lat. from 19° N. to 11° S. It is bounded on the N. by the China Sea, on the E. by the Pacific, and on the S. and W. by Australia and the Indian Ocean. The principal groups in the Archipelago are the Sunda Islands, in the west, embracing Sumatra, Java, &c.; the Philippines, in the north; and the Moluccas, or Spice Islands, eastward from Celebes. The chief members of the system are Borneo, Sumatra, and Celebes; only the western division of Papua, or New Guinea, is reckoned as forming a portion of the Malay Archipelago. Of these islands, Spain holds the Philippines; Britain possesses the settlements of Penang, Singapore, Labuan, and Malacca; native potentates reign in several; but by far the greater portion of this extensive Archipelago belongs to the Netherlands, and is frequently named the Dutch East Indies. With the exception of the tropical coasts of Brazil, no region produces such a luxuriant magnificence of vegetation as the Malay Archipelago. The heat of the climate is pleasantly tempered by sea-breezes; forests of invaluable timber cover the mountain slopes, and water is abundant.

MALAYS (properly, **MALAYUS**, a Malay word, the derivation of which has not yet been satisfactorily ascertained) is the name given, in a restricted sense, to the inhabitants of the Malay Peninsula, but in its wider acceptance, to a great branch of the human family, dwelling not only in the peninsula mentioned, but in the islands, large and small, of the Indian Archipelago, in Madagascar, and in the numerous islands of the Pacific. In the fivefold division of mankind laid down by Blumenbach, the M. are treated of as a distinct race, while in the threefold division of Latham they are regarded as a branch of the Mongolids. Prichard has subdivided

the various representatives of the Malay family into three branches—viz. (1.) the Indo-Malayan, comprehending the M. proper of Malacca, and the inhabitants of Sumatra, Java, Celebes, the Moluccas, and the Philippines, with whom, perhaps, may be associated the natives of the Caroline Islands and the Ladrões; (2.) the Polynesians; and (3.) the Madecasses, or people of Madagascar. Accepting this subdivision, we shall, in the present article, confine ourselves to the M. proper—the natives of Madagascar having been already noticed under that heading; and reserving the Polynesians generally and the Maoris in particular for distinct articles.

In physical appearance, the M. are a brown-complexioned race, rather darker than the Chinese, but not so swarthy as the Hindus. They have long, black, shining, but coarse hair; little or no beard; a large mouth; eyes large and dark; nose generally short and flat; lips rather thicker than those of Europeans; and cheek-bones high. In stature, the Indo-Malays are for the most part below the middle height, while the Polynesians generally exceed it. The Indo-Malays have also slight, well-formed limbs, and are particularly small about the wrists and ankles. 'The profile,' according to Dr Pickering, 'is usually more vertical than in the white race, but this may be owing in part to the mode of carriage, for the skull does not shew a superior facial angle.' Such is the general appearance of the M. proper, or inhabitants of the peninsula and Indian Islands. But these also have their subdivisions. There are the civilised M., who have a written language, and have made some progress in the arts of life; then there are the sea-people, *orang-laut*, literally, 'men of the sea,' a kind of sea-gipsies or robbers; and there are the *orang banua*, or *orang utan*, 'wild men,' or 'savages,' dwelling in the woods or forests, and supposed to be the aborigines of the peninsula and islands. 'These three classes of Malays,' says Crawford, 'existed nearly three centuries and a half ago, when the Portuguese first arrived in the waters of the Archipelago, just as they do at the present day. That people describes them as having existed also for two centuries and a half before that event, as, without doubt, they did in times far earlier.' Still, while so widely differing in habits, all these speak essentially the same language. The M. are essentially islanders, and have much of the daring and enterprise for which nations familiar with the sea are famous. Their original seat is by themselves stated to have been Menangkabo, in the island of Sumatra, rather than the peninsula itself. Even the M. of Borneo claim to have had a Menangkabo origin. Palembang, however, also in Sumatra, has been mentioned as the original seat of Malay civilisation; and others, again, point to Java as the source from which both Menangkabo and Palembang received their first settlers. 'The Javanese,' says Crawford, 'would seem to have been even the founders of Malacca. Monuments, which prove the presence of this people in the country of the Malays, have even been discovered. Thus, Sir Stamford Raffles, when he visited Menangkabo, found there inscriptions on stone in the ancient character of Java, such as are frequent in that island; and he was supported in his conclusion that they were so by the learned natives of Java who accompanied him in his journey. The settlement of the Javanese in several parts of Sumatra is indeed sufficiently attested. In Palembang, they have been immemorially the ruling people; and although the Malay language be the popular one, the Javanese, in its peculiar written character, is still that of the court.' The Malay language is simple and easy in its construction, harmonious in its pronunciation, and easily acquired

by Europeans. It is the *lingua franca* of the Eastern Archipelago. Of its numerous dialects, the Javanese is the most refined, a superiority which it owes to the influence upon it of Sanscrit literature. Many Arabic words have also been incorporated with it, by means of which the Javanese are able to supply the deficiency of scientific terms in their own tongue. In religion, the civilised M. are Mohammedans, having embraced that faith in the 13th or 14th century. The tribes in the interior and the 'men of the sea' have either no religion at all, or such as can be regarded only in the light of most debased superstition. The moral character of the Indo-Malays generally does not stand high: they are passionate, treacherous, and revengeful. Although good sailors, and able to amass wealth by legitimate commerce, they prefer piracy, and numerous have been the victims among European traders to Malay treachery and daring. Indeed, so little faith have Europeans in their professions or engagements, that they will never engage more than two or three of them in a ship's crew, for fear of unpleasant, if not disastrous consequences.

MALCOLM, the name of four kings of Scotland.—M. MacDonald succeeded to the throne on the abdication of Constantine MacAodh in 944 A. D. The most important event of his reign was the cession of Cumbria, in 946, by the English monarch Edmund I. M. was slain while engaged in quelling a revolt in the north of Scotland, in 953 A. D.

M. MacKenneth, grandson of the preceding, ascended the throne in 1003. His life was passed chiefly in repelling the incursions of the Danes. He died in 1033. A collection of laws, the *Leges Malcolmi Mackenneth*, has been attributed to him, but is obviously a work of a later age.

M. MacDuncan, surnamed **CAN-MORE** (Celtic, *Cean-mor*, 'Great Head'), was born about the year 1024, and ascended the throne on the death of Macbeth MacFinlegh, in December 1056, or of Lulach Mac-Gilcomgain in April 1057. For the first nine years of his reign, M. was at liberty to devote his energies to the consolidation of his kingdom, England being then ruled by the peaceful Edward the Confessor. After William of Normandy had settled himself on the English throne, many noble Saxons sought refuge at the Scottish court, and among them Edgar Atheling, nearest of kin to the Confessor, with his mother Agatha, and his sisters Margaret and Christina. Margaret, who was young, beautiful, and pious, captivated the heart of the Scottish king, and a marriage quickly followed. Her biographer, Turgot (also her chaplain and confessor), tells us how earnestly and affectionately she laboured to civilise the people and to 'enlighten' her husband. M., although a man of vigorous intellect, could not read her missals and books of devotion, but he used to kiss them in token of reverence, and he caused them to be richly bound, and ornamented with gold and jewels. The retinue of the king began to shew something of a royal magnificence, and his plate was, according to Turgot, 'at least gilt or silvered over.' But M.'s new relations, unfortunately, embroiled him with the Normans. In 1070, he crossed the border, harried Northumberland and Yorkshire, but was soon obliged to retreat. William the Conqueror retaliated in 1072, and wasted Scotland as far as the Tay. At Abernethy, M. was compelled to acknowledge him as his liege lord but (as the Scottish historians hold) only for such parts of his dominions as had belonged to England—viz., Cumbria and the Lothians. War broke out again between England and Scotland on the accession of William Rufus, probably at the instigation of

the fugitive Anglo-Saxons and the discontented Normans, who had been pouring into the country during the iron reign of William, and had obtained large grants of land from the Scottish monarch. Nothing of note, however happened, and peace was again concluded; but the seizure of Carlisle by the English king not long after provoked a fresh rupture, and, in 1093, M. again crossed the border, and laid siege to Alnwick; but while so engaged, he was suddenly attacked, defeated, and slain, November 13, 1093. His wife died immediately on hearing the fatal news.

M., surnamed 'The Maiden,' grandson of David I., succeeded that monarch, 24th May 1153, when only in his 12th year. He had no sooner mounted the throne than a Celtic insurrection, headed by Somerled, Lord of the Isles, broke out. Some years after, another insurrection broke out among 'the wild Scots of Galloway,' under their chief Fergus, to crush which M. had to employ a large force. In 1161, he had to chastise a revolt of the men of Moray, and to put down a second rebellion of Somerled. He died at Jedburgh, of a lingering disease, 9th December 1165, at the early age of twenty-four.

MALCOLM, SIR JOHN, G.C.B., a British statesman and historian, was born at Burnfoot, parish of Wester Kirk, Dumfriesshire, May 2, 1769, and at the age of 14 went to India as a cadet in the Madras army. About 1790, he commenced to devote his leisure hours to the study of the Oriental languages, especially Persian. He distinguished himself at the siege of Seringapatam in 1792, and was appointed to the staff as Persian interpreter. In 1800, he was sent as ambassador to Persia, to form an alliance with that country against Bonaparte, in which he succeeded. In 1802, 1807, and 1809, he was again sent as minister-plenipotentiary to the Persian court; and shortly before his final return, received from the Shah the order of the 'Sun and Lion,' and the titles of 'Khan' and 'Sepahdar of the Empire.' In 1803, he had been appointed president of Mysore; and during the two following years, his administrative talents had been of most important service to the government in reducing to order and tranquillity the newly conquered Mahratta states. In 1812, he returned to England, received the honour of knighthood, and, after a lapse of five years, returned to India as the governor-general's political agent in the Deccan, and with the rank of brigadier-general in the Indian army; in the latter capacity, he greatly distinguished himself in the wars against the Pindarris and Holkar. In 1827, he was appointed governor of Bombay, but finally left India in 1830. He died of paralysis at Windsor, May 1833. M.'s writings are highly esteemed as authorities; they are—*A History of Persia* (London, 1815, 2 vols. 4to; 2d ed. 1828); *Memoir of Central India* (2 vols. London, 1823); *Political History of India from 1784 to 1823* (2 vols. 8vo, 1826); and *Life of Lord Clive* (London, 1836), a posthumous work. The *Life and Correspondence* of M. were published by John W. Kaye, in 2 vols. 8vo (London, 1856).

MA'LDGEM, a small manufacturing town of Belgium, East Flanders, 17 miles north-west of Ghent. Population upwards of 6000, who are employed in the manufacture of tobacco, and in brewing and cotton-printing.

MA'LDIVE ISLANDS, a chain of low coral islands, in the Indian Ocean, about 400 miles west-south-west of Ceylon. They extend 500 miles in length by 45 miles in average breadth, and consist of 17 groups or atolls, each atoll surrounded by a coral reef. The entire number, including the islets,

is estimated at about 50,000. Mali, the largest of the chain, and the residence of the native prince, who is called 'The Sultan of the Twelve Thousand Isles,' is seven miles in circumference, and contains a population of 2000. The population of the whole chain is estimated at 200,000. Each island is circular in form, with a lagoon in its centre, and has an elevation above the sea in no case of more than 20 feet at high-water mark. The larger and inhabited islands are clad with palm, fig, citron, and bread-fruit trees. Grain is also abundantly produced. Wild-fowl breed in prodigious numbers; fish, rice (imported from Hindustan), and coconuts, constitute the food of the inhabitants, who are strict Mohammedans. The 'sultan' sends an annual tribute to the governor of Ceylon.

MALDON, a market-town, river-port, and municipal and parliamentary borough of England in the county of Essex, a mile below the confluence of the Chelmer and the Blackwater, and nine miles east of Chelmsford. Besides the manufacture of crystallised salt and silk fabrics, brewing and iron-founding, the usual branches of industry connected with a port, are carried on. In 1862, 1992 (sailing) vessels of 111,098 tons entered and cleared the port. M. returns two members to the House of Commons. Pop. (1861) of municipal borough, 4785.

MALE FERN. See **FERN, MALE.**

MALEBRANCHE, NICOLAS, a French philosopher, born August 6, 1638, at Paris, where his father was President of the Chamber of Accounts. He was deformed and sickly, and from his childhood fond of solitude. At the age of 22, he entered into the congregation of the Oratory, and devoted himself to the study of Bible history and of the Fathers of the church, till Descartes's treatise, *De Homine*, falling into his hands, attracted him to philosophy. His famous work, *De la Recherche de la Vérité* (3 vols. Paris, 1674, and other editions), displaying great depth and originality of thought, combined with perspicuity and elegance, had for its object the psychological investigation of the causes of the errors to which the human mind is liable, and of the nature of truth and the way of reaching it. He maintains that we see all things in God (his famous *Vision en Dieu*); that all beings and thoughts exist in God (*Dieu est le lieu des esprits, comme l'espace est le lieu des corps*); and that God is the first cause of all changes which take place in bodies and souls, which are therefore merely passive therein. His system is a kind of mystic idealism. It was immediately opposed by Ant. Arnauld, Bossuet, and many others, and was subjected to a thorough and critical examination by Locke and Leibnitz. Besides the work above mentioned, M. wrote a *Traité de Morale*, a *Traité de la Communication de Mouvement*, and *Conversations Métaphysiques Chrétiennes*, in the last of which he endeavoured to exhibit the harmony of his philosophic views with Christianity. He died at Paris (as English critics are fond of saying) of a dispute with the subtle Berkeley, October 13, 1715.

MALESHERBES, CHRÉTIEN GUILLAUME DE LAMOIGNON DE, a distinguished French statesman, was born at Paris, December 6, 1721, and educated at the Jesuits' College; he became counsellor to the parliament of Paris in 1744, and succeeded his father as President of the Court of Aids in 1750, where his clear judgment, strict integrity, and humane disposition, enabled him to be of great service to his country. A quiet but determined opponent of government rapacity and tyranny, he watched the ministry with a jealous eye, and was indefatigable in his efforts to prevent the people from being plundered. About the same time (1750),

he was appointed censor of the press. This was a most unsuitable office for him, but he appears to have accepted it lest it should fall into the hands of some mere bigot or court-hiring; and so tolerant was he, that French authors pronounce the period of his censorship 'the golden age of letters.' To M. we owe, among other things, the publication of the famous *Encyclopédie*. In 1771, his bold remonstrances against the abuses of law which Louis XV. was perpetrating, led to his banishment to one of his estates. At the accession of Louis XVI. (1774), who esteemed M., he was recalled, and entered Paris in triumph. In 1776, he resigned, on the dismissal of Turgot, all official employment; and from this period on to the Revolution, spent his time in travel, or in the improvement of his estates. The first storms of that wild period passed by and left him unscathed; but when he heard that the unfortunate king, who had always neglected to profit by his advice, was about to be tried by the Convention, he magnanimously left his retreat, and offered to defend his old master. The Convention granted permission, but from that day M. was himself a doomed man. He was arrested in the beginning of December 1793, and guillotined, April 22, 1794, along with his daughter and her husband, M. de Chateaubriand, brother of the famous author of that name. M. was a member of the French Academy, an able writer on political, legal, and financial questions, and one of the most virtuous and high-minded statesmen of the 18th century.

MALIBRAN, MARIA FELICITA, one of the most celebrated mezzo-soprano singers of recent times, born at Paris, March 24, 1808, was the daughter of Manuel Garcia, a Spanish singer and teacher of singing. When she was still very young, her reputation extended over Europe. Her father attempted to establish the Italian opera in New York, but without success; and, on account of his circumstances, she married M. Malibran, a Frenchman, who was supposed to be one of the richest merchants of that city, but who soon became bankrupt, on which she went again upon the stage, and was received with great enthusiasm in France, England, Germany, and Italy. She expended, with remarkable benevolence, the great sums which she won. Her first marriage having been dissolved, she married M. Beriot, a famous violinist, in 1836; but, in September of that year, she died at Manchester, whither she had gone to take part in a musical festival. M. was a woman of noble heart and high intellect, and her conversation possessed an exquisite fascination. She has left a number of musical compositions, some of which are deservedly popular. A memoir of her was published in England shortly after her death, by the Countess of Merlin.

MALIC ACID ($C_4H_4O_5 \cdot 2HO$), so called from *malum*, the Latin word for an apple, occurs abundantly in most acidulous fruits, particularly in unripe apples, gooseberries, and currants, in which it is found as an acid or super-salt of potash or lime, which gradually changes into a neutral salt as the fruit ripens. It crystallises in groups of radiating acicular prisms, but as the crystals are very deliquescent, it is usually obtained as a syrupy, semi-transparent mass, with a very sour smell, and readily soluble in water and alcohol.

The chemical changes which this acid undergoes under the influence of various reagents are very singular, and serve to illustrate many points in vegetable physiology in reference to the maturation of fruits, &c. Thus, nitric acid converts it into oxalic acid; hydrated potash, into oxalic and acetic acids; ferments, into succinic, butyric, acetic, and

MALIGNANT PUSTULE—MALLOW.

carbonic acids and water. When heated to about 350°, it loses the elements of water, and becomes converted into the two isomeric acids, maleic acid and fumaric acid (q. v.).

Malic acid forms two series of salts with bases, namely, neutral and acid salts. The most characteristic of these salts are the neutral malates of lead and of lime.

MALIGNANT PUSTULE is a contagious and very fatal disease, common in France, where it bears the name of *Charbon*, but of comparatively rare occurrence in England. It begins as a small dark-red, painful spot, on which there soon appears a pustule or vesicle, seated on a hard inflamed base. When this is opened, a black slough becomes apparent. This sloughing spreads rapidly, involving the cellular tissue, and sometimes even the adjacent muscles.

The disease appears to be caused by infection from horned cattle, which are sometimes affected by a similar disease, but it also arises by inoculation of diseased fluids. It is believed that flies which have alighted on the ulcers of diseased animals may occasionally convey the infection. The constitutional symptoms are much the same as those of putrid typhus fever; while the treatment consists in destroying the diseased surface by powerful caustics, in keeping up the strength by wine, brandy, beef-tea, bark with nitric acid, &c.; and in giving opiates in sufficient doses to relieve the pain during the day and to procure sleep at night.

MALIGNANT TUMOURS. See **CANCER** and **TUMOUR**.

MALINES, or **MECHLIN**, one of the chief cities of the Belgian province of Antwerp, 15 miles south-south-east of the city of that name, on the navigable river Dyle. The pop. was, in 1860, 31,371. It has fine squares, noble buildings, and wide regular streets, but is devoid of all signs of life and industry, having lost its former greatness, and fallen far behind all other Belgian cities in commercial enterprise and industrial activity. As the see of the cardinal-primate of Belgium, it still retains a certain degree of ecclesiastical importance, and possesses numerous churches, the most noteworthy of which is the cathedral of St Romuald, a vast building, covering nearly two acres of ground, and adorned in the interior with many fine pictures and choice carvings. It was built between the 12th and 15th c., but one tower, 345 feet in height, remains unfinished. The other objects most worthy of notice are the churches of St John and of Our Lady, which contain works by Rubens; the town-hall, dating from the 15th c., and known as the *Beyard*; the Market Hall, an ancient building, with towers, erected in 1340, and now used as a guard-house; the splendid modern archiepiscopal palace; and the monument to Margaret of Austria, erected in 1849. **M.** has two clerical seminaries, an academy of painting, a gymnasium, and a botanical garden. It still retains some of the important lace manufactories, for which it has been long noted, and manufactures caps and woollen goods, besides having considerable breweries. **M.** constitutes an important central point of junction for the entire Belgian system of railways.

MALINGERING, a term derived from a similar French word, signifies the feigning of disease, in order to avoid duty. This offence is punished very severely (usually by flogging) in the British army. For further particulars, see **FEIGNING OF DISEASE**.

MALL, or **PALL-MALL** (pr. Pell-Mell), a name given to places in London and other English towns where there were once alleys for playing tennis. See **BALL**.

MALLEABILITY is the property which certain metals possess of being reducible to thin leaves, either by hammering (hence the corresponding German word, *Hämmerbarkeit*) or by lamination between rollers. The order in which the malleable metals exhibit this property is as follows—Gold, Silver, Copper, Platinum, Palladium, Iron, Aluminium, Tin, Zinc, Lead, Cadmium, Nickel, Cobalt. Gold far surpasses all the other metals in malleability, being capable of reduction into films not exceeding the 200,000th of an inch in thickness; and silver and copper may be reduced to leaves of great tenuity. Although gold and silver also present the property of *Ductility* (q. v.) in the highest degree, there is no constant relation between the two properties; for example, iron, although it may be reduced to extremely thin wire, is not nearly so malleable as gold, silver, or copper.

MALLEACEÆ, a family of lamellibranchiate molluscs, regarded by many as a sub-family of *Aviculidæ* (see **PEARL OYSTER**), and of which the typical genus, *Malleus*, is remarkable—in an adult state—for the elongation of the ears of the shell, the other part of which at the same time assumes a curiously elongated, wavy, or crumpled form. The shell thus acquires the name of **HAMMER SHELL**. The species are natives of the East and West Indies and of the South Seas.

MALLOW (*Malva*), a genus of plants of the natural order *Malvaceæ*, having a 5-fid calyx, with an outer calyx of three leaves; stamens cohering in a tube; numerous styles cohering at the base; and numerous one-seeded carpels fixed in a whorl around an axis, and forming a separable orbicular fruit. The species are herbaceous plants, or more rarely shrubs.—The **COMMON M.** (*M. sylvestris*) is plentiful over most of Europe, and in Britain on waysides and heaps of rubbish. It is a perennial,



Common Mallow (*Malva sylvestris*).

with rather large bluish-red flowers on erect stalks. The **DWARF M.** (*M. rotundifolia*), also a common native of Britain, has smaller whitish or reddish-white flowers. These two plants have a mucilaginous and somewhat bitter taste, and the leaves are used as an emollient and demulcent medicine; a decoction of them being employed in cases of irritation of the pulmonary and of the urinary organs; and poultices made of them are very frequently employed to allay external inflammation. Other species have similar properties.—The **MUSK M.** (*M. moschata*), not unfrequent in England, but rare in Scotland, has a faint musk-like smell.—The fibre of *M. crispa* is used in Syria for textile purposes, and the fibres of many species are probably

fit for similar use, and for the manufacture of paper. The young leaves of some are occasionally used as boiled vegetables.—*M. tricuspidata* is used in the West Indies as a substitute for soap; and several species yield dyes.

MALLOW, a market-town and parliamentary borough of Ireland, in the county of Cork, is beautifully situated on the left bank of the Blackwater, 19 miles north-north-west of the county town. On the opposite side of the river, which is here crossed by a bridge of fifteen arches, is the suburb of Ballydahin. The town is resorted to in summer on account of its mineral waters, and contains a neat spa-house. Tanning, brewing, and the manufacture of salt are carried on, together with a good local trade. Pop. (1861) 3612. M. returns one member to the House of Commons.

MALMESBURY, a market-town and parliamentary borough of England, in the county of Wilts, 20 miles north-north-west of Devizes, and 96 miles west of London. Pop. (1861) of parliamentary borough, 6881. It returns one member to the House of Commons.

M. is a very ancient and interesting town. Here, according to William of Malmesbury, a monastery was founded before the year 670. The abbey afterwards became a cloth-factory. The remains of the abbey-church, partly early Norman, and partly decorated English, may still be seen. There are several other relics of antiquity in the place.

MALMESBURY, WILLIAM OF, an early English historian, was born near the close of the 11th c., probably in Somersetshire, educated in the monastery whence he derived his name, and of which he became librarian. He died some time after 1142, but the exact date is not known. M.'s principal works, which are written in Latin, are *De Gestis Regum*, a history of the kings of England from the Saxon invasion to the 26th year of Henry I.; *Historia Novella*, extending from the 26th year of Henry I. to the escape of the Empress Maud from Oxford; and *De Gestis Pontificum*, containing an account of the bishops and principal monasteries of England from the conversion of Ethelbert of Kent by St Augustine to 1123. The first of these was translated into English by the Rev. John Sharpe (Lond. 1815), and has been reprinted in Bohn's Antiquarian Library, under the editorship of Dr Giles (1847). Of his other works, Gale has printed his *Antiquities of Glastonbury*, and Wharton his *Life of St Wulstan*, in his *Anglia Sacra*. M. gives proof in his writings of great diligence, good sense, modesty, and a genuine love of truth. His style is much above that of his contemporaries.

MALMÖE, the principal town of the 'län,' or district, of Malmöhus, in Sweden, is situated on the Sound, nearly opposite Copenhagen, and had, in 1860, a population of 18,919. M. is a busy seaport, maintaining an active steam and sailing communication with Copenhagen and all the great Baltic and German Ocean ports, and has manufactures of stockings, tobacco, soap, sugar, woollen goods, &c. It is the seat of a governmental department, and is a lively, pleasantly situated town. The ancient fortifications, most of which are now converted into public walks, date from the time of Eric of Pomerania, who, in 1434, erected strong lines of defence on the sea-side of the town, and built the castle, which still remains. M. was an important place of landing and embarkation as early as 1259, and through the middle ages it was extensively visited by German and other traders. In 1523, it was the scene of the signing of a treaty of peace between the Danes and Gustavus Vasa.

MALMSEY (Malvasian Wine; Fr. *vin de Malvoisie*), a name originally bestowed on the red and white wines of Napoli di Malvasia, in the Morea, and afterwards on similar wines produced in Cyprus, Candia, and other islands of the Archipelago. Malmsey wines are of a luscious sweetness, and have a most peculiar bouquet. The Malmsey wines of commerce are mostly the produce of Teneriffe, the Madeiras, the Azores, the Lipari Isles, Sardinia, Sicily, and Provence. Malmsey is made from grapes grown on rocky ground, fully exposed to the sun, and left to hang on the vines for a month longer than those used to make dry wines, by which time they are partially withered.

MALONE, EDMOND, one of the most respectable editors of Shakspeare, was born in Dublin, 4th October 1741, and educated at the university of that city, where he won a high reputation as a scholar, and took the degree of B.A. In 1767, he was called to the Irish bar; but soon after becoming possessed of a considerable fortune, he went to London, and devoted himself to literary pursuits. His first appearance as an author was in 1780, when he published 2 vols. supplementary to Steevens's edition of Shakspeare (1778). His next achievement—though in this he was only one of several—was exposing the splendid forgeries of Chatterton. He also contributed some notes to Steevens's third edition of Shakspeare, published in 1785, in which he occasionally controverted the opinions of the editor. This led to a serious quarrel between the two, in which Steevens was wholly to blame. M.'s own edition of the great dramatist (1790) was warmly received. The essays on the *History of the Stage*, and on the *Genuineness of the Three Plays of Henry VI.*, have been praised in an especial manner. In this work, M. displays extreme good sense, much acuteness, extensive research, and a becoming respect for the text of the earlier editions. In 1796, he again signalled himself as a literary detective by exposing the Shakspearian forgeries of the Irelands. In 1797, he published a posthumous edition of the works of his friend Sir Joshua Reynolds. His death took place 25th May 1812. He left behind him a large quantity of materials for another edition of Shakspeare, which appeared in 1821, in 21 vols., under the editorship of Mr James Boswell. See *Life of Edmond Malone, with Selections from his Manuscript Anecdotes*, by Sir James Prior (Lond. 1860).

MALPIGHI, MARCELLO, an eminent Italian anatomist, was born near Bologna in 1628, and died at Rome in 1694. He held, at different periods of his life, the professorship of medicine in Bologna, Pisa, and Messina. In 1691, he was summoned to Rome, and appointed chief physician and chamberlain to Pope Innocent XII.

He is now chiefly known for his discoveries in the anatomy of the skin, of the kidney, and of the spleen; and although the so-called *rete Malpighii* of the skin is no longer regarded as a special structure, the *Malpighian bodies* or *corpuscles* of the kidney and the spleen still retain the name of their discoverer. He is also remarkable as being the first who examined the circulation with the microscope, and thus discovered the blood corpuscles. Amongst his most important works may be mentioned *De Formatione Pulli in Ovo*; *De Cerebro*; *De Lingua*; *De Externo Tactu Organo*; *De Structura Viscerum*; *De Pulmonibus*; and *De Structura Glandularum Conglobatarum*. His *Opera Posthuma* were edited by Petrus Regis of Montpellier; they contain a history of his discoveries and controversies, together with numerous autobiographical details.

MALPIGHIA'CEÆ, a natural order of exogenous plants; trees, or shrubs, many of them climbing shrubs or lianas. They often exhibit an anomalous formation of the stem, great part of the woody matter being deposited in lobed zoneless ribs. The leaves are simple, generally with glands on the stalks or under-side. The calyx is 5-partite, generally with very large glands; the corolla of five petals convolute in bud; the stamens generally ten, often monadelphous, a fleshy connective projecting beyond the anthers. There are about 600 known species, natives of tropical countries, and chiefly of South America, many of them having gaudy flowers. A few produce timber of a bright yellow colour. The bark of some species of the genus *Byrsonima* is astringent and medicinal, and at one time attracted considerable attention as a remedy for pulmonary consumption. It is known as *Alcornoque Bark*. The fruit of some, as the **BARBADOES CHERRY** (q. v.), is pleasant.

MALPLAQUET, a village (pop. 400) in the department of Nord, France, 20 miles east of Valenciennes, and close to the Belgian frontier, is celebrated for the bloody defeat of the French, under Marshal Villars, by the British and Dutch, commanded by the Duke of Marlborough and Prince Eugene, 11th September 1709. The forces engaged consisted of more than 200,000 men, the allies having a slight superiority in numbers; and the loss on each side amounted to about 20,000 men, the French losing also many standards and cannon. Marshal Villars was severely wounded early in the engagement, and the command devolved upon the old Marshal de Boufflers, in whose hands the battle degenerated into a mere butchery. The immediate result of the conflict was the capture of Mons.

MALSTRÖM, or **MOSKÖESTROM** ('whirling stream'), the most famous whirlpool in the world, is situated on the Norwegian coast, between Moskøe and Moskenäs, two of the Loffoden (q. v.) Isles. The tremendous current that rushes between the Great West Fjord and the outer ocean through the channels between the Loffoden Isles, creates many other dangerous currents, such as the Galström, Napström, &c.; but these are not to be compared with the famous Malström. The current runs for six hours from north to south, and then six hours from south to north, producing immense whirls. The depth of the water has been ascertained to be about 20 fathoms, while immediately to the west of the straits the soundings are from 100 to 200 fathoms. The whirlpool is greatest at high or low water; and when the wind blows directly against the current, it becomes extremely dangerous, the whole sea for several miles around being so violently agitated that no boat can live in it for a moment. In ordinary circumstances, it may be traversed even across the centre without apprehension. The stories of ships, whales, &c., being swallowed up in the vortex, are simply fables; at the same time, there can be no doubt that a ship, once fairly under the influence of the current, would certainly either founder or be dashed upon the rocks, and whales have often been found stranded on the Flagstadt coast from the same cause.

MALT AND MALTING. See **BEER**.

MALT REFUSE, or **MALT WASTE**, is of two kinds; (1.) the *cornings* or small shoots and radicles of the germinated grain, which are separated before the malt is used by the brewer, often called *Malt Dust* and *Kiln Dust*; and (2.) the exhausted malt, after it has been used by the brewer, called *Druff*. Both are of use for the feeding of cattle, but the first kind is the most nutritious, being rich in nitrogenous substances which the brewer extracts

from the malt used by him; druff, however, is advantageously employed, along with turnips, for the feeding of dairy cattle. Malt Dust is also used as a manure, chiefly as a top dressing, and is very fertilising and rapid in its effect.

MALTA, an island and British possession in the Mediterranean, 17 miles long by about 9 broad, with an area of about 95 square miles: it is of carbonaceous limestone, of the tertiary aqueous formation, and occupies a very central position in the Mediterranean Sea, being distant some 54 miles from the Sicilian coast, and about 200 from Cape Bon on the African coast. From its position, and also from the enormous strength of the fortifications, M. is a possession of immense value to any commercial nation which possesses a navy strong enough to prevent it being blockaded. It happens, consequently, that M. is one of the most important, after India, of the British dependencies, for it is not in any sense a colony. Possessing one of the most splendid harbours in the world, with such an even depth that the largest vessels may anchor alongside the very shore, the island forms at once an admirable station for a fleet to command the Mediterranean—a military focus, where a force protecting the route to Egypt and India can be concentrated—and a useful entrepôt for receiving the manufactures of Britain, which the small craft of the Mediterranean carry to every point on the shore of that inland sea and its tributaries. By whomsoever possessed, M. has always been held in high estimation. Between it and Gozzo, or Gozo (q. v.), lies the small island of Comino; and off this last, the still smaller islet, Cominotto, rears its rocky crest, while elsewhere round the shores of M. and Gozo, a few rocks stud the sea, sustaining each a few fishermen, and affording herbage for goats on their moss-grown summits; among these are Filfa, with a venerable church; Pietro Nero, or Black Rock; Scoglio Marfo, Salmonetta, and the *Hagira tal general*, or Fungus Rock, where grows the famed *Fungus melitensis* (see **CYNOMORIUM**). M. and Gozo, with their adjacent islets, form together a compact little realm, celebrated in history, possessing a magnificent capital in Valetta, and, from the fact that, owing to peculiar circumstances, vast contributions came to M. from all Catholic Europe, adorned with public buildings, institutions, and works out of all proportion to its actual intrinsic importance.

In physical conformation, M. is comparatively low, its highest point not exceeding 590 feet above the sea-level. The surface is diversified by a succession of hill and dale, the land being intersected by parallel valleys, running from south-west to north-east, the most considerable of which is the vale called Melleha. Across the island stretch the Ben-jemma hills or crags, and many spurs branch from them, which give a picturesqueness to the scenery. From the spongy nature of the limestone of which the island is composed, much of the rain falling in the wet season soaks in, and being evaporated through the thin alluvial covering by the heats of summer, keeps the ground moist, and gives it a fertility which could not otherwise be expected from so scanty and comparatively poor a soil, although its productiveness must also be attributed to the quantity of carbonate of lime held in a minutely divided state above the entire face of the rock.

M. shews no signs of volcanic formation; but the action of the sea among its cliffs has hollowed out grottoes and caverns in almost every direction, and some of considerable extent. The inhabitants are industrious, and good agriculturists, and, by the returns for 1860, had 35,007 acres in M., 9562 in Gozo, and 66 in Comino, under crops, comprising wheat, barley, beans, cotton,

sesamum, cumin, and grass; while the three islands together maintained 22,392 head of livestock, of which 5756 were horned cattle. On the whole, about the quantity of superior kinds of grain consumed is raised on the islands, and of inferior sorts a considerable amount is exported. Mules and asses are remarkable in M. for their strength and beauty, but horned cattle are small. Maltese goats are fine animals. The birds, which either make the island their permanent home, or migrate thither at special seasons, are renowned for their splendid plumage; and, lastly, the bees produce an aromatic honey, excelled in no other locality. The vegetable products comprise all that flourish in Italy, as aloe, oranges, and olives, with many plants of a more tropical growth.

Medina, the former capital of the island, now known as Citta Vecchia, or Notabile, is a handsome old town, lying inland; it contains the ancient palace of the Grand Masters of the order of St John, the cathedral, a college, and is still the seat of the bishopric. Pop. 7000. Its rival and successor is Valetta (q. v.). The numerous *casals* or villages scattered throughout M. and Gozo are neatly built, and generally present an aspect of industry and frugal happiness.

It is thought by some that M. was the *Hyperion* or *Ogygia* of Homer, but there is little doubt that the Phœnicians colonised the island at a very early date, probably in the 16th c. B.C. Before they were dispossessed by the Greeks in 736 B.C., they had developed considerable commerce. The Greeks called the island *Melitas*, and were driven out by the Carthaginians about 500 B.C. As early as the first Punic war, it was plundered by the Romans, but did not come finally into their possession until 242 B.C. They valued it highly, on account of its use as a commercial entrepôt; and also for its cotton and linen cloths, fabrics then, as now, manufactured of wonderful fineness by the Maltese. The island remained under its old laws, governed by a propretor, subject to the prætor of Sicily. On the north coast is the Port of St Paul, and here tradition fixes the wreck of the ship carrying that apostle to Rome. On the division of the Empire, M. followed the fortunes of the eastern division. During the 5th c., it fell successively under the Vandals and Goths, whose barbarism nearly annihilated its commerce. In 533, Belisarius recovered M. to the Byzantine empire, in nominal union with which it remained for more than three centuries; but its prosperity had departed, and its civilisation almost vanished amid constant local feuds. In 870, the Arabs destroyed the Greek power in M., and fortified the harbour as a station for their corsairs. Count Roger, of Sicily, drove out the Arabs in 1090, and established a popular council for the government of the island, composed of nobles, clergy, and elected representatives of the people. This council, in a more or less modified form, subsisted for 700 years. Under a marriage-contract, M. passed to the German emperor, who constituted it a marquisate, but it had ceased to be a place of trade, and was merely a garrison of more expense than value. Charles of Anjou, after overrunning Sicily, made himself master of M., which clung to the French even after they had been expelled from Sicily; but after a time the Houses of Aragon and Castile successively held the island. Subsequently, the Emperor Charles V. took possession of M., and, in 1530, granted it, with Gozo and Tripoli, in perpetual sovereignty to the Knights of the order of St John of Jerusalem, from whom the Turks had recently captured their great stronghold at Rhodes. The Knights raised by degrees the stupendous fortifications which render M. so powerful, and, moreover,

spent their large income in beautifying the island in every way. Meanwhile, they rendered incessant services to Christendom in the chastisement of the ferocious Barbary pirates. To revenge these acts, the Turks brought immense forces against M. in 1567, and again in 1565. The latter siege was carried on by the Sultan Solymán himself, with the flower of the Ottoman army; but the Grand Master La Valette opposed a heroic resistance, and he was forced to re-embark with the loss of more than 25,000 of his best troops. The defenders lost 260 knights and 7000 Maltese soldiers; and their gallantry was the theme of admiration throughout the world. After this siege the Knights built Valetta. In 1571, they, with the Maltese, behaved most courageously at the battle of Lepanto, where the Turks lost 30,000 men. Though waging perpetual war with the Moslem, the knights continued in possession of M. until 1798, when overcome by Bonaparte's treachery, and disorganised by internal quarrels, the order surrendered their noble fortresses to the French. After pillage and infamous treatment by the republican forces, the Maltese rose in a few months against their oppressors, and after a siege of two years, British auxiliaries arriving, the French garrison of Valetta capitulated to the English general Pigot. The treaty of Amiens stipulated that M. should be restored to the Knights of St John; but the Maltese loudly protested against such an arrangement, and preferred the peaceful government of Great Britain. The British government consequently refused to make the transfer, appreciating also, doubtless, the vast value of their new possession, and Napoleon made the refusal one of his grounds for the resumption of hostilities. The Congress of Vienna recognised M. as a British dependency, the condition in which it has since remained.

In 1860, M. and Gozo, with the adjacent islands, together contained 139,842 inhabitants (including 1118 British residents, and 1064 foreigners, but excluding the military, who numbered 7841). The population was increasing rapidly, but the annual rate of increase had declined from 1858. The upper classes speak Italian, but the real language of the people is a patois compounded from many sources, as must be expected from so chequered a history. Arabic, however, so far predominates that the Maltese find little difficulty in communicating with the Barbary peasants. It is alleged by some that the Maltese language—if its Italian and German elements were eliminated—would remain almost pure Punic, and would accurately represent the speech of Carthage at the time of its destruction. The religion of the people is strictly Roman Catholic, and, considering that the British flag waves over the island, but a scanty toleration is granted to other forms of faith. There are good provisions for education; a college at Valetta, where degrees are conferred in divinity, law, and physic; 54 public schools, with 6497 pupils, besides 114 private places for education. There is also an excellent public library, free to all.

The commandant of the garrison is governor, and is aided in the civil government by a council of 16 members, of whom 8 are officials, and 8 are freely elected. The revenue amounted, in 1860, to £145,944; but was exceeded by the expenditure, £148,303. Customs and excise, with a few assessed taxes, provide the former; the latter is absorbed in the charges of the civil government, and in a contribution of £6200 towards the military expenditure. On the other hand, Great Britain maintains a considerable force in the islands, mainly for imperial purposes, at a cost of £331,000 a year. Besides a large body of British artillery,

the garrison includes the Royal Malta Fencible Artillery, a fine native regiment of 639 officers and men. There is an extensive arsenal, and a very important dock-yard, M. being the head-quarters of the British fleet in the Mediterranean. Taken altogether, M. is a possession the British highly value; it is nearly, if not quite, as strong as Gibraltar, and far more useful.

The public debt amounted, in 1860, to £146,429, at a very low rate of interest. In the same year, the shipping belonging to the islands numbered 195 keels, of 32,625 tons; 3187 vessels, of 410,919 tons entered, and 3226 vessels, of 416,477 tons, cleared; of which about one-third were British bottoms; and of the foreign tonnage, about two-fifths belonged to the kingdom of Italy. The imports were valued at £2,981,947, and the exports at £2,300,821, corn *en route* from Russia for the United Kingdom figuring very largely in the transactions.

MALTA, KNIGHTS OF. See JOHN, ST, OF JERUSALEM, KNIGHTS OF.

MALTEBRUN, KONRAD (properly, **MALTHE BRUNN**), an eminent geographer, born 12th August 1775, at Thisted, in Jutland, studied in Copenhagen, and at the outbreak of the French Revolution, embraced with great ardour the liberal cause, so that being prosecuted upon account of political publications, he was twice obliged to flee from Denmark, and finally, in 1800, was condemned to perpetual banishment from his native country. He sought refuge in Paris, where he maintained himself by teaching and literary labours. In 1808, he began the *Annales des Voyages, de la Géographie et de l'Histoire* (24 vols.), which he concluded in 1814. In 1818, he began, along with Cyries, the *Nouvelles Annales, &c.* He devoted his pen to the support of Napoleon during his reign; and in 1815 became connected with an ultra-royalist journal, and a defender of the theory of legitimacy adopted by the Congress of Vienna. His principal work is his *Précis de la Géographie Universelle* (8 vols. Par. 1824—1828, with an atlas). He took part also in the *Dictionnaire Géographique Universelle* (8 vols. Par. 1821), and was Secretary to the Geographical Society of Paris. He died 14th

December 1826.—His son, **VICTOR ADOLPHE M.** (born 1816) is one of the most eminent living geographers of France, and has succeeded his father as Secretary of the Geographical Society of Paris.

MALTESE CROSS, a cross of eight points, of the form worn as a decoration by the Hospitallers (q. v.) and other orders of knighthood.

MALTESE DOG, a small kind of spaniel, with



Maltese Dog (*Canis familiaris*).

roundish muzzle, and long, silky, generally white hair. It is altogether useless, and fit only for a

lapdog; but is a very ancient breed, being figured on Roman monuments, and noticed by Strabo.

MALTHUS, THOMAS ROBERT, the founder of those opinions concerning the relation of population to the means of sustenance which have been named after him 'Malthusian,' was born in the county of Surrey, in the year 1766. He was well connected, and graduated with honours in 1788, at Jesus College, Cambridge, of which he became a Fellow. He became soon after clergyman of a small parish in his native county, and divided his time between his cure and the university libraries. In 1799, he left Britain to see foreign countries, along with the eminent traveller, Daniel Clarke. The great European war was then raging, and the most interesting portions of the continent of Europe were closed to our countrymen. M., however, with an evidently keen anxiety to observe mankind under a variety of conditions, wandered through Sweden, Norway, Finland, and part of Russia, making notes of what he observed. Next year, he took advantage of the short Peace of Amiens to visit France and other portions of Central Europe. These efforts to become acquainted with mankind are significant since. Although M. has the reputation of being a bold theorist, the charm of his writings consists in his practical knowledge of how men have existed and acted in various parts of the world and under diverse conditions; and his knowledge of actual human nature—his sagacity and accuracy, in short, in the details which he brought to bear on his great theory—were in a considerable measure the source of the great influence exercised by him over public opinion, and had the secondary effect of making his books readable even to those who made war on his conclusions. It was in 1798 that he first published his *Essay on the Principles of Population as it affects the Future Improvement of Society*; but in subsequent editions he so greatly enlarged and enriched the work, that it could hardly be identified with the first impression. The predominant idea of the book was evidently suggested by Hume's essay on the populousness of ancient nations, in which vague statements as to vast multitudes of human beings subsisting in any place, or wandering from place to place, are brought to the test of the means of subsistence at their disposal. Where there is an accurate census, the number of people living on the portion of the globe covered by it is, of course, known to within a trifle of the truth. Such arrangements for accuracy have, however, been extremely rare in the history of the world. Where they are absent, egregious exaggerations have been made in estimates of the numbers of mankind; and in the absence of absolute facts, the best means of reducing these wild estimates to something reasonable was the sceptical philosopher's plan of comparing the estimate of the numbers with the probable amount of food at their disposal. The application of this check by M. was something like the application of chemistry to organic matter. He set himself to finding out how the relation of population to the means of sustenance could affect the future of the world. The result was appalling. The human race was found to increase at something like geometrical progression; while the fertility of land, by bringing in waste, and improving the methods of agriculture, only increased in something like an arithmetical proportion. Hence, if population were permitted to increase at its natural rate, it would soon overtake the means of subsistence. The theory had only one defect as applicable to the present condition of the world, that it overlooked the element of free trade. It involved a general pauperism to Britain if her people had no resource but the produce of her soil, but it made no allowance for the

capacity of Britain to draw upon the fertility of the world at large. M. wrote other books, which got little notice in their day, and have been forgotten. He was appointed Professor of Political Economy at the college of Haileybury in 1805. He filled his chair with great repute until his death, on the 29th of December 1836.

MALTON, a parliamentary borough and market-town in the North Riding of Yorkshire, on an elevation on the right bank of the Derwent, 18 miles north-east of York. The parliamentary borough includes the parishes of Old Malton and Norton, to the former of which a grammar-school, founded in 1547, and having an annual endowment of £100 a year, is attached. There are also the remains of a priory, founded in 1150. Considerable trade is carried on. Pop. (1861) of parliamentary borough, which returns two members to parliament, 8072.

M., called by the Romans *Camulodunum*, abbreviated by the Saxons into *Meldun*, was an important Roman military station, to which six ancient roads lead. After having been burned down, the town was rebuilt in the reign of Stephen, since which time it has been generally called New Malton.

MALU'RUS, a genus of Australian birds, giving its name to a large subdivision of the family *Sylviadae*, in which are contained many Asiatic and African species, and some that are natives of the south of Europe. They have generally a long tail; in some, very long, as in the EMEU WREN of Australia, in which it is more than twice the length of the body, the shafts of its feathers loosely fringed on each side. The Emeu Wren (*Stipiturus malachurus*) is a very pretty little bird, living chiefly among long grass. One of the most noted *Maluri* is *M. cyanus*, the BLUE WREN or SUPERB WARBLER of Australia, which is gorgeously attired in black, blue, white, and brown. It haunts scrubby brushwood.

MALVA CEEÆ, a natural order of exogenous plants, of which about 1000 species are known, chiefly tropical, and most abundant in America, although the most important species belong to the Old World. They are herbaceous plants, shrubs, and occasionally in tropical countries trees; with alternate entire or lobed leaves; the pubescence, if any, starry; the flowers shewy, generally on axillary stalks; the calyx generally of five sepals or five segments, often with an epicalyx; the petals generally five, hypogynous, twisted in bud; the stamens numerous, united by their filaments; the ovary consisting of a number of carpels around a common axis, the styles generally five, the ovules few or many; the fruit dry or fleshy. The plants of this order have a great general similarity both in their appearance and in their properties and products. All of them contain a mucilaginous substance in great quantity, which is particularly abundant in the roots of the perennial herbaceous species. This mucilaginous quality makes some very useful as emollients and demulcents in medicine. The young foliage of some is used as a boiled vegetable. The seeds of all contain a considerable quantity of bland fixed oil. The inner bark of the stem often yields a useful fibre, for which species of *Hibiscus* and *Sida* are particularly valued; and to this order belong the Cotton plants, so valuable for the fibre which envelops their seeds. Many of them are frequent ornaments of flower-gardens.—See COTTON, HIBISCUS, HOLLYHOCK, MALLOW, MARSH-MALLOW, SIDA, and URENA.

MALVERN, GREAT, a town and watering-place in Worcestershire, England, picturesquely situated on the eastern side of the Malvern Hills, 8 miles south-west of Worcester. The purity and abundance of the spring-water, and the facilities for healthful

exercise afforded by the hills, have rendered Malvern a great resort for invalids following the hydropathic treatment, for which there are several large establishments. Pop. (1861) 4484.

MALWA, a former kingdom of India, lying for the most part north of the Nerbudda, and south-west of the valley of the Ganges, is an uneven plateau varying from 1500 to 2500 feet above sea-level. It is now divided into a number of protected states.

MAMELUKES, MAMLOUKS, or MEM-LOOKS, an Arabic word signifying *slaves*, the name given in Egypt to the slaves of the beys, brought from the Caucasus, and who formed their armed force. When Genghis Khan desolated great part of Asia in the 13th c., and carried away a multitude of the inhabitants for slaves, the Sultan of Egypt bought 12,000 of them, partly Mingrelians and Tcherkesses, but mostly Turks, and formed them into a body of troops. But they soon found their own power so great that, in 1254, they made one of their own number Sultan of Egypt, founding the dynasty of the Baharites, which gave place to another Mameluke dynasty, that of the Borjites, in 1382. The Caucasian element predominated in the first dynasty, the Tartar element in the second. In general, they formed able and energetic rulers, and Egypt under their sway arrived at a degree of prosperity and power to which she had been a stranger from the days of Sesoetria. Selim I, who overthrew the Mameluke kingdom in 1517, was compelled to permit the continuance of the twenty-four Mameluke beys as governors of the provinces. This arrangement subsisted till the middle of the 18th c., when the number and wealth of the M. gave them such a preponderance of power in Egypt that the pasha named by the Porte was reduced to a merely nominal ruler. The number of them scattered throughout all Egypt was between 10,000 and 12,000 men. Their number was kept up chiefly by slaves brought from the Caucasus, from among whom the beys and other officers of state were exclusively chosen. Their last brilliant achievements were on the occasion of the French invasion of Egypt, and during the time immediately following the retirement of the French. At this time, Murad Bey stood at their head. But in 1811 they were foully massacred by Mohammed Ali (q. v.), afterwards Viceroy of Egypt.

MAMERS, a small town of France, in the department of Sarthe, 25 miles north-north-east of Le Mans. Coarse linens, calico, beer, and leather are manufactured. Pop. about 5800.

MAMIANI, COUNT TRENZIO, an Italian philosopher, statesman, and writer, born in 1801, at Pesaro. Having taken a prominent part in the futile revolutionary outbreak which accompanied the accession of Gregory XVI., M. was compelled to seek safety in flight, and repaired to Paris, from whence he promoted with energy the revolutionary tendencies of his country. In 1846, on the accession of Pius IX., he declined the proffered papal amnesty, as long as its acceptance involved a disavowal of his former political principles; but on its being unconditionally granted, he availed himself of it, and even formed part of the papal ministry on the promulgation of the constitution. The inconsistent policy of the pope having compelled him to resign his post, he withdrew to Turin, where he founded, with Gioberti, a society for promoting the union of Italians. On the flight of Pius IX. from Rome to Gaeta, he re-entered the political arena, and was for a short period foreign minister in the revolutionary cabinet of Galetti. On the fall of Rome, he retired to Genoa; in 1856, he was returned member of the Sardinian parliament, and in 1860 entered Cavour's ministry as Minister

of Instruction. He has gained distinction in philosophy, poetry, oratory, and jurisprudence. His chief works are: *Del Rinnoamento della Filosofia antica Italiana* (1836); *Poeti dell' età Media* (1842); *Dell' ontologia e del Metodo*; *Principi della Filosofia del Diritto*, and a number of treatises on various subjects. A complete edition of his poetical works has been published by Le Monnier (Florence, 1857).

MAMMALIA (Lat. *mamma*, the breast), the highest class of the animal sub-kingdom *Vertebrata* (q. v.). This class includes Man and all the animals which resemble him in the most important points of their organisation; and it is naturally placed at the head of the animal kingdom, because (independently of Man being a member of it) it contains the animals which manifest the highest degree of intelligence, and which possess the most complex organisation.

The most distinctive character of the mammalia is their mode of development and of nourishment during the earliest period of life. They are all brought into the world alive (viviparous), not merely, as in certain (ovo-viviparous) reptiles and fishes, by the retention and hatching of the egg within the oviduct, but by the formation of a new connection between the embryo and its mother, while the former lies within the maternal cavities, so that provision is made for its development before birth, not, as in birds, &c., by the large yolk (see DEVELOPMENT OF THE EMBRYO), but by a constant supply of nutriment direct from the maternal blood. In mammals, the ovum, on quitting the ovary, is of extremely minute size, and the materials of the yolk only serve to support the embryo during its very earliest period. After undergoing certain changes in the passage through the Fallopian tube or oviduct, which it is unnecessary here to notice, the ovum reaches the uterus or womb, and connects itself by a set of root-like tufts of vessels with the maternal vessels. These

tufts absorb from the mother's blood the ingredients necessary for the support of the embryo, while they convey back to it the effete particles of the embryonic tissues. Through this organ, which simultaneously increases in size with the embryo, and is named the placenta, the young animal, except in the lowest orders of the class—viz., the Marsupialia (q. v.) and the Monotremata (q. v.)—derives its nutriment during the whole period of Gestation (q. v.); while in the two orders just named, no vascular connection of the ovum with the uterus of the mother is formed, the ovum being simply retained for a time within the uterus, and the requisite nourishment for the development of the young animal being obtained by absorption through the membranes of the ovum. This remarkable difference in the development of the mammalian embryo has given rise to a division of this class into two great sections or sub-classes—the *Placental* and the *Implacental* (or *Aplacental*) mammals. In both sub-classes, we find the same provision for nourishing the animal during the

period immediately succeeding its birth—viz., the Milk (q. v.), a fluid secreted by peculiar glands, called the *mammary glands*, which become greatly developed in the female during the periods of gestation and lactation; and as this is found in no other class, it is the character by which the entire group is most positively defined, and from which it derives its name.

The mammary glands exist in both sexes, but except in very rare cases, it is only in the female that they secrete milk. Their number is never less than two, and when more, is generally nearly proportional to that of the young produced at each birth. In the monkeys, the elephant, the goat, the mare, &c., there are two; in the cow, stag, and lion, four; in the cat, eight; in the rabbit, ten; in the pig, generally twelve; and in the rat, ten or twelve. These glands are often blended together, as in the cow; and their number is then indicated externally by that of the nipples or teats. Their position also varies: in the monkeys and bats, and in the herbivorous Cetacea, they are situated on the thorax, as in man; in most of the carnivorous animals, they are situated on the abdomen as well as on the thorax; while in the mare, cow, sheep, &c., they are placed still further back, near the hip-joint.

The *skin* in the greater number of mammalia is covered with hair, a form of tegumentary appendage peculiarly characteristic of this class. In the Cetacea, however, we have an almost entire absence of hair; one of its uses—that of keeping the heat within the body—being here provided for by the thickening of the skin and the deposition of the blubber beneath it. In the Edentata, the hairy covering is almost entirely replaced by horny scales, as in the scaly ant-eater, or by bony plates, as in the armadillo. In the quills of the porcupine and the spiny bristles of the hedgehog, we have other modifications of hair which depart less

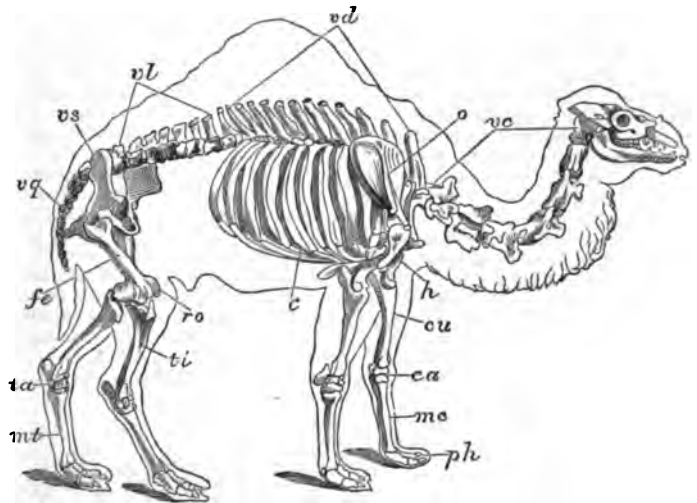

Fig. 1.—Skeleton of the Camel:

vs, cervical vertebrae; vd, dorsal vertebrae; vl, lumbar vertebrae; vs, sacral vertebrae; vg, caudal vertebrae; a, ribs; o, scapula; h, humerus; cu, bone of forearm (radius and ulna fused together); ca, carpus, or wrist-bones; mc, metacarpus; ph, phalanges; ro, femur; ti, patella; ta, tibia; ta, tarsus; mt, metatarsus.

from its ordinary character than those just mentioned. Moreover, the claws, nails, and hoofs of all mammals, the horn or horns on the nose of the rhinoceros, and the horns of the hollow-horned ruminants (such as the ox, sheep, &c.), are all

composed of a substance which is only a modification of hair.

The *skeleton*, as a general rule, governs the general form of the body. In its general conformation, it shews a close analogy with that of man, which is described in the article SKELTON; the differences which are remarked amongst the various animals of this class mainly depending (1) upon the absence of posterior limbs in the marine mammals, such as the dugong, the porpoise, and the whale; (2) upon the diminished number of digits (see HAND and FOOT), and upon the absence of the clavicle in the greater number of those species whose anterior limbs serve only for motion; (3) upon variations in the number of vertebrae; and (4) upon the inequalities in the relative sizes of the same bones (Milne-Edwards).

Although the same bones enter into the formation of every mammalian skull, great differences present themselves in different skulls, according as the face is more or less prolonged, or, on the other hand, the brain-case or cranium is more or less developed. In proportion as a mammal is removed in classification from man, we find that the cranium is diminished; that the face is prolonged by extension of the jaws and nasal cavities; that the orbits are directed outwards, and are less distinct from the temporal fossae; and that the occipital foramen (through which the spinal cord passes) and the condyles (by which the head articulates with the first vertebra of the spinal column) are placed towards the posterior part of the skull, instead of occupying the middle of its inferior surface, as in man. Amongst the most characteristic points in the mammalian skull generally, may be mentioned (1), that the lower jaw articulates directly with the skull, there being no intervening tympanic bone, such as occurs in the other vertebrates; and (2) that the occipital bone of the skull articulates with the first vertebra by two condyles, one on either side of the occipital foramen, instead of by a single condyle, as in the other vertebrates.

The *vertebral column*, except in relation to its length, closely resembles that in man, where there are 7 cervical, 12 dorsal, 5 lumbar, 5 sacral, and 5 caudal vertebrae. The *cervical vertebrae* are almost universally 7 in number, however long or short the neck may be, the only known exceptions being two cetaceans (*Manetus* and *Rytina*), which have 6, and the three-toed sloth, which has 9. The number of *dorsal vertebrae* ranges from 11 to 23, which latter number occurs in the two-toed sloth. The *lumbar vertebrae* range from 2 to 9, the most common number being 5. The *sacral vertebrae*, which coalesce to form the sacrum and to support the pelvic arch, vary from 2 (in the Monotremata and Marsupialia) to 6 (in the mole), the most common number being 4. In the Cetacea, the rudimentary pelvis is loosely connected with a single vertebra, and there cannot be said to be a sacrum. The *caudal vertebrae*, which in man and the higher apes coalesce to form the *coccyx*, are usually very numerous, 20 or 30 being a common number, and 40 occurring in the long-tailed ant-eater. The form and number of *caudal vertebrae* vary in accordance with the purposes to which the tail is applied; and the special uses of this organ are numerous. For example, in the kangaroo it serves as a third leg when the animal stands erect;

in the American monkey, and in some of the opossums, it is a prehensile organ; and in the Cetacea and in the beaver it is a powerful instrument of propulsion in water. The *ribs* correspond in number to the dorsal vertebrae, and, as a general rule (excepting in the Monotremata), they are connected superiorly not only with the bodies of two vertebrae, but with the transverse process of one of them, and hence present corresponding articular surfaces. The *sternum* is generally divided into three portions; the middle one, in place of being represented by a single piece, as in man, usually consisting of as many pieces as there are true ribs. It is very short in the Cetacea, and is very long in the Carnivora and Edentata, extending in some cases nearly to the pelvis. In certain cases, in which it is necessary that the anterior members should be endowed with unusual strength, as in the bats, moles, and armadillos, there is a projecting keel upon this bone (as in birds) for the attachment of powerful pectoral muscles.

The cavity of the *thorax*, which is bounded superiorly by the dorsal vertebrae, laterally by the ribs, and inferiorly by the sternum, is completely separated from the abdominal cavity in mammals (but in no other vertebrates) by the muscular septum known as the *diaphragm*, or midriff.

The *scapular arch* in mammals is comparatively imperfect, its coracoid element (see CORACOID BONES) not being sufficiently developed, except in the Monotremata, to reach the sternum, or to meet its fellow in the mesial line. Where the scapula has any bony connection with the sternum, it is through the clavicle or collar-bone, which is frequently absent. The *pelvic arch* is always composed of the ilium, ischium, and pubis on either side, and these bones generally coalesce together, as in man, at an early period of life; but in the Monotremata they remain separate. In the implantental mammals (the Monotremata and Marsupialia), the pelvis presents this striking peculiarity, viz., that from the symphysis (or mesial line of union) two additional bones, termed the marsupial bones, project forwards and outwards, one of whose functions is to support the *marsupium*, or pouch, which is characteristic of the female marsupials. In the bat, the pelvis is greatly elongated, and the bones do not unite in the mesial line to form

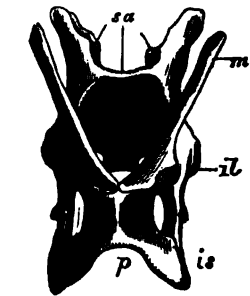

Fig. 2.—Pelvis of the Echidna: sa, sacrum; il, ilium; is, ischium; p, pubis; m, marsupial bone.

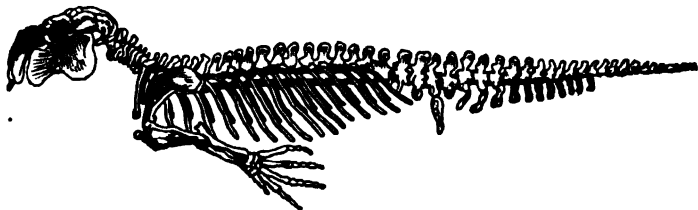

Fig. 3.—Skeleton of Dugong: In which the pelvis is a mere bony ring.

a symphysis, so that the lower part remains open, as in birds; while in the Cetacea, which have no

posterior limbs to be supported by the pelvis, that organ is extremely rudimentary (see fig. 3), or even entirely absent. As a general rule, the pelvis of mammals is never so broad as in the human subject, and its lateral walls are always relatively smaller, flatter, and longer.

The *anterior extremities* are always present, although their modes of conformation are very varied, according to the purposes for which they are designed; and the *posterior extremities*, which are also always present, except in the Cetacea, closely resemble the anterior; the difference being greater in man than in any other case, in consequence of the special adaptation of the pelvic extremities for the support of his body in an erect position. The ordinary modifications of these organs are described in the articles *HAND* and *FOOT*.—See *Owen On the Nature of Limbs*.

The *teeth* of mammals constitute so characteristic a feature in their organisation, and are of so much service in their classification, as to require a special notice. The only animals of this class in which teeth are altogether absent are the true ant-eaters and the Monotremata. The number of teeth is

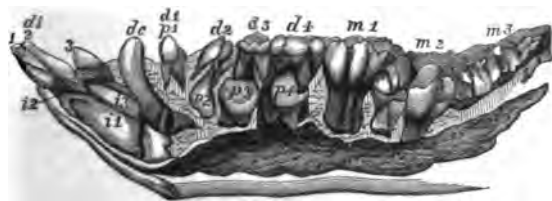

Fig. 4.—Lower Jaw of a young Pig (from Owen's *Mammalia*):

i, indicates an incisor; *c*, a canine; *p*, a premolar; and *m*, a molar tooth. When the letter *d* is prefixed, the tooth is a deciduous or milk tooth.

generally much more restricted than in reptiles or fishes. In most mammals it is the same as in man—viz., 32; but the typical number, according to Owen, is 44. The largest number of teeth occurs in the armadillos (in one species of which are 98 simple molars), and in the dolphins, which have from 100 to 190 teeth. When the teeth are in these excessive numbers, they are small, nearly equal, and usually of a simple conical form, but excepting in these cases, most mammals have particular teeth for special purposes; thus, the front teeth (fig. 4, *i*), from being commonly adapted to effect the first coarse division of the food, are called cutters, or *incisors*, and the back teeth (*m*), which complete its comminution, grinders, or *molars*; while the large conical pointed teeth (of which there is never more than one in each half jaw), which are specially adapted for holding the food while the animal tears it asunder, are called holders, lanaries, or more commonly *canines* (*c*), from being well developed in the dog. The incisors and canines may be absent, but except in the cases previously mentioned, the molars are always present. The mode in which the teeth are implanted in the jaw is characteristic of the class. Excepting in those teeth which grow from persistent pulps (as the front teeth of the Rodents, for example), the dental cavity is closed in at its extremity, and the tooth is prolonged into a fang, which is implanted in a socket lined by periosteum, to which the exterior of the fang is firmly adherent; there being never a continuous ossification or ankylosis of the tooth to the jaw. Again, the fang of the molars is usually divided into two, three, or even four divergent processes, and there is no known fish or reptile in which even a bifid fang occurs. Teeth are confined in this class to the maxillary, pre-maxillary, and lower maxillary bones, and form only a single row in each;

and, in general, teeth are situated in all these bones. In all existing mammals, except man, there is a vacant space between the incisor and canine teeth. No mammal has more than two sets of teeth; most, however, have two; the first, which are called temporary, deciduous, or milk teeth, being displaced, and succeeded by the permanent teeth, as shown in fig. 4. For a description of the structure and principal forms of these organs, we must refer to the article *TEETH*, and to Professor Owen's magnificent *Odontography*.

The *digestive apparatus* (of which the teeth may be considered a portion) acquires its greatest completeness and elaboration in this group. The leading differences which it presents, and which depend mainly on the nature of the food, have been already noticed in the article *DIGESTION*.

The *organs of circulation and respiration* require no special remark, as, in all essential points, they closely resemble the corresponding organs in man. See *CIRCULATION* and *RESPIRATION*.

The *kidneys* of mammals generally agree with those of man in their internal structure. See *KIDNEYS*. In some animals (especially those that live in water), they are much lobulated. In the ox, there are 20 free rounded lobules; in the bear, 40 or 50; in the seal, 70 or 100; while in the true Cetacea, the separate lobules are so numerous as to give a racemiform appearance to the kidney. All mammals are provided with a urinary *bladder*, in which the excretion may accumulate so as only to require being discharged at intervals. This organ is largest in the Herbivora, and very small in the Cetacea.

The *nervous system* is remarkable for the large size of the brain, and especially of its hemispheres, in comparison with the rest of the nervous system. The surface of the cerebral hemispheres exhibits a more or less convoluted appearance, the number of the convolutions being to a great degree in correspondence with the amount of intelligence of the animal. The hemispheres are united at their lower parts (except in the implacental mammals) by a fibrous band or commissure, termed the *corpus callosum*, which does not occur in the other vertebrates. In the lowest mammals, the cerebellum is situated quite behind the hemispheres, so as to be visible from above; as we get higher in the scale, it is more or less covered, in consequence of the prolongation of the hemispheres backwards; until in the highest apes and in man it is almost completely concealed.

The *organs of the senses* are constructed on precisely the same plan as in man. The most important variations are noticed in the articles *EAR*, *EYE*, &c.

The *muscular system* generally accords with that of man, but presents many remarkable deviations, according to the form of the skeleton, the use of the several organs in the act of locomotion, the natural posture of the animal, &c.

From the structural characteristics and peculiarities of mammals, we turn to that class of animals in their relations to man.

The *uses* to which mammals are subservient are almost innumerable, and will readily suggest themselves.

The number of species of existing mammals is estimated by Leunis at 2067, of which about 150 are found in Europe (about 60 being peculiar to that continent), 240 in Africa, 350 in Asia, 400 in America, and from 60 to 70 in Australia. Arranging them in orders, there are 65 species of Cetacea, 177 of Ruminantia, 35 of Pachydermata, 6 of Solidungula,

MAMMALIA—MAMMARY GLAND.

35 of Edentata, 617 of Rodentia, 33 of Pinnipedia, 413 of Carnivora (including Insectivora), 328 of Cheiroptera, and 221 of Quadrumana; while the order Bimana contains the single species Man.

The subdivision of the mammals into these orders closely approximates to that of Cuvier, as may be seen by a reference to the following table of his sub-classes and orders of the mammalia :

	Order.	Family or Genus.	Example.		
UNGUICULATA	BIMANA,	<i>Homo</i> ,	Man.		
		<i>Catarrhina</i> ,	Ape.		
	QUADRUMANA	<i>Platyrrhina</i> ,	Marmoset.		
		<i>Strepsirrhina</i> ,	Lemur.		
		<i>Cheiroptera</i> ,	Bat.		
	With three kinds of teeth	CARNIVORA (the CARNASSIERS of Cuvier)	<i>Insectivora</i>	Hedgehog. Shrew.	
			<i>Carnivora</i>	Mole. Bear. Dog. Seal.	
		MARSUPIALIA	<i>Didephys</i> ,	Opossum.	
			<i>Phalangista</i> ,	Phalanger.	
	Without canines,	RODENTIA	<i>Macropus</i> ,	Kangaroo.	
<i>Phascoglossus</i> ,			Wombat.		
Without incisors,		EDENTATA	<i>Clavicalata</i> ,	Rat.	
			<i>Non-clavicalata</i> ,	Hare.	
UNGULATA,		PACHYDERMATA	<i>Bradypus</i> ,	Sloth.	
			<i>Dasyus</i> ,	Armadillo.	
		RUMINANTIA,	<i>Myrmecophaga</i> ,	Ant-eater.	
			<i>Monotremata</i>	Echidna.	
		MUTILATA,	CETACIA	<i>Proboscidea</i> ,	Ornithorhynchus. Elephant.
				<i>Ordinaria</i> ,	Hog. Tapir.
			<i>Solidungula</i> ,	Horse.	
			<i>Herbivora</i> ,	Sheep.	
		<i>Ordinaria</i> ,	Dugong. Whale.		

This classification is given in the present article because, although imperfect in many respects (for example, in placing the sloth above the horse, the bat above the dog, and the hedgehog above the elephant), it has been retained in a large number of popular works. In consequence of these obvious imperfections, subsequent attempts at new classifications have been made by several of the most eminent zoologists, some of whom, as Waterhouse and Owen, have taken the brain, and others, as Milne-Edwards, Gervais, and Vogt, the placenta, as the basis of classification. Our limited space forbids us from discussing the merits of these systems. The grounds on which Professor Owen bases his cerebral classification may be found in his essay *On the Classification and Geographical Distribution of the Mammalia*, 1859; while the arguments in favour of the placental classification may be found in Professor Huxley's Lectures on Classification, published in the *Medical Times* for the year 1863.

Fossil Mammalia.—The remains of mammalia are generally found in a fragmentary condition; but there is a valuable compensation to the student of these higher organisms, for in them the parts are so differentiated that the smallest fragment—a tooth or a bone—often tells more to the comparative anatomist than the complete skeleton of some of the lower classes.

No relics of mammalia have been detected in the Palaeozoic rocks, the earliest we are acquainted with belong to Secondary strata. These are the remains of *Microlestes* from the Keuper, unless the jaws of the *Dramatherium* from an American coal-bed, which is probably of Triassic age, be older. The *Microlestes*, of which the teeth only have been found in Germany and in Somerset, is considered by Owen to have been allied to the small marsupial and insectivorous *Myrmecobius* of Australia. The next remains of this class have been found in the Stonesfield slate, a member of the Oolite. They consist of teeth and lower jaws, which have been referred to four genera, three of which are thought to have been marsupial Insectivora, while the other (*Stereognathus*) was a placental mammal, probably a hoofed, and consequently a herbivorous animal, allied to the Eocene *Hyracotherium*. Mr Beckles has recently

found the remains of twelve or thirteen species belonging to eight or nine genera of mammalia—placental and marsupial—in the Purbeck beds, the newest of the Oolites. The great series of the Chalk formations has hitherto yielded no mammalian fossils. We are certainly acquainted with only a small fraction of the mammals of the Secondary measures. When more continued and careful research is made, greater results must follow. Mr Beckles recently uncovered 22 yards square of the very thin dirt-bed of the Purbeck, from which previously the remains of only a single species had been obtained, and this very limited space yielded up to him the remains of no less than twelve or thirteen new species.

As we rise through the Tertiary deposits, the number of mammalia greatly increase. Nearly fifty species were described by Cuvier from the Eocene strata of the Paris basin; and since his time, numerous additions have been made by Owen and others. They are chiefly pachyderma, belonging to the genera *Palaotherium*, *Anoplotherium*, *Hyracotherium*, &c.; but with them are associated the remains of an opossum and of several carnivorous animals. Not only do the number of species increase in the Miocene beds, but they represent a larger number of Orders. There have been discovered two monkeys, numerous proboscidian pachyderma, as the *Dinotherium*, *Mastodon*, and *Elephant*, two or three cetaceans, an enormous ant-eater, and several carnivora. The fossils of the Pleiocene and Pleistocene beds are still more numerous, and represent a race of animals not unlike the living fauna, but generally of a gigantic size. The elephants, elks, and bears of Europe were the contemporaries of immense sloths and armadillos in South America, and of huge kangaroos and birds in Australasia. Associated with the bones of some of these extinct species have been found flint implements, and even the bones of man, but under circumstances that have caused great difference of opinion amongst observers as to their true age. See MAN.

MAMMARY GLAND, ANATOMY OF. See BREAST.

MAMMARY GLAND, DISEASES OF. The

following are some of the most important of these affections.

Acute inflammation of the breast, which is characterised by great swelling, tenderness, pain, and fever. There is a knotty feeling in the inflamed part, and matter soon forms; but the abscess is often slow in pointing. The affection may occur at any period of lactation, and sometimes arises from very trifling causes—as a loaded state of the bowels, too stimulating a diet, &c. The bowels should at once be cleared out by sharp purgatives; leeches and fomentations should be applied; the arm on the affected side should rest in a sling; and an opening should be made where matter can be felt. The milk should also be regularly drawn off, if it can be done without extreme pain.

Sore nipples are a frequent cause of the preceding disease. Amongst the remedies for excoriations, cracks, fissures, and ulcerations of the nipple which cause great pain in suckling, are the application of strong astringent lotions (tannin lotion, for example), touching the sore point with solid nitrate of silver (lunar caustic), and especially the application of collodion. In bad cases, a metallic shield must be placed on the nipple, to protect it from the clothes and from the child's mouth. The regular application of a liniment of rectified spirits and olive oil in equal parts will sometimes prevent this affection.

The mammary gland is also liable to hydatid disease (see HYDATIDS), to the morbid growth known as chronic tumour, serocystic disease, or glandular tumour, &c., and to Cancer (q. v.).

MAMMEE APPLE (*Mammea Americana*), a highly esteemed fruit of the West Indies (where it is sometimes called the *Wild Apricot*) and tropical America. It is produced by a beautiful tree of the natural order *Guttifera*, 60–70 feet high. The fruit is roundish, from the size of a hen's egg to that of a small melon, with a thick leathery rind, and a very delicate inner rind adhering closely to the pulp, which must be carefully removed on account of its bitter taste. The pulp is firm and bright yellow, with peculiar sweet and very agreeable taste, and a pleasant aromatic odour.—A similar fruit is produced by *Mammea Africana*, an African species.

MAMMOLA, a town of South Naples, in the province Calabria Ultra, seven and a half miles from Gerace. It stands in a beautiful and fertile district on the Locano. Pop. (1859) 8108.

MAMMOTH, the Russian name for the fossil elephant, whose remains are so common in the recent deposits of Northern Europe. For a description of it, see the article FOSSIL ELEPHANT. The name is sometimes erroneously given to the mastodon.

MAMMOTH CAVE, the largest known cavern in the world, is in Edmonson County, Kentucky, United States of America, near Green River, 130 miles south-south-west of Lexington, on the road to Nashville. It consists of a series of caverns, with communicating passages, and has been explored to a distance of ten miles. In the cavern, is a river crossed by a boat; two kinds of fishes have been caught in its waters: one without eyes, the other with eyes, but blind. Stalactites hang from the limestone rocks, and the earth is rich in nitre. The equable temperature and nitrous atmosphere of the cavern having been recommended as a remedy for diseases of the lungs, a hotel was built in one of the larger chambers of the cave, for the accommodation of consumptive and asthmatic patients; but the use of it has been long discontinued. There are many circumstances to prove that the Mammoth

Cave is part of the course of a subterranean river which existed in a former condition of the surface.

MAMUN, ABU'L ABBAS ABDALLA AL, Calif of Bagdad, of the Abbaside dynasty, and son of Hārūn Al-Raschid, was born in Bagdad, 786, and brought up along with his brothers under the care of the most illustrious men of the time. In 800 A. D. he was invested with the government of Khorassan; and after dispossessing his elder brother, Al-Amin, who had ascended the throne on the death of their father, became calif, 4th October 813. His reign was disturbed by internal dissensions, and rebellions of the outlying provinces. Africa and Yemen declared themselves independent, the subjection of Egypt, Syria, and Mesopotamia was merely nominal, but the rest was well and beneficently governed. Civilisation advanced with rapid strides; ruined towns and devastated tracts were restored; and distributions from the royal treasury made to those who had suffered from earthquakes, drought, or any other unavoidable cause. In 827, M. abjured the orthodox religion, and joined the heterodox sect called Motezalis, compelling a number of his subjects to follow his example. Towards the close of his reign, a war broke out with the Greek emperor Theophilus, and soon afterwards M. died, 9th August 834. M. was the most learned and liberal of the Abbaside califs, and is said to have expended 300,000 dinars (£137,500) on the translation of the works of the ancient Greek philosophers into Arabic, these works having been presented to him by the Byzantine emperor. He highly encouraged mathematics and astronomy, founded observatories at Bagdad and Kasim (near Damascus), caused a degree of latitude to be measured, and the obliquity of the ecliptic to be estimated. His new city of Bagdad became the abode of men of science and letters, who flocked to it from all quarters; and M. himself personally superintended their labours. M. has left three works, two of which are on religious subjects.

MAN. Under this heading, it is proposed to consider various topics relating to the physiology and natural history of man, which have not been treated of in independent articles, such as the development of the physical qualities of man, the distinctive characteristics of man, and the antiquity of the human race. The question of the races or varieties of man has been already discussed in the article ETHNOLOGY; and for information regarding the mental and social nature of man, the reader is referred to the articles ETHICS; INSTINCT; INTELLECT; MIND, &c.

In tracing the development of the physical qualities, we shall follow the arrangement pursued by Quetelet in his celebrated treatise *Sur l'Homme*.

It is a very remarkable fact, the true causes of which we do not know, that more boys are born annually than girls. Taking his data from the principal European states, M. Bickes (quoted by Quetelet), who has collected more than seventy million of observations, finds that in Europe generally 106 males are born to 100 females. In Great Britain, the ratio is not quite so high, being 104.75 to 100. To some extent, the age of the parents influences the sex of the children, and Mr Sadler was led to the conclusion, that 'the ratio in which the sexes are born is regulated by the difference of age of the parents, in such a manner that the sex of the father or the mother will preponderate beyond the average of the total number of births, according to the party which has the excess of age.'

The probable value or duration of life immediately after birth is, in general, about 25 years in Belgium (Quetelet), 32.2 in France, 33 years in England

(Riokman), and 47.2 in Geneva (Lombard). Towards the age of five years, the chances of prolonged life for both sexes is greatest, ranging from 43 to 50 years. It is impossible to state with scientific precision what is the natural length of man's life, when all abnormal disturbing causes are removed; but so few persons exceed the age of 100 years, that a century may be taken as the limit of man's existence.

The development of the height, weight, and strength, at different ages, has been studied by Quetelet, J. D. Forbes, Danson, and others. From a large number of observations made by Quetelet in Belgium, he deduces the following conclusions:

1. From birth there is an inequality both in weight and height between children of the two sexes: the average weight of a boy at birth being 3.20, and that of a girl 2.91 kilogrammes (1 kilogramme = 2.2 lbs.); the height of a boy being .496, and that of a girl .483 metres (1 metre = 3.28 feet). 2. The weight of a child diminishes slightly towards the third day after birth, and does not begin to increase sensibly until after the first week. 3. At equal ages, the boy is generally heavier than the girl. It is only at about the age of 12 that the individuals of both sexes are of the same weight. Between 1 and 11 years, the difference in weight ranges from a kilogramme to a kilogramme and a half; between 16 and 20, it is nearly 6 kilogrammes; and after this period, 8 to 9 kilogrammes. 4. When man and woman have attained their full development, they weigh almost 20 times as much as at birth; while their height is about 3½ times greater than it was at that period. 5. In old age, man and woman lose about 6 or 7 kilogrammes in weight, and 7 centimetres in height. 6. Man does not acquire his complete growth till after he has completed his 25th year; he attains his maximum weight at 40, and begins to waste sensibly after his 60th year. 7. Woman attains her maximum weight at the age of 50. During her reproductive period, the increase of her weight is very slight. 8. The weight of individuals who have been measured, and who were fully developed and well formed, varies within extremes which are nearly as 1 to 2; while the height varies within limits which at most are as 1 to 1½, as may be seen from the following observed values:

	Maximum.	Minimum.	Average.
Weight of man, .	96.5 kilog.	49.1 kilog.	63.7 kilog.
" woman, .	83.8 "	39.3 "	55.2 "
Height of man, .	1.860 metres,	1.476 metres,	1.684 met.
" woman,	1.740 "	1.468 "	1.579 "

Quetelet has instituted a series of experiments on the strength of persons of both sexes at various ages. He determined both the lumbar power (the weight that could be carried on the back) and the power of the hands by means of Regnier's dynamometer.

From his tabulated results, it appears that the lumbar power of females differs less from that of males during childhood than subsequently. During childhood, the lumbar power of boys is about one-third more than that of girls; towards the age of puberty, one-half; while in adult life it is more than twice as great. The average strength of a well-developed man is 89 kilogrammes, or nearly 19 kilogrammes more than his weight in his dress, so that such a man might hold on for a short time by a rope with a weight of 19 kilogrammes attached to his body. From experiments on the power of the hands, it appears that the manual power of the male sex is greater than that of the female at all ages. Before puberty, the ratio is 3 to 2, and it afterwards becomes 9 to 5. It also appears that the hands acting together produce a greater effect than the sum of the effects they produce when

acting singly; and that the right hand is about one-sixth stronger than the left.

Principal Forbes has made a series of experiments on English, Scotch, and Irish students, which, in most respects, are strongly confirmatory of Quetelet's results, but which evince the superior development of the natives of this country, especially in strength. The following numbers are selected from Forbes's tables:

WEIGHT IN POUNDS, INCLUDING CLOTHES.

Age.	English.	Scotch.	Irish.	Belgian. (Quetelet.)
16	127	125.5	129	117.5
20	144	146.5	148	143.0
24	180	180.0	185	160.5

HEIGHT IN INCHES, INCLUDING SHOES.

Age.	English.	Scotch.	Irish.	Belgian. (Quetelet.)
16	66.5	66.6	66.3	64.2
20	68.7	69.1	69.3	67.9
24	68.9	69.3	70.2	68.2

STRENGTH IN POUNDS.

Age.	English.	Scotch.	Irish.	Belgian. (Quetelet.)
16	326	314	...	236
20	385	369	416	310
24	462	481	481	337

If we proceed to compare the human figure with that of the animals which in their form approximate most closely to man (viz., the anthropoid apes), the chief point that strikes us is the great relative size of the human brain-case and brain, and the comparatively small size and vertical direction of the face; the great length and muscularity of the lower extremities, and their adaptation to the erect position; the adaptation of the hand to the great variety of actions of which it is capable, due mainly to the fact, that the thumb can be opposed to the extremities of all the fingers, whether singly or in combination; the greater breadth of the pelvis, &c.

Those, however, who are inclined to support Mr Darwin's hypothesis, maintain, that whatever system of organs be studied, the comparison of their modifications in the ape series leads to one and the same result—that the structural differences which separate man from the gorilla and the chimpanzee are not so great as those which separate the gorilla from the lower apes. This by no means implies that the structural differences between man and the highest apes are small and insignificant; it is admitted, on the contrary, 'that they are great and significant; that every bone of a gorilla bears marks by which it might be distinguished from the corresponding bone of a man; and that, in the present creation, at any rate, no intermediate link bridges over the gap between *Homo* and *Troglodytes*.'—Huxley.

The last point we shall notice is: When did Man first appear upon the surface of the globe? All that can be definitely stated upon this subject is, that the geological researches of Boucher de Perthes, Falconer, Prestwich, Sir Charles Lyell, and many others, shew that while it is impossible to fix the date of Man's appearance, or even to approximate to it, there is apparent evidence of his existence far beyond that which is assigned by our popular chronology. The flint implements which have been discovered in the lower gravels of Abbeville and elsewhere, have been already noticed in a special article, and their occurrence in association with the fossil bones of extinct mammals, and the other evidence of their antiquity deduced from their geological position, have been there described.

The Brixham caverns afford similar and corroborative evidence of the antiquity of man. They were discovered accidentally in 1858 by the roof of one of them falling in. Below a thick stalagmite crust, which formed their floor, and which contained some of the bones of the cave-bear, was a mass of loam of an ochreous red colour, in some parts 15 feet in

thickness, in which were found remains of the mammoth, an extinct rhinoceros, the cave-bear, &c., and from various parts of these deposits flint-knives were obtained. Under the bone-deposit was a bed of gravel, which in some parts was more than 20 feet thick. It contained no fossils, but even in its lowest parts were found specimens of flint-knives. The fabricators of these knives must have lived long antecedently to the time when the work of their hands was covered with stalagmite; and contemporaneous with the stalagmite must have been the cave-bear, whose bones were imbedded in it. The ossiferous caves of South Wales (Gower), Somersetshire, Sicily, &c., yield results of a similar nature.

There is reason to believe that in the island of Sardinia the land has risen 300 feet since man inhabited its shores, possessing at that time the art of fishing by nets and of making a coarse pottery. The western extremity of the island of Crete has been raised about 25 feet since the construction of its ancient ports, which are now high and dry above the sea. Supposing the movement to have been uniform and equal in the two islands, the mussel-beds of Cagliari (in Sardinia) must have emerged from the sea more than 20,000 years ago; but before that time, man fished the waters over them, if Count De la Marmora is right in conjecturing that a flat ball of baked earthen-ware, with a hole through its axis (which was found imbedded among them), was used for weighting a fishing-net.

Our last illustration shall be taken from the New World. Agassiz estimates that the southern half of the peninsula of Florida, which is built up of coral reefs, took 135,000 years to form; and hence he would estimate the age of the human jaws and teeth, and bones of the feet found in one of the coral banks, to be 10,000 years old.

For further information on this interesting and difficult subject, we must refer the reader to Sir Charles Lyell's work *On the Antiquity of Man*. It is right to add, that many still dispute the conclusions drawn from these facts; see *Transactions of the British Association for 1863*.

MAN, ISLE OF, is situated in the Irish Sea, in N. lat. $54^{\circ} 3' - 54^{\circ} 25'$, and W. long. $4^{\circ} 18' - 4^{\circ} 47'$; the shortest distance between the island and the adjacent countries being from Point of Ayre to Burrow Head in Scotland, 18 miles. The length of the island is $33\frac{1}{2}$ miles, breadth $12\frac{1}{2}$ miles, and area about 180,000 acres, of which more than 90,000 are cultivated. At the south-western extremity is an inlet called the Calf of Man, containing 800 acres, a large portion of which is under cultivation. A chain of mountains extends from north-east to south-west, the highest of which is Snaefell, 2024 feet above the mean sea-level: from its summit, the view is very imposing; the picturesque glens and undulating country in the foreground; the rich plains of the north and south of the island in mid-distance; and beyond, the Irish Sea, bounded by the high lands of the surrounding countries, on which even the corn-fields may be descried. Several streams take their rise in these mountains, in some of which trout abound, though in many the fish have been destroyed by the washings from the lead mines. The coast-scenery from Manghold Head on the east, passing south to Peel on the west, is bold and picturesque, especially in the neighbourhood of the Calf, where Spanish Head, the southern extremity of the island, presents a sea-front of extreme grandeur.

The greater part of the island consists of clay-slate under various modifications. Through the clay-schist, granite has burst in two localities, in the vicinity of which mineral veins have been discovered, and are extensively worked. Nearly 3000 tons of lead are extracted annually, as well as considerable

quantities of copper, zinc, and iron; the lead ore is very rich in quality, as much as 108 oz. of silver having been occasionally extracted from the ton. Old red sandstone and conglomerate are found in the neighbourhood of Castletown and Peel. The carboniferous rocks exist only in the south, extending from Port St Mary to Derby Haven: these consist of three classes, viz., the lower carboniferous limestone; the upper carboniferous, consisting of a mass of fossils; and what has been termed Posidonia Schist, or Poolvash black marble, which is extensively used for mantel-pieces, &c. Trap-dykes intersect the whole of the southern district, especially on the south-west side of Castletown Bay, where the Stack of Scarlett forms a conspicuous mass of basaltic rock. Greenstone is found in many parts of the mountain-chain. There is no trace of coal. Terraces of drift-gravel at various elevations evidence frequent changes of sea-level.

The island is divided into six *sheadings*; these into parishes, of which there are seventeen; these, again, into *treaws*; and, lastly, into *quarterlands*.

The towns are Castletown (q. v.), the capital and the seat of government, Douglas (q. v.), Peel (q. v.), and Ramsey (q. v.).

The Isle of Man possesses much to interest the antiquary. Castle Rushen (see CASTLETOWN), probably the most perfect building of its date extant, was founded by Guthred, son of King Orry, in 947. The ruins of Rushen Abbey, dated from 1154, are picturesquely situated at Ballasalla. There are numerous so-called Druidical remains and Runic monuments throughout the island.

The population of the island was, in 1861, 52,469; in 1851, 52,387; the small rate of increase being attributable to emigration. The language spoken by the natives is a dialect of the Celtic, and is closely allied to the Gaelic and the Erse or Irish. As a spoken language, it is likely to become almost entirely disused in the course of another generation.

The climate is remarkable for the limited range of temperature, both annual and diurnal; westerly and south-westerly winds greatly predominate; easterly and north-easterly winds occurring chiefly in the autumn quarter. Myrtles, fuchsias, and other tender exotics flourish throughout the year. The following data are the result of observations as published in the Registrar-general's Reports, taking an average of seven years, ending September 1860: Summer (June, July, and August), mean temperature, $56^{\circ} 17'$; Autumn (September, October, November), mean temperature, $49^{\circ} 07'$; Winter (December, January, February), mean temperature, $40^{\circ} 90'$; Spring (March, April, May), mean temperature, $44^{\circ} 70'$; mean annual rain-fall, 30.2 inches.

The fisheries afford employment to nearly 4000 men and boys. More than 600 boats of various tonnage are employed in the herring and cod fisheries, the average annual produce being above £60,000. In addition to these, about 500 English and Irish boats arrive at the island during the fishing season. Besides the herrings consumed fresh, there are about 40,000 barrels cured, each barrel containing 800 herrings. In 1862, 2439 vessels of 178,681 tons entered and cleared from the Isle of Man.

Agriculture has of late years made considerable progress. Tracts of the finest wheat-land are in the vicinity of Castletown, and in the north of the island. Large numbers of fat cattle are shipped to the English markets, as well as about 20,000 quarters of wheat annually. The manufactures are inconsiderable.

The revenue derived from the island by the British government amounts to about £35,000 per annum; of which more than £29,000 is received from customs' duties, the remainder being the land

revenues of the crown, such as mine royalties, lords' rents, &c.

The principal line of communication with the United Kingdom is between Douglas and Liverpool, by means of a fine fleet of swift steamers. There is a submarine telegraphic cable between Maughold Head and St Bees Head, near Whitehaven.

Previous to the 6th c., the history of the Isle of Man is involved in obscurity; from that period, it was ruled by a line of Welsh kings, until near the end of the 9th c., when the Norwegian, Harald Haarfager, invaded and took possession of the island. According to tradition, in the beginning of the 10th c., Orry, a Dane, effected a landing, and was favourably received by the inhabitants, who adopted him as their king: he is said to have been the founder of the present Manx constitution. A line of Scandinavian kings succeeded, until Magnus, king of Norway, ceded his right in the island and the Hebrides to Alexander III. of Scotland, 1266 A.D.; this transference of claim being the direct result of the disastrous failure of the expedition of Hacon of Norway against the Scots in 1263. On the death of Alexander, the Manx placed themselves under the protection of Edward I. of England by a formal instrument dated 1290 A.D.; on the strength of this document, the kings of England granted the island to various royal favourites from time to time until the year 1406, when it was granted to Sir John Stanley in perpetuity, to be held of the crown of England, by rendering to the king, his heirs, and successors, a cast of falcons at their coronation. The Stanley family continued to rule the island under the title of Kings of Man, until James, the 7th Earl of Derby, adopted the humbler title of Lord, on his accession to the government. In 1651, the island was surrendered to a parliamentary force by Receiver-general Christian, who had raised an armed body against the government, which was then in the hands of the Countess of Derby: the parliament having thus obtained possession of the island, granted it to Thomas Lord Fairfax. On the Restoration, the Derby family were again put in possession. On the death of James, 10th Earl of Derby, without issue in 1735, James, 2d Duke of Athol, descended from Amelia Sophia, youngest daughter of James, the 7th Earl of Derby, became Lord of Man. The Isle of Man having been for a long period the seat of an extensive smuggling-trade, to the detriment of the imperial revenue, the sovereignty of it was purchased by the British government, in 1765, for £70,000, the duke still retaining certain manorial rights, church patronage, &c. After negotiation and sales from time to time, the last remaining interest of the Athol family in the island was transferred to the British crown by John, the 4th duke, in January 1829; the amount paid for the island having amounted in the aggregate to £487,144.

The Isle of Man forms a separate bishopric under the title of Sodor and Man. The bishopric of the Sudoreys, or Southern Isles, was for a time annexed to Man, hence the title of Sodor, which is still retained, the name having been applied to the islet of Holm Peel, on which the cathedral church of the diocese stands. This bishopric is said to have been founded by St Patrick in 447. The Manx Church has its own canons, and an independent convocation. The see is, for certain purposes, attached to the province of York. There are in the island about 40 places of worship in connection with the Established Church of Man. The livings are, with few exceptions, in the gift of the crown. The principal denominations of dissenters are represented in the island.

The Isle of Man has a constitution and govern-

ment of its own, independent of the imperial parliament. It has its own laws, law-officers, and courts of law. The legislative body is styled the Court of Tynwald, consisting of the Lieutenant-governor and Council—the latter being composed of the Bishop, Attorney-general, two Deemsters (or Judges), Clerk of the Rolls, Water Bailiff, Archdeacon, and Vicar-general—and the House of 24 Keys, who are the legal representatives of the people. On a bill being introduced, it is separately considered by both branches, and on being passed by them, is transmitted to her Majesty for the royal assent; it does not, however, become law until it is promulgated in the English and Manx languages on the Tynwald Hill, an artificial mound near the centre of the island, which has been used for the purpose from time immemorial.

The ancient arms of the Isle of Man were a ship with her sails furled; these were continued until 1270, when the present arms were substituted, viz., *gules*, three legs of man in armour, conjoined in fesse at the upper part of the thighs, flexed in triangle, garnished and spurred, or, with the motto on garter surrounding, *Quocumque jeceris stabit*.

Works of reference: *The Isle of Man, its History, &c.*, by the Rev. J. G. Cumming, M.A., F.G.S.; *History of the Isle of Man*, by Joseph Train, F.S.A., Scot. For climate as adapted for invalids, see *Consumption in its Early and Remediable Stages*, by Dr E. Smith, LL.B., F.R.S.

MANAAR, GULF OF, lies between the west side of the island of Ceylon and Hindustan, and is divided from Palk's Passage on the north by the islands of Ramisseram and Manaar, and by a low reef called Adam's Bridge. At its north-east extremity, it is 80 miles in width; while at its south-western limit it reaches a width of nearly 200 miles.

MANAOA (*Franciscea uniflora*, or *Hopeana*), a plant of the natural order *Scrophulariaceae*, a native of Brazil. The whole plant, and especially the root, is found to be of great value in exciting the lymphatic system. It is nauseously bitter, purgative, emetic, emmenagogue, and alexipharmic; in overdoses, an acrid poison. It is much used in Brazil as a remedy for syphilis.

MANACOR, a town in the island of Majorca (q. v.), in a fertile plain, 30 miles east of Palma. It manufactures brandy, wine, oil, and verdigris, and has a population of 10,500.

MANA'SSEH (from Heb. *Nasha*, to forget, signifies 'one who causes to forget'), the name of the eldest son of Joseph.—At the Exodus, the tribe of Manasseh is said to have counted 32,200 warriors, and on entering Canaan, 52,700. It received land on both sides of the Jordan. The eastern half embraced the rich pasture-lands of Argob and Bashan, as far as the slopes of Hermon; the western extended from the Jordan to the Mediterranean, and lay between Ephraim and Issachar.—MANASSEH was also the name of one of the kings of Judah (the fourteenth), who succeeded his father Hezekiah, 699 B.C., at the age of 12, and reigned, according to the narrative, for 55 years. He rushed headlong into all manner of idolatry, and seduced the people to follow his example. The sacred writers cannot otherwise express their sense of the enormity of his guilt, than by saying that the very heathen never went so far in their practice of abominations as Judah did in those days. His subsequent history is differently related in *Chronicles* and in the *Book of Kings*.—The apocryphal composition called the *Prayer of Manasses* is received as canonical by the Greek Church.

MANATEE, or **LAMANTIN** (*Manatus*), a genus of herbivorous Cetacea or *Manatida* (q. v.), readily distinguished by the rounded tail-fin, and further characterised by the presence of small flat nails at the edge of the swimming paws, and by the structure of the grinders, which have square crowns with two transverse ridges. The species, which are all inhabitants of tropical coasts, feed not only on algae, but on the plants which grow along the shore, and are rendered accessible to them by the tide, which, after it has retired, often exhibit plain proofs of their browsing. They live chiefly in shallow bays and creeks, and in the estuaries of rivers, and often ascend rivers to a great distance from the sea. The best known species (*M. Americanus*) is found in the West Indies and on the western coasts of tropical America. It sometimes attains a length of 20 feet, and a weight of three or four tons. The skin is very thick and strong, and is almost destitute of hair. The fingers can be readily felt in the swimming paws, and, connected together as they are, possess considerable power of motion, whence the name *M.* (from Lat. *manus*, a hand). The *M.* is usually found in herds, which combine for mutual protection when attacked, placing the young in the centre. When one is struck with a harpoon, the others try to tear out the weapon. The females shew great affection for their young. No animal is more gentle and inoffensive than the manatee. It has been tamed and rendered familiar enough to come for food when called. Vast numbers were formerly found in places where it is now comparatively rare, as its capture is easy, and its flesh—which has been variously likened to beef and pork—is held in considerable esteem. A common name for the *M.* is Sea-cow.—Another species is found on the coast of Florida, and a third on the west coast of Africa.

MANATIDÆ, a family of *Cetacea*, including all the herbivorous section of the order. Besides the distinguishing characteristics mentioned in the article **CETACEA**, they differ from the ordinary *Cetacea* in having swimming paws rather than pectoral fins. It has been supposed that some of the stories of mermaids may have originated in the females of some of the *M.* being seen with the head and breasts raised out of the water. There are three genera of *M.*, described in the articles **DUGONG**, **MANATEE**, and **STELLERINE**.



Manch.

MANCH, or **MAUNCH** (Fr. *manche*), a frequent charge in English heraldry, meant to represent a sleeve with long pendent ends, of the form worn by ladies in the reign of Henry I. Or, a manch gules, has been for a long time the arms of the Hastings family, one of whom was steward of the household to Henry I.

MANCHA, or **LA MANCHA**, a district of Spain, in the province of Ciudad Real, and the southernmost part of the kingdom of New Castile. See **CASTILE**.

MANCHE, a maritime department in the north-west of France, formed from the most western district of the old province of Normandy, derives its name from *La Manche* (the English Channel), which washes its coasts. Greatest length, 98 miles; average breadth, 27 miles; area, 1,426,289 acres. Pop. (1862) 591,421. Of the entire area, 940,047 acres are cultivated, and about 235,000 acres are in meadow. The surface of the department is irregular; hills of no great elevation traverse it from north to south. The *Vire*, the *Douve*, and the *Selune* are the chief rivers. The

climate is mild and temperate, but somewhat humid. Flax, hemp, and fruit are extensively cultivated. Immense quantities of apples are grown, from which 44,000,000 gallons of cider are made annually. Horses of the true Norman breed are reared in the pastures, and excellent cattle of large size are bred in the valleys. The department is divided into the six *arrondissements* of *St Lô*, *Coutances*, *Valognes*, *Cherbourg*, *Avranches*, and *Mortain*. Capital, *St Lô*.

MANCHESTER (Sax. *Mancœstre*), a city, municipal and parliamentary borough of Lancashire, and the great centre of the cotton manufacture of the north-west of England, stands on the *Irwell*, 32 miles east-north-east of *Liverpool*, and 188 miles north-north-west of *London* by railway. On the west side of the *Irwell* is the borough of *Salford*, communicating with that of *M.* by means of a number of bridges, and considered as virtually a portion of the city.

By the census of 1861, the inhabitants of the parliamentary borough of *M.* were 357,604, and the increase from 1851 was 41,391. In the adjoining borough of *Salford*, the population, in 1861, was 102,414, the increase from 1851 having been 17,306. The area of the borough of *M.* is 9.9 square miles; of *Salford*, 7.9 square miles. Both boroughs were enfranchised by the Reform Bill, *M.* returning two members, and *Salford* one member to parliament. *M.* was incorporated in 1838, and *Salford* in 1844. *M.* was made a bishopric in 1847, and received the title of city in 1853. Water for the supply of *M.* is collected on the Lancashire side of *Blackstone Edge*, at *Woodhead*, and conducted from a series of reservoirs through iron-pipes, nearly 20 miles, to the borough. The water-works, in which are invested about £1,430,000, and the gas-works, involving about £450,000, belong to the corporation. The manorial and market rights were also acquired by the corporation in 1845 for the sum of £200,000. There are four public markets in *M.*, and two in *Salford*, besides the cattle-market. *Smithfield Market* in *M.* is more than four acres in extent, and is entirely covered in. The market-tolls of *M.* alone amount to £16,000 per annum. The sale of gas makes a profit of some £40,000 per annum, which is devoted to improvements in the borough. In 1845—1846, a public subscription founded three public parks of about thirty acres each; and *M.* was the first borough to take advantage of the Free Libraries' Act, which allows an appropriation of a penny in the pound on the local assessment for parks, libraries, and museums; and here was established the first free lending library in England. Three branch lending libraries and a museum have since been established in *M.*, and one reference library and an excellent museum in *Salford*; so that, including the old college library founded by *Sir Humphrey Chestham*, 1662, the people have the free use of upwards of 100,000 volumes of ancient and modern literature.

The two boroughs have 68 churches belonging to the establishment. The cathedral, formerly the *Old Church*, built 1422, is a very fine Gothic structure, and has latterly undergone a very extensive process of restoration in its original style. There are 10 Roman Catholic and 101 dissenting chapels, some of which, especially the Catholic Cathedral and *Cavendish Independent Chapel*, are very beautiful specimens of modern Gothic architecture. There are 2 Jewish synagogues, 2 German churches, and 1 Greek church. The principal public buildings for secular purposes are the *Town Hall*, the *Royal Infirmary*, the *Royal Exchange*, the *Royal Institution*, all in the Grecian style; the *Free Trade Hall*, in Composite; and the new

Assize Courts, in decorated Gothic. The assize courts cost about £100,000. Many of the warehouses of the merchants are palatial in appearance, and the business transacted is quite in accordance with the magnitude of the buildings. The floor of the Royal Exchange contains about 1800 square yards, and is yet too small for the numbers who throng it on market-days. M. has four private and five joint-stock banks, besides branches of the Bank of England, and the National Provincial Bank. The assessment of municipal M., in 1862, was £1,514,721, and of Salford, £360,000. The celebrated Bridgewater Canal connects M. with Liverpool, and access is also obtained for heavy barges by the Irwell and Mersey; and there is likewise communication by railway. See **CHAT MOSS**. The London and North-western; the Lancashire and Yorkshire; the Manchester, Sheffield, and Lincolnshire; and the Manchester, Altrincham, and South Junction Railway Companies have access to M. by their own lines; whilst the Great Western, the Great Northern, the Midland, and the North Staffordshire have running powers over the other lines.

The chief trade is spinning and manufacturing cotton, but there are also considerable manufactures of silk and mixed goods, of small-ware, of machinery and tools; and M. is also a dépôt for all kinds of textile fabrics, and does a very large export trade. In 1860, M. had 95 cotton mills, 13 silk mills, 16 small-ware mills, 37 dye-works, 48 iron foundries, and 63 machinists' workshops. There are ordinarily employed in the cotton mills about 60,000 persons, who earn about £30,000 per week in wages. There are at least 7000 skilled mechanics constantly engaged in the production of steam-engines, spinning-mules, looms, and other machinery, chiefly for the production of the various textile fabrics, whose wages average about 2s. each per week, and who need some 1500 labourers to assist them.

The educational endowments of M. are small compared with its great population. There is a hospital school for 100 boys, founded by Sir Humphrey Cheetham, and incorporated by Charles II.; there is also a free grammar-school, with about 300 pupils, founded 1519, by Hugh Oldham, D.D., Bishop of Chester. There is a school, called the Jubilee School, for orphan girls; and there are also schools for the deaf and dumb, and for the blind, which are all supported by voluntary subscription. In 1854, a secular school for 350 boys was established, in order to prove that children of all the various sects could be advantageously taught together, and it has since been kept up by voluntary subscription for the education of children whose parents are wholly unable to pay. In a parliamentary inquiry in 1853, the number of day-scholars in M. was shewn to be 27,000, and the Sunday-scholars 52,000, and in evening schools and literary institutions from 4000 to 5000 pupils. In 1848 John Owens, a Manchester merchant, left £100,000 in the hands of trustees to found a college for secular instruction; and in connection with that institution, there are now 92 day and 287 evening students, of whom 17 matriculated in the examination of the University of London in 1863. The college is well conducted, and is steadily rising in popularity. A mechanics' institution was commenced in 1824, and is still carried on successfully. It has day and evening classes, a good library, and reading-room, and all the necessary appliances for secondary education. Similar institutions on a smaller scale exist in Salford, and in the out-townships of Longsight, Rusholme, Harpenhey, Cheetham Hill, and Pendleton. In M. originated the agitation for free-trade (see **ANTI-**

CORN-LAW LEAGUE). M. was also the first place to secure the privilege of inland bonding for articles chargeable with customs-duties, and now produces a large revenue from that source.

Camden, who died in 1623, says: 'Where the Irk runs into the Irwell, on the left-hand bank, and scarce three miles from the Mersey, stands that ancient town called in *Antoninus* (according to different copies), *Mancunium* and *Manutium*. Perhaps, as an inland town, it has the best trade of any in these northern parts. The fustian manufacture, called *Manchester cottons*, still continues there; this, with a great variety of other manufactures, called *Manchester wares*, renders not only the town itself, but the parish about it rich, populous, and industrious.' The parish of M. covers a large area, reaching to Stockport, Oldham, and Ashton-under-Lyne, and in the early part of the 16th c. was reckoned to have 20,000 communicants.

MANCHESTER, a city of New Hampshire, United States of America, on the east bank of the Merrimac River, at the falls of Amoskeag, 18 miles south of Concord, 59 miles north-west of Boston. The town is laid out in broad streets, shaded with elms, with five public squares. The falls of 54 feet in a mile afford water-power to ten manufacturing companies, with factories of cotton, paper, locomotives, hardware, &c. There are also extensive print-works and starch-mills. There are fourteen churches, forty public schools, seven banks, two daily and five weekly newspapers. Pop. in 1838, 50; in 1860, 20,107.

MA'NCHINEEL (*Hippomane Mancinella*), a tropical American tree of the natural order *Euphorbiaceae*, celebrated for the poisonous properties of the acrid milky juice with which every part of it abounds. A drop of this juice, which is of a pure white colour, burns like fire if it falls upon the skin, and the sore which it produces is very difficult to heal. The Indians of tropical America use it for poisoning their arrows. The fruit is in form, colour, and scent not unlike a small apple—the name is from the Spanish *mancinilla*, a small apple—and contains a nut about the size of a chestnut. The fluid which the fruit contains is milder than that of other parts of the tree, but its acridity is so great as immediately to repel any who, tempted by its appearance and citron-like fragrance, may ignorantly attempt to eat it. The leaves are alternate, ovate, serrate, and shining. It is said that, owing to the volatile nature of the poisonous juice, persons have even died from sleeping under the shade of the M. tree. Much seems to depend on the state of the atmosphere, and there is good evidence that rain or dew falling from the branches of the M. does produce injurious effects. The fruit of M., dried and pulverised, is diuretic; the seeds are excessively so. The wood is of fine quality, and well suited for cabinet-making. Whole forests of M. at one time existed in Martinique, which have been burned down. It grows chiefly in the vicinity of the sea. *Cameraria latifolia*, another West Indian tree, of the natural order *Apocynaceae*, is called **BASTARD M.**, from its resemblance to M. in its poisonous properties.

MAND. See **ELEUSINE**.

MANDAMUS is a prerogative writ which issues from the Court of Queen's Bench, and in some cases a similar writ issues also from the other superior courts of law, whereby the court commands some public body, or inferior court, or justices of the peace, to do something which it is their legal duty to do, and the neglect of which there is no other way of redressing.

MANDARIN, a general term applied to Chinese officers of every grade by foreigners. It is derived from the Portuguese *mandar*, to command; the Chinese equivalent is *kwon*. There are nine ranks, each distinguished by a different-coloured ball or button placed on the apex of the cap, by a peculiar emblazonry on the breast, and a different clasp of the girdle. The balls are ruby, coral, sapphire, a blue opaque stone, crystal, opaque white shell, worked gold, plain gold, and silver. Theoretically, these grades are indicative of relative merit, but as office and titles are sold to a great extent, the competitive examinations, which are the only legitimate road to distinction, have lost much of their value. A mandarin is not allowed to hold office in his native province, the intention being to prevent intrigue, and to draw to Peking the ambition and talent of the country, where temporary employment is given in subordinate offices, prior to appointments to the provinces. He is not allowed to marry in the jurisdiction under his control, nor own land in it, nor have a near relative holding office under him; and he is seldom continued in office in the station or province for more than three years—a system of espionage which serves further to strengthen the imperial government. It is incumbent on every provincial officer to report on the character and qualifications of all under him, which he periodically transmits to the Board of Civil Office; the points of character are arranged under six different heads, viz., those who are not diligent, the inefficient, the superficial, the untalented, superannuated, and diseased. According to the opinions given in this report, officers are elevated or degraded so many steps in the scale of merit, like boys in a class. They are required also to accuse themselves when remiss or guilty of crime, and to request punishment.

MANDATE is a contract by which one employs another to manage something gratuitously for him. The one is called a mandant, and the other a mandatory; the term being derived from the Roman law of *mandatum*. In England, in consequence of the doctrine, that a simple contract cannot be enforced unless there is some consideration for it, or a *quid pro quo*, it is held that if the mandatory undertakes to do the work, but omits to do so, no action will lie against him, though it is otherwise if he once enter upon the work, in which case he is bound for the consequences of anything injurious or negligent. If the duty or work is undertaken, the mandatory is bound to use reasonable skill and diligence. In Scotland, where a consideration is not necessary to make a valid contract by word of mouth or writing, the mandatory is liable to an action if he has contracted or agreed to act. In Scotland, the word mandatory is used to denote a person who, in a litigation by a foreigner or person residing out of Scotland, undertakes to give security for costs, in the event of the mandant losing the suit, otherwise the suit is not allowed to go on in Scotland.

MANDAVI, the chief seaport of the principality of Cutch, Hindustan, on the north shore of the Gulf of Cutch, in lat. 22° 51' N., long. 69° 26' E. Though there is no regular landing-place, boats of any size can land at the sandy beach, and large vessels find secure anchorage in the offing at a distance of about three miles from shore. Its walls are numerous, and full of water. Pop. variously estimated at from 50,000 to 90,000.

MANDEVILLE, SIR JOHN, an old English traveller, born at St Albans about the year 1300. Prompted by curiosity or love of adventure, he left his native country about 1327, visited the Holy

Land, served under the Sultan of Egypt and the Great Khan of Cathay (China); and after 33 years' wandering through Europe, Asia, and Africa, returned to England, where he wrote an account of his travels in Latin, French, and English. He died at Liège, 17th November 1372. M.'s work is not of great value for historic geography, as he not merely states what came under his own observation, but what he heard; and he was credulous enough to admit what are now regarded as the most absurd and monstrous fables; but to do him justice, he (like Herodotus) customarily prefaces these by the phrases, 'thei seyne, or men seyn, but I have not sene it.' Besides, several of his statements, once regarded as improbable, have since been verified. The common notion of his being pre-eminently a 'lying' traveller, is therefore in all likelihood not well founded. Leland the antiquary even says that he had the reputation of being a very conscientious man. His book is written in a very interesting manner, was long exceedingly popular, and was translated into many languages. A MS. of M.'s travels, as old as the time of the author, exists in the Cottonian Library. The first edition printed in England is that by Wynkin de Worde (Westminster, 1499); the last, with Introduction, &c., by J. O. Halliwell, was published in London in 1839.

MANDIBULATA, **MANDIBULATED** or **MASTICATING INSECTS**, a great group or division of Insects (q. v.), having the mouth of the structure described in the article *Coleoptera*, and containing the orders *Coleoptera*, *Orthoptera*, *Neuroptera*, and *Hymenoptera*. The *haustellate* mouth—formed for suction—is regarded as a modification, in all its separate parts, of the mandibulate mouth.

MANDINGOES are, strictly speaking, the inhabitants of the most south-westerly territories belonging to the great west African race of the Wangarawa (sing. Wangara), and inhabiting a district extending in lat. from 8° to 12° N., and between the west coasts and the head waters of the Senegal and Niger. The name, however, as generally used, is applied to the whole nation of the Wangarawa, comprising a population estimated by Dr Barth at from 6,000,000 to 8,000,000. The original seat of the M. is said to be Manding, a small mountain country on the eastern sources of the Senegal, whence, partly by conquest and partly by emigration, they have spread themselves over a most extensive tract of country, and now consist of a variety of tribes. The M. are black in colour, tall and well shaped, with regular features, and are, generally speaking, a fine race, capable of a high degree of civilisation and organisation, great travellers, fond of trading, and remarkable for their industry and energy. Of the neighbouring nations, they were the first who embraced Islamism. The greater portion of them are now Moslems, and are zealous propagators of their religion.

MANDOLINE, a musical instrument of the lute species. The body of the mandoline is shaped like a shell, formed of a number of narrow pieces of different kinds of wood, bent into the shape, and glued together. On the open portion of the body is fixed the sounding-board, with a finger-board and neck like a guitar. The Neapolitan mandoline, which is the most perfect, has four double strings, which are tuned, beginning with the lowest, G, D, A, E. The Milanese mandoline has five double strings, tuned G, C, A, D, E. The sound of the mandoline is produced by a plectrum in the right hand, while the left hand produces the notes on the finger-board. The mandoline is chiefly used for accompaniment; in the beauty and quality of

its sound, it is different from all other stringed instruments.

MA'NDRAKE (*Mandragora*), a genus of plants of the natural order *Solanaceae*, nearly allied to *Belladonna* (q. v.). Two species are described by some botanists, the AUTUMNAL *M.* (*M. autumnalis*), which flowers in autumn, and has lanceolate leaves and ovate berries; and the VERNAL *M.* (*M. vernalis*), which flowers in spring, and has oblong-ovate leaves and globose berries. Both are natives of the South of Europe and of the East, and are united by many into one species (*M. officinarum*). The root is large and carrot-like, and from it the leaves spring with



Mandrake (*Mandragora officinarum*).

no apparent stem, and among them the stalked whitish flowers. The calyx and corolla are 5-cleft, there are five stamens, and the fruit is a one-celled berry, about the size of a sparrow's egg. The whole plant has a very fetid narcotic smell; but the fresh berries, when cut or bruised, have a pleasant odour like that of wine or apples, and two or three may be eaten without inconvenience. All parts of the plant, however, have poisonous properties like those of belladonna, but more narcotic, for which reason a dose of the root was formerly sometimes given to patients about to endure surgical operations. The ancients were well acquainted with the narcotic and stupefying properties of *M.*, and it was a common saying, of a sleepy or indolent man, that he had eaten mandrake. The root often divides into two, and presents a rude resemblance to the human figure; and human figures were formerly often cut out of it, to which many magical virtues were ascribed. Sometimes the roots of the bryony were employed instead of those of the *M.*, and sold under the name of *M. root*. From the most ancient times, aphrodisiac virtues have been ascribed to the *M.*, which was therefore supposed to cure barrenness. See Gen. xxx. 14—16. The same reputation has been attached in America to the berries of the nearly allied genera, *Himeranthus* and *Jaborosa*. Many fables connected with the *M.* are recorded by ancient and medieval writers.

MANDRIL. See BABOON.

MANDURIA (formerly *Castel-Nuova*), a town in the Neapolitan province of *Terra di Otranto*, 20 miles east of Taranto. Pop. 7660. It has two celebrated wells, one of which has been minutely described by Pliny, and is remarkable for the unalterable level of its waters. Near to it stood the ancient town of Manduria, of which some important relics are still extant.

MANÉS. See LARES.

MA'NETHO, a celebrated Egyptian historian, native of Sebennytus, and of the sacerdotal order, flourished in the reign of Ptolemy. According to some, he was priest of Diospolis or Heliopolis; others contend that he was high-priest of Alexandria. His name has been interpreted 'beloved of Thoth;' in the *song* of Lagos and Ptolemy Philadelphus, *Mai en tet*, or *Ma Net*, 'beloved of Neith;' but both interpretations are doubtful. Scarcely anything is known of the history of *M.* himself, and he is more renowned for his Egyptian history than on any other account. On the occasion of Ptolemy I. dreaming of the god Serapis at Sinope, *M.* was consulted by the monarch, and in conjunction with Timotheus of Athens, the interpreter of the Eleusinian mysteries, declared the statue of Serapis, brought by orders of the king from Sinope, to be that of the god Serapis or Pluto, and the god had a temple and his worship inaugurated at Alexandria. The fame of *M.* was much increased by his writing in the Greek language, and so being enabled to communicate from Egyptian sources a more correct knowledge of the history of his native country than his Greek predecessors. Of this history, only extracts given by Josephus in his work against Apion, and an epitome by Eusebius and other ecclesiastical writers, remain. It appears to have been drawn up in a compendious annalistic style of narrative, resembling the accounts given by Herodotus. The work of *M.* was divided into three books, the first beginning with the mythic reigns of gods and kings, and ending with the 11th dynasty of mortals; the second book continued the history from the 12th to the 19th dynasty; and the third from the 20th to the 30th dynasty, when Egypt fell under the dominion of Alexander the Great. The reigns of the gods are given as amounting to 24,900 years, and the epoch of Menes, the founder of the monarchy, commenced 3555 years before Alexander (332 B.C.). The difficulties attending the reconciliation of this chronology with the synchronistic history of the Hebrews, Greeks, and other nations, have given rise to numerous speculations and chronological systems since the revival of learning, by Scaliger, Freret, Maraham, Usher, Bunsen, Böckh, Lepsius, Poole, and others. The confusion in which the lists of kings have been transmitted, the ciphers of the lengths of each reign not agreeing with the summations of the durations of the dynasties, and these, again, differing from the total period assigned to the existence of the Egyptian monarchy, has given rise to two or three schools of chronology. The so-called long chronology, which supposes, with Scaliger and Böckh, that the 30 dynasties followed consecutively one after the other, has elevated the epoch of Menes to 5702 B.C. The short chronology, or that which endeavours to square the dates of *M.* with the Hebrew chronology, or 4004 B.C. for the year of the world, on the contrary, assumes that several of the dynasties were contemporary, and that some intervals, such as that of the rule of the Shepherd-kings, have been either exaggerated or misunderstood. The accession of newer and better information from the original sources of Egyptian monuments, papyri, and other documents, has considerably enhanced the general value of the history of *M.*, which, prior to their discovery, had fallen into discredit. But the restoration of the history of *M.*, notwithstanding all these resources, and the positive epoch of the monarchy, are still to be sought, although certain dynasties, in the 2d and 3d books of his work, can be reconciled with monumental evidence. Besides the true work of *M.* above cited, which he appears to have written in the reign of Ptolemy I. or II., another work, called *Sothis*, or the 'Dogstar,' in

allusion to the cycle of the heliacal rising of that star of 1461 years, and dedicated to Sebastos or Augustus, the title of the Roman emperors, and not found in use before that period, has been handed down. This work seems to have been added by the epitomisers; and another work, called the *Old Chronicle*, in which the history was arranged according to cycles, was compiled by them. Besides the history, M. wrote *Tōn Physikon Epitome* (Epitome of Physics), treating on the origin of gods and the world, and the laws of morality; and another work on the preparation of the sacred *kyphi*, a kind of frankincense or aromatic food. The astronomical work called *Apotelesmata* is a spurious production of the 5th c. A. D.

Suidas, *voce* Manetho; Josephus, *Contr. Apion*, i. 3, 9; Bunsen, *Aegyptens Stelle*, Bd. ii.; Fruin, *Manethon. Relig.* (8vo, Leyd. 1847); Böckh, *Manetho* (8vo, Berl. 1845).

MANFRED, king of Naples and Sicily, a rare example of heroic fortitude and disinterestedness, was a natural son of the Emperor Frederick II. by Blanca, the daughter of Count Bonifacius Lanza, and was born about 1231. On his father's death in 1250, he received the principality of Tarentum, and in the absence of his half-brother, Konrad IV., acted as regent in Italy. Notwithstanding Konrad's dislike to him, M., with unexampled fidelity, bravely defended his sovereign's interests against the machinations of Pope Innocent IV.; and after Konrad's death, which the pope accused him of having caused, he was acknowledged as regent of Apulia, in name of his nephew Konradin (q. v.). The pope, however, renewed his pretensions to Apulia, and compelled M. to flee for shelter to the Saracens, by whose aid he defeated the papal troops at Foggia, on 2d December 1254, and again obtained possession of Apulia, to which he soon afterwards added Calabria. The new pope, Alexander IV., caused a crusade to be preached against him; but M. steadily pursuing his victorious career, became, in 1257, master of the whole kingdom of Naples and Sicily. On the rumour of Konradin's death, he was crowned king at Palermo, 11th August 1258, and immediately afterwards was excommunicated by the pope along with his adherents, among whom were the first prelates of the kingdom; but M. invaded the papal dominions, levied heavy contributions from them, and made himself master of the whole of Tuscany. His power now seemed secure, and his government was at once mild and vigorous; he founded many schools, built towns and harbours, and laboured in many ways for the improvement of his kingdom. But this tranquillity was not of long duration. Pope Urban IV. renewed the excommunication against him and his friends, and bestowed his dominions as a papal fief on Charles of Anjou, the brother of Louis IX. of France. M., though at first successful in the war which ensued, was at last treacherously defeated, and slain in a bloody battle at Benevento, 26th February 1266. His widow and children were savagely treated by the French, the daughter being confined for 18, and the sons for 31 years. His body was found some days after, and interred as that of an excommunicated person; but the people, and even the French soldiers, heaped up stones for a monument, which received the name of the Rock of Roses.

MANFREDO'NIA, a city of the Neapolitan province of Capitanata, 26 miles north-east of Foggia, founded by Manfred (q. v.), king of Naples and Sicily, from the ruins of the ancient Sipontum: pop. 7472. It is strongly walled, and an imposing castle protects its port. In the vicinity of M. are remarkable salt lakes—the *Pontano Salso* and the

Lago di Salpi—the beds of which, during the summer heats, are thickly incrustated with salt.

MANFREDONIA, GULF OF (*Sinus Urias*), an inlet of the Adriatic, which washes the Neapolitan provinces of Bari and Capitanata, 15 miles in length, and 30 in breadth.

MANGALO'RE, a seaport on the west coast of Hindustan, in the presidency of Madras, lat. 12° 52' N. In former times, the harbour was good, and the town prosperous, but within the present century, it has become to a great extent silted up. Population, including seven villages in the vicinity, about 20,000. The cantonment on the north side of the town is healthy, being elevated, well drained, and open to the breezes from the sea.

MANGANESE (symb. Mn, equiv. 27.6, specific gravity 8) is one of the heavy metals of which iron may be taken as the representative. It is of a grayish-white colour, presents a metallic brilliancy, is capable of a high degree of polish, is so hard as to scratch glass and steel, is non-magnetic, and is only fused at a white heat. As it oxidises rapidly on exposure to the atmosphere, it should be preserved under naphtha.

It occurs in small quantity in association with iron in meteoric stones; with this exception, it is not found native. The metal may be obtained by the reduction of its sesquioxide by carbon at an extreme heat.

Manganese forms no less than six different oxides—viz., protoxide (MnO), sesquioxide (Mn₂O₃), the red oxide (Mn₃O₄), the binoxide or peroxide (MnO₂), manganic acid (MnO₃), and permanganic acid (Mn₂O₇). The *protoxide* occurs as an olive-green powder, and is obtained by igniting carbonate of manganese in a current of hydrogen. Its salts are colourless, or of a pale rose colour, and have a strong tendency to form double salts with the salts of ammonia. The carbonate forms the mineral known as manganese spar. The sulphate is obtained by heating the peroxide with sulphuric acid till there is faint ignition, dissolving the residue in water, and crystallising. It is employed largely in calico-printing. The silicate occurs in various minerals.

The *sesquioxide* is found crystallised in an anhydrous form in *braunite*, and hydrated in *manganite*. It is obtained artificially as a black powder by exposing the peroxide to a prolonged heat. When ignited, it loses oxygen, and is converted into red oxide. Its salts are isomorphous with those of alumina and sesquioxide of iron. See ISOMORPHISM. It imparts a violet colour to glass, and gives the amethyst its characteristic tint. Its sulphate is a powerful oxidising agent.

The *red oxide* corresponds to the black oxide of iron. It occurs native in *hausmannite*, and may be obtained artificially by igniting the sesquioxide or peroxide in the open air. It is a compound of the two preceding oxides.

The *binoxide*, or *peroxide*, is the black manganese of commerce, and the *pyrolusite* of mineralogists, and is by far the most abundant of the manganese ores. It occurs in a hydrated form in *varvicite* and *wad*. Its commercial value depends upon the proportion of chlorine which a given weight of it will liberate when it is heated with hydrochloric acid, the quantity of chlorine being proportional to the excess of oxygen which this oxide contains over that contained in the same weight of protoxide. The reaction is explained by the equation—

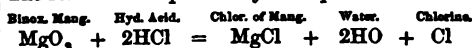

When mixed with chloride of sodium and sulphuric acid, it causes an evolution of chlorine, the other

MANGE—MANGO FISH.

resulting products being sulphate of soda and sulphate of protoxide of manganese, as shewn in the equation—

$\text{NaCl} + \text{MnO}_2 + 2\text{SO}_2 = \text{Na}_2\text{SO}_4 + \text{MnO}_2\text{SO}_4 + \text{Cl}$
When mixed with acids, it is a valuable oxidising agent. It is much used for the preparation of Oxygen (q. v.), either by simply heating it, when it yields 12 per cent. of gas, or by heating it with sulphuric acid, when it yields 18 per cent. Besides its many uses in the laboratory, it is employed in the manufacturing of glass, porcelain, &c.

Manganic acid is not known in a free state. Manganate of potash is formed by fusing together hydrated potash and binoxide of manganese. The black mass which results from this operation is soluble in water, to which it communicates a green colour, due to the presence of the manganate. From this water the salt is obtained *in vacuo* in beautiful green crystals. On allowing the solution to stand exposed to the air, it rapidly becomes blue, violet, purple, and finally red, by the gradual conversion of the manganate into the permanganate of potash; and on account of these changes of colour, the black mass has received the name of *mineral chameleon*.

Permanganic acid is only known in solution or in a state of combination. Its solution is of a splendid red colour, but appears of a dark violet tint when seen by transmitted light. It is obtained by treating a solution of permanganate of baryta with sulphuric acid, when sulphate of baryta falls, and the permanganic acid remains dissolved in the water. Permanganate of potash, which crystallises in reddish purple prisms, is the most important of its salts. It is largely employed in analytical chemistry, and is the basis of Condy's Disinfectant Fluid.

Manganese is a constituent of many mineral waters, and is found in small quantity in the ash of most vegetable and animal substances. It is almost always associated with iron.

Various preparations of manganese have been employed in medicine. The sulphate of the protoxide in doses of one or two drachms produces purgative effects, and is supposed to increase the excretion of bile; and in small doses, both this salt and the carbonate have been given with the intention of improving the condition of the blood in cases of anæmia. Manganic acid and permanganate of potash are of great use when applied in lotions (as in Condy's Fluid diluted) to foul and fetid ulcers. In connection with the medicinal applications of manganese, it may be mentioned that manganic acid is the agent employed in Dr Angus Smith's celebrated test for the impurity of the air.

MANGE, in horses, dogs, and cattle, and scab in sheep, are diseases very similar to itch in the human subject, resulting from the attacks of minute mites or *acari*, which burrow in the skin, especially if it be dirty or scurfy, cause much irritation, heat, and itching, and the eruption of minute pimples, with dryness, scurfiness, baldness, and bleaching of the skin. The treatment consists in destroying the *acari*, and insuring the cleanliness and health of the skin, both of which objects are effected by washing the parts thoroughly every second day with soft soap and water, and dressing daily with sulphur or mild mercurial ointments, or with a solution containing four grains either of corrosive sublimate or arsenic to the ounce of water. Castor-oil seeds, bruised and steeped for twelve hours in butter-milk, are very successfully used by the native Indian farmers. Where the heat and itching are great, as is often the case in dogs, a few drops of tincture of belladonna may be used to the usual dressing, or applied along with a little

glycerine. Where the general health is indifferent, as in chronic cases, the patient should be liberally fed, kept clean and comfortable, have an occasional alterative dose of any simple saline medicine, such as nitre or common salt, and a course of such tonics as iron or arsenic. Cleanliness and occasional washing and brushing maintain the skin in a healthy state, and thus prevent its becoming a suitable nidus for the *acari*.

MA'NGO (*Mangifera*), a genus of trees of the natural order *Anacardiaceæ*, having flowers with four or five petals, five stamens, of which the greater part are generally sterile, one ovary seated on a fleshy disk, the fruit a fleshy drupe.—The COMMON M. (*M. Indica*) is a native of India. It is a spreading tree of rapid growth; 30–40 feet in height, the stem only rising 8–10 feet before it divides into branches; the foliage so dense as to be impenetrable to the



Common Mango (*Mangifera Indica*).

burning rays of the sun, affording a most grateful shade; the leaves lanceolate, entire, alternate, stalked, smooth, shining, leathery, and about seven or eight inches long, with a sweet resinous smell. The flowers are small, reddish white or yellowish, in large erect terminal panicles; the fruit is kidney-shaped, smooth, varying considerably in size and colour, and containing a large flattened stone, which is covered on the outside with fibrous filaments, longest and most abundant in the inferior varieties, some of which consist chiefly of fibre and juice, whilst the finer ones have a comparatively solid pulp. The fruit of some of the varieties in cultivation is as large as a man's fist. The M. is much prized for the dessert; it is luscious and sweet, with slight acidity. It was introduced into Jamaica in 1782, and is now very generally cultivated in tropical and subtropical countries. The unripe fruit is made into tarts and pickles. M. kernels are nutritious, and have been cooked for food in times of scarcity. The tree is raised from seeds; the finer varieties are propagated by layering and inarching, and trees obtained in this way often bear much fruit without attaining a large size.—There are several other species of M., natives of different parts of the east, but the fruits of all of them are very inferior.

MANGO FISH (*Polynemus paradiseus*), a fish which inhabits the Bay of Bengal, and ascends the Ganges and other rivers to a considerable distance. It is accounted one of the most delicious fishes of India, but is particularly esteemed when salted and prepared in a peculiar manner, when it bears the name of *Burrah*. The name M. is given to this fish from its beautiful yellow colour, resembling that of a

ripe mango. Another Indian name is *Tupsee*. It is of a perch-like form, and belongs to a genus formerly referred to the Perch family (*Percidae*), but now the type of a distinct family (*Polynemidae*), having the ventral fins behind the pectorals, although partially attached to the bones of the shoulder, and the lower rays of the pectorals extended into threads, which in the mango fishes are twice the length of the body. The *M.* is seldom more than eight or nine inches in length. The genus *Polynemus* contains a number of species of tropical fishes, the air-bladders of some of which are of importance as isinglass; those of *P. Indicus*, a fish sometimes 20 lbs. weight, and other species, forming a considerable article of export from Singapore, under the name of *Fish-mouse*.

MA'NGOLD-WURZEL (Ger. beet-root), or **MANGOLD** (Ger. beet), a name in general use in Britain and America, to designate the varieties of the Common Beet (q. v.) cultivated in fields for the feeding of cattle. By mistake, the name was at first written *Mangel-Wurzel*, and this erroneous form is still sometimes used. The field-beets differ from the garden-beets chiefly in being larger in all their parts, and coarser. They have large roots, which in some of the varieties are red, in some greenish or whitish, in some carrot-shaped, and in some nearly globular. The cultivation of *M.* as a field-crop was introduced into England in 1786, but it is only of late that it has much extended. At first, so little was its value known, that the leaves alone were used as food for cattle. Its importance, however, was soon appreciated, and it rapidly gained favour. It is much more patient of a high temperature than the turnip, liable to fewer diseases, and vastly more productive under liberal treatment. In the island of Jersey, and in highly manured grounds in the vicinity of London, as much as from 70 to 80 tons to the acre have been raised. Throughout the south of England, it is generally admitted that it is as easy to grow 30 tons of *M.* to the acre as 20 tons of Swedish turnips. The lower temperature of Scotland, however, does not admit of the crop being raised to the same advantage. The yield is much smaller than in the south, and the plants are more liable to run to flower. This seems to be owing to the cold contracting the vessels, and in some measure acting in the same manner as a diminished supply of food in favouring the formation of seed. The increased precariousness of the turnip-crop of late years, however, has induced many to make trial of the cultivation of *M.*, and with considerable success. The mode of culture does not vary materially from that followed in Scotland in raising turnips. The land in which the crop is to be planted receives a deep furrow in autumn; and if it is quite free from perennial weeds, it is often previously well manured. Drills or ridges, from 20 to 30 inches wide, are formed in spring by the double-moulded plough; and if manure has not been applied in autumn, from 20 to 30 loads are spread along the furrows. In addition, from 3 to 4 cwts. of guano, and 4 cwts. of ammonia salt, are sown broadcast over the drills; indeed, this crop can rarely be over-manured. The manures are then covered by the plough, and the ridges are afterwards run over with a light roller, to smooth them down. Two or three seeds are then dibbled in on the tops of the ridges, from 1 foot to 1½ foot apart. It requires about 7 lbs. of seed to the acre; and as the grains are enclosed in a hard and rough coat, they may be moistened in water for two days previous to their being planted, for the purpose of promoting a quick and regular braird. The long red, the round red, and the round green-topped yellow, are all favourite varieties in England. As soon as the plants are

about three inches above ground, they are singled out by the hand, and their cultivation is afterwards the same in all respects as in the case of Swedish turnips. The crop is usually ready to be taken up by the end of October; indeed, it should not be delayed beyond this period, for, being a native of the warm coasts of the Mediterranean, it is injured by severe frost. The leaves are wrenched off by the hand, and the earth is merely roughly taken away from the roots, as they do not keep well through the winter if cut or bruised. The roots are stored in pits or clamps, covered with straw and a little earth, as a protection in severe weather. It is some time after storing before the roots can be used with advantage; for in autumn and the early part of winter, its juices being unripened, have a laxative effect on animals. Swedish turnips are at this season preferred for feeding; but the harshness of the *M.* wears off by spring, and it then becomes an excellent food for stock of all kinds, and if well kept, retains its juiciness till the middle of summer.

MA'NGON, or **MA'NGONEL**. See **BALISTA**.

MA'NGOSTEEN (*Garcinia mangostana*), one of the most delicious of all fruits, produced by a tree of the natural order *Guttifera* or *Clusiacea*, a native of the Molucca Islands. The tree is in general only about 20 feet high, but of beautiful appearance, having an erect tapering stem and a regular form, somewhat like that of a fir; the leaves 7 or 8 inches long, oval, entire, leathery, and shining; the flowers are large, with corolla of four deep red petals. The fruit, in size and shape, resembles an orange; it is dark brown, spotted with yellow or gray, has a thick rind, and is divided internally by thin partitions into cells. The pulp is soft and juicy, of a rose colour, refrigerant and slightly laxative, with a mixture of sweetness and acidity, and having an extremely delicate flavour. It may be eaten very freely with perfect safety, and is esteemed very beneficial in fevers. The *M.* is cultivated in Java and in the south-east of Asia; it has recently become common in Ceylon, and has been successfully introduced into some other tropical countries.

MA'NGROVE (*Rhizophora*), a genus of plants of the natural order *Rhizophoraceae*. This order consists of trees and shrubs, all tropical and natives of coasts, particularly about the mouths of rivers, where they grow in the mud, and form a close thicket down to and within the marge of the sea, even to low-water mark. Most of the species send down roots from their branches, and thus rapidly extend over large spaces, forming secure retreats for multitudes of aquatic birds, whilst crabs are also to be found in them in vast numbers, and shell-fish are attached to the branches. The order is distinguished by simple, opposite leaves, with convolute deciduous stipules between the leaf-stalks; the ovary 2—4-celled, each cell containing two or more ovules; the fruit not opening when ripe, crowned with the calyx, 1-celled, 1-seeded. The seeds have the peculiarity of germinating whilst still attached to the parent branch, a long thick radicle proceeding from the seed, piercing its covering, and extending rapidly downwards, till the fruit falls off, when it is soon imbedded in the mud, into which its form, club-like, the heavy end downwards, secures that it shall penetrate in a right position. The whole number of species known is only about twenty; the wood of some is hard and durable. The fruit of the common *M.* (*Rhizophora mangle*) is sweet, eatable; and its juice, when fermented, yields a light wine. The bark of the common *M.* is sometimes imported into Britain for the use of tanners, but it is only of second-rate quality.

MANI, MANES, MANICHÆUS (entitled *Zendik*, Sadducee), the founder of the heretical sect of the Manichæans (q. v.), who lived in the 3d c. A. D. Little is known with regard to his early history, and the accounts transmitted through two distinct sources—the Western or Greek, and the Eastern—are legendary and contradictory on almost every important point. According to certain—very dubious—acts of a disputation held between Manes and Archelaus, Bishop of Cascar (?), he was first called Curbicus, and was bought as a slave, at the age of seven years, by the wife of one Ctesiphon, in Babylonia, who gave him a good education, and at her death made him sole heir. Among the books she left him, he is said to have found the writings of Seythianus, which had been given to her by one of the latter's disciples named Terabinthus, or *Budda*. M. emigrated into Persia, where he remained up to his sixtieth year, and changed his former name, so as to obliterate all traces of his origin and former state. Here he also became acquainted with the New Testament and other Christian works; and gradually conceived the idea of amalgamating the Magian with the Christian religion, and of adding what he knew of Buddhism to the new faith. For the better carrying out of this plan, he announced that he was the Paraclete promised by Christ. King Sapor I. of Persia, in whose days he first proclaimed his mission, at first looked not unfavourably upon his proceedings; but when he had failed to heal the prince, his son, he was cast into prison, whence he managed to escape, but, pursued and captured, he was publicly executed. According to other accounts, however, M. was the scion of a noble Magian family, and a man of extraordinary mental powers, and artistic and scientific abilities—an eminent painter, mathematician, &c.—embraced Christianity in early manhood, and became presbyter at a church in Ehvaz or Ahvaj, in the Persian province of Hazitis, gave himself out to be the Paraclete, and styled himself in ecclesiastical documents 'Mani, called to be an apostle of Jesus Christ through the election of God the Father.' Persecuted by King Sapor I., he sought refuge in foreign countries, went to India, China, and Turkistan, and there lived in a cave for twelve months, during which he is said to have been in heaven. He reappeared with a wonderful book of drawings and pictures, called *Erdshenk* or *Ertlenki-Mani*. After the death of Sapor (272 A. D.), he returned to Persia, where Hormuz, the new king, who was well inclined towards him, received him with great honours, and in order to protect him more effectually against the persecutions of the Magi, gave him the stronghold of Deshereh, in Susiana, as a residence. After the death of this king, however, Behram, his successor, entrapped M. into a public disputation with the Magi, for which purpose he had to leave his castle; and he was seized upon, flayed alive, and hung before Djondishapur, 277 A. D. For his doctrine, &c., see **MANICHÆANS**.

MANIA is the form of mental derangement most familiar to ordinary observers. The excitement and violence by which it is sometimes characterised have become, erroneously and unfortunately, the type and standard by which the disease and those subject to it have been recognised and treated. These qualities occasionally involved danger to those around, and were always calculated to inspire fear; so that for centuries they were counteracted by repression, coercion, and harshness. It is worthy of remark that contemporaneously with the establishment of confidence, and with the introduction of a humane system of treatment, the fury and formidable pugnacity of the insane to a great degree disappeared. This effect must, however, in part be

referred to that change of type in the nature of the malady itself which is supposed to depend upon a modification in the human constitution, as well as upon external circumstances, and which has been observable in all affections of an inflammatory character since the beginning of the present century. The discontinuance of restraint, and the cessation of the necessity for such a measure in asylums, whether regarded as protective or remedial, may be accepted as a proof of the reality and extent of this change, upon whatever it may depend. It is, moreover, probable that, by the accuracy of modern diagnosis, cases of wild frenzy, depending upon fever or inflammation of the brain, have been distinguished from those of true mania, and its true features thus better determined. These are loss of appetite, general uneasiness and irritation, watchfulness, headache, restlessness, intense stimulation of the passions and propensities, rapid ideation, incoherence and loquacity, violence or unbridled agitation and extravagance; and, as the disease advances, emaciation, hollowness of the cheeks and eyes, discoloration of the skin, brilliancy and fixity of eyes. However similar these symptoms may be to what are seen in the fevered and the phrenetic, great caution must be exercised in concluding that the circulation is involved directly, or at all, for of 222 cases examined by Jacobi, 23 only presented any indications of fever, and in these this condition was attributable to hectic and other causes unconnected with mania. Esquirol rarely mentions the pulse as affording any guidance in this kind of alienation. The true interpretation of these symptoms appears to be, that they are connected with debility and exhaustion; that although, remotely, they may originate in any organ or condition, they proximately depend upon impaired nutrition and irritation of the nervous system, calling for support, stimulation, calm, and repose, alike moral and physical. The classification of the various aspects under which mania occurs has been so far regulated by the bodily affection with which it is complicated or associated. Epileptic mania, the most furious and formidable, and puerperal mania, perhaps the most intractable species, consist in the superaddition of the indications formerly detailed to certain states of the nervous system, and to that of parturition. Whatever the combination or complication, however, the essential psychical characteristic of mania is, that all mental powers are involved, and are thrown into a state of exaltation and perversion. When the initiatory extravagance and excitement have subsided, when the affection has become chronic, delusions, previously existing, become prominent, and impart a predominating complexion to the condition. It is probable that, wherever delusions or hallucinations are detected, although they may seem solitary deviations from health, there is a broader and deeper substratum of disease, of which they are trivial manifestations; and where mania has ushered in such affections, the original disease may be held to remain while they remain, and to be reacted upon, and, under certain circumstances, roused into activity through their instrumentality. In these views may be found an explanation of those partial mental derangements which appear to coexist with health.—Bucknill and Tuke, *Psychological Medicine—Sketches in Bedlam*.

MANICHÆ'ANS, a religious sect, founded by Mani (q. v.), which, although it utterly disclaimed being denominated Christian, yet was reckoned among the heretical bodies of the church. It was intended to blend the chief dogmas of Parsism, or rather Magism, as reformed by Zoroaster, with a certain number of Buddhistic views, under the outward garb of Biblical, more especially New Testament history, which, explained allegorically and

symbolically, was made to represent an entire new religious system, and one entirely at variance with Christianity and its fundamental teachings. The M. assumed, above all, two chief principles, whence had sprung all visible and invisible creation, and which—totally antagonistic in their natures—were respectively styled the Light, the Good, or God, and the Darkness, the Bad, Matter, or Archon. They each inhabited a region akin to their natures, and excluding each other to such a degree that the region of Darkness and its leader never knew of the existence of that of the Light. Twelve sons—corresponding to the twelve signs of the zodiac and the twelve stages of the world—had sprung (emanated) from the Primeval Light; while 'Darkness,' filled with the eternal fire, which burned but shone not, was peopled by 'demons,' who were constantly fighting among themselves. In one of these contests, pressing towards the outer edge, as it were, of their region, they became aware of the neighbouring region, and forthwith united, attacked it, and succeeded in carrying the Ray of Light that was sent against them at the head of the hosts of Light, and which was the embodiment of the Ideal or Primeval Man (Christ), captive. A stronger son, however (the Holy Ghost), hurried to the rescue, and redeemed the greater and better part of the captive Light (Jesus Impatibilis). The smaller and fainter portion, however (Jesus Passibilis), remained in the hands of the powers of Darkness, and out of this they formed, after the ideal of *The Man of Light*, mortal man. But even the small fraction of light left in him (broken in two souls) would have prevailed against them, had they not found means to further divide and subdivide it by the propagation of this man (Eve—Sin). Not yet satisfied, they still more dimmed it by burying it under dark 'forms of belief and faith, such as Paganism and Judaism.' Once more, however, the Original Light came to save the light buried in man, in the person of Christ, descending from the sun, with which he is one. The demons succeeded, however, in cutting his career of salvation short by seducing man to crucify him. His sufferings and death were, naturally, only fictitious, since he could not in reality die; he only allowed himself to become an example of endurance and passive pain for his own, the souls of light. Since, however, even his immediate adherents, the apostles, were not strong enough to suffer as he had bid them, he promised them a Paraclete, who should complete his own work. This Paraclete was Mani, who surrounded himself, like Christ, with twelve apostles, and sent them into the world to teach and to preach his doctrine of salvation. The end of the 'world' will be fire, in which the region of Darkness will be consumed and utterly annihilated. To attain to the region of eternal light, it is necessary that Passion, or rather the Body, should be utterly subdued; hence rigorous abstinence from all sensual pleasures, asceticism, in fact, to the utmost degree, is to be exercised. The believers are divided into two classes—the Elect and the Auditors. The Elect have to adhere to the *Signaculum Oris, Manus, and Sinus*, that is, they have to take the oath of abstinence from evil and profane speech (including 'religious terms such as Christians use respecting the Godhead and religion'), further, from flesh, eggs, milk, fish, wine, and all intoxicating drinks (cf. *Manu, Insti.* vv. 51, 52, 53: 'He who makes the flesh of an animal his food . . . not a mortal exists more sinful . . . he who . . . desires to enlarge his own flesh with the flesh of another creature,' &c.); further, from the possession of riches, or, indeed, any property whatsoever; from hurting any being—animal or vegetable; from heeding

their own family, or shewing any pity to him who is not of the Manichæan creed; and finally, from breaking their chastity by marriage or otherwise. The Auditors were comparatively free to partake of the good things of this world, but they had to provide for the subsistence of the Elect, and their highest aim also was the attainment of the state of their superior brethren. In this Manichæan worship, the Visible Representatives of the Light (sun and moon) were revered, but only as representatives of the Ideal, of the Good or supreme God. Neither altar nor sacrifice was to be found in their places of religious assemblies, nor did they erect sumptuous temples. Fasts, prayers, occasional readings in the supposed writings of Mani, chiefly a certain *Fundamental Epistle*, were all their outer worship. The Old Testament they rejected unconditionally: of the New Testament, they retained certain portions, revised and redacted by the Paraclete. (August. c. Faust., book xviii.; cf. book ix.). Sunday, as the day on which the visible universe was to be consumed, the day consecrated to the sun, was kept as a great festival; and the most solemn day in their year was the anniversary of the death of Mani. Baptism and the Lord's Supper were celebrated as mysteries of the Elect. Of this mode of celebration, however, we know next to nothing; even Augustine, who, for about nine years, belonged to the sect, and who is our chief authority on this subject, confesses his ignorance of it. As to the general morality of the M., we are equally left to conjecture; but their doctrine certainly appears to have had a tendency, chiefly in the case of the uneducated, to lead to a sensual fanaticism hurtful to a pure mode of life.

The outward history of the sect is one of almost continuous persecution. Diocletian, as early as 296 A. D., issued rigorous laws against them, which were reiterated by Valentinian, Theodosius I., and successive monarchs. Notwithstanding this, they gained numerous adherents; and very many medieval sects, as the Priscillians, Katharenes, Josephinians, &c., were suspected to be secretly Manichæans. Italy, the south of France, Spain, and even Germany, were the successive seats of this sect, which did not disappear entirely until the time of the Reformation.

MANIFESTO, a public declaration issued by a sovereign prince or by a government on some state emergency, expressive of intentions, opinions, or motives. Immediately before entering on a war, a manifesto is issued containing a statement of the reasons which have been held to justify the sovereign or government in taking up arms. In case of a revolt, a manifesto is sometimes issued to recall subjects to their allegiance.

MANILA, the capital of the Philippine Islands (q. v.), and residence of the Spanish viceroy, or governor of the Philippine Archipelago, is situated in the island of Luzon, on the banks of the river Pasig, and at the embouchure of that river in the Bay of Manila. M. Proper, or the city of M., consisting of 17 spacious streets, crossing at right angles, contained the Cathedral, begun in 1654, completed in 1672, and which was 240 feet in length by 60 feet broad; the *Palacio*, built in 1690; the Archbishop's Palace; the Hall of Audience, 11 churches and 3 convents, besides public offices, barracks, and other military establishments. It also comprised numerous squares, filled with the gorgeous vegetation of the tropics, with foliage and flowers of matchless splendour and beauty. Beyond the ramparts, on the east side, is the Calzada, or public promenade, and is crowded in the evening by carriages and equestrians. Instead of glazed windows, the houses are furnished with sliding

frames, fitted with plates of semi-transparent oyster-shells. The bay and harbour of M. are magnificent, and the river Pasig, at whose mouth the city is situated, is navigable for ten miles. The trade of M. is chiefly with the United States, Great Britain, China, and Australia. Its principal exports are sugar, abac'a (Manila hemp), cigars, leaf-tobacco, coffee, rice, and fine woods. The imports consist chiefly of woven goods from Manchester and Glasgow, with lead, iron-ware, and beer; silks, nankins, vermilion, and curiosities are imported from China. The cheroots of M. are famous; they are generally preferred to those of Havana everywhere east of the Cape of Good Hope. Their manufacture is under the charge of an administration whose head-quarters are at M.; 20,000 persons are employed in this branch of manufacture. The climate of M. is on the whole healthy, and the average temperature throughout the year is nearly 82°. Situated in a rich and fertile district, with a good climate, and in the midst of magnificent scenery, splendid alike in colour and form, M., like every town in the Philippines, has but one great enemy to dread—the earthquake. Convulsions of the earth have frequently made frightful ravages in this city. In 1824, many churches, private houses, &c., were destroyed, and the ships in the harbour were wrecked, but the number of victims was never ascertained. In 1828 and 1867, severe shocks were felt; but on the 3d June 1863, one of the most dreadful earthquakes almost ruined the city. The ground sank two feet; the cathedral and all the churches, with one exception, were overthrown, and numbers were buried beneath their ruins; the palace of the viceroy and the British consulate were destroyed; and a number of lives, of which 2000 seems but a moderate estimate, were lost. Pop., including suburbs, about 150,000.

MANIN, DANIEL, an illustrious Italian patriot and political leader, elected, during the revolution of 1848, President of the Venetian Republic. Born in 1804 at Venice, M. graduated at the university of Padua, was admitted Doctor of Laws at 19, and subsequently practised at the bar, of which his father, Pietro Manin, was an eminent member. From 1831, he became a recognised leader of liberal opinion in Venice; in 1847, his reputation as a political economist was established during the sittings of the scientific congress at Venice; and shortly after, he was thrown into prison for a spirited public address of which he was the author.

Previous to the outbreak of 1848, M. was, for the second time, incarcerated; but on the promulgation of the news that Paris, Naples, and Tuscany were in revolution, he was released in triumph by the populace, and was at once invested with supreme power. The organisation of a civic guard, and the expulsion of the Austrians from the arsenal, were M.'s first public measures; the mob that clamoured for the lives of their former oppressors, shrunk back abashed at his dignified rebuke.

From the period of his election to the presidency of the Venetian republic, M.'s energies were devoted to the organisation of the inhabitants for self-defence.

During the annexation of Lombardy to Piedmont, M. laid down his authority; but on the defeat of the Sardinian army at Novara, 23d March 1849, he resumed it, and was the animating spirit of the entire population of Venice during the heroic defence of the city for four months against the besieging Austrian army. On the 24th of August, Venice capitulated; but M., with forty of the principal citizens, being excluded from all stipulations, quitted the city. He retired to Paris, where he taught his native language, declining innumerable offers of

aid. From thence he proclaimed his desire that the republican system should give place in Italy to the Sardinian monarchy, or any executive form tending to get rid of Austrian rule. He died of heart-disease at Paris in September 1857.

In this really great man appeared a rare union of qualities the most exalted, enthusiasm being guided by great practical sagacity; extreme personal humility coexisting with a lofty sense of authority, and great faculty for command; and the energy and fire of action being equalled by the calm and stoical endurance of defeat and mortal disease.

MA'NIOC, MANDIIOC, or CASSAVA (*Manihot utilisima*, formerly known as *Jatropha manihot*, and as *Janipha manihot*), a large, half-shrubby plant of the natural order *Euphorbiaceae*, a native of tropical America, and much cultivated there. It is now also extensively cultivated in Africa, and has been introduced into other tropical countries. M., or *Mandioca*, is the Brazilian name; *Cassava*, the West Indian; and in Peru and some other parts of South America, the name is *Juca* or *Yuca*. The plant grows in a bushy form, with stems usually 6—8 feet high, but sometimes much more. The stems are white, brittle, and have a very large pith; the branches are crooked. The leaves are near the extremities of the branches, large, deeply 7-parted. The roots are very large, turnip-like, sometimes weighing 30 lbs., from three to eight growing in a cluster, usually from a foot to two feet long. In common with other parts of the plant, they contain an acrid milky juice, so poisonous as to cause death in a few minutes; but as this is owing to the presence of hydrocyanic acid, which is quickly dissipated by heat, the juice, inspissated by boiling, forms the excellent sauce called *CARAREP* (q. v.); and fermented with molasses, it yields an intoxicating beverage called *Ouycou*; whilst the root, grated, dried on hot metal-plates, and roughly powdered, becomes an article of food, very largely used in South America, and there very generally known as *Farinah* (Portug. meal). It is made into thin cakes, like the oatmeal-cakes of Scotland, which are formed, however, not by mixing it with water, but by the action of heat softening and agglutinating the particles of starch. These cakes are sometimes called *Cassava* or *Cassada Bread*. It is also imported into Britain, to be used in manufactories as starch. The true starch of M., separated in the ordinary manner from the fibre, is also imported in considerable quantity into Britain, under the name of *Brazilian Arrow-root*; and from it Tapioca is made, by heating it on hot plates, and stirring with an iron rod; the starch-grains burst, some of the starch is converted into dextrine, and the whole agglomerates into small irregular masses.—Another species or variety of M. is also cultivated, the roots of which contain a perfectly bland juice, and are eaten raw, roasted, or boiled. This, the *SWEET CASSAVA* or *SWEET JUCA* (*M. Aipi* of some botanists, said to be a native of Africa as well as of America), is described as having the leaves 5-parted, and the root of longer shape than the common or bitter cassava, and much smaller, only about six ounces in weight; but other descriptions represent the sweet cassava as having roots quite equal in size to the bitter.—The M. is easily propagated by cuttings of the stem, and is of rapid growth, attaining maturity in six months. The produce is at least six times that of wheat.

MANIS, a genus of mammalia, of the order *Edentata*, containing several species, natives of Africa and the warm parts of Asia, and in their habits and many of their characters closely resembling the Ant-eaters (q. v.) of South America; but

having, among other differences, the body and the tail covered with an armour of large sharp-edged and pointed scales. The species are pretty numerous. One, remarkable for the length of its tail, the *Phatagen* of the ancients (*M. tetradactyla*), inhabits Western Africa. It is about five feet long, of which the tail occupies three feet.—Another, the SHORT-TAILED *M. (M. pentadactyla)*, is common in many parts of the East Indies.

MANISSA (anc. *Magnesia ad Sipylum*), a town of Asia Minor, on the south bank of the Sarabat (*Hermus*), 28 miles north-east of Smyrna. It abounds in handsome public buildings. Silk and cotton manufactures are carried on. Pop. variously stated at 45,000 and 25,000. The ancient Lydian *Magnesia* is famous for the victory of the Romans under Scipio over Antiochus III. of Syria. There was another *Magnesia* in ancient times, not far from this one, and generally called, for the sake of distinction, *Magnesia ad Meandrum*.

MANITOU'LIN ISLANDS—comprising Grand Manitoulin, or Sacred Isle; Little Manitoulin, or Cockburn Isle, belonging to Britain; and Drummond Isle, belonging to the state of Michigan—are situated in Lake Huron, from whose northern shore they are separated by a channel varying from 7 to 18 miles in breadth. Grand Manitoulin is 90 miles long, by 5 to 30 broad; Little Manitoulin is circular in shape, and has a diameter of 7 miles; Drummond Isle is 24 miles long, by from 2 to 12 broad. All are irregular and striking in their natural features, and the Grand and Little Manitoulin are covered with large and dense forests of pine. Pop. 2000, almost all Indians.

MANN, HORACE, LL.D., American statesman and educationist, was born at Franklin, Massachusetts, May 4, 1796, graduated at Brown University, Providence, and commenced the study of law. Elected to the legislature of Massachusetts in 1827, his first speech was in favour of religious liberty, and his second a plea for railways. He was an advocate of temperance, and a founder of the State Lunatic Asylum. Removing to Boston, he was elected, 1836, to the state senate, of which he became president. After editing the revised statutes of the state, he was for eleven years Secretary of the Board of Education. He gave up business and politics, and devoted his whole time to the cause of education, introduced normal schools and paid committees, and, in 1843, made a visit to educational establishments in Europe. His Report was reprinted both in England and America. For eleven years, he worked fifteen hours a day, held teachers' conventions, gave lectures, and conducted a large correspondence. In 1848, he was elected to Congress, as the successor of ex-president John Quincy Adams, whose example he followed in energetic opposition to the extension of slavery. At the end of his term, he accepted the presidency of Antioch College, at Yellow Springs, Ohio, established for the education of both sexes, where he laboured with zeal and success until his death, August 2, 1859. His principal works are his educational reports, and *Slavery, Letters, and Speeches*.

MANNA, a species of sugar which exudes from incisions made in the stems of the Manna Ash (see ASH), a native of the mountainous parts of Southern Europe. Sicily is the chief locality of the manna, and there, in July or August, the collectors make a deep cut through the bark to the wood near the base of the tree with a curved-bladed knife, repeating such incisions daily in different places, always, however, on one side only, and gradually rising until the branches are reached, and then

some of the largest are also cut. The following year, the other side of the tree is operated upon, and this alternation gives the bark time to heal. If the weather is warm and favourable, the manna begins to ooze out of the cuts slowly, and to harden in lumps or flakes, which are from time to time removed by the collectors. Manna is a light porous substance, of a yellowish colour, not unlike hardened honey, but harder and drier. There are various qualities known in commerce, according to the time of collection, the goodness of the season, and other causes. It is chiefly used in medicine, having a gentle purgative effect, which renders it valuable for administration to very young children. It consists principally of a crystallisable sugar called *Mannite*, and an uncrystallisable sugar, which possesses the sweet and purgative properties. There are several other manna-yielding plants besides the ash, especially the manna-bearing Eucalyptus of Australia (*Eucalyptus mannifera*), which is non-purgative, and is a favourite sweetmeat with the children of that country. Small quantities are found on the common larch (*Larix Europæus*), in some districts; this kind is known under the name of manna of Briançon. Manna is also obtained in minute quantities from various mushrooms, and from the fronds of some sea-weeds.

The manna of the Israelites, which they ate during their wanderings in the wilderness, appears probably, as shewn by Ehrenberg in his *Symbols Physica* (Fasc. i. 1823), to have been the saccharine substance called *Mount Sinai Manna*, which is produced in that region by a shrub, *Tamarix mannifera*, a species of TAMARISK (q. v.), from the branches of which it falls to the ground. It does not, however, contain any mannite, but consists wholly of mucilaginous sugar. The exudation which concretes into this manna is caused by the punctures made in the bark by insects of the genus *Coccus* (*C. manniparus*), which sometimes cover the branches. It is a kind of reddish sirup, and is eaten by the Arabs and by the monks of Mount Sinai like honey with their bread. It has been very generally supposed that the manna of the Jews was produced by a species of Camel's Thorn (q. v.).

MANNA CROUP, or MANNA GROATS, a kind of semolina, prepared in Russia, usually from the hard wheats of Odessa and Taganrog. In the process of grinding for flour, small rounded fragments of these hard grains are obtained from the grooves of the grinding-stones, and these constitute the ordinary manna groats, which forms one of the most esteemed materials for puddings. It is undistinguishable from the semolina of Italy. Another kind is made by husking the small grain of the aquatic grass, *Glyceria fluitans*, which is carefully collected for the purpose; it is expensive, and is only used as a luxury. Small quantities of the commoner kind are occasionally imported for use in this country, but it is by no means sufficiently well known.

MANNA GRASS (*Glyceria fluitans*, or *Poa fluitans*), a grass plentiful in marshes, ditches, and by the sides of stagnant pools in Britain, and most parts of Europe; found also in Asia, North America, and New Holland. It is also known as *Flote Fescue*, *Floating Sweet Meadow Grass*, &c. It varies in height from one foot to three feet, and has a long, slender, nearly erect panicle, the branches of which are at first erect and appressed to the rachis; the spikelets awnless, slender, cylindrical, an inch long or nearly so, with 7—20 florets; the glumes small, unequal, and obtuse; the outer paleæ with seven prominent ribs and a membranous margin; a scale of one thick fleshy piece. The stems are decumbent

at the base, and rooting at the joints; the leaves long and rather broad, the lower ones often floating. *M. G.* is perennial, and useful in irrigated meadows and in very wet grounds, affording large quantities of food for cattle. In many parts of Germany and Poland, the seeds—which fall very readily out of the spikelets—are collected by spreading a cloth under the panicles and shaking them with a stick; they are used in soups and gruels, are very palatable and nutritious, and are known in shops as *Polish Manna*, *Manna Seeds*, and *Manna Croup* (q. v.). They are a favourite food of geese, and are also eagerly devoured by carp and other kinds of fish.—Akin to this grass is the Reed Meadow Grass, Water Meadow Grass or Reedy Sweet Water Grass (*Glyceria* or *Poa aquatica*), a still larger grass, with very abundant herbage, the most productive, indeed, of all British fodder grasses, growing in ponds, ditches, marshes, and the sides of rivers, often where they are tidal. Hay made of it is greatly preferred to that of other bog grasses. Its rapid growth often chokes up water-channels, so that they must be cleared of it.

MANNERS, THE FAMILY OF. This noble family are of Northumbrian extraction, their ancestor, Sir Robert de Manners, having been lord of the manor of Ethale, or Etal, in that county in the 13th century. His descendant, also Sir Robert de Manners, temp. Edward III., was governor of the important border fortress of Norham Castle, which he defended with ability against the Scots, and was subsequently commissioned to treat, on part of the king, with David Bruce, concerning the ratification of peace. In the reign of Henry VI., we find another Sir Robert de Manners acting as sheriff of Northumberland, and representing that county in parliament; a post at that time, as Sir B. Burke remarks, of great power and profit. His wife, a daughter of the noble House of Roos, or De Roos, brought to him that ancient barony, and with it the castle of Belvoir, Leicestershire; the grandson of this marriage was raised to the earldom of Rutland by Henry VIII.; and the tenth earl was raised to the dukedom in 1603. The eldest son of the third duke was the celebrated Marquis of Granby (q. v.), who attained a very high reputation as a field-officer whilst acting as commander-in-chief of the British forces serving under Prince Ferdinand in Germany, but who did not live to inherit the dukedom. The marquis's youngest brother having married the heiress of Sutton, Lord Lexington, assumed the additional name of Sutton, and became the father, *inter alios*, of two sons, one of whom was for many years Archbishop of Canterbury, and the other held the high post of Lord Chancellor of Ireland early in the present century, whilst the archbishop's son presided as Speaker over the councils of the House of Commons. The present heir-presumptive to the dukedom of Rutland is Lord John James Robert Manners, son of the late and brother of the present duke.

MA'NNHEIM, formerly the capital of the Rhenish palatinate, now the most important trading town in Baden, and, after Cologne and Coblenz, the most important on the Rhine, is situated in a fertile plain, on the right bank of the Rhine, at the junction of the Neckar, about 18 miles below the city of Spire. The site of the town is low, and a high dyke protects it from inundations. A bridge of boats crosses the Rhine, which is here 1200 feet in breadth, and a chain-bridge the Neckar. The town is remarkable for its cleanliness and regularity, the whole of it being laid out in quadrangular blocks. Its fortifications were destroyed after the peace of Lunville, and gardens

now occupy their place. The palace, built 1720—1729 by the Elector Palatine Karl Philipp, is one of the largest buildings of the kind in Germany. The city contains a lyceum with a library, a botanic garden, an observatory, &c. Tobacco, shawls, linen, and playing-cards are manufactured, and there are several tanneries and bleach-works. A thriving trade is carried on chiefly by boats on the Neckar and Rhine. In 1858, 6441 vessels, of 255,646 tons, entered and cleared the port. *M.* is connected by railway with the chief towns of Germany. Pop. 26,900.

M. was a mere village till the beginning of the 17th c., when a castle was built by the Elector Palatine Frederick IV., around which a town grew up, chiefly peopled by exiles for religion from the Netherlands. It was several times taken and retaken during the wars of the 17th c., totally destroyed by the French in the end of that century, rebuilt, and strongly fortified.

MANNING THE NAVY. Until a recent date, sailors only engaged themselves for the term a certain vessel should be in commission, which, there was a tacit understanding, would be about five years. When the captain hoisted his pendant, the men came down and volunteered, or the crimps in some manner made it their interest to produce them. When the captain was a popular officer, or noted for his daring, his crew was soon completed; while, when his reputation was that of a martinet, or of a commander under whom prize-money would probably be scarce, a ship would often lie for weeks, or even months in harbour, while the authorities sought in vain to provide her complement of men. In the Napoleonic and former wars, when seamen were urgently needed, and knew their value, the press-gang was resorted to, and vacancies filled by compulsion. See IMPRESSMENT.

At present, seamen are encouraged by contingent advantages to enlist for a specified number of years, at the end of which they become entitled to permanent pension. On the paying off of their ship, these men are granted liberal leave, after which they join a dépôt, and are thence drafted to some other vessel in which their services are required. As a reserve for times of emergency, there are the Royal Naval Coast Volunteers (see COAST VOLUNTEERS), and the Royal Naval Reserve (q. v.), both very important auxiliaries, of which the value became instantly apparent when hostilities with the United States were anticipated in 1861.

The Dutch, Danish, and Swedish navies are mainly manned by volunteers, as is that of the United States, into which, indeed, the very high pay frequently draws deserters from the ships of other nations. The navies of France, Russia, and Italy are manned by conscripts levied in the maritime provinces of the respective countries.

MANNING THE YARDS, in a practical sense, consists in sending sufficient men aloft and on to the yards to furl or unfurl the sails: in a complimentary sense, the yards are said to be manned when a row of sailors, with their hands touching, are ranged along them, standing on the yard itself, and holding to a rope which runs across about breast-high between the lifts. When the men are all in clean white uniforms, the act of manning the yards has a singularly lively and picturesque effect. It is resorted to when any great personage passes by the ship or comes on board, or in commemoration of some great event; but as the operation is attended with considerable and unnecessary danger, it is, under present regulations, performed far more rarely than used to be the case.

MA'NNITE. See MANNA.

MANNITE, or **MUSHROOM SUGAR** ($C_{12}H_{22}O_{11}$), is a peculiar saccharine matter which forms the principal constituent of *Manna* (q. v.); it is also found in several kinds of fungi, in asparagus, celery, onions, &c. It is most readily obtained by digesting manna in hot alcohol. On cooling the filtered solution, the mannite is deposited in crystals, which are very soluble in water, and possess a sweet taste. It is not susceptible of alcoholic fermentation, and may be readily distinguished from cane and grape sugar by simple tests. Heated with hydrate of potash, it gives a mixture of acetate, formate, and valerianate of potash, hydrogen being evolved.

MANNUS, according to Tacitus, the name given by the Germans to the son of the earth-born god *Tuisco*. From his three sons, they derived their three great tribes, the *Ingavones*, the *Iskavones*, and the *Herminones*. *M.* belongs, not to the Teutonic people alone, but to the great mythus of the origin of the human race, common to the whole Aryan family, and, like the Hindu *Manu* or *Manus*, stands forth as the progenitor of the inhabitants of earth endowed with reason. The name is derived from the Aryan root *man*, to think.—Compare *Wackernagel in Haupt's Zeitschrift für Deutsches Alterthum* (Bd. 6).

MANOËL, DON FRANCESCO, the most eminent of modern Portuguese lyric poets, was born at Lisbon in 1734, and devoting himself to the pursuits of literature, acquired a high reputation. The hostility of the Inquisition compelled him, however, to abandon his native country. He took up his residence at Paris, where he died, 25th February 1819. There are more editions than one of his *Obras completas*. His Odes are highly esteemed.

MANŒUVRE, a French word, signifying 'handy-work,' is somewhat vaguely used in English military and naval language to denote collateral movements, not openly apparent, of bodies of men or squadrons of ships, by which an enemy is coerced, or by which it is sought to compel him to take some course adverse to his interests.

MAN-OF-WAR, an expression, of unknown origin, for an armed vessel carrying cannon, and belonging to some constituted and acknowledged government. As such, she possesses the privileges of war: her deck is, by a legal fiction, taken to be a portion of the soil of the nation whose flag she hoists; in time of war, she is justified in attacking, sinking, burning, or destroying the ships and goods of the foe, and by the law of nations, she may stop and search the merchant-vessels of neutral powers which she suspects of carrying aid to her enemy. See **CONTRABAND**. In case of being overpowered, the crew of a man-of-war are entitled to the ordinary mercy granted to vanquished combatants, lawfully fighting. Any vessel making war, but not belonging to an acknowledged government, is either a **Privateer** (see **LETTER OF MARQUE**) or a **Pirate** (q. v.).

MAN-OF-WAR BIRD. See **FRIGATE BIRD**.

MANOMETER (Gr. *manos*, thin, rare) is properly an instrument for measuring the rarity of the air or of other gases; but the name is most frequently applied to instruments for indicating the elastic force of gases, which is always inversely proportional to their rarity. The several kinds of **Barometers** (q. v.) are really manometers, and so is the steam-gauge of a Steam-engine (q. v.).

MANOR, in English Law, is a freehold estate held by the lord of the manor, who is entitled by immemorial custom to maintain a tenure between himself and the copyhold tenants, whereby a kind

of feudal relation is kept up between them. As, however, subinfeudation in England was prohibited by the statute of *Quia Emptores*, in the reign of Edward I., and no manor could be created since that date, it follows that all existing manors must trace their origin from before that time. Copyhold estates are thus a relic of ancient feudalism, and form an exception to the general rule in England, where freeholds form the highest kind of estate known to the law. See **COPYHOLD**. Manors closely resemble the feudal estate held in Scotland by all proprietors of land, who have to this day unlimited powers of subinfeudation, which they constantly act upon, and thus keep up a chain of vassals. See **FEU**.

MANRENT (more properly, **MANRED**), **BONDS OF**, agreements which used to be entered into in the Highlands of Scotland between the greater and lesser magnates, where protection on the one hand was stipulated in return for allegiance on the other. Such bonds were common up to two or three centuries ago, the royal authority being comparatively powerless to repress internal warfare among the fastnesses of the north and west.

MANS, LE, a city of France, formerly capital of the province of Maine, now of the department of Sarthe, on the right bank of the river of that name, 132 miles south-west of Paris by railway. The chief edifice is the cathedral, in combined Gothic and Romanesque, its most recent portions dating from the 13th c., and containing the tomb of Berengaria of Sicily, the queen of Richard Cœur de Lion. There is a public library of 46,000 volumes, and several artistic and scientific institutions. The town manufactures wax-candles, woollens, lace, soap, and hosiery, and is famous for its poultry, of which it sends a large supply to the metropolis. Pop. 34,664. *Le M.* (anc. *Cenomani*) was, in the age of Charlemagne, one of the chief cities of the Frankish empire.

MANSARD ROOF, a form of roof invented by Francis Mansart, a distinguished French architect of the 17th century. It is constructed with a break in the slope of the roof, so that each side has two planes, the lower being steeper than the upper. The framework ought to be arranged so that its parts are in equilibrium. This kind of roof has the advantage over the common form of giving more space in the roof for living room.

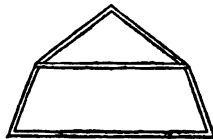

Mansard Roof.

MANSE, in Scotch Law, is the designation of a dwelling-house of the minister of the Established Church, and in popular use the term is often applied generally to the dwelling-house of any minister of a dissenting congregation, though no legal right exists in the latter case. In the Established Church, every minister of a rural parish is entitled to a manse, which the heritors or landed proprietors are bound to build and uphold; and he is also entitled, as part of the manse, to a stable, cowhouse, and garden. The manse must, by statute, be near to the church. The usual sum allowed of late years to build a manse is £1000. It has often been made a question, how far the heritors can be compelled to rebuild a manse which, by time or other circumstances, has become inadequate. It is now held to be the law, that at least the presbytery has power to order sufficient alterations and additions, and they can order a visitation, and take estimates from skilful tradesmen, and decree what is necessary to be done. It is only the ministers of rural parishes that are

entitled to a manse, and not ministers of a royal burgh where there is no landward district.

MANSFIELD, a market-town of England, in the county of Nottingham, and 14 miles north of the town of that name, is surrounded by the remains of the ancient forest of Sherwood. It stands in the centre of a large manufacturing and mining district, and contains, among other institutions, a Royal Free Grammar School, with an annual income from endowment of £250. Silk, cotton, and doubling mills are in operation, and the corn and cattle markets are extremely well attended. Pop. (1861) 8346.

MANSFIELD, WILLIAM MURRAY, EARL OF, Lord-chief-justice of the King's Bench, was the fourth son of Andrew, Viscount Stormont, and was born at Perth, 2d March 1704. He studied at Christ-Church, Oxford, took the degree of M.A. in 1730, and was called to the bar in 1731. He soon acquired an extensive practice—mainly, it would seem, on account of his facility and force as a speaker, for neither then nor at any subsequent period of his career was he reckoned a very erudite lawyer—and was often employed on appeal cases before the House of Lords. In 1743, he was appointed by the ministry Solicitor-general, entered the House of Commons as member for Borough-bridge, and at once took a high position. In 1746, he acted, *ex officio*, as counsel against the rebel lords, Lovat, Balmerino, and Kilmarnock; was appointed King's Attorney in 1754; and at this time stood so high, that had not the keenness of his ambition been mitigated by a well-founded distrust of his fitness for leading the House, he might have aspired to the highest political honours. He became Chief-justice of the King's Bench in 1756, and entered the House of Lords under the title of Baron Mansfield of Mansfield, in the county of Nottingham. Still, his political rôle has little interest for posterity. As his opinions were not those of the popular side, he was exposed to much abuse and party hatred. Junius, among others, bitterly attacked him; and during the Gordon riots of 1780, his house, with all his valuable books and manuscripts, was burned. He declined, with much dignity, indemnification by parliament. In 1776, Murray was made Earl of Mansfield. He worked hard as a judge till 1788, when age and ill-health forced him to resign. His death took place 20th March 1793, in the 89th year of his age.

MANSLAUGHTER is, in Scotland, the offence of causing the death of a person by some carelessness or neglect. In England, the offence is usually called Culpable Homicide.

MANTCHURIA, a territory in Eastern Asia, under the dominion of the Chinese Empire, extending between lat. 42° and 53° N., and bounded, according to its present limits, by the Amur on the north; by the Usuri and the Sungacha on the east, separating it from the Russian maritime territory of Orochi; by the Shan-Alin range on the south, separating it from Korea; and by a portion of the Khingan Mountains, the river Sira-Muren, and the district of the upper Sungari, which separate it on the west, from the desert of Gobi. Previouly to the recent incursions of the Russians on the north, the area of this territory was about 682,000 square miles; it is now about 378,000 square miles; nearly one-half having passed into the possession of the Russians, who concluded a treaty with the Chinese, 14th November 1860, finally making over to themselves all the territory east of the Usuri and north and east of the Amur. Population variously estimated at from 3,000,000 to 4,000,000. M. is divided into three provinces, Shing-King—formerly Leaotong,

which alone contains upwards of 2,100,000 inhabitants, and the chief town of which, Mukden, is the seat of government for the three provinces—Girin or Kirin, and Tai-tai-har. The country is mountainous, densely wooded in the south, but consisting chiefly of prairies and grass-land in the north. It is well watered and fruitful in the valleys. The rivers are the Amur (the northern boundary), the Usuri (the eastern boundary), and the Sungari, which waters the two provinces of Girin and Tai-tai-har. The Sungari is about 1200 miles in length; its banks, which form the most densely-peopled region of M., are low and fertile, and its general course is north-east to its junction with the Amur. About 200 miles from its source, it passes the flourishing trading city of Girin, in lat. 43° 40' N., with a population variously estimated at from 150,000 to 600,000, and inhabited by Mantchus and Chinese, but by the latter in far greater numbers. The city of Mukden, on the Sira-Muren, is large and beautiful, surrounded by walls, and containing 200,000 inhabitants. In 1631, it was the seat of the government of the empire of Mantchu. Millet, barley, tobacco, and oats are largely produced, and herds of cattle are fed on the prairies. Chinese form the great bulk of the population; the Mantchus are for the most part soldiers, and are drafted out of the country into China. For the history of M., see CHINESE EMPIRE.

The Mantchus are the present rulers of China, who gradually subjugated the country; the first emperor of the new dynasty, Shunche, succeeding the last of the Mings in 1644. They are not a nomadic race like the Mongols, but are given to agriculture or hunting, according to the part of their country they inhabit. They are of a lighter complexion and slightly heavier build than the Chinese, have the same conformation of the eyelids, but rather more beard, and their countenances present greater intellectual capacity. Literary pursuits are more esteemed by them than by Mongolians, and they are less under the priesthood. The Mantchus, in short, may be regarded as the most improvable race in Central Asia, if not on the continent.—Williams, *Middle Kingdom*.

MANTELL, GIDEON ALGERNON, an eminent British palaeontologist and geologist, was born at Lewes, in Sussex, in 1790; studied medicine, and for some time practised in his native town. Subsequently, he removed to Brighton, and thence to London, where he died, November 10, 1852. M.'s principal works are—*Fossils of the South Downs* (1822); *The Fossils of Tilgate Forest*; *Wonders of Geology* (1838), perhaps the most popular geological work ever written by an Englishman; and *Medals of Creation, or First Lessons in Geology* (1844). He was a very voluminous writer, no less than 67 works and memoirs of his being mentioned in Agassiz and Strickland's *Bibliotheca Zoologica et Geologica*. His claims to a permanent place in the history of science rest chiefly on his laborious investigations into the fossils of the Wealden beds. To him, we owe the discovery and description of four out of five of the great Dinosaurian reptiles—viz., the *Iguanodon*, the *Hylaeosaurus*, the *Peloro-saurus*, and the *Regnosaurus*.

MANTELPIECE, the lintel over the opening of a fireplace supporting the masonry above. It was in ancient times frequently ornamented with mouldings and carving. The name is now applied to the marble or wooden jambs, lintel, and shelf, so universally used.

MA'NTIDÆ. See MANTIS.

MA'NTIGER, or MANTÈGRE, a monster with the body of a tiger, the head of an old man, and long spiral horns. It is one of the imaginary

MANTINEA—MANTLING.

creatures known in heraldic blazon, and is variously represented, sometimes with the horns of an ox and feet of a dragon. The supporters of the Earl of Huntingdon are mantègres without horns.

MANTINEA, anciently, a city of Arcadia, in the Peloponnesus, on the borders of Argolis. It was situated on the river Ophis, in the midst of a broad plain, and was famous as being the scene of several battles, of which the most important was that fought between the Spartans and the Thebans under Epaminondas (362 B. C.), in which the former were defeated. Its site is now called *Palaeopoli*. Some ruins still remain, the principal of which are those of a theatre whose diameter was 240 feet. See Colonel Leake's *Travels in the Morea* (Lond. 1830).

MANTIS, a Linnean genus of orthopterous insects, which included not only those now constituting the family *Mantida*, but also the *Phasmida* (Leaf-insects, Spectre-insects, Walking-stick insects, &c.). All of them are of very remarkable forms. The Mantids have a narrow, compressed, and elongated abdomen, and a long thorax, which consists almost entirely of the first segment. The head is triangular, with large eyes, three small stemmatic eyes, and rather long bristle-like antennae. The wings fold in a fan-like manner, and the wing-covers are long, narrow, and thin. The second and third pair of legs are long and slender, and are used only for locomotion; the first pair are chiefly used as weapons of combat and instruments of prehension, and have the *coxa* unusually long and large; the *femur* also long and large, compressed, and capable of closing on the *coxa*, so that the sharp edges cut like a pair of scissors. The Mantids feed on other insects, and remain long fixed in one position, moving their fore-legs in the air to catch prey, which has led to a superstitious regard for them as *praying insects*, and to many foolish notions and legends concerning them. One species (*M. religiosa*) is plentiful in the south of France and in Italy, and others are frequent in warmer parts of the world. The Mantids not only lie in wait for prey, but move about in quest of it,



Mantis Religiosa.

moving slowly, and advancing stealthily on the victim. Many of them are large insects. Some of the South American ones are four inches in length. They are all of very pugnacious disposition, the combat generally terminating in the decapitation of one of the combatants, or the dividing of its body in some part by the legs of the other; and the victor enjoys his triumph in eating the vanquished. In China and some other parts of the East, these insects are kept in cages, and set

to fight with each other for the amusement of the beholders. Some of the Mantids (genus *Empusa*) have the forehead produced into a horn.

MANTLE, a long flowing robe, worn in the middle ages over the armour, and fastened by a fibula in front, or at the right shoulder. The mantle is an important part of the official insignia of the various orders of knighthood. Ladies of rank wore similar mantles, in many instances decorated with heraldic charges, in which case the mantle bore either the impaled arms of the lady and her husband, or her husband's arms only. A number of examples may be seen in monumental effigies.

MANTLET, a sort of temporary fortification intended to protect the men working guns in embrasures, casemates, or port-holes from the bullets of sharpshooters. The mantlet is usually made to be hoisted up while the gunner takes aim, and then lowered to cover the whole opening except a circular aperture for the muzzle of the cannon. With every increase in the range and precision of small-arms, mantlets become more essential for the safety of gunners. Mantlets are made of thick fir, of solid oak planks, or of iron plates, the last being preferable, as the lightest. At Sebastopol, the Russians effectively blocked their embrasures by thick mantlets of plaited rope suspended freely. A mantlet of planks or iron plates, about five feet high, and occasionally mounted on small wheels, is also used to protect sappers working at the end of a sap, although a rolling gabion is preferred for this purpose by many engineers.

MANTLING, or **LAMBREQUIN**, a heraldic ornament depicted as hanging down from the



Mantling.

helmet, and behind the escutcheon. It is considered to represent either the cointise, an ornamental scarf which passed round the body, and over the shoulder; or the military mantle, or robe of estate. When intended for the cointise, it is cut into irregular strips and curls of the most capricious forms, whose contortions are supposed to indicate that it has been torn into that ragged condition in the field of battle. When the mantling is treated as a robe of estate, the bearings of the shield are sometimes embroidered on it. A mantling adjusted so as to form a background for the shield and its accessories, constitutes an *Achievement of Arms*. It is not till the latter end of the 14th c. that the mantling appears as a heraldic ornament on seals. In British heraldry, the mantling of the sovereign is of gold lined with ermine; that of peers, of crimson velvet lined with ermine. Knights and gentlemen have generally crimson velvet lined with white satin; but sometimes the livery colours

(see *LIVERY*) are adopted instead, as is generally the practice in continental heraldry.

MANTUA (Ital. *Mantova*), an ancient city of the Italian province of Lombardy, and formerly capital of a duchy of same name, belongs to Austria, and is situated in lat. 45° 9' 34" N., long. 10° 48' 1" E. Its population, of 30,000, comprises about 2500 Jews, whose commercial influence and social privileges are more extensive in this city than in any other of Italy. M. occupies two islands formed by branches of the Mincio, the waters of which surround the city, with the additional defence of swamps or marshy lakes. It is the most strongly fortified town in Italy, but, owing to its situation, is extremely unhealthy—a fact evinced by the pallid faces of the inhabitants. There are five gateways leading into the city, one of which, *La Porta dei Mulini*, deserves examination. The fortifications of M., including its vast citadel, present such a combination of defensive resources, that its regular investment could only be effected by a numerous army; and its reduction even then would be impracticable, except by famine. It forms one of the four fortresses of the Quadrilateral, which, by the treaty of Villafranca, remain in the hands of Austria. The streets of M. are spacious and regular, but indifferently paved; the squares are numerous and fine. Some of the public buildings are splendid, both from the massive grandeur of their proportions, and the novel beauty of their architecture. The inadequate population of M., added to the sombre character of its feudal structures, imparts to the city an air of gloomy decadence, except in the central commercial quarters, and the populous animated *Ghetto* or Jewish quarter, still subject to enclosure. The ancient ducal palace, or *Castello di Corte*, a vast irregular pile of building, was the state residence and fortress of the Gonzagas, by whom it was erected, and now serves as a state prison and for public offices. The adjoining sumptuous edifice, which now comprises the *Palazzo Imperiale*, the *Palazzo Vecchio*, and the *Corte Imperiale*, or Provincial Tribunal, was originally planned and begun by Buonacoli, the feudal lord of M. in 1302; it contains 500 rooms, including a magnificent suite of state apartments, whose choicest embellishment consists in the glorious paintings and exquisite designs of the great Mantuan artist Giulio Romano. The cathedral of San Pietro, also designed by G. Romano, contains some fine frescoes. The churches of San Martino and Sant' Egidio are of great antiquity—the former dating from 528, and the latter from 568.—The province of M. had a high reputation in the time of the Romans. After sharing the fate of the rest of Northern Italy, it was seized by the Gonzagas about the commencement of the 14th century. The last duke of the House of Gonzaga died childless at Padua in 1708, when M. fell into the hands of Austria, who, in 1859, was obliged to give up the province, though she still retains the town of Mantua.

MANU (from the Sanskrit *man*, to think, literally, the thinking being) is the reputed author of the most renowned law-book of the ancient Hindus; and likewise of an ancient Kalpa work on Vedic rites. It is matter, however, of considerable doubt whether both works belong to the same individual, and whether the name M., especially in the case of the author of the law-book, was intended to designate an historical personage; for, in several passages of the Vedas (q. v.), as well as the *Mahābhārata* (q. v.), M. is mentioned as the progenitor of the human race; and in the first chapter of the law-book ascribed to him, he declares himself to have been produced by Virāj, an offspring of the

Supreme Being, and to have created all this universe. Hindu mythology knows, moreover, a succession of Manus, each of whom created, in his own period, the world anew after it had perished at the end of a mundane age. The word M.—kindred with our '*man*'—belongs therefore, properly speaking, to ancient Hindu mythology, and it was connected with the renowned law-book in order to impart to the latter the sanctity on which its authority rests. This work is not merely a law-book in the European sense of the word, it is likewise a system of cosmogony; it propounds metaphysical doctrines, teaches the art of government, and, amongst other things, treats of the state of the soul after death. The chief topics of its twelve books are the following: 1. Creation; 2. Education and the duties of a pupil, or the first order; 3. Marriage and the duties of a householder, or the second order; 4. Means of subsistence, and private morals; 5. Diet, purification, and the duties of women; 6. The duties of an anchorite and an ascetic, or the duties of the third and fourth orders; 7. Government, and the duties of a king and the military caste; 8. Judicature and law, private and criminal; 9. Continuation of the former, and the duties of the commercial and servile castes; 10. Mixed castes, and the duties of the castes in time of distress; 11. Penance and expiation; 12. Transmigration and final beatitude. The text of this work has been published in several editions both in India and Europe. An excellent English translation of it we owe to Sir W. Jones (2d ed., by Haughton, London, 1825), and a very good French translation to A. Loiseleur Dealongchamps (Paris, 1833).

MANUAL, in Military Language, is an exercise with the musket or rifle, through which recruits are drilled, to give them a free use of their limbs, and of the weapon regarded merely as a pike. It comprises the first course of instruction after the rifle has been placed in the learner's hands.

MANUEL I. COMNENUS, Emperor of Constantinople, and fourth son of the Emperor Calo-Joannes, was born about 1120, and succeeded his father in 1143. He became at once involved in an uninterrupted series of wars both with the eastern and western nations, and greatly distinguished himself by his courage and heroism. In 1144, Raymond, Prince of Antioch, who had thrown off the Byzantine yoke, was compelled to submit again to vassalage; and in the following year, the Turks, who had invaded Isauria, were paralysed by repeated and decisive defeats. In 1147, the Crusaders, under Louis VII. of France, and Conrad III. of Germany, marched through M.'s dominions without hindrance on his part, as he was at this time preparing for his notable contest with Roger, king of Sicily, for the possession of Greece. At first, this contest was highly favourable to M.; but after the death of Roger, the fortune of war changed, and peace was concluded in 1155. The rest of his life was spent in wars with the Hungarians and Turks. He died 24th September 1180.

MANURE. This is a term applied to a great variety of substances, mineral as well as organic, which have been used for the purpose of increasing the produce of those plants that man selects for cultivation. Lime, and the ashes of vegetables, have been applied to the land to increase its fertility from time immemorial; so also have all kinds of organic substances, whether vegetable or animal. The rationale of such applications to growing plants was but little understood, till chemistry revealed to us the nature of the materials which entered into the composition of all plants. At the present day, much definite knowledge has been acquired of the true

MANURE.

nature and action of the various substances that are found to increase the growth of our cultivated crops. It was long supposed that the food of such a varied class of plants as the globe presents must necessarily be very different, almost as much so as the difference in their forms and properties of their products. Chemistry, however, has shown that the food of all plants is very much alike, though some classes must be supplied with certain substances in greater abundance than others. The great mass of all vegetables is resolved into carbonic acid, water, and ammonia, on being subjected to heat or burned in a fire. It is these same substances which constitute the chief food of all plants. The light of the sun enables plants to decompose and assimilate carbonic acid and ammonia, and to manufacture out of them the various products they contain. All organic substances yield these by slow decomposition, as well as by combustion. It is for this reason that such substances increase the fertility of land when added to it. Water is so common an article, that nature provides all that plants require. Carbonic acid, too, is contained in considerable proportion in the atmosphere, and is readily taken from it by the leaves; still, it is of great use when applied to the soil as vegetable matter, and the decomposition rendered accessible to the roots of plants. Ammonia exists in exceedingly sparing quantities in the atmosphere, as well as in rain and river water, so that artificial applications to the soil are generally needed to produce full crops. The nitrogen which enters into the composition of plants is generally supposed to be capable of being only assimilated either in the form of ammonia or nitric acid; it is for this reason that the salts of ammonia and nitric acid are all very powerful fertilisers. They generally produce a dark-green colour in the leaves, such as is associated with healthy growth and luxuriance.

But besides carbonic acid, water, and ammonia, plants feed upon certain mineral or earthy substances, which seem to impart the power of condensing and digesting the other organic elements. On plants being burned, they leave lime, potash, soda, magnesia, silica, sulphates, and phosphates, as ash. These substances are all found to exist in certain kinds of plants in proportions which are confined within rather narrow limits. The earthy substances, it must be remembered, enter into combinations in definite proportions with the other constituents, and are thus linked together in the vegetable organisms as part and parcel of their structure.

Lime acts as a manuring substance directly by supplying one of the constituents of plants; so also does magnesia. But lime is often added as an agent to assist in digesting and preparing the organic materials existing in the soil. See **LIME**. Magnesia is seldom applied singly to the soil; it is usually associated with limestone, and is generally contained in the soil in quantities sufficient for the wants of plants.

Potash is a substance most essential for all our cultivated plants; its market-price, however, is so high, that farmers seldom apply it directly to the soil. They employ certain crops, such as clover and turnips, to gather it up for them in the soil. These are consumed on the farm by cattle and sheep, and as little potash enters into animal tissues as a permanent constituent, it is mostly returned to the dung-heap in the excrementitious matters. Farm-yard dung thus possesses a value of its own, by supplying this constituent, which cannot be bought economically in the market. Soda can be easily obtained in the form of common salt, but as this substance is usually associated with potash, the one is found in the dung-heap as well as the other.

Common salt is applied to corn-crops that are growing too rapidly. The salt has the effect of stiffening the straw, and rendering it less liable to lodge. Salt is also used with great success in growing mangold-wurzel, as this is a plant which was originally taken from the sea-shore.

Sulphates.—Every plant contains a quantity of sulphur, which is derived from the sulphates that are found in the soil. Sulphate of magnesia has often been applied with marked effect for turnips and potatoes, but its use does not commonly pay the expense of the application. A much cheaper source of sulphur is found in sulphate of lime or gypsum (q. v.).

Phosphates.—These are largely used in agriculture. Phosphoric acid being very sparingly diffused in most soils, many plants have apparently great difficulty in obtaining as much of this material as is necessary to rapid growth, and hence the importance of an artificial supply, which is administered in the form of phosphate of lime. The chief sources of this important element are Bones (q. v.), Apatite (q. v.), and Guano (q. v.). The reason of its importance, and the principle which should guide its application, are explained in the article **BONES AS MANURE**.

Nitrogenous Manures.—Plants are supplied with nitrogen in the form of nitrates, or of salts of ammonia. Nitrates and the salts of ammonia promote growth in all cultivated plants when the earthy substances that enter into their composition are present. Nitrogenous manures are often beneficially applied without other substances to grain, because the grain-plants have greater facilities than the turnip for taking up phosphates and other constituents from the soil. So also, to a still greater extent, do we see the operation of this principle in the case of grass. Having a permanent staff of roots in the soil, the plants are ready to gather up the necessary supply of mineral food when abundant nitrogenous food is presented to them, and thus nitrogenous manures of all kinds have very marked effects on grass. What determines the amount that can be profitably applied to the different cultivated plants, is simply the capability that each species possesses of expanding under such treatment.

Farm-yard Manure.—This is the most valuable manure that the farmer uses. It contains all the elements of plants, and without its use in ordinary circumstances, the fertility of the land would rapidly deteriorate. The richer the food upon which stock is fed, so much the richer the manure produced. Stock fed upon straw and water leave a very inferior manure, that requires to be largely supplemented by other materials. Turnips add largely to the value of manure, and oilcakes of all kinds, from containing nitrogen and the earthy matters of the seeds of oil-bearing plants, produce a rich manure. Farm-yard manure, under ordinary circumstances, is much more valuable for some kind of crops than for others. The potato, for example, cannot be raised with much success, unless it be supplied with this or other bulky manure having the greater number of ingredients present. This does not appear to arise from its absolutely requiring more of any one substance than many other plants that can do far better without artificial supply. It seems to be owing rather to a deficiency of power to gather its food when dispersed through the soil. A large allowance of farm-yard manure is therefore applied to the potato when it is grown in great quantities. The bean, also, is dependent on farm-yard manure more than the pea. Large breadths of turnips are often raised without farm-yard manure, as, when supplied with phosphate and nitrogen, they seem to have greater facilities for taking up what is diffused

through the soil. The weaker and poorer the soil, the more important does farm-yard manure become for all plants. Farm-yard manure also tends to render soils more adapted for carrying clovers, and many farmers always apply this to lands which are to be sown out in grasses.

Liquid Manure.—This is a favourite manure in many districts. Scotch and English farmers, in general, endeavour to have all the liquid excrements of the stock absorbed by the straw, and carried out in the solid form. On many farms, however, far more is produced than can be absorbed by the straw. Various modes have been adopted to apply it when this is the case. It is commonly done by a large barrel drawn by a horse; the liquid is distributed by various methods as the horse walks over the ground. The liquid manure is commonly applied to grasses, more especially to clovers or rye-grass, common or Italian. As the liquid accumulates, it may be applied to the young grasses as soon as the corn crop is removed. The plants, being vigorous in autumn, absorb it, and form roots and juices that are available as soon as the growing season arrives. It may be applied during intervals of mild weather during the whole winter. It is, no doubt, most economical to apply it at the season of growth, as the roots take it up then very readily, and there is comparatively little waste from being washed out of the soil. In some large establishments, the whole urine is collected during the winter in large tanks, and applied in spring. This has been done on a large scale by means of underground pipes laid over the fields, the liquid being distributed by means of a pump and hose. Steam or water power has been in some cases applied to this operation; in others it is effected by gravitation, when the situation of standing and reservoir suits. In wet weather, the liquid manure can be put on pretty strong, but in dry weather large quantities of water are added for the purpose of diluting it, and not allowing it to injure the plants. Liquid manure is exceedingly rich in all the elements of plants, and is valuable for all crops; but there are often considerable practical difficulties connected with its use and distribution.

MANUSCRIPTS, ILLUMINATION OF, the art of painting manuscripts with miniatures and ornaments, an art of the most remote antiquity. The Egyptian papyri of the ritualistic class, as old as the 18th dynasty, are ornamented with vignettes or miniatures, attached to the chapters, either designed in black outlines, or painted in primary colours in tempera. Except these papyri, no other manuscripts of antiquity were, strictly speaking, illuminated; such Greek and Roman ones of the 1st c. as have reached the present day being written only. Pliny, indeed, mentions from Varro that authors had their portraits painted on their works, and mentions a biographical work, with numerous portraits introduced, but all such have disappeared in the wreck of ages; the oldest illuminated MSS. which have survived being the *Dioscorides* of Vienna, and the *Virgil* of the Vatican, both of the 4th c., and ornamented with vignettes or pictures in a Byzantine style of art. St Jerome, indeed, in the same century, complains of the abuse of the practice, as shewn by filling up books with capital letters of preposterous size; but the manuscripts of this and the subsequent century are ornamented with rubrics only, as evidenced by the *Codex Alexandrinus* and other manuscripts. Probably the art of illumination was derived from rubrics, as the emperors in the 5th c., commencing with Leo (470 A. D.), signed in this colour, like the Chinese, and this 'vermillion reply,' adopted by Charles the Bold in the 9th, continued down to the 13th century. The art of illuminating

manuscripts with gold and silver letters is supposed to have been derived from Egypt, but it is remarkable that no papyrus has any gold or silver introduced into it. The artists who painted in gold, called *Chryseographi*, are mentioned as early as the 2d century. One of the oldest manuscripts of this style is the *Codex Argenteus* of Ulphilas (360 A. D.); and the charter of King Edgar (966 A. D.), six centuries later, shews the use of these letters. Gold letters seem to have been used in the East during the 12th and 13th centuries. At an early period, the use of illuminated or decorated initial letters commenced, which is to be distinguished from the illuminated or painted pages placed at the head of Byzantine manuscripts. Originally, they were not larger than the text, or more coloured; but the Syriac manuscripts of the 7th c. have them with a pattern or border; and they go on increasing in size and splendour from the 8th to the 11th c., when large initial letters, sometimes decorated with little pictures or miniatures, came into fashion in the Greek and Latin manuscripts. The subjects of the figures mixed up with the Arabesque ornaments often referred to the texts; warriors and warlike groups of figures being introduced when the text referred to war; symbolical representations of hell, where the chapters following treated on that region. These initial letters soon increased to a great size, being from 2 to 24 inches long; they were most used in the 8th and 9th centuries, but continued till the 12th c., and degenerated in the 16th to the last decadence of art—the grotesque. The art which flourished in the Eastern and Western Empires passed over to Ireland, and there gave rise to a separate school or kind of illumination. This style, which consists in a regular series of interlaced ribbon ornaments, often terminating in the heads of gryphons and other animals, seems to have been derived from the later patterns of Byzantine art, seen on mosaics, mural paintings, and other objects. Some, indeed, have thought that they are of oriental origin. The so-called Durham Book, in the British Museum, of the 8th c. is a splendid example of the school which was established in Holy Island by St Aidan, and in Kent by St Dunstan, before the end of the 6th century. Another remarkable MS. of this age is the Book of St Kells, at Dublin. The Scriptorium of the monastery at Hyde, near Winchester, was celebrated at this period for its illuminations; and the celebrated St Dunstan of Glastonbury applied in early youth his talents to this art. The minute size and number of interlacements of the *Book of St Kells*, at Dublin, is quite wonderful; while the *Benedictional* of Chataworth, executed by one Godemann of Hyde for Ethelwold, Bishop of Winchester (1100 A. D.), exhibits a bold style of art and ornament. Separate schools prevailed in the 11th c., the Greek or Byzantine manuscripts of the period exhibiting a fine style of ornament derived from the Byzantine school; while the Latin manuscripts of the period are distinguished by the use of a light blue and green in titles and pictures. While, however, the ornaments of the Byzantine and Latin schools were of a more purely architectural character, and the Anglo-Hibernian, Saxon, and even Franco-Gallo manuscripts of Charlemagne and his successors exhibit a union of Roman and Gaulish treatment; a new kind of work arose in the 10th c. in England, called the *Opus Anglicum*, resembling more in character the ornaments of Gothic architecture, a remarkable specimen of which is seen in the Gospels made for Knut or Canute. During the 12th c., there arose a new style, distinguished by the profusion of its ornamentation, intricate mode of illumination, and abundant use of gold and silver. The taste was false, but the art

had become more special, blank spaces being left for the limners to fill in. In the 13th c., the art still more deteriorated in Western Europe—long-tailed illuminated initial letters were introduced; the background was often of gold, on which the ornaments and subjects were coloured in a style resembling oil-painting, from 1190 to 1230; manuals were then prepared to instruct the limner, and the art was formalised. The Gothic style of ornament of this age had superseded the Roman or Byzantine of previous centuries. In the 14th c., the art greatly improved; the border or ornament running all round the page was introduced, and the ornaments were interpolated and enriched with miniature pictures, even by celebrated artists, as Niccolo Pisano, Cimabue, Giotto, in Italy. Few volumes, however, were illuminated till after the reign of Edward I., when the art took a further development; grotesque figures were introduced, and are alluded to by writers of the period. In the 16th c., continuous borders and fine miniature pictures were in use, and towards the end of the century, celebrated works of this nature were produced by Giulio Clovio in Italy, and Lucas van Leyden in Flanders, the Van Eycks, and Memling or Hemlink; medallions of exquisite style and finish were inserted in the border. Of this age, the most beautiful known specimen is the *Book of Hours* of Anne of Brittany, wife of Louis XII., with borders of natural plants on a gold ground. The Italian art of the same age was symmetrical rather than picturesque and naturalistic, but on solid backgrounds; the ornaments, although resembling those of preceding centuries, are distinguished by the introduction of miniatures. In the 16th century, in the reign of Louis XIV., the art became extinct, ending with a style of painting called *camarieu gris*, a kind of monochrome, in which the lights are white or gold, and shaded so as to emulate bas-reliefs. Among oriental nations, the Persians, Hindus, and Chinese have illuminated manuscripts of great beauty, none of which, however, can compete with those of the Western nations in antiquity. For beauty of design, some of the Arab manuscripts are charming, but their antiquity does not reach beyond the 13th century. The Chinese Buddhists have also illuminated classics, or religious books of their sect, one of which, the *Diamond Book* as it is called, in the British Museum, has a text splendidly printed in silver and gold letters on a blue ground; and the vignettes charmingly painted in tempera, on macerated leaves of the *Ficus Indica*.

Humphrey, H. Noel, *Art of Illumination* (12mo, Lond. 1849); Shaw's *Illuminated Letters* (fol. 1828); Bradley, J. W., *Manual of Illumination* (12mo, Lond. 1860).

MANUTIUS, ALDUS (*Aldo*, a diminutive of *Theobaldo*, his baptismal name), a great printer and improver of the art of printing. His name, in its Italian form, is spelled in three different ways by himself or his descendants, viz., Manuzio, Manuzzi, and Manucci; while from his patron, Alberto Pio, Lord of Carpi, he took also the name of Pio, and, after the year 1503, always designates himself Aldo Pio Manutio Romano. He is often called Aldus the Elder. He was born at Bassiano, near Velletri, in the States of the Church, in 1449, and established a printing-press at Venice in 1490 (though the first book bearing a date has 1494), from which many works were issued (see **ALDINE EDITIONS**). He died 1515.

MANZONI, ALESSANDRO, one of the most admired of modern Italian novelists, was born at Milan in 1784, of noble parents, his father being Count Manzoni, and his mother the gifted daughter of the great savan, the Marquis Beccaria. From

youth, the literary predilections of M. gave good promise of his after-mental development. In 1806, at the age of 21, his essay on poetry, entitled *Versi Sciolti*, was inspired by the death of Carlo Imbonati, an intimate family friend; and in 1810 his sacred lyrics met with general admiration. Several tragedies, written with much spirit and originality, attracted notice not only in Italy, but in France and Germany; and foremost amid the warm admirers and favourable critics of M. stood Goethe. The work, however, by which M. attained to European fame is his historical novel, *I Promessi Sposi*—a Milanese story of the 17th c., translated into German, English, French, and other tongues—(3 vols. Milan, 1827), by which a new era may be said to have been created in the fictitious literature of his country. The tale abounds in interesting sketches of national and local Italian customs and modes of life, portrayed with unflagging spirit and humour, while various grave historical events are narrated with force and grandeur of style, especially the episode of the plague in Milan. M.'s ode to Napoleon (1823) is noble in thought and diction. The poet's later years have been spent in strict and devout seclusion, the free tendency of his early opinions having been succeeded by a stringent conformity to the doctrines of Rome. A complete edition of M.'s works, in 5 vols., was published by Tommaseo in Florence (1828—1829).

MAOR, the royal official who, in the early periods of Scottish history, was placed over crown or fiscal lands, and at an after-time became the Thane. A similar official, the Maer, existed in Wales.

MAO'BIS (a New Zealand word signifying *native* or *indigenous*) is the name given to themselves by the inhabitants of New Zealand, and that by which they are now usually designated by ethnologists. The M., in common with the natives generally of Polynesia, belong to the Malay race or family of mankind. Though calling themselves indigenous, the M. have a tradition that their ancestors migrated to the present seat of the nation from the island of Hawaiki about 500 years ago. They came in seven canoes, which had outriggers, to prevent foundering, and were called Amatiatia, being very different from those subsequently used by them, which were much simpler in construction, and named Wakka. The first of these canoes that touched at New Zealand was named Arawa, and this brought over the first settlers from whom the M. are descended. If any faith is to be attached to this tradition, Hawaiki was, probably, the same as Hawaii, the principal of the Sandwich Islands, distant about 4000 miles north-east of New Zealand. Some, however, suppose that it may have been Savaii, one of the Samoan or Navigators' Islands, a group not half that distance away. The tradition says nothing of any indigenous population found in New Zealand before the arrival of these immigrants. Many writers, however, incline to the belief that it was previously inhabited by a darker race, somewhat akin to the Papuas of New Guinea, sometimes called Negritos and Pelagian negroes. Supposing that the two races, in process of time, intermingled, this might account, in some measure, for the differences apparent between the M. and the Tahitians, Samoans, Sandwich Islanders, and other natives of the Pacific. But whether of pure or mixed race, all testimony combines in representing the M. as a nation standing very high in the scale of humanity. The skin of the Maori is in general of an olive-brown colour, but there are some in whom the shade is much lighter, while in others it is darker. In stature they almost equal Englishmen, and have a powerful muscular development. They have well-shaped, intellectual heads,

and their features, when not tattooed, might almost be taken for European. Few of them have beards or whiskers, it being an immemorial custom with them to pluck out the hair on the face with pipi shells. On the head, the majority have long black hair, with a slight wave in it; but with some it is of a reddish tinge, and some M. again have the hair slightly frizzled. Their eyes are large, their lips thick, and their teeth, unlike those of most savage nations, are large and irregular. The women are of less stature than the men in proportion, and are in other respects inferior to them, perhaps from their marrying too young, and having to perform too much of the drudgery of life. Some of the women, however, are represented as being delicately moulded, with long eyelashes, pleasing features, and a plaintive, pathetic voice, which makes them highly interesting. Both sexes used to practise tattooing, a custom which has been almost abandoned since the conversion of the M. to Christianity. It was a painful operation, performed with a hammer and saw-like chisel. The punctures were stained with vegetable dyes, and the patterns, which extended over the face, hips, thighs, &c., represented ornamental scrolls and figures, supposed to denote the rank of the individual wearing them. The women were but slightly tattooed, with a few lines on the lips, chin, and occasionally other parts of the body. The priests were the principal operators, and during the process, ancient songs were sung, to encourage, divert the attention, and increase the patience of the sufferers. This tattooing was supposed to make the Maori youth both more terrible in the eyes of his enemies, and more acceptable in those of his mistresses. Another remarkable custom among the M. was that of the *taboo*, by which the priest could make certain persons and things sacred and inviolate. This was partly a religious and partly a political ordinance, and was so much respected, that even in war-time hostile tribes left unharmed all persons and things thus protected by the *taboo* of the opposite side. Cannibalism, a much more heinous and abominable custom, practised so lately as within the last thirty years, was universally prevalent among the M. before their conversion to Christianity. The last instance of it occurred in the year 1843. 'Now, however,' says Dr Scherzer (*Voyage of the Novara*), 'any allusion to this revolting practice is very painful to the New Zealander, as reminding him of his former low position in the scale of nations. Every time that we endeavoured to make any inquiry of the natives respecting this custom, they withdrew with an ashamed look. In like manner, dogs' flesh has ceased to be an article of food, ever since the introduction of pork by Captain Cook. Formerly, the native or Maori dog, which at present is very scarce, was eaten on certain occasions, while its blood played a somewhat conspicuous part in Maori pharmacy.' Infanticide, which also prevailed largely among them in their days of heathenism, is now universally abolished, and the same is the case with slavery and polygamy. The M. generally marry very young, and instances are known of females among them becoming mothers even at the tender age of eleven years. Their marriages, however, are not very productive, three in a family being considered a good average, and many of these dying in their first year. It is difficult to account for this, seeing that the M. of the present day are not addicted to intemperance, like other half-civilised tribes. The wars of the M. were formerly carried on with spears and clubs of various kinds, manufactured from stone and wood. Their most remarkable weapon was a spear of nephrite, which descended among the principal chiefs from father

to son, and was regarded as a kind of sceptre, and even a sacred object. It was called *Merimeri*, 'the fire of the gods,' and was sometimes used for scalping prisoners. There are other weapons of nephrite in use among the M.; they are much sought after, and very costly. The use of firearms is now, however, very general among the M., and that they are adroit marksmen has been made but too apparent in their contests with English troops. The language of the M., like the Polynesian languages generally, belongs to the Malay family. Its alphabet comprises only fourteen letters, viz., A, E, H, I, K, M, N, O, P, R, T, U, W, and Ng. Seven tolerably distinct dialects are spoken among them. The language is represented as rich and sonorous, well adapted for poetical expression, especially of the lyric kind. The M. have an abundance of metrical proverbs, legends, and traditions, of which a collection has been made by Sir George Grey. They are also passionately attached to music and song. More than five-sixths of the M. are now converted to Christianity. Of these, such as live within the English settlements are becoming gradually assimilated to our own colonists, for the most part wearing the European dress, &c., while those further removed are content with the blanket, which has come to supersede the native cloth. They generally practise agriculture, but will not work very hard. They are good sailors and fishermen, and, indeed, more than a hundred coasting-vessels of a good size are now the property of natives. The M., however, as a nation, although ready to imitate our manners and customs, are not quite contented with our colonial rule, and have frequently raised the standard of revolt against Britain under their native chieftains. Even now (1863) a new war has broken out. Such hostilities are much to be deplored, as the only result that can be looked to is a still further thinning of the Maori race, which has already declined from about 100,000 souls, the amount of the native population twenty years ago, to 56,049, the number, according to an official return, at the end of 1859.

MAORMOR, the old equivalent of the earl in Scotland, an official similar to a Maor (q. v.), but placed over a province instead of a thanage, an earldom or county instead of a barony, exercising the office of royal deputy or steward over the territory of which he had at a still earlier period been the independent lord, and probably retaining to himself the third part of the royal revenues and prerogatives. Prior to the introduction of feudalism, Scotland seems in theory to have been subdivided into maormordoms, each made up of the maormor's portion and the king's, in later language, the earldom and the regality, over both of which the maormor exercised his office, though the former was, in a special sense, his own. Practically, however, in certain of these districts the king retained both maormordom and regality in his own hands, and the maors held their thanages directly of the sovereign, without the intervention of a maormor. As the feudal system extended, the maormors were converted into earls, who were confined within the limits of their own districts, the Earl of Fife alone retaining the privilege of exacting his rights over the whole province.

MAP (Lat. *mappa*, a towel). A map is a delineation, on a plane, of some portion of the surface of a sphere, celestial or terrestrial, on which the objects intended to be shewn are traced, whether stars or towns, mountains, &c. Terrestrial maps are termed *geographical*, when they refer to the land; and *hydrographical* maps, or *charts*, when they delineate the shores of the sea. A perfect representation of a

country, with all its parts in true proportions and relative positions, may be made on a globe; but, since the surface of the earth is spherical, it is not possible so to delineate any large portion of it on a plane as to retain these properties. Hence geographers resort to different methods of representation called projections (q. v.), which are of two kinds—either real perspectives from different points of view, or approximative developments. The five principal projections are—the orthographic, the stereographic, the globular, the conical, and the cylindrical, or Mercator's.

In the first of these, the flat surface on which the map is drawn is supposed to pass through the centre of the earth, and, according to the distance of the eye, the projection is either of the first, second, or third kind. In the *orthographic*, the eye is assumed to be at an infinite distance from the centre of the earth, so that all rays of light proceeding from every point in its surface are parallel and perpendicular.

From the nature of this projection, it is evident that while the central parts of the hemisphere are almost accurately represented, towards the circumference the countries are crowded together and diminished in size. On this account it is of little use for geographical, though of considerable value for astronomical purposes. In the *stereographic*, the eye or point of projection is assumed to be placed on the surface of the sphere opposite the one to be delineated. If the globe were transparent, the eye would then see the opposite concave surface. Contrary to the orthographic, this method contracts the centre of the map, and enlarges it towards the circumference. Owing to the unequal area of the divisions, and the difficulty of finding the true latitude and longitude of places, this projection is not much employed. In order to rectify the opposite effects of the two preceding, the globular projection, a modification of the two, is generally adopted. If we suppose the eye to be removed from the surface to a distance equal to the sine of 45° of the circumscribing circle, the projection is called globular. In other words, if the diameter of the sphere be 200 parts, it must be produced 70 of these parts, in order to give the point of projection.

All meridians and parallels in this projection are in reality elliptical curves, but as they approach so nearly to being circular arcs, they are very rarely shewn otherwise.

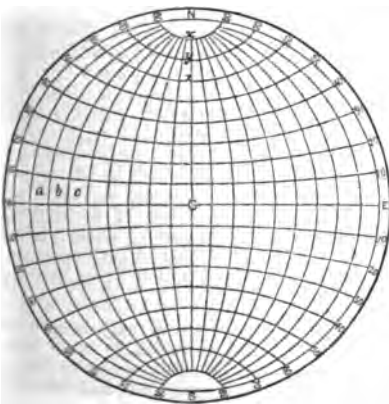

Fig. 1.—Globular, or Equidistant Projection of a Hemisphere.

The construction of the globular or equidistant projection is as follows (fig. 1): Describe a circle

NESW, to represent a meridian, and draw two diameters, NCS and WCE, perpendicular to each other, the one for a central meridian, the other for the equator. Then N and S will represent the North and South poles. Divide each of the quadrants into 9 equal parts, and each of the radii CN, CE, and C also into 9 equal parts. Produce NS both ways, and find on it the centres of circles which will pass through the three points 80×80 , 70×70 , &c., and these arcs described on both sides of the equator will be the parallels of latitude. In like manner, find on WE produced, the centres of circles which must pass through a, b, c , and the poles. Having selected the first meridian, number the others successively to the east and west of it. A map in this way may be constructed on the rational horizon of any place.

The impossibility of getting a perfect representation of special parts of the sphere by any of the previous methods, led to the desire for others less defective. Of all solid bodies whose surfaces can be accurately developed or rolled out upon a plane without alteration, the cone and cylinder approach nearest to the character of the sphere. A portion of the sphere between two parallels not far distant from each other, corresponds very exactly with a like conical zone; whence it is that conical developments make the best projections for special geographical maps, and even with some modifications for large portions of the globe.

A conical projection of Europe (fig. 2) is constructed

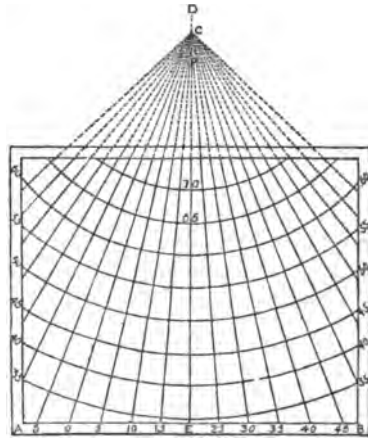

Fig. 2.—Conical Projection of Europe.

thus: Draw a base line AB of indefinite length; bisect it in E, and at that point erect a perpendicular ED, to form the central meridian of the map. Take a space for 5° of latitude, and since Europe lies between the 35th and 75th parallels of latitude, mark off eight of these spaces along ED for the points through which the parallels must pass. The centre from which to describe the parallels will be the point in ED where the top of a cone, cutting the globe at the 45th and 65th parallels, would meet the axis of the sphere. This point will be found to be beyond the North Pole, at C. Since on the parallels of 45° and 65°, where the cone cuts the sphere, the degrees of longitude are exactly equal to those on the globe, if on these parallels distances be marked off equivalent to 5° of longitude, in proportion to the degrees of latitude in those parallels, and through these points straight lines be drawn from C, they will represent the meridians for every 5°.

Since all meridians on the globe are great circles

passing through the poles, the north and south points at any place correspond with the poles of the earth. The east and west points, however, are indicated by a line at right angles to the meridian, and do not, except at the equator, correspond with those of the earth. In all the projections hitherto described, the direction either of the north and south, or of the east and west points, is represented by a curved line, so that on such a map the course of a vessel would almost always be laid down in a curve, which could only be described by continually laying off from the meridian a line at an angle equal to that made with the meridian by the point of the compass at which the ship was sailing. If the vessel were to steer in a direct north-east course by one of the previous projections, she would, if land did not intervene, describe a spiral round, and ultimately arrive at the North Pole; therefore, the mariner requires a chart which will enable him to steer his course by compass in straight lines only. This valuable instrument is supplied by Mercator's chart, in which all the meridians are straight lines perpendicular to the equator, and all the parallels straight lines parallel to the equator.

It is constructed as follows (fig. 3): A line AB is

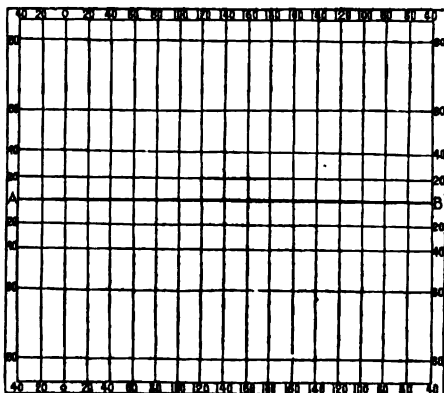

Fig. 3.—Mercator's Projection.

drawn of the required length for the equator. This line is divided into 36, 24, or 18 equal parts, for meridians at 10°, 15°, or 20° apart, and the meridians are then drawn through these perpendicular to AB. From a table of meridional parts (a table of the number of minutes of a degree of longitude at the equator comprised between that and every parallel of latitude up to 89°), take the distances of the parallels and of the tropics and arctic circles from the equator, and mark them off to the north and south of it. Join these points, and the projection is made.

This projection, of course, does not and is not intended to give a natural representation of the earth, its effect being to exaggerate the polar regions immensely. The distortion in the form of countries and relative direction of places, is rectified by the degrees of latitude being made to increase proportionally to those of longitude. This is the only map which gives an unbroken view of the whole surface of the earth.

The term *map* is specially applied to representations of land, or land and water together; while that of *chart* is limited to the coast and water surface only, shewing currents, rocks, anchorage, light-houses, harbours, soundings, and other objects of importance to seamen.

A geographical map proper is a general map of

the world, or of a large extent of country. A topographical map differs from it in being limited in area, and much more detailed. The Ordnance Survey of Britain is a good example of a topographical map. Besides purely geographical and topographical maps, others are constructed for special purposes, which, may be physical, political, or civil, military, statistical, historical, &c.

In order to construct a map, and to determine accurately the positions of places on it, a knowledge of two elements is essential—viz., latitude or distance from the equator, and longitude or distance east or west of the meridian adopted.

Every map, whatever its dimensions, is in some definite relation to the actual size of the globe. This relation is indicated by a scale—a graduated line shewing, by its divisions, the number of miles corresponding to any space measured on the map. The scales of geographical maps range from about 800 miles to an inch (for maps of quarters of the globe) to 10 miles to an inch; those of topographical maps range from 1 inch to 25 inches to a mile, the largest topographical maps we have, admitting of the most minute details.

The Ordnance Survey of Great Britain is on the scale of $\frac{1}{250000}$ of nature, or one inch of paper to one mile of surface.

A recent improvement introduced into our best maps, is that of printing the water-courses in blue ink, making the orography and skeleton of every country stand out in clear relief, thus avoiding the confusion resulting from all the lines being black, as in older maps.

MAPES, or MAP, WALTER, a famous medieval writer of Latin verse, called by Lord Lyttleton 'the Anacreon of the 12th century,' was born somewhere on the frontiers of Wales (probably Herefordshire) before 1150. He studied at Paris, and on his return to England found entrance to the court, became a favourite with Henry II., and was made Archdeacon of Oxford in 1196, after which he does not again appear in history. He is thought to have died about 1210. M.'s best known piece is the drinking-song, beginning

Meum est propositum in taberna mori,

which has been charmingly rendered into English by Leigh Hunt. It is part of a longer poem entitled *Confessio Goliae*. Considerable doubt, however, is now felt as to the proper authorship of the poems commonly attributed to M.; and Mr Wright, who has edited them for the Camden Society (1841), brings forward several reasons for concluding that the author must be a different person from Mapes. The most weighty of these reasons is, that Giraldus Cambrensis, the intimate friend of the archdeacon, severely censures the poems that went under the name of Goliae, of which the famous drinking-song was one, while in the same breath he warmly praises Mapes. It is certain, however, explain it as we may, that soon after the time of the archdeacon they were regarded as his, and his name is inscribed on them in MSS. of the 14th and 15th century. M. also wrote several prose works in Latin and Anglo-Norman.

MAPLE (*Acer*), a genus of exogenous trees of the natural order *Aceraceae*. This order contains more than sixty species, natives of the temperate parts of the northern hemisphere, and particularly numerous in North America and the north of India. They have opposite leaves without stipules, usually lobed or palmate. The flowers are in axillary corymbs or racemes, small, but abounding in honey, and very attractive to bees. The calyx is generally divided into five segments; the petals, when present,

equal in number to the segments of the calyx, grow from the margin of a fleshy, hypogynous disk. The fruit is formed of two small winged nuts, each with one or two seeds. With few exceptions, the genus *Acer* includes the whole order.—The COMMON *M.* (*A. campestre*), a small tree, is a native of Britain, and of many parts of Europe and Asia. The leaves are small, and usually five-lobed; the wood is compact, fine-grained, takes a high polish, and is much used by turners and for carved work. Several nearly allied species are found in the south of Europe.—The STRIPED BARK *M.* (*A. striatum*) of North America, where it often forms great part of the undergrowth in woods, is remarkable for longitudinal black and white stripes on its bark; and its wood, which is very white, is used for inlaying in cabinet-work.—The GREAT *M.* or SYCAMORE (*A. pseudo-platanus*), commonly called *Plane-tree* in Scotland, is a native of various parts of Europe, but a doubtful native of Britain, in which, however, it has long been common. It attains a height of 70—90 feet, has a spreading umbrageous head, and large, palmate, coarsely serrated leaves on long stalks. It is of quick growth, and succeeds well near the sea, and in other exposed situations. The wood is white, compact, and firm; not hard, but capable of a fine polish; and is used by wheelwrights, turners, &c. It is not apt to warp. Stair-rails are often made of it, and pattern-blocks for manufactories, as well as bowls, bread-plates, &c. Sugar is sometimes made from the sap of this tree, as from that of several other maples; but the species which yields it most abundantly is the SUGAR *M.* (*A. saccharinum*) of North America, a species which much resembles the sycamore, and abounds in the northern parts of the United States and in the British possessions, where large quantities of sugar are made from it, although only for domestic use. The trunk of the Sugar *M.* is generally more slender than that of the sycamore. To obtain sugar, holes are bored in the trunk when the sap is ascending, early in spring, before the winter frost has passed away, in an obliquely ascending direction, at no great distance from the ground, at first only to the depth of half an inch, but afterwards deepened to two inches; and the sap thus collected is evaporated in boilers over a brisk fire, to the consistency of sirup, strained and poured into moulds, in which it crystallises into a coarse gray or brown coloured sugar. It is sometimes afterwards refined. Four gallons of sap yield about one pound of sugar. A single tree yields from two to six pounds in a season. During the sugar-making season, sheds are erected in the woods for the boiling and other processes of the manufacture. The sap cannot be kept long after being collected. Good vinegar is made from it, and a kind of molasses much superior to that from the sugar-cane, and much used in America with buckwheat cakes, &c. The wood of the Sugar *M.* has a satiny appearance, and is used for cabinet-making; it is sometimes finely marked with undulations of fibre, and is then known as *Bird's-eye M.*, and is used for veneers. The cultivation of the Sugar *M.* in Europe, for the sake of its sugar, has of late been much advocated. It is not so hardy in the climate of Britain as the sycamore, and seems to require a dry and sheltered situation.—The NORWAY *M.* (*A. platanoides*) is a native of the north of Europe, although not of Britain, and is also found in North America. It much resembles the sycamore, and its wood is used for the same purposes. It is pretty common in plantations in Britain.—A Himalayan species (*A. villosus*), a noble tree, found with pines and birches at great elevations, has recently been introduced into Britain.

MAQUI (*Aristotelia Maqui*), the only known species of a genus of plants sometimes referred to the natural order *Tiliaceae*, and which has also been made the type of a proposed order. It is an evergreen or sub-evergreen shrub, of considerable size, a native of Chili. The flowers are small, green, and yellow, in axillary racemes of no great beauty. The fruit is a three-celled berry, about the size of a pea, black, acid, and eatable; the Chilians make a wine from it. The wood is used for making musical instruments, and the tough bark for their strings. The *M.* sometimes ripens fruit against a wall in England, and is frequently cultivated as an ornamental shrub.

MA'RABOU FEATHERS. See ADJUTANT.

MA'RABUTS, a name given to the descendants of the *Moravides* (Arab. frontier inhabitants), a certain Arabic tribe, which, in 1075, founded a dynasty in the north-western parts of Africa, and held Morocco and Spain for a considerable period. The Almohads having put an end to their temporal dominion, their descendants exercise to this day a kind of spiritual superiority over the Moslem negroes in Barbary, the coast of Guinea, &c. They form a kind of priestly order, officiating at mosques and chapels, explaining the Koran, providing the faithful with amulets, prophesying, and working miracles. They are looked up to with great awe and reverence by the common populace, who also allow them a certain vague licence over their goods and chattels—their wives not excluded. The Great Marabut ranks next to the king, and the dignity of a Marabut is generally hereditary. One of the most eminent *M.* of our day is Abd-el-Kader (q. v.).

MARACAYBO, a fortified city of the South American republic of Venezuela, is situated on a sandy plain on the west shore of the strait which connects the lake of Maracaybo with the gulf of the same name. Lat. 10° 45' N., long. 71° 40' W. It is the chief town of a province of the same name, comprising the territory surrounding the lake of Maracaybo, and containing 33,075 square miles, and a population (1854) of 59,311. It is a handsome town, with a hot but healthy climate, and has a harbour deep enough to contain the largest vessels, but inaccessible to them, owing to the shifting bar at its mouth. It carries on a considerable trade, and, in 1860, 197 vessels, of 36,054 tons, entered and cleared the port. Value of imports for 1860, £243,953; of exports, £341,072. Pop. 25,000 (?).

MARACAYBO, LAKE AND GULF. The Lake of *M.*, in the north of Venezuela, is about 100 miles in length, and 70 miles in breadth. It is of considerable depth, but the bar at its mouth prohibits the entrance of large vessels. It is connected with the gulf of the same name by a strait upwards of 20 miles in length, and from 5 to 10 miles in breadth. The gulf is a wide inlet of the Caribbean Sea, 150 miles from east to west, and about 75 miles from north to south.

MA'RAGHA, an old town of Persia, in the province of Azerbaijan, 50 miles south of Tabriz, on a tributary of Lake Urumiah. It is surrounded by walls, and was long the capital of the province. It contains two bridges of the 11th c., and the remains of the observatory of the celebrated medieval astronomer, Nasir Eddin. Pop. 20,000.

MARAJO, an island on the north-east coast of Brazil, belonging to the province of Para, and situated between the estuaries of the rivers Amazon and Para, is 180 miles in length by 125 miles in breadth. In the north-east, it is somewhat elevated, without trees, and covered by herds of cattle. The

western portion is low, and watered by numerous streams. Pop. estimated at 20,000.

MARANHA'M, or **MARANHAO**, a rich and important maritime province of the empire of Brazil, is bounded on the north by the Atlantic Ocean. Area, 141,939 square miles; pop. (1856) 360,000. The surface is uneven, but there is no range of mountains. It is quadrilateral in shape, and is watered by numerous rivers, which, falling into the Atlantic, traverse its whole length in a direction parallel with its sides. Its climate is fine, and its soil produces vast quantities of rice, for the production of which it is peculiarly fitted. Cotton, sugar-cane, and fruits are also extensively grown. Its surface is still to a great extent covered with forests; iron and lead ores and antimony have been discovered; and sheep, cattle, and horses are extensively reared.—The chief city is *Maranhã*, or *San Luiz de Maranhã*, the fourth in rank and importance, and the best-built city in the Brazilian empire. It is situated on an island of the same name, in lat. 2° 30' S., long. 44° 18' W., is remarkably clean, gay, hospitable, and prosperous, and has a population of 36,000. In 1860, 150 vessels, of 47,140 tons, entered and cleared the port. The imports for that year amounted to £353,400; the exports to £282,961.

MARANO, a town of the province of Naples, situated on a gentle slope four miles from Naples. Pop. 7302.

MARANTA'CEÆ, or **CANNACEÆ**, a natural order of endogenous plants, very nearly allied to *Scitamineæ* (q. v.), and differing chiefly in having all the stamens petal-like, and the one fertile stamen lateral. They are destitute of the aromatic property so general in the *Scitamineæ*. There are about 160 known species, all tropical or sub-tropical. They are all herbaceous perennials. Not many of them are large or notable for the beauty of their flowers. The tuberous root-stocks of many abound in starch.

MARASCHINO. See LIQUEUR.

MARASMUS is a term which was somewhat vaguely used by the older medical writers to designate those cases of general emaciation or atrophy for which they did not see any special cause. The word is now seldom used except occasionally as a synonym for *tubercularis*, or tubercular disease of the mesenteric glands. See **MESENTERY AND MESENTERIC DISEASES**.

MARAT, JEAN PAUL, one of the most infamous characters of the French Revolution, born 1744, of Protestant parents, at Baudry, in Neuchâtel. He spent some of his early years in Britain; published several treatises in London; acted as a teacher of languages in Edinburgh; and underwent punishment for stealing some valuable medals from the museum in Oxford. Afterwards returning to Paris, he practised an inferior branch of the medical profession until the Revolution brought him into prominence as a demagogue. His features and appearance were grotesque, his look wild, and his speeches extravagant, the ludicrous mingling with the terrible. His influence over the lowest classes, however, soon became great. He issued a journal, which he at first called the *Publiciste Parisien*, but afterwards the *Ami du Peuple*, which is historically connected with some of the most fearful events of that period. No falsehood was too monstrous to be published in it, no atrocity too great to be recommended. It was in a great measure the influence of M. which led to the cruelties and massacres of September 1792, in the midst of which he was elected a member of the Convention, but on his appearance there he was

received with almost universal expressions of abhorrence. No one would sit beside him, and when he attempted to speak, a tumult always arose. His journal, now the *Journal de la République*, became more ferocious and sanguinary than ever. He demanded the sacrifice of 270,000 heads, and defended this in the Convention, saying that if these were not granted, he would demand more. During the king's trial, he was urgent for his immediate execution, and in his journal called upon the people to slay 200,000 of the adherents of the old régime, and to reduce the Convention to one-fourth. In April 1793, M. obtained the enactment of the fearful law against suspected persons, in virtue of which 400,000 were imprisoned. Robespierre, Danton, and M. were now the triumvirate which ruled France. But on July 13, 1793, M. was stabbed in his own house by Charlotte Corday (q. v.). This event was followed by some of the worst atrocities of the Reign of Terror; streams of blood flowing, as was said, to the manes of M., whose likeness, with gaping wounds, painted by David, was exhibited on an altar in the Court of the Louvre, and then hung up in the Convention; whilst it was decreed that his housekeeper, whom he had married 'one fine day, in the presence of the Sun,' should be maintained at the expense of the state. A decree of 4th November 1793 gave to M.'s remains the honours of the Pantheon; but they were cast out of it again on 8th November 1795, and his picture was removed from its place in the Convention.

MARATE'A, a town of the Neapolitan province of Basilicata, situated on the slope of a mountain, in the midst of a lovely and salubrious country. Pop. 6480.

MARATHON, anciently, a village on the east coast of Attica, about 20 miles north-east of Athens, now called Marathon, or, according to Leake, the present Vrana. It was situated in a plain of the same name, about six miles in length and three in breadth, with a background of mountains in the west, and a marsh both on the north and south; eastward, it reached the sea. Byron's lines in the *Isoles of Greece* correctly describe it:

The mountains look on Marathon—
And Marathon looks on the sea.

It is gloriously memorable as the scene of the grand defeat of the Persian hordes of Darius by the Greeks under Miltiades (490 B.C.).

MARAU'DING (a word, common under orthographic variations, to most of the European languages, and, probably, of identical root with the verb 'to mar') is irregular plunder or violence offered to the inhabitants of a country by the individuals of an army. In all armies where discipline is maintained, marauding is, at least professedly, punished by death; the provost-marshal having power to inflict that penalty summarily on all offenders taken in the act.

MARAVEDI, an old Spanish coin, either of vellon, worth about $\frac{1}{4}$ ths of a farthing; or of silver, worth $\frac{1}{2}$ ths of a farthing.

MARBLE, in its strict and proper sense, is a rock crystallised in a saccharoidal manner, having the fracture of loaf-sugar, and composed of carbonate of lime, either almost pure when the colour is white, or combined with oxide of iron or other impurities which give various colours to it. But many other kinds of stone are popularly included under this title. Indeed any limestone rock sufficiently compact to admit of a polish is called marble. It is only in this vague sense that the indurated amorphous rocks used in this country can receive

this name. Such are the black, red, gray, and variegated limestones of the Old Red Sandstone Period found in Devonshire, which are very beautiful from the numbers of exquisitely preserved corals which abound in them; the marbles of the Carboniferous series from Flintshire, Derbyshire, and Yorkshire, so full of encrinites; the shell marbles from the Oolite rocks at Rance, Stamford, and Yovil; and the dark Purbeck and Petworth marbles, beautifully 'figured' with shells, from the Wealden strata, which were so much used by the architects of the middle ages.

Saccharine or statuary marble is a white fine-grained rock, resembling loaf-sugar in colour and texture, working freely in every direction, not liable to splinter, and taking a fine polish. Of the marbles used by the ancients, the most famous are—Parian marble, a finely granular and very durable stone, with a waxy appearance when polished. Some of the finest Grecian sculptures were formed of this marble, among others, the famous Venus de Medici. The marble of Pentelicus was at one time preferred by the Greeks to Parian, because it was whiter and finer grained. The Parthenon was entirely built of it, and many famous statues still remain which were executed in this marble, but they are always more or less weathered, never retaining the beautiful finish of the Parian statues. The quarries at Carrara were known to the ancients, but they have been more extensively wrought for modern sculptors, who use this marble chiefly. It is a fine-grained, pure white marble, but is so often traversed by gray veins, that it is difficult to get large blocks free from them. Of coloured marbles, the best known are the Rosso Antico, a deep blood-red, sprinkled with minute white dots; Verde Antico, a clouded green produced by a mixture of white marble and green serpentine; Giallo Antico, a deep yellow, with black or yellow rings; and Nero Antico, a deep black marble.

The crystalline structure of marbles may be the original condition in which the rock was formed as a chemical deposition, in the same manner as some stalactites are crystalline, but there can be no doubt that they principally owe their structure to metamorphic action, which has taken place subsequent to their deposition. This action having at the same time destroyed all trace of fossils, marbles were considered formerly as belonging to the Primitive or Metamorphic series of rocks; but while they generally are members of one of the Palaeozoic formations, it is now known that some of the statuary marbles of Greece and Italy are Secondary, and others even Tertiary limestones.

MARBLEHEAD, a seaport town of Massachusetts, United States of America, on Massachusetts Bay, 16 miles north-east of Boston. Its population was formerly devoted to the fisheries, but is now largely engaged in manufacturing, chiefly boots and shoes. The town was settled by emigrants from the Channel Islands. At the close of the revolutionary war, there were 600 widows; and at the end of the war of 1812, 500 citizens of M. were prisoners of war in England. Pop. in 1860, 7646.

MARBURG, an interesting old German town, capital of the province of Upper Hesse, in the electorate of Hesse-Cassel, on both banks of the river Lahn, 50 miles north of Frankfurt-on-the-Main. Its situation is strikingly beautiful. It is placed chiefly on a hill, round which are built quaint old-fashioned houses, interspersed with buildings of a later date, and separated by terrace-gardens. The hill is crowned by the stately burg or castle, while at its base extends the lovely valley of the Lahn. Of the ecclesiastical edifices, the principal is the

fine Gothic church of St Elizabeth, begun 1255, completed 1283, having two towers 303 feet in height. It was erected in honour of St Elizabeth (q. v.), daughter of Andreas II. of Hungary, and wife of Ludwig, Landgraf of Hesse and Thuringia. From her, the ancestress of the Cassel and Darmstadt branches of the House of Hesse, is descended the present (1863) Princess (Alexandra) of Wales. The castle of Marburg was built in 1065. In one of its halls, the conferences between the Wittenberg and Swiss reformers regarding the Lord's Supper took place. The university of M. was founded in 1527 by Philip the Magnanimous, Landgraf of Hesse, and soon became one of the most flourishing in Protestant Europe. Among its earliest students were the celebrated Patrick Hamilton, and William Tyndale, the translator of the English Bible. The university has four faculties—Theology, Jurisprudence, Medicine, and Arts; and comprises about forty professors, twenty lecturers, and from 300 to 350 students. It contains a library of 112,000 volumes. Extensive potteries and tanneries are in operation. Pop. 8000.

MARCATO, in Music, means in a strongly accented or marked manner.

MARCELLUS, **M. CLAUDIUS**, a famous Roman general, of one of the most eminent plebeian families. He was consul for the first time in 222 B. C., and obtained a decisive victory over the Insubrians in Cisalpine Gaul, slaying with his own hand their king, Britomartus or Viridomarus, whose spoils he dedicated to Jupiter, and was honoured with a triumph. This was the third and last occasion in Roman history on which *spolia opima* were offered to the gods. In the Second Punic War, M. fought as prætor, in 216 B. C., against Hannibal at Nola, in Campania; and the victory which he gained was the more important, as it shewed that Hannibal was not invincible, and that the Romans had not been irreparably overthrown at Cannæ. In the course of two years, he thrice repulsed the Carthaginian general at this place. Being consul again in 214 B. C., he was intrusted with the command of the war in Sicily. He took Leontini, massacring in cold blood 2000 Roman deserters whom he found there, and then advanced against Syracuse, which he tried to storm. All his efforts were rendered unavailing by the skill of Archimedes (q. v.), and he was compelled to regularly blockade the city. Famine, pestilence, and ultimately treachery on the part of the Spanish auxiliaries of the Syracusans, enabled M. to make himself master of the place (212 B. C.), after which the remainder of Sicily was soon brought under the dominion of the Romans. He was the first Roman general who adopted the practice (afterwards so common) of despoiling conquered cities of their works of art. In 210 B. C., he was again consul, and was again opposed to Hannibal, with whom he fought an indecisive battle at Numistro, in Lucania, and by whom he was defeated at Canusium, in Apulia, in 209 B. C., but on the day following retrieved the defeat. In 208 B. C., he was for the fifth time elected to the consulate, and assumed once more the command of the Roman army against Hannibal. When out reconnoitring one day, he fell into an ambuscade, and was slain. The Carthaginian general treated his remains with honour. It ought to be noticed that the accounts of M.'s life given by Livy, Plutarch, and others, are believed to be very much coloured and distorted—as Polybius, one of the best and most trustworthy authorities on the Punic War, denies that he ever defeated Hannibal at all!

MARCELLUS, the name of two popes, of whom the latter deserves special notice, as having, when

Cardinal Marcello Cervini, taken a very prominent part in the discussions of the Council of Trent, over which he was appointed to preside as legate of Julius III. He is also remarkable from the minor but curious circumstance of his not complying with the ancient custom by which the pope, on his election, lays aside his baptismal name, and assumes a new one. Marcello Cervini retained on his elevation the name which he had previously borne. He was elected March 9, 1555, and survived his elevation but 22 days.

MARCH, the first month of the Roman year, and the third according to our present calendar, consists of 31 days. It was considered as the first month of the year in England until the change of style in 1752, and the legal year was reckoned from the 25th March. The Anglo-Saxons called it *Hlyd monath*, stormy month, and *Hraed monath*, rugged month. There is an old proverb, still used by the English and Scotch rustics, which represents March as borrowing three days from April; and in *The Complaynt of Scotland* they are thus described:

The first it shall be wind and weat;
The next it shall be snaw and sleet;
The third it shall be sic a freeze
Shall gar the birds stick to the trees.

But it is disputed whether these 'borrowed days' are the last three of March or the first three of April.

MARCH, a musical composition, chiefly for military bands, with wind instruments, intended to accompany the marching of troops. There are slow and quick marches, also marches peculiar to different countries.

MARCHANTIA, a genus of *Hepatica* (q. v.), the type of a sub-order distinguished by the spore-cases bursting irregularly, and the spores being mixed with elaters, by some botanists elevated into a distinct order. Several species are natives of Britain, some of which are very common in moist shady situations, covering rocks, earth, &c., with their spreading green lichen-like fronds.

MARCHEÑA, a town of Spain, in the province of Sevilla, and 33 miles east-south-east of the city of that name, in a district rich in corn and olives. In the vicinity are sulphur baths, to which many invalids resort. Pop. 11,600.

MARCHES, the boundaries between England and Scotland, also between England and Wales. See **MARK**.

MARCHES, in Scotch Law, mean the boundaries of property. By an ancient Scotch statute, one proprietor can compel an adjoining proprietor to join him in erecting a mutual fence, or to bear half the expense thereof. No such power exists in England or in Ireland.

MARCHING, one of the first necessities to distinguish a body of disciplined troops from a mere crowd of men is a regular cadenced step, taken by every individual at the same time, and with the same foot. The necessity of this for harmonious action is obvious. The ancient Roman legions had military music to beat time for their march. In the feudal ages, when infantry fell into disrepute, cadenced marching was unattended to, and seems only to have been thoroughly revived by Marshal Saxe. The best music for a march is found to be some simple tune, such as can readily be performed by drums and fife. The music, besides preserving the time, acts as a preventive of fatigue.

In the British service, there are the slow march of 75 paces, each of 30 inches, in a minute—only used on parade; the quick march, of 110 paces, in which all evolutions are performed; and the double-quick, of 150 running paces, with the

knees raised high. This last cannot be sustained for any great distance, and is employed in a charge, or in suddenly occupying a hill or some commanding position, and in a few short internal movements of regiments.

Countermarching is an evolution by which a body of men change front, and at the same time retain the same men in the front-rank. The operation for a company will be understood by the annexed diagram, where the solid line represents the first

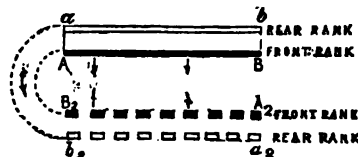

Countermarching:

AB, original position; A₂B₂, a₂b₂, the new position. The arrows denote the direction in which the ranks face.

position, and the broken line that afterwards taken up, the movement being represented by 'right face, quick march, left wheel, forward, halt, front, dress.' On the same principle, a whole army will sometimes change front. If after the countermarch the order 'rear-face' be given, the same front will be preserved, with the rear-rank in front, and what was previously the right now serving as the left. A rear-rank may also become a front-rank by merely countermarching round the end of the latter, which remains stationary.

MARCION'SI, a town of the Neapolitan province of Terra di Lavoro, situated 13 miles north of Naples, in a low unhealthy plain, in the midst of several lakes. Pop. 9210.

MARCION, the founder of the Marcionites, an extremely ascetic Gnostic sect, was the son of a Bishop of Sinope in Pontus. In his earlier years, he was a sailor or ship-master. Being excommunicated by his father, on account of his heretical opinions, he went to Rome about 140 A.D. He made several anxious efforts to obtain a reconciliation with the Catholic Church, for he does not appear to have loved schism; but his restless, prying, theorising intellect constantly led him into opinions and practices too hostile to those of his fellow-Christians to permit of their being passed over in silence. After his final excommunication, he associated himself with the Syrian Gnostic Cerdon, and founded a system, in some respects, quite antagonistic to Christianity. The gospel of Christ, according to him, consisted in free love of the Good; the Mosaic system, with its motives of rewards and punishments, was mere legality; and there is as irreconcilable an opposition between the respective authors of the 'Law' and the 'Gospel,' i. e., the Creator, on the one hand, and the God of the Christians, on the other, as there is between these two works. His system is but imperfectly known; and it is supposed to have assumed either three or four aboriginal beings—Good, Evil, Creator, and Master. See **GNOSTICS**. Respecting the outward form of worship practised among his followers, little is known save that it had great similarity—as had their whole religious system—to that of the Manichæans (q. v.). M. entirely rejected the Old Testament; and of the New Testament, all but a few Epistles and the Gospel of St Luke, which had also to undergo certain changes from his hand. The first four chapters were omitted, and the fifth he began with the words: 'In the 15th year of the reign of Tiberius Cæsar, God came to Capernaum, a city of Galilee, and spoke on the Sabbath.' The

Marcionites subsisted as a distinct party till the 6th c. and were diffused through Syria, Egypt, Palestine, &c. Tertullian and others wrote against them.

MARDIN, a considerable town of Asiatic Turkey, is strikingly situated, at an elevation of 2300 feet, on the southern slopes of the Mardin Hills (anciently Mount Masius), 57 miles south-east of Diarbekir. It contains numerous mosques, bazaars, and baths, and the ruins of an old castle. The ornaments in Arabesque on the gates of the citadel are said to be finer than those of the Alhambra. Pop. about 15,000, of whom the half are Moslem Kurds, and the other half Chaldeans, Maronites, and Jacobites (q. v.), and who carry on manufactures of linen and cotton fabrics, and of leather. During the decline of the khalifate of Bagdad, M. rose to considerable importance, and was for a long time the capital of a principality under a branch of the Ayubites (descendants of Salah-ed-din), but its short-lived glory was soon after quenched by the advancing tide of the Mongols. It was subsequently taken by Timür.

MAREE, LOCH, in the west of Ross-shire, Scotland, is 18 miles in length, with a breadth varying from one to three miles, and a depth, in some places, of 60 fathoms. Owing to its great depth, it never freezes over its whole extent. It is surrounded by mountain-scenery which, for wildness and grandeur, is not excelled in Scotland. Its waters are carried off to the sea by the river Ewe, two miles in length. The loch contains numerous islets, one of which contains the remains of an ancient chapel, with a graveyard.

MAREMMA (corrupted from *Marittima*, situated on the sea), a vast marshy region of West Italy, extending along the sea-coast of Tuscany, from the mouth of the Cecina to Orbitello, and embracing an area of 997 square miles. The Pontine Marshes and the Campagna of Rome are similar districts. Formerly, these Maremme were fruitful and populous plains; but neglect of the water-courses of the district allowed the formation of marshes; and now they have become generators of tertiary fevers, and present an aspect of dreary desolation in the summer months, when the inhabitants flee from their miasmata, prejudicial alike to man and beast. Leopold II., the late Grand Duke of Tuscany, directed especial attention to the drainage and amelioration of the Tuscan Maremme, and considerable success attended their being largely planted, trees being a corrective of their malarious effects. From 1828 to 1848 the cost of the drainage of the M. was £531,000. The arable land in the vicinity of the M. is exuberantly fertile; but the harvests are gathered by hired labourers in the most infected districts, and in their emaciated and livid features may be seen the fatal action of malaria. During winter, the M. is inhabitable, and yields good pasture.

MARENGO, a village of Italy, in the Sardinian province of Alessandria, situated near the Bormida, in the midst of extensive forests. M. was the scene of a memorable battle, in which a French army, commanded by Bonaparte, and numbering somewhat more than 20,000, defeated and routed 32,000 Austrians, under General Melas, on the 14th June 1800.

MAREOTIS, or **MAREIA, LAKE**, the modern *Birket-el-Maridit*, a salt lake or marsh in the north of Egypt, extends southward from the city of Alexandria, and is separated from the Mediterranean, on its north-west side, by a narrow isthmus of sand. In ancient times, its length was about 42 miles, its breadth about 22. Its shores were

planted with olives and vines, and the papyrus, which grew upon its banks and on its eight islets, was famous for its fine quality. In more recent times, the canals which fed Lake M. were neglected, and its depth and area were much reduced. In the 18th c., the bed had become, in great part, a sandy waste; but in 1801, during the war between the English and French, the sea was let in by the former, and it is now again a marshy lake. The passage by which the sea found entrance was subsequently closed up by Mehemed Ali. The present dimensions of the lake are about 27 miles long by 25 miles broad.

MARGARET, sometimes called the 'Northern Semiramis,' queen of the triple Scandinavian kingdom of Denmark, Norway, and Sweden, was the second daughter of Valdemar III., king of Denmark, and wife of Hakon VIII., king of Norway. M. was born in 1363, and on the death of her father, without direct male heirs, in 1375, the Danish nobles, passing over the son of Valdemar's eldest daughter, Ingeborg of Mecklenburg, offered the crown to M. and her husband in trust for their infant son Olaf. By the death of Hakon in 1380, M. became sole guardian of the young prince, who died at the age of 17 in 1387; and such was the discretion with which she had conducted the government during her sole regency, that the estates of both kingdoms concurred in electing her as their joint sovereign ruler. Having received the crown at their hands, she convoked a *landthing*, in which she announced that, with the concurrence of her subjects, she would nominate her grand-nephew, Eric of Pomerania, as her successor; and although, owing to Eric's infancy at the time, and his subsequent incapacity, the real power rested in the hands of M., she contented herself from that time with the title of 'Margaret, by the grace of God, daughter of Valdemar, king of Denmark.' At the moment that M. was cementing the union of Norway and Denmark, the condition of affairs in Sweden opened the way for a further extension of her power; for the Swedish king, Albert of Mecklenburg, had so thoroughly alienated the affections of his subjects, that the nobles, declaring the throne vacant, offered to acknowledge M. as their ruler. The queen lost no time in sending an army into Sweden to support her pretensions, and defeated the king's German troops at Leaby, where Albert and his son Eric fell into her hands. Albert remained in prison seven years, during which time M. succeeded in wholly subjugating Sweden; and in 1397 she made her triumphal entry into Stockholm, with her nephew Eric, who shortly afterwards was, in his 16th year, crowned king of the three Scandinavian kingdoms. On this occasion, M. brought forward the memorable Act of Union, which she had drawn up with her own hand, and to which were appended the signatures of seventeen of the principal men in the three kingdoms. By this remarkable act, known as the Union of Calmar, from the place at which it was signed and first promulgated, it was stipulated that the three kingdoms should remain forever at peace under one king, retaining their own laws and customs; and that, at the death of the sovereign, if he left several sons, one of their number should be chosen by the combined estates of the three realms, who were also to elect a new king in the event of the deceased monarch having died childless. It had required all the genius and conciliatory power of a M. to fuse the discordant elements, of which her triple sovereignty were composed, into harmony, and it is scarcely to be wondered, therefore, that her utopian schemes for one vast Scandinavian unity of empire should have utterly broken down at her death, and soon

seeds of dissension for centuries to come. The Swedes, who were jealous of the Danes, never cordially concurred in the act, and were the first to attempt to set it aside. M. died in 1412, leaving the character of a politic and able ruler. Where fair means failed to secure her ends, she shewed herself ready to act with the astute craft for which her father had been noted; and while she possessed unusual powers of fascination, she seems to have combined masculine vigour with considerable beauty of person. By the Danes, M. has been especially venerated; but they have reason to the present day to lament the political blunder to which the pressure of circumstances drove her, when she converted Holstein into a hereditary fief, and thus severed it more completely from the crown, to which it had previously stood in the relation of an appanage.

MARGARET, Sr, Queen of Malcolm Canmore (q. v.).

MARGARET OF ANJOU, wife of Henry VI. of England, and daughter of René of Anjou, the titular king of Sicily, and of Isabella of Lorraine, was born at Pont-à-Mousson, in Lorraine, March 1425. She was married to Henry VI. of England in 1445; and her husband being a person of very weak character, she exercised an almost unlimited authority over him, and was the virtual sovereign of the realm; but a secret contract at her marriage, by which Maine and Anjou were relinquished to the French, excited great dissatisfaction in England. The strife between the English and French, which lost to the former the whole of their possessions in France except Calais, was charged upon Margaret. In 1450, occurred the insurrection of Jack Cade, and soon after, the country was plunged in the horrors of that bloody civil war known as the *Wars of the Roses* (q. v.). After a struggle of nearly 20 years, M. was defeated and taken prisoner at Tewkesbury, and imprisoned in the Tower, where she remained five years, till Louis XI. redeemed her for fifty thousand crowns. She then retired to France, and died at the château of Dampierre, near Saumur, in Anjou, 25th August 1482.

MARGARIC ACID ($C_{34}H_{58}O_3 \cdot HO$) is one of the solid fatty acids. At an ordinary temperature, it is solid, white, and crystalline; it makes a persistent greasy spot on paper; it is perfectly insoluble in water, dissolves in boiling alcohol, from which it separates in glistening groups of very delicate needles, appearing under the microscope as bunches of lily-leaf-shaped crystals, or in star-like forms, and is readily soluble in ether. It unites with bases, forming margarates, and in combination with glycerine (q. v.) forms the glyceride or fat known as margarine.

This acid occurs either in a free state or in combination with alkalis in most of the animal fluids, with the exception of the urine, and as a glyceride it is widely diffused in the animal and vegetable fats. Heintz has thrown considerable doubt on the existence of this acid, and maintains that it is a mixture of about ten parts of Palmitic Acid (q. v.) with one part of Stearic Acid (q. v.).

MARGARINE ($C_{100}H_{180}O_{12}$) appears, from the researches of Berthelot (who has succeeded in forming this and other fats artificially), to be a combination of three equivalents of hydrated margaric acid with one equivalent of glycerine, with the loss of six equivalents of water; or in symbols—

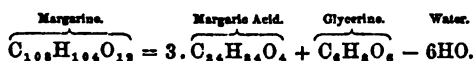

It constitutes the solid ingredient of human fat, of

butter, of goose-grease, of olive oil, &c. It crystallises from hot alcohol as a white flocculent powder, which under the microscope appears in the form of very delicate needles, so grouped as to radiate from one point, and thus to form a whorl of fine capillary threads. According to the views of Heintz, referred to in the article MARGARIC ACID, margarine is a mixture of palmitine and stearine.

MARGARITA, an island in the Caribbean Sea, belonging to the South American republic of Venezuela. Length, 40 miles; average breadth, 12 miles; area, 441 square miles. Pop. estimated at 15,000. M. was discovered by Columbus in 1498, and was long famous for its pearl-fisheries, whence its name.

MARGARITA, SANTA, a town of Sicily, 42 miles north-west Girgenti. Pop. 7000.

MARGATE, a municipal borough, seaport, and famous watering-place of England, in the Isle of Thanet, Kent, about 70 miles east-south-east of London. All the usual resources of a watering-place—theatre, baths, libraries, assembly-room, &c.—are found here; and a fine pier, which is the principal promenade. The shore, covered with a fine and firm sand, is well adapted for sea-bathing. Fishing is carried on to a considerable extent. A fluctuating population of between 50,000 and 100,000 is poured into the town by railway and steamer during the season. Pop. (April 8, 1861) 8874.

MARGUERITE DE VALOIS, in her youth known as Marguerite d'Angoulême, sister of Francis I. of France, and daughter of Charles of Orleans, Comte d'Angoulême, was born at Angoulême, 11th April 1492. She received a brilliant, and even a profound education, Greek and Hebrew being among her accomplishments, as well as Spanish, Italian, and Latin; yet she was characterised by the most charming vivacity. In 1509, she was married to Charles, Duke of Alençon, who died in 1525. Out of love to her brother, Francis I., she repaired to Madrid, to attend him in his sickness, during his imprisonment there. In 1527, she was married to Henry d'Albret, king of Navarre, to whom she bore a son, who died in infancy, and a daughter, Jeanne d'Albret, mother of the great French monarch, Henri IV. She encouraged agriculture, the arts and learning, and to a certain extent embraced the cause of the Reformation. When the persecution of heretics in France began to wax hot, and furious monks declared that she ought to be tied up in a sack, and pitched into the Seine, she felt it necessary to be prudent and reserved in her speech, and in her later years even returned to the practices of the Roman Catholic Church. But she never ceased to act with a courageous generosity towards the Reformers, who always found an asylum and welcome in Navarre. She wrote a little religious work, *Miroir de l'âme Pécheresse*, which was condemned by the Sorbonne, as favouring Protestant doctrines. She also wrote poems and tales, and a *Heptaméron des Nouvelles* (Par. 1559, and other editions). This last is a singular performance for a pious lady like M.—one hardly knows what to make of it. Inferior to its model (the *Decameron* of Boccaccio) in point of genius and inventiveness, it fully equals it in indecency. It has been translated into English, and forms one of Bohn's *extra volumes*. M. died at Odos, in Bigorre, 21st December 1549.

MARIA CHRISTINA, Queen of Spain, born at Naples, 27th April 1806, is a daughter of Francis I., king of the Two Sicilies. On the 11th December 1829, she became the fourth wife of Ferdinand VII. of Spain; who, anxious to secure the throne to his own posterity, restored in March 1830 the law of '*Siete partidas*,' by which, in

MARIA LOUISA—MARIA THERESA.

default of male issue, the right of inheritance was given to females, and in October of that year, the queen gave birth to a daughter, the present Isabella II. of Spain. The Spanish liberals gladly embraced the cause of the queen, rejoicing to see the dreaded Don Carlos, Ferdinand's brother, further removed from probable succession to the throne. Ferdinand died, 29th September 1833, and by his testament his widow was appointed guardian of her children—the young Queen Isabella, and the Infanta Maria Louisa, now Duchess de Montpensier—and also regent, till the young queen should attain the age of eighteen years. A civil war broke out, the adherents of Don Carlos seeking to place him on the throne. The event of this war, which continued till 1840, was long doubtful, and Spain was fearfully desolated by contending armies; but the queen-mother seemed indifferent to everything except the company of Don Fernando Muñoz, one of the royal body-guard, whom she made her chamberlain, and with whom she was united, in December 1833, in a morganatic marriage, which, however, was kept secret, whilst her connection with him was no secret. She has had ten children by him. A conspiracy, which broke out on the night of the 13th August 1836, exposed Muñoz to great danger, and led the queen-mother to concede a constitution to Spain. Her practice as regent was to adopt the course agreeable to the minister of the day, and thus her government was despotic under one ministry and liberal under another. She contrived, however, upon many occasions to embarrass the proceedings of her more liberal or constitutional ministers; but when she sanctioned by her signature the law respecting the *Ayuntamientos* (q. v.), a popular commotion ensued, and she gave to the new prime minister Espartero (q. v.), 10th October 1840, a renunciation of the regency, and retired to France, but continued to interfere from her retirement in the affairs of Spain. After the fall of Espartero, she returned to Madrid in 1843, and in October 1844, her marriage with Muñoz, who was now made Duke of Rianzares, was publicly solemnised. Her participation in the schemes of Louis Philippe as to the marriage of her daughters, in 1846, and her continual exercise of all her influence in a manner unfavourable to constitutional liberty, made her the object of great dislike to the whole liberal party in Spain. At length, in July 1854, a revolution expelled her from the country, and she again took refuge in France, where she had taken care to place most of her property.

MARIA LOUISA, the second wife of the Emperor Napoleon I., born 12th March 1791, was the daughter of the Emperor Francis I. of Austria. She was married to Napoleon, after his divorce of Josephine, 2d April 1810. The marriage seemed to give stability to the Bonaparte dynasty, and in some measure to afford a prospect of peace to Europe. On 20th March 1811, she bore a son, who was called King of Rome. At the beginning of the campaign of 1813, Napoleon appointed her regent in his absence, but under many limitations. On the abdication of Napoleon, she went to Orleans, and thence, in company with Prince Esterhazy, to Rambouillet. She was not permitted to follow her husband, but went with her son to Schönbrunn, where she remained till, in 1816, she received the duchies of Parma, Piacenza, and Guastalla, on the government of which she then entered. She contracted a morganatic marriage with Count von Neipperg. She died at Vienna, 18th December 1847.

MARIA THERESA, Empress of Germany, the daughter of the Emperor Karl VI., was born at Vienna, 13th May 1717. By the Pragmatic Sanction

(q. v.), her father appointed her heir to his hereditary thrones. In 1736, she married Francis Stephen, Grand Duke of Tuscany, to whom she gave an equal share in the government when she became Queen of Hungary and of Bohemia, and Archduchess of Austria, on the death of her father, 21st October 1740. She found the monarchy exhausted, the finances embarrassed, the people discontented, and the army weak; whilst Prussia, Bavaria, Saxony, Naples, and Sardinia, stirred up by France, put forward claims to portions of her dominions, chiefly founded on the extinction of the male line of the House of Hapsburg. Frederick II. of Prussia soon made himself master of Silesia; Spain and Naples laid hands on the Austrian dominions in Italy; and the French, Bavarians, and Saxons conquered some of the hereditary Austrian territories. The young queen was in the utmost danger of losing all her possessions, but was saved by the chivalrous fidelity of the Hungarians, the assistance of Britain, and most of all by her own resolute spirit. Her enemies also quarrelled amongst themselves; and the War of the Austrian Succession, after lasting more than seven years, terminated in her favour by the peace of Aix-la-Chapelle in 1748. She lost only Silesia and Glatz, and the duchies of Parma, Piacenza, and Guastalla, whilst, on the other hand, her husband was elected emperor. During the time of peace, she made great financial reforms; agriculture, manufactures, and commerce flourished, the national revenues greatly increased, and the burdens were diminished. The empress availed herself of the increase of the revenue for the increase of her military power. She held the reins of government herself, but was much guided by her husband and her ministers. She found at last in Kannitz (q. v.) a minister possessed of the wisdom and energy requisite for the conduct of affairs, and in him she placed almost unlimited confidence. The *Seven Years' War* (q. v.) between Austria and Prussia again reduced Austria to a state of great exhaustion; but when it was concluded, the empress renewed her efforts to promote the national prosperity, and made many important reforms, ameliorating the condition of the peasantry, and mitigating the penal code. Her son Joseph was elected king of the Romans in 1764; and on the death of her husband, in 1765, she associated him with herself in the government of her hereditary states, but in reality committed to him the charge only of military affairs. She joined with Russia and Prussia in the partition of a third part of Poland (1772), after the death of Augustus III., although she at first objected to the proposed spoliation, and thought it necessary to satisfy her conscience by obtaining the approval of the pope. Galicia and Lodomeria were added to her dominions at this time. She also compelled the Porte to give up Bukowina to her (1777). The brief Bavarian war of succession ended in her acquisition of the Innthal, but led to the formation of the *Fürstentbund* or *League of German Princes*, which set bounds to the Austrian power in Germany. M. T. died 29th November 1780. Throughout her reign, she displayed a resolute and masculine character, and raised Austria from deep depression to a height of power such as it had never previously attained. Although a zealous Roman Catholic, she maintained the rights of her own crown against the court of Rome, and endeavoured to correct some of the worst abuses in the church. She prohibited the presence of priests at the making of wills, abolished the right of asylum in churches and convents, suppressed the Inquisition in Milan, and in 1773 the order of Jesuits. She also forbade that any person, male or female, should take monastic vows before the age of 25 years. She did nothing, however, to

ameliorate the condition of the Protestants in her dominions. She had three sons and six daughters. Her eldest son, Joseph II., succeeded her.

MARIANA, JUAN, a distinguished Spanish historian and scholar, was born at Talavera in 1537, and in 1554 entered the then rising order of the Jesuits. His early studies, both in languages and theology, were so brilliant that he was appointed to teach in the schools of his order, first at Rome (where the celebrated Bellarmine was one of his scholars) in 1561, afterwards in Sicily in 1565, and finally in Paris in 1569. After a residence there of seven years, his health became so much impaired that he was compelled to return to his native country, and settled at Toledo, where he resided till his death, at an extreme old age, in 1624. His retirement, however, was not inconsistent with the most energetic and sustained literary activity. From an early period, he devoted himself to a History of Spain, of which he published 20 books in 1592, and 10 additional books, carrying the narrative down to 1516, in 1605. The original of this history was Latin, the elegance and purity of which have secured for M. a place among the most distinguished of modern Latinists. Its great historical merit also is admitted, although with some drawbacks, even by Bayle. M. himself published a Spanish translation, which still remains one of the classics of the language. Among his other productions, are a volume published at Cologne in 1609, consisting of Seven Treatises on various subjects; scholia on the Bible, which, although written at the age of 83, display a degree of vigour as of learning which might provoke the admiration of modern biblical students; an edition of the works of Isidore of Seville, with notes and dissertations; and several similar works. But the most celebrated of the works of M. is his well-known treatise, *De Rege et Regis Institutione*, which appeared in 1599, and in which is raised the important question, Whether it be lawful to overthrow a tyrant? M. decides that it is—even where the tyrant is not a usurper but a lawful king. See JESUITS. The principles of the book, in other particulars, are in the main the same as those of all modern constitutional writers. The tyrannicide doctrines of this writer drew much odium upon the entire order of Jesuits; but it is only just to observe that while, upon the one hand, precisely the same doctrines were taught in almost the same words by several of the Protestant contemporaries of M. (see Hallam's *Literary History*, iii. 130—140); on the other, M.'s book itself was formally condemned by the general Aequiviva, and the doctrine forbidden to be taught publicly or privately by members of the order.

MARIAZE'LL, the most famous place of pilgrimage in Austria, on the north border of the crown-land of Styria, 24 miles north of Bruck. It consists of a number of inns, or lodging-houses, and contains 900 inhabitants. It is visited by 100,000 pilgrims annually. Here there is an image of the Virgin believed to possess the power of working miracles. During the great annual procession from Vienna, the greater number of the pilgrims of both sexes spend the night in the woods in drinking, singing, and general riot. Formerly, the processions from Gratz and Vienna took place at the same time, but owing to the fighting, as well as debauchery, that characterised the occasion, the processions were ordained to take place at different times.

MARIE ANTOINETTE DE LORRAINE, JOSEPHINE JEANNE, wife of Louis XVI. of France, was the youngest daughter of Francis I., Emperor of Germany. Her mother was the famous Maria Theresa (q. v.). M. A. was born at Vienna,

November 2, 1755; at the age of fourteen, was betrothed to the Dauphin; and in the following year was married at Versailles. Her reception by her husband and the king, Louis XV., was flattering enough; but her Austrian frankness and simplicity, her *naïveté*, unceremonious pleasantry, and detestation of rigid etiquette, scandalised Versailles. Soon after the accession of Louis XVI. (May 1774), libels were circulated by her enemies, accusing her of constant intrigues, not one of which has ever been proved. Her faults, as a queen (and, in that age, rapidly growing earnest, angry, and imbibited, they were fatal ones), were a certain levity of disposition, a girlish love of pleasure, banquets, fine dress, an aristocratic indifference to general opinion, and a lamentable incapacity to see the actual misery of France. The affair of the *diamond necklace* (q. v.), in 1785, hopelessly compromised her good name in the eye of the public, although, in point of fact, M. A. was quite innocent of any grave offence. Her political rôle was not more fortunate. Loménie de Brienne and Calonne were ministers of her choice, and she shared the opprobrium called down upon them for their reckless squandering of the national finances. She strongly opposed the Assembly of the Notables, and in the following year, of the States-general, and, indeed, she had good reason to dread their convocation, for one of the very first things the Notables did was to declare the queen the cause of the derangement of the finances. From the first hour of the Revolution, she was an object of fanatical hatred to the mob of Paris. Her life was attempted at Versailles by a band of assassins on the morning of October 6, 1789, and she narrowly escaped. After this, she made some spasmodic efforts to gain the goodwill of the populace by visiting the great manufactories of the capital, such as the Gobelins, and by seeming to take an interest in the labours of the workmen, but the time was gone by for such transparent *showing* to succeed. The relentless populace only hated her the more. At last she resolved on flight. Her husband long refused to abandon his country, and she would not go without him. A dim sense of kingly duty and honour was not wanting to Louis, but after the mob stopped his coach (April 18, 1791), and would not let him go to St Cloud, he consented. The flight took place on the night of the 20th June. Unfortunately, the royal fugitives were recognised, and captured at Varennes. From this time, her attitude became heroic; but the French people could not rid themselves of the suspicion that she was secretly plotting with the allies for the invasion of the country. After the useless effort to defend the Tuileries (August 10, 1792), she was confined in the Temple, and separated from her family and friends. Here she was subjected to the most sickening humiliations. About a year after (August 1, 1793), she was removed to the Conciergerie, by order of the Convention, condemned by the Revolutionary Tribunal (October 15), and guillotined next day. See *Mémoires sur la vie privée de Marie Antoinette*, by Mme Campan (Paris, 1823); Buchez and Roux, *Histoire Parlementaire*; and Lacretelle, *Histoire de France pendant le XVIII^{me} Siècle* (6 vols. Paris, 1850).

MARIE DE MEDICIS, wife of Henri IV. of France, was the daughter of Francis I., Grand-Duke of Tuscany, and was born at Florence, 26th April 1573. She was married to Henri 16th December 1600, and in the following September, gave birth to a son, afterwards Louis XIII. The union, however, did not prove happy. M. was an obstinate, passionate, waspish, and withal dull-headed female,

and her quarrels with Henri soon became the talk of Paris. She was—as such women are apt to be—wholly under the influence of favourites. A certain couple, who professed to be man and wife, Leonora Galigal and Concini, exercised a most disastrous influence over her mind, and, of course, encouraged her dislike to her husband. The assassination of Henri (May 14, 1610) did not much grieve her, and she was even suspected of complicity in the act, but nothing was ever ascertained that could incriminate her. For the next seven years, she governed as regent, but proved as worthless a ruler as she had been a wife. After the death of Concini, a sort of revolution took place. Louis XIII. assumed royal power. She was confined to her own house, and her son refused to see her. Her partisans tried to bring about a civil war, but their attempts proved futile; and by the advice of Richelieu, then Bishop of Luçon, she made her submission to her son in 1619, and took her place at court. M. hoped to win over Richelieu to her party, but she did not in the least comprehend that mighty genius; however, she soon enough found out that he had no mind to be ruled by her, whereupon she resolved, if possible, to undermine his influence with the king. Her intrigues for this purpose failed; she was imprisoned in Compiègne, whence she escaped, and fled to Brussels in 1631. Her last years were spent in utter destitution, and she is said to have died in a hayloft at Cologne, 3d July 1642.

MARIE GALANTE, an island in the West Indies, one of the Lesser Antilles, belongs to France, and lies 17 miles south-east of Guadeloupe. Area, about 60 square miles, covered for the most part with wood, and surrounded by steep rocky shores. The cultivated soil produces sugar, coffee, and cotton. Cattle and horses are abundant, the latter of a highly esteemed breed. Its chief town, Grand-bourg, or Marigot, on the south-west coast, has a population of 2000. The population of the island is 13,000. M. G. is so called from the name of the ship commanded by Columbus when he discovered the island in 1493.

MARIENBAD, one of the most frequented of the Bohemian spas, 33 miles north-west of Pilsen, at an elevation of almost 2000 feet above the level of the sea. The springs of M. have long been used by the people of the vicinity, but it is only since the commencement of the present century that it has become a place of resort for persons from distant parts of the world. The springs are numerous, varying in temperature from 48° to 54° Fahrenheit. They are saline, containing sulphate of soda and various alkaline ingredients, but differing considerably in their composition and qualities. They are used both internally and in the form of baths. Great quantities of the waters of some of the springs are exported to distant places. M. is surrounded by wooded heights, has a population of 1100, and is visited every season by upwards of 5000 patients.

MARIENBURG, an old town of Prussia, in the province of West Prussia, on the Nogat, 28 miles south-east of Danzig. It was long the seat of the Grand Masters of the Teutonic Order (q. v.) of Knights, who removed from Venice hither in the year 1300. The first fortress of the Knights, however, was founded here in 1274. M. remained in the hands of the Knights till 1457, when it was taken by the Poles. The castle, or palace, in which 17 Grand Masters had resided, a noble edifice in a species of Gothic peculiar to the vicinity of the Baltic, was restored in 1820. Pop. 7595.

MARIENWERDER, one of the most prosperous and beautiful towns of the province of West Prussia, is picturesquely situated on an elevation, about two miles east of the Vistula, and 47 miles south-south-east of Danzig. It was founded in 1233 by the Teutonic Order of Knights, and its old castle was the residence of a commander of that order. The town derives its prosperity chiefly from being a residence of numerous government officials. Manufactures of various kinds are carried on, and fruit is extensively cultivated. Pop. 6607.

MARIGOLD, a name given to certain plants of the natural order *Compositæ*, sub-order *Corymbifera*, chiefly of the genera *Calendula* and *Tagetes*. The genus *Calendula* has the achenia remarkably curved, variously toothed, and very rough on the back. The species are annual and perennial herbaceous plants and shrubs, of which some of the former are found in the countries bordering on the Mediterranean, the latter chiefly in South Africa. *Por M.* (*C. officinalis*) is an annual, a native of France and the more southern parts of Europe, with an erect stem, 1—2 feet high, the lower leaves obovate on long stalks, and large, deep yellow flowers. It has long been very common in British gardens, and there are varieties with double flowers. The whole plant has a slight aromatic odour, and a bitter taste. It was formerly in great repute as a carminative, and was regarded also as an aperient and sudorific. The florets were the part used, and they were dried in autumn, to be preserved for use. They are often employed to adulterate saffron, and sometimes for colouring cheese. They were formerly a frequent ingredient in soups, and are still so used in some parts of England.—The genus *Tagetes* consists of annual and perennial herbaceous plants, natives of the warmer parts of America, although *T. erecta*, one of those most frequently cultivated in Britain, bears the name of **AFRICAN MARIGOLD**; and *T. patula*, another annual well known in our flower-borders, is called **FRENCH MARIGOLD**. Both species are Mexican. They have been long in cultivation, and with a little assistance of a hotbed in spring, succeed well even in Scotland, and are much admired for the brilliancy of their flowers.—**CORN M.** is a *Chrysanthemum* (q. v.).—**MARSH M.** (q. v.) has no botanical affinity with the true marigolds.

MARINE ENGINE. See **STREAM-ENGINE.**

MARINE FORTIFICATION differs from land fortification in that the approaches of the enemy which are to be resisted take place on the level of the sea, so that he can come near without having to overcome the dangerous slope of the glacis. The combat is simply one between two powerful batteries, and the question to be decided is, whether the ship or the fort will first be placed *hors de combat*: the ship having ordinarily the largest number of guns, while the fort has more solid battlements, and its fewer guns of great calibre can be fired with a steadiness unattainable on so shifting a base as the ocean. Under these circumstances, the less relief a sea-fortress has the better, as by so much the less is it likely to be hit from the shipping. Its walls are usually built perpendicular, or nearly so. The magazines and quarters for the men are bomb-proof, as also are the casemates, from which the guns are usually fired, although sometimes, as in the martello-tower, the gun is worked on the top of the structure.

Sea-fortifications may be of various importance; the simplest being the battery consisting of a mere parapet formed in a cliff or on a hill, and mounted with guns to command the sea; these are generally built in such concealed situations, that it is hoped the hostile ships will not perceive them until they

actually open fire. They are numerous all around the British coast. Next greater in importance is the Martello Tower (q. v.). More powerful still are the beach-forts, such as those which on either shore defend the entrance to Portsmouth harbour: these are constructed of the most solid masonry, and armed with guns of the heaviest calibre, sweeping the very surface of the sea, so as to

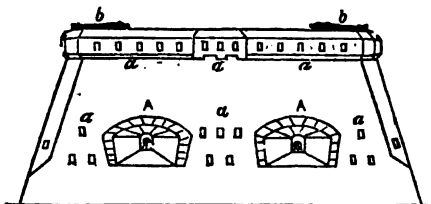

Casemated Bomb-proof Sea-fort:

A, casemate embrasures; a, loopholes for small-arms; b, guns mounted en barbette.

strike an approaching ship between wind and water. The guns are usually in bomb-proof casemates, and the fort is often defended on the land side, if the coast be level; if, however, higher ground be behind, this would be useless, and then the sea-front alone is defensible. Most terrible of all sea-forts, however, are the completely isolated forts, with perpendicular faces and two or three tiers of heavy guns. Such are the tremendous batteries which render Cronstadt almost inapproachable, and by which Spithead and Plymouth Sound are now being fortified. These forts are generally large, with all the requisites for a garrison to maintain itself; against them, wooden ships stand no chance, and in the American Civil War, Fort Sumter at Charleston has shewn itself no mean antagonist for iron-sided. In the new forts at Spithead, &c., iron is to be employed as the facing, in plates of such vast thickness and weight, that it is supposed no ship can ever possess any comparable resisting power; and as they are to be armed with guns, the smallest of which will probably be 300-pounders, it is expected that they will be able to destroy any fleet that could be sent against them.

At the present day, the value of sea-fortifications is disputed, as iron-plated vessels may pass them with impunity, unless the artillery in the fort be so heavy as to destroy the armour of the ships. In the long-run, however, it is apparent that the fort can command the greater power; for its armour may be of any thickness, while that of the ship must be limited by her floating powers, and on the other hand, the limit to the size of artillery must be sooner reached in a ship than in a solid and stationary fortress.

MARINE-STORE DEALERS, in point of law, are subjected to certain restrictions as regards the business they carry on, in order to keep some check on their relations with thieves and other vendors of stolen property. They are bound, under a penalty of £20, to have their name and the words 'Dealer in Marine Stores' distinctly painted in letters not less than six inches in length over their warehouse or shop; to keep books stating the name of the person from whom they bought or received the respective articles in their possession; not to purchase marine stores from any person apparently under 16 years of age; not to cut up any cable or article exceeding five fathoms in length without a permit from justices of the peace. By a recent act, 24 and 25 Vict. c. 101, dealers in old metals have also been subjected to similar restrictions. Whenever a dealer in old

metal has been once convicted of being in possession of stolen property, justices of the peace may order him to be registered at the chief police-office of his district, and he shall keep a book containing entries of the goods he has, and of the person from whom obtained, &c.

MARINED, a term applied in Heraldry to an animal whose lower part is terminated like the tail of a fish.

MARINES are soldiers that serve on board ships of war. The men are drilled in all respects as soldiers (light infantry), and therefore on shore are simply ordinary land-forces. On board ship, they are trained to seamen's duties, but still preserving their military organisation. Their ordinary functions are as sharpshooters in time of action, and at other times to furnish sentries for guarding the stores, gangways, &c. They are useful as exercising a good control over the less rigidly disciplined sailors; and having always firearms and bayonets ready, they have often been instrumental in suppressing the first outbreaks of mutiny. The Royal Marines are divided into four divisions of light infantry and one of artillery. Promotion cannot be purchased, but goes by seniority throughout the corps. In rank, marine officers correspond with army officers of similar grades according to seniority; as a corps, the marines take place between the 49th and 50th regiments of infantry of the line. Every ship, on being commissioned, has her complement of marines drafted into her. The uniform is red, with blue facings and white belts. On their colours, the men proudly bear the word 'Gibraltar,' in the famous defence of which fortress they bore an heroic part.

Marines were first established, as a nursery from whence to obtain seamen to man the fleet, by order in council of 16th October 1664. Their utility becoming conspicuous, other regiments of marine forces were raised, so that by 1741 there were 10,000 men, and in 1759 as many as 18,000. During the great French war, the number rose above 30,000, but a great reduction took place after peace was concluded. By the navy estimates of 1863—1864, 18,000 marines are provided, including 3150 artillery, at a cost for the year of £512,055. Their government rests solely with the Admiralty.

MARINI, GIOVANNI BATISTA, an Italian poet, born at Naples in 1569. After a period of fruitless study, M. abandoned jurisprudence for the more congenial pursuit of poetry, a decision which so incensed his father as to lead to his expulsion from home. All through life, M. seems to have courted troubles by his unbridled licentiousness, and many of his best compositions are polluted with a shameless obscenity, unavailingly deplored by the poet at the approach of death, when he expressed the desire that they should be suppressed and destroyed. M. quitted Naples for Rome, and finally followed in the suite of Cardinal Aldobrandini to Turin, where he was at first received with flattering notice from the reigning prince, Charles Emmanuel; but on the publication of some biting satirical verses, he was thrown into prison. On his release, he repaired to France, where Marie de Medicis received him with marked favour, and conferred on him a liberal pension. In his poem *Il Tempio* he celebrates this queen's noble qualities. His best work, the *Adone*, was written during his residence in France, and on its publication, he revisited his native country (1622), and died at Naples, aged 56, in 1625, in the midst of high public festivities in his honour. He is the founder of the *Marinist* school of poetry, of which the essential features are florid hyperbole and false overstrained imagery.

MARINO, or **SAN MARINO**, one of the most ancient and most limited republican states of Europe, consists of a craggy mountain 2200 feet in height, situated amidst the lesser ranges of the Apennines, and encircled by provinces formerly belonging to the Pontifical States. It possesses a total area of 21 miles, and comprises a town of the same name, and several villages in the adjacent territory. The climate is healthy, but, owing to its exposure, high winds and frequent rains prevail. The town of M. is built on a slope of the mountain; it is accessible only by one road, and is protected by walls and towers; it contains several squares and streets, rudely paved, and various public buildings, including seven churches, a town-hall, a theatre, the governor's palace, convents, museums, and hospitals. The inhabitants, who are reckoned at 8000, are noted for their hospitality, sobriety, industry, and general morality. They are sensitively jealous of their rights, and cling with tenacity to their territorial and legislative independence. Their chief trade is in agricultural produce and cattle.

The early history of the republic is very obscure. During the medieval wars of Italy, M. had its pigmy feuds and factions, which seem to have been none the less envenomed from the pettiness of the arena in which they were enacted. In 1740, the democratical form of government was securely guaranteed against further assault. The rights of this miniature state were scrupulously respected by Napoleon during his Italian campaign. The government, designated the Sovereign Grand Council (*Generale Consiglio Principe*), is composed of 60 members, of whom one-third are nobles. From this number are selected the smaller 'Council of Twelve' (two-thirds from the town and the rest from the country), who, with the assistance of a juriconsult, decide in questions of the 2d and 3d instance. The representatives of the state are termed Captains-regent (*Capitani Reggenti*). They are chosen, the one from the party of the nobles, the other from the bourgeoisie. They each hold office only for six months. The army, or rather the militia of the republic, numbers 1189 men.

MARIO, GIUSEPPE, MARQUIS DE CANDIA, was born at Turin in 1810, of an aristocratic family, and evinced from his boyhood high musical abilities. In 1830, he received his commission as officer in the Chasseurs Sardes; but having involved himself in some youthful escapade, was ordered from Genoa to a temporary retreat at Cagliari. From thence he threw up his commission, and finally escaped to Paris, on his resignation not being accepted. The young Sardinian deserter speedily won his way into the most exclusive circles of fashionable Paris, both by the genuine, manly stamp of his nature, and the charm of his exquisite voice. Having contracted debts, however, he accepted the appointment of first-tenor of the Opera, with a salary of 1500 francs per month; at the same time he changed his name from Marquis of Candia to Mario. After a term of two years' study at the Conservatoire, M. made his debut, on the 2d December 1838, in *Robert le Diable*, and achieved the first of a long series of operatic triumphs. At the Théâtre Italien, he took rank with Rubini, Lablache, Malibran, Sontag, and Grisi; and by none of these great artists was he excelled in purity, sweetness, method, and taste. From 1845 to 1850, he fulfilled an engagement in Russia, and on his return appeared in London, where his success was immense. M.'s operatic career has been a succession of brilliant and remunerative engagements. In his private capacity, he is esteemed for his large-handed liberality to the many political exiles of his country,

and his noble assistance to struggling artists. His repertoire embraces all the great works of Rossini, Bellini, Donizetti, and Verdi.

MARIO'LATRY (Gr. *Maria*, and *latreia*, adoration), a name given by polemical writers to the worship paid by Roman Catholics to the Virgin Mary. This name is intended to imply that the Catholic worship of the Virgin is the supreme worship of *latreia* or adoration, which Catholics earnestly disclaim, although, from her relation to our Lord, they hold her worship, which they style *hyperdulia*, to be higher than that of all other saints. See INVOCATION OF SAINTS. Many examples of prayers addressed to Mary, of acts of worship done in her honour, and of expressions employed regarding her, are alleged by controversialists, for the purpose of shewing that the worship of Mary in the Roman Church is in effect 'adoration.' Such are (see Farrar's *Ecclesiastical Dictionary*, p. 372) the 'Litany of the Sacred Heart of Mary;' the adaptation of the Athanasian Creed as a profession of faith regarding her; addresses to her as the 'hope of the desponding, and refuge of the destitute;' professions that 'her Son has given her such power that whatever she wills is immediately done;' kneelings and prostrations before her image; pilgrimages in her honour. To these and similar allegations, Roman Catholics reply, that many of the objected prayers and devotional practices are entirely unauthorised by the church, and that some of them are undoubtedly liable to misinterpretation; but they further insist that all such prayers, however worded, are to be understood, and are, in fact, understood by all Roman Catholics, even ordinarily acquainted with the principles of their faith, solely as petitions for the intercession of Mary, and as expressions of reliance, not on her own power, but on the efficacy of her prayers to her Son. It would be out of place in this work to enter into such controversies, and we shall content ourselves with a brief account of the origin and nature of the worship of the Virgin Mary in the church, and of its present condition, as it is professed by those religious bodies among which the practice now prevails.

Although no trace is found in the New Testament of any actual worship of the Virgin Mary, yet Roman Catholic interpreters regard the language of the angel Gabriel, who saluted her as 'full of grace,' or highly 'favoured,' and as blessed 'among women,' and her own prediction in the canticle of the Magnificat, that 'all nations should call her blessed' (Luke i. 48), as a foreshadowing of the practice of their church; and they rely equally on the language employed by the early Fathers, as, for instance, Irenæus, regarding the Virgin, although Protestants consider it as having reference to the incarnation. But it seems quite certain that, during the first ages, the invocation of the Virgin and the other saints must have held a subordinate place in Christian worship; the reason for which, according to Roman Catholics, was probably the fear which was entertained of reintroducing among the recent converts from paganism the polytheistic notions of their former creed. But from the time of the triumph of Christianity in the 4th c., the traces of it become more apparent. St Gregory Nazianzen, in his panegyric of the virgin martyr Justina, tells, that in her hour of peril she 'implored Mary the Virgin to come to the aid of a virgin in her danger' (Opp. tome i. pp. 278, 279). St Ephraim, the Syrian, in the same age, uses language which is held by Roman Catholics to be equally favourable to their view; and the fact that about this time there arose a sect, the Collyridians, who were condemned for the actual adoration of the Virgin, seems to them to prove

that some worship of her must have existed in the church, out of which this excessive worship of the Collyridians grew. But it was only after the heresy of Nestorius that the worship of Mary seems to have obtained its full development. His denial to her of the character of mother of God, and the solemn affirmation of that character by the ecumenical council of Ephesus (430 A. D.), had the effect at once of quickening the devotion of the people, and drawing forth a more marked manifestation on the part of the church of the belief which had been called into question. The 5th and 6th centuries, both in the East and in the West, exhibit clear evidence of the practice; and the writers of each succeeding age till the Reformation speak with gradually increasing enthusiasm of the privileges of the Virgin Mary, and of the efficacy of her functions as a mediator with her Son. St Bernard, and, still more, St Bonaventura, carried this devotional enthusiasm to its greatest height; and the popular feeling found a stronger and still more strong manifestation in the public worship of the church. From a very early period, we find several festivals of the 'blessed Virgin;' but in the centuries to which we refer, the number received large additions. The institution of the 'Rosary of the Virgin Mary,' the appointment of a special office in her honour, and more than all, the fame of many of the sanctuaries which were held to be especially sacred to her worship, gave a prominence to the devotion which Protestants find it difficult to reconcile with the honour which they hold due to God alone.

The chief festivals of the Virgin, common to the Western and Eastern Churches, are the Conception, the Nativity, the Purification, the Annunciation, the Visitation, and the Assumption. All these festivals are retained in the English calendar. The Roman Church has several special festivals, with appropriate offices—all, however, of minor solemnity.

MARIONETTES, little jointed puppets of wood or cardboard, representing men and women, and moved by means of cords or springs by a concealed agent. They are exhibited in what are called marionette theatres, the exhibitor varying his voice, so that a sort of dramatic performance is accomplished. This entertainment was known to the Greeks, and from them passed to the Romans. In modern times, it has chiefly prevailed in France and Italy, and has there reached a very respectable degree of artistic perfection.

MARIOTTE, EDMÉ, a distinguished French natural philosopher, was born in Burgundy during the first half of the 17th c., and was the prior of St Martin-sous-Beaune, when the Academy of Sciences admitted him within its pale in 1666. His life is devoid of particular interest, having been almost wholly spent in his cabinet, among his books and instruments. He died in 1684. M.'s forte consisted in an extraordinary power of drawing conclusions from experiment. He repeated Pascal's experiments on gravitation, and detected some peculiarities which had escaped that ingenious philosopher; confirmed Galileo's theory of motion; enriched hydraulics with a multitude of discoveries, and finally made a thorough investigation into the subject of the conduction of water, and calculated the strength necessary for pipes under different circumstances. His collected works were published at Leyden in 1717, and at the Hague (2 vols. 4to) in 1740. His *Traité du Mouvement des Eaux* was published by La Hire (Paris, 1786, 12mo).

MARIOTTE, LAW OF, an empirical law deduced by Boyle (q. v.) and Mariotte (q. v.) from two independent series of experiments, though, strangely enough, reached by both at about the same time; it

is generally expressed as follows: *The temperature remaining the same, the volume of a given mass of gas is in inverse ratio to the pressure which it sustains.* This law may be held to be substantially correct within a considerable range of pressure. But the labours of Regnault have made it evident that atmospheric air and most other gases, especially under very high pressures, are really more compressed than if they followed the law. This deviation is most marked in the case of gases capable of being liquefied, as they approach the point of liquefaction.

MARITZA (the anc. *Hebrus*), a river of European Turkey, in the province of Rumili, takes its rise in lat. 42° N., long. 24° E., and flows east-south-east to Adrianople, where it bends south, and falls into the *Ægean* by the Gulf of Enos. It is upwards of 300 miles in length, and is navigable to Adrianople, about 100 miles from its mouth.

MARIU'POL, or **MARIAMPOL**, a seaport in the government of Ekaterinoav, Russia, is situated near the place where the Kalmius falls into the Sea of Azov, 60 miles west of Taganrog. It was founded in 1779 by Greek emigrants from the Crimea, and the port was opened to foreign vessels in 1836, when 20 ships entered it; but by 1853 their number had increased to 309. The articles of export are wheat, linseed, wool, and hides from the adjacent provinces, the total value in 1853 being £500,000. The imports are insignificant, ships most commonly arriving in ballast. Pop. 5289, who speak a corrupt jargon derived from the Turkish and Greek languages.

MARIUS, C., a Roman general, was born of an obscure family, at the village of Cereata, near Arpinum, 157 B. C. In the Numantine war (134 B. C.), he served with great distinction under the younger Scipio Africanus, who treated him with high consideration, and even indicated that he thought him a fit successor to himself. In 119 B. C., he was elected tribune of the plebs, and signalled himself by his vigorous opposition to the nobles, by whom he was intensely hated. In 114 B. C., he went to Spain as propretor, and cleared the country of the robbers who infested it. He now married Julia, the aunt of Julius Cæsar. He accompanied Q. Cæcilius Metellus to Africa in 109 B. C., was elected consul two years after, and intrusted with the conduct of the Jugurthian war, which he brought to a successful close in the beginning of 106 B. C. From this period dates the jealousy between him and L. Sulla, then his quaestor, which was ultimately productive of so many horrors. Meanwhile, an immense horde of Cimbri, Teutones, and other northern barbarians, had burst into Gaul, and repeatedly defeated the Roman forces with great slaughter. M. was again called to the consulate for the year 104 B. C., and for the third, fourth, and fifth time in the following years, 103—101 B. C., for it was felt that he alone could save the republic. The war against the Teutones in Transalpine Gaul occupied him for more than two years; but he finally annihilated them in a battle of two days' duration at Aquæ Sextiæ, now Aix, in Provence, where 200,000—according to others, 100,000—Teutones were slain. After this, he assumed the chief command in the north of Italy against the Cimbri (q. v.), whom he also overthrew, near Vecelle to the west of Milan, with a like destruction (101 B. C.). The people of Rome knew no bounds to their joy. M. was declared the saviour of the state, the third founder of Rome, and his name was mentioned along with those of the gods at banquets. He was made consul for the sixth time in 100 B. C. It has often been remarked, that, had he died at this period, he would have left behind

him one of the greatest reputations in Roman history. When Sulla, as consul, was intrusted with the conduct of the Mithridatic war, M., who had long manifested an insane jealousy of his patrician rival, attempted to deprive him of the command, and a civil war began (88 B.C.). M. was soon forced to flee, and after enduring the most frightful hardships, and making numerous hairbreadth escapes, he reached Africa, where he remained until a rising of his friends took place under Cinna. He then hurried back to Italy, and, along with Cinna, marched against Rome, which was obliged to yield. M. was delirious in his revenge upon the aristocracy; a band of 4000 slaves carried on the work of murder for five days and nights. M. and Cinna were elected consuls together for the year 86 B.C., but the former died after he had held the office seventeen days.

MARJORAM (*Origanum*), a genus of plants of the natural order *Labiata*, having a ten-ribbed, five-toothed calyx, loose spikes, and broad bracts. The species are annual, perennial, and shrubby plants, natives chiefly of the East, and of the countries bordering on the Mediterranean. They abound in a yellow essential oil—*Oil of M.* or *Oil of Origanum*—which is obtained from some of the species by distillation. The COMMON M. (*O. vulgare*) is the only species found in Britain, and is



1, Sweet Marjoram (*Origanum Majorana*); 2, Common Marjoram (*Origanum vulgare*).

not unfrequent in dry hilly and bushy places. It is a perennial plant, has a stem one foot high, ovate leaves, and roundish, paniced, crowded heads of purple flowers, with large bracts. It is used, as are also other species, as a seasoning in cookery, and an infusion of it as a stimulant, tonic, and remedy for nervousness. The powder is an errhine. The essential oil is used as a palliative of toothache, and is mixed with olive oil, to make a stimulating liniment, which is used as a remedy for baldness and in rheumatic complaints, and in cases of sprains and bruises.—The SWEET M. of our gardens (*O. Majorana*) is an annual plant, a native of Greece and the East, with ovate grayish-green leaves, covered on both sides with a thin down, about three roundish heads of flowers growing close together, wrinkled bracts, and small white flowers. Its uses are similar to those of the common marjoram.

MARK, the standard of the German money-system. During the Carolingian period, a pound-

weight (the Roman pound of 12 oz., which had been adopted as the standard of weight by the Frankish kings) of pure silver was coined into 240 pennies (*denarii*), so that a pound of money, or 240 silver pennies, actually weighed a pound. But in the course of time the coins became debased, and while they retained their original nominal value and weight, were actually only worth $\frac{1}{4}$ or $\frac{1}{5}$ of this. To make matters worse, the debasement of the coins was not uniform, and there was no standard by which their relative values might be estimated. The necessity of a remedy was urgently felt among the commercial cities of Germany, fast rising in importance; and as 240 of the pennies then commonly current, contained about half a Cologne pound of pure silver, it was agreed to accept this as the standard. The Cologne pound was divided into 32 oz., and the half-pound of 16 oz. had been known by the name of a *Mark* as early at least as 1042; and thus the mark of 16 Cologne oz. of pure silver has come to be the fundamental standard of reference in German coinage. Since 1750, Prussia has coined the fine mark into 14 thalers, and has gradually brought the other thaler-reckoning states to adopt the same rate. In the states reckoning by guldens, 24 $\frac{1}{2}$ guldens now contain a fine mark, except in Austria, where 20 guldens make a mark. The mark at one time used in English reckoning, was $\frac{3}{4}$ of a pound, or 13s. 4d.; a Scotch mark, 13 $\frac{1}{2}$ d.

MARK, a German geographical term, signified primarily the *mark* of a country's limits (the *mark*); and hence was applied as a designation of the border countries or districts of the German empire, conquered from the Slavonians, Hungarians, Wendes, and other neighbouring nations. Thus, we read of the marks of Austria, of Northern Saxony or Brandenburg, Lausatia, Slesvig, Moravia, Steiermark, &c. The governors intrusted with the charge of these border districts, or *marks*, were called *mark-grafs*, corresponding to the English and Scottish *Wardens of the Marches*. See **MARQUIS**.

MARK, the Evangelist, is probably the same who, in the Acts of the Apostles, is called John Mark. He came originally from Jerusalem, was a nephew of Barnabas, and accompanied the Apostle Paul and him to Antioch, Cyprus, and Perga in Pamphylia, returned to Jerusalem, and went afterwards to Cyprus, and thence to Rome (see Acts xiii.; Col. iv. 10; 2 Tim. iv. 11). Ecclesiastical tradition speaks of a missionary expedition of M. to Egypt and the west of Africa, of his suffering martyrdom about the year 62 or 66 (the Coptic church still consider him their founder and first bishop), and of the transmission of his corpse to Venice, which city has chosen him for its patron saint. The festival (April 25) which the Roman Catholic Church holds in his honour is no older than the close of the 7th century. The canonical gospel which passes under his name is believed by some scholars to have sprung from a primitive collection of notices of the life and acts of Christ, drawn up by M., and to have been worked up into its present form by a later writer, who had before him the gospels of Matthew and Luke. Others, on the contrary, are of opinion that in M.'s work we have the primitive gospel from which the rest have originated. Compare Wilke, *Der Urevangelist* (Dresd. and Leip. 1838), and Baur, *Das Marcus-evangelium* (Tüb. 1851). See **GOSPELS**.

MARKET OVERT, a term in English Law, used to denote an open market. If stolen goods are sold in open market without fraud on the part of the buyer, the real owner cannot reclaim them

from such purchaser, till he has prosecuted the thief.—In Scotland, the real owner can reclaim the goods at any time, whether in the meantime sold in open market or not.

MARKETS. See FAIRS.

MARL (Ger. *Mergel*), a mixture, naturally existing, of clay and carbonate of lime, often also containing sand and other substances. Marls are found in very different geological formations, but everywhere seem to owe their origin to deposition by water. The name is sometimes applied to friable clays, or mixtures of clay and sand, in which there is almost no trace of lime; but the presence of a notable proportion of carbonate of lime is essential to marls, properly so called. This proportion varies from 6 to 20 per cent. Marly soils are in general of great natural fertility. Marl is very advantageously used as a manure, acting both chemically and mechanically; but different kinds of marl are of very different value in this respect. The use of marl as a manure has been known from ancient times. An English statute of 1225 (10 Henry III.) gave every man a right to sink a marl-pit on his own ground, and there is other evidence that the application of marl to land was common in England in the 13th century. Old marl-pits are very common in some parts of England. The quicker action and greater efficiency of lime have led to its use in many cases instead of marl, although some kinds of marl are extremely useful in some soils. The bulkiness of marl confines its use to the neighbourhood in which it is found.—Marl is sometimes indurated into a rock, and a slaty variety, containing much bitumen (*Bituminous Marl-slate*), is found in Germany and other countries.

MARLBOROUGH, an old and interesting town of England, Wiltshire, is a municipal and parliamentary borough, pleasantly situated in the valley of the Kennet, 75 miles west-south-west of London. It consists principally of one street, of picturesque houses. The chief edifice is the 'college,' a handsome building, occupying the site of the old castle. As early as the days of *Cœur-de-Lion*, there was a castle at M.; and a parliament, whose enactments were called the 'Statutes of Marlbridge,' was held here in the reign of Henry III. In the beginning of the 18th c., the castle was the residence of the Earl and Countess of Hertford, who occasionally entertained Thomson and Pope, and other men of letters here. The college was incorporated in 1845; the pupils are about 300 in number. M. was formerly an important posting-station between London and Bath and Bristol. It still carries on a trade in coal, corn, and malt. Population (1861) of parliamentary borough, which returns two members to the House of Commons, 4893.

MARLBOROUGH, JOHN CHURCHILL, DUKE OF, the greatest general and statesman of his time, was born 24th June 1650, at Ashe, in Devonshire, of an old family impoverished by the civil wars. Without having received much education, he became a page in the service of the Duke of York, who gave him a commission as an ensign of Guards in his 16th year. He was present at the relief of Tangiers, and a number of engagements with the Moors, and after his return to England, rose to the rank of captain in a regiment which was sent to the Netherlands to the support of the French. In the campaign from 1672 to 1677, his brilliant courage and ability gained him the praise of the celebrated Turenne. On the conclusion of the war by the peace of Nimeguen, Churchill, now a colonel, returned to England. His advancement had been obtained, not merely on account of his own merit, but through the influence

of his sister, Arabella, mistress of the Duke of York. His prosperity was afterwards still further secured by his marriage with Sarah Jennings, a lady as remarkable for her talents and imperious disposition as for her beauty. When James II. ascended the throne, Churchill was made Baron of Sundridge, and was raised to the military rank of general. He took an active part in suppressing Monmouth's rebellion, but on the landing of the Prince of Orange, he passed over to the side of the invader very unscrupulously. He was rewarded by being made Earl of Marlborough. He aided in reducing Ireland to subjection; and having received from William III. the command of the troops employed against France in the Netherlands, displayed great ability as a general in the campaigns of 1690 and 1691, and gained a great victory at Walcourt. But, entering into a treasonable correspondence with the Jacobites, he was, on his return to England, suddenly arrested and thrown into the Tower. On the commencement of the War of the Spanish Succession, he was intrusted with the command of the British army in the Netherlands. The death of William, and the accession of Anne to the throne in March 1702, made M. virtually regent, although without the title. His wife governed the queen, and he himself directed the minister Godolphin, who had married his daughter. A constant succession of victories strengthened his political power. In the campaign of 1702, he drove the French out of Spanish Guelders, in reward for which service the queen raised him to the rank of duke; in 1703, he went to the support of the Emperor in Germany, and joined Prince Eugene of Savoy; in June 1704, he stormed the French and Bavarian lines at Donauwörth, and on 13th August overthrew the French in the memorable and decisive battle of Blenheim. The parliament bestowed on him the estate of Woodstock, and the queen caused Blenheim Palace to be built for him. During the year 1705, M. was chiefly occupied with diplomatic negotiations; but in 1706 he resumed that career of victory by which Louis XIV. was so completely humbled. In May of that year, the battle of Ramillies was fought, which compelled the French to evacuate the whole of Spanish Flanders. In the summer of 1708, an attempt made by the French, under Vendome, to recover Flanders, brought on an engagement at Oudenarde, July 11, which resulted in the total defeat of the French. On 11th September 1709, he fought the bloody and unprofitable battle of Malplaquet; in 1710, his final campaign, he took from the French town after town, sometimes in the very sight of a superior French army. Meanwhile, however, important events took place at the British court: the queen shook off the tyranny of the Duchess of Marlborough, which had become intolerable to her; Godolphin and Sunderland ceased to be ministers, and the Earl of Oxford and the Tories came into power. M. returned to London in May 1711. He was accused of having embezzled the public money, and on 1st January 1712 he was deprived of his offices, but the charge against him was not prosecuted. On the accession of George I., he was treated with distinction, and made Commander-in-chief of the Forces. But on 8th June 1716, he had a stroke of apoplexy, which reduced him to a state of imbecility. He lingered in this state till 17th June 1722, when he died. He left an immense fortune.

Macaulay and Thackeray have united in painting M. as a cold-blooded, scheming traitor; and although general opinion has not yet endorsed the extreme views of these writers, there is too much evidence that he thought more of his own interest than of any cause in which he was engaged.

His wife, SARAH JENNINGS, was born on 29th May

1660, and when about 12 years of age came into the service of the Duchess of York, and became the chosen and most intimate friend of the Princess Anne, over whom, after her accession to the throne, she exercised the influence due to a superior and extremely active mind. Her power was almost boundless, the Whig ministry depended upon her support, and she disposed of places and offices at her pleasure, and is even said to have accumulated money by the sale of them. Her rule was, however, by no means gentle, and became at last intolerable to the queen, in whose favour her own cousin, Lady Masham, whom she had herself brought to court, supplanted her. She retired from the court in January 1711, and at the same time a change of ministry took place. She long survived her husband, living in complete retirement, and died on 29th October 1744, leaving a fortune of £3,000,000 sterling.—The only son of the Duke and Duchess of Marlborough died young, and the title has been inherited by the descendants of one of their daughters.

MARLINE-SPIKE, a ponderous iron pin, with a large head and taper point, used on shipboard for separating the strands of rope preparatory to splicing or knotting; also employed as a lever in tightening rigging, &c.

MARLOW, GREAT. See **GREAT MARLOW.**

MARLOWE, CHRISTOPHER, familiarly *Kit*, an English dramatic writer, was born, it is supposed, in 1565. But little is known of the events of his life. He studied at Corpus Christi College, Cambridge, and took the degree of Master of Arts in 1587. After leaving the university, he came up to London, and wrote for the stage. His chief works are *Dr Faustus*, *Edward II.*, *Tamburlaine the Great*, and two cantos of *Hero and Leander*, a narrative poem which was afterwards completed by Chapman. He appears to have led a reckless life; and on the 1st June 1593, he perished in a tavern brawl, it is supposed by the hand of a jealous rival.

Of all the dramatic writers before Shakspeare, he was the greatest genius; indeed, his *Edward II.* may be considered a foreshadow of Shakspeare's historical dramas. His 'mighty line' has been the subject of much critical laudation. His imaginative force and splendour are at their best in *Faustus*; his delicacy and sweetness in *Hero and Leander*. An edition of his works, with a Life and a literary-historical Introduction, was published by Dyce in 1850.

MARMA LADE (Port. *marmelada*, from *marmelo*, a quince; which, again, is from Mid. Lat. *malomellum*, Gr. *melimelon*, honey-apple or sweet apple) is a semi-liquid preserve, made by boiling the pulp of thick rinded fruits, such as oranges, pine-apples, quinces, &c., with portions of the rind. The most common kind of marmalade is made from the bitter or Seville oranges, the common or sweet sorts being considered inferior for this purpose, though also occasionally used. The mode of preparing it is generally as follows: the rind is boiled by itself, and the white woolly coating on the interior being then removed, the rind is cut up into thin strips, and boiled along with the expressed juice of the pulp and a quantity of sugar equal in weight to the other ingredients. After the mixture has attained the proper consistence, it is treated in a similar manner to jam, jelly, and other preserves. A species of marmalade is commonly made in France from apricots, peaches, plums, pears, &c.

MARMANDE, an old town of France, in the department of Lot-et-Garonne, on the right bank of the Garonne, 50 miles above Bordeaux. An important general trade is carried on with Bordeaux,

with which M. is in daily communication by steam-boat. Pop. (1862) 5500, who manufacture hats, woollen stuffs, brandy, &c.

MARMONT, AUGUSTE FRÉDÉRIC LOUIS VIÈSSE DE, Duke of Ragusa and Marshal of France, was born 20th July 1774, at Châtillon-sur-Seine, entered the army at an early age, served as a brigadier-general in Egypt, returned with Bonaparte to France, supported him in the revolution of the 18th Brumaire, and afterwards continued in active military service. Having defended the Ragusan territory against the Russians and Montenegrins, he was made Duke of Ragusa. He joined the great army in 1809, the day before the battle of Wagram, was intrusted with the pursuit of the enemy, won the battle of Znaym, and was made a marshal. He was thereafter for eighteen months governor of the Illyrian provinces; and in 1811 succeeded Massena in the chief command in Portugal, where he assumed the offensive, caused the siege of Badajoz to be raised, and kept Wellington in check for fifteen months. A wound compelled him to retire to France. In 1813, he commanded a *corps d'armée*, and fought at Lützen, Bautzen, and Dresden. He maintained the contest with great spirit in France in the beginning of 1814; and it was not until further resistance was hopeless, that he concluded a truce with Barclay de Tolly, on which Napoleon found himself compelled to abdicate. The Bourbons loaded M. with honours. On the return of Napoleon from Elba, he was obliged to flee. After the second restoration, he spent much of his time in agricultural pursuits, till the revolution of 1830, when, at the head of a body of troops, he endeavoured to reduce Paris to submission, and finally retreating with 6000 Swiss, and a few battalions that had continued faithful to Charles X., conducted him across the frontier. From that time, he resided chiefly in Vienna. In 1852, he engaged in an effort for the fusion of the French Legitimists and Orleanists, but died at Venice on 2d March of that year. He was the last survivor of the marshals of the first French Empire.

MARMONTEL, JEAN FRANÇOIS, an elegant French writer, born of an obscure family at Bort, in the Limousin, 11th July 1723. He studied for the church, but turned aside to literature, and after obtaining some reputation in Toulouse as a poet, he went to Paris on an invitation from Voltaire in 1746. Here he wrote tragedies and operas without any great success, but was fortunate enough to get a secretaryship at Versailles, through the influence of Madame Pompadour, in 1753. Afterwards, he received a more lucrative appointment, the *Mercure* being intrusted to his charge. His *Contes Moraux* (2 vols. Par. 1761), part of which originally appeared in the *Mercure*, have been translated into many languages, but are in some measure liable to the charge of monotony. He wrote other works, the most celebrated of which is his *Bélisaire*, a political romance, containing a chapter on *toleration*, which excited the most furious hostility on the part of the doctors of the Sorbonne. The book was condemned as 'heretical and blasphemous.' The clergy declaimed against it from the pulpits; the city was in a ferment; even the wise Turgot was borne away by the current. Pamphlets, epigrams, caricatures appeared in great numbers. There was a dead set to between the philosophers and wits on the one hand, and the theologians on the other; but the latter were defeated, and M. was named historiographer of France. In 1787, appeared his *Éléments de Littérature*, consisting of his contributions to the *Encyclopédie*, in which he had charge of the departments of poetry and general literature. It is really

his best book, and the one on which his reputation most securely rests. After the Revolution, he retired to the village of Ablouville, near Evreux, where he died, 31st December 1799. An edition of his *Œuvres Complètes* was published by himself in 17 vols.; another, 18 vols. (Par. 1818); a third, 7 vols. (Par. 1819—1820).

MARMORA, THE SEA OF, the *Propontis* of the ancients, a small sea between European and Asiatic Turkey, communicating with the *Ægean Sea* by the Strait of the Dardanelles (anciently *Hellespont*), and with the Black Sea by the Strait of Constantinople (anciently *Bosporus*). It is of an oval form, and about 135 miles in length by 45 in breadth, but has besides a large gulf, the Gulf of Ismikmid or Ismid, which extends about 30 miles eastwards into Asia. The depth is great. There is a current from the Bosphorus through it and the Hellespont to the Archipelago; but its navigation is by no means difficult. It contains many islands, of which the largest is Marmora or Marmara, famous for its quarries of marble and alabaster. The scenery around the Sea of M. is soft and beautiful.

MARMOSET, a name often given to a number of small and beautiful species of American monkeys of the genera *Hapale* and *Jacchus*, also called *OUSTITI*, and sometimes also to species of the genus *Midas* of naturalists. They are all distinguished from the other American monkeys by the smaller number of their grinders, resembling in this the monkeys of the Old World, also by the sharpness and crookedness of their nails. They depart from the true quadrumanous character in having the thumb not opposable. The tail is very long, and thickly covered with hair, but not prehensile. They exhibit a very affectionate disposition; but



Marmoset, or Striated Monkey (*Hapale Jacchus*).

unhappily all of them prove very delicate when removed from a warm climate. The name M. is sometimes restricted to the species also called the **STRIATED MONKEY**, or **STRIATED OUSTITI** (*Hapale Jacchus*, or *Jacchus vulgaris*), a native of Guiana and Brazil, a species often brought to Europe, and a favourite pet whenever it can be obtained. It is about seven or eight inches long, exclusive of the tail, which measures a foot. Its fur is long and soft, of a fine dark gray or reddish-yellow colour, banded with black; a long tuft of white hairs on each side of the black head.

MARMOT (*Arctomys*), a genus of rodents, usually ranked among the *Muridæ*, but regarded as forming a connecting link between that family

and *Sciuridæ*; resembling squirrels in their dentition, although in their form and habits they more resemble rats and mice. They have two incisors and two premolars in each jaw, four molars on each side above, and three below.—The **COMMON M.**, or **ALPINE M.** (*A. alpinus*), is a native of the Alps, the Pyrenees, and the more northern mountains of Europe, up to the limits of perpetual snow. It is not a native of Britain. It is about the size of a rabbit, grayish yellow, brown towards the head. It



Marmot (*Arctomys alpinus*).

feeds on roots, leaves, insects, &c. It is gregarious, and often lives in large societies. It digs large burrows with several chambers and two entrances, generally on the slopes of the mountains, where the marmots may be seen sporting and basking in the sunshine during the fine weather of summer. They spend the winter in their burrows, in one chamber of which is a store of dried grass; but the greater part of the winter is passed in torpidity. The Alpine M. is easily tamed.—The **QUEBEC M.** (*A. empetra*), found in Canada and the more northern parts of America, in woody districts, is a burrowing but not a gregarious animal.

MARNE, a river of France, the *Matrôna* of the ancients, the most considerable tributary of the Seine, on the right. It rises in the plateau of Langres, flows through the departments of Haute-Marne, Marne, Aisne, and Seine-et-Marne, in a course at first to the north-west, and then to the west, with many windings; passes Chaumont, Joinville, St Dizier, Vitry, Châlons, Epemay, Château-Thierry, and Meaux; and joins the Seine at Charanton, about four miles above Paris. Its length is about 205 miles, and it is navigable for 140 miles. It is rather a rapid stream, and in most places with a wide bed. The commerce carried on upon this river has been extended by means of canals, of which the most important is one completed in 1851, connecting it with the Rhine.

MARNE, an inland department in the north-east of France, formed out of the old province of Champagne, is traversed by the river Marne, and extends southward from the frontier department of Ardennes. Area, 2,021,488 English acres, of which 1,519,320 acres are cultivable, and 45,704 are in vineyards. Pop. (1861) 385,498. The soil is very fertile in the south, but chalky and arid in the north. It is in the dry and chalky soil of the north of this department where the best varieties of the famous Champagne Wine (q.v.) are grown. Of wines of all kinds, about 15,400,000 gallons are produced in this department annually. The rearing of a Spanish breed of sheep is a chief branch of industry, and woollen manufactures are largely carried on. The department is divided into the five arrondissements of Châlons-sur-Marne, Epemay, Reims, Sainte-Ménéhould, Vitry-le-François. Capital, Châlons-sur-Marne.

MARNE, HAUTE, an inland department in the north-east of France, south-east of the department of Marne. Area, 1,545,460; pop. (1861) 254,413. The surface is generally hilly, and is mountainous in the south and east. More than one-half of it is cultivable, and about one-third is in forests. The principal rivers are the Marne, with its tributaries, and the Meuse. About 13,000,000 gallons of wine of an ordinary quality are produced. The department is rich in iron ore; there are numerous furnaces, and the production of iron is the principal branch of industry. There are three *arrondissements* of Chaumont, Langres, and Vassy; capital, Chaumont-en-Bassigny.

MAROCCO. See **MOROCCO**.

MAROCCHETTI, BARON, CARLO, Chevalier of the Legion of Honour, an Italian sculptor of merit, born at Turin in 1805. Having completed his primary studies at the Lyceum Napoleon, he entered Bossio's study. On the completion of a tour through Italy, he took up his abode in France in 1827, and carried off a medal the same year for his beautiful statue of 'A Young Girl sporting with a Dog.' In 1831, he exhibited the 'Fallen Angel.' On the outbreak of the Paris revolution of 1848, M. repaired to London, where he continued to reside, having met with splendid encouragement both from the public and a host of royal and noble patrons. Among his best works are an equestrian statue of Emmanuel Philibert, executed gratuitously for the city of Turin; the tomb of Bellini, in Père la Chaise; the grand altar in the Madeleine at Paris; statues of the Emperor, the Duke of Orleans, and Queen Victoria; the colossal figure of Richard Cœur-de-Lion, exhibited at the portal of the Crystal Palace. His latest work is a memorial statue of Prince Albert at Aberdeen. He died in 1867.

MARONITES, a Christian tribe of Syria, of very ancient origin. Considerable controversy has arisen as to their primitive history: the most probable account represents them as descendants of a remnant of the **MONOTHELISTE** sect (q. v.), who, fleeing from the repressive measures of the Emperor Anastasius II., in the early part of the 8th c., settled on the slopes of the Lebanon, their chief seats being around the monastery of Maron; a saint of the 5th c., whose life is found in Theodoret's *Religious Histories* (iii. p. 1222). The emigrants are said to have elected as their chief and patriarch a monk of the same name, with the title of Patriarch of Antioch, and, throughout the political vicissitudes of the succeeding centuries, to have maintained themselves in a certain independence among the Moslem conquerors. In the 12th c., on the establishment of the Latin kingdom of Jerusalem, the M. abandoned their distinctive monothelite opinions, and recognised the authority of the Roman Church. Again, in the Council of Florence, 1445, they entered into a formal act of union with Rome. In 1584, a college was founded in Rome for the education of the Maronite clergy; and in 1736, they formally subscribed the decrees of the Council of Trent. Nevertheless, although united with Rome, they are permitted to retain their distinctive national rites and usages. They administer communion in both kinds; they use the ancient Syriac language in their liturgy; their clergy, if married before ordination, are permitted to retain their wives; and they have many festivals and saints not recognised in the Roman calendar. The M. at present are about 150,000 in number, distributed into 150 parishes. Their patriarch is still styled Patriarch of Antioch, and resides in the convent of Canobin on the Lebanon. He acknowledges the supremacy of the pope, and is bound to lay before him every tenth year a report of the state of his patriarchate. Under

him are 17 bishops, to whom are subject the officiating clergy of the 150 districts alluded to above. The revenues of all orders of ecclesiastics, however, are very narrow, and the inferior clergy live in great measure by the labour of their hands. Very many convents for both sexes are spread over the country, containing, in the whole, from 20,000 to 25,000 members, who all wear a distinctive costume, but follow the rule of St Anthony. The chief seat of the M. is the district called Kesrawan, on the western declivity of Mount Lebanon; but they are to be found scattered over the whole territory of the Lebanon, and in all the towns and larger villages towards the north in the direction of Aleppo, and southwards as far as Nazareth. Their political constitution is a kind of military republic, regulated for the most part by ancient usages and by unwritten, but well-recognised laws. Like the Arabs of Syria, they have a political hierarchy, partly hereditary, partly elective. The chief administration is vested in four superior sheiks, who possess a sort of patriarchal authority, and under these are subordinate chiefs, with whom, as in the feudal system, the people hold a military tenure. They retain even still a custom similar to that of the Sardinian *vendetta*, by which the kindred of the slain are bound to avenge his death. The relations of the M. with the Druses have been already detailed. See **DRUSES**. By an arrangement adopted since the recent sanguinary conflicts, both populations alike are subject to one governor, who is appointed by the Porte as governor of the Lebanon.

MAROO'NS, a name given in Jamaica and Dutch Guiana to runaway negro slaves. The term was first applied to those slaves who were deserted by their masters, the Spaniards, when the British conquered Jamaica (1655), and who took refuge in the uplands, where for 140 years they maintained a constant warfare with the British colonists; but in 1795 they were subdued, and a portion of them removed to Nova Scotia, and afterwards to Sierra Leone. The remnant fraternised with their manumitted brethren in 1834—1835. The M. of Dutch Guiana form a number of small independent communities.

MAROS-VASARHE'LY, a market-town of Austria, in Transylvania, in a fruitful district, on the Maros, 55 miles north-north-east of Hermanstadt. It contains a strong castle, a beautiful Gothic church (Reformed), and a public library of 60,000 volumes. Tobacco, wine, and fruit are extensively grown. Pop. 9127.

MAROZIA, a Roman lady of noble birth, but of infamous reputation in the scandalous chronicles of her age, daughter of the equally notorious Theodora, was born in the close of the 9th century. On the dissolution of all the moral ties of public and private life which the war of factions occasioned in Rome in the 10th c., M., by her beauty and her intrigues, contrived to exercise great influence. She was married three times, and, if we may credit the narrative of Luitprand, had skill and address enough to procure the deposition and death of the pope, John X., and the elevation of her son, the fruit, it is alleged, of adulterous intercourse, to the pontificate, under the name of John XI. This, however, rests on the testimony of Luitprand, who wrote some time after the period, and whose authority is considered more than doubtful, not merely by Muratori, but even by so critical and unbiassed a writer as Dr Pertz. M.'s latter years brought on her the punishment of her crimes. She died in prison at Rome in 938.

MARQUE, LETTERS OF. See **LETTERS OF MARQUE**.

MARQUE'SAS ISLES are, properly speaking, the southern group of the Mendaña Archipelago, in Polynesia, the northern group bearing the name of the Washington Islands; but the name is also applied to the whole archipelago. The M. I., in lat. 7° 30'—10° 30' S., long. 138°—140° 20' W., were discovered by Mendaña de Neyra, a Spanish navigator, in 1596; the Washington Isles were discovered in 1791 by Ingraham, an American. Area of the group as under the French protectorate, 500 English square miles; pop. 12,000. The M. I. were named after the viceroy of Peru, Marquesas de Mendoza. The islands are of volcanic origin, and are in general covered with mountains, rising in some cases to about 3500 feet above sea-level; the soil is rich and fertile, and the climate hot, but healthy. The coasts are difficult of access, on account of the surrounding reefs and the sudden changes of the wind. Cocoa-nut, bread-fruit, and papaw trees are grown, and bananas, plantains, and sugar-cane are cultivated. The inhabitants are of the same race as those of the Society and Sandwich Islands. They are well proportioned and handsome, but degraded in their religion and in many of their customs. On some of the islands, there are missionary stations; but although cannibalism has been abolished, the efforts of the missionaries have not otherwise met with much success. In 1842, the M. I. submitted to the French, and they are now governed by independent chiefs, under the protectorate of France.

MARQUETRY (Fr. *marqueterie*), the art of inlaying wood with wood of other colours, or with various other materials, as metal, ivory, shell, &c. The marquetry of Italy, especially that called Sorrento work, stands very high in artistic merit, and that of Wurtemberg is perhaps the cheapest made. Not only are all kinds of coloured woods used for producing the patterns in this kind of work, but artificial colours are given to poplar, willow, and other white woods, to increase the effect. The cabinet-makers of France, Belgium, and Germany are famous for the beautiful marquetry furniture they manufacture.

MARQUIS, or **MARQUESS**, the degree of nobility which in the peerage of England ranks next to duke. Marquises were originally commanders on the borders or frontiers of countries, or on the sea-coast, which they were bound to protect. In England, the title of marquis was used in this sense as early as the reign of Henry III., when there were marquises or lords-marchers of the borders of Scotland and Wales; and the foreign equivalent of *Markgraf* was common on the continent. But the marquise eventually became honorary, no specific duty being attached to it. The first English marquis in the modern sense was Robert de Vere, Earl of Oxford, who was created Marquis of Dublin by Richard II., to the no small offence of the earls who had to yield him precedence. In 1397, the same king made John Beaufort, Earl of Somerset, Marquis of Dorset, a title which was taken from him in the next reign. The House of Commons petitioned that his marquise should be restored, but he himself requested that it might not, being an innovation. No marquises are mentioned in England from this time for a century and a half. The oldest existing marquise is that of Winchester, created by Edward VI. in 1551. The title was first introduced into Scotland in 1599, when the Marquises of Huntly and Hamilton were created. After the Revolution, it became the practice to bestow a marquise as a second title in conferring a dukedom.

The coronet of a marquis, as worn in the United Kingdom, is a circle of gold, with four strawberry leaves (or oak leaves), and as many pearls alternating with them, and placed on pyramidal points of the same height with the leaves. The mantle is scarlet, with three and a half doublings of ermine. A marquis is styled 'The Most Honourable;' his wife is a marchioness; his eldest son takes by courtesy the next lower title in the peerage, except where that is identical with the title of the marquise, in which case he must take the next lower still, as in the case of the Marquis and Earl of Salisbury, whose eldest son bears the courtesy-title of Viscount Cranborne. The younger sons of a marquis are styled 'Lord,' and daughters 'Lady,' with the addition of Christian name and surname.



Marquis's Coronet.

MARRIAGE, the union of a man and woman in the legal relation of husband and wife. No two systems of laws are exactly agreed either as to the modes of constituting marriage, the rights which it confers, or the obligations which it imposes. It is one of the leading bases of law, and it is probable that around it laws first began to grow. In some places the old names for 'law' and 'marriage' are interchangeable, and everywhere the institution of marriage equally with that of laws had been ascribed to the first rulers. It accords, however, with historical inquiry and reasoning *à priori*, that they were not the invention of legislators, but growths from the experience and necessities of society, which could not advance far without rules for the appropriation of men and women to one another, securing them in the enjoyment of one another's society, and defining their obligations to their progeny. But while experience and necessity everywhere led to the institution of marriage, the forms of the institution were exceedingly various. The broadest differences between the institution in different localities are indicated by the words monogamy and polygamy, the latter including polygynia and polyandria. Monogamy, the rule among the most advanced nations, is the practice, on the whole, of mankind. Polygamy is *permissive* merely. It has been doubted whether pure polyandria—i. e., the system according to which a woman may have several husbands—exists; but the fact seems to be well established. Of old, the modes of getting a wife were the same with those of acquiring any other species of property—capture, gift, sale. The contract of sale may be said to be at the foundation of the marriage relation in every system of ancient law. When daughters belonged to fathers as goods, they were parted with only on the principles of fair exchange. Usually the contract was between the heads of families, the intending bride and bridegroom not being consulted. As to the marriage ceremonies, they then were those and no other which were necessary to complete and evidence a sale—delivery, on the price being paid, and 'the taking home.' It consisted with the growth of civility that the children should in time come to be consulted, and allowed to act on their likings. Now, among all civilised communities marriage is a civil contract between the parties themselves, constituted by their consent properly evidenced. The Church of Rome indeed regards it as a sacrament, and throughout Christendom marriage is usually attended by religious rites; but in the eye of the law, it is a simple civil contract, 'evidenced in words prescribed by law, or by law counted sufficient.' See **DIVORCE**; *Montesquieu's Spirit of Laws*; *Goquet's Origin of Laws*; and

Maine's Ancient Law. Subjoined are accounts of the modes of constituting marriage in England, Scotland, and Ireland.—For the legal effects of entering into marriage as regards the persons and property of the married parties, see HUSBAND AND WIFE.

England.—Marriage is considered in England as merely a civil contract, but the contract can be entered into only in certain ways, this restriction being intended to enforce some caution and deliberation in the parties, as well as to preserve evidence of the fact which may be easily accessible afterwards. Before stating what forms are necessary, it may be observed that as marriage is merely a contract between two persons, it follows that an action will lie for breach of a promise to marry at the instance of either party, and damages may be recovered accordingly. A promise to marry may be made either verbally or in writing; and in actions for breach of the promise it is for a jury to assess the damages which are appropriate to the relative situation and conduct of the parties, the usual evidence of the promise being acts of courtship, love-letters, and the observation of friends and acquaintances. The contract of marriage differs from other contracts in this, that it will not be set aside and treated as null merely because either party procured it by fraudulent representations. However much either party may have been deceived as to representations of the other's wealth, position, or prospects, the contract remains valid notwithstanding. Another particular in which the contract of marriage differs from other contracts is, that it cannot be rescinded by either party or both at pleasure, though that effect is brought about in another way by certain kinds of misconduct, whether studied or not, of either party. See DIVORCE, JUDICIAL SEPARATION. Another circumstance in which marriage differs from other contracts is, that it cannot be entered into in a moment, but certain preliminary notices must be given, and forms gone through. By the ancient common law of England, mere consent was enough to constitute marriage, as it is still in Scotland; but since Lord Hardwick's Act, in 1757, a ceremony in an established church was made necessary, and this continued till 1836, when the dissenters succeeded in removing this exclusiveness. Persons have now the option of two forms of contracting marriage: it may be with or without a religious ceremony; and if with a religious ceremony, it may be either in the established church, or in a dissenting chapel. If the marriage is to take place in an established church, then there must be either publication of bans of marriage for three preceding successive Sundays, or a licence or certificate obtained, which dispenses with such publication; and in either case, seven or fifteen days' previous residence in the parish by one of the parties is necessary, according as it is a certificate or licence respectively which is applied for. The marriage must take place in the church, the marriage service of the Church of England being read over, and this must be done in canonical hours—i. e., between 8 and 12 A. M., in presence of two witnesses. If the marriage is celebrated in a dissenting chapel (and for that purpose such chapel must be duly licensed and registered), there must be present the superintendent-registrar of the district as one of the witnesses, but the dissenting clergyman may use his own or any kind of form of service. If the marriage is not to be with any religious ceremony, then it must take place in the office of the superintendent-registrar, and in presence of witnesses, the essential thing being that both parties should in the presence of witnesses there exchange a declaration that they take

each other for man and wife. The canonical hours must be attended to in all cases, and the condition of previous residence by one of the parties in the district; but the condition of residence is often evaded. And in all cases the fact of the marriage must be entered in a register, which register is kept by a public officer, and ultimately filed and kept in Somerset House, London, where a copy of the certificate of registration of every marriage in England can at all times be had for a small sum. There is no fixed age at which parties are not allowed to marry, provided the male is above 14, and the female above 12; and though it is usual in England to say that an infant—that is, a person under 21 years of age—cannot marry without his or her guardian's consent, this is not correct, for infants can marry like other persons, without anybody's consent; the only consequence that can happen is, that they may incur penalties for perjury, and the property, if any, may be ordered by the Court of Chancery to be settled in a particular way, but the marriage nevertheless remains good. Though marriage thus consists essentially of forms as well as of free consent of parties, still, it may sometimes happen that persons go through the form of marriage, and yet are not married, owing to some illegality or fundamental condition being wanting; thus, a common instance of a form of marriage being utterly useless is where one of the parties is already married, the spouse being alive. In such case, it is quite immaterial whether the party so re-marrying is really ignorant, or affects to be so, that his or her spouse is alive, provided such is the fact; for though, after seven years, if nothing has been heard of one of two married parties being alive, the other will escape the penalties of bigamy on marrying again, yet it depends entirely on whether the first spouse is really dead at the time, whether the second marriage is valid. Another case in which parties may go through the form of marriage, is where the parties are too nearly related, as being within the forbidden degrees, as, for example, a man marrying his deceased wife's sister. See INCEST. Another instance of the marriage being void, though the ceremony is complete, is where one of the parties is impotent; for it is considered that an essential object of marriage is the procreation of children, and therefore, if this is impossible, the marriage is null. But it is entirely optional with the parties to treat the marriage as null on this head. If they are content, the marriage stands good; if not so, then the party must apply for a declaration of the Divorce Court, that the marriage never was valid, and is null, which decree is only granted on examination and evidence.

Scotland.—In Scotland, the law as to the constitution of marriage remains in the same state in which the law of England was before Lord Hardwick's Act, and in which the laws of several foreign countries also remain to this day. Marriage is not only entirely a civil contract, but it is allowed to be entered into with the same freedom as the contract of sale and other contracts which require nothing but mutual consent. The contract may be made by word of mouth, or by writing, and at a moment's notice, nothing in the nature of a preliminary notice, far less any form or ceremony, being requisite. As, however, many contracts are made, not in a direct and specific form, but circuitously and without any precise expression of consent either way, it is often a matter of difficulty afterwards, in case of dispute, to prove the fact, that a contract really was entered into at a given time. Accordingly, it is usual to divide marriages into three kinds, according as the mode of proof is of one description or another; and there is also a division of

MARSEILLAISE—MARSH-MALLOW.

well-cultivated district, and is a regularly built and pleasant town, with a college, a cathedral, a gymnasium, and several conventual establishments. It occupies the site of Lilybæum, the ancient capital of the Carthaginian settlements in Sicily, and was selected by Garibaldi as the landing-point of his volunteers in his famous Sicilian campaign, 1860. It obtained its present name from the Arabs, who, when they held Sicily, esteemed this part so highly that they called it *Marsa Alla*, 'Port of God.' Its harbour is encumbered with sand, but its celebrated wines form an export trade of great importance, chiefly since 1802, when they were adopted by Lord Nelson for the use of the British fleet. 30,000 pipes of M. wine, which resembles sherry, are annually manufactured, two-thirds being exported. M. has also a large export trade in grain, oil, salt, and soda.

MARSEILLAISE, the name by which the grand song of the first French Revolution is known. The circumstances which led to its composition are as follows. In the beginning of 1792, when a column of volunteers was about to leave Strasbourg, the mayor of the city, who gave a banquet on the occasion, asked an officer of artillery, named Rouget de Lisle, to compose a song in their honour. His request was complied with, and the result was the *Marseillaise*—both verse and music being the work of a single night! De Lisle entitled the piece *Chant de Guerre de l'Armée du Rhin*. Next day, it was sung with that rapturous enthusiasm that only Frenchmen can exhibit, and instead of 600 volunteers, 1000 marched out of Strasbourg. Soon from the whole army of the North resounded the thrilling and fiery words *Aux armes, Aux armes*; nevertheless, the song was still unknown at Paris, and was first introduced there by Barbaroux, when he summoned the youth of Marseille to the capital in July 1792. It was received with transports by the Parisians, who—ignorant of its real authorship—named it *Hymne des Marseillais*, which name it has ever since borne.

MARSEILLE, the first seaport of France and of the Mediterranean, in the department of Bouches-du-Rhône, is situated on the Gulf of Lyon, 410 miles in a direct line south-south-east of Paris, and in lat. 43° 17' N., long. 5° 22' E. M. is a military place of the fourth class, and is defended by a citadel and other works; the roads are protected by the fortified isles of If (crowned by a castle, once a state-prison), Pomègue, and Ratonneau. Its harbour is formed by an inlet of the sea running eastward into the heart of the city, and from its extent (nearly 70 acres), and its great natural and artificial advantages, it is capable of accommodating 1200 vessels. A new port, La Joliette, formed by a breakwater 1224 yards long, thrown out into the sea, running parallel to the shore, and at a distance of 1312 feet from it, has recently been constructed. A third, named after the emperor, is in process of construction. Immediately north of the harbour is the old town, with narrow streets, lined with high, closely piled houses. It contains the cathedral, a structure originally built out of the ruins of a heathen temple in the 4th century. Westward from the old town, and connected with it by a beautiful street, Le Cours, is situated the new town, elegantly built and laid out. Here the shops and houses rival in splendour the finest in Paris. Other fine streets are the *Cours Bonaparte* and the *Promenade de Tourette*. The site of the city is a valley surrounded by hills, the highest of which is Notre-Dame-de-la-Garde, with a fort and chapel, held in great veneration by the sailors of the Mediterranean. M. has schools of hydrography, medicine, drawing, and music; five

hospitals, an observatory, various learned societies, a large and admirable lazaretto, a town-house by Pugin, a public library of 60,000 vols., a cabinet of natural history, botanical gardens, and a picture-gallery. Of the manufactures, one of the chief is soap, which gives employment to 700 men. Ship-building and the allied employments of a seaport are carried on. Its commerce is chiefly with the Levant, Northern Africa, Italy, Spain, Holland, England, the Baltic, &c. It is connected with Paris by a railway, and is the steam-packet station for Italy, the Peninsula, and the East. In 1860, 8672 vessels, with cargoes of 2,026,678 tons, entered and cleared the port. M. is the third town of France in population, having (1861) 219,984 (including the whole commune and the military, the population was 260,910) inhabitants. During a portion of the year, the climate of M. is delightful, but in summer and autumn, the heat is often intense. Cold, dry, and cutting winds from the north-east render the climate at times exceedingly trying. In the environs of the town are about 9000 *Bastides*, or country villas.

M. was founded by a Greek colony from Phocæa, in Asia Minor, about 600 years B.C. Its ancient name was *Massalia*, written by the Romans *Masilis*. It was an important member of the ancient Greek community, planted numerous colonies along the North Mediterranean shores, and introduced the germs of Greek civilisation into Gaul. The Massaliots were long in intimate alliance with the Romans; but the city was at last taken by Julius Cæsar. In the 8th c., it was destroyed by the Arabs, and the maritime republics of Italy inherited the commerce of the Mediterranean, which formerly had been centred in Marseille. It was united, with the whole of Provence, to France in the reign of Charles VIII. In 1720, when it had again risen to great importance, it was ravaged by a fearful epidemic, and 40,000 of its inhabitants swept away. Since 1830, the commerce and industry of the city have increased vastly. The conquest of Algeria has brought increasing prosperity to M., and its North African trade is now an important part of its commerce.

MARSH, GEORGE PERKINS, LL.D., an American philologist, was born at Woodstock, Vermont, March 17, 1801; graduated at Dartmouth College, New Hampshire, 1820; studied law at Burlington, Vermont; was elected to the Supreme Executive Council of the state in 1835, and to Congress in 1842 and 1849. He was for several years afterwards United States minister resident at Constantinople, and in 1852 was charged with a special mission to Greece. He travelled in the north of Europe, and became an adept in the Scandinavian languages. Between 1857—1859 he served as railroad commissioner for Vermont. His most important works are a *Grammar of the Icelandic Language*; *Lectures on the English Language*; *The Camel, his Organisation and Uses*. His wife has been an able assistant in his literary and philological labours. In 1860, she published *Wolfe of the Knoll, and Other Poems* (New York).

MARSH-MALLOW (*Althæa*), a genus of plants of the natural order *Malvaceæ*, differing from the true mallows chiefly in the 6—9-cleft outer calyx. The species, which are not numerous, are annual and perennial plants, with showy flowers, natives of Europe and Asia. Only one, the COMMON M. (*A. officinalis*), is an undoubted native of Britain, and is common only in the south, growing in meadows and marshes, especially near the sea. It has a stem 2 to 3 feet high, entire or 3-lobed leaves, both leaves and stem densely clothed with soft,

MARSH-MARIGOLD—MARSHALLING OF ARMS.

starry down, and large, pale, rose-coloured flowers on short 3—4-flowered axillary stalks. Lozenges made from it (*Pâtes de Guimauve*) are in use. The whole plant is wholesome, and in seasons of scarcity, the inhabitants of some eastern countries



Marsh-Mallow (*Althaea officinalis*).

often have recourse to it as a principal article of food. It is said to be palatable when boiled, and afterwards fried with onions and butter. The Hollyhock (q. v.) is commonly referred to this genus.

MARSH-MARIGOLD (*Caltha*), a genus of plants of the natural order *Ranunculaceae*, having about 5 petal-like sepals, no petals, and the fruit consisting of several spreading, compressed, many-seeded follicles. *C. palustris* is a very common British



Marsh-Marigold (*Caltha palustris*).

plant, with kidney-shaped shining leaves, and large yellow flowers, a principal ornament of wet meadows and the sides of streams in spring. It partakes of the acidity common in the order; but the flower-buds, preserved in vinegar and salt, are said to be a good substitute for capers.

MARSHAL (Fr. *maréchal*, Teut. *mare*, horse, and *scalc* or *schalk*, servant), a term, in its origin, meaning a groom or manager of the horse, though eventually the king's marshal became one of the principal officers of state in England. The royal carrier rose in dignity with the increasing importance of the *chevalerie*, till he became, conjointly with the Constable (q. v.), the judge in the *Curia Martiales*,

or courts of chivalry. An earldom is attached to the dignity, and the office of earl-marshal is now hereditary in the family of the Duke of Norfolk. When the king headed his army in feudal times, the assembled troops were inspected by the constable and marshal, who fixed the spot for the encampment of each noble, and examined the number, arms, and condition of his retainers. With these duties was naturally combined the regulation of all matters connected with armorial bearings, standards, and ensigns. The constable's functions were virtually abolished in the time of Henry VIII, and the marshal became thenceforth the sole judge in questions of honour and arms. The earl-marshal is president of the English College of Arms, and appoints the kings-at-arms, heralds, and pursuivants. The marshal's functions were formerly exercised in time of peace in the *Aula Regis* or King's Great Court, and on the division of the *Aula Regis*, he appointed deputies in the new courts; hence arose the offices of Marshal of the King's (Queen's) Bench and of Exchequer, whose principal duty is to take charge of persons committed to their custody by the court. Besides the earl-marshal, there is a knight-marshal, or marshal of the king's (queen's) household. The Marshal of the King's Bench held two different courts, which have been altogether discontinued since 1849. The marshal or provost-marshal of the Admiralty is an officer whose duty it is to act ministerially under the orders of the Court of Admiralty in securing prizes, executing warrants, arresting criminals, and attending their execution.

The dignity of marshal existed formerly in Scotland, where a different orthography was adopted, and the office of marischal was hereditary in the family of Keith. Sir Robert Keith, the marischal, was one of the most distinguished warriors in the army of Robert the Bruce; and his descendant, the marischal, in 1456, had the dignity of earl conferred on him with no other title but that of Earl Marischal. There is little doubt that the lyon king-at-arms was like the English kings-at-arms, originally subject to the marischal, but his dependance ceased at a very early period, and the heraldic functions discharged by the earl-marshal in England devolved in Scotland on the lord Lyon, who held office directly from the crown. Scotland had no knight-marischal till 1633, when Charles I., at his coronation, created the office. In 1716, George, tenth Earl Marischal, was attainted in consequence of his share in the rebellion of the previous year, and the office has since been in abeyance. In France, the highest military officer is called a marshal, a dignity which originated early in the 13th century. There was at first only one *Maréchal de France*, and there were but two till the time of Francis I. Their number afterwards became unlimited. Originally, the marshal was the esquire of the king, and commanded the vanguard in war; in later times, the command became supreme, and the rank of the highest military importance. From the title of this class of general officers, the Germans have borrowed their *Feld-marschall*, and we our *Field-marshal*, a dignity bestowed on commanders distinguished either by elevated rank or superior talents.

MARSHALLING OF ARMS is the combining of different coats-of-arms in one escutcheon, for the purpose of indicating family alliance or office. In the earlier heraldry, it was not the practice to exhibit more than one coat in a shield, but the arms of husband and wife were sometimes placed *accollée*, or side by side, in separate escutcheons; or the principal shield was surrounded by smaller ones, containing the arms of maternal ancestors; and we not unfrequently find maternal descent or marriage

indicated by the addition of some bearing from the wife's or mother's shield. Then followed *dimidiation*, where the shield was parted per pale, and the two coats placed side by side, half of each being shewn. By the more modern custom of impaling (fig. 1), the whole of each coat is exhibited, a reminiscence of the older practice being retained in the omission of bordures, orles, and tressures on the side bounded by the line of impalement. The most common case of impalement is where the coats of husband and wife are conjoined, the husband's arms occupying the dexter side of the shield, or place of honour, and the wife's, the sinister side. Bishops, deans, heads of colleges, and kings-of-arms, impale their arms of office with their family coat, giving the dexter side to the former.

A man who marries an heiress (in heraldic sense) is entitled to place her arms on a small shield called

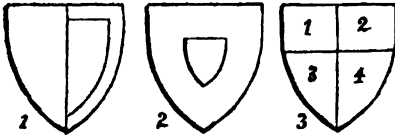

Marshalling of Arms.

an *escutcheon of pretence*, in the centre of his achievement, instead of impaling, as in fig. 2.

Quartering (fig. 3), or the exhibiting different coats on a shield divided at once perpendicularly and horizontally, is the most common mode of marshalling arms, a practice which, however, was unknown till the middle of the 14th century. The divisions of the shield are called quarters, and are numbered horizontally, beginning at the dexter chief. The most common object of quartering is to indicate descent. The coats quartered in an escutcheon must all have been brought in by successive heiresses, who have intermarried into the family. In the case of a single quartering, the paternal arms are placed in the first and fourth quarters, and the maternal in the second and third. The third and fourth quarters may, in after-generations, be occupied by the arms of a second and third heiress. Sometimes an already quartered coat is placed in one of the four quarters of the escutcheon, then termed a grand quarter. We occasionally find the shield divided by perpendicular and horizontal lines into six, nine, or even more parts, each occupied by a coat brought in by an heiress; and in case of an odd number of coats, the last division is filled by a repetition of the first. In the course of generations, a shield may thus be inconveniently crowded by the accumulation of coats, including the several coats to which each heiress may, in a similar way, have become entitled, and in Germany, sometimes twenty or thirty coats are found marshalled in one escutcheon; but in British heraldry, families entitled to a number of quarterings, generally select some of the most important. Quarterings, at least in Scotland, are not allowed to be added to the paternal coat without the sanction of the heraldic authorities.

Sovereigns quarter the ensigns of their several states, giving precedence to the most ancient, unless it be inferior to the others in importance. In the royal escutcheon of the United Kingdom, England is placed in the first and fourth quarters, Scotland in the second, and Ireland in the third; the relative positions of Scotland and England being, however, reversed on the official seals of Scotland. Spain bears the arms of Leon in the first and fourth quarters, and Castile in the second and third. An elected king generally places his arms surtout on an escutcheon of pretence.

MARSH'S TEST. See ARSENIC.

MARSICO NUOVO, a town in the Neapolitan province of Basilicata, 18 miles south of Potenza, built on a height, and exposed to violent winds. Pop. 6355.

MARSILEA'CEÆ, or RHIZOCARPEÆ, a natural order of Acotyledonous plants, nearly allied to *Lycopodiaceæ*, but differing in the want of a stem, and in the usually stalked leaves. The species are all inhabitants of ditches and pools, chiefly in temperate regions, and two of them occur in various parts of Great Britain. No species was known to be of any importance till the discovery of the Nardoo (q. v.) of Australia.

MARSUPIALIA, or MARSUPIATA, an extensive order or group of mammals, differing essentially from all others in their organisation, and especially in their generative system. The animals of this aberrant group originally received the name of *Animalia Crummata*, or Purse-bearing Animals; and the names now employed have a similar signification, being derived from *marsupium*, a pouch or bag. This marsupium, or pouch, which is situated on the abdomen of the female, contains the teats, and serves for the protection of the immature young; and is unquestionably the most marked characteristic of these animals. As the different genera of this order live upon various kinds of food—some being herbivorous, others insectivorous, and others, again, purely carnivorous—we find various modifications of their organs of progression, prehension, and digestion; but as the most important of these modifications are noticed in the articles on the principal genera, we shall confine ourselves to the characters common to the group.

The leading peculiarity presented by the skeleton is the presence of the marsupial bones (see MAMMALIA), which are attached to the pubis, and are imbedded in the abdominal muscles. Another constant but less striking peculiarity is a greater or less inversion of the angle of the lower jaw. The organs of digestion, including the teeth, vary extremely, according to the nature of the food; a complex stomach and a cæcum of considerable size being present in some, while others (the carnivorous genera) have a simple stomach and no cæcum. The brain is constructed on a simpler type than in the placental mammals. The size of the hemispheres (fig. 1, A) is so small that they leave exposed the olfactory ganglion (a), the cerebellum (C), and more or less of the optic lobes (B), and they are but partially connected together by the 'fornix' and 'anterior commissure,' the great cerebral commissure known as the 'corpus callosum' being absent. In accordance with this condition of the brain, these animals are all characterised by a low degree of intelligence, and are said (when in captivity) not to manifest any sign of recognition of their feeders. It is, however, in the organs of generation and mode of reproduction that these animals especially differ from all the ordinary mammals. Professor Owen, who has done more to elucidate this subject, and indeed the anatomy and physiology of marsupials generally, than any other anatomist, observes that in all the genera of this

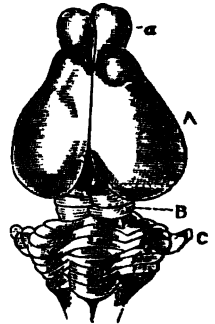

Fig. 1.
Brain of Opossum.

order the uterus is double, and the introductory passage more or less (sometimes wholly) separated into two lateral canals. Both the digestive and generative tubes terminate within a common Cloaca (q. v.), and there are various other points in which these animals manifest their affinity to the oviparous vertebrates. The marsupial bones serve important purposes in connection with their generative economy. 'In the female,' he observes, 'they assist in producing a compression of the Mammary gland



Fig. 2.

Outline of the Kangaroo about twelve hours after birth, shewing its natural size and external development at this period.

necessary for the alimentation of a peculiarly feeble offspring, and they defend the abdominal viscera from the pressure of the young as these increase in size during their marsupial existence, and still more when they return to the pouch for temporary shelter,' while in the males they are subservient to the reproductive process. The marsupials belong to the *aplacental* division of the *Mammalia* (q. v.). The period of their gestation is short (26 days in the Virginian opossum, and 39 days in the kangaroo), and the young are produced in so immature a state, that the earlier observers believed that they were produced like buds from the nipples to which they saw them attached. The appearance presented by a young kangaroo of one of the largest species, within twelve hours of its being deposited in the pouch, is described by Professor Owen (from personal observation in the Zoological Gardens) as follows: 'It resembled an earthworm in the colour and semi-transparency of its integument, adhered firmly to the point of the nipple, breathed strongly but slowly, and moved its fore-legs when disturbed. The body was bent upon the abdomen, its short tail tucked in between the hind-legs, which were one-third shorter than the fore-legs. The whole length from the nose to the end of the tail, when stretched out, did not exceed one inch and two lines.' The mother apparently employs her mouth in placing the young at the nipple, where it remains suspended, involuntarily absorbing milk for a considerable time (probably about two months on an average), after which, it sucks spontaneously for some months. Although able from the first, by the muscular power of its lips, to adhere firmly to the nipple, it does not possess the strength to obtain the milk by the ordinary process of sucking. In the process, it is assisted by the adaptation of a muscle to the mammary gland, which, by contracting, injects the milk from the nipple into the mouth of the adherent foetus; and to prevent the entrance of milk into the air-passage, the larynx is prolonged upwards to the aperture of the posterior nares, where it is closely embraced by the muscles of the soft palate. The air-passage is thus entirely separated from the throat, and the milk passes on either side of the larynx into the *œsophagus*.

Professor Owen has proposed that these animals should be divided into five tribes or primary groups, viz., *Sarcophaga*, *Entomophaga*, *Carpophaga*, *Poephaga*, and *Rhizophaga*, according to the nature of their food. With the exception of one American and one Malayan genus, all known existing marsupials belong to Australia, Tasmania, and New Guinea.—For further details regarding this order, the reader is referred to Waterhouse's *Natural History of the Mammalia*, vol. i., and to Owen's article 'Marsupialia' in the *Cyclopaedia of Anatomy and Physiology*.

MARTABAN, the name of a small town, in a province of that name, in British Burmah, on the banks of the river of the same name, and near its mouth in the Gulf of M., in lat. 16° 32' N., long. 97° 35' E., was the first that fell into the hands of the British in the Burmese war in 1852.

MARTEL, CHARLES. See CHARLES MARTEL.

MARTELLO TOWERS are round towers for coast defence, about 40 feet high, built most solidly, and situated on the beach. They occur in several places round the coast of the United Kingdom; but principally opposite to the French coast, along the southern shore of Kent and Sussex, where, for many miles, they are within easy range of each other. They were mostly erected during the French war, as a defence against invasion. Each had walls of 5½ feet thickness, and was supposed to be bomb-proof. The base formed the magazine; above were two rooms for the garrison, and over the upper of these the flat roof, with a 4½-foot brick parapet all round. On this roof a swivel heavy gun was to be placed to command shipping, while howitzers on each side were to form a flanking defence in connection with the neighbouring towers. Although the cost of these little forts was very great, they are generally considered to have been a failure; their armaments have mostly been removed, and their garrisons of six to twelve pensioner-soldiers replaced by coast-guard men, or in some cases by old master-gunners.

The name is said to be taken from Italian towers built near the sea, during the period when piracy was common in the Mediterranean, for the purpose of keeping watch and giving warning if a pirate-ship was seen approaching. This warning was given by striking on a bell with a hammer (Ital. *martello*), and hence these towers were called *Torri da Martello*.

MARTEN (*Martes*), a genus of digitigrade carnivorous quadrupeds of the family *Mustelidae*, differing from weasels in having an additional false molar on each side above and below, a small tubercle on the inner side of the lower carnivorous cheek-teeth, and the tongue not rough—characters which are regarded as indicating a somewhat less extreme carnivorous propensity. The body is elongated and supple, as in weasels, the legs short, and the toes separate, with sharp long claws. The ears are larger than in weasels, and the tail is bushy. The martens exhibit great agility and gracefulness in their movements, and are very expert in climbing trees, among which they generally live. Two species are natives of Britain, the COMMON M., BEECH M., or STONE M. (*M. foina*), and the PINE M. (*M. adietum*), inhabiting chiefly the more rocky and wooded parts of the island; the former in the south, and the latter in the north. Both were once much more common than they now are, being sought after on account of their fur, and killed on every opportunity, because of their excessive depredations among game and in poultry-yards. The head and body are about 18 inches long, the tail nearly 10 inches. Both species are of a dark tawny colour, the Common M. having a white throat, and the Pine M. a yellow throat. Many naturalists regard them as varieties of one species, of which also they reckon the Sable (q. v.) to be another variety. The fur of the martens is of two sorts: an inner fur, short, soft, and copious, and long outer hair, from which the whole fur derives its colour. The Common M. is much less valuable for its fur than the Pine M., whilst the Pine M. is much less valuable than the sable; but skins of the Common M. are imported in great numbers from the north of Europe, and they are often dyed, and sold as an inferior kind of sable.

MARTHA'S VINEYARD—MARTIAL LAW.

Pine M. skins are imported from the north of Europe, Siberia, and North America.—The martens generally have their retreats in the hollow trunks



1, Common Marten (*Martes foina*); 2, Pine Marten (*Martes abietum*).

of trees, or usurp the nest of a magpie or other bird, but sometimes among rocks. They are capable of a certain amount of domestication.

MARTHA'S VINEYARD, an island on the southern coast of Massachusetts, 21 miles long and 6 miles in average width; it has 3 towns, the largest of which is Edgartown, settled in 1642 by emigrants from Southampton, England. Pop. of island, 4401.

MARTIAL (MARCUS VALERIUS MARTIALIS), the first of epigrammatists, was born at Bilbilis, in Spain, 43 A.D. In 66, he came to Rome, where he resided till 100, when he returned to his native town. There he married a lady called Marcella, on whose property he lived till his death (about 104). When at Rome, he soon became famous as a wit and poet; received the patronage of the Emperors Titus and Domitian, and obtained from them the privileges of those who were fathers of three children, and, in addition, the rank of tribune, and the rights of the equestrian order. He lived, seemingly, in affluence, in a mansion in the city, and in Nomentum, a suburban villa, to both of which he makes frequent reference. From Rome, his reputation rapidly extended to the provinces; and even in Britain his *Epigrammata*, which, divided into 14 books, now form his extant works, were familiarly read. These books, which were arranged by himself for publication, were written in the following order: the first eleven (including the *Liber de Spectaculis*) were composed at Rome, with the exception of the third, which was written during a tour in Gallia Togata; the 12th was written at Bilbilis; and the 13th and 14th at Rome, under Domitian. The last two, entitled *Xenia* and *Apophoreta*, describe, in distichs, the various kinds of *souvenirs* presented by the Romans to each

other on holidays. To the other books, we are also indebted for much of our knowledge of the manners and customs which prevailed under the Emperors Nero, Galba, Otho, Vespasian, Titus, Domitian, Nerva, and Trajan, under whose collective reigns he spent 35 years of his life. His works have also a great literary value, as embodying the first specimens of what we now understand by epigram—not a mere inscription, but a poem of two or more lines, containing the terms of an antithesis, which goes off with a repercussion at the close. The wonderful inventiveness and facility displayed by M. in this species of composition have always received the highest admiration, only qualified by his disgusting grossness, which, blame-worthy in him, was even more so in the age by which it was demanded and relished. The best edition of M. is that of Schneidewin. He has never found an adequate translator.

MARTIAL LAW is a collective name for those laws to which the individuals composing the military and naval forces of a country are subject, but which do not apply to civilians. As, however, the soldier remains a citizen, he is governed by the common law in all matters not coming under the cognizance of the martial law, the degree to which the latter is applicable to his actions varying in different countries, and in times of peace and war. In France and Austria, a soldier's offences against the civil code are dealt with by a court-martial; while among British troops—unless serving against an enemy—the civil tribunals deal with non-military offences.

The maintenance of discipline and other obvious causes necessitate, for a body of armed men, a code of laws and regulations much more strict and severe in their penalties, as well as more prompt in their execution, than suffices for ordinary society. Accordingly there have always been martial laws, more or less clearly defined, where there have been armies. For the nature of the rules under which the discipline of the British army is kept up, see **ARTICLES OF WAR and MUTINY ACT**.

There is yet another phase of martial law, and that is the degree of severity which may be applied to an enemy. All authorities agree that the life of an enemy taken in arms is forfeit to his captor; but modern ideas preclude his being put to death, unless in open resistance; and the massacre of prisoners in cold blood, once thought lightly of, is now esteemed a barbarity, which nothing but the most urgent circumstances, such as their uprising, or their attempted rescue by their countrymen, could justify. The slaughter of the captive Mamelukes at Jaffa has left an indelible stain on Napoleon's memory. As regards civil population and property, much amelioration has taken place with advancing civilisation. Formerly, the devastation of the country, and the destruction, accompanied even by torture, of the inhabitants, was deemed a legitimate feature of war. Now, the rule is to spare private property, to respect personal liberty, unless the inhabitants directly or indirectly aid the enemy, and only to lay waste so much ground as military necessities may require. Such at least is the principle professed; but few commanders are able to prevent their troops from deeds of violence. A province occupied by a hostile army is usually considered 'under martial law.' This means that civil law is defunct, and all government under military regimen; but it is impossible to define the bounds of this martial law; nor is any more correct dictum on the subject likely to be arrived at than that celebrated saying of the Duke of Wellington when he described it as 'the will of the commander-in-chief.'

MARTIGNY, or **MARTINACH** (the *Octodurus* of the Romans), a small town of Switzerland, in the canton of Valais, is situated on the Drance, an affluent of the Rhone, about 24 miles south-south-east from the east end of the Lake of Geneva. The two noted routes, one to the vale of Chamouni by the Tête Noire or the Col de Balme, and another to the Great St Bernard, branch off here. M. is on the Simplon road into Italy. It is a great resort for tourists, and has a population of about 1200.

MARTIGUES, a small town of France, in the department of Bouches du Rhone, is situated on three islands, united by bridges, in the entrance to the Etang de Berre, 16 miles north-west of Marseille. From the peculiarity of its position, it has been called the Provençal Venice. Pop. 8500, who are engaged in the tunny and pilchard fisheries.

MARTIN. See SWALLOW.

MARTIN, Bishop of Tours, and a saint of the Roman Catholic Church, was born in Pannonia about the year 316. He was educated at Pavia, and at the desire of his father, who was a military tribune, entered the army, first under Constantine, and afterwards under Julian the Apostate. The virtues of his life as a soldier are the theme of more than one interesting legend. On obtaining his discharge from military service, M. became a disciple of Hilary, Bishop of Poitiers (q. v.). He returned to his native Pannonia, and converted his mother to Christianity, but he himself endured much persecution from the Arian party, who were at that time dominant; and in consequence of the firmness of his profession of orthodoxy, he is the first who, without suffering death for the truth, has been honoured in the Latin Church as a confessor of the faith. On his return to Gaul, about 360, he founded a convent of monks near Poitiers, where he himself led a life of great austerity and seclusion; but in 371 he was drawn by force from his retreat, and ordained Bishop of Tours. The fame of his sanctity, and his repute as a worker of miracles, attracted crowds of visitants from all parts of Gaul; and in order to avoid the distraction of their importunity, he established a monastery near Tours, in which he himself resided. His life by his contemporary, Sulpicius Severus, is a very curious specimen of the Christian literature of the age, and in the profusion of miraculous legends with which it abounds, might take its place among the lives of the mediæval or modern Roman Church. The only extant literary relic of M. is a short *Confession of Faith on the Holy Trinity*, which is published by Galland, vol. vii. 569. In the Roman Catholic Church, the festival of his birth is celebrated on the 11th November. In Scotland, this day still marks the winter-term, which is called *Martinmas* (the mass of St Martin). Formerly, people used to begin St Martin's Day with feasting and drinking; hence the French expressions *martiner* and *faire la St Martin*, 'to feast.'

MARTIN, the name of five popes, of whom the fourth and fifth deserve a brief notice.—**MARTIN IV.** (Nicholas de la Brie), a Frenchman, was elected in 1281. His name is best known in connection with the memorable tragedy of the 'Sicilian Vespers.' Having been from the time of his election a devoted adherent of Charles of Anjou, he supported that monarch with all his influence, and even by the spiritual censures which he had at his command, in his effort to maintain French domination in Sicily; and it is to his use of the censures of the church in that cause that many Catholic historians ascribe the decline and ultimate extinction of the authority in temporals which the papacy had exercised under the distinguished pontiffs who

preceded him. He died at Perugia in 1285.—**MARTIN V.** must be noticed as the pontiff in whose election was finally extinguished the great WESTERN SCHISM (q. v.). He was originally named Otho Colonna, of the great Roman family of that name. On the deposition of John XXIII., and the two rival popes Gregory XII. and Benedict XIII., in the council of Constance, Cardinal Colonna was elected. He presided in all the subsequent sessions of the council, and the Fathers having separated without discussing the questions of reform, at that period earnestly called for in the church, Martin undertook to call a new council for the purpose. The council was summoned accordingly, after several years, to meet at Siena, and ultimately assembled at Basel in 1431. Martin died in the same year.

MARTIN, JOHN, an English painter, was born in the neighbourhood of Hexham, Northumberland, 19th July 1789, went to London in 1806, and—after some years spent in obscure struggles—made his first appearance as an exhibitor at the Royal Academy in 1812. His picture was entitled 'Sadak in Search of the Waters of Oblivion,' and attracted much notice. It was followed within two years by the 'Expulsion from Paradise,' 'Clytée,' and 'Joshua commanding the Sun to stand Still.' The last of these works was a great success in point of popularity, but it was also the cause of a quarrel between M. and the Academy, in consequence of which he never obtained any distinction from the society. From this period till nearly the close of his life, he incessantly painted pictures in a style which was considered 'sublime,' by the same sort of people who thought Montgomery's *Satan* and Pollok's *Course of Time equal to Paradise Lost*. The principal of these 'sublime' productions are 'Belshazzar's Feast' (1821); 'Creation' (1824); 'The Deluge' (1826); 'The Fall of Nineveh' (1828); 'Pandemonium' (1841); 'Morning' and 'Evening' (1844); 'The Last Man' (1850). M. died at Douglas, Isle of Man, February 9, 1854.

MARTIN, Sr., one of the Lesser Antilles, lies in 18° 4' N. lat., and 63° 8' W. long. Area about 30 square miles. The northern part of St M. belongs to France, and the southern to the Netherlands. It is mountainous in the interior, indented with bays, and is about four square leagues in extent. There are salt marshes from which much salt is made; and sugar-canes, cotton, tobacco, maize, plantains, bananas, and other West India products are cultivated. In 1860, the Great Salt Pan produced 301,234 vats of salt, valued at £15,060 sterling. Population of the French part of the island about 3450; of the Netherlands part, 3157. The law for emancipating the slaves in the Netherland West Indies, which passed the States-general August 1862, came into operation July 1863.

MARTINA, a fine town of the Neapolitan province Terra di Otranto, situated on a hill 18 miles north-north-east of Taranto. Pop. 14,500. It is a rising industrious place, and has a fine palace of similar architecture to the great Roman palace Panfilii.

MARTINEAU, HARRIET, an English authoress, was born at Norwich 12th June 1802. Her education was conducted for the most part at home; from an early age she was a lover of books, and was wont to amuse her solitary hours by committing her thoughts to paper. Her father's affairs becoming embarrassed, she was compelled to procure her own livelihood; in the first instance, it is said, as a teacher of music, which profession she was compelled to relinquish from deafness, when she began to turn her attention to literature. If this be so,

it affords a remarkable example of the good gifts which necessity, the hard mother, has sometimes in store for her children. Had this lady remained in affluence, or unvisited by physical affliction, it is probable that England would have been without, if not its greatest, certainly its most remarkable female writer. The subjects upon which her pen has been exercised are of the most varied kind, including some—such as politics—which have rarely been before attempted by women. Her first volume, entitled *Devotions for Young People*, appeared in 1823; and was followed in 1824 by *Christmas Day*, a tale, and by *The Friend*, a sequel, the year after. In 1826, she published *Principle and Practice*, and *The Rioters*; and for two years thereafter she was busily engaged writing stories and a series of tracts on social matters, adapted mainly for the perusal of the working-classes. In 1830, she produced her *Traditions of Palestine*. During the same year, the Association of Unitarian Dissenters awarded her prizes for essays on the following subjects: *The Faith as unfolded by many Prophets*, *Providence as Manifested through Israel*, and *The Essential Faith of the Universal Church*. Her next important literary venture was unique, and in one of the softer sex almost audacious, *The Illustrations of Political Economy*, a series of tales, which met with great and deserved success, and was followed by others illustrative of *Taxation*, and *Poor-law and Paupers*. In 1835, she crossed the Atlantic, and published her *Society in America* in 1837. In 1839, she published *Deerbrook*, which was followed by *The Hour and the Man*. She afterwards produced a series of tales for the young, the best known of which are *Feats on the Fjord*, and *The Crofton Boys*. About 1839, and on till 1844, she was an invalid more or less, and during this period she wrote *Life in the Sick-room*. On her recovery she published *Forest and Game-law Tales*. In 1846, she visited Palestine, and collected materials for *Eastern Life, Past and Present*, which she published on her return. Afterwards, she completed Mr Knight's *History of England during the Thirty Years' Peace*—her best and most useful work, perhaps, on the whole. In 1851, in conjunction with Mr H. G. Atkinson, she published a series of *Letters on the Laws of Man's Social Nature and Development*, convulsing the literary coteries with the boldness of her speculations. The long catalogue of her literary labours may be closed by her translation of Comte's *Positive Philosophy*. While the foregoing works were in progress, M. was a constant contributor to the larger reviews, and the daily and weekly press. At present, she resides at Ambleside, writing when her state of health permits.

MARTINEAU, JAMES, brother of the preceding, was born in Norwich about 1807. He was educated for the ministry in connection with the Unitarian body of Christians, and was pastor of congregations in Dublin and Liverpool. He has been for many years Professor of Mental and Moral Philosophy in Manchester New College; and that institution having been removed to London, he resigned his pastoral charge in Liverpool in 1858, and transferred his residence to the metropolis, where he became joint-pastor of the Unitarian Church of Little Portland Street. He is understood to have been one of the projectors of the *National Review*, and has been a frequent contributor to its pages. This periodical may be taken as generally representing his theological views. M. is one of the most earnest and lofty of living religious writers. He is deeply read in German theology and philosophy, and is remarkable for strong grasp of thought and power of subtle analysis. He

is a master of English style, and in the power of giving form and substance to the most abstract thought, has seldom been surpassed. His principal works are the *Rationale of Religious Inquiry* (1836), *Endeavours after the Christian Life* (1843), *Miscellanies* (1852), and *Studies of Christianity* (1856).

MARTINIQUE, or MARTINICO, called by the natives MADIANA, one of the Lesser Antilles, is 40 miles long, about 12 miles broad, and has an area of about 380 square miles, and 137,455 inhabitants, of whom upwards of 87,000 are black. The island was discovered by the Spaniards in 1493, colonised by the French in 1635, and now belongs to that nation. It is of an oval form, with much indented coasts, and is everywhere mountainous; the highest peak, Mount Pelée, being considerably more than 4000 feet above sea-level. There are six extinct volcanoes on the island, one of them with an enormous crater. The cultivated portion of M. (about one-third of the whole) lies chiefly along the coast. The climate is moist, but, except during the rainy season, is not unhealthy, and the soil is very productive. Of the land in cultivation, about three-fifths are occupied with sugar-cane. The government of the island consists of a governor, a privy council of 7, and a colonial council of 30 members. Slavery was abolished in 1848. The island is liable to dreadful hurricanes. The capital is Fort Royal, but St Pierre (q. v.) is the largest town and the seat of commerce. Macouba, on the north coast, is famous for a particular kind of snuff.

MARTINMAS, in Scotland, is one of the four quarter-days for paying rent—viz., 11th November.

MARTIUS, CARL FRIEDRICH PHILIPP VON, one of the most distinguished of modern travellers and naturalists, born at Erlangen 1794. He studied medicine at Erlangen, and had published two botanical works, when he was induced to proceed to Brazil as a member of a scientific expedition sent out by the Austrian and Bavarian governments, and by his researches in that country acquired a reputation inferior perhaps to that of no scientific traveller except Humboldt. He was specially intrusted with the botanical department, but his researches extended to ethnography, statistics, geography, and natural science in general; and his works published after his return exhibit a poet's love of nature and great powers of description. These works are: *Reise nach Brasilien* (3 vols. Munich, 1824—1831); *Nova Genera et Species Plantarum* (3 vols. Munich, 1824—1832); and *Icones Plantarum Cryptogamicarum* (Munich, 1828—1834). He also published a most valuable monograph of palms, *Genera et Species Palmarum* (3 vols. Munich, 1823—1845). He is the author of a number of other botanical works, some of which are monographs of orders and genera; also of works relative to tropical America, as *Die Pflanzen und Thiere des tropischen Amerika* (Munich, 1831); *Das Naturell, die Krankheiten, das Arzthum und die Heilmittel der Urbewohner Brasiliens* (Munich, 1843); *Systema Materia Medica Vegetabilis Brasiliensis* (Leip. 1843). He has contributed largely to the *Flora Brasiliensis* (Stuttgart, 1829, &c.); and has written on the Potato Disease (Munich, 1842), &c., &c. He is Professor of Botany and Director of the Botanic Garden at Munich.

MARTLET, in Heraldry, a Martlet. a bird resembling a swallow, with long wings, very short beak and thighs, and no visible legs, given as a mark of cadency to the



Martlet.

fourth son. It is also otherwise used as a charge. The martlet was originally meant for the martin, and in the earliest heraldry, it is not deprived of its feet.

MARTOS, a town of Andalusia, Spain, 16 miles south-west of the city of Jaen, on a steep hill crowned by an old castle. It is resorted to for its mineral waters. Pop. stated at 11,000.

MARTYR (Gr. *martyr*, a witness), the name given in ecclesiastical history to those who, by their fearless profession of Christian truth, and especially by their fortitude in submitting to death itself rather than abandon their faith, bore the 'witness' of their blood to its superhuman origin. Of the same use of the word, there are some examples also in the New Testament, as in Acts xxii. 20, Apoc. ii. 13, and xvii. 6. But this meaning, as its technical and established signification, is derived mainly from ecclesiastical writers. During the Persecutions (q. v) of the Christians in the first three centuries, contemporary writers, as well pagan as Christian, record that many Christians preferring death to apostasy, became martyrs or witnesses in blood to the faith, often in circumstances of the utmost heroism. The courage and constancy of the sufferers won the highest admiration from the brethren. It was held a special privilege to receive the martyr's benediction, to kiss his chains, to visit him in prison, or to converse with him; and, as it was held that their great and superabundant merit might, in the eyes of the church, compensate for the laxity and weakness of less perfect brethren, a practice arose by which the martyrs gave to those sinners who were undergoing a course of public penance, letters of commendation to their bishop, in order that their course of penance might be shortened or suspended altogether. See **INDULGENCE**. The day of martyrdom, moreover, as being held to be the day of the martyrs' entering into eternal life, was called the 'natal' or 'birth' day, and as such was celebrated with peculiar honour, and with special religious services. Their bodies, clothes, books, and the other objects which they had possessed were honoured as **RELICS** (q. v.), and their tombs were visited for the purpose of asking their intercession. See **INVOCATION**. The number of martyrs who suffered death during the first ages of Christianity has been a subject of great controversy. The ecclesiastical writers, with the natural pride of partisanship, have, it can hardly be doubted, leaned to the side of exaggeration. Some of their statements are palpably excessive; and Gibbon, in his well-known 16th chapter, throws great doubt even on the most moderate of the computations of the church historians. But it is clearly though briefly shewn by Guizot in his notes on this celebrated chapter (see Milman's *Gibbon's Decline and Fall*, i. 598), that Gibbon's criticisms are founded on unfair and partial data, and that even the very authorities on which he relies demonstrate the fallaciousness of his conclusions. Those who are interested in the subject will find it discussed with much learning and considerable moderation in Ruinart's *Acta Primitiva et Sincera Martyrum*. Considerable difference of opinion also has existed as to what, in the exploration of the ancient Christian tombs in the Roman catacombs, are to be considered as signs of martyrdom. The chief signs, in the opinion of older critics, were (1), the letters B. M.; (2), the figure of a palm-tree; and (3), a phial with the remains of a red liquor believed to be blood. Each of these has in turn been the subject of dispute, but the last is commonly regarded as the conclusive sign of martyrdom. The first recorded martyr of Christi-

anity, called the 'proto-martyr,' was the deacon Stephen, whose death is recorded Acts vi. and vii. The proto-martyr of Britain was Alban of Verulam, who suffered under Diocletian in 286 or 303.

MARTYROLOGY, a calendar of martyrs and other saints arranged in the order of months and days, and intended partly to be read in the public services of the church, partly for the guidance of the devotion of the faithful towards the saints and martyrs. The use of the martyrology is common both to the Latin and to the Greek Church, in the latter of which it is called *Menologion* (from *Mēn*, a month), or 'month-calendar.' The earliest extant Greek martyrology or menology dates from the 9th century. It was published in 1727 by Cardinal Urbini. The oldest Latin martyrology is that attributed to St Jerome, published in the 11th volume of the collected edition of his works by Vallars; but the genuineness at least of some portions of it is more than doubtful. In the mediæval period, martyrologies were issued in England by Venerable Bede; in France by Florus, Ado, and Usuard; and in Germany by St Gall, Nolter, and Rabanus Maurus. The so-called 'Roman Martyrology' is designed for the entire church, and was published by authority of Gregory XIII., with a critical commentary by the celebrated Cardinal Baronius in 1586. A still more critical edition was issued by the learned Jesuit, Herebert Rosweid.

MARUT is, in Hindu Mythology, the god of wind; his wife is Anjana, and his son Hanumān (q. v.). Bhīma, the second of the Pān'du princes (see **MAHĀBHĀRATA**), is likewise considered as an offspring of this god.

MARVEL OF PERU. See **JALAP**.

MARVELL, ANDREW, an English writer and politician, was born 15th November 1620 at Hull, in Yorkshire, where his father was master of the grammar-school and lecturer of Trinity Church. He studied at Trinity College, Cambridge, and afterwards spent several years in various parts of the continent, 'to very good purpose,' according to Milton. He returned to England about 1653, and was employed by Oliver Cromwell as tutor to a Mr Dutton; in 1657, he became assistant-secretary to Milton; and in 1660, was chosen by his native town to represent it in parliament. M.'s parliamentary career was both singular and honourable. Without fortune or influence, possessing no commanding talent as a speaker, nor, indeed, brilliant intellectual qualities of any kind, he maintained a character for integrity, so genuine and high that his constituency felt itself honoured by his conduct, and allowed him to the end of his life 'a handsome pension.' Otherwise, it would have occasionally fared ill with this incorruptible patriot, for he was often reduced to great pecuniary straits. Charles II. made many but fruitless efforts to win him over to the court-party. The story of the interview between M. and the Lord Treasurer Danby, who had found out the patriot's lodgings (with difficulty) 'up two pair of stairs, in one of the little courts in the Strand,' is believed to be essentially true, and indicates a certain noble republican simplicity of nature, which cannot be too highly admired. M. died 16th August 1678, not without suspicion of poison. His writings, partly in verse, and partly in prose, are satirical, sharp, honest, and pithy (like his talk), but they relate to matters of temporary interest, and are now well-nigh forgotten. An edition of them was published, along with a life of the author, by Captain Edward Thompson, London, 1776.

MARY, THE BLESSED VIRGIN (Heb. *Miriam*, Gr. *Maria* or *Mariam*), called in the New Testament 'the mother of Jesus' (Matt. ii. 11, Acts i. 14), as the

mother of our Lord according to the flesh, is held in high honour by all Christians; and her intercession is invoked with a higher religious worship and a firmer confidence than that of all the other saints, not only in the Roman Church, but in all the Christian churches of the East—the Greek, the Syrian, the Coptic, the Abyssinian, and the Armenian. Of her personal history, but few particulars are recorded in Scripture. Some details are filled up from the works of the early Fathers, especially their commentaries or deductions from the scriptural narrative; some from the apocryphal writings of the first centuries, and some from mediæval or modern legends. The twofold genealogy of our Lord (Matt. i. 1–16, and Luke iii. 23–38) contains the only statement regarding the family of M. which the sacred writers have left. The genealogy of our Lord in St Matthew is traced through Joseph; and as it is plainly assumed that M. was of the same family with her husband Joseph, the evidence of the descent of the latter from David is equivalently an evidence of the origin of M. from the same royal house. But the genealogy of Christ as traced in St Luke is commonly held to be the proper genealogy of his mother in the flesh, Mary. Hence it is inferred that the Heli of this genealogy (Luke iii. 23) was the father of M.; and it may be added, in confirmation of this inference, that M. is called in the Talmud the 'daughter of Heli,' and that Epiphanius (Hor. lxxviii. n. 17) says her parents were Anna and 'Joachim,' a name interchanged in Scripture (as 2 Chron. xxxvi. 4) with Eliachim, of which name Eli or Heli is an abridgment. The incidents in her personal history recorded in Scripture are few in number, and almost entirely refer to her relations with our Lord. They will be found in Matt. i. ii. xii.; Luke i. ii.; John ii., xix.; and Acts i., where the last notice of her is of her 'persevering in prayer' with the disciples and the holy women at Jerusalem after our Lord's ascension (Acts i. 14). Beyond the few leading facts which will be found under these references, the Scripture is silent as to the life of M. during the presence of our Lord on earth; nor of her later life is there any record in the canonical Scriptures. The apocryphal gospels, entitled 'The Gospel of the Nativity of Mary,' and the 'Protovangeleon of the Birth of Christ,' contain some additional, but, of course, unauthentic particulars as to the lineage, birth, and early years of M.; among which is the miraculous story of her betrothal with Joseph, immortalised by the pencil of Raphael, according to which narrative Joseph was selected from among all who had been proposed as suitors for the hand of M. by the supernatural sign of a dove issuing from his rod and alighting upon his head. See Protovangeleon, cap. viii. As to her history after the ascension of her son, the traditions differ widely. A letter ascribed to the Council of Ephesus speaks of her as having lived with John at that city, where she died, and was buried. Another epistle, nearly contemporaneous, tells that she died and was buried at Jerusalem, at the foot of the Mount of Olives. Connected with this tradition is the incident which has so often formed a subject of sacred art, of the apostles coming to her tomb on the third day after her interment, and finding the tomb empty, but exhaling an 'exceeding sweet fragrance.' On this tradition is founded the belief of her having been assumed into heaven, which is celebrated in the festival of the Assumption. The date of her death is commonly fixed at the year of our Lord 63, or, according to another account, the year 48. Another tradition makes her survive the crucifixion only 11 years.

Many theological questions regarding the Virgin M. have been raised among Christians of the various

churches, which would be quite out of place here. One of these, which possesses present interest, has been treated under a separate head. See **IMMACULATE CONCEPTION**. The perpetual virginity of M. is not explicitly attested in Scripture, and there are even certain phrases which at first sight seem to imply that children were born of her after the birth of Jesus, as that of his being called (Matt. i. 25, Luke ii. 7) her 'firstborn son,' and that of James and others being more than once called 'brothers of the Lord.' On the latter argument, no critic acquainted with the wide scriptural use of the word 'brother' would ever rely. The former, which was urged anciently by Helvidius and others, but was rejected by the unanimous voice of tradition, is founded on a phrase susceptible of equal latitude of interpretation. The perpetual virginity of M. is held as a firm article of belief in the Roman and Eastern churches. Protestants hold nothing positively on the subject. The controversies regarding the Virgin M. have reference to the lawfulness of the worship which is rendered to her in some Christian communities. See **MARIOLATRY**.

MARY I., queen of England, daughter of Henry VIII by his first wife, Catharine of Aragon, was born at Greenwich on the 18th of February 1517. She was in her early years a great favourite with her father, who had her carefully educated after the masculine fashion of her time. Erasmus praises particularly the style of her Latin letters. At the age of seven, she was betrothed to the Emperor Charles V.; but when Henry sought a divorce from Queen Catharine, the Spanish monarch broke off the engagement. Her father then tried to marry her to Francis I. of France, but his design did not succeed. Francis, however, asked her for his second son, the Duke of Orleans, but Henry in turn refused. After the birth of Elizabeth, Henry's affections were diverted to that princess; and when James V. of Scotland sought the hand of M., it was refused, on the ground that the issue of such union might imperil the right of Anne Boleyn's children to the crown. This was virtually condemning M. to celibacy, and doubtless had the effect of making her still more attached to the Catholic party, to which, on account of her training, her natural tendencies, and the wrongs of her mother, she was already closely allied. Several other matrimonial negotiations, with the Prince of Portugal, the Duke of Cleves, and the Duke of Bavaria, also came to nothing. About this time, she was in great danger of losing her life, on account of her strong attachment to her mother's interests. Towards the close of Henry's reign, better prospects opened out for her; in 1544, she was restored to her place in the line of succession, of which she had been deprived, and she lived on very good terms with Catharine Parr, the last of her father's numerous wives. During the reign of her half-brother, Edward VI., she lived in retirement, but had three more offers of marriage—from the Duke of Brunswick, the Markgraf of Brandenburg, and the Infante of Portugal—none of which was accepted. On the death of Edward in 1553, she was proclaimed queen; and after a brief and imbecile struggle on the part of those who advocated the claims of Lady Jane Grey, was crowned in October of the same year by Stephen Gardiner, Bishop of Winchester. A fierce spirit in favour of the papacy soon began to shew itself, although it does not appear that M. herself was at first disposed to be severe; she even occasionally interfered to mitigate the cruelties of Gardiner and Bonner; but after her marriage with Philip of Spain (July 25, 1554), to whose father she had been betrothed many years before, a worse spirit took possession of her, or at least worse counsels

prevailed; and those bloody persecutions began which have given her an odious name in history. Her domestic life was wretched; Philip, whom she loved with a morbid passion, proved a sour, selfish, and heartless husband; at once a bigot and a brute. No children followed their union, and exasperation and loneliness working upon a temper naturally obstinate and sullen, without doubt rendered her more compliant to the sanguinary policy of the reactionary bishops. Fortunately for England, her reign was brief. She died—after suffering much and long from dropsy and nervous debility—November 17, 1558.

MARY (St) AND ALL SAINTS, LINCOLN, commonly called LINCOLN COLLEGE, Oxford, was founded for a rector and seven fellows, in 1427, by Richard Fleming, Bishop of Lincoln. In 1475, Thomas Scot, commonly called Rotheram, from the place of his birth, then Bishop of Lincoln, afterwards Archbishop of York, finished the building, added five fellowships, and gave statutes to the society. The object of both founders was to extirpate the Wycliffite heresy, by training up theologians for that purpose. The fellowships were restricted to the dioceses of Lincoln, York, and Wells. By the ordinances under 17 and 18 Vict. c. 81, they are thrown open, the rector and fellows are empowered to reduce the number to ten, as vacancies occur, should this seem expedient, and their value is not to exceed £300. Various benefactors have bestowed scholarships on the college to the number of 22. By the ordinances, 16 of these are thrown open, of value £50 per annum, and tenable for 16 terms from matriculation, which may be extended to 20 if the rector and fellows think fit. This college presents to 10 benefices.

MARY HALL (St), Oxford. In 1239, Henry Kelve, a citizen of Oxford, presented a tenement, on the site of the present St Mary Hall, to the rector of St Mary's Church, to be the parsonage house. In 1325, Edward II. gave the church, together with the parsonage, to Oriol College. The college converted the parsonage into a place of education, and it gradually grew into an independent Hall. It possesses 4 scholarships of £75 per annum, tenable for four years, and 1 exhibition.

MARY STEWART, QUEEN OF SCOTS. This beautiful and accomplished, but most unhappy princess, was the daughter of King James V. of Scotland by his second wife, Mary of Lorraine, daughter of Claude, Duke of Guise, and widow of Louis of Orleans, Duke of Longueville. She was born at Linlithgow, on the 8th of December 1542. Her misfortunes may be said to have begun with her birth. Its tidings reached her father on his deathbed at Falkland, but brought him no consolation. 'The devil go with it!' he muttered, as his thoughts wandered back to the marriage with Bruce's daughter, which brought the crown of Scotland to the Stewarts—it came from a woman, and it will end in a woman! Mary became a queen before she was a week old. Before she was a twelvemonth old, the Regent Arran had promised her in marriage to Prince Edward of England, and the Scottish parliament had declared the promise null. War with England followed, and at Pinkie Cleuch the Scots met a defeat only less disastrous than Flodden. But their aversion to an English match was unconquerable; they hastened to place the young queen beyond the reach of English arms, in the island of Inchmahome, in the Lake of Monteith, and to offer her in marriage to the eldest son of Henry II. of France and Catharine of Medicis. The offer was accepted; and in July 1548 a French fleet carried Mary from Dumbarton, on the Clyde, to Roscoff,

in Brittany, whence she was at once conveyed to St Germain-en-Laye, and there affianced to the Dauphin.

Her next ten years were passed at the French court, where she was carefully educated along with the king's family, receiving instructions in the art of making verses from the famous Ronsard. At a somewhat later period, she had the great Scottish scholar Buchanan for her Latin master. On the 24th of April 1558, her marriage with the Dauphin, who was about two years younger than herself, was celebrated, with every circumstance of pomp and splendour, in the Church of Notre-Dame, at Paris. It was agreed, on the part of Scotland, that her husband should have the title of King of Scots; but this was not enough for the grasping ambition of France, and Mary was betrayed into the signature of a secret deed, by which, if she died childless, both her Scottish realm and her right of succession to the English crown (she was the great-grand-daughter of King Henry VII.) were conveyed to France. On the 10th of July 1559, the death of the French king called her husband to the throne by the title of Francis II. The government passed into the hands of the queen's kinsfolks, the Duke of Guise and the Cardinal of Lorraine; but their rule was short-lived. The feeble and sickly king died on the 5th of December 1560, when the reins of power were grasped by the queen-mother, Catharine of Medicis, as regent for her son, Charles IX. Mary must have been prepared, under almost any circumstances, to quit a court which was now swayed by one whom, during her brief reign, she had taunted with being 'a merchant's daughter.' But there were other reasons for her departure from France. Her presence was urgently needed in Scotland, which the death of her mother, a few months before, had left without a government, at a moment when it was convulsed by the throes of the Reformation. Her kinsmen of Lorraine had ambitious projects for her marriage; great schemes were based on her nearness of succession to the English crown; and both these, it was thought, might be more successfully followed out when she was seated on her native throne.

She sailed from Calais on the 15th, and arrived at Leith on the 19th of August 1561, having escaped the English ships-of-war which Elizabeth despatched to intercept her. She wept as the shores of France faded from her sight, and her tears flowed anew when she beheld the rudeness and poverty of Scotland. Her government began auspiciously. The Reformation claimed to have received the sanction of the Scottish parliament, and if Mary did not formally acknowledge the claim, she was at least content to leave affairs as she found them, stipulating only for liberty to use her own religion—a liberty which Knox and a few of the more extreme Reformers denounced as a sin against the law of God. She is said to have rejected the violent counsels of the Roman Catholics; it is certain that she surrounded herself with Protestant advisers, her chief minister being her illegitimate brother, James Stewart, an able if ambitious statesman, whom she soon afterwards created Earl of Murray. Under his guidance, in the autumn of 1562, she made a progress to the north, which, whatever was its design, ended in the defeat and death of the Earl of Huntly, the powerful chief of the Roman Catholic party in Scotland.

Meanwhile, the courts of Europe were busy with schemes for Mary's marriage. The king of Sweden, the king of Denmark, the king of France, the Archduke Charles of Austria, Don Carlos of Spain, the Duke of Ferrara, the Duke of Nemours, the Duke of Anjou, the Scottish Earl of Arran, and the

English Earl of Leicester were proposed as candidates for her hand. Her own preference was for Don Carlos, the heir of what was then the greatest monarchy in Christendom; and it was not until all hopes of obtaining him were quenched, that she thought seriously of any other. Her choice fell, somewhat suddenly, on her cousin, Henry Stewart, Lord Darnley, son of the Earl of Lennox, by his marriage with a granddaughter of King Henry VII. of England. He was thus among the nearest heirs to the English crown, and his claims to the succession were believed to have the support of the great body of English Roman Catholics. But except this, and his good-looks, he had no other recommendation. He was weak, needy, insolent, and vicious; his religion, such as it was, was Roman Catholic; his house had few friends and many enemies in Scotland; and he was two or three years younger than Mary. Her best friends, both Roman Catholic and Protestant, warned her against him, but in vain. The marriage was celebrated at Holyrood on the 29th July 1566. It was the signal for an insurrection by Murray and the Hamiltons, who hoped to be joined by the whole Protestant party. But their hope was disappointed; and the queen, taking the field in person, at once quelled the revolt, and chased the rebels beyond the Tweed.

Her triumph was scarcely over, when her eyes began to open to the great mistake of her marriage. Her husband's worthlessness and folly became only too apparent; she was disgusted by his debauchery, and alarmed by his arrogance and ambition. She had given him the title of king, but he now demanded that the crown should be secured to him for life, and that if the queen died without issue, it should descend to his heirs. Mary hesitated to comply with a demand which would have set aside the settled order of succession; and what she refused to grant by favour, the king prepared to extort by force.

Mary's chief minister, since Murray's rebellion, had been David Riccio, a mean-looking Italian, of great ability and many accomplishments; but generally hated beyond the palace walls as a base-born foreigner, a court favourite, and a Roman Catholic. The king and Riccio had been sworn friends, sharing the same table, and even sleeping in the same bed; but the king was now persuaded that it was Riccio who was the real obstacle to his designs upon the crown. In this belief, he entered into a formal compact with Murray, Ruthven, Morton, and other chiefs of the Protestant party, undertaking, on his part, to prevent their attainder, or procure their pardon, and to support and advance the Protestant religion; while they, on the other part, bound themselves to procure the settlement of the crown upon him and his heirs, and to take and slay, if need were, even in the queen's palace and presence, every one who opposed it. The result of this conspiracy was the murder of Riccio on the 9th of March 1566, the king leading the way into the queen's cabinet, and holding her in his grasp, while the murderers dragged the poor Italian into an ante-chamber, and mangled his body with more than fifty wounds, completed what they believed, and Knox pronounced to be, 'a just act, and most worthy of all praise.' When Mary learned what had been done, she broke out in reproaches against the king, as to blame for all. 'I shall be your wife no longer,' she told him, 'and shall never like well till I cause you have as sorrowful a heart as I have at this present.' As had been agreed beforehand among the conspirators, Mary was kept prisoner in Holyrood; while the king, of his own authority, dismissed the parliament which was about to forfeit Murray and his associates in the late insurrection. The plot was thus far successful; but Mary no

sooner perceived its objects, than she set herself at work to defeat them. Dissembling her indignation at her husband's treachery and the savage outrage in which he was the ringleader, she succeeded by her blandishments in detaching him from the conspirators, and in persuading him not only to escape with her from their power by a midnight flight to Dunbar, but to issue a proclamation in which he denied all complicity in their designs. The conspiracy was now at an end; Ruthven and Morton fled to England, while Murray, by renouncing their cause, hastened to make his peace with the queen; and the king, hated by both sides, because he had betrayed both sides, became an object of mingled abhorrence and contempt.

It was an aggravation of the murder of Riccio that it was committed, if not in the queen's presence, at least within a few yards of her person, only three months before she gave birth (on the 19th June 1566) to the prince who became King James VI. As that event drew near, the queen's affection for her husband seemed to revive; but the change was only momentary; and before the boy's baptism, in December, her estrangement from the king was greater than ever. Divorce was openly discussed in her presence, and darker designs were not obscurely hinted at among her friends. The king, on his part, spoke of leaving the country; but before his preparations were completed, he fell ill of the small-pox at Glasgow. This was about the 9th of January 1567. On the 25th, Mary went to see him, and travelling by easy stages, brought him to Edinburgh on the 31st. He was lodged in a small mansion beside the Kirk of the Field, nearly on the spot where the south-east corner of the University now stands. There Mary visited him daily, and slept for two nights in a room below his bedchamber. She passed the evening of Sunday the 9th of February by his bedside, talking cheerfully and affectionately with him, although she is said to have dropped one remark which gave him uneasy forebodings—that it was much about that time twelvemonth that Riccio was murdered. She left him between ten and eleven o'clock to take part in a masque at Holyrood, at the marriage of a favourite valet. The festivities had not long ceased in the palace, when, about two hours after midnight, the house in which the king slept was blown up by gunpowder; and his lifeless body was found in the neighbouring garden.

The chief actor in this tragedy was undoubtedly James Hepburn, Earl Bothwell, a needy, reckless, vainglorious, profligate noble, who, since Murray's revolt, and still more since Riccio's murder, had enjoyed a large share of the queen's favour. But there were suspicions that the queen herself was not wholly ignorant of the plot, and these suspicions could not but be strengthened by what followed. On the 12th of April, Bothwell was brought to a mock-trial, and acquitted; on the 24th, he intercepted the queen on her way from Linlithgow to Edinburgh, and carried her, with scarcely a show of resistance, to Dunbar. On the 7th of May, he was divorced from the young and comely wife whom he had married little more than a twelvemonth before; on the 12th, Mary publicly pardoned his seizure of her person, and created him Duke of Orkney; and on the 15th—only three months after her husband's murder—she married the man whom every one regarded as his murderer.

This fatal step at once arrayed her nobles in arms against her. She was able to lead an army against them, but it melted away without striking a blow on the field of Carberry (15th June), when nothing was left to her but to abandon Bothwell, and surrender herself to the Confederated Lords. They

led her to Edinburgh, where the insults of the rabble and grief at parting with Bothwell threw her into such a frenzy, that she refused all nourishment, and rushing to the window of the room in which she was kept prisoner, called for help, and shewed herself to the people half-naked, with her hair hanging about her ears.

From Edinburgh, she was hurried to Loch Leven, where, on the 24th of July, she was prevailed upon to sign an act of abdication in favour of her son, who, five days afterwards, was crowned at Stirling. Escaping from her island-prison on the 2d of May 1568, she found herself in a few days at the head of an army of 6000 men. On the 12th, it was met and defeated by the Regent Murray at Langaide, near Glasgow. Four days afterwards, in spite of the entreaties of her best friends, Mary crossed the Solway, and threw herself on the protection of Queen Elizabeth, only to find herself a prisoner for life. From Carlisle, her first place of captivity, she was taken, in July, to Bolton; from Bolton, she was carried, in February 1569, to Tutbury; from Tutbury, she passed in succession to Wingfield, to Coventry, to Chatsworth, to Sheffield, to Buxton, and to Chartley. She was removed, last of all, to Fotheringhay, in September 1586, there to be tried on a charge of complicity in a plot against the life of Elizabeth. Sentence of death was pronounced against her on the 25th of October; but it was not until the 1st of February 1587 that Elizabeth took courage to sign the warrant of execution. It was carried into effect on the 8th, when Mary laid her head upon the block with the dignity of a queen and the constancy and resignation of a martyr. Five months afterwards, her body was buried with great pomp at Peterborough, whence, in 1612, it was removed to King Henry VII.'s Chapel at Westminster, where it still lies in a sumptuous tomb erected by King James VI.

The character of Mary was long one of the most fiercely-vexed questions of history, and is still in debate, although the great preponderance of authority seems now to be on the side of those who believe in her criminal love for Bothwell and her guilty knowledge of his conspiracy against her husband's life. Her beauty and accomplishments have never been disputed. 'She was confessed by every one'—says Mr Joseph Robertson, the latest writer on her life—'she was confessed by every one to be the most charming princess of her time. Her large sharp features might perhaps have been thought handsome rather than beautiful, but for the winning vivacity and high joyous spirit which beamed through them. It has been questioned whether her eyes were hazel or dark gray, but there is no question as to their star-like brightness. Her complexion, although fresh and clear, would seem to have been without the brilliance so common among our island beauties. Her hair appears to have changed with her years from a ruddy yellow to auburn, and from auburn to dark brown or black, turning gray long before its time. Her bust was full and finely shaped, and she carried her large stately figure with majesty and grace. She shewed to advantage on horseback, and still more in the dance. The charm of her soft, sweet voice is described as irresistible; and she sang well, accompanying herself on the harp, the virginals, and still oftener on the lute, which set off the beauty of her long, delicate, white hand. The consciousness how that hand was admired may have made it more diligent in knitting and in embroidery, in both of which she excelled. Her manner was sprightly, affable, kindly, frank perhaps to excess, if judged by the somewhat austere rules already beginning to prevail among her Scottish subjects. She spoke three or four lan-

guages, was well and variously informed, talked admirably, and wrote both in prose and in verse, always with ease, and sometimes with grace or vigour. In the ring of which she was the centre, were statesmen like Murray and Lethington, soldiers like Kyrkcaldy of Grange, men of letters like Buchanan, Lesley, Sir Richard Maitland, and Sir James Melville. The first poet of France published verses deploring his absence from her brilliant court; Damville, the flower of French chivalry, repined at the fate which called him away from it so soon; Brantôme and the younger Scaliger delighted to speak, in old age, of the days which they passed beneath its roof.'

Mary's prose-writings have been collected by the enthusiastic devotion of Prince Alexander Labanoff, in his *Recueil des Lettres de Marie Stuart*. Setting aside the twelve sonnets which she is said to have written to Bothwell, and which survive only in a French version of an English translation, no more than six pieces of her poetry, containing in all less than 300 lines, are now known. They have no remarkable merit. The best is the poem of eleven stanzas on the death of her first husband, Francis II., printed by Brantôme. The longest is a *Meditation* of a hundred lines, written in 1572, and published two years afterwards by her ever faithful follower, Bishop Lesley of Ross. All are in French, except one sonnet, which is in Italian. The sweetly simple lines beginning, 'Adieu, plaisant pays de France,' so often ascribed to her, are the work of A. G. Meunier de Querlon, a French journalist, who died in 1780. A volume of French verse on the *Institution of a Prince*, which she wrote for the use of her son, has been lost since 1627, along with a Latin speech in vindication of learned women, which, when no more than thirteen, she delivered in the hall of the Louvre, in presence of the French court.

To enumerate all that has been written on Mary would fill a volume. Among the chief works are S. Jebb's *De Vita et Rebus Gestis Mariae Scotorum Reginae* (Lond. 1725, 2 vols. fol.); J. Anderson's *Collections Relating to the History of Mary, Queen of Scotland* (Lond. 1727—1728, 4 vols. 4to); Bishop Keith's *History of the Affairs of Church and State in Scotland* (Edin. 1734, fol.; 1844—1850, 3 vols. 8vo); W. Goodall's *Examination of the Letters said to be written by Mary, Queen of Scots, to James, Earl of Bothwell* (Edin. 1754, 2 vols. 8vo); Principal Robertson's *History of Scotland*; W. Tytler's *Inquiry into the Evidence against Mary, Queen of Scots* (Edin. 1759, 8vo; Lond. 1790, 2 vols. 8vo); M. Laing's *History of Scotland*; G. Chalmers's *Life of Mary, Queen of Scots* (Lond. 1818, 2 vols. 4to; 1822, 3 vols. 8vo); P. F. Tytler's *History of Scotland*; Prince Labanoff's *Recueil des Lettres de Marie Stuart* (Lond. 1844, 7 vols. 8vo); David Laing's edition of *John Knox's History of the Reformation* (Edin. 1846—1848, 2 vols. 8vo); M. Teulet's *Papiers d'Etat relatifs à l'Histoire de l'Ecosse* (Par. 1851—1860, 3 vols. 4to; 1862, 5 vols. 8vo); Miss Agnes Strickland's *Lives of the Queens of Scotland* (Edin. 1850—1859, 8 vols. 8vo); A. de Montaignon's *Latin Themes of Mary Stuart* (Lond. 1855, 8vo); Prince Labanoff's *Notices sur la Collection des Portraits de Marie Stuart* (St Petersburg, 1856); M. Mignet's *Histoire de Marie Stuart* (Par. 1852, 2 vols. 8vo); M. Teulet's *Lettres de Marie Stuart* (Par. 1859, 8vo); M. Chenuel's *Marie Stuart et Catherine de Medicis* (Par. 1858, 8vo); Joseph Robertson's *Catalogues of the Jewels, Dresses, Furniture, Books, and Paintings of Mary Queen of Scots* (Edin. 1863, 4to).

The best representations of Mary are the contemporary portraits by the French painter Francis

Clouet, more commonly called Jehannet or Janet, and the statue, by an unknown sculptor, on her tomb at Westminster. All portraits which cannot be reconciled with these types may safely be rejected as spurious.

MARYLAND, one of the original 13 American states, lies immediately south of Pennsylvania, and is bounded on the east by Delaware and the Atlantic Ocean, between lat. 37° 48'—39° 44' N., and long. 75° 4'—79° 33' W. Area, 11,124 square miles, or 7,119,360 acres; pop. (1860) 687,034, of which 87,188 were slaves. The line of Atlantic coast is but 33 miles, but including Chesapeake Bay, is 411 miles. This bay, 15 miles wide at its mouth, expands to a breadth of 30 miles, with numerous islands, and reaches nearly across the state. The country rises gradually from the coast to the tops of the Alleghanies, with great varieties of formation, including deposits of coal, iron, copper, chromate of iron, silicates and hydrates of magnesia, marl, &c. The climate is temperate, and the soil fertile, producing wheat, Indian corn, cotton, tobacco, apples, plums, peaches, grapes. Its chief towns are Baltimore, Annapolis, Fredericktown, Cumberland. It is the sixth state in commercial importance, with 500 miles of railways, canals, a large manufacturing interest, 13 universities and colleges, 223 academies and private schools, 898 public schools, 1000 churches, 68 periodicals, 124 public libraries. M. was settled by a colony of Roman Catholic gentry from England, under a grant to the second Lord Baltimore, 1632, when it received its present name in honour of the English queen, Henrietta Maria. In 1649, it was made, as has been well said, 'a land of sanctuary,' by the toleration of all religious denominations, but the Puritans, expelled from Virginia, made great trouble in the colony. Organised as a state in 1776, M. took a prominent part in the revolution. In the war of 1861, its sympathies were with the South, and the first blood of the war was shed in Baltimore, several Massachusetts volunteers having been killed on their way to Washington. The position of the state with reference to the seat of federal government caused it, however, to be occupied by a strong military force, and kept under martial law; while it has been invaded from Virginia, and made the scene of bloody conflicts.

MARYPORT, a seaport of Cumberland, England, at the mouth of the Ellen, 23 miles south-west of Carlisle by railway. Its origin dates from 1750. Shipbuilding and its kindred employments are carried on extensively. Lead-pencils are manufactured; and large steam and water-power flour-mills, and two extensive iron-foundries are in operation. The coasting-trade to Ireland averages per month nearly 300 ships, carrying 50,000 tons of coal and coke. Great facilities are given by means of a large floating dock and railway accommodation. Ships registered, 137; tonnage, 24,307. Pop. in 1861, 6037.

MARYSVILLE, a city of California, United States of America, on the north bank of the Yuba River, 100 miles north-north-east of Benicia, and 50 miles north of Sacramento, having steam-boat communication with San Francisco. It is a great resort of gold-miners, and has a variable population of 8000 or 10,000.

MASANIELLO (properly, TOMMASO ANIELLO), a fisherman of Amalfi, was the leader of the revolt which took place in Naples in July 1647 against the Spanish viceroy, the Duke of Arcos. The people had been exasperated by oppression, and great excitement had been produced by a new tax laid upon fruit. M. himself was indignant at the rude

treatment which his wife had received when she was detected in the attempt to smuggle a little flour. He entered into a conspiracy with some others who cherished feelings similar to his own; and an opportunity being afforded them by a tumult at the Customs' Houses on 7th July 1647, when the new tax on fruit was to be levied, they stirred up the multitude to a revolt. Their triumph was complete; palaces and public buildings were destroyed, a bloody popular justice was executed, and the viceroy was terrified into the greatest concessions, and entered into a regular treaty with M. in the church of the Carmelites on 13th July. But success and the flatteries of the viceroy turned the fisherman's head; he gave himself up to drunkenness and every excess, and his capricious despotism immediately became terrible to his own associates, who assassinated him on 16th July. See Angelo Saavedra, Duke of Rivas, *Insurreccion de Napoli en 1647* (2 vols., Madr. 1849).

MASCARENNE ISLES, or **MASCARENHAS**, the collective name given to islands of Bourbon (q. v.), and of Isle-de-France or Mauritius (q. v.). The island of Rodriguez, 360 miles further east, is sometimes reckoned as one of them.

MASCLE (from *macula*, the mesh of a net), in Heraldry, a lozenge-shaped figure perforated and shewing a narrow border. The term *masally* is applied to a field divided by diagonal lines into lozenge-shaped compartments of alternate tinctures, each having its centre voided of the opposite tincture. *Lozengy-masally* is a field composed of lozenges and mascles alternately. In the earlier heraldry, *masally* was used for what was afterwards called lozengy. Crosses and other ordinaries may be formed of mascles, in which case they should begin with half a mascle.



Mascle.

MÁS-ĒNA, a town of Negroland, Africa, capital of the country of Bagirmi, in lat. 11° 35' N., long. 16° E., about 100 miles south-east of Lake Tchad. It covers an area seven miles in circumference, and was formerly much larger. Its present reduced condition has been induced by disastrous civil and foreign wars. Only about half the area of the town is inhabited. The palace of the sultan, who is reported to have from 300 to 400 wives, consists of irregular clusters of clay buildings, and huts surrounded by a wall built of baked bricks. The town is walled, and has nine gates. It has on the whole a dilapidated appearance. Barth's *Travels in Central Africa*.

MASK (Med. Latin, *masca*; Fr. *masque*), a disguise or covering of the face, the use of which perhaps originated in the harvest festivities of the Grecian peasantry of the most ancient times, and appears subsequently to have been associated with the representation of Satyrs, Silenus, and Bacchus in the orgies of Bacchus. Greek tragedy having originated in close connection with the worship of Bacchus, masks were employed in it from the first; but it is uncertain when they were introduced in comedy. The masks used by actors were of very various form and character. They were often provided with metallic mouthpieces, for the purpose of increasing the power of the voice, this being rendered requisite by the immense size of the ancient theatres; their whole use being indeed adapted to such vast buildings, and to a style of dramatic representation in which the ideal prevailed, and the reality of individual impersonation was far less thought of than in modern times. Much information on the subject of ancient masks may be

found in the work of Pacichelli, *De Mascheris, Capillamentis et Chirothecis* (Naples, 1693); in the magnificent work of Pietro Contucci Ficoroni, *De Larvis Scenicis et Figuris Comicis* (Rome, 1754), and in Berger's *De Personis vulgò Larvis seu Mascheris* (Frankf. 1723).

The use of masks in the modern theatre originated in the Italian *commedia dell'arte*, which may itself be traced back to the ancient Roman mimes and pantomimes, and has always been confined to that class of entertainments in which the very names of the characters, *Pantaloon, Harlequin, &c.*, have been borrowed from Italy.

MASK, MASKED, a military expression used in several senses. A *masked battery* is one so constructed, with grassy glacis, &c., as to be hidden from the view of the enemy, until, to his surprise, it suddenly opens fire upon him—on his flank, perhaps. The fire of a battery is *masked* when some other work, or a body of friendly troops, intervenes in the line of fire, and precludes the use of the guns. A fortress or an army is masked when a superior force of the enemy holds it in check, while some hostile evolution is being carried out.

MASKELYNE, NEVIL, an English astronomer and physicist, was born in London, 6th October 1732. He was educated at Westminster School, whence he was removed to Catherine Hall, and subsequently to Trinity College, Cambridge, where he obtained a fellowship in 1756. In 1758, he was elected a Fellow of the Royal Society, and resolved to devote himself to astronomy. In 1763, he made a voyage to Barbadoes, to test the newly-invented Harrison chronometers, and, after his return, was (1765) appointed astronomer-royal. During the 46 years that he held this situation, he acquired universal respect by his diligence and the accuracy of his investigations, made several improvements in the arrangements and employment of the instruments, and was the first to mark the time to tenths of a second. In 1772, he made his celebrated expedition to Shehallion, for the purpose of determining the density of the earth. See **EARTH**. M. was the means of originating the *Nautical Almanac* (q. v.), and also obtained leave to have his observations printed at the expense of government. He published very few works out of his official capacity, but of the others, no fewer than thirty-five appeared, many of which have been found of immense service (especially his *Astronomical Observations*) to subsequent astronomers. M. died 9th February 1811.

MASKS, in Architecture, are carved as decorations on keystones and other prominent positions.

MASON AND DIXON'S LINE, the line which divides Pennsylvania from Maryland, running on the parallel of $39^{\circ} 43' 26''$. The boundary between the colonial possessions of the Lords Baltimore and of the Penn family had been a subject of almost continual dispute from the first settlement of the country. At length, in 1760, the contending parties having agreed upon a compromise, appointed commissioners to settle definitively the limits between the two territories. Surveyors were accordingly employed by both sides, but their progress appearing rather slow, the proprietors who resided in England decided to send Charles Mason and Jeremiah Dixon, two distinguished mathematicians and astronomers, to complete the work which had been begun. They arrived in Philadelphia in November 1763, and concluded their labours in the autumn of 1767, having carefully surveyed and marked a line of nearly 250 miles, extending for the most part through a dense forest, and passing over a number of mountain ridges. This line, dividing as it does the free state of Pennsylvania from the slave state

of Maryland, is often referred to, in popular language, as the boundary between freedom and slavery in the United States.

It is important to distinguish between Mason and Dixon's Line and that of $36^{\circ} 30'$, which separates the cotton states from the border slave states. This line (i. e., the parallel of $36^{\circ} 30'$) is also the celebrated *compromise line* which, in 1820, as a preliminary condition of the admission of Missouri as a slave state, was agreed to by Congress as the northernmost limit of such slave states as should thereafter be admitted into the confederacy.

MASON BEE, a name given to those species of bee which build their nests of agglutinated earth or grains of sand. See **BEE**. *Megachile muraria* is a British species, black, the wings tinted with violet. The nest is attached to walls or stones in sunny places. The interior contains about a dozen cells, in each of which is deposited an egg, with a piece of paste for the food of the larva. These bees sometimes repair old nests, and have fierce combats for the possession of them.

MASON WASP (*Odynerus murarius*), a species of wasp, which makes its nest by boring a cylindrical hole in hard sand, or even in the plaster of walls, on which an exudation from the mouth seems to act



Solitary Mason Wasp (*Odynerus murarius*), and Group of Nests and Larvæ.

so as to soften it sufficiently. At the orifice, an outer tube is constructed, sometimes two or three inches in length, of pellets formed in the excavation. In the interior, an egg is deposited, with a number of little caterpillars ready for food of the larva when hatched.

MASONED, in Heraldry, a term used to describe the lines formed by the junction of the stones in building.

MASONRY, the art of construction in stone. The earliest existing examples are among the most magnificent specimens of the art. No nation has excelled the ancient Egyptians in stonework, whether we consider the size of the materials, or the unequalled exactness with which they are fitted together. The Egyptians did not use mortar in their important structures such as the pyramids, the joints being all carefully polished and fitted. Cyclopean masonry, of which remains exist in many parts of Greece and Italy, also exhibits stones of great size and with carefully-adjusted joints (fig. 1). The walls of Mycenæ are among the earliest examples. These are built with huge irregular blocks, the spaces

between being filled up with smaller stones. The Etruscan specimens are more carefully executed; the stones are not squared, but they are all care-

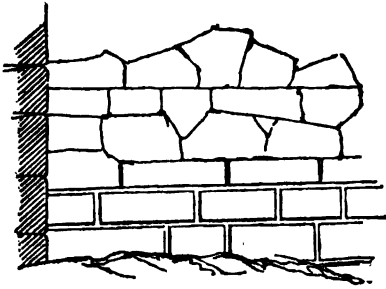

Fig. 1.—Wall in Peloponnesus.

fully fitted together. In some cases, the beds or horizontal joints are made level, and the upright joints left unsquared. No mortar is used in cyclopean masonry.

The masonry of the Greeks and Romans very closely resembled that of the present day: *Rubble-work* (*opus incertum*), in which the stones are not regularly coursed; *Coursed-work*, where the joints are all level, and the stones of equal height; *Ashlar*, resembling the latter, but built with larger stones all carefully dressed on the joints. Many of the Roman buildings in the Eastern Empire were constructed with blocks of enormous size, as at Baalbec, where some of the stones are sixty feet in length. Ashlar-work is frequently used for the exterior surface of walls, the inside being 'backed up' with rubble-work. This kind of work is sufficient for ordinary purposes; but where great strength is required, the whole thickness must be built with solid blocks. Ashlar-work is generally bedded in fine mortar, with one inch of oil-putty on the outer edge.

The early medieval masonry was of very bad construction, being, in fact, little better than common rubble, with an occasional use of Herring-bone Work. The Normans improved upon this kind of work, but their masonry was also so bad, that most of the towers built by them either fell or had to be taken down. The fall of the tower of Chichester Cathedral, a few years ago, was occasioned by defective Norman masonry. The art gradually improved with the advance of Gothic architecture, and ashlar was reintroduced for all important works. The ashlar-work so constantly used in Renaissance buildings, has lately given place to a more picturesque style of masonry called hammer-dressed and squared work—the money saved upon this cheaper work being applied with good effect in improving the appearance of the doors, windows, and other prominent features of the buildings.

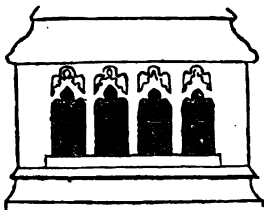

Fig. 2.—Flint Panelling from Fakenham Church, Norfolk.

There is one very simple rule, too little attended to in modern masonry—viz., that all stones, at

least when stratified, should be laid on their *natural bed*, for if set on edge, they are sure to scale off and decay under the influence of the weather.

Special materials sometimes produce special kinds of work; thus, in Norfolk and Suffolk, where large flints abound, the walls are often faced with these, split so as to form a clean face and good joints, and arranged in bands or panels between stonework or brickwork (fig. 2). In Aberdeenshire, where granite is the usual building material, ashlar-work is almost universal, large blocks being more easily obtained and dressed than smaller ones. Again, where rag-stone only can be got, it is frequently neatly used in a similar manner to the flint above described.

MASONS, FREE. The mason brotherhoods of the middle ages were organised incorporations, not substantially different in their nature from the other guilds, governed by rules of their own, and recruited from a body of apprentices who had undergone a period of probationary servitude. Fable and imagination have traced back the origin of freemasonry to the old Roman Empire, the Pharaohs, the Temple of Solomon, or even the times of the Tower of Babel and of the Ark of Noah. The masonic craft in reality sprang into being about the same time, and from the same set of causes, as other incorporated crafts; but a variety of circumstances combined to give it an importance and influence beyond the rest. Men skilled in the hewing and setting of stones were naturally prized in an eminently church-building age. Their vocation necessarily involved travelling from place to place in search of employment. Wherever a great church or cathedral was built, the local masons had to be reinforced by a large accession of craftsmen from other parts; and the masons from neighbouring towns and districts flocked to the spot, and took part in the work, living in a camp of huts reared beside the building on which they were engaged. A master presided over the whole, and every tenth man was a warden having surveillance of the rest. A mason, therefore, after going through his apprenticeship and probation, could not settle down, like another craftsman, among his neighbours and acquaintances, but must travel from place to place to find employment; hence it became desirable or necessary to devise means by which a person once a member of the fraternity might be universally accepted as such, without requiring, wherever he went, to give fresh evidence of his skill, or having to undergo a renewed examination on his qualifications. In order to accomplish this end, and to enable a mason travelling to his work to claim the hospitality of his brother-masons on his way, a system of symbols was devised, in which every mason was initiated, and which he was bound to keep secret. This symbolism, invented for the convenience of intercourse between members of the same craft, is the sole shadow of foundation for the popular notion that the masonic brethren were in possession of secrets of vital importance, the knowledge of which had been from generation to generation confined to their own order. It has been supposed that the possession of the masonic secrets enabled the masons to design the great cathedrals of the 13th and 14th centuries, whereas it is now certain that during the purest ages of Gothic architecture, both in France and in England, the architects were not members of the masonic fraternity at all, but either laymen of skill and taste, uninitiated in the mysteries of mason-craft, or oftener bishops and abbots. The masons who worked from the architect's design were, at the same time, not the mere human machines that modern workmen too generally are, but men who,

in carrying out an idea imparted to them, could stamp an individuality of their own on every stone. Architecture was then a progressive art, and the architect of every great church or cathedral had made himself acquainted with the works of his predecessors, and profited by experience, adopting their beauties, and shunning their defects. The nature of the advance which architecture was then making, has been compared by Mr Fergusson to the advance with which we are familiar in the present day in ship-building and other useful arts. 'Neither to the masons nor to their employers, nor to the Abbé Sugar, Maurice de Sully, Robert de Susarches, nor Fulbert de Chartres, is the whole merit to be ascribed, but to all classes of the French community carrying on steadily a combined movement towards a well-defined end.' In Germany, however, the masons of the 14th c., who had attained a wonderful skill in carving and in constructing arches, overstepping their original functions, took to a great extent the office of architect into their own hands; and it is undeniable that the churches designed by German masons, though rich in the most exquisite workmanship, are not comparable, in the higher elements of beauty, to the works of non-masonic architects.

The epithet 'Free' was applied to the craft of masons in consequence of their being exempted by several papal bulls from the laws which regulated common labourers, and exonerated from various burdens thrown on the working-classes at large both in England and on the continent. Like all the other guilds, the masons were bound by their rules to the performance of specific religious duties; but a craft one of whose principal functions was church-building, was naturally under the more especial protection of the clergy. Yet a considerable time before the Reformation, we find the jealousy of the church excited from time to time by the masonic brethren, partly in consequence of their assuming other functions besides those of mere builders. In England, an act, passed in the minority of Henry VI., at the instigation of Henry of Beaufort, Cardinal of Winchester, prohibited the masons from holding their wester chapters and assemblies. But this act was never enforced; and Henry VI., on coming of age, himself countenanced the masons, and was a member of the fraternity. Henry VII. became their grand master in England.

The history of freemasonry has been overlaid with fiction and absurdity, partly from an exaggerated estimate of its importance in the development of architecture, and partly from a wish to connect medieval masonry with the institution that passes under the same name in the present day. Modern (or so called 'speculative') freemasonry is an innocent mystification unconnected either with the building craft or with architecture. It is of British origin, and dates from the 17th century. According to the peculiar phraseology of the masonic brethren, it is founded in the 'practice of moral and social virtues; its distinguishing characteristic is charity, in its most extended sense; and brotherly love, relief, and truth are inculcated by its precepts. Its real founders were Elias Ashmole and some of his literary friends, who amused themselves by devising a set of symbols, borrowed in part from the Knights Templars, between whom and the old masons an intimate relation is said to have subsisted, and in part from the Rosicrucians (q. v.). These symbols, which have since been adopted as the distinguishing badge of the brotherhood of 'Free and Accepted Masons,' include the sun, the moon, the compasses, square, and triangle. A number of so-called degrees or grades of masonry with fantastic names were established and conferred on the mem-

bers.* Charles II. and William III. were masons; and the appearance of a connection with operative masonry was kept up by the appointment of Sir Christopher Wren to the office of Grand Master. The 'Lodges' of Scotland profess to trace their origin to the foreign masons who came to Scotland in 1150 to build Kilwinning Abbey; those of England go still further back, to an assemblage of masons held by St Alban, the proto-martyr, at York in 926; and the mother-lodges of York and Kilwinning were, with insignificant exceptions, the parents of all the several lodges erected in different parts of Great Britain. Towards the close of last century, it was in some quarters made a charge against freemasonry, that under its symbolism was concealed a dangerous conspiracy against all government and religion. The accusation was probably groundless enough, and so little effect was produced by it, that, in an act passed in 1799 for the suppression of secret societies, an exception was made in favour of freemasons. In 1717, a Grand Lodge was formed in London, with power to grant charters to other lodges. Under its sanction, the first edition of the constitutions of the fraternity was published. The Grand Lodge was for a length of time on an unfriendly footing with the lodge of York, in consequence of having introduced various innovations, not approved of by the older lodge, and of having granted charters within the district which York claimed as its own. In 1742, the Duke of Cumberland was elected Grand Master of the Grand Lodge; and on his death, George IV., then Prince of Wales, succeeded to the office, which he continued to hold till he was appointed Regent, when, it being considered unsuitable that he should longer exercise any personal superintendance, he took the title of Grand Patron. In 1813, an understanding and a union was brought about between the two rival lodges by their respective Grand Masters, the Dukes of Kent and Sussex. The fraternity has since been managed by the 'United Grand Lodge of Ancient Free and Accepted Masons of England,' consisting of the Grand Master; with his Deputy, Grand Wardens, and other officers, the provincial Grand Masters, and the Masters and Wardens of all regular lodges, with a certain number of stewards annually elected, who meet four times a year for the despatch of business, besides which there is an annual masonic festival, at which every mason is entitled to attend. The Grand Lodge of England has at present above a thousand lodges under its protection, and has given away large sums for philanthropic objects.

In Scotland, the Grand Masterhip of the masons, when they were a real company of artificers, was for a considerable time hereditary in the family of the barons of Rosslyn, and annual meetings of the fraternity were held at the town of Kilwinning. On the introduction of modern masonry, William St Clair of Rosslyn was made Grand Master of all Scotland, and the Grand Lodge of Scotland was instituted in 1736. The masons of Scotland held communication only with the more ancient English masons till 1805, when they established an alliance also with the Grand Lodge of England, and elected the Prince of Wales their Grand Master. In 1744, masonic 'brotherly love' was interrupted by a dispute between the Kilwinning Lodge and the lodge of the Chapel of St Mary, each claiming the post of honour as the oldest lodge in Scotland. The Grand Lodge decided in favour of the latter, as being

* The three principal grades are apprentice, fellow-craft, and master-mason; there being peculiar ceremonies at the making of each; and it is only on attaining to the degree of master-mason, that a brother enjoys the full benefits and privileges of the craft.

possessed of the older charter; and the Kilwinning Lodge feeling aggrieved, withdrew from the control of the Grand Lodge, and established the 'Grand Chapter of the Royal Order of Kilwinning.' The Grand Mastership of Scotland is now held by the Duke of Athole.

Besides granting charters of affiliation, the chief use of the Grand Lodge, whether of England or Scotland, consists in its acknowledged authority to enforce uniformity of ceremonial and other observances, and to settle all disputes that may arise within the lodges under its charge. The officers of the Grand Lodge are to a large extent delegates from the respective lodges; the delegation being in the form of proxy masters and wardens. As a source of revenue for each master made by a lodge, a fee must be remitted to the Grand Lodge, whereupon a diploma of brotherhood will be issued.

Modern freemasonry spread from Britain to the continent. Lord Derwentwater and other Englishmen introduced it into France in 1725, where it established itself, although discountenanced by Louis XV. and by the clergy. In 1756, the French masons became independent of the English Grand Master; and in 1772, the two grand lodges of 'Le Grand Orient' and 'La Grande Loge de France' were formed, which became united in 1799. There are now above 300 lodges in France, about a fourth of which are in Paris. In Russia, masonry, introduced by the English in 1731, was encouraged by the Empress Catharine II., and to a greater extent by the Emperor Alexander, who was himself initiated. Masonic institutions have also existed in Spain and Italy, generally under the ban of government, and sometimes of the Inquisition. Under the auspices of English and Scotch Grand Lodges, masonry has also obtained a footing in Holland, Poland, Denmark, Hungary, Sweden, Prussia, India, and America.

The deep symbolical meaning supposed to be couched under the jargon of the masonic fraternity, is probably as apocryphal as the dangers of masonry to government and order. A set of pass-words, and a peculiar grip of the hand, enable the initiated to recognise each other, and give a zest to their convivial meetings; and if the institution possesses any practical utility, it is in its enabling a mason in a place where he is a stranger to make himself known to his brother-masons, and claim their protection and assistance. The mysteries of the craft have recently been so far encroached on, that the Grand Master has given leave to the *Free Masons' Magazine* to publish reports of the proceedings of grand and private lodges.

MASQUE, a species of dramatic performance, much in vogue in England towards the close of the 16th and the beginning of the 17th century. It was, in fact, the favourite form of private theatricals at the time. The masque appears to have originated in the practice of introducing, in any solemn or festive processions, men wearing masks, who represented either imaginary or allegorical personages. At first, it was simply an 'acted pageant,' as in the well-known progresses of Queen Elizabeth; but gradually it expanded into a regular dramatic entertainment, and in the hands of men like Fletcher and Ben Jonson attained a high degree of literary beauty. Jonson's masques were represented at court, and were greatly relished. The taste for this kind of amusement, however, died away in the reign of Charles I.; nevertheless, to the time of that monarch belongs the finest masque, and one of the most splendid poems ever written—the *Comus* of Milton (1634). See Masson's *Life of Milton* (vol. i. page 542, et seq.).

MASQUERA'DE, or MASKED BALL, a festive meeting in which the host and guests assume fictitious characters, and disguise themselves more or less for the occasion, the name being derived from the use of the mask. The public *mummers* of former times, Easter plays, Festivals of Fools, &c., which were frequent in most parts of Europe, but somewhat various in different countries, probably suggested the idea of the masquerade, which, however, was not open to all, according to the well understood rules of these ancient amusements, but was limited to some select class, or to those who paid a certain sum for admission. Catharine de' Medici introduced the regular masquerade at the French court. It found its way to England in the reign of Henry VIII., but did not reach any of the courts of Germany till the end of the 17th century. The *bal costumé* is a very modified and much less objectionable form of the masquerade. During the Carnival, public masquerades are held in all the theatres and dancing-saloons of Paris, and on these occasions scenes of the most disgraceful profligacy are said to be enacted, in spite of the strict supervision of the police.

MASS (Lat. *Missa*), the name given in the Roman Catholic Church to the Eucharistic service which in that church, as well as in the Greek and other oriental churches, is held to be the sacrifice of the new law, a real though unbloody offering, in which Christ is the victim, in substance the same with the sacrifice of the cross, and instituted as a commemoration of that sacrifice, and as a means of applying its merits, through all ages, for the sanctification of men. The doctrine of the Mass, as understood by Roman Catholics, presupposes the Eucharist, although the latter doctrine does not necessarily involve the notion of a sacrifice, and may even be held by those who deny the sacrificial character of the Eucharistic rite. The arguments for and against this belief, on which the Mass is founded, do not fall within our province, which limits us to a brief history and explanation of the rite, as it is found among Catholics and the members of other communions in which it is observed. Without entering into discussions as to the primitive character of the Eucharistic rite, it will be enough to observe that the very earliest records of Christian history, whether in the Acts of the Apostles, the canonical Epistles, or the writings of the most ancient of the Fathers, plainly evince the existence from the beginning of a rite, which it is impossible not to regard as in its general character identical with that which still constitutes in most Christian communities the chiefest and most solemn part of their public worship. This rite is believed by Roman Catholics to have been partly a sacrifice, partly a communion and participation thereof by the faithful; and of the names by which it is called in the works of the early Fathers, some—as, for example, *agape*, and *hagia synaxis*, refer to the latter, while others—as *thusia*, *prosphora*, *hiericon*—indicate the former signification. The etymology of the name now in use is somewhat obscure, but it is commonly referred to the proclamation made by the deacon at the close of the service—'Ite; missa est' ('Go; the assembly is dismissed'). By primitive use, the communion of the faithful appears always, unless in exceptional cases, to have formed part of the Eucharistic service; but afterwards it came to pass that the officiating priest only communicated, whence arose, especially in the Western Church, the practice of 'private masses,' which has been in later times a ground of complaint with dissentients from Rome, even those who in other respects approach closely to the Roman doctrine. In the ancient writers, a distinction is

made between the 'mass of the catechumens' and the 'mass of the faithful'; the former including all the preparatory prayers, the latter all that directly regards the consecration of the elements and the communion, at which the 'discipline of the secret' forbade the presence of the catechumens. With the cessation of this discipline, the distinction of names has ceased, but the distinction of parts is still preserved, the mass of the catechumens comprising all the first part of the Mass as far as the 'preface.' The Mass is now in general denominated according to the solemnity of the accompanying ceremonial, a 'Low Mass,' a 'Chanted Mass,' or a 'High Mass.' In the first, a single priest simply reads the service, attended by one or more acolytes or clerks. The second form differs only in this, that the service is *chanted*, instead of being read by the priest. In the High Mass, the service is chanted in part by the priest, in part by the deacon and sub-deacon, by whom, as well as by several ministers of inferior rank, the priest is assisted. In all these, however, the service, as regards the form of prayer, is the same. It consists of (1) an introductory prayer composed of the 41st Psalm, together with the 'general confession'; (2), the Introit, which is followed by the thrice-repeated petition, 'Lord, have mercy,' 'Christ, have mercy,' and the hymn, 'Glory to God on high'; (3), the collect, or public and joint prayers of priest and people, followed by a lesson either from the Epistles or some book of the Old Testament, and by the Gradual (q. v.); (4), the gospel, which is commonly followed by the Nicene Creed; (5), the OFFERTORY (q. v.), after the reading of which comes the preparatory offering of the bread and wine, and the washing of the priest's hands, in token of purity of heart, and the 'secret,' a prayer read in a low voice by the priest; (6), the preface, concluding with the trisagion, or 'thrice holy'—at which point, by the primitive use, the catechumens and penitents retired from the church; (7), the 'canon,' which is always the same, and which contains all the prayers connected with the consecration, the elevation, the breaking, and the communion of the Host and of the chalice, as also the commemorations both of the living and of the dead; (8), the 'communion,' which is a short scriptural prayer, usually appropriate to the particular festival; (9), the 'post-communion,' which, like the collect, was a joint prayer of priest and people, and is read or sung aloud; (10), the dismissal with the benediction, and, finally, the first chapter of St John's gospel. Great part of the above prayers are fixed, and form what is called the 'ordo' or 'ordinary' of the Mass. The rest, which is called the 'proper of the Mass,' differs for different occasions; some masses being 'of the season,' as of Lent, Advent, Passion-tide, 'Quarter-time,' &c.; others, of 'Mysteries,' as of the Nativity, the Circumcision, the Resurrection; others, again, of saints, as of an Apostle, a Martyr, or a Confessor; others, again, 'votive,' as 'of the Passion,' 'of the Dead,' 'for Peace,' &c. In all these various classes, as well as in the individual masses under each, the 'proper' portions of the Mass differ according to the occasion, and in some of them certain portions of the 'ordinary,' as the 'Glory to God on high,' the 'Gradual,' or the 'Nicene creed,' are omitted. On one day in the year, Good-Friday, is celebrated what is called the 'Mass of the Precinctified,' in which no consecration takes place, but in which the priest communicates of the Host which was consecrated on the preceding day. This usage is found also in the Greek Church, not alone on Good-Friday, but on every day during the Lent, except Saturday and Sunday. In the celebration of Mass, the priest wears peculiar vestments, five

in number—two of linen, called 'amice' and 'alb,' and three of silk or precious stuffs, called 'maniple,' 'stole,' and 'chasuble,' the alb being girt with a cincture of flaxen or silken cord. The colour of these vestments varies with the occasion, five colours being employed on different occasions—white, red, green, purple or violet, and black; and they are often richly embroidered with silk or thread of the precious metals, and occasionally with precious stones. The priest is required to celebrate the Mass fasting, and, unless by special dispensation, is only permitted to offer it once in the day, except on Christmas-day, when three masses may be celebrated.

In the Greek and Oriental churches, the Eucharistic service, called in Greek *Theia Leitourgia* (The Divine Liturgy), differs in the order of its parts, in the wording of most of its prayers, and in its accompanying ceremonial, from the mass of the Latin Church (see LITURGY); but the only differences which have any importance as bearing upon doctrine, are their use of leavened bread instead of unleavened; their more frequent celebration of the 'Mass of the Precinctified,' to which reference has already been made; the Latin use of private masses, in which the priest alone communicates; and, in general, the much more frequent celebration of the Mass in the Latin Church. The sacred vestments, too, of the Greek and Eastern rites differ notably from those of the Latin; and in some of the former—as, for example, the Armenian—a veil is drawn before the altar during that part of the service in which the consecration takes place, which is only withdrawn at the time of the communion. The service sometimes used on ship-board, and improperly called *Missæ Siccæ* (Dry Mass), consists simply of the reading of the prayers of the mass, but without any consecration of the elements. It was resorted to with a view to avoiding the danger of spilling the sacred elements, owing to the unsteady motion of the ship. It is sometimes also called *Missæ Nauticæ* (Ship Mass).

MA'SSA DUCALĒ, or DI CARRA'RA, so called to distinguish it from the many towns of the same name, is a small city of Northern Italy, 58 miles south-west of Modena, and formerly capital of the duchy of Massa-Carrara. Pop. 8000. It is a bishop's see, has a public library, a literary institute, a cathedral, and a ducal palace. M. stands in a beautiful situation, sheltered by a background of mountains, and surrounded by a district productive in oranges, citrons, and vast olive-groves.—In the middle ages, the duchy of M. was held by a succession of feudal lords, and passed to the House of Este, Dukes of Modena, towards the close of the 18th century. Bonaparte invested his sister, the Princess Eliza, with the principality of M. and Carrara; but in 1829 it was reunited to Modena, and in 1860 became a province of the Kingdom of Italy, and has a pop. of 147,838.

MA'SSA LUBRE'NSE, a pleasant Italian town, 17 miles south of Naples by sea. Pop. 8168. M. stands amidst the loveliest scenery of Italy, and is built on a cliff projecting into the sea, and commanding a fine view of the Bay of Naples. It dates from the early Greek period, and contains many remains of Roman antiquities. It is famed for the beauty of its women.

MASSACHU'SSETTS, one of the thirteen original states of the American Union, and oldest of the New England States, lies between lat. 41° 15'—42° 53' N., and long. 69° 56'—73° 32' W., being 160 miles from east to west, and from 47 to 110 from north to south, with an area of 7800 square miles; it lies south of Vermont and New Hampshire,

MASSACHUSETTS BAY—MASSILLON.

and borders on the Atlantic. There are 14 counties, and the chief towns are Boston, the capital, Lowell, Lawrence, Newburyport, Salem, New Bedford, Charlestown, Cambridge, and Worcester. On the south-eastern coast are the islands of Nantucket and Martha's Vineyard. The principal rivers are the Connecticut, Merrimac, and Housatonic, which afford water-power to many manufacturing cities and villages. The country is hilly, and much of the soil sterile, but in the river-valleys it is fertile. The most important mineral products are granite and syenite, sand for glass, and iron. The chief agricultural products are Indian corn, apples and pears, grass and hay; but the manufactures are very large and various. There are more than 300 cotton-mills, 150 woollen-mills, 13 carpet-mills, with many iron foundries, rolling-mills, nail-factories, and machine-shops. The manufacture of boots and shoes amounts to 50,000,000 dollars a year; 30,000 persons are engaged in various fisheries; there are 176 banks of issue; 51 railway companies have covered the state with a net-work of 1600 miles of railway. There are 1475 churches, 22 daily papers, and 282 periodical publications, 4444 public or free schools, 750 academies, 4 normal schools, 5 colleges, a state asylum for the blind, and 3 lunatic asylums. M. was discovered by the Cabots in 1497. In 1614, it was visited by Captain John Smith. In 1620, the *Mayflower*, 180 tons, sailed from Southampton with 102 Puritan settlers, and landed at Plymouth, M., December 22. Half died from cold and hardship the first year. In 1637, the colony suffered from Indian massacres; and in King Philip's war, 1675, 12 towns and 600 houses were burned. The war of the Revolution of 1776 began in M. with the battles of Lexington and Bunker Hill. The Federal constitution was adopted 1780, in convention, by a vote of 187 to 168, since when it has been a leading state in politics, commerce, manufactures, and education. Pop. in 1810, 472,040; in 1860, 1,231,065.

MASSACHUSETTS BAY, an indentation on the eastern coast of Massachusetts, between Cape Cod and Cape Ann, 70 miles long and 25 miles wide, but including in its irregular form Plymouth Bay, Cape Cod Bay, and several others, with numerous small islands.

MASSA'FRA, a town of the Neapolitan province of Otranto, 11 miles north-west of Taranto, situated in a plain in the midst of hills more productive than salubrious. Pop. 9100. Its site is partly that of the ancient *Messapia*, from which the whole district takes its name.

MASSA'GETÆ, a nomadic people, who inhabited the broad steppes on the north-east of the Caspian Sea, to the northward of the river Araxes or Jaxartes. Herodotus says that they had a community of wives; that they sacrificed and devoured their aged people; that they worshipped the sun, and offered horses to him; that they lived on the milk and flesh of their herds, and on fish; and fought on horseback and on foot with lance, bow, and double-edged axe. Cyrus is said to have lost his life in fighting against them, 530 B.C. Niebuhr and Böckh are of opinion that they belonged to the Mongolian, but Humboldt and others, to the Indo-Germanic or Aryan family.

MASSENA, ANDRÉ, Duke of Rivoli, Prince of Essling, and a marshal of France, was born at Nice, 6th May 1758. In his youth, he served as a ship-boy in a small vessel, and afterwards 14 years in the Sardinian army, but left it because his plebeian birth precluded him from promotion. Early in the French Revolution, he joined a battalion of volunteers, and soon rose to high military rank. In

December 1793, he was made a general of division. He greatly distinguished himself in the campaigns in Upper Italy. After Jourdan's defeat at Stockach on 25th March 1799, the chief command of the army in Switzerland devolved on him in circumstances of great difficulty, but he kept his ground against the Archduke Charles, and finally, by his victory over the Russians at Zürich, 25th September 1799, freed France from the danger of invasion. After the battle of Marengo, Bonaparte gave him the command of the army of Italy. In 1805, he was made a marshal of the empire. In 1805, he again commanded in Italy; and subsequently he signalled himself in the terrible contest for the village of Aspern (q. v.). In 1810, he was intrusted with the chief command in Spain, and compelled the British and their allies to fall back to Lisbon; but being unable to make any impression on Wellington's strong position at Torres Vedras, he resigned his command. He offered his services, however, again, when Napoleon was preparing for the Russian campaign, but was only intrusted with the command in Provence, and in this position he remained till the Restoration, when he gave in his adhesion to the Bourbons, and was made a peer. On Napoleon's return from Elba, he invited M. to follow him, but received no response. After the second Restoration, M. retired into private life. He died 4th April 1817. M. was one of the ablest of Napoleon's generals, but he was as extortionate as a Roman prætor. His master called him a robber, and is said to have offered him a present of 1,000,000 francs if he would give up speculation!

MA'SSICOT, a mineral, occurring in shapeless masses of a yellow colour, brittle, with earthy fracture. Chemically, it is protoxide of lead. It is used as a pigment.

MASSILLON, JEAN BAPTISTE, one of the most distinguished of modern pulpit orators, was born at Hières, in France, June 24, 1663. His father, a notary, designed the boy for his own profession; and it was only after repeated and persistent efforts, that M. obtained his father's permission to enter the congregation of the Oratory in 1681. It was while he was engaged in teaching theology in one of the houses of the congregation in the diocese of Meaux, that he made his first essay in the pulpit at Vienna. His funeral oration on M. Villars, the Archbishop of Vienna, was eminently successful, and led to his being called by the superiors of the Oratory to Paris, where he first had the opportunity of hearing Bourdaloue, whose style and manner, without being exactly taken by M. as a model, had great influence in forming the taste of the young aspirant. Like Bourdaloue, he avoided the declamatory manner and theatrical action then popular in the French pulpit; but the earnest impressiveness of his look and voice more than supplied the vigour and energy which other speakers sought from these adventitious aids. His course of ecclesiastical conferences, delivered in the seminary of St Magloire, established his reputation. The criticism of Louis XIV., after his Advent course at Versailles, that 'when he heard other great preachers, he felt satisfied with them, but when he heard M., he felt dissatisfied with himself,' well expresses the characteristics of the eloquence of this great orator, who, more than any of his contemporaries, was able to lay bare the secret springs of human action, and to use the feelings and the passions of his audience as arms against themselves. He was again appointed to preach the Lent at Versailles in 1704; but although the king was again equally warm in his admiration of the preacher, M. was never afterwards invited to preach in the presence of

this monarch; yet his funeral oration on the Prince de Conti, in 1709, was one of the greatest triumphs of his oratory. Soon after the death of Louis XIV., M., in 1717, was named Bishop of Clermont, and in the same year, was appointed to preach before the young king, Louis XV., for which occasion he composed his celebrated *Petit Carême*—a series of ten sermons. It was not till 1719 that he was consecrated Bishop of Clermont, in which year also he was elected a member of the Academy; and in 1723, he preached the funeral oration of the Duchess of Orleans, his last public discourse in Paris. From this time he lived almost entirely for his diocese, where his charity, gentleness, and amiable disposition gained him the affections of all. He died of apoplexy in 1742, at the age of 79 years. His works, consisting mainly of sermons and other similar compositions, were collected, in 12 vols. by his nephew, and published in 1745—1746; later editions are those of Beauc6 (4 vols. 1817), Mequignon (15 vols. 1818), and Chalandre (3 vols. 1847).

MASSINGER, PHILIP, an English dramatist, was born in 1584, at or near Wilton, it is supposed, the seat of the Earls of Pembroke, of which family his father was a retainer. Of his boyish days, and of the place of his education, nothing is known. From his plays, we are, however, certified that he was a classical scholar. He entered St Alban's Hall as a Commoner in 1602, and quitted the university suddenly, and without obtaining a degree, on the occasion, it is surmised, of his father's death. After leaving Oxford, his career cannot be clearly traced. He came to London, and wrote for the stage, sometimes on his own account, frequently—as was the fashion of the time—in conjunction with others. He produced many plays, the dates of which are obscure. He seems to have lived in straitened circumstances, and to have been of a melancholy turn of mind. On the morning of the 16th March 1640, he was found dead in his bed. He was buried in the churchyard of St Saviour's, by the hands of the actors. In the parish register stands the pathetic entry: 'March 20, 1639—1640, buried Philip Massinger, a stranger.'

Taken as wholes, M.'s plays do not strike one much; their merits consist in detached passages. He was of a grave and serious mood, and his reflective passages rise into a rich elaborate music. His finest writing is contained in *The Virgin Martyr*, but his best plays are *The City Madam*, and the *New Way to Pay Old Debts*—the last of which has even yet some slight hold on the stage. The best edition of his works is that by Gifford (Lond. 1806, reprinted 1815).

MASSO'RAH, variously derived from *massar* (to hand down to posterity—tradition), and *assar* (to bind, to fix within strict limits), denotes chiefly a certain collection of critical notes on the text of the Old Testament, its divisions, accents, vowels, grammatical forms, letters, &c.; all the more necessary for the more accurate preservation of the sacred documents, as, according to the early mode of Semitic writing, only the consonants, and these without any stop or break, were put down; a proceeding which, in the course of time, must naturally have produced a vast number of variants, or rather different ways of reading and interpreting the same letters, by dividing them into different words with different vowels and accents. The origin of the M., which, by fixing an immutable reading upon each verse, word, and letter, put an end to the exercise of unbounded individual fancy—which, for homiletical purposes alone, was henceforth free to take its own views—is shrouded in deep mystery. The

first traces of it are found in certain Halachistic works treating of the synagoga rolls of the Pentateuch, and the mode of writing them. Some of the earliest works on the subject have survived in their titles only, such as *The Book of the Crowns*, *The Book of the Sounds*, &c., attributed to the Soferim, or Masters of the Mishna (q. v.). There can hardly be a doubt that the Massorah, like the Halacha and Haggada, was the work, not of one age or century, but of many ages and centuries, as, indeed, we find in ancient authorities mention made of different systems of accentuation used in Tiberias, Babylon (Assyria), and Palestine. It was in Tiberias also that the M. was first committed to writing between the 6th and 9th c. A. D. Monographs, memorial verses, finally, glosses on the margins of the text, seem to have been the earliest forms of the written M., which gradually expanded into one of the most elaborate and minute systems, laid down in the 'Great Massorah' (about the 11th c.), whence an extract was made known under the name of the 'Small Massorah.' A further distinction is made between M. *textualis* and *finalis*, the former containing all the marginal notes; the latter, larger annotations, which, for want of space, had to be placed at the end of the paragraph. The final arrangement of the M., which was first printed in Bomberg's Rabbinical Bible (Ven. 1525), is due to Jacob ben Chajim of Tunis, and to Felix Pratensis. The language of the M. is Chaldee, and besides the difficulty of this idiom, the obscure abbreviations, contractions, symbolical signs, &c., with which the work abounds, render its study exceedingly hard. Nor are all its dicta of the same sterling value; they are not only sometimes utterly superfluous, but downright erroneous. Of its 'countings,' we may adduce that it enumerates in the Pentateuch 18 greater and 43 smaller portions, 1534 verses, 63,467 words, 70,100 letters, &c.—a calculation which is, however, to a certain degree at variance with the Talmud.—An explanation of the M. is found in Elijah Levita's (q. v.) *Masoreth Hammesoreth* (transl. into German by Semler, Halle, 1772), and Buxtorf's *Tiberias* (Basel, 1620), a work abounding with exceedingly curious information on the text of the Old Testament.

MAST, an upright, or nearly upright spar, resting on the Keelson (q. v.) of a ship, and rising through the decks to a considerable height, for the purpose of sustaining the yards on which the sails are spread to the wind. It is usually in joints or lengths, one above the other, the lowest and strongest being the *mast* proper, distinguished by its position as the fore, main, or mizzen mast. Above this come successively the *top-mast*, the *top-gallant-mast*, the *royal-mast*, and—though very rarely used—the *sky-scraper*. The full height of all the masts together, in a first-rate ship of war, is about 250 feet. As, when a strong wind is blowing, the pressure upon the canvas carried by a mast amounts to many tons, the mast itself must be of great strength. In some modern vessels, hollow iron masts are used, with success, it is said, as being much lighter than those of wood; but the majority are of Norway fir of the best quality. In small vessels, the mast is made of one tree; but it is considered stronger when 'a made mast,' that is, when constructed of several pieces riveted together, and strengthened by iron hoops. The mast is sustained, when fixed, by the shrouds, as supports on each side, by the Stay (q. v.) in front, and the back-stays behind.

MASTER, in the Royal Navy, is an officer ranking with, but junior to, lieutenants, and charged with

the details of sailing the vessel, under the general orders of the captain. It is his duty to take charge of such of the ship's stores as are not under the paymaster: in short, the master is the navigator and storekeeper for the vessel; as such, holding a most responsible and onerous position. For his assistants, he has the junior officers in his own department—the second master and master's assistants—and the ship's quartermasters. A master enters the navy as master's assistant, and having risen through second master to be master, has then attained his highest substantive rank. This has long been a grievance to the department; and to ameliorate their condition, the Admiralty have lately granted higher relative rank to masters of long service, with the titles of 'Staff-commander' and 'Staff-captain.' The full-pay of a master, exclusive of store and other allowances, ranges from 10*s.* to 20*s.* a day; of a second master, from 5*s.* to 7*s.* 6*d.*; and of a master's assistant, from 3*s.* to 4*s.* a day.

In the Merchant Navy, the master of a vessel, usually, by courtesy, denominated the captain, is the officer commanding her. His duties comprise the maintenance of discipline, the sailing of the ship, the charge of her cargo, and many other mercantile functions. His responsibilities to the ship's owners are of course settled by distinct agreement, applicable to the special case. Towards the public, however, many acts of parliament determine his responsibility. The master is bound to come to a written agreement with each of his men, before sailing, as to the wages to be paid. He is bound to bring home and subsist (to the number of four for every ten tons), seafaring persons—British subjects—who may have been cast away, captured by the enemy, or by other unavoidable accident left upon a foreign shore; for these he is granted head-money by the Admiralty. The master is compelled to keep a proper log-book, and must produce it, with his ship's papers, on the requisition of the commander of a ship-of-war of his own nation. Masters of vessels of a certain size are required to obtain certificates of qualification from the Board of Trade. Certificated masters are eligible for the ROYAL NAVAL RESERVE (q. v.), with the rank of lieutenant.

MASTER (Ger. *Meister*, Lat. *magister*, from *magis*), one who rules, governs, has servants under him. As a complimentary appellation of respect, it is prefixed to the Christian name and surname, or surname simply, contracted into Mr in writing, and pronounced 'Mister.' The eldest son of a baron in the peerage of Scotland is generally known by the title of the 'Master of —,' prefixed to his father's title of peerage.

MASTER AND SERVANT. The relation of master and servant is constituted in Great Britain entirely by contract; for there being no status of slavery recognised in law, one person can only serve another with his or her own free consent. Being a mere contract, it may, like other contracts, be broken at will, subject only to the usual consequence, that the party in the wrong is liable to pay damages for the breach. In England and Ireland, the engagement or hiring of a servant may be either verbal or in writing; but if the engagement is for more than one year, it must be in writing. If for an indefinite time, no writing is necessary. When a servant continues in the service after the first year, a renewal of the contract is presumed on the same terms. Sometimes it is difficult to say whether an engagement of an indefinite kind is by the year, or by the month or week; in such cases, a material fact is how the wages were to be paid, for if they are paid weekly, the presumption will be that the hiring was by the week, unless there are other

circumstances to shew that a yearly hiring was meant. The difference between a yearly contract and a weekly one is, that if the servant is discharged without cause during the year, he is entitled to wages up to the end of the year; and on the other hand, if he leave without cause during the service, he is entitled to no wages at all.

A servant undertakes to have competent skill for the duties of the service, and is bound to use due diligence, and to conduct himself respectfully. He is bound to obey all lawful orders of his master during the engagement, if they are within the scope of the particular service for which he was engaged. Thus, a coachman is not bound to do the duties of a cook, and *vice versa*. Every servant is bound to take due care of his master's property, and he is liable to an action at the suit of his master for gross negligence, and also for fraud and misfeasance. A master is not entitled to chastise a servant, whatever the age of the servant may be, though, in the case of an apprentice under age, a moderate chastisement is justifiable. The grounds on which a servant may be lawfully discharged are wilful disobedience, gross immorality, habitual negligence, and incompetence. If any person entice away a servant, and thereby cause loss to the master, the latter may sue such person for the injury. If the servant is a female, and is seduced, and thereby is unable to continue her service, the master may also bring an action against the seducer for the loss of service caused thereby; and on the same principle a master may bring an action against a third party who causes personal injury to the servant. In the case of the bankruptcy of the master, a preference is given to the servant's wages if due and unpaid, but this extends only to three months' wages, and the servant is an ordinary creditor for the balance beyond that sum. The death of the master is a discharge of the contract; and in many cases, the servant is not entitled to recover wages for the time actually served, though there is an exception as to domestic servants. If a servant is rightfully discharged, he is not entitled to wages for the broken time since the previous periodical payment of wages; and so in the case of the servant's death during the currency of the term, the servant's executors cannot recover payment for the broken time; but it is otherwise in the case of domestic servants. When a servant falls sick, the master is not bound to provide medical attendance whether the servant lives under his roof or not; but as in such cases a doctor is often sent for by the master without any express understanding between the parties, the master is frequently made liable on the ground that the doctor was sent for by and gave credit to the master. As a general rule, the servant takes the risk of all the ordinary accidents attending the particular service; and if he suffer from an accident met with in the course of the service, the master is not liable for the consequences, unless there was some personal negligence on his part. Thus, it often happens that servants are engaged in a manufactory or building where machinery is used and accidents frequently occur. Another case often occurs where two or three servants of the same master are engaged together, and one servant is injured by the negligence of another. In such a case, the rule is, that the injured servant can sue the master, except where the servants at the time were engaged in a common operation, for in the latter case, the servants are or ought to be a check on each other. In cases where a servant injures a third party, the rule is, that the master is liable, provided the servant at the time was acting in the ordinary course of his duty, and within the scope of the master's orders,

expressed or implied. Hence, if a coachman carelessly run down a person on the highway, or do injury to another, the master is liable; but if the coachman was driving the master's carriage without or contrary to the orders of the master, the servant alone is liable. So the master is not in any way responsible for the crimes or criminal offences committed by his servant; every servant must answer for his own crimes. The above are the general rules as regards servants generally; but in England there is a distinction in many instances observed between domestic servants and other servants. The leading distinction is, that if nothing is said as to the length of service, it is presumed that the service can be terminated at any time, on giving a month's notice on either side, or in case of the discharge of a domestic servant without notice, then on payment of a month's wages. It is often popularly thought that a domestic servant cannot be turned out of the master's house at a moment's notice, even on paying a month's wages, but this can always be done with or without cause. In case of discharge without cause, the servant is entitled to demand board-wages for the month. When a servant is discharged, the master cannot be compelled to give a character to the servant; it is entirely optional; but if he does so, then it must be a true one, otherwise an action will lie for defamation. But if a master without malice, and acting *bona fide*, gives an untrue character, he is not liable, for the communication is held to be privileged. If a master knowingly give a false character to a servant who is engaged by a third party on the faith of it, and robs such third party, the latter can sue the former master for the damages. Persons personating masters, and giving false characters, and servants using such false characters, are liable to be summarily convicted, and fined £20.

In general, a servant, if he refuse to enter the service, or leave it without cause, is merely liable to an action of damages for breach of contract, which is no remedy at all, as few servants are worth the expense of a suit. As this conduct, however, might often cause great hardship to masters, especially where they are employed in trade or manufactures, statutes have been passed which give a power to justices of the peace to compel the servant to remain in the service until he give the legal notice to leave. This is done by punishing the servant who leaves the service without just cause by imprisonment; and the dread of this punishment is supposed to act on the servant compulsorily. This power is not competent, as already mentioned, in the case of domestic servants, but is so in regard to all skilled workmen and agricultural servants, as artificers, calico-printers, handicraftsmen, miners, colliers, labourers, &c. The master, on making oath before a justice, can obtain a warrant to arrest absconding servants of this description, and put them in prison, if they have no just cause for absenting themselves.

In *Scotland*, the law as to master and servant differs from the above in several particulars, of which the following are the most important. With regard to domestic servants, the rule is, if nothing is said, that the hiring is for half a year, and cannot be put an end to without forty days' warning before the end of the half year; and if the servant is dismissed without just cause, he or she can claim not only wages but board-wages till the end of the term. In case of the master's death, the servant can claim wages for the whole of the current term, but is bound in that case to serve the executors, or look out for another situation. In case of the master's bankruptcy, the servant is a privileged debtor for the wages of the current term. In most other respects,

the law as to servants is the same as in England. And the statutes which enable justices of the peace to imprison defaulting workmen and artificers, extend to Scotland. See MASTER & SERVANT in Supp.

MASTER-AT-ARMS is a petty officer on board a ship-of-war, charged with the care and instruction in the use of small-arms, except as regards the marines. He is also employed in maintaining discipline, order, and cleanliness among the crew. His assistants in his duties are the 'ship's corporals.'

MASTER OF ARTS (abbreviated M.A., and sometimes, particularly in Scotland, A.M.), is a degree conferred by universities or colleges. In the universities of England, this title follows that of Bachelor (q. v.). It is the highest in the faculty of Arts, but subordinate to that of Bachelor of Divinity. A Master becomes a Regent shortly after obtaining his degree, and thereby obtains the privilege of voting in congregation or convocation at Oxford, and in the senate at Cambridge; and in the Scotch universities, of becoming a member of the General Council. See DEGREE.

MASTER OF COURT is the title given in England to the chief officers under the judges, their duty being to attend the sittings of the courts during term, and make minutes of their proceedings. They also tax all the bills of costs of the parties arising out of the suits and matters before the courts. They are appointed by the chief judge of the court, and hold their offices for life during good-behaviour. Masters in Chancery were similar officers in the Court of Chancery, but were abolished, and the duties are now performed partly by the judge, and partly by the registrars.

MASTER OF THE BUCKHOUNDS, an officer in the Master of the Horse's department of the royal household, who has the control of all matters relating to the royal hunts. A salary of £1700 is attached to the office, which is regarded as one of considerable political importance. The Master of the Buckhounds goes out of office on a change of ministry.

MASTER OF THE CEREMONIES, an office instituted at the court of England in 1603, for the more honourable reception of ambassadors and persons of distinction. The same term was afterwards extended beyond the court, by being applied first to Beau Nash, the famous 'Master of the Ceremonies,' or president of the amusements at Bath, and then to other persons exercising the same function in ordinary assemblies.

MASTER OF THE GREAT WARDROBE, an officer at the court of England, who had, in former times, the superintendence of the royal wardrobe. The office existed from a very early period down to 1782, and was considered a position of great honour. Its duties are now transferred to the Lord Chamberlain.

MASTER OF THE HORSE, the third great officer of the court, who has the superintendence of the royal stables, and of all horses and breeds of horses belonging to the Queen. He exercises authority over all the equerries and pages, grooms, coachmen, saddlers, and farriers, and has the appointment and control of all artificers working for the Queen's stables. He is answerable for the disbursement of all revenues appropriated to defray the expenses of his department; but his accounts are audited and examined by the Board of Green Cloth. He has the privilege of making use of the royal horses, pages, and servants, and rides next to Her Majesty on all state occasions. The office is one of great antiquity, and is considered to be a

position of great honour. The Master of the Horse is appointed during pleasure, by letters-patent; but his tenure of office depends on the existence of the political party in power. The salary is £2500 a year.

MASTER OF THE HOUSEHOLD, an officer in the Lord Steward's department of the royal household, whose specific duties consist in superintending the selection, qualification, and conduct of the household servants. He is under the treasurer, and examines a portion of the accounts. The appointment is during pleasure, and is not dependent on political party. The salary is £1158 per annum.

MASTER OF THE ROLLS, one of the judges of the Court of Chancery in England, who ranks next to the Lord Chancellor, though his decrees may be reviewed by the Lords Justices. He is an ancient officer of the court, and was formerly the chief of the Masters in Chancery. He is the only superior judge in England who can now be elected to represent a constituency in the House of Commons. The Master of the Rolls had originally the custody of the Rolls or Records; in the course of time, this charge became merely nominal, the custody having vested in officers not in his appointment or control; an anomaly which was remedied by 1 and 2 Vict. c. 94, which restored the custody to him with extensive powers. The salary is £7000 a year.

MASTERWORT (*Peucedanum Ostruthium*), a perennial plant of the natural order *Umbellifera*, having a stem from one foot to two feet high, broad bi-ternate leaves, large flat umbels of whitish flowers, and flat, orbicular, broadly margined fruit. It is a native of the north of Europe and the north of America, and is found in moist pastures in some parts of Britain, but apparently naturalised rather than indigenous, its root having formerly been much cultivated as a potherb, and held in great repute as a stomachic, sudorific, diuretic, &c.; its virtues being reckoned so many and great that it was called *divinum remedium*. It still retains a place in the medical practice of some countries of Europe, although, probably, it is nothing more than an aromatic stimulant. The root has a pungent taste, causes a flow of saliva, and a sensation of warmth in the mouth, and often affords relief in toothache.

MASTIC, a species of gum-resin yielded by the Mastic or Lentisk tree (*Pistacia lentiscus*, natural order *Terebinthaceae*). It oozes from cuts made in the bark, and hardens on the stem in small round tear-like lumps of a straw-colour, or if not collected in time, it falls on the ground; in the latter state, it acquires some impurities, and is consequently less valuable. The chief use of this gum-resin is in making the almost colourless varnish for varnishing prints, maps, drawings, &c. It is also used by dentists for stopping hollow teeth, and was formerly used in medicine. It is imported in small quantities, chiefly from the Morocco coast, but some is occasionally brought from the south of Europe.—The name of mastic is also given to oleaginous cements, composed of about 7 parts of litharge and 93 of burned clay, reduced to fine powder, made into a paste with linseed oil.

MASTIFF, a kind of dog, of which one variety has been known from ancient times as peculiarly English, and another is found in Tibet. No kind of domestic dog has more appearance of being a distinct species than this, and it shews little inclination to mix with other races, although the English M. has been in part crossed with the stag-hound and blood-hound. The ENGLISH M. is large and powerful, with a large head, broad

muzzle, large, thick, pendulous lips, hanging ears of moderate size, smooth hair, and a full but not bushy tail. It is generally from 25 to 28 inches high at the shoulder, but a still greater size is sometimes attained. The M. is very courageous, and does not flee even from the lion, for which three or four of these dogs are said to be a match. The Gauls trained British mastiffs, and employed them in their wars. The M. is now chiefly valued as a watch-dog, for which no dog excels it; and whilst it faithfully protects the property intrusted to it, it has the additional merit of refraining from the infliction of personal injury on the invader. It becomes much attached to its master, although not very demonstratively affectionate; it is excelled by many kinds of dog in sagacity. The English M. is usually of some shade of buff colour, with dark muzzle and ears. The ancient English breed was brindled yellow and black.—The M. of TIBET is still larger than the English; the head is more elevated at the back; the skin, from the eyebrow, forms a fold which descends on the hanging lip; the hair is very rough, and the tail bushy; the colour mostly a deep black.

MASTODON, a genus of fossil proboscidean pachyderms, nearly allied to the elephant, but with simpler grinding teeth, adapted for bruising coarser vegetable substances, or perhaps fitted for an animal of a more omnivorous character than its modern representative. The teeth were roughly mammillated, hence the name, meaning teat-tooth. Eleven or twelve species have been described from the Miocene, Pleiocene, and Pleistocene strata in Europe, Asia, and America.

MASULIPATAM, a maritime district of British India, in the presidency of the river Godavary, having the river Kistnah for its south-west boundary. Area, 5000 square miles; pop. 520,866. Along the shore to a distance of 40 or 50 miles inland, the surface is exceedingly low, lower in some places than the shore itself and the beds of the Kistnah and the Godavary, the chief rivers. The commercial crops are chay-root, indigo, tobacco, and cotton. Chief town, MASULPATAM, on a wide bay, in lat. 16° 12' north. Pop. stated at 23,000, who carry on cotton manufactures to some extent.

MA'TADOR (Spanish, 'slayer'). See BULL-FIGHT.

MATAGOR'DA, seaport and bay, on the Gulf of Mexico, at the mouth of the Colorado River, Texas, United States of America, 80 miles west-south-west of Galveston, an important outlet of a country rich in cotton, sugar, rice, &c. The town was destroyed by a storm in 1854, but has been rebuilt, and contains a population of about 2000.

MATAMORAS, a river-port of Mexico, in the department of Tamaulipas, is situated on the south bank of the Rio Grande, 40 miles from the mouth of that river in the Gulf of Mexico. Pop. 20,000. The chief exports are specie, hides, wool, and horses; the chief imports, manufactured goods from Great Britain and the United States.

MATANZAS, a fortified town and seaport on the north coast of the island of Cuba, 55 miles east of Havana, with which it is connected by railway. It is situated in an exceedingly rich and fertile district, has an excellent, well-sheltered harbour, and a pop. of 27,000. After Havana, it is the most important trading-place on the island.

MATARÓ, a flourishing city and seaport of Spain, in the province of Barcelona, 17½ miles north-east by railway from the city of that name. There are here 10 cotton spinning-mills, 7 of which are driven by steam, 21 sailcloth factories, 9 tanneries,

MATCHES—MATE.

with several iron-foundries. Pop. 13,000. At the harbour, there are docks, at which ship-building is carried on.

MATCHES, pieces of various inflammable materials prepared for the purpose of obtaining fire readily. One of the first forms of this useful article was the brimstone match, made by cutting very thin strips of highly resinous or very dry pine-wood, about six inches long, with pointed ends dipped in melted sulphur; thus prepared, the sulphur points instantly ignited when applied to a spark obtained by striking fire into tinder from a flint and steel. This was in almost universal use up to the end of the first quarter of the present century, when several ingenious inventions followed each other in rapid succession, and displaced it so completely that it would be now very difficult to purchase a bunch of brimstone matches. The first of these inventions was the 'Instantaneous-light Box,' which consisted of a small tin box containing a bottle, in which was placed some sulphuric acid with sufficient fibrous asbestos to soak it up and prevent its spilling out of the bottle, and a supply of properly prepared matches. These consisted of small splints of wood about two inches long, one end of which was coated with a chemical mixture prepared by mixing chlorate of potash, six parts; powdered loaf-sugar, two parts; powdered gum-arabic, one part; the whole coloured with a little vermilion, and made into a thin paste with water. The splints were first dipped into melted sulphur, and afterwards into the prepared paste. They were readily inflamed by dipping the prepared ends into the sulphuric acid. There were several disadvantages in this invention, especially those arising from the use of so destructive a material as sulphuric acid, which also had another drawback: its great power of absorbing moisture soon rendered it inert by the absorption of moisture from the atmosphere. The Lucifer match succeeded the above, and differed materially: the bottle of sulphuric acid and all its inconveniences were dispensed with; the match was either of small strips of pasteboard or wood, and the inflammable mixture was a compound of chlorate of potash and sulphuret of antimony, with enough of powdered gum to render it adhesive when mixed with water, and applied over the end of the match, dipped as before in melted brimstone. These matches were ignited by the friction caused by drawing them through a piece of bent sand-paper. So very popular did these become, that although they have since passed away like their predecessors, they have left their name behind, which is popularly applied to other kinds since invented. Next to the Lucifer in importance was the Congreve, which is the one generally used at present. The body of the match is usually of wood, but some, called Vestas, are of very thin wax-taper. The composition consists of phosphorus and nitre, or phosphorus, sulphur, and chlorate of potash, mixed with melted gum or glue, and coloured with vermilion, red-lead, umber, soot, or other colouring material. The proportions are almost as varied as the manufacturers are numerous. The Congreve match requires only a slight friction to ignite it, for which purpose the bottom or some other part of the box is made rough by attaching a piece of sand-paper, or covering it, after wetting it with glue, with sand. Amadou, or German tinder, is largely made into Congreve matches or fuses, as they are often called, for the use of smokers, to light their pipes or cigars. The latest introduction, and the best, is that of Bryant and May, which is properly called the 'Special Safety Match.' With every variety of Lucifer and Congreve, there are certain dangers attending the use, for in both a slight friction will ignite them, and as, from the

very nature of their application, they are apt to be carelessly thrown about, they are consequently exposed to the risk of accidental friction, and have doubtless been the cause of numerous and serious conflagrations. The Congreves are exposed to further risks of accidental ignition arising from the employment of phosphorus, which, from its very inflammable nature, will ignite spontaneously if the temperature is a little higher than ordinary. The match of Messrs Bryant and May, although a new introduction, was invented in Sweden, under the name of the Swedish Safety Match, by a Swede named Lundstrom, a large manufacturer of matches at Jönköping, in 1855 or 1856, and patented in this country by the firm above mentioned. The only essential difference from the Congreves is in leaving out the phosphorus from the composition applied to the match, and instead, mixing it with the sand on the friction-surface, thus separating this highly inflammable material from its intimate and dangerous connection with the sulphur and chlorate of potash. This simple invention seems to have removed all the objections from the use of this class of matches.

Many ingenious inventions have been introduced for making the wooden splints. The square ones, which have always proved to be the best, are cut very simply by two sets of knives acting transversely to each other. The round ones, which always have the fault of weakness, are cut by a perforated steel plate invented in 1842 by Mr Partridge. The perforations are the same size as the splints; and their edges are sufficiently sharp, when pressed on the transverse section of the wood, to cut down through it. The various ornamental forms of the German match-makers, who excel in this manufacture, are produced by planes, the irons of which are so constructed as to plough up splints of the form required. These are usually made of a soft kind of pine-wood—that of *Abies pectinata* is preferred in Austria and Germany—of which vast quantities are yielded by the forests of Upper Austria. Until the introduction of amorphous phosphorus (see PHOSPHORUS), the trade of match-making was fearfully unhealthy; the emanation of phosphoric acid, when common phosphorus was used, gave rise to necrosis, or mortification of the bones, and fatal effects often followed. Too many manufacturers are still using the common kind for cheapness, but others avoid the injury to their work-people by employing the amorphous kind. This, and other dangerous manufactures, demand legislative interference.

The trade in matches has assumed enormous dimensions, especially in Germany, where vast quantities are exported. One firm, having its principal establishment at Gaudenzdorf, near Vienna, employs 2000 persons in this manufacture; more than one firm in England produces ten million Congreve matches per day; and a Birmingham firm manufactures daily eight miles of thin wax-taper, and converts it into Congreve matches. Indeed, so wonderfully has match-making developed itself, that in this country more thousands are now engaged in it than there were hundreds of persons who found employment in making the brimstone matches formerly.

MATCHLOCK. See LOCK.

MATE (allied to *meet*, measured, suitable, conformable, equal, companionable) is an assistant, a deputy, or a second in any work; in this sense, it is a common word in nautical affairs. In the navy, its use is now confined to petty officers, such as boatswain's-mate, gunner's-mate, &c.; but formerly, several officers bore the title, as master's-mate,

now second master, surgeon's-mate, now assistant-surgeon. Until within a few years, the distinctive term *mate* survived, and was applied to a grade between lieutenant and midshipman: the title is now changed to *Sub-lieutenant* (q. v.).

In the merchant-service, the mates are important officers, holding functions not greatly inferior to those of lieutenants in the royal navy. The first mate ranks next to the master or captain, commands in his absence, and is immediately responsible for the state of the vessel; the second and third (and fourth in large well-found vessels) have various analogous duties, the junior mate generally having the superintendence of the stowage of the cargo.

MATÉ, or **PARAGUAY TEA**, a substitute for tea, extensively used in South America, and almost universally through Brazil. It consists of the leaves and green shoots of certain species of Holly (q. v.), more especially *Ilex Paraguayensis*, dried and roughly ground; the leafy portion being reduced to a coarse powder, and the twigs being in a more or less broken state, sometimes, however, as much as an inch in length. The term *maté*, which has by usage attached to this material, belonged originally to the vessels in which it was infused for drinking; these were usually made of gourds or calabashes, often trained into curious forms during their growth. Into the hollow vessels thus formed, a small quantity of the material, more properly called *Yerba de Maté*, is put, and boiling water is added; it is then handed round to those who are to partake of it; and each being provided with a small tube about eight inches in length, with a small bulb at one end, made either of basket-work of wonderful fineness, or of perforated metal, to act as a strainer, and prevent the fine particles from being drawn up into the mouth, dips in this instrument, which is called a *bombilla*, and sucks up a small portion of the infusion, and passes the *maté*-bowl on to the next person. It is usual to drink it exceedingly hot, so much so as to be extremely unpleasant to Europeans. Its effect is much the same as tea, stimulating and restorative; and it derives this property from the presence of a large proportion of the same principle which is found in tea and coffee—viz., *Theine*. The collection and preparation of *maté* is a large industrial occupation in Paraguay and Brazil; and the learned and accurate botanist, Mr John Miers, has proved that not only *Ilex Paraguayensis*, but also *I. curitibensis*, *I. gigantea*, *I. ovalifolia*, *I. Humboldtiana*, and *I. nigropunctata*, besides several varieties of these species are in general use. It is very remarkable that when caffeic acid, to which coffee owes its agreeable flavour, independently of the theine, is treated with sulphuric acid and binoxide of manganese, it forms kinone; and by treating the *maté* with the same agents, kinone has also been obtained.

Upwards of 5,000,000 lbs. of M. are annually exported from Paraguay to other parts of South America; but it is not yet an article of export to other quarters of the world.

Ilex Paraguayensis is a large shrub or small tree; with smooth, wedge-shaped, remotely serrated leaves, and umbels of small flowers in the axils of the leaves. The leaves of many species of holly possess properties very different from those of the M. trees. Some are emetic.

MATERA, a city of the Neapolitan province Basilicata, situated between lovely valleys, 37 miles west-north-west of Taranto. Pop. 13,300. It has an episcopal palace, a cathedral, and a college, but its lower classes are reputed the most uncivilised

of Southern Italy; they dwell chiefly in ancient caverns, excavated in the side of the deep valley surrounding the town, and are much afflicted with cretinism. M. has manufactures of leather and arms, and a trade in nitre and agricultural produce.

MATERIA MÈDICA is that department of the science of medicine which treats of the materials employed for the alleviation and cure of disease. Some writers, as Pereira, divide the subject into the inorganic and the organic, while others, as Christison, adopt an alphabetical arrangement. In the description of an inorganic compound, as, for example, iodide of potassium or calomel, the writer on *materia medica* notices (1), its physical properties; (2), its various modes of preparation; (3), its chemical composition and relations, including the tests for its purity, and the means of detecting its probable adulterations; (4), its physiological action on man and animals in large and small doses; (5), its therapeutic actions and uses, and the average doses in which it should be prescribed; and (6), the official preparations containing the substance in question, and their uses and doses: while in the notice of an article belonging to the organic department, the natural history of the source from whence it is obtained, and the mode of collecting or extracting it, must also be given.

MATERIALISM. This is the name for a certain mode of viewing the nature of mind, namely, to regard it either as mere matter, or as a product of the material organisation. The opposite view is called Spiritualism, and means that the mind, although united with the body, is not essentially dependent on bodily organs, but may have an existence apart from these. There has been much controversy on this question; and although in later times the immateriality of the mind has been the favourite view, and been treated by many as a supposition essential to the doctrine of man's immortality; yet, in the earliest ages of the Christian Church, the materialistic view was considered the most in unison with revelation, and was upheld against the excessive spiritualising tendencies of the Platonic schools. Tertullian contended that the Scriptures prove, in opposition to Plato, that the soul has a beginning, and is corporeal. He ascribes to it a peculiar character or constitution, and even boundary, length, breadth, height, and figure. (This last view is incompatible with the definition of mind. See MIND.) To him, incorporeity was another name for nonentity (*nihil est incorporale, nisi quod non est*); and he extended the same principle to the Deity, who, he conceived, must have a body. He could not comprehend either the action of outward things on the mind, or the power of the mind to originate movements in outward things, unless it were corporeal.

The state of our knowledge at the present time shews us more and more the intimacy of the alliance between our mental functions and our bodily organisation. It would appear that feeling, will, and thought are in all cases accompanied with physical changes; no valid exception to this rule has ever been established. Mind, as known to us, therefore, must be considered as reposing upon a series of material organs, although it be totally unlike, and in fundamental contrast to, any of those properties or functions that we usually term material—extension, inertia, colour, &c. We never can resolve mind into matter; that would be a confounding of the greatest contrast that exists in the entire compass of our knowledge (see MIND); but we are driven to admit, from the whole tenor of modern investigation, that the two are inseparably united within the sphere of the animal kingdom. 'Our consciousness

in this life is an embodied consciousness. Human Understanding and Belief are related, in a variety of ways, to the original and successive states of the bodily organism from birth to death. Observation and experiment prove the important practical fact, that the conscious life on earth of every individual is dependent on his organism and its history' (Professor Fraser, *Rational Philosophy in History and in System*, p. 122).

MATHEMATICAL INSTRUMENTS include all those instruments employed in the determination of the length of lines or the size of angles. Pairs of compasses, surveying-chains, &c., are examples of the former class; while the compass, sextant, theodolite, and the numerous list of astronomical instruments generally denominated telescopes, including the equatorial, transit instrument, mural circle, &c. from the latter class. The more important of these instruments will be treated of under separate heads.

MATHEMATICIANS (Lat. *mathematici*), the name given by the Romans to the professors of astrology, from the fact that, in all cases, those who practised astrology also to some extent cultivated mathematical science. The Romans, unlike the Greeks, appeared not to comprehend the attractions possessed by mathematical studies, and being consequently unable to distinguish between the student of pure science and the fanatic enthusiast who attempted to derive a knowledge of future events on this earth from the position of the stars, joined them together in a common condemnation, under the name of 'mathematici.'

MATHEMATICS (Gr. *mathema*, learning), the science which has for its subject-matter the properties of magnitude and number. It is usually divided into *pure* and *mixed*; the first including all deductions from the abstract, self-evident relations of magnitude and number; the second, the results arrived at by applying the principles so established to certain relations found by observation to exist among the phenomena of nature. The branches of pure mathematics which were first developed were, naturally, *Arithmetic*, or the science of number, and *Geometry*, or the science of quantity (in extension). The latter of these was the only branch of mathematics cultivated by the Greeks, their cumbrous notation opposing a barrier to any effective progress in the former science. Algebra (q. v.), or the science of numbers in its most general form, is of much later growth, and was at first merely a kind of universal arithmetic, general symbols taking the place of numbers; but its extraordinary development within the last two centuries has established for it a right to be considered as a distinct science, the *science of operations*. Combinations of these three have given rise to *Trigonometry* (q. v.) and Analytical Geometry. The Differential and Integral Calculus (q. v.) makes use of the operations or processes of geometry, algebra, and analysis indifferently; the *calculus of finite differences* is in part included under algebra, and may be considered as an extension of that science; and the *calculus of variations* is based upon the differential calculus. The term 'mixed mathematics' is calculated to lead to error; 'applied mathematics' is a more appropriate name. This portion of mathematics includes all those sciences in which a few simple axioms are mathematically shewn to be sufficient for the deduction of the most important natural phenomena. This definition includes those sciences which treat of pressure, motion, light, heat, sound, electricity and magnetism—usually called *Physics*—and excludes chemistry, geology, political economy, and the other branches of science, which, however, receive more or less aid from mathe-

matics. For a notice of the separate sciences, see **ASTRONOMY, OPTICS, MECHANICS, HYDROSTATICS, HYDRODYNAMICS, HEAT, ACOUSTICS, ELECTRICITY, MAGNETISM, &c.**

MATHER, INCREASE, an American colonial divine, son of Richard Mather, an English nonconformist minister, who emigrated to Massachusetts in 1635, was born at Dorchester, Massachusetts, January 21, 1639. He was educated at Harvard College, Massachusetts, and Trinity College, Dublin, and settled for 62 years as pastor of the North Church, Boston. In 1684, he was also chosen president of Harvard College, for which he obtained the right to confer the degrees of B.D. and D.D. An industrious student, he spent 16 hours a day in his study, and published 92 separate works, most of which are now very scarce. One of these, entitled *Remarkable Providences*, was republished in the Library of Old Authors (London, 1856). His influence was so great in the colony, that he was sent to England in 1688 to secure a new charter, and had the appointment of all the officers under it. M. died at Boston, August 23, 1723.

MATHER, COTTON, an American colonial divine, son of the above, was born at Boston, February 12, 1663. He entered Harvard College when 12 years old, and his precocity and piety excited great expectations. He entered upon a course of fasting and vigils, cured a habit of stammering by speaking with 'dilated deliberation,' studied theology, became the colleague of his father in the ministry, and wrote in favour of the political ascendancy of the clergy. The phenomenon termed 'Salem Witchcraft' having appeared in the colony, he investigated it, and wrote, in 1685, his *Memorable Providences relating to Witchcraft and Possessions*. He found that devils or possessed persons were familiar with dead and foreign languages, &c., and eagerly advocated the adoption of desperate remedies for the diabolical disease. It is well known that M. was responsible for the shedding of much innocent blood; and he himself admitted that 'he had gone too far.' In 1692, he published *Wonders of the Invisible World*, to which a reply appeared at London in 1700 by Robert Calet—the effect of which was to dissipate the sombre and superstitious influence of the New England divine. With a remarkable industry, he wrote 382 works. His *Essays to do Good* have been highly commended by Franklin; and when we think of his misdeeds, which were serious, it ought also to be remembered that he helped to introduce into the States inoculation for the smallpox. He died February 13, 1728. His life was written by his son, Samuel Mather (1729).

MATHEW, REV. THEOBALD, commonly known as **FATHER MATHEW**, was descended from an illegitimate branch of the Llandaff family, and was born at Thomastown in Tipperary, Ireland, October 10, 1790. On the death of his father, while M. was still very young, the kindness of the Llandaff family enabled the boy to enter the Catholic college of Kilkenny, whence he was transferred, as a candidate for the Roman Catholic priesthood, to the college of Maynooth, in 1807. He left that college, however, in the next year. He relinquished the secular priesthood for that of the religious order of the Capuchins, in which he took priest's orders in 1814, and was sent to the church of his order in the city of Cork. His singularly charitable and benevolent disposition, his gentleness and affability, his simple and effective eloquence, and the zeal and assiduity with which he discharged all the duties of his ministry, won for him the universal love and respect alike of rich and of poor. To him was due the introduction of the religious brotherhood of

St Vincent of Paul. He founded schools for children of both sexes, and contributed, in a very marked degree, to the correction of many abuses and indecencies connected with the burial of the dead, by establishing a new cemetery on the model of that of Père la Chaise, although, of course, of a far less pretentious character. But the great work of Father M.'s life is the marvellous reformation which he effected in the habits of his fellow-countrymen, and which has won for him the title of APOSTLE OF TEMPERANCE. In 1833, he established an association on the principle of total abstinence, at first confined to the city of Cork, but afterwards numbering 150,000 members in the city alone, and extending to the county and the adjacent districts of Limerick and Kerry. The marvellous success which attended this first local effort, led to the suggestion that Father M. himself should repair to the several great centres of population, especially in the South. Thence he gradually extended the field of his labours to Dublin, to the North, and even to Liverpool, Manchester, London, Glasgow, and the other chief seats of the Irish population, even in the New World itself. His success had something almost of the marvellous in its character. The form of engagement partook of the religious, and was accompanied by the presentation of a medal, to which the utmost reverence was attached by the recipient; and an opinion prevailed among the poor, that the mission of the 'Apostle of Temperance' was marked by many miraculous manifestations of the assistance of Heaven. It is difficult to form an exact estimate of the number of his association; but it included a large proportion of the adult population of Ireland, without distinction of rank, creed, or sex; and so complete was the revolution in the habits of the Irish people, that very many distilleries and breweries ceased from working. Among the sufferers from this great moral revolution, the members of Father M.'s own family, who were largely engaged in the distilling trade, were some of the earliest and most severely visited; and it is painful to have to add, that the latter years of this great benefactor of his country were embittered by pecuniary embarrassments arising out of the engagements into which he entered in the course of his philanthropic labours. Although very large sums of money passed through his hands, in payment for the medals which were distributed to the members of the association, yet the exceeding munificence of his charities, and the enormous expenses connected with his various missions, and perhaps his own improvident and unworldly habits, involved him in painful difficulties. A pension of £300 was granted to him by the crown, in acknowledgment of his eminent public services, and a private subscription was also entered into for the purpose of releasing him from embarrassment. He died in 1856; but the fruit of his labours is still visible in Ireland. Very many, it is true, of those who were enrolled in his association ceased after some years to observe the pledge of total abstinence; but very many also continued faithful; and while but few of those who abandoned the society relapsed into the extreme of drunkenness, the general tone of the public mind in Ireland, as regards the use of intoxicating drinks, may be truly said to have undergone a complete revolution, which endures to the present day.

MATHEWS, CHARLES, an English comedian, was born on the 28th June 1776, and was educated in London. His father was a bookseller, and intended his son to follow the same profession; but his early inclination for the stage overcame parental counsel, and he made his first appearance as an amateur—curiously enough, in the part of Richard III.—at the Richmond Theatre in 1793,

and as a professional comedian in the Theatre Royal, Dublin, the following year. He first appeared in London at the Haymarket, and subsequently he transferred his services to Drury Lane. In 1818, he gave his 'At Home' in London, and achieved an immense success. He visited America twice. In the autumn of 1828, he became joint-proprietor of the Adelphi Theatre. He died at Plymouth on the 28th June 1835, and was buried in that town.

M. was a wonderful master of personification and mimicry; and while imitating every one, he never lost a friend, or hurt the feelings of the most sensitive. His taste was as instinctive as his wit. His wonderful variety of facial expression, and his gentlemanly sarcasm, are still fondly remembered by old playgoers. His son CHARLES, born in the early part of the present century, has also achieved a brilliant reputation in the same department of histrionic art.

MATHIAS CORVINUS, king of Hungary, was the second son of John Hunyady (q. v.), and was born in 1443. Having been released from the hands of the treacherous Frederick III. of Germany by Podiebrad, king of Bohemia, he returned to Hungary, and was elected king in 1458. His accession was hailed with the utmost enthusiasm over the whole country. But the Hungarian crown at this time was no chaplet of roses; two sovereigns, alike formidable, the one, Mohammed II., from his military talents and immense resources, the other, Frederic III., from his intriguing policy, were busily conspiring against the boy-king. To meet these dangers, M. rapidly carried out his measures of defence, the most important of which was the formation of a regular force of cavalry, to form which, one man was enrolled out of every twenty families. This was the origin of the term 'Hussar,' which means in Hungarian 'the price or due of twenty.' M. fell on the Turks, who had ravaged the country as far as Temesvar, inflicted upon them a bloody defeat, pursued them as far as Bosnia, took the stronghold Jajcza, where he liberated 10,000 Christian prisoners, and thence returned to Weisenberg, where he was crowned with the sacred crown of St Stephen in 1464. He next suppressed the disorders of Wallachia and Moldavia; but feeling that his plans were counteracted by the intrigues of Frederic III. to gain possession of Hungary, M. besought the assistance of Pope Pius II., but to no purpose. After a second successful campaign against the Turks, he turned his attention to the encouragement of arts and letters, and adorned his capital with the works of renowned sculptors, in addition to a library of 50,000 volumes. He sent a large staff of literary men to Italy for the purpose of obtaining copies of valuable manuscripts,* and adorned his court by the presence of the most eminent men of Italy and Germany. He was himself an author of no mean ability, and he possessed a delicate appreciation of the fine arts. At the same time, the affairs of government were not neglected. The finances were brought into a flourishing condition, industry and commerce were promoted by wise legislation, and justice was strictly administered to peasant and noble alike. But the promptings of his ambition, and the pressure exercised by the Catholic party, cast an indelible blot on M.'s otherwise spotless escutcheon; he wantonly attacked Podiebrad, his father-in-law, the Hussite king of Bohemia, and after a bloody contest of seven years' duration between these kings, the greatest generals of the age, the Hungarian power prevailed, and Moravia, Silesia, and Lusatia were wrested from

* Even at the present day, the remains of the celebrated *Collectio Corvina* are eagerly sought after.

Bohemia. Immediately after the conclusion of this war, M. went to meet his old enemies, the Turks, and inflicted upon them, at Kenyermész (1479), such a defeat as kept them quiet for the next 46 years. After defeating an invading army of Poles, he had at length a fair opportunity for settling his differences with Frederick, and taking revenge on the insidious plotter who had embittered his whole life. The Austrian fortresses fell before him in rapid succession. After an obstinate defence, Vienna shared the same fate (1485), and the emperor was reduced to beg his bread from village to village. M. now took up his residence in Vienna, but while on the pinnacle of glory, he was struck down by a fit of apoplexy, and died at Vienna in 1490. To the patriotism and bravery of his father, M. added a taste for letters, and the highest abilities as an administrator and politician; even his secret enemy, Castelli, testifies 'that for subtlety and daring he had no equal among the princes of the age.'

MATHILDA, Countess of Tuscany, well known in history through her close political connection with Pope Gregory VII., was a daughter of Boniface, Count of Tuscany, and was born in 1046. She is said to have married Godfrey (surnamed *Il Gobbo*, or the 'Hunchback'), Duke of Lorraine, in 1069, by procuration; but if so, her husband did not make his appearance in Italy until four years after the wedding-ceremony, and the two, if they were ever united, soon afterwards separated. Godfrey went back to his duchy, and became a supporter of the Emperor Henry IV., while M. made herself conspicuous by the zeal with which she espoused the cause of Gregory VII. She became his inseparable associate, was ever ready to assist him in all he undertook, and to share every danger from which she could not protect him. In 1077 or 1079, she made a gift of all her goods and possessions to the church. In 1081, she alone stood by the pope, when Henry poured his troops into Italy, burning to avenge his humiliation at Canossa; she supported him with money when he was besieged in Rome; and after his death at Salerno, boldly carried on the war against the emperor. She died at the Benedictine monastery of Polirone in 1115. M.'s death gave rise to new feuds between the emperor and Pope Paschal III., on account of her gift to the church, which finally resulted in the former wresting from the latter a portion of M.'s possessions, but even what remained constituted nearly the whole of the subsequent 'Patrimony of Peter.'

MATHURA. See **MUTTRA**, in SUPPLEMENT.

MATICO (*Artanthe elongata*), a shrub of the natural order *Piperaceae*, a native of Peru, remarkable for the styptic property of its leaves, which are used for stanching wounds, and are also useful as an aromatic stimulant in mucous discharges of various kinds.

MATINS. See **CANONICAL HOURS**.

MATRICARIA. See **CHAMOMILE**.

MATTER. From a physical point of view, matter is anything that can affect the senses, or that can exert, or be acted on by, force. The existence of matter, in the sense of *substance*, has been doubted by many philosophers, including some of the greatest of experimenters. Indeed, as we can know matter only by the forces it exerts, it is obvious that the supposition of mere geometric points, capable of exerting force (technically called *Centres of Force*), will as satisfactorily account for all observed phenomena as any other idea of the ultimate nature of matter. Here, however, we are dealing with a question confessedly beyond the reach of experiment, and belonging to the domain with which metaphysics professes to deal. See **PERCEPTION**.

Although experiment cannot lead to a knowledge of the ultimate nature of matter, it may lead to important discoveries as to the arrangement of the molecules of different bodies, and their similarity or dissimilarity. Some of the questions to which we may expect an answer, though not a speedy one, have already been mentioned in the article **FORCE**, **CONSERVATION OF**; but in order to render intelligible the short account which we intend to give of some very interesting ideas recently propounded by Graham (q. v.), it will be necessary to repeat some of them.

The old idea of the transmutation of metals (see **ALCHEMY**) implicitly contains the assumption that all kinds of matter are ultimately one. Far from being a startling assumption, this is the simplest and most easily conceived notion we can entertain on the subject; and it offers a remarkably simple explanation of that extraordinary property of matter which Newton proved by careful experiments, that the weight of a body depends only on the quantity, not on the quality of the matter that composes it. One idea, then, of matter is, that the atoms (or smallest parts, whatever these may be) of all bodies are identical, but that the molecules (each of which is a single atom, or a definitely arranged group of atoms) differ from one body to another. Thus (to take an instance merely for *explanation*, not as at all likely to be correct), if hydrogen be supposed to consist of the simple atoms of matter; oxygen, each molecule of which is eight times as heavy as one of hydrogen, may have each molecule formed of eight elementary atoms, arranged in a group such as the corners of a die; carbon, six times as heavy per molecule, might be composed of six simple atoms grouped as at the corners of an octahedron; and so on. It is obvious that here each atom must be supposed capable of exerting force on every other. This leads us naturally to speculations as to the medium through which this force, if it be exerted at a distance, is propagated (see **FORCE**, **CONSERVATION OF**); and then we have introduced matter of a more refined character than our supposed elementary atoms. This difficulty has suggested to various philosophers the idea, that there is no *actio in distans*, that all pressure, for instance, in a gas is due to incessant impacts of its particles upon each other and upon the containing vessel. But from various experimental results, we know that *this* species of motion is capable of being transferred from one body to another, of being increased or diminished by change of temperature, and is, in fact, *Heat* itself, one form of kinetic energy. This, if there be no ultimate difference between kinds of matter, could never be the cause of their apparent difference. Hence, in Graham's view, though all ultimate atoms are identical in substance, they have special motions of their own, by which one is distinguished from another, these motions not being capable of transfer from one atom or group of atoms to another. It is difficult to conceive energy in such a form as not to be transferable, so that we refer the reader to Graham's own papers for the further development of his theory—remarking, in conclusion, that no theory of the nature of matter can be considered as at all complete till it account for the mutual action of separate atoms; for this the existence of a *continuous* material medium in space would seem to be necessary; and this, in its turn, would, if accepted, enable us to dispense with the idea of atoms. In connection with this, we may mention that W. Thomson has recently shewn that mere heterogeneity (which we know exists in matter), together with gravitation, is sufficient to explain all the apparently discordant laws of molecular action; matter being supposed, in

this theory, to be continuous but of varying density from point to point.

MATTHEW, SAINT, an apostle and evangelist, was a publican or tax-gatherer at the Sea of Galilee. It is assumed by divines generally, that he is the same person that Mark and Luke refer to under the name of 'Levi'; but several weighty names are against this view, as, for example, Origen, Grotius, Michaelis, and Ewald. After the ascension of Christ, M. is found at Jerusalem; he then disappears from Scripture. Nothing whatever is known of his career.—M.'s GOSPEL is believed to be the first in point of time. Irenæus places its composition in the year 61 A. D.; some of the later Fathers, as early as 41 A. D. The obvious design of the work is to prove the Messiahship of Jesus; hence the frequency of the expression used in regard to the acts of the Saviour, 'that it might be fulfilled which was spoken by the prophet.' Much controversy has been carried on regarding the language in which St M. wrote his gospel. The opinion of the ancient church generally (founded on a passage in Papias, Bishop of Hierapolis in the 2d century) was, that M. wrote it in Hebrew, or rather in that mixture of Hebrew, Chaldee, and Syriac spoken in Palestine in Christ's time, and known as Aramaic. Erasmus doubted this, and held that M. only wrote the one we now possess. His view was supported by Calvin, Beza, and others of the reformers; and more recently, in some form or other, by the great majority of scholars, both orthodox and heterodox. Still more recently, the opinion of Bengel, that M. wrote first a Hebrew gospel, and then translated it into Greek, has been advocated by several able writers. The passage in Papias is by no means clear; and some of the greatest grammarians and biblicists, such as Lachmann, Ewald, Meyer, Reuss, and Credner, understand it to mean that M. only drew up a series of notices of Christ's life and sermons, which were afterwards arranged in some sort of order by another writer. Even yet, however, the order is but dimly perceptible, and little or no attention is paid to chronological sequence. On this view, the present gospel is M.'s in substance only, and not in form. The style is comparatively tame, and even the conception of Christ which is predominant is earthly rather than divine. Hence, the Fathers called it the *Somatic* or 'bodily' gospel, as distinguished from the more spiritual gospels of Luke and John.

MATTHEW OF WESTMINSTER, an early English chronicler, who flourished in the reign of Edward II., but of whom nothing whatever is known, except that he was a monk of the Benedictine Abbey of Westminster. His history or chronicle is written in Latin, and is entitled *Flores Historiarum, per Matthæum Wesmonasteriensem collecti, præcipue de Rebus Britannicis, ab Exordio Mundi, usque ad annum 1307* (Flowers of History gathered by Matthew of Westminster, chiefly concerning the affairs of Britain, from the Beginning of the World down to the year 1307). That part which treats of English history from the Conquest to the close of Edward I.'s reign is considered valuable, on account of the manifest diligence, accuracy, and honesty of the writer. The work was first printed at London in 1567, and again (with additions) at Frankfurt in 1601. Bohn has published a translation into English (2 vols. 1853).

MATTO or **MATO GROSSO** (*dense forest*), a province of Brazil, bordering on Bolivia. Area, 406,500 square miles; population estimated at 100,000, mostly Indians. Chief rivers, the Madeira, Jurumá, and Faraguay, with their numerous

affluents. Its soil is fertile, but there is almost no cultivation. Dense forests cover immense tracts of the country. Gold and diamonds abound, and indeed the mineral riches of the province have hitherto formed the chief barrier to its progress. Diamonds and gold, with a quantity of ipecacuanha, are the whole exports. Manufactured goods are imported.

MAUL See SANDWICH ISLANDS.

MAULMAIN, or **MOULMEIN**, a flourishing seaport of the Tenasserim provinces, on the south-east shore of the Bay of Bengal, at the mouth of the Salwyn, lat. 16° 30' N., long. 97° 43' E. Pop. about 20,000, among whom are a considerable number of Europeans. There are here seven Christian churches, eight English and native schools, and three printing-presses. It is the seat of a flourishing trade with Calcutta, Madras, Rangoon, and Penang. In the vicinity are extensive forests, which furnish an abundant supply of teak, and ship-building is carried on to a considerable extent. M. exports grain, timber, ivory, wax, stick-lac, oils, gums, &c.; cotton and silk goods, wine, beer, tobacco, sugar, arms, &c., are imported. In the year 1860—1861, the principal imports of M. amounted in value to 5,302,341 rupees. In 1826, when this region was ceded to the British, the site of M. was a wild jungle, overrun by tigers. The temperature is comparatively temperate, even in the hot season, seldom rising higher than 90° in the shade.

MAUNDY-THURSDAY, the Thursday of Holy Week (q. v.). The name is derived from *mandatum*, the first word of the service chanted at the washing the feet of pilgrims on that day, which is taken from John xiii. 34. The washing of the pilgrims' feet is of very ancient usage, being referred to by St Augustine; and, both in ancient and modern times, it was accompanied by a distribution of 'doles,' which were handed to the pilgrims in small baskets, thence called 'maunds.' In the royal usage of the maund in England, the number of doles distributed was reckoned by the years of the monarch. They are usually given by the Lord High Almoner; but James II. performed the ceremony in person. The distribution of doles was retained till the year 1833, since which period the 'Maundy' men and women receive a money-payment from the Clerk of the Almonry Office, instead of the dole. In most mediæval countries, the maund was held in all the great houses; and in England, in the Household Book of the Earl of Northumberland, which begins in 1512, there are entries of 'al maner of things yerly yevin by my lorde of his Maundy and my laidis and his lordshippis children.'

MAUPERTUIS, **PIERRE LOUIS MOREAU DE**, a French mathematician, was born at St Malo in 1698. He early displayed a love of mathematics, and after serving in the army for five years, withdrew from it to pursue his favourite studies. His able advocacy of Newton's physical theory, in opposition to that of Descartes, gained him general favour in Britain, and he was admitted to the Royal Society of London in 1727. In 1736, he was placed at the head of the Academicians whom Louis XV. sent to Lapland, to obtain the exact measurement of a degree of longitude, whilst the same thing was also being done in Peru by Condamine. This operation he described in his work, *De la Figure de la Terre, déterminée par les Observations de M. Clairaut, Camus, &c.* (Par. 1738). In 1740, he went to Berlin, on the invitation of Frederick II., to be President of the Academy there; but having accompanied the Prussian army to the field, was taken prisoner at Mollwitz by the Austrian hussars,

and sent to Vienna in 1741. He returned to Berlin shortly afterwards, and resumed his former office; but his morbid *amour-propre* and tyrannical disposition excited general dislike. Among others, M. attacked Voltaire; but the latter applied the lash of satire so vigorously, that M. was perforce compelled to return to France in 1756. In 1758, he went to Basel, for the sake of his health, and to enjoy the society of the Bernoullis, but died soon after, 27th July 1759. M. was a mathematician of ordinary ability, but a very inferior philosopher, and owed his celebrity more to the idiosyncrasies of his manners and disposition than to his merit.

MAURICE, PRINCE OF ORANGE and COUNT OF NASSAU, one of the most skilful and distinguished generals of his age, was the son of William I., Prince of Orange, and was born at Dillenburg, 14th November 1567. After his father's assassination in 1584, the provinces of Holland and Zealand, and afterwards Utrecht, elected him their stadtholder. A great portion of the Netherlands was still in the hands of the Spaniards; but under the admirable leadership of M., the Dutch rapidly wrested cities and fortresses from their enemies. In 1591, Zutphen, Deventer, Nimeguen, and other places fell into their hands; in 1593, Gertruydenberg; and in 1594, Gröningen. In 1597, with the help of some English auxiliaries, he defeated the Spaniards at Turnhout in Brabant, and in 1600 won a splendid victory at Nieuport. Finally, in 1609, Spain was compelled to acknowledge the United Provinces as a free republic. The ambition of M., however, was excited to the desire of sovereignty; but in this, notwithstanding the love and respect with which he was regarded by the people, he finally failed. See **BARNEVELDT**. He died at the Hague, 23d April 1625.

MAURICE, REV. FREDERICK DENISON, M.A., a distinguished divine of the Church of England, and one of the most influential thinkers of his age, is the son of a Unitarian minister, and was born in 1805. His reputation at the university for scholarship stood high, but being at this time a dissenter, and otherwise not in a position to sign the Thirty-nine Articles, he left Cambridge without taking a degree, and commenced a literary career in London. To this period belongs his novel entitled *Eustace Conyers*. He also wrote for the *Athenæum*, which had then been recently started by James Silk Buckingham. After the lapse of two years, a change came over his religious sentiments and opinions; his spirit was profoundly stirred and influenced by the speculations of Coleridge, and he now resolved to become a clergyman of the Church of England. He did not, however, return to Cambridge, but proceeded to Oxford, where he took the degree of M.A., and was ordained a priest about 1828. Since then, the aim of his whole life has been the interpretation of Christianity in accordance with the most pure and spiritual conceptions of our nature; nor have his labours been without result. At this moment, there is probably no clergyman in the United Kingdom more deeply revered and loved than he is by a large body of the thoughtful and cultivated portion of the religious laity. He has also succeeded in gathering round him, *within* the church, a large number of adherents, especially among the younger clergy, who constitute what is commonly called the 'Broad Church' party, though its members repudiate any sectional tendency, and do not associate for the purpose of carrying out any sectional schemes, like the 'Evangelicals' and Tractarians. M.'s theological opinions, especially on the question of the atonement, are not considered 'sound' by the 'orthodox' portion of the

clergy; and the publication of a volume of *Theological Essays*, in which, among other heresies, he took the charitable view of future punishments, lost him the Professorship of Theology in King's College, London. For many years, M. was chaplain of Lincoln's Inn, but in 1860 he was appointed incumbent of the district church of Vere Street, Mary-le-bone. He has always been a warm and enlightened friend of the working-classes, and founded the first Working-man's College in London. M. is one of the most voluminous authors of his age. All his works are written in the most exquisite and pellucid English, and display a beauty and tenderness of Christian sentiment that are nearly faultless, but united with a subtlety of thought that frequently passes into mysticism, and makes his opponents pronounce him unintelligible. His principal productions are his *Mental and Moral Philosophy*, *Religions of the World*, *Prophets and Kings of the Old Testament*, *Patriarchs and Lawgivers of the Old Testament*, *The Kingdom of Christ*, *The Doctrine of Sacrifice*, *Theological Essays*, *Lectures on the Ecclesiastical History of the First and Second Centuries*, and *Gospel of St John*.

MAURICIUS, one of the greatest of the Byzantine emperors, was descended of an ancient Roman family, and was born at Arabissus, in Cappadocia, about 539 A. D., and executed November 27, 602. During the reigns of Justin II. and Tiberius, M. served in the army, and in 578 was appointed by the latter emperor to the command of the army against the Persians, in which office he gained the universal esteem of his soldiers, notwithstanding the severity of his discipline, and surpassed the emperor's hopes by humbling to the earth the most dangerous enemy of the eastern empire. In 582, he obtained the rare honour of a triumph at Constantinople, and in August of the same year succeeded Tiberius on the throne. Immediately after his accession, the Persians invaded the Byzantine territories; an army was sent to repel them, and the war between the empires soon became general; a fierce contest of eight years' duration, which, chiefly owing to the internal convulsions that distracted Persia, resulted in favour of the Byzantines. The king of Persia, Khusru II., driven from his throne, fled to Hierapolis, whence he sent to M. a letter beseeching shelter and aid. The emperor's generous nature was not proof against such an appeal: an army was immediately assembled, to which the loyal Persians flocked from all quarters; and in 591, Khusru was restored to his throne, giving up to M., in evidence of his gratitude, the fortresses of Dara and Martyropolis, the bulwarks of Mesopotamia. Some time after these events, a war broke out with the Avars; and after two years of bloody conflict, with little gain to either side, the Byzantines suffered a severe defeat, and 12,000 veterans were taken prisoners. M. refused to ransom them, and they were consequently put to death. M.'s conduct has been satisfactorily accounted for (see Gibbon's *Decline and Fall*), but it excited a deep and lasting resentment amongst the people and the army; and in 602, when the emperor ordered his troops to take up their winter-quarters on the north (or Avarian) side of the Danube, they broke out into open revolt, elected Phocas for their chief, and marching upon Constantinople, raised him to the throne. M., with all his family and many of his friends, was put to death. He was a general of rare ability, and little inferior as a ruler.

MAURITANIA, or MAURETANIA, the ancient name of the most north-western part of Africa, corresponding in its limits to the present sultanate of Morocco and the western portion of Algiers. It

derived its name from its inhabitants, the *Mauri* or *Maurusi*. See *MOORA*. It reached on the south to the Desert, and was separated from Numidia on the east by the river Mulucha or Molochath, now the Muluya.

MAURITIA, a genus of palms, having male flowers and female or hermaphrodite flowers on distinct trees, imperfect spathes, and fan-shaped leaves. They are all natives of the hottest parts of America. Some of them, like the Buriti (q. v.) Palm (*M. vinifera*), have lofty columnar smooth stems; others are slender, and armed with strong conical spines. The *MIRITI* Palm (*M. flexuosa*) grows to the height of 100 feet; it has very large leaves on long stalks. The stem and leaf-stalks are used for various purposes. A beverage is made from the fruit, as from that of the Buriti Palm and several other species.

MAURITIUS, or ISLE OF FRANCE, an island of the Indian Ocean, belonging to Great Britain, lies in lat. 19° 58' to 20° 33' S., and long. E. from Greenwich 57° 17' to 57° 46'. It contains about 708 square miles; pop. (1861), including the small dependencies of Seychelles, Rodrigues, &c., 322,517; 98,042 of whom are engaged in agriculture, 38,145 in commerce, trade, and manufactures. Of the whole population, 5000 were British; more than two-thirds of the remainder were of the coloured races. The surface is of varied formation, a great portion being volcanic; while its coast is fringed by extensive coral reefs, pierced in several places by the estuaries of small streams. Its mountains, although of no great height, are marked by the usual irregularities observed in volcanic formations. Of these, the most celebrated is the Peter Botte, situated in the rear of the town of Port Louis, and forming a remarkable cone, sustaining on its apex a gigantic piece of rock, which has the appearance of being poised upon its summit with the nicest precision. In the island are the remains of several small craters, and the traces of lava are numerous. The principal towns are Port Louis, the capital, and Grande Port, or Mahébourg, the southern port, the latter difficult of access for shipping, and much encumbered with coral reefs. Port Louis comprises a spacious harbour, and is provided with an inner basin, denominated the Fanfaron, wherein vessels can take refuge during the hurricanes, which occasionally occur here with exceeding violence. There is also a slip upon which large vessels can be raised for the purpose of examination and repair.

M. produces annually a large amount of sugar, which it exports to England, France, and Australia. The nature of the soil, however, in many parts prevents a more universal development of the culture of this article of commerce. In some districts, considerable tracts of cane-growing land are encumbered with large boulders; in many places, these have been collected into rough walls, between which the canes are planted, while in others their size precludes their removal. The method employed in the cultivation of the cane is similar to that adopted in the West Indies; but the bulk of the sugar is ultimately shipped in bags composed of the leaf of the *Vacoua* palm. The climate of this island is remarkably fine. There are four seasons, as in England; but the temperature in the months of November, December, and January is very high. Throughout the year, the thermometer ranges from 76° to 90° in the shade. In some of the more elevated districts, however, the climate resembles that of the hills of India, and the thermometer usually stands 7° or 8° lower than in Port Louis. The southern portion of the island, called La Savanne, is exceedingly beautiful, and diversified

with mountain and ravine, clothed with luxuriant wood. The mountains themselves are bold and fantastic, and present every possible form of outline. Few communities present so varied an admixture as that of Mauritius. The descendants of the original French inhabitants represent a considerable portion of the influential classes; government officials and merchants, or planters of English birth or extraction, make up the remainder. In Port Louis may be seen representatives of almost every eastern nation. Many Chinese find their way here, and there is now scarcely a hamlet that has not its Chinese storekeeper. The Creoles, or native coloured population, who derive their colour from the African and Malagash slaves, form a very considerable portion of the inhabitants. Emigration of coolies from British India, for the supply of the sugar-plantations, is in active progress; and the recent passing of the measures for the introduction of railways, which are in course of formation, has had the effect of drawing public attention to this colony, which, small as it is, forms a very important accessory to the British possessions. The revenue for 1861 amounted to £553,419, the expenditure to £500,854. In 1860, 1523 vessels, of 603,082 tons, entered and cleared the ports of the island. The imports of the same year amounted to £2,769,209, the exports to £2,259,640. The chief imports were live-stock (for which M. is chiefly dependent on Madagascar and the Cape), rice, specie, manure (guano), wine, grain, and machinery. The principal exports were sugar (value, £2,109,166), copper, and rum. The island contained, in 1860, 296 sugar-mills, 59 lime-kilns, 25 distilleries, and 15 quarries.

M. was discovered in the year 1505, by the Portuguese commander, Don Pedro Mascaregnhas, and was subsequently visited by the Dutch under Van Neck in 1598, who gave the island its present name in honour of Prince Maurice. The Dutch formed a settlement here in 1644, but subsequently abandoned it. A new and more successful attempt to form a permanent establishment was made by the French in 1721, already in possession of the adjacent island of Bourbon, who re-named it 'l'Île-de-France.' M. remained in French hands until near the close of the year 1810, when it was taken by the British in an expedition under General Abercromby, and has since remained a British possession.

MAUROCORDATOS, also **MAVROCAR-DATO**, a Fanariote family, distinguished for ability and political influence, and descended from merchants of Chios of the Genoese family of Scarlati.—**ALEXANDER M.** was professor of medicine and philosophy in Padua, and became dragoman or interpreter to the Porte in 1681, in which capacity he did much to promote the interests of his countrymen. In 1699, he displayed great diplomatic talents as plenipotentiary of the Porte in the negotiations for peace at Carlowitz.—His son, **NICOLAS**, was the first Greek who was Hospodar of Moldavia and Wallachia.—**CONSTANTINE**, brother of Nicolas, who became Hospodar of Wallachia in 1735, abolished slavery in that country, and introduced the culture of maize.—His grandson, **ALEXANDER**, Prince M., born at Constantinople in 1787, took an active part in the Greek contest for independence, prepared the declaration of independence and the plan of a provisional government, was elected president of the executive body; and being appointed commander-in-chief, undertook, in 1822, an expedition to Epirus, which ended in the unsuccessful battle of Peta; but he delivered the Peloponnese by his bold and resolute defence of Missolonghi (1823). Notwithstanding the opposition of the party

of Colocotronis and Dimitrios Ypsilanti, he was able afterwards to render important services to his country—as, for instance, by the heroic defence of Navarino and Sphacteria; but became very much involved in political strife. He was a steadfast admirer of English policy and institutions, and a fierce opponent of the pro-Russian government of Capo D'Istria. After the accession of King Otho, he was at different times a cabinet minister and ambassador at different courts. The leading feature of his policy—viz, his endeavour to promote British influence—made him at times very unpopular among his countrymen. Yet, at the outbreak of the Crimean War, it was found necessary to place him once more at the head of the government—a dignity, however, which he soon resigned; but he continued to interest himself in the cause of education, and as late as 1861 held the office of minister of public instruction. He died August 1865.

MAURY, MATTHEW FONTAINE, LL.D., an American naval officer, astronomer, and hydrographer, was born in Virginia, January 14, 1806. In 1825, he was appointed midshipman in the United States navy, and during a voyage round the world in the *Vincennes* frigate, commenced a treatise on navigation, which is adopted as a text-book in the navy. In 1836, he was made lieutenant; but being lamed by an accident, and unfitted for service afloat, he was appointed to the Hydrographical Office at Washington. Here he carried out a system of observations which enabled him to write his *Physical Geography of the Seas*, and to produce in 1844 his works on the Gulf Stream, Ocean Currents, and Great Circle Sailing. He projected the maritime conference at Brussels (1853); and with the co-operation of the British government, and the assistance of naval officers and the learned, completed his sailing charts, to the great advantage of the commerce of the world. In 1855, he was promoted to the rank of commander, and published *Letters on the Amazon and Atlantic Slopes of South America*. In 1861, Virginia, his native state, having seceded from the union, he resigned his commission in the Federal navy, and accepted a corresponding position in that of the Confederate States.

MAUSOLEUM, a sepulchral monument of large size, containing a chamber in which urns or coffins are deposited. The name is derived from the tomb erected at Halicarnassus to Mausolus, king of Caria, by his disconsolate widow, Artemisia, 353 B.C. It was one of the most magnificent monuments of the kind, and was esteemed one of the seven wonders of the world. It was described by Pliny and other ancient writers, as late as the 12th c., and must have been overthrown, probably by an earthquake, during the following two centuries, for all trace of it had disappeared, except some marble steps, when the Knights of St John of Jerusalem, in 1404, took possession of the site of Halicarnassus, then occupied by a small village called Cleesy. While excavating among the ruins for building materials, the knights discovered a large chamber decorated with marble pilasters, and with richly inlaid panels. The sarcophagus of the founder was also discovered in another great hall.

Excavations have been recently made by Mr Newton, assisted by the British government, and he has succeeded in bringing to light many of the beautiful sculptures of the Mausoleum. Amongst others, the fragments of the statue of King Mausolus (now pieced together in the British Museum), and a portion of the Quadriga which crowned the monument. Many fragments of lions, dogs, &c., and a beautiful sculpture of a horse, have been found. Portions of *Arteses*, of fine design and workmanship,

the subjects of which invariably are Greeks in conflict with Amazons, have also been dug up.

The plan of the basement has been traced, the area being 126 feet by 100 feet; and from the fragments of columns, Ionic capitals, &c., which have been found, the description of Pliny has been verified. The Mausoleum consisted of a basement 65 feet high, on which stood an Ionic colonnade 23½ feet high, surmounted by a pyramid, rising in steps to a similar height, and on the apex of which stood a colossal group, about 14 feet in height, of Mausolus and his wife in the Quadriga; these statues are supposed to be the work of the celebrated Scopas. The above dimensions are from Mr Newton's restoration, but they are disputed by Mr Fergusson, and others. All agree that the total height of 140 feet given by Pliny is probably accurate.

MAUVE. See **DYE-STUFFS**.

MAW-SEED, a name by which Poppy-seed (*Papaver somniferum*) is sold as food for cage-birds. It is given to them especially when they are moulting.

MAXIMILIAN I., one of the most distinguished of the German emperors, the son and successor of Frederick III., was born at Neustadt, near Vienna, 22d March 1459. In his 19th year, he married Maria, the only child and heiress of Charles the Bold, Duke of Burgundy, and was soon involved in war with Louis XI of France, who attempted to seize some of her possessions. M., although successful in the field, was compelled, by the intrigues of Louis in the Netherlands, and disaffection stirred up there to betroth his daughter, Margaret, a child of four years old, to the Dauphin, afterwards Charles VIII., and to give Artois, Flanders, and the duchy of Burgundy as her dowry. In 1486, he was elected king of the Romans. Insurrections in the Netherlands, encouraged and supported by France, occupied much of his time, and again involved him in war with Louis XI. He afterwards repelled the Hungarians, who had seized great part of the Austrian territories on the Danube; and the Turks, who in 1492 invaded Carinthia, Carniola, and Steiermark. He again took up arms against France, because Charles VIII. sent back his daughter, and married Anne of Bretagne, in order to acquire that great province. A peace was, however, soon concluded at Senlis in 1493, M. receiving back the provinces which he had given with his daughter. On the death of his father in 1493, he became emperor, and he subsequently married Bianca Sforza, daughter of the Duke of Milan. He applied himself with wisdom and vigour to the internal administration of the empire, took measures for the preservation of peace in Germany, and encouraged the cultivation of the arts and sciences. But he was soon again involved in wars against the Swiss, the Venetians, and France. He sought to put a stop to French conquests in Italy, and was at first successful; but after various changes of fortune, and years of war, mingled with many political complications, he was compelled to give up Milan to France, and Verona to the Venetians. Nor was M. more successful against the Swiss, who in 1499 completely separated themselves from the German empire. The hereditary dominions of his House, however, were increased during his reign by several peaceful additions; and the marriage of his son Philip with the Infanta Juana, and of his daughter Margaret with the Infant Juan of Spain, led to the subsequent union of Spain with Austria; whilst the marriage of two of his grandchildren with the son and daughter of Ladislaus, king of Hungary and Bohemia, brought both these kingdoms to the Austrian monarchy. M. died at Wels, in Upper

Austria, 12th January 1519. He was of a chivalrous character. He wrote various works on war, gardening, hunting, and architecture, and an autobiography full of marvels. He produced also some poems.

MAXIMILIAN II., JOSEPH, king of Bavaria, son of Ludvig I, was born 28th November 1811. He married in 1842 the Princess Maria Hedwig, cousin to the present king of Prussia. Until 1848 he took no part in political affairs, but devoted himself to agricultural and other improvements, and to the pursuits of literature and science. In that year of the revolutionary excitement, he was suddenly called to the throne, on his father's abdication, and adopted a policy accordant with the liberal tendencies of the time. Reactionary measures were afterwards to some extent adopted; but M.'s reign was chiefly signalled by the encouragement of science. He was regarded with no favour by the ultramontane party, but without respect to their opposition, he brought to Munich men of liberal opinions, eminent in literature and science. He died March 1864.

MAXIMUM, in Mathematics, the greatest value of a variable quantity or magnitude, in opposition to *minimum*, the least. More strictly, a maximum is such a value as is greater than those immediately preceding and following it in a series; and a minimum is a value which is less than those immediately preceding and following it, so that a function may have many maxima and minima unequal among themselves, as in the case of a curve alternately approaching and receding from an axis. Traces of the doctrine of maxima and minima are to be found in the works of Apollonius on Conic Sections. The thorough investigation of them requires the aid of the differential calculus, and even of the calculus of variations. The brothers Bernoulli, Newton, Maclaurin, Euler, and Lagrange, have greatly distinguished themselves in this department of mathematics. The Hindus have displayed great ingenuity in solving, by ordinary algebra, problems of maxima and minima, for which, in Europe, the calculus was considered to be necessary.

MAY [Lat. *Maius*, contracted from *Magius*, is from a root *mag*, or (Sans.) *mah*, to grow; so that May is just the season of growth], the fifth month of the year in our present calendar, consists of 31 days. The common notion, that it was named *Maius* by the Romans in honour of *Mais*, the mother of Mercury, is quite erroneous, for the name was in use among them long before they knew anything either of Mercury or his mother! The outbreak into new life and beauty which marks nature at this time, instinctively excites feelings of gladness and delight; hence it is not wonderful that the event should have at all times been celebrated. The first emotion is a desire to seize some part of that profusion of flower or blossom which spreads around us, to set it up in decorative fashion, pay it a sort of homage, and to let the pleasure it excites find expression in dance and song. Among the Romans, the feeling of the time found vent in their *Floralia*, or Floral Games, which began on the 28th of April, and lasted a few days. The first of May—**MAY-DAY**—was the chief festival both in ancient and more modern times. Among the old Celtic peoples, a festival called *Beltain* (q. v.) was also held on this day, but it does not seem to have been connected with flowers. In England, as we learn from Chaucer and other writers, it was customary, during the middle ages, for all, both high and low—even the court itself—to go out on the first May morning at an early hour 'to fetch the flowers fresh.' Hawthorn (q. v.) branches were also gathered; these were brought home about sunrise,

with accompaniments of horn and tabor, and all possible signs of joy and merriment. The people then proceeded to decorate the doors and windows of their houses with the spoils. By a natural transition of ideas, they gave the hawthorn bloom the name of the 'May'; they called the ceremony 'the bringing home the May'; they spoke of the expedition to the woods as 'going a-Maying.' The fairest maid of the village was crowned with flowers as the 'Queen of the May'; placed in a little bower or arbour, where she sat in state, receiving the homage and admiration of the youthful revellers, who danced and sang around her. This custom of having a May queen looks like a relic of the old Roman celebration of the day when the goddess Flora was specially worshipped. How thoroughly recognised the custom had become in England, may be illustrated by the fact, that in the reign of Henry VIII. the heads of the corporation of London went out into the high grounds of Kent to gather the May—the king and his queen, Catharine of Aragon, coming from their palace of Greenwich, and meeting these respected dignitaries on Shooter's Hill. But perhaps the most conspicuous feature of these festive proceedings was the erection in every town and village of a fixed pole—called the Maypole—as high as the mast of a vessel of 100 tons, on which, each May morning, they suspended wreaths of flowers, and round which the people danced in rings pretty nearly the whole day. A severe blow was given to these merry customs by the Puritans, who caused Maypoles to be uprooted, and a stop put to all their jollities. They were, however, revived after the Restoration, and held their ground for a long time; but they have now almost disappeared. In France and Germany too, Maypoles were common, and in some places are still to be seen, and festive sports are even yet observed.—See Chambers's *Book of Days*, pp. 569—582, vol. i.

MAY-FLY. See **EPHEMERA**.

MĀYĀ is, in the Purānic mythology of the Hindus, the personified will or energy of the Supreme Being, who, by her, created the universe; and as, in this later doctrine, the world is unreal or illusory, M. assumes the character of illusion personified. In this sense, M. also occurs in the *later* Vedānta philosophy, and in some of the sectarian philosophies of India.

MAYBOLE, a burgh of regality, in the county of Ayr, Scotland, 9 miles south of the town of that name, and on the line of the Ayr and Girvan Railway. Pop. 4115, who are mostly shoemakers and weavers. In feudal times it was considered the capital of Carrick, and was the seat of the courts of justice of the Carrick bailiery. In the vicinity of M. are the ruins of the famous Abbey of Crossraguel, the head of which, at the time of the Reformation, was Quentin Kennedy, who held a public disputation with John Knox in the town of Maybole. The house where the disputation took place is still shewn.

MAYENCE. See **MAINZ**.

MAYENNE (Lat. *Meduana*), a river in the north-west of France, which rises in the department of Orne, and after being joined on the right by the Varenne, Calmont, Ernée, and Oudon, and on the left by the Jouanne and Ouette, debouches at Pont de Cés into the Loire, under the name of the Maine, having become navigable 50 miles south of Mayenne.—This river gives its name to the department of **MAYENNE**, which has been formed from the western part of the old province of Maine and the north of Anjou. For its area and population, see **FRANCE**. Mayenne, which is included almost

MAYENNE—MAYO.

entirely within the basin of the Loire, has a mild climate, but only a partially productive soil, being occupied in many districts by extensive sandy heaths. The chief branches of industry are the breeding of cattle and sheep, and the rearing of bees; while the iron mines and marble quarries of the district yield employment to the poorer classes. The linen, hemp, and paper manufactures are of some importance. Mayenne is divided into the three arrondissements of Laval, Château-Gontier, and Mayenne.

MAYENNE, chief town of the department of the same name, is situated on the Loire, on the right bank of which rises, on a steep and rocky height, the ancient fortress of the dukes of Mayenne. Lat. 48° 14' N., long. 0° 35' W. The town is pleasantly situated, has several good squares, and some fine fountains; but it is specially remarkable for the extreme steepness of its narrow and winding streets. Pop. about 10,000.

MAYNOOTH, a village of the County Kildare, Ireland, 15 miles north-west from Dublin by the Midland Great Western Railway; population (including the college) 2200. It is of some historical interest as the seat of the powerful family of the Geraldines, of whose castle large and very striking ruins still remain; and as the scene of more than one struggle with the English power, especially the 'Rebellion of Silken Thomas,' in the reign of Henry VIII., and in the war of the Confederates (1641—1650). But its chief modern interest arises from the well-known Roman Catholic college, which has supplied for many years material for strife to the zealots of the rival religious parties in Great Britain. This college was established during the ministry of Mr Pitt, in the year 1795, by an act of the Irish parliament, in order to meet a necessity created by the utter destruction, through the French Revolution, of the places of education in France upon which the Irish Catholic clergy, excluded by the penal laws from the opportunity of domestic education, had hitherto been driven to rely. The original endowment was settled by an annual vote of £8928, which annual vote was continued, although not without a sustained opposition, by the imperial parliament after the act of union. In the year 1846, Sir Robert Peel carried, in despite of a powerful opposition, a bill for an increased and permanent endowment, no longer dependent on a vote of parliament, of £26,000 a year, to which was added a grant of £30,000 for building purposes. The building erected under the original endowment is a plain quadrangle. The new college is a very striking Gothic structure, after the designs of Pugin, containing professors' and students' apartments, lecture-halls, and a singularly fine library and refectory. Pugin's design included a chapel and common-hall, which, owing to insufficiency of funds, have been postponed. The college receives 500 students, all destined for the priesthood, and all resident within the building. The patronage of these studentships is divided in the ratio of population among the bishops of the several sees of Ireland. Candidates named by their bishops are subjected, before matriculation, to examination in a rather comprehensive entrance course. The full collegiate course is of eight years, two of which are given to classics, two to philosophy, and the remaining four to the more directly professional studies of divinity, scripture, church history, canon law, and the Hebrew and Irish languages. The divinity students, 250 in number, receive a money-stipend of £20 annually; and at the close of the ordinary course, 20 scholarships, called from the founder, Lord Dunboyne, 'Dunboyne Scholarships,' are assigned by competition to the most

distinguished students, and may be held for three years. The legislative authority is vested in a board of trustees, consisting of 11 clerical and 7 lay members; and the care of the internal discipline and studies is intrusted to an academical body, consisting of a president and vice-president, together with a numerous body of professors and deans. A visitatorial power is vested in a board of 8 visitors, of whom 5 are named by the crown, and 3 elected by the trustees. At present, the great majority of the Irish Catholic clergy receive their education in this college. In addition to the parliamentary endowment, the college also possesses some landed and funded property, the result of donations and bequests, the most considerable of which is that of Lord Dunboyne, already referred to, who, having been Roman Catholic Bishop of Cork, and having for a time conformed to the Protestant faith, returned before death to his ancient belief, and in dying bequeathed his estate for the endowment of the national college. The parliamentary grant to this college constitutes the sole state endowment for religious purposes which is received by the Catholics of Ireland.

MAYO, a maritime county of the province of Connaught, Ireland, is bounded on the N. and W. by the Atlantic Ocean. Area, 1,363,882 acres, of which 497,587 are arable; pop. (1861) 254,449, of whom 246,108 were Roman Catholics, 6939 Protestants of the Established Church, and the rest Protestants of other denominations. The coast-line of M. is about 250 miles. The surface is very irregular, the interior being part of the great plain of Ireland, bordered by two ranges of mountains, separated from each other at the sea by Clew Bay. Of these ranges, the highest points are Croagh Patrick, 2610 feet, and Nephin, 2646 feet in height. The soil of the central plain is fertile, and for the most part suitable either for tillage or for pasture, although the prevalence of rain and the frequency of ungenial winds render the pursuit of tillage, especially of wheat and potatoes, precarious and unremunerative. The number of acres under crop in 1862 was 200,399. The rearing of cattle forms in most parts of the county the more ordinary pursuit of the agricultural population. In 1862, the number of cattle was 126,252; of sheep, 230,819; and of pigs, 39,630. Ironstone abounds in some districts, but, owing to want of fuel, no attempt is made to work it. An excellent marble is found in the north-western district, and there are several places in which slates are successfully quarried. The chief towns are Castlebar, Westport, Ballina, and Ballinrobe. Almost the only occupations of the population are agriculture and fishing. A valuable salmon-fishery exists in the river Moy; and the small lake of Lough Mask is the habitation of the well-known 'gillaroo' trout. The Irish language is still spoken in a large part of Mayo. The number of national schools in 1861 was 243, attended by 30,731 pupils, of whom 17,812 were male, and 12,919 females.

M. formed part of the extensive territory granted by Henry II. to William de Burgho; but in the middle of the 14th c., one of the younger branches of the family, seizing on the counties of Galway and M., threw off the English allegiance, adopted the 'customs of the Irishry,' together with the Celtic name of MacWilliam. In the year 1575 the MacWilliam made his submission at Galway; but having subsequently revolted, the district was finally subdued by Sir Richard Bingham in 1586. The antiquities of M. are chiefly ecclesiastical. Four round towers are still in existence, and there are at Cong the remains of a splendid abbey, which dates from the 12th century. The celebrated 'Cross of Cong,' now in the Museum of the Royal Irish

Academy, was the archiepiscopal crosier of Tuam, once preserved in the abbey of that name.

MAYOR (Fr. *maire*, Lat. *major*; see **MAOR**), originally a steward, bailiff, or overseer, thence the chief magistrate of a city or corporate town in England or Ireland. The mayor is the head of the local judicature, and the executive officer of the municipality; he is elected by the council from the aldermen or councillors, and holds office for a year only. His duties include those of returning officer in all burghs except those cities and towns which, being counties of themselves, have sheriffs of their own. The first Mayor of London was appointed in 1189, the first Mayor of Dublin in 1409. The mayors of London, York, and Dublin are called 'Lord Mayor.' The Lord Mayor of London has the title of 'Right Honourable,' which, along with the title 'Lord,' was first allowed by Edward III. in 1354; is the representative of royalty in the civil government of the city, the chief commissioner of lieutenancy, the conservator of the river Thames; and on the demise of a sovereign, he becomes, *pro tempore*, a member of the Privy Council. To sustain the hospitality of the city, he receives an allowance of £8000 a year, with the use of the Mansion-house, furniture, carriages, &c. He is chosen by the Livery (q. v.) on the 29th September, being commonly the senior alderman, who has been sheriff, but not Lord Mayor. In former times, it was the ambition of the first merchants and bankers of the City to become Lord Mayor; but since the district within the metropolitan boundaries has come to be but a small fraction of what is generally known as London, this has ceased to be the case; and it is only in the eye of foreigners that the Lord Mayor of London is one of the most important public functionaries of the realm. The Mayor of Dublin was first styled Lord Mayor by Charles II. in 1665.

MAYSVILLE, a city of Kentucky, United States of America, on the Ohio River, 63 miles south-east of Cincinnati. It is finely situated, is the river-port of a rich territory, and the largest hemp-mart in America. It has extensive manufactories of cotton, hemp, tobacco, iron, and coal-oil. It contains the county buildings, city-hall, market, 2 banks, 90 stores, 7 churches. Pop. 7000.

MAZANDERAN, a province of Persia, bounded on the north by the Caspian Sea. It consists for the most part of a tract of low coast-land, about 200 miles in length by 50 in breadth. Along the shore of the Caspian, the land is marshy, but further inland, the surface becomes elevated. The climate cannot be called salubrious, although it is more healthy than that of the neighbouring province of Ghilan. The soil is fertile; rice, cotton, mulberry, sugar-cane, and a variety of fruits, are produced. It exports silk, cotton, and rice to Russia, and imports woollen goods, cutlery, tobacco, &c. Throughout the whole province, parallel with the shores of the Caspian, extends a causeway, constructed by Shah Abbas the Great in the 17th c., and still in good repair. Pop. of the province, about 150,000; capital, Sari (q. v.).

MAZARIN, **JULES** (Ital. *Giulio Mazarini*), cardinal and chief minister of France during the minority of Louis XIV., was born 14th July 1602 at Rome, or, some say, at Piscina in the Abruzzi. The social position and occupation of his father are points in dispute. M. studied law at Rome and at the Spanish universities, where he contrived to unite industry with amorous gaiety. Afterwards, he entered the pope's military service, perhaps about 1624. Having accompanied a papal legate to the

court of France, he became known to Richelieu about 1628, who perceived his great political talents, and engaged him to maintain the French interests in Italy, which he did while still employed by the pope as vice-legate to Avignon (1632), and nuncio to the French court, an office to which he was appointed in 1634. The Spaniards complained of his partiality for France, and the pope was obliged to recall him. The subtle Italian was not thus to be checkmated. In 1639, he openly entered the service of Louis XIII., and was naturalised a Frenchman; and in 1641 received a cardinal's hat, through the influence of Richelieu, who, when dying, recommended M. to the king as the only person capable of carrying on his political system. M.'s position was one of great difficulty amidst the intrigues, jealousies, and strifes of the earlier years of Louis XIV.'s minority. The queen-mother, Anne of Austria, was at first particularly hostile to him; but although she was declared sole regent and guardian of the young king, M. kept his place as minister, and soon made himself indispensable to her, partly by his wonderful business qualities, and still more by the exquisite charm of his manner, so that, although with greater smoothness, he ruled with almost as unlimited a sway as Richelieu. The parliament, thinking to regain political power, resisted the registration of edicts of taxation; but M. caused the leaders of the opposition to be arrested, upon which the disturbances of the Fronde (q. v.) began. The court retired to St Germain; M. was outlawed by the parliament; but by the truce of Ruel, he still remained minister. The feeling against him, however, became still more inflamed, when, at his instigation, the queen-regent caused the Princes of Condé and Conti and the Duke of Longueville to be arrested in January 1650. M. went in person at the head of the court troops to the insurgent provinces; and after the victory at Rethel, shewed so much insolence, that the nobles and the people of the capital made common cause against him, and he thought it necessary to secure his safety by flight to the Netherlands, whilst the press teemed with violent publications against him, known as *Mazarinades*. After the rebellion of the Prince of Condé, he ventured to return to France; but Paris making his removal a condition of its submission, he retired again from the court, and it was not till February 3, 1653, that he made a triumphant entry into the capital, where he was received with significant silence. Yet in a short time he was popular, and had acquired his former power. Under him, the influence of France amongst the nations was increased, and in the internal government of the country those principles of despotism were established on which Louis XIV. afterwards acted. The administration of justice, however, became very corrupt, and the commerce and finances of the country sunk into deep depression. It is admitted that as a financial administrator he was far inferior to Richelieu. M. died at Vincennes, 9th March 1661. He was very niggardly and very avaricious, and had acquired in various ways, fair and foul, an immense fortune, amounting to 12,000,000 livres, which he offered to the king shortly before he died; afraid, it is thought, that it might be rudely seized from his heirs. Louis declined the restitution, which was perhaps what the wily minister expected. He was privately married to Anne of Austria. See the *Memoirs* of M.'s contemporaries, Retz, Madam de Motteville, La Rochefoucault, Turenne, Grammont, &c.; *Siècle de Louis XIV.*, by Voltaire; *Mme. de Longueville*, &c., by Victor Cousin; and *A. Renée's Les Nèdes de Mazarin*.

MAZATLAN, a seaport of Mexico, at the mouth of a river of its own name, which falls into the entrance to the Gulf of California, lat. 23° 10' N., long. 106° 21' W. It is a well-built and picturesque town. The climate is healthy, but very hot (85° to 105° in the shade during August). Pop. from 12,000 to 15,000—a mixed race of old Aztec Mexicans, Indians, Spaniards, and negroes. The chief exports to California and Europe are silver dollars, Brazil or Lima wood, and copper; imports, provisions, machinery, British hardware and crockery, and dry goods from France and Germany. In 1856, the aggregate value of the exports was 1,331,039 dollars. The harbour of M., though much exposed to winds from the south-west, is the most important on the Mexican coast.

MAZEPPA, JAN ('JOHN'), hetman of the Cossacks, was born about 1645, and was descended of a poor but noble family of Podolia. He became a page in the service of John Casimir, king of Poland. A Polish nobleman, having surprised him in an intrigue with his wife, caused him to be stripped naked, and bound upon his own horse, lying upon his back, and with his head to its tail, and sent the animal off, leaving M. to his fate. The horse carried him to his own distant residence—not to the Ukraine, as has been often said; but M., out of shame, fled to the Ukraine, joined the Cossacks, and by his strength, courage, and activity, rose to high distinction amongst them, and in 1687 was elected their hetman. He won the confidence of Peter the Great, who loaded him with honours, and made him Prince of the Ukraine; but on the curtailment of the freedom of the Cossacks by Russia, M. conceived the idea of throwing off the sovereignty of the czar, and for this purpose entered into negotiations with Charles XII. of Sweden. These and other treasons were revealed to Peter the Great, who did not credit the informants; but afterwards, being convinced of M.'s guilt, caused a number of his accomplices to be put to death. M. joined Charles XII., and took part in the battle of Pultowa, after which he fled, in 1709, to Bender, and there died in the same year. His story has been made the subject of a poem by Byron, of a novel by Bulgarin, and of two paintings by Horace Vernet.

MAZURKA, a lively Polish dance of the grotesque kind, the music of which is sometimes in $\frac{4}{4}$ time, but more commonly in $\frac{3}{4}$. The peculiarity of the rhythm, which has a pleasing effect, is what characterises the music of the Mazurka. It is danced by four or eight pairs, and is much practised in the north of Germany, as well as in Poland.

MAZZARA, a city of the island of Sicily, 26 miles south of Trapani, stands in a fine plain on the seashore. Pop. 8400. It is enclosed by walls, and has a cathedral, an episcopal palace, a college, and several convents. It has a considerable trade in cotton, which is extensively grown in the neighbourhood.

MAZZARINO, a town of Sicily, in the fertile province of Caltanissetta, and 15 miles south-east of the town of that name. Pop. 11,600.

MAZZINI, GIUSEPPE, one of the most remarkable men of modern Italy, was born in 1808 at Genoa, his father being a physician of note, of good private means. In youth, M. was noted for the warmth of his friendships, the fixity of his will, and the exaggerated susceptibility of his humane feelings. From birth, sentiments of social equality were engendered in him by the example of his parents; and very early the degraded political condition of his country began to prey upon his mind, producing ardent aspirations for her national

unity and deliverance from foreign domination, which seemed to him attainable only through a return to the republican glories of ancient times. M.'s patriotic enthusiasm speedily gained absolute sway over his spirit, and led him to renounce his cherished idea of a life of literature and contemplative study, for the action and strife of the political arena. In 1827, his maiden essay in literature, 'Dell' Amor Patrio di Dante,' appeared in the liberal journal, the *Subalpino*; and he subsequently contributed critical, literary, and political papers to the *Antologia* of Florence and the *Indicatore Genovese*. In the pages of this latter originally appeared the essay subsequently republished under the title of *Scritti d'un Italiano Vivente*. Literature, according to M.'s own assertion, having been employed by the liberal party solely as a means for the great end of liberal propagandism, the journals were suppressed, and the writers disbanded. In 1830, the affiliation of M. to the secret society of the Carbonari was the introductory step to his practical political career; and the young member was speedily invested with a preponderating influence in the counsels and missions of the body. Insnared and betrayed by a Piedmontese spy, M. was arrested, detained for six months in the fortress of Savona, and finally liberated on condition of his departure from Italy. After short residences in several places, he took up his abode in Marseille, and thence he addressed to Charles Albert his famous letter, which drew down on the daring young writer a decree of perpetual banishment. The organisation of a new liberal league, 'Young Italy,' was M.'s next work. Republican and unionist to the core, the tendencies of this great body were more humanitarian and universal than its extinct predecessor, Carbonarism. In addition to the paramount aim of Italy's republican union under one common law, and the extinction of foreign rule, the general principles of this new association enforced the universal obligation to labour for a common moral regeneration, and the establishment of political equality over the world. Liberty, equality, and humanity were the watchwords of the body; 'God and the People' their motto; white, red, and green their tricolored banner; education and insurrection the great agencies of their operations; assassination was erased from their statutes, and the symbolic dagger of the Carbonari was replaced by the more humane emblems of a book and the cypress. M. was the animating spirit of this formidable league, which speedily enclosed all Europe in a network of similar associations, modified to meet the individual requirements of the various European nationalities. Banishment from Marseille, in consequence of the extensive operations of the society having been revealed to the authorities, compelled M. to resort to concealment for a period of several months. About this time, a charge was brought against him of advocating assassination as a legitimate weapon in the warfare of liberalism; but the charge was proved in the public tribunals of France to be false; and in the British parliament (1845), Sir James Graham made an apology to M. for having re-echoed the calumny. The first-fruits of *La Giovine Italia* was the revolutionary expedition of Savoy, organised by M. at Geneva, but which was defeated by the royal troops. Sentence of death, *par contumace*, was recorded against M. in the Sardinian courts for his participation in the affair; but he soon recommenced with increased vigour his revolutionary operations. A new association, entitled 'New Europe,' and based on principles of European rights and enfranchisement, was inaugurated by the exertions of M. in Switzerland. In 1837, M. quitted Switzerland for England, and

finally took up his abode in London. From thence, his labours in the Italian revolutionary cause have been incessant. To trace the part enacted by M. in the great crisis of 1848 would be to record the history of that period, so intimately were his individual acts connected with the course of events. The resolute combatant of partial union and monarchical leadership at Milan, M. retired to Switzerland on the capitulation of Milan to the Austrians, to reappear in Florence on the rising of Tuscany, and finally at Rome, where he was elected triumvir amidst the triumphant rejoicings of the Austrians, to reappear in Florence on the rising of Tuscany, and finally at Rome, where he was elected triumvir amidst the triumphant rejoicings of the capital of Italy. His tenure of supreme authority was marked by such wisdom, moderation, and success, as to elicit a public tribute of approbation from Lord Palmerston. On the surrender of Rome by M.'s advice, he quitted the city, and proceeded to Lausanne *via* Marseille. The conduct of France he bitterly attacked in public letters to De Tocqueville and others. He subsequently returned to London, and at his instigation, risings in Milan (1853) and in Piedmont (1857) were attempted. In 1859, while lending the whole weight of his influence to the revolutionary movements going on in Italy, he combated with vigilant foresight the threatened French predominance, and refused to accord faith to the liberal programme of Louis Napoleon. The Sicilian expedition of 1860 owed as much to the organisation of M. as to the heroic command of Garibaldi (q. v.). In the more recent attempt, which ended in the inauspicious engagement of Aspromonte, the two leaders were somewhat at variance as to the most efficient plan of attack, Rome being preferred by Garibaldi, while Venice was deemed the most vulnerable point by Mazzini.

M.'s writings are various and extensive, and include valuable dissertations on art, literature, and music, in which he is a proficient. He founded several liberal journals, and contributed able papers to various British periodicals. His valuable narration of the insurrection of Milan, *Cenni e Documenti Intorno all' Insurrezione Lombarda e alla Guerra Regia del 1848*, has been translated into French and English, under the title, *Royalty and Republicanism in Italy*. His elevation of sentiment, and the flashing eloquence of his writings, have exerted an immense influence on the fervid youth of Italy. A complete edition of M.'s works, edited by Daelli, and corrected by M. himself, is now in course of publication. Whatever may be thought of M.'s political views, few will call in question the ardent sincerity of his patriotism. Still less can we refuse to admire the inflexibility with which he has pursued his aim, unchecked by persecution, calumny, and defeat. M. possesses in the highest degree that personal fascination by which friends are converted into ardent partisans. In his private life, he is allowed to be a model of purity and frugal simplicity, as in his public career he has been conspicuous for disinterestedness and self-abnegation; and to these personal virtues of M., aided by his extraordinary influence and eloquence, those who know Italy best ascribe a great share at least in inspiring that higher tone of life manifest in recent years among the Italian youth, without which the political regeneration of the country would have been impossible.

MEAD, a fermented liquor made from honey. The honey is mixed with water, and fermentation is induced and conducted in the usual manner. Cottagers sometimes use the honey which remains in the combs after the usual processes of dropping and squeezing, for making mead, which is a thin and very brisk, but at the same time luscious beverage. Mead has been in use from very ancient times, and was known equally to the polished nations of

Southern Europe and the barbarous tribes of more northern regions. Pliny says it has all the bad qualities of wine, but not the good ones. The Latin name is *Hydromeli*.

MEADOW GRASS (*Poa*), a genus of Grasses, having a loose spreading panicle, the spikelets usually containing a number of florets, and with two glumes shorter than the florets, the florets each having two pales, which are bluntish and awnless, the fruit free. The species are very numerous, chiefly natives of the temperate and colder parts of the world, and forming in these a very important part of the herbage of pastures and meadows. Most of the species are of a slender and delicate appearance, with small spikelets and florets; and the herbage is tender, nutritious, and rather abundant. Of the British species, the ROUGH-STALKED M. G. (*P. trivialis*) and the SMOOTH-STALKED M. G. (*P. pratensis*) are among the most common, and are esteemed among the most valuable for sowing in mixtures of grasses for pasture.—The ABYSSINIAN M. G. (*P. Abyssinica*), an annual species, yields immense returns of herbage in its native country, but a warmer climate than that of Britain seems to be requisite for its successful cultivation. It is called *Teff* in Abyssinia, and its seeds are used as corn for making bread. Beer is made by putting slices of this bread into warm water, the temperature of which is kept up in a close vessel for some days.—*P. annua* is an extremely common British species, springing up continually as a weed in cultivated grounds, and abounding on waysides as well as in pastures. It is often to be seen in flower, even in winter, and in summer is said to ripen its seeds in four or five weeks from the time of sowing. It is employed with advantage for sowing on greens in towns, and wherever from any cause perennial grasses are apt to be destroyed. It is very abundant in most parts of Europe, and Dr Hooker found it at one of the most elevated passes of the Himalaya Mountains.—Manna Grass (q. v.) is closely allied to this genus.

MEADOW SAFFRON. See COLCHICUM.

MEADOWS, a term somewhat indefinitely applied to moist level lands covered with grass, which is usually rich in consequence of the moisture, and often also from advantages of soil. The grass is either used for pasture, or is mown and carried away. *Water Meadows* are meadows in which the supply of water is increased and regulated by artificial irrigation. See IRRIGATION. The herbage of all meadows consists generally of various kinds of grasses; meadow-grass, rye-grass, timothy, fox-tail, and bent-grass or florin, predominating.

MEAL (Sax. *mal*, a part or portion; Ger. *mahl*), a portion of food taken at one time, a repast. The number of meals eaten per day has varied at different times and in different countries. Among the Greeks and Romans of the classic ages, it was the general practice to have the principal meal towards evening, a light meal in the morning, and another in the middle of the day. The *akratisma*, *ariston*, and *deipnon* of the Greeks, corresponded nearly to the breakfast, luncheon, and dinner of our own country at the present time; the first was taken immediately after rising in the morning, the second about mid-day, and the *deipnon*, the principal meal, often not till after sunset. In Rome of the Augustan age, the three corresponding meals were *jentaculum*, *prandium*, and *cena*. The two former were simple and hasty, except among persons of luxurious habits, with whom the mid-day meal was sometimes of an elaborate description. The *cena*, taken in the evening, consisted of three courses, with often a great variety of viands. Reclining

was the usual posture at meals for the men, the women and children sitting. Two persons, and occasionally three, reclined on one couch. Before a guest took his place at table, his shoes were taken off, and his feet washed by an attendant.

In mediæval and modern Europe, the prevailing practice, down nearly to the middle of last century, was to have three meals in the day, the mid-day, and not the evening meal, being the principal one. The habits of all classes were early; four was a usual hour for rising, and five for breakfast. Twelve was the dinner-hour, when it was the usage in England down to Queen Elizabeth's time for every table, from that of the twenty-shilling freeholder, to the table in the baron's hall and abbey refectory, to be open to all-comers, with free fare, bread, beef and beer. Supper followed in the evening, a less abundant repetition of dinner. In the course of the last 120 years, a revolution has been going on in the hour of dinner, which has gradually got later till it has reached the present usage of from six to eight in the evening among the more cultivated classes. The introduction of tea and coffee has, to a certain extent, changed our habits as regards meals. They form an essential part of our breakfast, which is later than that of our ancestors, from nine to ten. The meal called tea is but a part of dinner, and supper, as a regular meal, has nearly disappeared. A light meal, called luncheon, is often taken between breakfast and dinner. Our dinner has therefore come nearly to correspond with the supper of our ancestors. This change of hours has brought with it one important change to the better in social habits; the excessive drinking, so common during the Georgian era, even among people of refinement, has disappeared; the long carousals of that period have been abridged to an hour, or half an hour, spent over wine after dinner. In Britain, dinner is, more than anywhere else, made a social meal, and an occasion of meeting one's friends; and public dinners, with toasts and after-dinner speeches, are a characteristically British mode of celebrating any public event or anniversary. In France and Italy, the gradual advance of the dinner-hour has not proceeded further than four or five o'clock. In Germany, the usage still obtains, to a large extent, of an early dinner and a supper. One o'clock is a usual dinner-hour, and even the court hour has hardly advanced beyond three and four. In Vienna, and some other parts of Germany, it is not uncommon to have five meals a day—breakfast, luncheon, dinner, tea, and supper.

MEAL. See BREAD.

MEAL-WORM, the larva of *Tenebrio molitor*, a



Tenebrio Molitor :

1 and 2, perfect insect; 3, pupa; 4, larva (meal-worm).

coleopterous insect of a genus allied to *Blaps* (q. v.), but possessing wings and wing-covers. The perfect insect is of a pitchy or dark chestnut colour, smooth,

about half an inch long, with short 11-jointed antennæ, and stout legs. It is a common insect in Britain, most active in the evening, abounding in granaries, mills, and houses in which considerable stores of meal or flour are kept; as its eggs are deposited among these substances, on which the larva feeds, often doing considerable injury. Stores of ship-biscuit often suffer from this cause. The larva is about an inch long, thin and round, of an ochreous colour, with bright rusty bands, very smooth and glossy, with six small feet, and two very short antennæ.—Another species, *T. obscurus*, has been introduced with American flour, and has become pretty common in some parts of Britain. The insect is of a dull black colour above; the under parts, legs, and antennæ, chestnut. The larva is shining and pale brown.—Cleanliness and care are the best preventives of these pests. Meal-worms are a favourite and excellent food of caged nightingales.

MEALY BUG (*Coccus adonidum*), an insect naturalised in our hothouses, and very injurious to pine-apples and other plants. It is reddish, and covered with a white powdery substance. See COCCUS.

MEAN, in Mathematics, is a term interpolated between two terms of a series, and consequently intermediate in magnitude. The *Geometric Mean* (q. v.) of two numbers is always less than their *Arithmetic Mean* (q. v.), and greater than their *Harmonic Mean*; and the geometric mean is itself a geometric mean between the two other 'means.'

MEARNS. See KINCARDINESHIRE.

MEASLES (known also as RUBEOLA and MORBILLI) is one of the group of blood-diseases termed *Exanthemata* (q. v.), although, from the eruption which appears on the surface of the body, it is sometimes classed with the skin-diseases. It is communicable from person to person, and seldom occurs more than once in the same individual. Its period of incubation—that is to say, the time that elapses between exposure to the contagion and the first appearance of the febrile symptoms which precede the eruption—is usually about a fortnight; then come lassitude and shivering, which are soon followed by heat of skin, increased rapidity of the pulse, loss of appetite, and thirst. The respiratory mucous membrane is also affected, and the symptoms are very much the same as those of a severe cold in the head, accompanied with a dry cough, a slight sore throat, and sometimes tightness of the chest.

The eruption which is characteristic of the disease usually appears upon the fourth day from the commencement of the febrile symptoms and the catarrh—seldom earlier, but not unfrequently some days later. It is a rash, consisting at first of minute red papule, which, as they multiply, coalesce into crescentic patches. It is two or three days in coming out, beginning on the face and neck, and gradually travelling downwards. The rash fades in the same order as it occurs; and as it begins to decline three days after its appearance, its whole duration is about a week. The red colour gives way to a somewhat yellowish tint, and the cuticle crumbles away in a fine bran-like powder; the process being often attended with considerable itching.

There are two important points in which it differs from Smallpox (q. v.), with which in its early stage it may be confounded: these are—1. That the fever does not cease or even abate when the eruption appears, but sometimes increases in intensity; and (2), that the disease is not more severe or more dangerous because the eruption is plentiful or early. The character of the eruption, after the first day, will serve to remove all doubt regarding these two

diseases; and the comparative prevalence of either disease in the neighbourhood will materially assist in forming the diagnosis. It is distinguished from Scarlet Fever (q. v.) or scarlatina, (1), by the presence at the outset of catarrhal symptoms, which do not occur in the latter disease, at any rate, prior to the eruption; (2), by the absence of the throat-affection, which always accompanies well-marked cases of scarlet fever; (3), by the character of the rash, which in measles is said to present somewhat the tint of the raspberry, and in scarlet fever, that of a boiled lobster; which in measles appears in crescentic patches, and in scarlet fever is universally diffused; which in measles usually appears on the fourth day, and in scarlet fever on the second day of the disease.

In ordinary uncomplicated measles, the prognosis is almost always favourable. The chief danger is from inflammation of some of the textures that compose the lungs; and in scrofulous children, it often leaves chronic pulmonary mischief behind it. No age is exempt from the disease, but it is much more common in childhood than subsequently. The reason probably is that most persons have it in early life, and are thus protected from an attack at a later period.

In mild forms of the disease, nothing more is requisite than to keep the patient on a low diet, attend to the state of the bowels, and prevent exposure to cold, which is best accomplished by keeping him in bed with the ordinary warmth to which he is accustomed in health. If the chest-symptoms become urgent, they must be treated according to their nature. Bronchitis (q. v.), sometimes extending into Pneumonia (q. v.), is most to be feared. If the eruption disappear prematurely, it may sometimes be brought back by placing the patient in a warm bath. In such cases, stimulants are often required, but must, of course, only be given by the advice of the physician. The patient must be carefully protected from exposure to cold for a week or two after the disease has apparently disappeared, as the lungs and mucous coat of the bowels are for some time very susceptible to inflammatory attacks.

MEASURE, in Music, is a term applied to the quantity of notes which are placed in the bar, and which is generally called the *time*, of which there are but two kinds, viz., common time, containing an equal quantity of notes in the bar, and triple time, containing an unequal quantity. Common time is generally marked with a C at the beginning, which means that every bar contains four crotchets, or their value in other notes. There are also other kinds of common time, which are marked $\frac{3}{4}$, $\frac{2}{4}$, $\frac{3}{8}$. Triple time is marked $\frac{3}{4}$, $\frac{3}{8}$, $\frac{3}{16}$, $\frac{3}{32}$. Sometimes, in common time, we have $\frac{3}{4}$, $\frac{3}{8}$. The lower figure indicates the parts of the semibreve, and the upper figure shews how many of these parts there are in the bar.

MEATH, a maritime county of the province of Leinster, Ireland, bounded on the east by the Irish Sea and the county of Dublin; area, 906 square miles, or 590,083 acres, of which 547,391 are arable, 16,033 are uncultivated. Pop. (1851) 140,748; (1861) 110,575, of whom 103,499 are Roman Catholics, 6584 Protestants of the Established Church, the rest Protestants of other denominations. The surface is for the most part an undulating level, forming the eastern extremity of the great limestone plain of Ireland, and rising slightly towards the north and north-west. No minerals of any importance are found. The soil is a rich loam, and extremely fertile; but it has long been devoted almost entirely to pasture; the total extent under cereal crops in 1862 being only 78,751 acres. In the same year, the cattle amounted to 142,906,

the sheep to 200,022, and the pigs to 17,357. The chief rivers are the Boyne and Blackwater. The principal towns are Trim, Navan, and Kells, in the first of which the assizes are held. M. possesses abundant means of internal communication, being intersected by numerous roads and several railways, as also by the Royal Canal. The coastline is about 10 miles, but without any port of importance, even as a fishing-station. The occupations of the people are almost exclusively agricultural. Anciently, M., which included West Meath, and probably portions of several other adjacent counties, constituted one of the kingdoms into which Ireland was divided, the royal seat being the celebrated Temor or 'Tara of the Kings,' the scene of the first preaching of Christianity under St Patrick. After the English invasion, M. was early occupied by Strongbow, and was erected into a county palatine by Henry II., who conferred it on Hugh de Lacy. From this time forward, it was the scene of many conflicts. In the end of the reign of Henry VIII., it was separated into East and West Meath. Few Irish counties present so many interesting relics of Irish antiquities of all the various periods. Celtic remains abound along the valleys of the Boyne and Blackwater. The earthworks of the ancient royal seat at Tara are still discernible, and some valuable and highly characteristic gold ornaments were there discovered. John's castle at Trim is one of the most extensive monuments of English rule in Ireland. The round tower and sculptured crosses of Kells are singularly interesting; and almost every parish in the county contains some relic of the feudal or ecclesiastical structures which formerly covered the land. M. returns two members to the imperial parliament.

MEAUX, a town of France, in the department of Seine-et-Marne, on the river Marne, 25 miles east-north-east of Paris. It is a bishop's see, and its cathedral, begun in the 11th c., is a noble Gothic structure. Bossuet, the famous preacher, was bishop here, and is buried in the choir. Corn and flour from the water-mills on the Marne are sent to Paris in large quantities, and there are manufactures of cotton and other cloths, pottery, leather, saltpetre, &c. Pop. 10,000.

MECCA (*Om Al Kora*, Mother of Cities), one of the oldest towns of Arabia, the capital of the province of Hedjaz, and, through being the birthplace of Mohammed, the central and most holy city of all Islam. It is situated in 21° 30' N. lat., and 40° 8' E. long., 245 miles south of Medina, and about 65 miles east of Jiddah, the well-known port on the Red Sea, in a narrow, barren valley, surrounded by bare hills and sandy plains, and watered by the brook Wadi-Al-Tarafeyn. The city is about 1500 paces long, and about 650 broad, and is divided into the Upper and Lower City, with about 25 chief quarters. The streets are broad and rather regular, but ungarved; excessively dusty in summer, and muddy in the rainy season. The houses, three or four stories high, are built of brick or stone, ornamented with paintings, and their windows open on the streets. The rooms are much more handsomely furnished, and altogether in a better state than is usual in the East; the inhabitants of M. making their living chiefly by letting them to the pilgrims (see HAJJ) who flock hither to visit the Beit Ullah (House of God), or chief mosque, containing the Kaaba (q. v.). This mosque, capable of holding about 35,000 persons, is surrounded by 19 gates surmounted by seven minarets, and contains several rows of pillars, about 20 feet high, and about 18 inches in diameter, of marble, granite, porphyry, and common sandstone, which at certain distances

are surmounted by small domes. A great number of people are attached to the mosque in some kind of ecclesiastical capacity, as *katibs*, *muftis*, *mueddins*, &c. No other public place or building, sacred or profane, of any importance, is to be found in this city, which also is singularly destitute of trees and verdure of any kind. It is protected by three castellated buildings, and is governed by a *sherif*. The population has, in consequence of the rapidly decreasing number of pilgrims, fallen off considerably of late, from above 100,000 to hardly 40,000, who do not find the 100,000 annual pilgrims sufficient to keep them in the state of prosperity of former years. The trade and commerce of M. hardly deserve mention; the chief articles manufactured there are chaplets for the pious pilgrims. The townspeople themselves are lively, polished, and frivolous, and growing up amid an immense concourse of strangers from all parts of Asia, are generally able to converse in three or four eastern languages. Respecting the history of M., it was known to Ptolemy already as *Macoraba*, and first belonged to the tribe of the *Kosaites*, later to the *Koréish*. Mohammed, who had been obliged to leave it precipitately (see *HEDJRAH*) in 622, returned to it and conquered it in 627. Within the course of the present century, M. was taken by the *Wahabites* (1803), but given up again to the *Pasha* of Egypt, *Mehemed Ali* (1833) whose son, *Ibrahim*, was made *Sheik El Haram*—'of the Sacred Place.' At present, however, M. is directly dependent on the sultan.—A certain balm, called *Balm of Mecca*, is made from a plant which grows in abundance in the neighbourhood of the city, called *Besem*.

MECHANICAL POWERS—MACHINES.

Machines are instruments interposed between the moving power and the resistance, with a view of changing the direction of the force, or otherwise modifying it. Machines are of various degrees of complexity; but the simple parts, or elements of which they are all composed, are reducible to a very few. These elementary machines are called the *MECHANICAL POWERS*, and are usually reckoned as six in number, three being primary—viz. the *lever*, *inclined plane*, and *pulley*; and three secondary, or derived from the others—viz. the *wheel-and-axle* (derived from the lever), the *wedge*, and the *crew* (both derived from the inclined plane). To these some add toothed-wheels. What is special to each machine, will be found under its name; a few observations applicable to all may appropriately be made here. 1. In treating of the theory of the lever and other mechanical powers, the question really examined is, not what power is necessary to move a certain weight, but what power is necessary to balance it; what force at P, for instance (see *LEVER*, fig. 1), will just keep W suspended. This once done, it is obvious that the least additional force to P will suffice to begin motion. 2. In pure theoretical mechanics, it is assumed that the machines are without weight. A lever, for instance, is supposed to be a mere rigid line; it is also supposed to be perfectly rigid, not bending or altering its form under any pressure. The motion of the machine is also supposed to be without friction. In practical mechanics, the weight of the machine, the yielding of its parts, and the resistance of friction, have to be taken into account. 3. When the effect of a machine is to make a force overcome a resistance greater than itself, it is said to give a *mechanical advantage*. A machine, however, never actually increases power—for that would be to create work or energy, a thing now known to be as impossible as to create matter. What is gained in one way by a machine is always lost in another. One pound at the long end of a lever will lift ten pounds at

the short end, if the arms are rightly proportioned; but to lift the ten pounds through one foot, it must descend ten feet. The two weights, when thus in motion, have equal moments; the moving mass multiplied into its velocity, is equal to the resisting mass multiplied into its velocity. When the lever seems to multiply force, it only concentrates or accumulates the exertions of the force. The descending one-pound weight, in the case above supposed, may be conceived as making ten distinct exertions of its force, each through a space of a foot; and all these are concentrated in the raising of the ten-pound weight through one foot. The principle thus illustrated in the case of the lever holds good of all the other mechanical powers. 4. The object of a machine is not always to increase force or pressure; it is as often to gain velocity at the expense of force. See *LEVER*. In a spinning-factory, e. g., the object of the train of machinery is to distribute the slowly working force of a powerful water-wheel, or other prime mover, among a multitude of terminal parts moving rapidly, but having little resistance to overcome. 5. The mechanical advantage of a compound machine is theoretically equal to the product of the separate mechanical advantages of the simple machines composing it; but in applying machines to do work, allowance must be made for the inertia of the materials composing them, the flexure of parts subjected to strains, and the friction which increases rapidly with the complexity of the parts; and these considerations make it desirable that a machine should consist of as few parts as are consistent with the work it has to do. 6. The forces or 'Moving Powers' by which machines are driven, are the muscular strength of men and animals, wind, water, electrical and magnetic attractions, steam, &c.; and the grand object in the construction of machines is, how, with a given amount of impelling power, to get the greatest amount of work of the kind required. See *WORK*, *FOOT-POUND*. This gives rise to a multitude of problems, some more or less general, others relating more especially to particular cases—problems, the investigation of which constitutes the science of Applied Mechanics. One of the questions of most general application is the following: If the resistance to a machine were gradually reduced to zero, its velocity would be constantly accelerated until it attained a maximum, which would be when the point to which the impelling force is applied was moving at the same rate as the impelling force itself (e. g., the piston-rod of a steam-engine) would move if unresisted. If, on the other hand, the resistance were increased to a certain point, the machine would come to a stand. Now the problem is, between these two extremes to find the rate at which the greatest effect or amount of work is got from the same amount of driving power. The investigation would be out of place here, but the result is, that the greatest effect is produced when the velocity of the point of application is one-third of the maximum velocity above spoken of. The moving force and the resistance should therefore be so adjusted as to produce this velocity.

MECHANICS is the science which treats of the nature of forces and of their action on bodies, either directly or by the agency of machinery. The nature of force will be found treated of under *FORCE*. The action of forces on bodies may be in the form of pressure or of impulse, and may or may not produce motion. When the forces are so balanced as to preserve the body affected by them in a state of equilibrium, their actions are investigated in that branch of mechanics called *STATICS* (q. v.); when motion is produced, they are considered under the head of *DYNAMICS* (q. v.), or *Kinetics*. The

equilibrium and motion of fluids (including liquids and gases) is treated in the subordinate branches of HYDROSTATICS and HYDRODYNAMICS; though the special terms AKROSTATICS and AERODYNAMICS (for which the comprehensive term PNEUMATICS is often used) are sometimes employed to designate those portions of the science of mechanics in which the action of gaseous bodies is treated of.

The science of mechanics owes very little to the ancient philosophers. They were acquainted with the conditions of equilibrium on the lever—discovered by Archimedes—and had reduced the theory of all the mechanical powers, except the pulley and the inclined plane and its derivatives, to that of the lever, but this was nearly all. Archimedes, starting from the principle of equilibrium on the lever, struck out the idea of a centre of gravity for every body, and investigated the position of that point for the triangle, parabola, and paraboloid. Till the 16th c., the science remained stationary, Cardan, the Marquis Ubaldi, and Stevinus—who was the first to give the correct theory of equilibrium on the inclined plane—then gave it a slight impetus, and the labours of Galileo, who introduced the expression of mechanical propositions in mathematical formulas, discovered the laws regulating the motion of falling bodies, and originated investigations concerning the strength of materials, placed the science on a broad and substantial basis. Torricelli, Descartes, Pascal, Fermat, Roberval, and Huyghens, on the continent, and Wallis and Wren in England—the last three of whom simultaneously discovered the laws which regulate the collision of bodies—added each his quota to the *new science*, as mechanics was then called. In 1687, appeared Newton's *Principia*, in which the complete experimental basis of the subject was first laid down in a satisfactory manner, and the mechanical principles which had before been considered to act only at the surface of the earth, were shewn to rule and direct the motions of the planets. Contemporary with Newton were Leibnitz, and the two elder Bernouillis, James and John, who, besides contributing greatly to the advancement of the science, applied to it the newly-invented differential calculus, which was found to be a weapon of immense power. From this time, a constant succession of illustrious men have prosecuted the study of theoretical mechanics, or of subjects connected with it. The chief names are Daniel Bernouilli, Euler, D'Alembert, Clairaut, Lagrange, Laplace. Lagrange's *Mécanique Analytique* not only systematised the subject, but enormously increased its power and the range of its applications. The last great additions to the science are those made by Sir W. R. Hamilton (q. v.) under the name of the principle of *Varying Action*. The developments which this has received from Jacobi, Boole, Cayley, Liouville, Donkin, Bour, &c., form an extensive and difficult branch of applied mathematics, chiefly of the theory of simultaneous differential equations.

MECHITARISTS, a congregation of Armenian Christians, who reside on the island of San Lazaro at Venice, but who have also obtained a footing in France and Austria. They derive their name from MECHITAR (i. e., the Comforter) DA PÉTRO (born at Sebaste 1676, died at Venice 1749), who, in the year 1701, founded at Constantinople a religious society for the purpose of diffusing a knowledge of the old Armenian language and literature. Subsequently, the M. removed to the Morea, and thence, on the conquest of that portion of Greece by the Turks in 1715, to San Lazaro, which was granted to them by the Venetian government.—The M. acknowledge the supremacy of the Roman pontiff. Their most useful occupation is printing the classic

writings of Armenian literature; their editions are universally admitted to be the best and most correct. They also issue a *journal*, which is much read throughout the Levant.—Compare Boné, *Le Convent de St-Lazare à Venise, ou Histoire succincte de l'Ordre des Méchitaristes Arméniens* (Paris, 1837).

ME'CHLIN. See MALINES.

MECKLENBURG-SCHWERIN, a grand duchy of Northern Germany, bounded on the N. by the Baltic, E. by Pomerania, S. by Brandenburg, and W. by Lauenburg. The area is about 5126 square miles, and pop. (1862) 551,761. M.-Schwerin is watered by several rivers, the most important of which are the Elbe and the Warnow, and has a great many lakes and ponds, yielding an abundant supply of fish. The country is generally flat, although here and there intersected by low ranges of hills, and its surface is still extensively covered with wood, notwithstanding the great clearings which have been made in the forests during the present century. Near the sea, tracts of sand and morass cover large areas; but on the whole, the soil is of a good quality, and well adapted for the growth of corn, or the rearing of cattle, which constitute the principal native industry. There is considerable commerce through Warnemünde (Rostock) and Wismar; there were in 1862, belonging to the two ports, 413 vessels, with a burden of 48,983 lasts of 6000 lbs. The grand duchy is divided into the circles of Schwerin, Güstrow, Rostock, and Wismar. The capital is Schwerin. The central and south-east districts are the most densely peopled. The people of both the Mecklenburg duchies (Schwerin and Strelitz) are for the most part of Slavonic origin, but amalgamation with their Saxon neighbours has largely Germanised the original race. The predominant form of religion is the Lutheran, Roman Catholic and other churches numbering about 1100, while there are upwards of 3000 Jews. Much has been done of late years in extending the educational organisation of both duchies, although the lower classes do not yet enjoy as many advantages as in some other districts of Germany. Besides the university at Rostock (q. v.), there are five gymnasia, and numerous burgher, parochial, and other schools. The army of M.-Schwerin numbers in time of peace 2700 men, and when on a war-footing, 5380 men. The principal towns are the capital Schwerin, Ludwigslust, Rostock, Güstrow, and Wismar. The grand-duke, whose powers are limited by a mixed feudal and constitutional form of government, has the title of Royal Highness, and is styled Prince of the Wends, and of Schwerin and Ratsburg, Count of Schwerin, and Lord of Rostock, Stargard, &c. The two Mecklenburg duchies have provincial estates in common, which meet once a year, alternately at Malchin and Sternberg. This united chamber consists of noble landowners and the representatives of forty-seven provincial boroughs, each of which has, however, its separate municipal government. The annual receipts of the duchy (according to the *Almanach de Gotha* for 1864) amounted, in 1861, to 391,295 thalers, and the expenditure was about equal to the receipts; while the public debt is upwards of 8,000,000 thalers. In the limited council of the Federal Diet, the two duchies conjointly occupy the fourteenth place; but in the Plenum, M.-Schwerin possesses two distinct votes. In time of peace, it furnishes to the federal army a contingent of 3000 men, which, in war, may be raised to 7860 men.

History.—The Mecklenburg territory, anciently occupied by Germanic, and afterwards by Slavonic tribes, was finally subdued, in the 12th c., by Henry

the Lion, Duke of Saxony, who, after thoroughly devastating the country, and compelling the small number of inhabitants remaining after the war to adopt Christianity, restored the greater part of the territory to Burewin, the heir of the slain Slavonic prince, Niklot, and gave him his daughter in marriage. The country at that period received its present designation from its principal settlement, Mikilenburg, now a village between Wismar and Brühl. In 1349, it was elevated into a duchy by the Emperor Charles. Duke Johann Albrecht introduced the Protestant doctrines in 1550, and his grandsons, Wolf-Friedrich and Johann Albrecht, founded the lines of Mecklenburg-Schwerin and Mecklenburg-Güstrow, which were, however, deprived of the ducal title in 1627, in consequence of their adhesion to the Protestant cause, when the imperial general Wallenstein was proclaimed duke of all Mecklenburg. In 1632, Gustavus Adolphus of Sweden restored his kinsmen, the deposed dukes, to their domains. After various subdivisions of the ducal line into the branches of Schwerin, Strelitz, and others, and the successive extinction of several of these collateral houses, the Imperial Commission, which met at Hamburg in 1701, brought about the settlement of a family compact, by which it was arranged that Schwerin and Güstrow should form one duchy, and Strelitz, with Ratzeburg and Stargard, Mirow and Nemerow, another independent sovereignty. After this, very few events of importance occurred till the accession in Schwerin, in 1785, of Friedrich Franz, who obtained the title of grand duke in 1815, and died in 1837, after a long reign, which he had made highly conducive to the internal welfare and external reputation of his hereditary dominions. The reign of Friedrich Franz II., who succeeded his father, Paul Friedrich, in 1842, was disturbed by a contest between the nobles and the burgher and equestrian landowners, the former arrogating to themselves the exclusive right of electing members into the equestrian order, nominating to benefices, and monopolising other prerogatives of the ancient feudal nobility. The revolutionary excitement of 1848 gave a fresh stimulus to the popular ferment, and the disturbances could only be quelled by the intervention of Prussian troops. Since that period, the course of events has nearly resumed the old channels.

MECKLENBURG-STRELITZ, a grand duchy of Germany, composed of two distinct portions of territory, viz., Stargard (by far the larger division, lying to the east of Mecklenburg-Schwerin) and the principality of Ratzeburg (between Mecklenburg-Schwerin and Lanenburg), and comprising an area of rather more than 1000 square miles, with a pop. (1860) of 99,060. The country is flat, and similar in its physical characters to Schwerin, although, from its greater distance from the sea, the climate is less humid and less changeable. Strelitz, as already observed, has one joint representative chamber with Schwerin, but the lordship of Ratzeburg is not included in these estates, and is governed directly by the grand duke, who possesses very considerable private domains, from which he draws large revenues. In addition to its joint vote with Mecklenburg-Schwerin, M.-Strelitz possesses one vote in the Plenum of the Federal Diet, and furnishes a contingent of 718 men to the army of the confederation. M.-Strelitz has a debt of nearly two million thalers. For the history of M.-Strelitz see preceding article.

The Mecklenburg duchies are essentially agricultural, 71 per cent. of the inhabitants being employed on the land. In M.-Schwerin 3549 square miles, and in M.-Strelitz 670 square miles, are under cultivation. The cattle of the duchies are considered

the best in Germany; the horses especially are held in high esteem. The principal products are corn (which is exported to Scandinavian and British ports), cattle and sheep (which are sent to the markets of Hamburg and Berlin), wool, tobacco, butter, cheese, fish, fruit, hides, &c. The exports of both duchies amount to about 26 million thalers annually, and the imports to about 13 million thalers.

MECO'NIC ACID ($C_{14}H_{10}O_3 \cdot 3HO + 6Ag$), (from Gr. *mecōn*, a poppy), an acid existing in opium, which, when good, yields from 6 to 8 per cent. of it. Both the acid and its salts assume a characteristic blood-red tint with persalts of iron, and this test, which is very sensitive, is employed by the toxicologist in searching for traces of opium. As, however, the alkaline sulphocyanides which exist normally in the saliva give a precisely similar tint with the persalts of iron, it is necessary to be able to distinguish the meconate of iron from the sulphocyanide of iron. A solution of terchloride of gold or of corrosive sublimate removes all doubt, by discharging the colour of the sulphocyanide, but not affecting the colour of the meconate of iron.

MECO'NIUM. This term is applied to the earliest matter discharged from the bowels of a new-born infant. It is of a brownish-green or almost black colour, acid to test-paper, but devoid of odour, and rapidly putrefying on exposure to air. It is usually regarded as a product of the foetal liver, but, according to Lehmann, it contains neither biliary acids nor bile-pigment. When examined under the microscope, it is found to consist of an abundance of cylinder epithelium of a beautiful green tint, of mucus-corpuscles, and of fat, with which there is a good deal of cholesterine.

MEDAL (Fr. *médaille*, Lat. *metallum*), a piece of metal in the form of a coin, not issued or circulated as money, but stamped with a figure or device to preserve the portrait of some eminent person, or the memory of some illustrious action or event. The study of medals, interesting in an historical and antiquarian point of view, is also important as illustrating the contemporary state of art. Like coins, medals belong to two periods, ancient and modern, separated by a wide interval. To the former belong those pieces issuing from the mint of ancient Rome, known as *medallions*, of the size of the aureus in gold, of the denarius in silver, and of the first or large brass in copper. They are generally supposed to have been struck on occasions similar to those on which medals are coined in modern times, on the accession of an emperor, on the achievement of an important victory, or as specimens of workmanship; but there are circumstances which countenance the belief that they were circulated as money. Medallions prior to the time of Hadrian are rare and of great value—one of the most beautiful and most famous being a gold medallion of Augustus Cæsar—from Hadrian to the close of the Empire they are comparatively common. Of the Roman medallions, some were struck by order of the emperors, some by the senate; the latter may be known by being inscribed with the letters S. C. The larger bronze medallions are of admirable workmanship. In some of them, a ring of bronze surrounds a centre of copper, and the inscription extends over both metals. No portrait of a person not princely occurs on any ancient medal, a remarkable circumstance, considering the numerous contemporary statues of poets, historians, and philosophers. The *Contorniiati* are bronze medals marked with furrows (*contorni*), distributed at the public games, and apparently also in use as money. Numerous medals and medallions were struck in the

Greek provinces of the Roman empire, of less substance and thickness, for the most part, than those of Rome. The Sicilian medals are of very fine workmanship, particularly one with a head of Ceres, and on the reverse a Victory crowning a figure in a car.

Modern medals begin in the 14th c., but few were struck prior to the 15th. Portraits of non-princely persons are freely introduced after the 16th century. An affectation of the classical takes from their value as illustrations of contemporary life. Most European countries possess a succession of medals from the 15th c. onwards. The best in point of design of the 15th c. medals are those wrought by Victor Pisani of Verona, and inscribed 'Opus Pisani Pictoria.' The medals of the popes form an unbroken series from the time of Paul II., who filled the papal chair from 1464 to 1471. Those that purport to be of earlier popes are all known to be, in point of fact, of later date. The reverse generally bears the cross-keys and mitre, and the obverse the head of the reigning pope. Some of the medals of Julius II., Leo X., and Clement VII. have an especial value, as having been designed by Raphael and Giulio Romano, and engraved by Benvenuto Cellini. A 16th c. medal of Sicily is probably the first instance in modern times of the use of a medal as a vehicle of political satire; it is directed by Frederick II. against his adversary, Ferdinand of Spain, whose head is on the obverse, with the inscription, 'Ferdinandus R. R. Vetus Vulpes Orbis;' and on the reverse a wolf carrying off a sheep, with 'Jugum meum suave est et opus meum leve.' Satirical medals were afterwards common in the Low Countries. A medal representing Van Heubingen, the Dutch ambassador, in the character of Joshua arresting the course of the sun, is said to have so exasperated Louis XIV., who was understood to be typified by that luminary, as to cause the whole hostile force of France to be brought against Holland. Some of the Dutch medals are noted for the elaborate views, maps, and plans engraved on them. France produced few medals prior to the time of Louis XIV.; but there is a series illustrative of the chief events in the life of the Grand Monarque, and another devoted to the career of the First Napoleon. The Spanish medals begin with Gonsalvo about 1500. Scotland produced one of the earliest of modern medals, struck by David II., perhaps during his captivity in England, and formed on the model of the nobles of Edward III. English medals only begin with Henry VIII., and from Edward VI. onwards, there is an unbroken succession of coronation medals. The Scottish gold coronation medal of Charles I. is the first medal struck in Britain with a legend on the edge. The medals of the Commonwealth and Charles II. are by Simon; those of Queen Anne record the achievements of Marlborough. Medals, in connection with NUMISMATICS (q. v.), are treated of by the various writers on that subject.

Medals in the present day are conferred by the sovereign as marks of distinction for eminent worth or noble conduct, more particularly for naval and military services. Such medals of honour are seldom of great intrinsic value, their worth depending merely on the associations connected with them. They have ribbons attached, with clasps or small bars, each of which bears the name of a particular action. The Waterloo medal is of silver, with the head of George IV. (Prince Regent), a winged Victory, and the words 'Waterloo,' 'Wellington;' it hangs from a crimson ribbon, with a narrow stripe of blue near each edge. The Crimean medal, also of silver, is attached to a blue ribbon with yellow edges when worn for service in the Crimea, and to a yellow ribbon with blue edges when for service in the Baltic. Good-service medals of silver were

instituted in 1830 and 1831, and rules formed for their distribution among meritorious sailors, soldiers, and marines. The naval medal is worn suspended from a blue, and the military from a crimson ribbon. There are also various British medals which have been conferred for services in the Peninsula, India, &c. On every medal is engraved the name, rank, &c., regiment or ship of the recipient of it. Medals and decorations do not seem to have been ever conferred as rewards in the army or navy prior to the Commonwealth. The French military medal and the Sardinian war-medal have lately been bestowed to a large extent on British officers, soldiers, seamen, and marines. The former exhibits the effigy of Napoleon III., surmounted by an eagle, and is worn from a yellow ribbon with green borders; the latter is charged with the cross of Savoy, and suspended from a sky-blue ribbon. No medal of honour from any foreign sovereign is allowed to be worn or accepted by any British subject without the sanction of the Queen.

MEDALLION (in Architecture), a circular panel containing a bas-relief of a head, bust, figure, &c.

MEDEA, in Grecian legend, a famous sorceress, the daughter of Aetes, king of Colchis, and of the Oceanid Idyia, or of Hecate. She married Jason, the leader of the Argonauts (q. v.), and aided him in obtaining the Golden Fleece. Jason, after his return home, being desirous to be revenged on Pelias for the murder of his parents and his brother, M. persuaded the daughter of Pelias to cut him in pieces and boil him, in order to make him young again. Jason and she fled to Corinth, where, after she had been his wife for ten years, he repudiated her, to marry Glauce or Creusa, and M., in revenge, sent by her son to her rival a poisoned robe or diadem, the virulence of which destroyed both her and her father. M. then slew the children which she had born to Jason, and fled to Athens in a chariot drawn by dragons, which she obtained from Helios. There she was received by Aegæus, to whom she bore Medos; but afterwards being compelled to flee from Athens, she took Medos to Aria, the inhabitants of which were thenceforth called Medea. She finally became immortal, and the spouse of Achilles in the Elysian Fields. Such is the classic legend, which afforded material for many productions of the tragic muse, and subjects for the painter and sculptor, and which even in modern times has been so employed.

MEDELLI'N, a city of the Granadian Confederation, South America, in the province of Antioquia, and 50 miles south-east of the city of that name, between the ranges of the Central and Western Cordilleras. It is a beautiful town, and, placed at an elevation of about 5000 feet above sea-level, its climate is exceedingly pleasant. It is the entrepôt of trade for the surrounding district, and contains a population estimated at 15,000.

MEDIA, in ancient times, the name of the north-western part of Iran, which was bounded by the Caspian Sea on the N., by Persia on the S., by Parthia on the E., and by Assyria on the W. The northern portion of the country is very mountainous; the south is a rich and fertile tract. M. at present forms the Persian provinces of Azerbijan, Ghilan, Mazanderan, and Irak-Ajemi, and the northern portion of Luristan. The Medians were in language, religion, and manners very nearly allied to the Persians. After they had shaken off the yoke of the Assyrians, their tribes united about 708 a. c., according to the common account, chose Dejoces (Kai-Kobad) for their chief, and made Ecbatana their capital. His son Phraortes, or Arphaxad, subdued the Persians. Cyaxares (Kai-

Kaous), the son of Phraortes, in alliance with Nabopolassar, king of Babylon, overthrew the Assyrian empire about 604 B. C., spread the terror of his arms as far as Egypt and the furthest bounds of Asia Minor, and vanquished the brigand hordes of Scythia, who had carried their ravages as far as Syria. He was succeeded by his son Astyage (Asehak), who was deposed (560 B. C.) by his own grandson Cyrus (Kai-Kaburu), king of Persia; and from this time the two nations are spoken of as one people. Ecbatana, the capital of M., became the summer residence of the Persian kings. After the death of Alexander the Great (324 B. C.), the north-west portion (*Atropatene*) of M. became a separate kingdom, and existed till the time of Augustus; the other portion, under the name of *Great M.*, forming a part of the Syrian monarchy. M. was on several occasions separated from Persia. In 152 B. C., Mithridates I. took Great M. from the Syrians, and annexed it to the Parthian empire, and about 36 B. C. it had a king of its own, named Artavasdes, against whom Mark Antony made war. Under the Sassanian dynasty, the whole of M. was united to Persia. It became, during the 14th and 15th centuries, the stronghold of the Turkoman tribes Kara-Koïnlû, or 'Black Sheep,' and Ak-Koïnlû, or 'White Sheep.'

In early times, the Medes were a warlike race, possessed of an enthusiastic love of independence, and distinguished for their skill with the bow. They were also celebrated for their horsemanship, and it was from them that the Persians adopted this and other favourite exercises and acquirements. In subsequent times, they appear to have become effeminated by luxury. (See the works of Xenophon, Strabo, and Ammianus.)

MEDIATE, in the old German empire, a term applied to those lordships or possessions which were held by feudal tenure under one of the greater vassals, and so only *mediately* under the emperor as the supreme feudal lord. Many of the smaller states or lordships were gradually reduced to this condition as the neighbouring greater states increased in power; and amidst the changes caused by the wars of the French Revolution in 1803 and 1806, many small states were thus *mediatised*, in which the greater states found a sort of compensation for their losses in other quarters. The term continued to be employed even when the feudal sovereignty of the German empire did not exist. At the Congress of Vienna, further mediatisations were effected; and at the present day the people of many of the smaller existing states are anxious for a similar change. The question of mediatisation was one of those affecting the internal welfare of Germany which were most keenly agitated in 1848.

MEDIATOR, a term applicable to any person who endeavours to reconcile parties at variance. In theology, it is employed to denote Jesus Christ, both with respect to his sacrifice of *Atonement* (q. v.)—making God and man *as one* again, by satisfying divine justice, which otherwise demands the punishment of sinners—and with respect to his continual intercession (q. v.). The Roman Catholic Church represents *saints* as mediators of intercession, although not of atonement; but this view is rejected by Protestants.

MEDICAL DEPARTMENT of an Army, next to the commissariat, is the most important of all the non-combatant sections. The surgical treatment of the wounded in actual fighting, and still more the combat with disease engendered by crowding, unhealthy stations, and the reckless habits of the soldiery, necessitate a large medical staff; for, on an average of the whole army, it is found that the

rate of sickness is at least quadruple that for the civil population.

In the British army, every battalion, when at home or in the temperate zone, has a surgeon and an assistant-surgeon; when in India or the tropics, another assistant-surgeon is added. In addition to these officers, there are numerous staff medical officers at all stations, who have charge of detachments, hospitals, &c. The active list of the medical officers comprises (1864) about 320 officers on the staff, and 375 regimental surgeons and assistant-surgeons. Besides these, there are between 400 and 500 medical officers employed with the army in India. The cost of the former to the British treasury is about £167,000 per annum.

The medical department is governed by a director-general, who is a member of the War Office, and has charge of the surgical, medical, and sanitary arrangements of the army. The special duties, pay, &c., of the several ranks, will be found under **INSPECTOR-GENERAL AND SURGEON**.

MEDICAL DEPARTMENT, in the Navy, is only of less importance than the same department in the army, in that the sea-service is vastly more healthy than service upon land. After an action, the surgeon, of course, is in equal requisition in either case. In the British navy, the medical officers in active employ, in 1863, comprised 1 inspector-general, 3 deputy-inspectors-general, 22 staff-surgeons, 171 surgeons, and 272 assistant-surgeons. The pay of these officers varies from £2, 5s. a day for an inspector-general of hospitals and fleets, to 10s. a day for a junior assistant-surgeon.

MEDICAL PRACTITIONERS, in point of law, have lately been put on a new footing in many respects. The late statute (21 and 22 Vict. c. 90) to a certain extent gave the body of medical practitioners powers of self-government, so far as regards qualification and training. All duly qualified persons are now registered, and the register is published, though it is not in strict law compulsory on practitioners to register themselves, the only disadvantage being that those who are not registered cannot fill certain offices, and cannot sue for their fees. Before the late act, physicians were on the same footing as barristers, and could not sue for their fees, these being considered an honorarium which ought to be paid beforehand, and, at all events, were not a legal debt. But the act remedies this defect as regards qualified registered practitioners. Another enactment of the recent statute, which was intended to put down quacks, but which is still found to be capable of evasion to some extent, was the giving of power to justices of the peace to punish with fine of £20 or imprisonment those who falsely pretend to be, or take, or use the name or title of a physician, doctor of medicine, licentiate in medicine or surgery, bachelor of medicine, surgeon, general practitioner or apothecary.

MEDICAL SCHOOL, NETLEY, an establishment for the technical education of medical officers for the British and Indian military service. Candidates are examined competitively in the ordinary subjects of professional knowledge; and, passing satisfactorily through that ordeal, are then required to attend, for six months, at the Military Medical School, where they go through practical courses of military hygiene, military and clinical-military surgery and medicine, and pathology with morbid anatomy. As the school is attached to the Royal Victoria Hospital, which is the great invalid dépôt for the whole army, the students have ample opportunity of seeing theory exemplified in practice. The school comprises four professors, with £700 a year each, and usually about 45 medical candidates, who

receive each 5s. a day and lodging-money. The annual cost of the whole establishment is about £6300.

MEDICI, THE, who ranked among the first and most distinguished families of the Florentine republic, owe their earliest distinction to the success with which they had pursued various branches of commerce, and the liberal spirit in which they devoted their wealth to purposes of general utility. From the beginning of the 13th c., the M. took part in all the leading events of the republic; and from the period when Salvestro dei Medici attained the rank of gonfaloniere in 1378, the family rose rapidly to pre-eminence, although the almost regal greatness which it enjoyed for several centuries is more especially due to Giovanni dei Medici, who died in 1429, leaving to his sons, Cosmo and Lorenzo, a heritage of wealth and honours hitherto unparalleled in the republic. With Cosmo (born 1389, died 1464), on whom was gratefully bestowed the honoured title of 'Father of his country,' began the glorious epoch of the M.; while from Lorenzo is descended the collateral branch of the family, which, in the 16th c., obtained absolute rule over Tuscany. Cosmo's life, except during a short period, when the Albizzi and other rival families re-established a successful opposition against the policy and credit of the M., was one uninterrupted course of prosperity; at once a munificent patron and a successful cultivator of art and literature, he did more than any sovereign in Europe to revive the study of the ancient classics, and to foster a taste for mental culture. He assembled around him learned men of every nation, and gave liberal support to numerous Greek scholars, whom the subjection of Constantinople by the Turks had driven into exile; and by his foundation of an academy for the study of the philosophy of Plato, and of a library of Greek, Latin, and Oriental MSS., he inaugurated a new era in modern learning and art. But although these merits must be conceded to him, it must not be forgotten that while he retained the name of a republican form of government, and nominally confided the executive authority to a gonfaloniere and eight priori or senators, he totally extinguished the freedom of Florence. His grandson, Lorenzo the Magnificent (born 1st January 1448, died 8th April 1492), who succeeded to undivided and absolute power in the state, after the murder of his brother Giuliano in 1478, pursued, with signal success, the policy of his family, which may be characterised as tending to ennoble individuals and debase the nation at large. He encouraged literature and the arts, employed learned men to collect choice books and antiquities for him from every part of the known world, established printing-presses in his dominions as soon as the art was invented, founded academies for the study of classical learning, and filled his gardens with collections of the remains of ancient art; but when his munificence and conciliatory manners had gained for him the affection of the higher and the devotion of the lower classes, he lost no time in breaking down the forms of constitutional independence that he and his predecessors had hitherto suffered to exist. Some few Florentines, alarmed at the progress of the voluptuous refinement which was smothering every spark of personal independence, tried to stem the current of corruption by an ascetic severity of morals, which gained for them the name of *piagnoni*, or weepers. Foremost among them was the Dominican friar Girolamo Savonarola (q. v.), whose eloquent appeals to the people in favour of a popular and democratic form of government, threatened for a time the overthrow of the M.; but the jealousy of the Franciscans, and the vindictiveness of the papal

court, averted their doom. Savonarola's martyrdom restored outward tranquillity to Florence, and left the M. in undisturbed possession of absolute power. Pietro (born 1471), who succeeded his father Lorenzo in 1492, possessed neither capacity nor prudence; and in the troubles which the ambition of her princes and the profligacy of her popes brought upon Italy, by plunging her into civil and foreign war, he shewed himself treacherous and vacillating alike to friends and foes. Lodovico Sforza, surnamed the 'Moor,' relying on the friendship which, from the middle of the 15th c., had prevailed between the Sforza family of Milan and the M., applied to him for assistance in establishing his claim to the duchy of Milan; but seeing that no reliance could be placed on Pietro, he threw himself into the arms of Charles VIII. of France. The result was the invasion of Italy by a French army of 32,000 men. Pietro, in hopes of conciliating the powerful invader, hastened to meet the troops on their entrance into the dominions of Florence, and surrendered to Charles the fortresses of Leghorn and Pisa, which constituted the keys of the republic. The magistrates and people, incensed at his perfidy, drove him from the city, and formally deposed the family of the M. from all participation in power. Pietro, who was slain in 1503, while fighting in the French ranks, and several of his kinsmen, made ineffectual attempts to recover their dominions, which were not restored till 1512. The elevation of Giovanni de Medici to the papal chair, under the title of Leo X., completed the restoration of the family to their former splendour, while the accession, in 1523, of his cousin Giulio Medici to the pontificate as Clement VII., and the marriage of Catharine, the granddaughter of Pietro, to Henry II. of France, and her long rule over that country as regent for her sons, together with the military power of the cadet branch (descended from a younger brother of the 'Father of his country'), threw a weight of power into the hands of the M., which rendered all attempts to maintain even a show of independence futile on the part of the Florentines. The faintest indication of republican spirit was at once crushed by the combined aid of the pope and Charles V.; and though the legitimate male line of Cosmo was extinct (with the exception of Pope Clement VII.), the latter gave, in 1529, to Alessandro, natural son of the last prince Lorenzo II., the rank of Duke of Florence; and on his death, by assassination, without direct heirs, in 1537, raised Cosmo I., the descendant of a collateral branch, to the ducal chair. Cosmo, known as the Great, possessed the astuteness of character, the love of elegance, and taste for literature, but not the frank and generous spirit that had distinguished his great ancestors; and while he founded the academies of painting and of fine arts, made collections of paintings and statuary, published magnificent editions of his own works and those of others, and encouraged trade, for the protection of which he instituted the ecclesiastical order of St Stephen, he was implacable in his enmity, and scrupled not utterly to extirpate the race of the Strozzi, the hereditary foes of his House. His acquisition of Siena gained for him the title of Grand Duke of Tuscany from Pius V.; and he died in 1574, leaving enormous wealth and regal power to his descendants, who, throughout the next half century, maintained the literary and artistic fame of their family. In the 17th c., the race rapidly degenerated; and after several of its representatives had suffered themselves to be made the mere tools of Spanish and Austrian ambition, the last male representative of the line, Giovanni Gaston,

died in 1737, and his only sister the Electress Palatine, the last of the M. family, expired in 1743. In accordance with a stipulation of the Peace of Vienna, the grand duchy of Tuscany passed to the House of Lorraine.

MEDICINA, a town of Italy, in the province of Bologna, 13 miles east of the city of that name. Pop. 6700. It is a thriving place, with considerable trade and large markets. It has five churches and a theatre, and is surrounded by walls. It occupies the site of the ancient city *Claterna*, of which some remains are still visible.

MEDICINAL PLANTS. Those plants of which some part or product is used in medicine, are very numerous, and belong to the most widely different orders. In some orders, particular properties are prevalent; other medicinal species are exceptional as to their properties in the orders to which they belong. Important properties and products are sometimes characteristic of a particular very limited group of species, as in the case of the *Cinchona*. Many medicinal plants are merely used by the people of the countries in which they grow, others—known as *official plants*—have a place accorded them in pharmacopœias and in the practice of educated medical practitioners. Many plants, however, are in high repute among the native physicians of India, which have not yet found a place in any western pharmacopœia, although a few of the most valuable have recently been introduced to notice in Europe. Of the plants which have been rejected from the pharmacopœias, but retain their place in rustic practice, some are really useful, and would be held in greater esteem if there were not preferable medicines of similar quality; others have owed their reputation merely to ridiculous fancies. Some medicinal plants are always gathered where they grow wild, others are cultivated in order to have them in sufficient abundance. This branch of gardening is carried on to a greater extent at Mitcham, near London, than in any other part of Britain. A great boon has very recently been conferred on mankind—so recently that it has scarcely yet begun to be enjoyed—in the introduction of *Cinchona* (q. v.) trees into India, Ceylon, and Java, where their cultivation has been commenced with every prospect of success, a continued supply of Peruvian Bark and of Quinine, their increased abundance, and a diminution of their price, being thus secured.

Among the most valuable books on medicinal plants are Hayne's *Getreue Darstellung und Beschreibung der in Arzneikunde gebräuchlichen Gewächse* (4 vols. Berlin, 1805—1846); Nees von Eenbeck, Weihe, Walter, und Funke, *Vollständige Sammlung officineller Pflanzen* (3 vols. Düsseldorf, 1821—1833).—Pereira's *Materia Medica* is also of very high excellence.

MEDICINE, HISTORY OF. There is reason to believe that Egypt was the country in which the art of medicine, as well as the other arts of civilised life, was first cultivated with any degree of success, the offices of the priest and the physician being probably combined in the same person. In the writings of Moses, there are various allusions to the practice of medicine amongst the Jews, especially with reference to the treatment of leprosy. The priests were the physicians, and their treatment mainly aimed at promoting cleanliness and preventing contagion. Chiron (q. v.), the centaur, is said to have introduced the art of medicine amongst the Greeks; but the early history of the art is entirely legendary. See **ÆSCULAPIUS**.

With a passing allusion to the names of Pythagoras, Democritus, and Heraclitus, who in their various departments may be regarded as having

advanced the art of medicine, we arrive at the time of Hippocrates (q. v.). The advance which Hippocrates made in the practice of medicine was so great, that no attempts were made for some centuries to improve upon his views and precepts. His sons, Thessalus and Draco, and his son-in-law, Polybius, are regarded as the founders of the medical sect which was called the Hippocratic or Dogmatic School, 'because it professed to set out with certain theoretical principles which were derived from the generalisation of facts and observations, and to make these principles the basis of practice.'

The next circumstance requiring notice in the history of medicine is the establishment of the school of Alexandria, which was effected by the munificence of the Ptolemies, about 300 years before the Christian era. Amongst the most famous of its medical professors are Erasistratus and Herophilus. The former was the pupil of Chrysippus, and probably imbibed from his master his prejudice against bleeding, and against the use of active remedies, preferring to trust mainly to diet and to the *vis medicatrix naturæ*. It was about this time that the Empirics formed themselves into a distinct sect, and became the declared opponents of the Dogmatists. The controversy, says Bostock, in his *History of Medicine*, really consisted in the question—how far we are to suffer theory to influence our practice. While the Dogmatists, or, as they were sometimes styled, the Rationalists, asserted, that before attempting to treat any disease, we ought to make ourselves fully acquainted with the nature and functions of the body generally, with the operation of medical agents upon it, and with the changes which it undergoes when under the operation of any morbid cause; the Empirics, on the contrary, contended that this knowledge is impossible to be obtained, and, if possible, is not necessary; that our sole guide must be experience, and that if we step beyond this, either as learned from our own observation, or that of others on whose testimony we can rely, we are always liable to fall into dangerous, and often fatal errors. According to Celsus, who has given an excellent account of the leading opinions of both sects, the founder of the Empirics was Serapion of Alexandria, who was said to be a pupil of Herophilus. At this period, and for some centuries subsequent to it, all physicians were included in one or other of these rival sects, and, apparently, the numbers of the two schools were about equal.

We learn from Pliny that medicine was introduced into Rome at a later period than the other arts and sciences. The first person who seems to have made it a distinct profession was Archagathus, a Peloponnesian, who settled at Rome about 200 B.C. His treatment was so severe and unsuccessful that he was finally banished; and we hear of no other Roman physician for about a century, when Asclepiades, of Bithynia, acquired a great reputation. His popularity depended upon his allowing his patients the liberal use of wine and of their favourite dishes, and in all respects consulting their inclinations and flattering their prejudices; and hence it is easy to understand the eminence at which he arrived. He was succeeded by his pupil Themison of Laodicea, the founder of a sect called Methodics, who adopted a middle course between the Dogmatists and Empirics. During the greater part of the first two centuries of our era, the Methodics were the preponderating medical sect, and they included in their ranks C. Aurelianus, some of whose writings have come down to us. They then broke up into various sects, of which the chief were the Pneumatics, represented by Aretæus of Cappadocia, whose works are still extant; and the Eclectics,

of whom Archigenes of Apamea was the most celebrated. But the most remarkable writer of this age is Celsus (q. v.), whose work *De Medicina* gives a sketch of the history of medicine up to his time, and the state in which it then existed. He is remarkable as being the first native Roman physician whose name has been transmitted to us. The names of Andromachus, the inventor of the Theriaca, a preparation which was retained in our pharmacopœias until the close of the last century—of Pliny the naturalist—and of Dioscorides, cannot be altogether omitted in even the briefest sketch of the early history of medicine; but their contributions to its progress dwarf into insignificance when compared with those of Galen (q. v.), whose writings were universally acknowledged as ultimate authority, until they were attacked and publicly burned in the 16th c. by the arch-quack, Paracelsus (q. v.). A learned and impartial critic, the late Dr Aikin, after giving full credit to Galen for talent and acquirements, thus concludes: 'His own mass and modern improvements have now in a great measure consigned his writings to neglect, but his fame can only perish with the science itself.' As in the case of Hippocrates, his immeasurable superiority over his contemporaries seems to have acted as a check to all attempts at further improvement.

The first names of any renown that occur subsequently to the death of Galen (about 193 A. D.) are those of Oribasius, Alexander of Tralles, Ætius, and Paulus Ægineta, who flourished between the fourth and seventh centuries. They were all zealous Galenists, and those of their writings which are extant, are, for the most part, compilations from their predecessors, and especially from their great master. With the death of Paulus, the Greek school of medicine may be considered to have come to an end, for after his time no works of any merit were written in this language. The Arabian school was now beginning to rise into notice. The earliest Arabic writer on medicine of whom we have any certain account is Ahrum, who was contemporary with Paulus. The most celebrated physicians of this school were Rhazes (who flourished in the 9th c., and was the first to describe the small-pox), Avicenna (q. v.), (who flourished in the 11th c., and whose *Canon Medicinæ* may be regarded as a cyclopædia of all that was then known of medicine and the collateral sciences), Albucasis (whose works on the practice of surgery were for several ages regarded as standard authorities), Avenzoar, and Averrhoes (q. v.), (who flourished in the 12th c., and was equally celebrated as a physician and a philosopher). The works of Hippocrates and Galen, which, together with those of Aristotle, Plato, and Euclid, were translated into Arabic in the 9th c., formed the basis of their medical knowledge; but the Arabian physicians did good service to medicine in introducing new articles from the East into the European *materia medica*—as, for example, rhubarb, cassia, senna, camphor—and in making known what may be termed the first elements of pharmaceutical chemistry, such as a knowledge of distillation, and of the means of obtaining various metallic oxides and salts.

Upon the decline of the Saracenic universities of Spain, which may date from the death of Averrhoes, the only medical knowledge which remained was to be found in Italy, where the school of Salerno acquired a considerable celebrity, which it maintained for some time, till it was gradually eclipsed by the rising fame of other medical schools at Bologna—where Mondini publicly dissected two human bodies in 1315—Vienna, Paris, Padua, &c. Contemporary with Mondini, lived Gilbert, the first English

writer on medicine who acquired any repute; and the next century gave birth to Linacre, who, after studying at Oxford, spent a considerable time at Bologna, Florence, Rome, Venice, and Padua, and subsequently became the founder of the London College of Physicians. It was in this (the 15th) c. that the sect of Chemical Physicians arose, who maintained that all the phenomena of the living body may be explained by the same chemical laws as those which rule inorganic matter. Although the illustrations and proofs which they adduced were completely unsatisfactory, a distinguished physiological school of the present day is merging into a very similar view, with, however, far more cogent arguments in its support. The chemists of that age, with Paracelsus at their head, did nothing to advance medicine, except to introduce into the *materia medica* several valuable metallic preparations.

This period seems to have been prolific in originating new diseases. It is in the 13th, 14th, and 15th centuries that we hear most of leprosy and of the visitations of the plague in Europe. Until the 15th c., hooping-cough and scurvy were unknown, or, at all events, not accurately described; and it was towards the close of that century that syphilis was first recognised in Italy (from which country it rapidly extended over the whole of Europe), and that the Sweating-sickness (*Sudor Anglicanus*) made its first appearance in this country.

In the 16th c., the study of human anatomy may be said to have been first fairly established by the zeal and labours of Vesalius (q. v.); and in this and the succeeding century we meet with the names of many physicians whose anatomical and physiological investigations materially tended, either directly or indirectly, to advance the science of medicine. This was the epoch of Eustachius, Fallopius, Asellius, Harvey, Rudbeck, Bartholin, Malpighi, Glisson, Sylvius, Willis, Bellini, &c. Chemistry was now separating itself from alchemy, and was advancing into the state of a science, and a combination was now formed between its principles and those of physiology, which gave rise to a new sect of chemical physicians, quite distinct from the sect represented two centuries previously by Paracelsus. They considered that diseases were referrible to certain fermentations which took place in the blood, and that certain *humours* were naturally acid, and others naturally alkaline, and according as one or other of these predominated, so certain specific diseases were the result, which were to be removed by the exhibition of remedies of an opposite nature to that of the disease. They were soon succeeded by the Mathematical Physicians, or the Iatro-mathematical school, of which Borelli, Sauvages, Keill, Jurin, Mead, and Freind were amongst the most celebrated. In proportion as this sect gained ground, that of the chemists declined, while the old Galenists were fast disappearing. To these rival sects must be added that of the Vitalists, which originated with Van Helmont (q. v.), and which, with some modifications, was adopted by Stahl and Hoffmann. The greatest physician of the 17th c. was, however, unquestionably Sydenham (q. v.), who, though inclining towards the chemical school, did not allow his speculative opinions regarding the nature of disease to interfere with his treatment.

The most eminent teacher of medicine in the early part of the 18th c. was Boerhaave, who was elected to the chair of medicine at Leyden in 1709. Amongst the pupils of Boerhaave must be especially mentioned Van Swieten, whose commentaries on the aphorisms of his master contain a large and valuable collection of practical observations; and

Haller (q. v.), the father of modern physiology; whilst amongst the most celebrated opponents of the Hallerian theory, that irritability and sensibility are specific properties of the muscular and nervous systems, must be mentioned Whytt and Porterfield, physicians of high reputation in Edinburgh, and the former Professor of Medicine in the university.

In the article upon Cullen (q. v.), so full an account is given of the doctrines of that celebrated physician, that it is unnecessary to add more than that most of the distinguished physicians of the latter part of the 18th c. belonged to what may be termed the Cullenian school of medicine. His views were attacked with great acrimony by his former assistant, John Brown, the founder of the Brunonian system of medicine. In this country, the views of Brown were regarded as too purely theoretical, and did not acquire any great popularity; but on some parts of the continent, and especially in Italy, they were very generally adopted, and became for a considerable time the prevailing doctrine in several of the leading medical schools. To supplement this meagre outline of the progress of medicine in the 18th c., the reader is recommended to consult the biographical sketches of Monro, Blane, the Hunters, Jenner, &c.

If we exclude certain popular quackeries, we may regard the Brunonian as the last of medical sects. The present century may be considered as the epoch of physiological experiment and clinical observation. The efficient labourers in the field of medicine, during the last sixty years, have been so numerous, that it would be impossible to notice, in this article, even those whom we deemed the most celebrated, while it would be invidious to attempt such a selection.

Our materia medica has received a large number of most important additions, amongst which may be especially noticed quinine, morphia, strychnine, iodine and the iodides, the bromides, hydrocyanic acid, cod-liver oil, and chloroform. The physical diagnosis of disease has been facilitated to an extent far beyond what the most sanguine physician of last century could have deemed possible, by the discovery and practical application of the stethoscope, the pleximeter, the speculum, the ophthalmoscope, and the laryngoscope; while chemistry and the microscope have been successfully applied to the investigation of the various excretions, and especially of the urine and its deposits.

The discovery of vaccination as a means of preventing small-pox, although made (see JENNER) at the close of last century, may be regarded practically as belonging to the present, since a considerable time elapsed before its value was generally recognised.

The true and certain diagnosis between typhus and typhoid (or enteric) fever is due to living physicians; and the discoverers of Bright's disease of the kidneys, and of Addison's disease of the supra-renal capsules, have only recently been lost to science.

The treatment of many diseases, especially those of an inflammatory nature, has been much modified, and in most cases improved, especially during the last quarter of a century. The victims to the lancet are far fewer than they formerly were, but if the patients of the present day run little risk of being bled to death, there is an occasional chance of their perishing from the too copious administration of brandy. The moral to be drawn by the unbiassed observer of the depleting and the stimulating modes of treating inflammatory diseases such as pneumonia and pericarditis, is, that nature will often effect a cure even in spite of the interference of too energetic physicians. It is established beyond all question by the statistics which have been collected

by an eminent living physician, that the progress of pulmonary consumption is retarded for an average space of three years by the judicious administration of cod-liver oil; due attention being, of course, paid to the general treatment of the patient.

MEDIOCK (*Medicago*), a genus of plants of the natural order *Leguminosæ*, sub-order *Papilionaceæ*, nearly allied to CLOVER (q. v., *Trifolium*), but distinguished from that and other kindred genera by the sickle-shaped, or, in most species, spirally twisted legume. The species, which are very numerous, are mostly annual and perennial herbaceous plants, with leaves of three leaflets like those of clover, natives of temperate and warm climates. A number of them are found in Britain, and many more in the south of Europe. They generally afford good green food for cattle, and some of them are cultivated like the clovers for this use, amongst which the most important is the PURPLE M. or LUCERNE (q. v., *M. sativa*). Besides this, the BLACK M., NONSUCH, or LUPULINE (*M. lupulina*), is one of the most generally cultivated. It receives the name Black M. from the black colour of the ripe pods, which are short, black, twisted, and arranged in oblong heads, and is often called Yellow Lucerne, or Yellow Clover, from the colour of its flowers. It is a common native of Britain. In habit and general appearance, it is very similar to *Trifolium procumbens*, or *T. Filiforme*. In British husbandry, it is now very generally sown in mixture with Red Clover and Rye-grass, and is useful where a close turf is desired.

MEDIETATE LINGUÆ, JURY DE. See JURY.

MEDINA (Arab. City), or, more fully, **MEDINAT AL NABI** (City of the Prophet), also called **TABAHA, TIRAH, &c.** (the Good, Sweet, &c.), and mentioned by Ptolemy as *Jathrippa*: the holiest city throughout Mohammedanism, next to Mecca, and the second capital of Hedjaz in Western Arabia, is situated about 270 miles N. of Mecca, and 140 N. by E. of the port of Jembo on the Red Sea, and contains about 16,000 inhabitants (Barton). It consists of three principal parts—a town, a fort, and suburbs, of about the same extent as the town itself, from which they are separated by a wide space (the *Munakha*). M. is about half the size of Mecca, and forms an irregular oval within a walled enclosure of 35–40 feet high, and flanked by thirty towers—a fortification which renders M. the chief stronghold of Hedjaz. Two of its four gates—viz., the Bab Al Jumah (*Friday Gate*, in the eastern wall) and the Bab Al Misri (*Egyptian*)—are massive buildings with double towers. The streets, between fifty and sixty in number, are deep and narrow, paved only in a few places. The houses are flat-roofed and double-storied, and are built of a basaltic scoria, burned brick, and palm-wood. Very few public buildings of any importance are to be noticed beside the Great Mosque Al Haram (the Sacred), supposed to be erected on the spot where Mohammed died, and to enclose his tomb. It is of smaller dimensions than that of Mecca, being a parallelogram, 420 feet long and 340 feet broad, with a spacious central area, called El Sahn, which is surrounded by a peristyle, with numerous rows of pillars. The Mausoleum, or Hujrah, itself is an irregular square, 50–55 feet in extent, situated in the south-east corner of the building, and separated from the walls of the mosque by a passage about 26 feet broad. A large gilt crescent above the 'Green Dome,' springing from a series of globes, surmounts the Hujrah, a glimpse into which is only attainable through a little opening, called the Prophet's Window; but nothing more is visible to the profane eye than costly carpets

or hangings, with three inscriptions in large gold letters, stating that behind them lie the bodies of the Prophet of Allah and the two califs—which curtains, changed whenever worn out, or when a new sultan ascends the throne, are supposed to cover a square edifice of black marble, in the midst of which stands Mohammed's tomb. Its exact place is indicated by a long pearly rosary (Kaukab Al Durri)—still seen in 1855—suspended to the curtain. The Prophet's body is supposed to lie (undecayed) stretched at full length on the right side, with the right palm supporting the right cheek, the face directed towards Mecca. Close behind him is placed, in the same position, Abubekr, and behind him Omar. The fact, however, is, that when the mosque, which had been struck by lightning, was rebuilt in 892, three deep graves were found in the interior, filled only with rubbish. Many other reasons, besides, make it more than problematic whether the particular spot at M. really contains the Prophet's remains. That his coffin, said to be covered with a marble slab, and cased with silver (no European has ever seen it), rests suspended in the air, is a stupid story, invented by Christians, and long exploded. Of the fabulous treasures which this sanctuary once contained, little now remains. As in Mecca, a great number of ecclesiastical officials are attached in some capacity or other to the Great Mosque, as Ulemas, Mudarisin, Imaums, Khatibs, &c.; and not only they, but the townspeople themselves live to a great extent only on the pilgrims' alms. There are few other noteworthy spots to be mentioned in M., save the minor mosques of Abubekr, Ali, Omar, Balal, &c. The private houses, however, surrounded by gardens, fountains, &c., have a very pleasing appearance; and the city, although in its decay, is yet one of the busiest and most agreeable. Thirty Medresses, or public endowed schools, represent what learning there is left in the city, once famed for its scholars.

MEDINA SIDONIA (Arab. *Medinatu-Shidunah*, 'City of Sidon,' so called by the Moors because they conjectured it to be the site of the Phœnician *Asidor*), a city of Spain, 25 miles east-south-east of Cadiz. It has a picturesque and splendid appearance at a distance; but within, it is described as 'a whitened sepulchre full of decay.' It is of Moorish origin, and contains a beautiful Gothic church, and extensive ruins of a castle. The town gives the title of duke to the descendants of the famous Guzman the Good, and is otherwise noted in Spanish history. Population 10,800, who carry on manufactures of earthenware.

MEDINET-EL-FAYÛM. See **FAYÛM.**

MEDITATIO FU'GÆ, a phrase used in Scotch law to denote an intention to abscond from the jurisdiction of the ordinary courts. It is used chiefly in reference to debtors. Wherever a creditor in Scotland believes—i. e., can make an oath or affidavit that he has reasonable ground to believe—that the debtor is about to leave the country in order to evade payment of debts, he can obtain from a justice of the peace a warrant to apprehend the debtor. The consequence of this is, that the debtor must either pay or give security, or remain in prison till the cause is tried. The process may be used either against natives or foreigners who have lived forty days in Scotland, but not where they are merely passing through the country on business or pleasure. The warrant may be executed on a Sunday as well as other days. It may also be executed within the Sanctuary of Holyrood. Though creditors often avail themselves of this compulsiory to recover their debts, they are liable to an action, if they maliciously, and without cause, procure the debtor's

arrest; and if the debtor can shew that he never intended, at the time in question, to leave the country, and that the creditor had no just ground to believe he so intended, an action of damages will lie.—In England and Ireland, there is a similar process. See **DEBTORS, ABSCONDING.**

MEDITERRANEAN SEA, so named from its being almost entirely enclosed by the continents of Europe, Asia, and Africa, one of the greatest inland seas in the world, extends (inclusive of the Sea of Marmora, but exclusive of the Black Sea and Sea of Azof) to about 977,000 square miles. Its length from east to west is about 2320 miles, its greatest breadth about 1080, but it is divided into two great basins by the approach of the European and African coasts in its middle. It is connected with the Atlantic Ocean only by the Straits of Gibraltar, through which a strong current continually flows into the Mediterranean. Another strong current also flows into it from the Black Sea, which receives large supplies of fresh water, whereas the great rivers which fall into the M. itself are comparatively few; the principal being the Ebro, the Rhone, and the Po, from Europe; and the Nile, from Africa. It receives no large river from Asia. The evaporation from the surface of the M. is, on the contrary, greater than what takes place in the ocean generally, owing to the heat which proceeds from the African deserts, and the shelter which mountains afford from the cold winds of the north. The temperature of the water at the surface is higher by about 3°·5 F. than in the Atlantic Ocean, and it declines more slowly as the depth increases. In consequence, probably, of the greater evaporation, the water of the M., unlike that of inland seas in general, contains about $\frac{1}{4}$ th per cent. more salt than the Atlantic Ocean. Its specific gravity is almost everywhere greater than that of the Atlantic, being in the proportion of 1·0386 to 1·0283; while within 50 miles of the Strait of Gibraltar, it was found to be as much as 1·1288. Its colour, when undisturbed, is a bright deep blue; but in the Adriatic a green, and in the Levant a purple tinge prevails, while the dark hue of the Euxine is indicated in its name of 'Black Sea.' Different parts of the M. S. bear different names—as the *Egean Sea*, the *Ionian Sea*, the *Adriatic Sea* or *Gulf of Venice*, &c. Its northern coast is very much broken with bays and peninsulas, and abounds in harbours, affording the inhabitants of the south of Europe great advantages for commerce, of which the M. S. was the chief seat during all periods of history, till toward the close of the middle ages, when, after the invention of the mariner's compass, a spirit of maritime adventure sprung up, and the discoveries of the Portuguese and of Columbus led to the extension of commerce over the whole world. The commerce of the Egyptians, the Phœnicians, the Carthaginians, the Greeks, the Romans, &c., was almost entirely confined to the M. S.; and around its shores, until a comparatively recent period, all the great nations of the world flourished, and all the great events of history took place. At present, none of the European nations on the coasts of the M. S., with the exception of France, occupies a place among the greatest nations of the world, whilst the inhabitants of its Asiatic and African shores have sunk into deep degradation.

The depth of the M. S. is generally greatest in its western basin. In many places it is 3000 feet deep. Near Nice, it is 4200 feet deep at a distance of only a few yards from the shore. In many places it is 5000 feet deep and more. The depth in the Straits of Gibraltar is about 5500 feet. It is highly probable that the coasts of Europe and

Africa were once united here, and have been separated by some great convulsion; it is also supposed that land once stretched from Sicily to Cape Bon in Africa, where now a ridge exists along which there is for the most part a depth of scarcely 200 feet, and in some places of little more than 40 feet, whilst on each side, at a short distance, the depth is more than 6000 feet. The M. S. is subject to the west, north, and north-easterly winds for more than two-thirds of the year, while in spring the south-east and south-west winds prevail. The most formidable of those winds which are peculiar to the M. S. is the *solano* or *levanter*. In the Gulf of Venice, the greatest tides rise about three feet, and in the Great Syrtis, five feet, but in most places the tides are scarcely observable. According to the measurements of the French Egyptian expedition, the surface of the M. S. in the neighbourhood of Alexandria is about twenty-four feet lower than that of the Red Sea at Suez at the time of ebb tide, and about thirty feet lower than the Red Sea there at high water; but more recent measurements have shewn that there is no considerable difference of level.

Of the 643 species of European sea-fishes, 444 inhabit the M. S., some of which are peculiar to it. It has a greater number of species than the British and Scandinavian seas, but does not nearly so much abound in useful kinds. Tunny-fishing is extensively prosecuted on some parts of its coasts. It is rich in red coral, which is procured in great quantity on the coasts of Provence, of the Balearic Isles, and of Sicily, but particularly on the coasts of Bona and Barca in Africa.

The shores of the M. S. are in many parts subject to frequent earthquakes. Besides the existing active volcanoes of Etna, Vesuvius, and Stromboli, there are many evidences of recent volcanic action, and instances have occurred of islands suddenly upheaved by it, where volcanic fires have appeared for a short time.

MEDJIDIE, a Turkish order, instituted in 1852, and conferred after the Crimean campaign, to a considerable extent, on British officers. It has five classes; and the decoration, which differs in size for the different classes, is a silver sun of seven triple rays, with the device of the crescent and star alternating with the rays. On a circle of red enamel, in the centre of the decoration, is the legend in Turkish, whose signification is 'Zeal, honour, and loyalty,' and the date 1268, the Mohammedan year corresponding to 1852; the Sultan's name is inscribed on a gold field within this circle. The first three classes suspend the badge round the neck from a red ribbon having green borders, and the fourth and fifth classes wear it attached to a similar ribbon on the left breast. A star, in design closely resembling the badge, is worn on the left breast by the first class, and on the right breast by the second class.

MEDLAR (*Mespilus*), a genus of trees or shrubs of the natural order *Rosaceæ*, sub-order *Pomeæ*, having a 5-cleft calyx with leafy segments, nearly round petals, a large honey-secreting disk, and 2—5 styles, united together in the flower; but widely separated on the fruit, the upper ends of the bony cells of which are exposed. The COMMON M. (*M. Germanica*), a large shrub or small tree, spiny in a wild state, but destitute of spines in cultivation, is a native of the south of Europe and of the temperate parts of Asia, but is a doubtful native of Britain, although it is to be seen in hedges and thickets in some parts of England. It has lanceolate leaves, not divided nor serrated, solitary large white flowers at the end of small spurs, and some-

what top-shaped fruit, of the size of a small pear or larger, according to the variety. The M. is much cultivated in some parts of Europe, and is common in gardens in England, but it does not generally ripen well in Scotland without a wall. It is very austere, even when ripe, and is not eaten till *bletted*, when its tough pulp has become soft and vinous by incipient decay.

MEDULLA OBLONGATA. See BRAIN.

MEDULLARY RAYS. See EXOGENOUS PLANTS and FITZ.

MEDULLARY SARCOMA is one of the synonyms for that variety of Cancer (q. v.) which is also known as encephaloid, cellular cancer, medullary cancer, fungus medullaris, &c. It grows more quickly, distributes itself more rapidly, and attains a more considerable bulk than any other form of cancer, tumours of this nature being often as large as a man's head, or even larger. Of all forms of cancer, it runs the quickest course, soonest ulcerates, is the most malignant, and causes death in by far the shortest time, often destroying life in a few weeks, or, at furthest, in a few months after its first appearance, unless it has been removed by an operation at an early stage.

When it ulcerates, fungoid growths form upon the surface; they are extremely vascular, and bleed on the slightest provocation. In this state, the disease has received the name of *Fungus hæmatodes*.

MEDUSA. See ACALYPHÆ, and GENERATIONS, ALTERNATION OF.

MEDWAY, a river of England, rises near the northern border of the county of Sussex, and, after a north-east course of upwards of 50 miles, it joins the Thames at Sheerness. At Penshurst, 40 miles from its mouth, it becomes navigable. The chief towns on its banks are Maidstone, Rochester, Chatham, and Sheerness. Large vessels do not ascend above Rochester Bridge, but below that the river widens into an estuary, and forms an important harbour for the navy.

MEEANEE, or **MIYANI**, a village in Sinde, Hindustan, on the Indus, six miles north of Hyderabad, is celebrated as the scene of a great battle fought between Sir Charles Napier and the Ameers of Sinde, February 17, 1843. Sir Charles's force, composed partly of Europeans, and partly of natives, amounted to only 2800 men; that of his foes to 22,000, yet the latter were totally routed, losing in killed and wounded 5000 men. Sir Charles's loss was only 256. The result of this victory was the conquest and annexation of Sinde.

MEERSCHAUM, a mineral existing in many parts of the world. In Europe, it is found chiefly at Hrubshitz in Moravia, and at Sebastopol and Kaffa in the Crimea; and in Asia it occurs abundantly just below the soil in the alluvial beds at Kittisch and Bursa in Natolia; and in the rocks of Eski-Hissar in the same district, it is mined so extensively as to give employment to nearly a thousand men. M., from its having been found on the sea-shore in some places, in peculiarly rounded snow-white lumps, was ignorantly imagined to be the petrified froth of the sea, which is the meaning of its German name. Its composition is, silica, 60·9; magnesia, 26·1; water, 12·0. Almost all the M. found is made into tobacco-pipes, in which manufacture the Germans have been for a long time pre-eminent. Vienna contains many manufactories, in which some very artistic productions are made; and pipes worth a hundred guineas, from the beauty of their designs, are by no means uncommon. The French pipe-makers have lately used M., and have displayed great

taste in their works. When first dug from the earth, M. is quite soft and soap-like to the touch, and as it lathers with water, and removes grease, it is employed by the Turks as a substitute for soap in washing. The waste in cutting and turning the pipes was formerly thrown away, but it is now reduced to powder, mixed into a paste, and compressed into hard masses, which are carved into inferior pipes.

MEERUT, MERUT, or MIRUT, the chief town of a district of the same name in British India, in lat. 29° N., long. 77° 40' E., on the Kali Nuddi, about 42 miles north-east of Delhi. Its most important edifice is the English Church, a fine building, with an excellent organ, and large enough to accommodate 3000 persons. The climate of M. is healthy. Pop. 29,014. The cantonment is situated two miles north of the town; on the opposite side of the stream are quarters of the native infantry. Here, on 10th May 1857, the native troops revolted, shooting their own European officers, firing the bungalows, and massacring the European inmates without respect to age or sex.—The district of M., forming a portion of the Doab (q. v.), has an area of 2332 square miles, and a population of 1,135,032.

MEETING, an assemblage of people called with a view to deliberate on some specified subject, or to accomplish some specified purpose. The proceedings begin with the choice of a chairman, or presiding officer, and consist in the proposing and seconding of resolutions, on which the voice or vote of the meeting is taken. The chairman, in addition to his deliberative vote, is often entitled to give a second or casting vote, in case of equality. Any number of persons may in this country assemble for any purpose not in itself illegal; but the use of force or violence, or any tendency towards it, may entitle the authorities to interfere with a meeting, as an unlawful assemblage. Meetings called, not officially, but by private arrangement, are looked on in the continent as a characteristically English institution; in most parts of the continent, the right of holding such assemblages is more or less restricted by law.

MEGALICHTHYS (Gr. great fish), a genus of fossil heterocercal ganoid fishes, so named from their large size, compared with the other fish of the period. They were covered with large strong rhomboid scales, composed externally of brilliantly polished brown enamel, usually granulated, as in the scutes of the recent crocodile. These scales have been found as large as five inches in diameter. The head was defended by similar strong plates, and the jaws were furnished with immense laniary teeth, of a size rarely attained, even in the largest modern reptiles, and so closely resembling them, that they were for some time considered as having belonged to some crocodilean animal. These teeth—specimens of which have been found measuring four inches long and two broad at the base—were smooth at the point, had a long furrowed root, and a hollow base, in which the new tooth was prepared. Numerous smaller teeth were scattered over the jaw among the large ones. The fish of this genus must have been the terror of the seas they inhabited. Their strong skeleton, large tail, powerful head, and ferocious jaws remarkably suited their carnivorous habits.

Three species have been described from the carboniferous strata of Edinburgh, Glasgow, and the centre of England.

MEGALOSAURUS (Gr. great lizard), a genus of fossil Dinosaurians, or land-saurians, of gigantic size and carnivorous habits, whose remains occur in

the rocks of the Oolite period. The huge body of the animal was supported on four large and strong unguiculate limbs; specimens of the femur and tibia have been found measuring each nearly three feet, giving a total length of almost two yards to the hind leg; and a metatarsal bone thirteen inches long shews that the foot had a corresponding magnitude. The sacrum was composed of five vertebrae, ankylosed together, as in the other Dinosaurs. Buckland calculated that the megalosaurus must have been 60 or 70 feet long; but it is not likely that a reptile raised so high above the ground would have its body and tail so large in proportion to its limbs, as in our modern lizards or crocodiles. There seems good reason for rather accepting Owen's more moderate estimate of thirty feet as its whole length. A fragment of the lower jaw, containing several teeth in position, tells of its carnivorous habits. Only a single species has been referred to this genus. Its remains are abundant in the Stonefield slate, in the lower Oolite of Gloucestershire, and in the Wealden and Purbeck limestones.

MEGAPODIDÆ, a family of Birds, referred by some naturalists to the order *Gralla*, but more generally to the Gallinaceous order, being regarded as allied to the Curassows, &c. The feet are large and have large blunt claws. To this order belong the genera *Megapodius* (see JUNGLE-FOWL), *Leipos* (q. v.), *Talegalla* (q. v.), &c. The order is peculiar to New Holland and the neighbouring islands.

MEGARIC SCHOOL. See EUCLID.

MEGARIS, a small mountainous region of Hellas, or Greece Proper, bounded by Attica, Corinth, and the sea. It formed the north-eastern part of the Isthmus of Corinth. The capital was MEGARA, famous amongst the ancients for its white shell marble, and for a white kind of clay, of which pottery was made.—From Euclid, the philosopher, who was born at Megara, about 400 B. C., the MEGARIC SCHOOL took its name.

MEGATHERIUM (Gr. great beast), a gigantic extinct quadruped of the order Edentata, nearly allied to the sloth, found in the superficial stratum of the South American Pampas. In structure, it is very near its modern representative, except that



Skeleton of the Megatherium.

the whole skeleton is modified to suit the requirements of an immense heavy-boned and heavy-bodied animal, some 18 feet in length and 8 feet in height. The appellation tardigrade, which Cuvier applied to

the sloth, cannot be given to the M.: its limbs were comparatively short and very strong, and the feet adapted for walking on the ground, approaching in this respect nearer to the allied ant-eaters, but with this peculiarity, that the first toe of each of the hind feet was furnished with a large and powerful claw, which was probably used as a digger to loosen roots from the soil, and enable the creature the more easily to overturn the trees on the foliage of which it browsed. The enormous development of the bones of the pelvis, the hind legs, and the tail, gave the animal great power when, seated on its hind legs and tail, as on a tripod, it raised its fore legs against the trunk, and applied its force against a tree that had already been weakened by having its roots dug up. The structure of the lower jaw seems to indicate that the M. was furnished with a huge prehensile tongue like that of the giraffe, with which it stripped the foliage from the trees.

The remains of several allied genera of huge Edentata are associated with the M. in the Pampas deposits. They form the family Megatheriidae of Owen, which includes *Myodon*, *Megalonyx*, *Sceleotherium*, &c., genera which are separated from M. chiefly from peculiarities in the dentition.

The modern sloth is a native of South America, and the fossil remains of these immense creatures, which represented it in the newer Tertiaries, have been found only in this continent, the past and present distribution of the family being the same.

ME'GRIM (Gr. *hemigrana*, the *migraine* of the French) is the popular term for neuralgia occupying one half of the head, or more commonly only the brow and forehead of one side. It is often periodical, coming on at a certain hour, lasting a certain time, and then entirely disappearing for a fixed interval. It may be induced by any cause that debilitates the system; it not unfrequently attacks women who have suckled their children too long; or it may be associated with hysteria; or it may arise, like ague, from marsh miasma; and sometimes no exciting cause can be detected.

When it is associated with anemia (paleness and general debility), it should be treated with the preparations of iron, the shower-bath, nourishing food, and plenty of exercise in the open air. When it is strictly periodical, quinine in full doses should be tried (the bowels being previously well cleared out); and if the quinine fails, Fowler's solution of arsenic, given in small doses (three minims in a wine-glassful of water), three times a day, after meals, will be almost sure to remove it.

MEGRIMS: and **VERTIGO** are the terms usually applied when a horse at work reels, and then either stands for a minute dull and stupid, or falls to the ground, lying for a time partially insensible. These attacks come on suddenly, are often periodical, are most frequent during hot weather, and when the animal is drawing up a hill, or exposed during heavy work to the full rays of a hot sun. Liability to megrims constitutes unsoundness, and usually depends upon the circulation through the brain being temporarily disturbed by the presence of tumours. Horses subject to megrims are always dangerous; if driven at all, they should be used with a breastplate or pipe-collar, so as to prevent, as much as possible, pressure on the veins carrying the blood from the head; they should be moderately and carefully fed, and during hot weather have an occasional laxative.

MEHEMED or **MEHEMET ALI**, also **MOHAMMED ALI**, Viceroy of Egypt, was born in 1769 at Kavala, a little town in Macedonia, entered the Turkish army at an early age, and, in 1799, was

sent to Egypt at the head of a contingent of 300 troops to co-operate with the British against the French invaders. Here his fine military qualities rapidly developed themselves, and he at length became commander of the Albanian *corps d'armée* in Egypt. In 1806, he was recognised by the Porte as Viceroy of Egypt, and Pasha of Three Tails; but was soon involved in disputes with the Mamelukes, who had long practically ruled Egypt. The struggle was finally terminated in 1811, by the massacre of the greater number of these at Cairo. The rest fled to Upper Egypt, but were expelled by M. in the following year. They then took refuge in Nubia from their remorseless foe, but in 1820 he followed them thither, and they were utterly exterminated.

The Porte now felt alarm at his growing power, and with a view to break it, intrusted him with the command of an expedition against the Wahabis, a religious sect of Arabia. But the victories of his son, Ibrahim Pasha (q. v.), only rendered him more powerful, and his authority extended itself over a great part of the Arabian peninsula. Shortly after, he conquered Kordofan, added it to his dominions, and opened up a great trade in black slaves from the interior of Africa. About this time he began to reorganise his army on something like European principles, built a fleet, and erected fortresses, military workshops, and arsenals. His ambition, however, received a severe check by the total destruction of his new navy at Navarino, in 1827. In 1830, the Porte conferred on him the government of Candia, but this did not satisfy him; and in the following year, on a frivolous pretext, he sent out an army for the conquest of Syria, under Ibrahim Pasha, who, by his victory at Konieh (20th December 1832), brought the Turkish government to the brink of ruin. The European powers now stepped in, and a treaty was concluded (May 4, 1833), by which Syria was ceded to M., on condition of his acknowledging himself a vassal of the sultan. Neither of the belligerents was satisfied, and M. continued to plot in his usual secret and crafty style, till Sultan Mahmud was obliged in 1839 to declare war against his dangerous subject. The European powers again interfered, and M. saw himself compelled to give up all his claims to the possession of Syria, and to content himself with getting the pashalic of Egypt made hereditary in his family. If the infirmities of age had not now begun to tell upon M., he might have become what many in fact have pronounced him to be—the regenerator of Egypt! He thoroughly cleared the country of robbers from Abyssinia to the mouths of the Nile; he may almost be said to have introduced the cultivation of cotton, indigo, and sugar into the country. While Syria was under his rule, he increased to an immense extent the mulberry plantations, and consequently the cultivation of silk; and to crown all his efforts, he established in Egypt a system of national education! In his last years, he fell into a sort of religious dotage, and at last, in 1848, resigned his viceroyship in favour of his son, Ibrahim Pasha (q. v.). M. died August 2, 1849.

MEI'NINGEN, the capital of the duchy of Saxe-Meiningen-Hildburghausen, lies in a narrow valley, on the banks of the Werra. Pop. 6700. The ducal castle, built in 1691, contains a fine library and several art collections. The 'English garden' attached to it is one of the finest in Germany. M. has almost no trade.

MEI'SSEN, one of the oldest towns in the kingdom of Saxony, is situated on the left bank of the Elbe, 15 miles below Dresden. Its chief building is the cathedral, the finest Gothic church in Saxony,

surmounted by an exquisite spire of open work, and containing many monuments of very early times. There are here a number of brasses, some of them finer than any in England or Flanders. M. was founded in 928 by Henry I. of Germany, as a bulwark of his German territories against the Slavonians, and was long the capital of the markgrafdom of M., which was subsequently merged in the duchy of Saxony. Otto I. founded the cathedral. It was, however, burned down at the beginning of the 13th c.; rebuilt, 1266—1293; since which time it has been twice destroyed by fire, and restored. The castle, built on a precipitous rock overlooking the town, and formerly the residence of the markgrafs, burggrafs, and bishops of M., was rebuilt in 1471; and in 1710, was converted into a porcelain factory, in which the famous Dresden china is made. In this factory, 600 hands, of whom 150 are painters, are employed. The other chief manufactures are leather, hosiery, artists' colours, and brushes, &c. Pop. about 10,500.

MELA, POMPONIUS, a Latin writer—the first who composed a strictly geographical work—was a native of Spain, and is believed to have lived in the time of the Emperor Claudius, but nothing whatever is known concerning him. M.'s compend is in three books, and is entitled *De Situ Orbis*. The text is greatly corrupted, on account of the abundance of proper names; but the style is good, and the author shews a very creditable diligence of research and discrimination in the use of his authorities. The *editio princeps* appeared at Milan in 1471; the best edition is that of Tzschuckius (Leip. 1807). M. was translated into English as long ago as 1585.

MELALEUCA. See CAJEPUT.

MELANCHOLIA, as a disease, is the exaggeration of the natural and legitimate feelings of grief, dependency, and apprehension, which become morbid where the emotion is without a cause, disproportioned to the actual cause, or so intense as to disturb and destroy the exercise of the other mental powers. This dejection and suffering is found associated with exalted sensations, or delusions as to the personal or physical condition of the individual, which originate in habitually cherishing certain impressions, in fixing the attention upon certain vital processes, which may be unhealthy, or become so by the very concentration of thought bestowed upon them. The patient lives in fear of death, in the conviction that he is differently or more exquisitely constructed than those around; that he labours under some foul or fatal disease; that he is destitute of strength or comeliness. This has been regarded as hypochondriacal melancholia—the *maladie anglaise*, and affects the opening of life. Similar feelings are called forth in reference to the social position. There arises a dread of poverty and want. The victim is haunted by imaginary debts, obligations, peculations. He feels incapable of extricating himself. The poor, as well as the rich, entertain such doubt and dread. They starve, in order to husband their resources. This affection prevails at maturity—at the period of greatest activity and usefulness. Towards the decline of life—although encountered at every age—morbid depression assumes the form of religious anxiety, despair, remorse. Moral statistics shew that among the inhabitants of Northern Europe the number of cases of melancholia exceeds those of mania; and it has been supposed that the rudiments of the malady may be detected in the original character, the temperament and the habits of the race, as well as in the climate, domestic condition, and diet, by which these are modified. Defective blood nutrition, or

anæmia, appears to be the physical state with which the great majority of cases of melancholia are connected, and to which all modes of treatment are directed. Powerful and permanent and depressing moral emotions act as effectively in arresting healthy digestion and alimentation, as the use of injudicious food, or the use of proper nourishment under circumstances such as the respiration of impure air, or indulgence in intemperate or degraded tendencies, which render assimilation impossible. The aspect of the melancholiac corroborates the view of inanition and exhaustion. The surface is pale, dry, cold, attenuated, even insensible; the muscles are rigid; the frame is bent; the eyes sunk, and fixed or flickering; the lips parched and colourless. There is a sense of exhaustion or pain, or impending dissolution. It has been remarked, that in proportion to the intensity of the internal agony is there an obtuseness or anæsthesia to wounds or external injuries. Such an immunity gives in lunatics an indifference to the most grievous forms of suffering, and may explain the conduct of many reputed martyrs and even criminals under punishment.—Haalam, *Observations on Madness and Melancholy*; Esquirol, *Maladies Mentales*, t. i. p. 398; Crichton, *Inquiry into Nature and Origin of Mental Derangement*.

MELANCHTHON, PHILIP, Luther's fellow-labourer in the Reformation, was born, 16th February 1497, at Bretten, in the Palatinate of the Rhine, now in the grand duchy of Baden. His name was originally Schwarzerd (black earth), of which M. is a Greek translation. He was educated at the university of Heidelberg, where he took the degree of Bachelor of Philosophy in 1512. In the same year he went to Tübingen, studied theology, took the degree of Master, and in 1514, gave lectures on the Aristotelian philosophy and the classics. About this time, he published a Greek grammar. On his relative Reuchlin's recommendation, he was appointed, in 1518, professor of the Greek language and literature in Wittenberg. He soon decided in favour of the Reformation, and brought to the aid of Luther great attainments in learning, great acuteness in dialectics and exegesis, a remarkable power both of clear thinking and of clearly expressing his thoughts; and, along with all, a gentleness and moderation that most advantageously tempered Luther's vehemence. In 1521, he published his *Loci Communes Rerum Theologicarum*, the first great Protestant work on dogmatic theology. It passed through more than fifty editions in the course of the author's life. In 1530, he made a most important contribution to the cause of Protestantism in the Augsburg Confession (q. v.). In 1541, he went to Worms, and soon after to Ratisbon, to conduct the cause of the Protestants in the conferences there. But the influence of the papal legate counteracted all his efforts for a peaceful accommodation, and his own party were much dissatisfied on account of the concessions which he made. After Luther's death, M. lost in some measure the confidence of some of the Protestants, by those concessions to the Roman Catholics which his anxiety for peace led him to make; whilst the zealous Lutherans were no less displeased because of his approximation to the doctrine of Calvin on the Lord's Supper. His consent, conditionally given, to the introduction of the Augsburg Interim (q. v.) in Saxony, in 1549, led to painful controversies; and he was involved in various controversies, which filled the latter years of his life with disquietude. He died at Wittenberg, 19th April 1560. M., although gentle, was emotional and excitable, and conciliatory in the extreme. As a public teacher, he was exceedingly admired, and

students flocked to him from all parts of Europe. He was essentially a theologian and scholar, and in his habits, if not in his opinions, was the precursor of those acute and laborious divines who have in modern times shed so much lustre on the German church. The most complete edition of his works (which comprise a Greek and Latin Grammar, editions of and commentaries on several classics and the Septuagint, biblical commentaries, doctrinal and ethical works, official documents, declarations, dissertations, responses, and a very extensive correspondence with friends and the leading men of the age) is that by Bretschneider in his *Corpus Reformatorum* (23 vols. 1834—1860). M.'s life has been written by his friend Camerarius (1566), and frequently in the course of the present century. The latest is that by Wöhlahrt (1860). The tricentenary of M.'s death (April 19, 1860) was celebrated with great solemnity throughout Germany.

MELANORRHŒA, a genus of trees of the natural order *Anacardiaceæ*.—To this genus belongs the **BLACK VARNISH TREE** (*M. usitata*) of Burmah and the north-east of India, called *Theet-tee* or *Ziti* in Burmah, and *Kheo* in Munipoor. It is a very large tree, attaining a height of 100 feet, with large, leathery, simple, entire, deciduous leaves, and axillary panicles of flowers. It yields a viscid rust-coloured juice, which becomes black on exposure to the atmosphere, and is excessively acrid, causing swellings with much pain and fever if it touches the skin. It is, however, much valued as a varnish for painting boats, and vessels intended to contain liquids, and also as a size-glue in gilding. This black varnish is a considerable article of trade in India and Burmah.

MELANTHA'CEÆ, a natural order of endogenous plants; containing bulbous, tuberous, and fibrous-rooted plants, with or without stems, and having parallel-veined leaves which are sheathing at the base. The fruit is a capsule, generally divisible into three pieces.—There are about 130 known species, natives of all parts of the world, but most abundant in northern countries. Some resemble crocuses, and some are like small lilies. The order is characterised by a great prevalence of poisonous qualities. Some of the species are employed in medicine, particularly *Colchicum* (q. v.), White Hellebore (*Veratrum album*, see HELLEBORE), and *SABADILLA* (q. v.). The root of *Helonias dioica* is used in North America as an anthelmintic and tonic bitter. The plant grows in wet places, and is called *Starwort* and *Blazing Star*, also *Unicorn's Horn* and *Devil's Bit*.

MELASTOMA'CEÆ, a natural order of exogenous plants, containing about 1200 known species; trees, shrubs, and herbaceous plants, mostly natives of warm climates, although a few are found in the temperate parts of North America. They have opposite undivided leaves, destitute of dots. The flowers are regular.—None of the *M.* possess poisonous properties; some are used in dyeing; the gratefully acid leaves of some are cooked and eaten—particularly those of species of *Medinilla* and *Astronia papularia* in the Malay Archipelago; some yield eatable and pleasant fruits, as *Blakea triplinervis* in Guiana, *Clidemia hirta* in the West Indies, and *Memecylon edule* in Coromandel. The wood of some is tough and hard.

MELBOURNE, capital of the British colony of Victoria, in Australia, is situated chiefly on the north bank of the Yarra-Yarra, about nine miles by water and two miles by land above its mouth, in the spacious bay of Port-Phillip. Lat. 37° 48' S., long. 144° 58' E. Its streets are straight, regular, and wide, and are paved, macadamised, and

plentifully supplied with gas and fresh water. Collins Street, the finest in the city, is one-third wider than the famous Broadway of New York. M. is built of brick and stone, and contains many fine churches. Perhaps nothing gives stronger testimony to the wealth and enterprise of the inhabitants of M., than the rapidity with which so many noble institutions as adorn the city have sprung up among them. Among these, one of the chief is the university, with an annual endowment from the state of £9000, and possessing valuable scholarships and exhibitions. It is a large building, in the shape of a parallelogram, and is surrounded by extensive grounds. It was opened in April 1855, was attended, in 1861, by 105 students, who are classified as attending lectures on law, on civil engineering, and on arts. The new post-office, a magnificent structure in the Italian style, elaborately ornamented with sculpture, and having one of its façades surmounted by four towers, was opened in 1859. The Yan-Yean water-works, by means of which water is conveyed by iron pipes into all parts of the city from a distance of 18 miles, were opened in December 1857. The Parliament Houses, the cost of which, when finished, will be, it is estimated, £400,000, were commenced in 1855. In 1861, £178,778 had been expended on their construction. Besides these, the chief institutions are the Melbourne Hospital, the Benevolent Asylum, the Immigrants' Home, the Orphan Asylums, the Lying-in-Hospital, Treasury, County and City Courts, Public Library, Custom-house, Barracks, the numerous richly-ornamented banks, the Grammar-school, Scotch College, besides many other educational establishments, and numerous literary and scientific institutions and societies. M. is the centre of four converging lines of railway. The temperature is moderate; the mean of the year being 59°, and the variation between the average temperature of January (midsummer) and July (winter), 19°. The annual rainfall is about 32·33 inches. M. occupies the first rank among the ports of the British colonies, and is the most important trading town of the southern hemisphere. The population, including the suburbs, in 1862, was 139,916. In 1861, 3598 vessels, of 1,090,002 tons, entered and cleared the ports of the colony of Victoria; and of these, 3023 vessels, of 995,082 tons, entered and cleared the port of M., which is thus shewn to carry on six-sevenths of the commerce of the whole colony. For further information regarding trade, &c., see VICTORIA. Vessels drawing 24 feet can come up to the mouth of the Yarra-Yarra, but are unable to ascend the river, on account of two bars which obstruct its course. M., however, is connected with Sandridge on Port Phillip by means of a railway two miles long. The chief industrial establishments of M. are flour-mills, tallow-boiling works, and brass and iron foundries.

PORT-PHILLIP, on which M. is situated, is a spacious and beautiful inlet of the South Pacific Ocean, on the south coast of Australia, and is 35 miles long, by about 25 miles broad. Its entrance, which is only 2 miles in width, is formed by two projecting promontories, called the Heads; and on these promontories strong fortifications were in process of erection in 1861. Navigation at the entrance of the port is rendered dangerous on account of the foul ground on either side, and the violence of the ebb and flood tides caused by the unevenness of the bottom.

M. was first colonised in 1835, and received its name from Lord Melbourne, then the British prime minister, in 1837. It became the seat of a bishop in 1847, and in 1851 the capital of the newly-formed colony of Victoria. The discovery of gold

in Victoria in 1851, which gave such a surprising impetus to the material prosperity of M., is treated of under VICTORIA.

MELBOURNE, WILLIAM LAMB, VISCOUNT, English Minister, was second son of Sir Peniston Lamb, of Brocket Hall, Herts, who was raised to the peerage. M. was born in London in 1779. His university education he received first at Trinity College, Cambridge, and next at Glasgow, where he studied jurisprudence and politics under Professor Millar. He entered the House of Commons for Leominster in 1805, and joined the Whig opposition, under the leadership of Charles James Fox. He accepted the chief secretaryship of Ireland in Mr Canning's government, and this partial alienation from the Whigs was increased when he not only took office under Lord Goderich, but remained for a short time in the government of the Duke of Wellington. In 1823, the death of his father transferred him to the Upper House. In 1830, he accepted the seals of the Home Office in the government of Earl Grey, but his administration was by no means popular or successful. In July 1834, Earl Grey retired, and William IV. sent for Melbourne. In November, the king chose to consider the removal of Lord Althorp to the Upper House as the breaking up of the Melbourne Ministry, and sent for Sir Robert Peel, to form a Conservative administration. But the House of Commons resented the interference of the Crown; and a new parliament having shattered the new government, M. again became First Lord of the Treasury. On the accession of Queen Victoria in 1837, it became the duty of M. to instruct the young sovereign in the various duties of her high station, and fit her to perform her part as the constitutional monarch of a free country. In 1841, his government was succeeded by that of Sir Robert Peel. Henceforward, M. took little part in public affairs. He had little of the oratorical faculty, and was ineffective as a speaker, but possessed a cheerful temper and cordial frankness of manner, which made him many friends. He possessed classical tastes and rare social qualities, joined with an easy temper and careless habits. Sydney Smith, in his second letter to Archdeacon Singleton, has described his character with an exquisite mixture of sarcasm and compliment. He married (1805) a daughter of the Earl of Bessborough, who, under the title of **LADY CAROLINE LAMB** (born 1785, died 1828), attained some celebrity as a novel-writer and a correspondent of Lord Byron. M. died November 24, 1848.

MELCHITES, the name given to Christians in Syria and other parts of the East, who, acknowledging the authority of the pope, and the doctrines of the Church of Rome, adhere to the liturgy and ceremonies of the Eastern Church. They conduct divine service in the vernacular tongue, and receive the Lord's Supper in both kinds. Their priests may be married before ordination, but not their bishops. They are chiefly to be found in Aleppo and Damascus. Their patriarch resides at Damascus. The name M. (lit. Royalists) dates from the 5th c., when they were supported by the emperors against the Monophysites (q. v.).

MELCOMBE REGIS AND WEYMOUTH. See WEYMOUTH.

MELEGNANO, or **MALEGNANO**, formerly **MARIGNANO**, a town of Northern Italy, 10 miles south-east of Milan, has a population of 4500. It is famous as the scene of a great victory won by Francis I. of France over the Swiss and Milanese in the month of September 1515: upwards of 20,000 men were slain. This conflict has been termed the *Battle of the Giants*. Francis accepted the honour of

knighthood on the field from the Chevalier Bayard. —A second battle was fought here, 8th June 1859, between a French force of 16,000 men, under Marshal Baraguay d'Hilliers, and a rather larger body of Austrian troops, in which the latter were routed with a loss of about 1400 killed and wounded.

MELENDEZ VALDES, DON JUAN, one of the most distinguished of the modern Spanish poets, was born March 11, 1754, at the village of Ribera del Freano, in Estremadura. He studied at Madrid, and subsequently at Salamanca, where he became intimate with the poet Cadalso, and acquired a thorough knowledge of English. It was Locke, he said, who first taught him to reason, and his writings contain imitations of Pope, Thomson, and Young. In his earlier period, he wrote admirable Anacreontics in praise of student-life; his descriptive poetry is also excellent. His style and sentiment are simple and natural; and the national idioms are used with singular grace and vigour. The first collection of his verses appeared in 1785, and soon became very popular. Four years before this publication, M. V. was appointed a professor at Salamanca, and high political honours even seemed in store for him, but during the French invasion he allowed himself to be cajoled by Murat, and afterwards by Joseph Bonaparte; a weakness which was as disastrous to his prospects as it was discreditable to his character. When the invaders were driven out of the Peninsula, the unhappy poet was forced to accompany them. He died, a proscribed traitor, at Montpellier, May 21, 1817. M. V.'s Anacreontics are the writings on which his fame rests, and they have procured for him the title of *Restaurador del Parnaso*.

MELIA'CEÆ, a natural order of exogenous plants, containing nearly 200 known species, trees and shrubs, natives of warm climates, and mostly tropical. Many of the species possess bitter, astringent, and tonic properties; some are used in medicine; the seeds of some yield useful oil; some are poisonous; some yield pleasant fruits; the wood of some is valuable. See **CARAPA**.—The **Lansch** is the most esteemed fruit of this order; and next to it is *Milnea edulis*, a fruit of the north-east of India, of which the edible part is the large succulent aril.—The **CAPE ASH** (*Elkebergia Capensis*) deserves notice among the timber trees of this order. It has a trunk two feet in diameter, and yields excellent tough timber, useful for many purposes.—*Melia Azedarach*, a tree about forty feet high, with large bipinnate leaves, a native of Syria and other parts of the East, has long been much planted as an ornamental tree in the south of Europe, and is now common in the southern states of North America. Its flowers are in large spikes, and very fragrant. The fruit is of the size of a cherry, somewhat elongated, pale yellow, containing a brown nut. The nuts are bored and strung for beads in Roman Catholic countries, whence the tree is often called **BEAD TREE**. It is also known as the *Pride of India*, and is sometimes erroneously called *Persian Lilac*. The fruit is sweetish, and not poisonous, although very generally reputed so. The bark of the root, which is bitter and nauseous, is used as an anthelmintic. The pulp of the fruit of the **NEEM TREE** or **MARGOSA TREE** (*Azadirachta Indica*) yields a fixed oil, which is bitter, stimulant, and anthelmintic. The bark is a valuable tonic. The leaves are universally used in India for poultices.

MELIC GRASS (*Melica*), a genus of Grasses, having a lax panicle, and spikelets of 2—5 awnless florets, of which one is generally imperfect. *M.*

MELILOT—MELON.

eniflora is a common grass in Britain, growing in the shade of woods. It is of a graceful and delicate appearance. Cattle are fond of it. *M. nutans* is a rarer British species. *M. altissima*, a Siberian species, growing to the height of 3 or 4 feet, has been introduced in some parts of Europe, and yields a considerable bulk of herbage. It is perennial.

MELILOT (*Melilotus*), a genus of clover-like plants of the natural order *Leguminosæ*, with ternate leaves, differing from the clovers in the generally elongated racemes of flowers, the stamens not adhering to the corolla, and the 1-4-seeded tumid pods. All the species have a strong peculiar sweetish smell, which becomes more agreeable when they are dried, and is owing to the presence of Coumarin (q. v.).—The **COMMON YELLOW M.** (*M. officinalis*) is found in bushy places and the borders of fields in Britain and most parts of Europe. It has an erect stem, two or three feet high, and long loose axillary racemes of yellow flowers. A water distilled from the flowers is used in perfumery. The herbage is relished by cattle, but the produce is not large. It is an annual, but if frequently mowed without being permitted to flower, lives for several years.—The **WHITE M.** (*M. vulgaris* or



Melilot.

leucantha), common in some parts of Europe, has become naturalised in many places in Britain.—The **BLUE M.** (*M. cærulea*), a native of the north of Africa, with short racemes of blue flowers, is cultivated in many parts of Europe, particularly in Switzerland and the Tyrol, and has the peculiar M. odour in a high degree. It was formerly much used in medicine as an anodyne, discutient, diuretic, sudorific, expectorant, and vulnerary; and to the many good qualities supposed to belong to it may be ascribed the high estimation in which the *Schabzieger* or *Chapzieger* cheese of Switzerland is held, to which it imparts its flavour. Where this cheese is made in considerable quantities, the smell of M. can be discerned even at a distance.—**BOX-HARA CLOVER** (*M. arborea*) has attracted attention on account of the fibre of its stem, which is used for the same purposes as hemp.—The **Messina M.** (*M. Messinensis*), a native of the countries near the Mediterranean, is believed to be one of the plants called *Lotus* by the ancients.

MELIORATIONS, the name used in Scotch law to denote the improvements made by a tenant to the estate or farm which he occupied. If the

lease is terminated prematurely and abruptly, he is entitled to compensation from the landlord for the value of the improvements; it is otherwise in England. Similar claims exist in Scotland in the case of heirs of entail or life-renters improving the estate.

MELIPHA'GIDÆ. See **HONEY-EATER.**

MELI'SSIC ACID AND MELISSIN. See **WAX.**

MELODRA'MA (Gr. *melos*, a song, and *drama*) strictly denotes a half-musical drama, or that kind of dramatic performance in which declamation is interrupted from time to time by instrumental music. The name, however, was first applied to the *opera* by its inventor, Ottavio Rinuccini. In Germany, the melodrama retains its primitive character; but both in France and England the name has come to designate a romantic play, generally of a serious nature, in which great prominence is given to splendid decoration, to sensational incidents, and to an effective dénouement.

MELODY (Gr. *sweet song*) is a succession of musical notes regulated so as to be pleasing to all cultivated ears, and expressive as a whole of some particular feeling. It is opposed to Harmony, in which different notes, being chords, are sounded together. The part intended for the leading voice in a harmonised piece of music is often called the *melody* or *air*. The character of a melody depends in a great degree on the rhythm and measure, as the same succession of sounds may, by the slightest change in the power of the notes, be so altered in character as to produce a different effect.

MELON (*Cucumis melo*), a plant of the same genus with the Cucumber (q. v.), much cultivated for its fruit, which is sweet, with a delicious though peculiar flavour and smell. The M. is an annual, with trailing or climbing stems, lateral tendrils, rounded angular leaves, small, yellow, monoecious flowers, and large round or somewhat ovate fruit. It is supposed to be a native of the sub-tropical parts of Asia, although it has never been discovered in a wild state, and it was first introduced into England from Jamaica about 1570. It is said to



Common and Water Melon.

derive its name from the Grecian island Melos. Its English name was originally *Musk Melon*. The varieties in cultivation are very numerous, some of them distinguished by a thick and warty rind, some by a rind cracked in a net-like manner, some by ribs and furrows, some by a perfectly smooth and thin rind; they differ also in the colour of the *flesh* of the fruit, which is green, red, yellow, &c.; and in the size of the fruit, which varies from three or four

inches to a foot or more in diameter. The *M.* is eaten either by itself, or with sugar, and sometimes with pepper or ginger. The *M.* can be grown in the open air only in the most southern parts of Britain, and even there requires a hot-bed in spring. Its cultivation in hot-beds is extensively carried on in all parts of Britain, and very great care is bestowed on it. A loamy soil is best suited to it. The setting of the fruit by dusting the female flower with the pollen of the male flower, is constantly practised by gardeners. Warmth and bright sunshine are requisite to the production of fruit of good quality.—The WATER *M.* or CITRUL (*Cucumis citrullus*), although rarely cultivated in Britain, is highly esteemed and much cultivated in almost all warm countries. It is a native of the warm parts of the old world. It has deeply lobed and gashed leaves, and a large round fruit with smooth dark-green spotted rind, and pink or white flesh, less sweet than the *M.*, but much more juicy or watery, and therefore much prized in many warm countries, not merely as an article of food, but for quenching thirst and allaying fever.—South Africa has another species of WATER *M.* (*C. Caffer*), very valuable to the inhabitants.—The CHATE (*C. Chate*) is a native of Egypt and Arabia. Its taste is sweet, and as cool as the water melon.—The KAUKOOR (*C. utilis-simus*) is a native of India, and much cultivated in some parts of that country; it has oval fruit, smooth, variegated with different shades of yellow, and about six inches long, with much the flavour of the melon. The fruit will keep for several months, and is much used both raw and in curries. The half-grown fruit is pickled. The seeds contain much farina and oil, and are ground into meal; the oil is also expressed, and used both for food and in lamps. The seeds of others of this genus may be used in the same way; and they are said to be useful as a diuretic medicine, and for relief of strangury.

MELORIA, a small island in the Mediterranean, about five miles in length and one in breadth, four miles from Leghorn. In 1284, the Genoese gained a famous naval victory over the Pisans in the vicinity of *M.*, by which the latter were deprived of their maritime supremacy. An ancient Pisan tower stands on a rock to the south of Meloria.

MELPOMENE (the Singing One), one of the nine Muses, specially invoked as the muse of Tragedy.

MELROSE, a pleasant village at the foot of the Eildon Hills, on the south bank of the Tweed, having a population of 1141, at the last census. It is famous for the ruins of its noble Cistercian abbey, founded by King David I. in 1136. The original pile having been destroyed during the Wars of the Succession, the monastery began to be rebuilt about 1326. The work was helped by large grants from King Robert Bruce, and his son King David II., but proceeded so slowly that it was scarcely finished at the Reformation, in the middle of the 16th century. It was in the Second Pointed style, with one or two approaches to Third Pointed, and was beyond doubt the most beautiful structure of which Scotland could boast in the middle ages. What now remains are the chief portions of the conventual church, measuring 251 feet in length, and some fragments of the cloister, which would seem to have been a square 150 feet deep. The tracery and carvings, cut in stone of singular excellence, are scarcely surpassed by any in England. In the pages of Scott, *M.* shines with a splendour which its meagre history fails to sustain. Its line of abbots shewed one saint, St Waltheof, the stepson of its royal founder. King Alexander II. chose

his sepulture within its walls; Bruce left it the legacy of his heart; and it gave tombs to that flower of Scottish chivalry, the Knight of Liddesdale, and to his kinsman, the heroic Douglas who fell at Otterburn. But its annals have little else to record. As a seat of piety and learning, its renown is eclipsed by the older and humbler monastery founded by St Aidan, about the middle of the 7th c., and commemorated by the Venerable Bede as the home of Eata, of Boisil, of Cuthbert, and of Drythelm. 'Old Melrose,' as it was called after the 12th c., stood about two miles below the modern abbey, on a beautiful promontory almost encircled by the Tweed. It was burned by Kenneth, king of Scots, in 839, and seems never to have recovered the blow. After it had lain waste for many years, we hear of it about 1073, as giving shelter, for a short season, to a few fugitive monks. All that survived the erection of the later abbey was a chapel dedicated to St Cuthbert, and still famous about the middle of the 15th c. as a resort of pilgrims. The *Chronica de Mailros*, a series of brief obits and annals from 731 to 1275, has been twice printed, first among the *Quindecim Scriptores Historia Anglicana*, published by Bishop Fell at Oxford in 1684; and again by Mr Joseph Stevenson, for the Bannatyne Club, at Edinburgh in 1835. The charters of the more modern abbey were printed by Mr Cosmo Innes, at Edinburgh in 1837, for the same society, at the cost of the Duke of Buccleuch, in two sumptuous quartos, with the title of the *Liber S. Marie de Melros*.

MELTON-MOWBRAY, a market-town of England, in the county of Leicester, and 16 miles north-east of the town of that name, on the Eye near its junction with the Wreak, which is navigable to the Soar-Navigation, about 11 miles above the town. Bobbin-net is manufactured, and pork-pies are extensively made, chiefly for retail in the London, Manchester, and Leeds markets. In the vicinity are numerous hunting-seats, and the town, with stabling accommodation for 800 horses, is the central rendezvous of the famous Melton Hunt. Pop. 4446.

MELUN, an ancient town of France, capital of the department of Seine-et-Marne, built on an island and on both banks of the Seine, 23 miles south-east of Paris. It is neither beautiful nor important. The manufactures are cement, bricks, tiles, and hats, and there is a trade in timber, grain, and flour. *M.*, the *Melodunum* of the Romans, was taken by Clovis in 494, was stormed five times during the 9th c. by the Northmen, and fell into the hands of the English, after a siege of six months, in 1419, and was held by them for ten years. Pop. (1862) 7858.

MELVILLE, the name of an island, a sound, and a peninsula in the north polar regions of America.—The Island is in lat. between 74° 30' and 77° N., long. between 105° 40' and 117° 30' W. Greatest length, 200 miles; greatest breadth, 130 miles. It is separated on the west by Fitzwilliam and Kellet Straits from Prince Patrick Island, the most western island of these regions. In 1819, Lieutenant Parry, who gave its name to *M.* Island, passed the winter here with his crews, in the vain hope of finding in summer a passage westward to the Pacific.—*M.* Sound, about 250 miles long by 200 miles broad, extends immediately south-east of *M.* Island. It communicates with the Arctic Ocean on the west by Banks' Strait, and with Baffin's Bay on the east by Barrow Strait and Lancaster Sound.—*M.* Peninsula, abutting from the continent of British North America, is bounded on the north by the Fury and Hecla Strait, and connected with the mainland by Rae Isthmus. It is 250 miles in

length by about 100 miles in average breadth. Lat. 66° 10'—69° 50' N., long. 81°—87° W.

MELVILLE, ANDREW, an eminent Scottish reformer, was born 1st August 1545, at Baldovy, on the banks of the South Esk, near Montrose. He was educated at the grammar-school of Montrose, whence he removed in his fourteenth year to the university of St Andrews. Here he remained four years, and left it with the reputation of being 'the best philosopher, poet, and Grecian of any young master in the land.' He then proceeded to Paris, where he continued his studies for two years. His reputation must have been already considerable, for in his twenty-first year he was chosen Regent in the college of St Marceon, Poitiers, whither he had gone, a perfect stranger, to acquire a knowledge of law. Some time afterwards, he proceeded to Geneva, where he was more in his element, both politically and religiously, and where, by the influence of his friend Beza, he was appointed to the chair of Humanity in the Academy. He returned to Scotland in 1574, and was, in the course of the same year, appointed Principal of the university of Glasgow, where his scholarship, energetic discipline, and intrepidity of character, exercised a most quickening and elevating influence. When the Regent Morton exclaimed on one occasion: 'There will never be quietness in this country till half a dozen of you be hanged or banished,' M. is said to have replied: 'Tush, man; threaten your courtiers so. It is the same to me whether I rot in the air or in the ground; and I have lived out of your country as well as in it. Let God be praised, you can neither hang nor exile His truth!' In 1580, M. was chosen Principal of St Mary's College, St Andrews. Here, 'besides giving lectures on theology, he taught the Hebrew, Chaldee, Syriac, and Rabbinical languages.' In 1582, he preached the opening sermon before the General Assembly, and boldly 'inveighed against the bloody knife of absolute authority, whereby men intended to pull the crown off Christ's head, and to wring the sceptre out of his hand.' The Assembly applauded his intrepidity, drew up a remonstrance in a similar spirit, and appointed M. and others to present it. In less than two years, M. was summoned before the Privy Council, on account of a sermon preached at St Andrews. He declined to appear, maintaining that whatever a preacher might say in the pulpit, even if it should be called treason, he was not bound to answer for it in a civil court until he had been first tried in a church court. For this denial of secular jurisdiction he was condemned to imprisonment, but escaped to London, where he remained till the downfall of Arran in the following year. After an absence of twenty months, he returned to Scotland, and resumed his office at St Andrews. He was repeatedly elected Moderator of the General Assembly, and Rector of the university. A remarkable instance of his plain speaking took place at Cupar in 1596. M. was heading a deputation to 'remonstrate' with the king. James reminded the zealous remonstrant that he was his vassal. 'Sirrah!' retorted M., 'ye are God's silly vassal; there are two kings and two kingdoms in Scotland: there is King James, the head of this commonwealth; and there is Christ Jesus, the King of the church, whose subject James the Sixth is, and of whose kingdom he is not a king, nor a lord, nor a head, but a member.' In 1605, M. was called to England to attend the famous conference at Hampton Court. Having ridiculed the service in the chapel-royal in a Latin epigram, he was summoned before the English Privy Council, where his temper gave way, and he broke out into a torrent of invective against the Archbishop of Canterbury for encouraging popery

and superstition, profaning the Sabbath, &c. The king, violating every principle of justice, immediately sent him to the Tower, where he remained for more than four years. In 1611, he was released, on the solicitation of the Duke of Bouillon, who wanted his services as a professor in his university at Sedan in France. M., now in his sixty-sixth year, would fain have gone home to Scotland to lay his bones there, but the king would on no account hear of such a thing; and he was forced to spend his old age in exile. M. died about 1622, but neither the date of his death nor the events of his last years are ascertained. See *Life of Andrew Melville* by Dr M'Crie (2 vols. 1819).

MELVILLE, HERMAN, an American author, was born in New York, August 1, 1819. At the age of eighteen, he shipped as a common sailor on a voyage to Liverpool; and in 1841, he went again before the mast on a whaling voyage to the Pacific. Ill treated by the captain, he deserted at Nukaheva, Marquesas Islands, and was kept four months as the prisoner of a savage tribe in the Typee Valley, whence he was rescued by an Australian whaler, and taken to Tahiti. After visiting the Sandwich Islands, he shipped on a United States' frigate, and returned to Boston in 1843. In 1846, the first literary result of his adventures was published in *Typee*, a spirited account of his residence in the Marquesas. *Omoo*, a continuation of his adventures in Oceania, appeared in 1847, in which year he married a daughter of Chief-justice Shaw of Massachusetts. *Mardi*, a strange philosophical romance, in 1848, was followed by *Redburn* in 1849; *White Jacket, or the World in a Man-of-War*, 1850; *Moby Dick, or the White Whale*, 1851; *Pierre, or the Ambiguities*, 1852; *The Piazza Tales*, 1856; *The Confidence Man*, 1857; *Israel Potter*, 1860; when he left his farm in Massachusetts, and embarked in a whaling vessel on a voyage round the world.

MELVILLE, VISCOUNT. See DUNDAS.

MEMBERED, in Heraldry. When a bird has its legs of a different colour from its body, it is said to be membered of that colour.

MEMBRANA PUPILLA'RI, the name given to a very thin membrane which closes or covers the central aperture of the iris in the fœtus during a certain period of gestation, but which disappears in the seventh month.

MEMBRANE, in Anatomy. This term is applied to designate those textures of the animal body, which are arranged in the form of laminae, and cover organs, or line the interior of cavities, or take part in the formation of the walls of canals or tubes. The structure and special uses of some of the most important of the animal membranes are noticed in separate articles, such as **MUCOUS MEMBRANE**, **SEROUS MEMBRANE**, &c.; and the membranes in which the fœtus is enclosed—commonly called the fetal membranes—are described in the article **PLACENTA**. The membranes which cover and protect the brain and spinal cord are commonly termed *Meninges*, from the Greek word *meninx*, a membrane.

MEMEL, a governmental district of Prussia, forming its most northerly boundary towards Russia, and included in the circle of Königsberg. The chief town, Memel, situated in 55° 43' N. lat., and 21° 6' E. long., and lying at the northern extremity of the Kurisches Haff, at its opening into the Baltic, is a well-fortified, active seaport. Pop. (1862) 17,590. It has an excellent large harbour, and is the centre of an active trade in corn, wood, hemp, and amber; the produce of Lithuania and other Russian provinces being brought thither for exportation. The

town itself, which is surrounded by an unproductive sandy plain, possesses several good manufactories for the preparation of brandy, soap, linseed-oil, &c., and extensive saw-mills, iron-foundries, and amber and iron works, the last of which are noted alike for their strong cables and their light and elegant cast-iron goods. Ship-building is carried on at M., which owns about 100 ships, and has a good school of navigation; 2500 ships (of 550,000 tons) annually enter and leave the port, and steam-packets maintain a communication with many of the other Baltic ports. M. was founded in 1253 by the Livonian order of knights; in 1404 it was fortified by the Teutonic Knights. In consequence of a fire in 1854, it has of late years undergone an almost complete renovation, and is now a clean well-built town.

MEMMINGEN, a town of Bavaria, near the right bank of the Iller, 42 miles south-west of Augsburg. It is surrounded by a wall, carries on manufactures of woollen, cotton, and linen goods, ribbons, hosiery, and copper and iron ware; in the vicinity, hops are extensively cultivated. Pop. 7620.

MEMNON, a celebrated hero, the son of Tithonus and Eos or Aurora, who led to Troy a host of Æthiopians, to support the cause of Troy after the fall of Hector. He was said to be clad in armour made by Hephestus or Vulcan, and killed Antilochus, son of Nestor, in single combat. He was killed in single combat with Ajax or Achilles. Others suppose he was ruler of the nations between Susa and Troy, or a vassal of the Assyrian monarch Tautamus, who sent him with 10,000 Æthiopians, and as many Susians, to the Trojan war. After his death, his corpse was carried by Aurora to Susa, and buried in the acropolis of that town, Memnoneia; or his ashes, collected in a silver urn, borne to his sister Himera at Paphos, and thence to Palliochis or Paltos; or to the banks of the Belos, near Ptolemais. The river Paphlagonios flowed from his blood, and his companions were changed into birds. But the M. of the older writers obtained a still greater renown by the name being transferred at a later period by the Greeks to a celebrated colossus, seated in the plains of Thebes, on the left or west bank of the Nile; while the name of Memnoneia was applied by the Egyptian Greeks to the sepulchral quarter of Thebes, as Diospolis was to the right or east bank. Memnoneia, or supposed palaces of M., also existed at Abydos. The two statues—one of which is the celebrated vocal M., one of the wonders of the old world—are at a place called Koum-el-Sultan. Both are seated on thrones, and represent the monarch Amenophis III., of the 18th dynasty, whose name and titles are inscribed on the plinths behind. At the sides of the throne are sculptured the wife and mother of the monarch, about 18 feet high. The height of each of these colossi appears to have originally been 60 feet, and they are made of a coarse hard gritstone or breccia. They are at present known by the sobriquets of Tammy and Shammy, and were originally placed before the propylon of an Amenophion or palace-temple of Amenophis III. in this quarter at Thebes. The easternmost of these colossi is the celebrated vocal statue, distinguished from its companion by having been anciently broken and repaired from the lap upwards with blocks of sandstone, placed horizontally, in five layers. The statue was either injured by Cambyzes, to whom the Egyptian priests ascribed most of the mutilations of the Theban temples, or else thrown down by an earthquake. The peculiar characteristic of this statue was its giving out at various times a sound resembling the breaking of a harp-string or a metallic ring; and considerable difference of

opinion has prevailed as to the reason of this sound, which has been heard in modern times, it being ascribed to the artifice of the priests, who struck the sonorous stone of which the statue is composed, the passage of light draughts of air through the cracks, or the sudden expansion of aqueous particles under the influence of the sun's rays. This remarkable quality of the statue is first mentioned by Strabo, who visited it in company of Ælius Gallus, about 18 B. C.; and upwards of 100 inscriptions of Greek and Roman visitors incised upon its legs, record the visits of ancient travellers to witness the phenomenon, from the 9th year of Nero, 63 A. D., to the reign of the Emperor Severus, when it became silent. Amongst other visitors whose names are recorded are those of the Emperor Hadrian and his wife Sabina; Septimius Severus also visited the statue, and is conjectured to have restored it; for Juvenal mentions it as broken in half, and no notice of it occurs under the Pharaohs or Ptolemies. The identity of this statue and of M. is mentioned in the gloss upon Manetho, and by Pausanias and the inscriptions.—Besides the mythical M., two historical personages of this name are known—one a Rhodian commander of the mercenaries of Artabazus in the war against Artaxerxes-Ochus, who subsequently fled to Macedon, and afterwards entering the Persian service, defended Persia against Alexander, 336 B. C.; but finally died at the siege of Mitylene, 333 B. C.: the other, a Greek historian, who wrote a history of Heracles Pontica, in 16 books, which have been epitomised by Photius.—Welcker, *Epiich. Cycl.* 211; Strabo, xv. 728, xvii. 816; Ælian, *H. A.*, v. 1; Jacobs, *Die Græber des Memnon*; Eusebius, *Hieron.*, p. 154; Juvenal, xv. 5; Letronne, *Sur le Mon. d'Osmyndyas*; Wilkinson, *Top. of Thebes*, p. 33; Vossius, *De Hist. Græc. à Westermann*, p. 226; Diodor. xvi. 52.

MEMORY. This is one name for the great and distinctive fact of mind, namely, the power of retaining impressions made through the senses, and of reviving them at after-times without the originals, and by mental forces alone. The conditions of this power have been already stated (see ASSOCIATION OF IDEAS, HABIT). We shall advert here to some of the arts and devices that have been propounded from time to time, for aiding our recollection in the various kinds of knowledge.

Perhaps the commonest remark on this subject is, that memory depends on Attention, or that the more we attend to a thing, the better we remember it. This is true with reference to any special acquisition: if we direct the forces of the mind upon one point, we shall necessarily give that point the benefit of the concentration, but this does not affect memory as a whole: we merely take power from one thing to give it to another. Memory at large can be improved only by increasing the vigour and freshness of the nervous system, and by avoiding all occasions of exhaustion, undue excitement, and other causes of nervous waste. We may do this by general constitutional means, or by stimulating the brain at the expense of the other functions; this last method is, however, no economy in the end. Every man's system has a certain fund of plastic power, which may be husbanded, but cannot be materially increased on the whole; the power being greatest in early life, and diminishing with advancing years. If it is strongly drawn upon for one class of acquisitions, we must not expect it to be of equal avail for others.

But there may be ways and means of presenting and arranging the matters of our knowledge, so as to make them retained at a smaller cost of the plastic power of the brain. These include the arts of teaching, expounding, and educating in general,

and also certain more special devices commonly known as the arts of Memory, or Mnemonics. A brief account of these last may be given here.

The oldest method of artificial memory is said to have been invented by the Greek poet Simonides, who lived in the 5th c. B. C. It is named the *topical*, or locality memory, from the employment of known places as the medium of recollection. As given by Quintilian, it is in substance as follows: You choose a very spacious and diversely arranged place—a large house, for instance, divided into several apartments. You impress on the mind with care whatever is remarkable in it; so that the mind may run through all the parts without hesitation and delay. Then, if you have to remember a series of ideas, you place the first in the hall, the second in the parlour, and so on with the rest, going over the windows, the chambers, to the statues and several objects. Then, when you wish to recall the succession, you commence going over the house in the order fixed, and in connection with each apartment you will find the idea that you attached to it. The principle of the method is, that it is more easy for the mind to associate a thought with a well-known place, than to associate the same thought with the next thought without any medium whatever. Orators are said to have used the method for remembering their speeches. The method has been extensively taught by writers on mnemonics in modern times. Probably, for temporary efforts of memory, it may be of some use; the doubtful point always is, whether the machinery of such systems is not more cumbrous than helpful.

Much labour has been spent on mnemonic devices for assisting in the recollection of numbers, one of the hardest efforts of memory. The principal method for this purpose is to reduce the numbers to words, by assigning a letter for each of the ten ciphers. This method was reduced to system by Gregor von Feinaigle, a German monk, and was taught by him in various parts of Europe, and finally published in 1812. He made a careful choice of the letters for representing the several figures, having in view some association between the connected couple, for more easy recollection. For the figure 1, he used the letter *t*, as being a single stroke; for 2, *n*, as being two strokes combined; 3, *m*, three strokes; 4, *r*, which is found in the word denoting 'four' in the European languages; 5, *l*, from the Roman numeral *L*, signifying fifty, or five tens; 6, *d*, because the written *d* resembles 6 reversed; 7, *k*, because *k* resembles two 7's joined at top; in place of this figure is also used on occasion *g*, *q*, *c* (hard) as all belonging to the guttural class of *k*; 8, *b*, from a certain amount of similarity, also *w*, for the same reason, and sometimes *v*, or the half *w*; 9 is *p*, from similarity, and also *f*, both of which are united in the word *puff*, which proceeds from a *pipe*, like a 9 figure; 0 is *s*, *x*, or *z*, because it resembles in its roundness a grindstone, which gives out a hissing noise like these letters. The letters of the alphabet not employed in representing figures are to be used in combination with these, but with the understanding that they have no meaning of themselves. Suppose, then, that a number is given, say 547; 5 is *l*, 4 is *r*, 7 is *k*; which makes *l, r, k*; among these letters we insert an unmeaning vowel, as *a*, to make up an intelligible word, *LARK*, which remains in the memory far more easily than the numerical form. In making up the words by the insertion of the unmeaning or *dumb* letters, we should also have regard to some connection with the subject that the number refers to, as, for example, in chronology. Thus, America was discovered in 1492; the letters here are *l, r, p, n*; they may be made into *TO RAPINE*, because that discovery led to rapine by the first

Spaniards. There is, of course, great room for ingenuity in the formation of these suggestive words. Also, a series of numbers may be joined together in some intelligible sentence, which can be easily remembered. Such combinations, however, should be formed once for all in the case of any important series of numbers, as the dates of our sovereigns and other historical epochs. It is too much to expect pupils to construct these felicitous combinations. Feinaigle combined the topical method with the above plan in fixing a succession of numbers in the memory.

Dr Edward Pick, a recent lecturer on mnemonics, has called attention to a peculiar mode of arranging lists of words that are to be fixed in the memory, as the exceptions to grammar rules, &c. He proposes to choose out such words as have some kind of connection with one another, and to arrange them in a series, so that each shall have a meaning in common with the next, or be contrasted with it, or be related to it by any other bond of association. Thus, he takes the French irregular verbs, which are usually arranged in the alphabetical order (which is itself, however, a mnemonic help), and puts them into the following series, where a certain connection of meaning exists between every two: as *sew, sit down, move, go, go away, send, follow, run, shun, &c.* In a case where two words have no mutual suggestiveness, he proposes to find out some intermediate idea that would bring about a connection. Thus, if the words were—garden, hair, watchman, philosophy, he would interpolate other words; thus—garden, plant, hair of a plant—hair; hair, bonnet, watchman; watchman, wake, study—philosophy; and so on. Of course, the previous method is the one that should be aimed at, as the new words are to a certain extent a burden to the mind. Dr Pick further suggests as a practical hint, in committing to memory, that the attention should be concentrated successively upon each two consecutive members of the series; the mind should pause upon the first and the second, until they have been made coherent; then abandoning the first, it should in the same way attend to the second and the third, the third and the fourth, &c. Of course, if every successive link is in that way made sufficiently strong, the whole chain is secure.

There are various examples of effective mnemonic combinations. The whole doctrine of the syllogism (q. v.) is contained in five lines of Latin verse; as regards amount of meaning in small compass, these lines have never been surpassed, if, indeed, they have been equalled. The versification of the rules of the Latin grammar has the same end in view, but all that is gained by this is merely the help from the association of the sounds of the verse in the ear; in comparison with a topical memory, this might be called a rhythmical memory. The well-known rule for the number of days in the different months of the year ('Thirty days hath September, &c.') is an instance of mnemonic verse.

MEMORY, DISEASES OF. Memory, or the power of reproducing mental impressions, is impaired by age, wounds, or injuries to the head or nervous system, fevers, intemperance, and various physical conditions. It is perhaps affected in all kinds of mental derangement, but is in a most signal manner obliterated or enfeebled in *Dementia*. There are, however, examples of recollection surviving all other faculties, and preserving a clear and extensive notion of long and complicated series of events amid the general darkness and ruin of mind. Incoherence owes some of its features to defective or irregular memory. Cases of so marvellous an exaltation and extension of this capacity, as where a whole parliamentary debate could be recalled, suggest the suspicion of unhealthy action. There

appear, however, to be special affections of the faculty. It may be suspended while the intelligence remains intact. Periods of personal or general history may elude the grasp, and even that continuity of impressions which goes far to constitute the feeling of personal identity, is broken up, and a duality or multiplicity of experiences may appear to be conjoined. The converse of this may happen, and knowledge that had completely faded away may, under excitement or cerebral disease, return. There are, besides, states in which this power is partially affected, as in the instances where the numbers 5 and 7 were lost, and where a highly educated man could not retain any conception of the letter F; secondly, where, it appears perverted, recalling images inappropriately, and in an erroneous sequence of order or time, and different from what are desired; and thirdly, where, while the written or printed signs of ideas can be used, the oral or articulate signs are utterly forgotten. All these deviations from health appear to depend upon changes generally of an apoplectic nature in the anterior lobes of the brain.—Crichton on *Mental Derangement*, i. 337; Teuchtersleben, *Medical Psychology*, p. 121.

MEMPHIS, a celebrated Egyptian city, situated in the Delta, or Lower Egypt, the ancient capital of the country, called by the Egyptians *Men nifer*, or 'the Good Station,' by the Hebrews, *Moph*; and by the Arabs, *Memf*. It was founded by Menes, the first monarch of the first dynasty, who, according to Herodotus, changed the bed of the Nile, and made an embankment, 100 stadia above M., to protect the new city against inundations. The remains of this bank still exist at Kafr-el Tyat, about 14 miles above Metrahenny, which is the centre of old M., and the site of the temple of Ptah or Hephæsteum. Menes fortified the city, and laid the foundations of the temple. Uchoreus, a later monarch, is also said to have founded M., and introduced the worship of Apis and Epaphus. The site of the city was well chosen, protected alike by the Libyan and Arabian chains of mountains against the river and the incursions of the sand, defending the approach of the country from the incursions of Asiatic nomads, and communicating with the Red Sea and the Mediterranean. The city was composed of two portions—one built of crude bricks; the other, on which was the citadel, of calcareous stone, called the *Leukon Teichos*, or 'White Wall,' which held some of the principal buildings. The palace, built by Menes, was enlarged by his son Athothis, and was always inhabited either by a monarch or his viceroy. Under the Persian rule, it was occupied by the satrap; and by the Greek mercenaries, under the Saite kings. Under Uchoreus, the total circumference was 150 stadia. After the 6th dynasty, the city declined in importance, and was apparently held by the Hyksos after the 13th and before the 18th (1500 B. C.). At this period, M. was ruled by a viceroy, a prince of the blood, and still remained the religious capital of the old worship. It rose again to great importance under the Saite monarchs, about 600 B. C., who restored it, became the seat of a separate monarchy, and was conquered by Sennacherib and his successors. The temples of this city were magnificent, and comprised the Iseum, a large temple of Isis, completed by Amasis II. just prior to Cambyses (525 B. C.); a temple dedicated to Proteus, in the foreign quarter; the temple of the Apis, having a peristyle and court ornamented with figures, opposite the south propylæum of the temple of Ptah, where the sacred bull resided; the Serapeum, or temple of Os or Apis, in the quarter recently discovered by M. Mariette (see **SERAPEUM**); the

Nilometer, removed by Constantine I. to Constantinople, replaced by Julian III. or the Apostate; a temple of Ra; and the shrine of the Cabiri. Here were the statues of Rameses II., one of which exists as the fallen colossus, Metrahenny, and others have been discovered by Hekekyan Bey in his excavations. These colossi, above 75 feet high, were of Syenitic granite, or of the limestone of Tourah or Mokattam. These temples flourished in all their glory till the Persian conquest. Still more remarkable was the great necropolis of the city, in the centre of which towered the pyramids (see **PYRAMIDS**). During the attempts of the native rulers to throw off the Persian rule, M. was an important strategic point. Ochs inflicted severe injury on this town, having plundered the temples and thrown down the walls after he had driven out Nectanebus. Alexander the Great here worshipped the Apis, and his corpse was brought to this city by Ptolemy before it was finally transferred to Alexandria. The first Ptolemies were crowned in the Serapeum. Ptolemy VIII. destroyed the city, and it had so declined after his time as to become a decayed site. It fell with the rest of Egypt under the Roman rule, and afterwards was conquered by Amru Ben Abas (639—640 A. D.); and Fostat and Cairo were built out of its ruins, which were large and important in the 13th c., when they were seen by Abd-alatif. The few remains of the ancient city are Koum-el-Azyzeh to the north; Metrahenny on the west; and the canal of Bedrachin on the south; but the remains here are submerged many feet in the soil of the Delta.

Herod. ii. 97, 101, 147, 178; Diod. xviii. 34, i. 46, Fragm. t. 33, lvi. p. 184; Thucyd. i. 104; Hygin. xiv. 90; Heliod. ii. 69, 61; Hosea ix. 6; Isaiah xix. 30; Ezek. xxx. 13, 16; Wilkinson, *Top. Thebes*, p. 340; Bunsen, *Egypt's Place*, ii. p. 47; Champollion-Figeac, *L'Égypte*, 35, 63, 205, 286; Lepsius, *Beise*, 20, 51, 63.

MEMPHIS, a city and port of entry on the east side of the Mississippi River, in the south-west corner of Tennessee, United States of America, 420 miles below St Louis. It is handsomely built on a bluff, 30 feet above the highest floods. It is the outlet of a large cotton region, exporting 400,000 bales per annum. It has fine public buildings and hotels, and theatre, 15 churches, 2 medical colleges, 5 daily and 3 weekly newspapers, 7 banks, 7 insurance companies, railways connecting it with New Orleans, Charleston, Louisville, and Little Rock, with several foundries, manufactories of boilers, machinery, &c. In the War of Secession, it fell into the hands of the Federal forces after the fall of Island No. 10 in 1862, and was the base of military operations for the capture of Vicksburg, July 4, 1863. Pop. in 1860, 22,625.

MENADO, an important possession of the Netherlands, on the north of Celebes, forming a residency under the government of the Moluccas, is separated from the Ternate Islands by the Moluccas Strait. The country is volcanic, many of the mountains rising to a great height. The mountainous grounds of the province of Minahassa are well adapted for the growth of coffee, which was first planted in 1820, and speedily became favourably known in the market. The coffee-culture is compulsory, and the produce is monopolised by the government at a fixed price, which, in 1861, was 19s. 3d. the picol (= 132½ lbs. avoirdupois). In 1856, it seems to have reached its limit, being in that year 26,965 picols; while in 1860 it had fallen to 15,010. The quantity of rice grown has been doubled since 1853, as also the value of the import and export trade. In this residency, civilisation and

Christianity make rapid progress. In 1855, the pagans formed by far the greatest portion of the population; in 1860, the Christians outnumbered them by 15,000. The town of Menado is neatly built, has a church, a school for the children of Europeans, and others for those of natives. Population of the residency, 233,000.

MENAGE, **ÆGIDIUS**, or **GILES DE**, a French lexicographer and linguist, was born at Angers in 1613. Disliking the profession of an advocate, he renounced it, along with an office under government, which his father had transferred to him, entered the church, and fixed his residence in the convent of Notre Dame. His time was chiefly spent in literary pursuits, in which he acquired a great reputation. He was an extreme pedant, full of prejudices and bitter hostilities. His *Dictionnaire Etymologique de la Langue Française* (Par. 1650; best ed. by Jault, 2 vols. Par. 1750), and his *Origini della Lingua Italiana*, are erudite and valuable works, although they contain many erroneous etymologies. His poems (Latin, Italian, French, and Greek) are of little worth. He died in 1692.

MENAI STRAIT, which separates the island of Anglesey from the mainland, runs east-north-east from its southern extremity to Bangor, a distance of 13 miles, and there widens out into Beaumaris Bay. Its width varies from about 250 yards to 2 miles. The navigation is hazardous, but the strait is nevertheless much used for the sake of expedition by vessels under 100 tons, and occasionally by some of larger size. At the entrance of the strait, the tides sometimes rise to a height of 30 feet, and the ordinary neap-tide rises from 10 to 12 feet. Communication between Anglesey and the mainland was formerly maintained by ferry-boats at different points; but a Suspension Bridge was constructed by government in the line of the great Holyhead road, and subsequently railway communication was established by means of the Britannia Bridge (q. v.). The scenery on both sides of the strait is mildly beautiful.

MENANDER, the most celebrated Greek poet of the New Comedy, was born at Athens, 342 B. C. His uncle was the comic poet Alexis; he had Theophrastus for his teacher, and Epicurus for a friend; and the influence of all three is discernible in his style of thought and feeling. M. was a handsome, light-hearted, and elegant Greek, somewhat luxurious, but not impure in his manners. He was drowned while swimming in the harbour of the Piræus. M. wrote more than one hundred comedies, which were in high repute among his countrymen, at least after death; but we possess mere fragments of them. We know something of their character, however, from the imitations of them by Terence. Pleasant and refined wit, clear, sententious reflection, and a vein of real earnestness at times, are the qualities most apparent in them. The best edition of the extant fragments of M. is Meineke's *Fragmenta Comicorum Græcorum* (Berl. 1841).

MENCHIKOW, or **MENCHIKOFF**, **ALEXANDER DANILOVITCH**, a Russian field-marshal and minister of state, was born at Moscow, on 28th November 1672. He was a baker's apprentice, when his intelligent countenance attracted the notice of General Lefort, through whose patronage he was taken into the service of Peter the Great. He had the good fortune to discover a conspiracy among the czar's guards, and his rapid promotion was secured. He accompanied Peter in his travels to Holland and England, and on the death of Lefort, was raised to the post of chief adviser. M. was one of the greatest men of his time, excelling equally as a general and a diploma-

tist; and although totally uneducated, he did much to promote the education of the people, and was a liberal patron of the arts and sciences. On the 30th October 1706, he defeated the Swedes at Kalisch; he contributed to some of the czar's other victories; was made a field-marshal on the field of Pultawa; and compelled Löwenhaupt to capitulate with great part of the Swedish army. In 1710, he took Riga; in 1713, he led the Russian troops into Pomerania and Holstein, and took Stettin, but gave it up to Prussia, contrary to the will of the czar. This and his avarice so displeased Peter, that he subjected him to a court-martial. He was condemned to death by a majority of voices; but was pardoned on payment of a heavy fine. During the reign of Catharine I., he regained his influence at court, and after her death, governed Russia with almost absolute authority in the name of Peter II., whose father-in-law he was just about to become, when he was overthrown by Dolgorouki, and banished to Siberia (September 1727). His immense estates and treasures were confiscated. He died 22d October (2d November) 1729.—His great-grandson, **PRINCE ALEXANDER SERGEJEVITCH M.**, was born in 1789, and after being long an attaché of legation at Vienna, served in the campaigns of 1812—1815, rose to the rank of general, and after the accession of the Emperor Nicholas, was employed both in diplomatic and military services. In the Turkish campaign of 1828, he took Anapa after a short siege, but received so severe a wound before Varna as compelled his retirement. He was afterwards for a time at the head of the Russian navy, and raised it to a high state of efficiency. In March 1853, he was sent as ambassador to Constantinople, where his overbearing behaviour produced a speedy rupture between the Porte and the czar, and brought about the Crimean war. In this war he commanded both the land and naval forces of Russia, and displayed the utmost energy in defending the important fortress of Sebastopol. In March 1855, he was removed from the Crimea, and appointed commander of Cronstadt. M. is one of the most prominent members of the old Russian party.

MENDE, a town of France, capital of the department of Lozère, on the Lot, in a valley surrounded by high hills, about 70 miles north-west of Montpellier. In the vicinity, are numerous villas and gardens. M. has a cathedral surmounted by two spires, and manufactures serges and other coarse cloths. Pop. 5331.

MENDELSSOHN, **MOSES**, an eminent German philosopher, was born on the 7th September 1729 at Dessau. From his father, a Jewish schoolmaster and scribe, he received his first education; and in his 13th year proceeded to Berlin, where, amid very indigent circumstances, he contrived to learn Latin and modern languages, and to apply himself to the study of philosophy, into which early readings, chiefly of Maimonides's *Moreh Nebuchim*, had initiated him already. After many years of comparative indigence, he became the partner of a rich silk-manufacturer, whose children he had educated. The intimate friend of men like Lessing, Sulzer, Nicolai, he, directly and indirectly, contributed in a vast degree to the extermination of the brutal prejudices against the Jews, and the disgraceful laws with respect to them. On the other hand, he acted in the most beneficial manner on his own co-religionists, by rousing them from the mental apathy with which they regarded in his day all that had not a distinct reference to Religion, and by waging fierce war against their own religious and other prejudices. He was also, on account of his immense influence upon them, called another Moses. He died 4th

January 1786, and Ramler wrote the following epitaph on him: 'True to the religion of his forefathers, wise as Socrates, teaching immortality, and becoming immortal like Socrates.' His principal works are—*Pope, ein Metaphysiker* (with Lessing) (Dan. 1755); *Briefe über die Empfindungen* (Berl. 1764); *Ueber die Evidenz der metaphysischen Wissenschaften*, a prize essay of the Berlin Academy, which thereupon unanimously resolved to elect him a member of their body; Frederick the Great, however, generally prejudiced against the Jews, struck his name off the list; *Phaedon, oder über Unsterblichkeit der Seele* (Berl. 1767), a dialogue in the manner of Plato; *Jerusalem, oder über religiöse Macht des Judenthums* (Berl. 1783), chiefly in answer to Lavater's obtrusive, sometimes even offensively worded arguments, by which he intended to convert M. to Christianity, or to prove that he was a Christian already. Further, *Morgenstunden* (Berl. 1785): Morning Conversations with his children and friends, chiefly in refutation of Pantheism and Spinozism. Besides many other smaller Hebrew and German essays, contributions to the *Bibliothek der schönen Wissenschaften*, edited by Lessing (to whom, in a manner, he furnished the prototype to his *Nathan der Weise*), &c., his translation of the Pentateuch and the Psalms deserves a prominent place. His works have been collected and edited by G. B. Mendelssohn (Leip. 1843—1845, 7 vols.).

MENDELSSOHN-BARTHOLDY, FELIX, a German musical composer, son of Abraham Mendelssohn-Bartholdy, the eminent banker, and grandson of Moses Mendelssohn, the philosopher, was born at Hamburg, 3d February 1809. His father was a convert to Christianity, and young Felix was brought up in the Lutheran faith. The affluent circumstances of his parents enabled them to bestow a most liberal and careful education on their son, whose fine genius early shewed itself. Zelter was his instructor in composition, Ludwig Berger on the piano. In his ninth year, he gave his first public concert in Berlin, and in the following year played in Paris. From this period, he commenced to write compositions of all sorts, some of them of a very difficult character, for the piano, violin, violoncello, &c. In 1824, the first of these—three quartets for the piano—were published. In 1825, he went a second time to Paris—his father, on the advice of Cherubini and other eminent artists, having consented that he should devote himself exclusively to music. He now gave concerts both in Paris and Berlin, after which he travelled for three years in England, Scotland, France, and Italy. In the first of these countries, he obtained enthusiastic applause by his overture to Shakespeare's *Midsummer Night's Dream*, which, in its blending of the fanciful, the delicate, and the grotesque, is said to have caught the inspiration of Shakespeare himself. He afterwards wrote music to accompany the whole of the play. His *Isles of Fingal* are a fine memorial of the impression left upon him by the wild scenery of the Western Highlands. His letters from Italy also shew how profoundly he was affected by that glorious land—the true home of art. M. subsequently attempted to start a musical theatre for the cultivation of high art, at Düsseldorf; but it did not succeed. In 1835, he accepted the directorship of the Leipzig concerts. Here he was in the centre of the musical world of Germany, and was stimulated to his highest and most brilliant efforts; yet it was in England that M. first met with a reception proportionate to his genius. His oratorio of *St Paul*, after being performed at Dresden and Leipzig, was produced under his own management at the Birmingham Festival, September 20, 1837, and

created quite a furor. It and his other oratorio of *Elijah*, on which he laboured for nine years, and which was first brought out at the Birmingham festival of 1846, are reckoned his two greatest works. He died at Leipzig, November 4, 1847. Among his best known compositions are his music for Goethe's *Walpurgisnacht*, the *Antigone* and *Œdipus* of Sophocles, *Athalie*, and a great number of splendid sonatas, concertos, trios. In his *Lieder ohne Worte* (Songs without Words), he has achieved a great and novel triumph. M.'s character, which was even finer than his genius, is charmingly delineated in his *Letters*, which have been translated from the German by Lady Wallace (London, 1862).

MENDICANT ORDERS, certain religious associations in the Roman Church, which, carrying out the principle of religious poverty and self-humiliation to its fullest extent, make it a part of their profession to denude themselves of all property, whether real or personal, and to subsist upon alms. As the scriptural foundation of this practice, the words of our Lord (Matt. xix. 21) to the young man who sought counsel of him, and again (verse 27—30) to his own disciples, are commonly alleged, both by the mendicant orders, and in general by all who profess what is called evangelical poverty. In the mendicant orders, alms are commonly collected by the lay-brothers; in some, by actual solicitation; in others, by the ringing of the convent bell when the stock of provisions is exhausted. Formerly, such orders were numerous in the church; but by a decree of the second Council of Lyon in 1274, the mendicant orders were limited to four—the Dominicans, Franciscans, Carmelites, and Augustinians or Austin Friars. See these articles, also **FRIARS**. The rule by which individuals are denied the possession of even personal property, is strictly understood in Catholic countries. In England and Ireland, it was considerably relaxed, but of late years has been enforced with increasing exactness.

MENDIP HILLS, a range in the northern part of Somersetshire, England, extend in a north-west and south-east direction, and are about 25 miles in length, by from 3 to 6 miles in breadth. In former times, the moors of Mendip were attached to the crown as a royal forest, and were frequently hunted over by the Saxon and Norman kings. A considerable portion of the range is now under cultivation. The summit is Black Down, 1100 feet in height. The lead and calamine mines of Mendip (called *grooves*, the miners being called *grooveres*) were in operation before the dawn of history.

MENDOZA, DON DIEGO HURTADO DE, a Spanish classic, distinguished also as a statesman and a general, was born at Granada about 1503, studied there and at Salamanca; and shortly after leaving the latter university, was sent by the Emperor Charles V. as ambassador to Venice. Later, he was present at the Council of Trent as imperial plenipotentiary, and in 1547 was appointed ambassador to the papal court. As a general, he was successful in subjugating Siena, which was handed over to Cosmo I. Medici, as a fief of the Spanish crown. His position, however, was a difficult one; he was hated both by pope and people, and in 1554, the emperor recalled him. During his residence in Italy, he shewed the greatest zeal in collecting literary treasures, especially ancient MSS. He sent learned men for that purpose to Mount Athos, and also took advantage of the regard entertained for him by Soliman the Magnificent, Sultan of Turkey. In 1568, an affair of gallantry terminated in his banishment from court. He withdrew to Granada, where he spent his last years in writing his *Guerra contra*

los Moriscos [History of the War against the Moors—first published (with parts omitted) in 1610, and in a complete form in 1776, by Portalegre, who prefixed a life of the author]. This work is regarded by M.'s countrymen as a masterpiece. M. died in 1576. His library is now one of the ornaments of the Escorial. In his poetical epistles, he gave his country the first good model for that form of composition. His sonnets and serious poems are of inferior merit.

MENDOZA, formerly the capital of a department of the same name in the Argentine Republic (q. v.), was situated on the eastern base of the Andes, 110 miles east-north-east of Santiago, and at a height of 2891 feet above sea-level. It was totally destroyed by an earthquake in 1863, when its buildings were demolished, and most of its inhabitants, 15,000 in number, perished.

MENELA'US, in ancient Greek legend, was king of Lacedæmon, the younger brother of Agamemnon, and husband of the famous Helen. The abduction of his wife by Paris is represented as the cause of the Trojan war. After the fall of Troy, he sailed with Helen for his own land; but his fleet was scattered by a storm, and he wandered for eight years about the coasts of Cyprus, Phœnicia, Ethiopia, Egypt, and Libya. After his return, he lived at Sparta with his wife Helen in great style and happiness.

MENES, the first king of the first Egyptian dynasty, who built Memphis, made foreign conquests, introduced luxury, and was subsequently devoured by a hippopotamus. During his reign, there was a revolt of the Libyans. His name marks a great chronological epoch, being placed by chronologists 3643, 3892 B. C., or even 5702 B. C. Stricter chronologists make his accession 2717 B. C. This name, which signifies the conductor, has been found on inscriptions, but no contemporary monuments of him are known.—Bunsen, *Egypt's Place*, ii. p. 579; Lepsius, *Königbuch, quellentaf.*, p. 5; Böckh, *Manetho*, p. 386; Poole, R. S., *Hor. Egypt*, p. 219.

MENG-TSE (i. e., the teacher Meng; earlier, **MENG-KO**; Latinised by the Jesuits into **MENGIUS**), a Chinese sage, born in the beginning of the 4th c. B. C., in the village of Tsou, in the present district of Shan-tung. He died about 317 B. C. M. is the greatest of the early Confucians. His father died while M. was very young; but he was educated with such admirable care by his mother, that the phrase 'mother of Meng' has become a proverb for an excellent preceptress. At this period, China was divided into a number of states, all acknowledging the suzerainty of the emperor of Tseu. M. travelled to several courts, seeking to introduce his doctrines of 'virtue' and 'justice'; but unfortunately, as too frequently happens, he found that princes and great men did not admire these things so much as poor scholars. His conversations with rulers and state-functionaries, with his disciples and acquaintances, were taken down by his admirers. They form the *Hsi-tsi*, otherwise called the Book of Meng-tse—the fourth of the Four Books. See **CONFUCIUS**. Many of the thoughts are exquisitely true, suggestive, and subtle. Several translations of it have been published, but they fall far short of the energy, sentimentousness, freshness, and vivacity of the original. One of the best is the Latin version of Stanislas Julien, 12 vols. (Paris, 1824). There is also an English one by Collier (Malacca, 1828), and another by Pauthier (Paris, 1851).

MENGS, **ANTON RAFAEL**, a modern German artist and writer on art, was born at Aussig, in

Bohemia, March 12, 1728. His father, Israel Mengs, was himself a painter, but possessed of very mediocre talent, and from him young Rafael received his first instructions in art. At the age of thirteen, he went to Rome, where he remained three years, rigorously devoting his whole time to the study of the works of Michael Angelo, Raphael, and others of the old masters. On his return to Dresden in 1744, he was appointed court-painter to Augustus III., king of Poland and Saxony, but received permission at the same time to go back to Rome. Here he established his reputation by a picture of the 'Holy Family.' The young peasant-girl who sat for the Virgin so charmed the painter by her beauty, that he subsequently passed over to the Roman Catholic Church, and married her. In 1754 he accepted the presidency of the newly instituted Academy of Painting at Rome. Within the next few years, he executed the frescoes in the church of San Eusebio, and those of 'Apollo and the Muses on Parnassus' for Cardinal Albani; besides which, he copied Raphael's 'School of Athens' for Lord Percy, and painted several original pictures in oil, among which may be mentioned a 'Cleopatra,' a 'Holy Family,' and a 'Magdalene.' In 1761, he went to Madrid, on an invitation from Charles III. of Spain, and while there, executed a great variety of works, the best known of which is his 'Aurora'; but ill-health and the intrigues of enemies induced him to return to Italy. He had no sooner arrived, than Clement XIV. employed him on a large allegorical subject for the Vatican Library, representing Janus dictating to History, who appears in the act of writing. After three years, he again visited Spain. To this period belongs his most celebrated effort; it represents the Apotheosis of the Emperor Trajan, and is executed on the dome of the grand saloon in the royal palace at Madrid. Ill-health, however, again forced him to leave Spain. On his way back to Italy, he stopped at Monaco, where he painted his picture of the 'Nativity,' reckoned by many to be his finest piece. Shortly after reaching Rome, he died, 29th June 1779. M.'s works are careful and elaborate imitations of the great masters. He borrowed the technical qualities of a painter in high perfection, but the living soul of genius, the quickening and creative power of imagination was not his. His works, therefore, though lofty in their subjects, seldom exhibit more than a correct and cultivated taste. M.'s writings were edited in Italian by Azara in 1780. There is an English translation (Lond. 1796).

MENIN, a frontier town of West Flanders, Belgium, on the left bank of the Lys, which separates it from France, 30 miles south-south-west of Bruges. It was formerly fortified, but its works have been demolished, and it is now a dismal and lifeless town, with some manufactures. Pop. 8900.

MENINGITIS (Gr. *mēninx*, a membrane) is the term employed in medicine to designate inflammation of the arachnoid and pia mater (the middle and innermost of the membranes investing the brain).

This disease has been divided into three stages—the symptoms of the first being those of excitement, resulting from inflammation; those of the second being those of compression, shewing that an effusion of fluid into the arachnoid cavity has taken place; while those of the third stage vary according as convalescence or death is the result.

Meningitis is especially apt to occur in children of a tuberculous diathesis, in which case the disease is usually described as acute Hydrocephalus (q. v.). Scarletina, measles, and other diseases caused by a blood-poison, may induce it in children. In adult life, the disease may often be traced to the action of

typhous and marsh poisons, to intemperance, sun-stroke, mechanical injuries, &c.

When the disease is due to any of the above-named blood-poisons, or to any constitutional cause, little can be done effectually in the way of special treatment. When it arises from mechanical injuries, bleeding, calomel, active purgatives, and cold applications to the head are often of use. The patient should be kept on low diet, and all mental excitement should be most carefully avoided.

MENIPPUS, one of the most noted of the Cynic philosophers, and a pupil of Diogenes, was born at Gadara, in Syria, and flourished in the 1st c. B. C. He was originally a slave, and acquired considerable wealth by usury, but lost it all again; in consequence of which he strangled himself, out of mortification. He satirised the philosophers of his time in terms so severe, that the most biting satires were afterwards designated Menippean. Lucian pronounces him 'the greatest snarler and snapper among all the old dogs' (the Cynics). His works were thirteen in number, according to Diogenes; they are all lost.

MENISPERMA'CEÆ, a natural order of exogenous plants, mostly tropical and sub-tropical; creeping and twining shrubs, the wood of which is frequently disposed in wedges, and without the zones usual in exogenous stems. The leaves are alternate, generally simple, destitute of stipules; the flowers small, unisexual, often in large panicles or racemes. There are about 200 known species, including those which by some botanists have been formed into the two small separate orders *Schizandraceæ* and *Lardizabaluceæ*. The true M. are generally bitter and narcotic; some of them are very poisonous, and some are valuable in medicine. See **CALUMBA**, **CISSAMPELOS**, and **COCCULUS**.

MENNO, SIMONS, the founder of the later school of Anabaptists (q. v.) in Holland, was born at Witmarsum, in Friesland, in 1496; took orders in 1524, and officiated for some years as a priest, first in the village of Pinjum, and afterwards in his native place. The study of the New Testament, however, about the year 1530, excited grave doubts in his mind regarding the truth both of the doctrine and constitution of the church; and in 1536, he withdrew from it altogether. He now attached himself to the party of the Anabaptists, was rebaptized at Leeuwarden, and appointed a teacher and bishop at Gröningen. Henceforth, his great endeavour was to organise and unite the scattered members of the Anabaptist sect in Holland and Germany. With this design, he spent much time in travelling; but Friesland was his chief residence until persecution compelled him to flee to Wismar. Finally, he settled at Oldeslohe, in Holstein, where he found not only protection, but even encouragement, and was allowed to establish a printing-press for the diffusion of his religious opinions. Here he died in 1561. He was a man of gentle, earnest, modest, and spiritual nature, with no trace about him of the wild fanaticism of the earlier Anabaptists. His book of doctrine, entitled *Fundamentbuch von dem rechten Christlichen Glauben*, was published in 1539. See **ANABAPTISTS**.

MENOPOME (*Protonopsis horrida*), one of the largest of batrachians, found in the Ohio and other rivers of the same region, and known on their banks by many names, such as Hellbender, Mud Devil, Ground Puppy, Young Alligator, and Tweeg. In form, it resembles the newt and salamander; the head is flat and broad; the teeth in two concentric rows in the upper jaw, and one row in the lower, numerous and small; it is about two feet long, and

of a slaty gray colour, with dark spots. Notwithstanding its small teeth, it is fierce and voracious, feeding chiefly on fish and batrachians; and partly



Menopome (*Protonopsis horrida*).

from its habits, partly from its ugliness, is much disliked by the fishermen of the Ohio, who erroneously regard it as venomous.

MENSTRUATION is the term applied to the discharge of blood which issues every month from the generative organs of the human female during the period in which she is capable of procreation.

The first appearance of this discharge, to which the terms *menses* and *catamenia* (each having reference to the monthly period) are indiscriminately applied, is a decided indication of the arrival of the period of commencing womanhood, and is usually accompanied by an enlargement of the mammary glands, and other less important changes. In this country, menstruation usually commences between the 14th and the 16th years, and terminates between the 48th and 52d years. The interval which most commonly elapses between the successive appearances of the discharge is about four weeks, although it is often shorter; and the duration of the flow is usually three or four days, but is liable to great variations. The first appearance of the discharge is usually preceded and accompanied by pain in the loins and general disturbance of the system, and in many women these symptoms invariably accompany the discharge. As a general rule, there is no menstrual flow during pregnancy and lactation, and its cessation is one of the first signs that conception has taken place.

MENSURATION, the name of that branch of the application of arithmetic to geometry which teaches, from the actual measurement of certain lines of a figure, how to find, by calculation, the length of other lines, the area of surfaces, and the volume of solids. The determination of lines is, however, generally treated of under Trigonometry (q. v.), and surfaces and solids are now understood to form the sole subjects of mensuration. As the length of a line is expressed by comparing it with some well-known unit of length, such as a yard, a foot, an inch, and saying how many such units it contains, so the extent of a surface is expressed by saying how often it contains a corresponding superficial unit, that is a square whose side is a yard, a foot, an inch; and the contents of solid bodies are similarly expressed in cubes or rectangular solids having their length, breadth, and depth, a yard, a foot, an inch. To find the length of a line (except in cases where the length may be calculated from other known lines, as in trigonometry) we have to apply the unit (in the shape of a footrule, a yard measure, a chain), and discover by actual trial how many units it contains. But in measuring a surface or a solid, we do not require to apply an

actual square board, or a cubic block, or even to divide it into such squares or blocks; we have only to measure certain of its boundary-lines or *dimensions*; and from them we can calculate or infer the contents. To illustrate how this is done, suppose that it is required to determine the area of a rectangular figure ABCD, of which the side AB is 7 inches, and the side AC 3 inches. If AC be divided at the points F and E into 3 portions, each 1 inch long, and parallels be drawn from F and E to AB or CD; and if AB be similarly divided into 7 parts, of 1 inch each, and parallels be drawn to AC or BD through the points of section, then the figure will be divided into a number of equal squares or rectangular figures, whose length and breadth are each 1 inch; and as there are 3 rows of squares, and 7 squares in each row, there must be in all 7×3 , or 21 squares. In general terms, if a and b be the lengths of two adjacent sides, there are a rows of little squares, and b squares in each row. Hence the area of a rectangle = the product of two adjacent sides.

The areas of other figures are found from this, by the aid of certain relations or properties of those figures demonstrated by pure geometry; for instance, the area of a parallelogram is the same as the area of a rectangle having the same base and altitude, and is therefore equal to the base multiplied by the height. As a triangle is half of a parallelogram, the rule for its area can be at once deduced. Irregular quadrilaterals and polygons are measured by dividing them into triangles, the area of each of which is separately calculated. For the area of the circle, see CIRCLE. By reasoning similar to what has been employed in the case of areas, it is shewn that the volume of a rectangular parallelepiped or prism is found in cubic inches by multiplying together the length, breadth, and depth in inches; and the oblique parallelepiped, prism, or cylinder, by multiplying the area of the base by the height.

MENTONE (Fr. *Menton*), a town in the department of Alpes Maritimes, France. It is pleasantly situated on the shore of the Mediterranean, and from its southern exposure, as well as a high sheltering range of mountains on the north, it enjoys a salubrious and agreeable climate. In its environs are groves of orange, lemon, and olive trees. Lately, M. has become a favourite winter resort of invalids and health loungers from England, Germany, and other countries; and is greatly improved as a place of residence by the addition of numerous hotels, pensions, &c. In 1860, by vote of the inhabitants, M. was detached from the small principality of Monaco, and annexed to France; the French government paying 4,000,000 francs to the Prince of Monaco for relinquishing his rights, and according to him certain privileges. M. is within a mile and a half of the Italian frontier on the railway and Corniche road from Nice to Genoa. Population about 5000.

MENTOR, the son of Alcimus, was the trusted friend of Ulysses, who, on setting out for Troy, left to him the charge of his household, and by him Telemachus was educated. His name became a sort of appellative for an instructor and guide of the young.

MENU. See MANU.

MENURA. See LYRE-BIRD.

MENZA'LEH, LAKE, a lake of Egypt, extends east from the Damietta branch of the Nile, and is separated from the Mediterranean by a narrow strip of land, through which, however, there are several openings. It receives the Pelusiac and Tanitic branches of the Nile, and is 37 miles in length, by

about 16 miles in average breadth. Its surface is studded with islands, the most interesting of which is Tennees, the ancient Tennessus, with Roman remains of baths, tombs, &c. An extensive and thriving fishery is carried on on the lake. The shores abound in wild-fowl, comprising, besides the duck and coot, the heron, the ibis, the spoon-bill, and the pelican.

MENZEL, WOLFGANG, an eminent German author, is the son of a medical practitioner, and was born at Waldenburg, in Silesia, 21st June 1798. He studied at Jena and Bonn, and for two years schoolmaster at Aargau in Switzerland, and in 1824 returned to Germany. He first made himself known in the literary world by his *Streckversee* (Heidelb. 1823), a volume replete with poetry and wit, and opening up many novel and ingenious views of art and literature. He then engaged with several coadjutors in a periodical called *Europäische Blätter* (Zür. 1824—1825), in which war was waged against the prevalent heartlessness and formality of German literature, in which he was led to attack vehemently the school of Goethe. This involved him, however, in a controversy with the extreme admirers of that poet. He was afterwards engaged in a succession of controversies, in consequence of opinions expressed by him in his various publications; among which may be noticed his *Geschichte der Deutschen* (3 vols. Zür. 1824—1825, and several editions); *Die deutsche Literatur* (2 vols. Stuttg. 1828, and several editions); *Taschenbuch der neuesten Geschichte* (5 vols. Stuttg. 1829—1833); *Mythologische Forschungen und Sammlungen* (Stuttg. 1842, &c.); and *Geschichte Europas von 1789—1815* (2 vols., Stuttg. 1853). As a poet, he has acquired a high reputation by a volume entitled *Ribezahl* (Stuttg. 1829), and another entitled *Narcissus* (Stuttg. 1830). His *Gesänge der Völker* (Leip. 1851) is a valuable lyrical collection. After the July revolution, he set himself to counteract the French influence that set in strongly among the youth of Germany, whence Börne gave him the nickname of *der Franzosenfresser* ('the Frenchman-eater'). M. has also taken an active part in the political struggles of Germany since 1830.

MEPPEL, an important trading and manufacturing town in the Netherlands, province of Drenthe, is situated near the northern boundary of Overysseel. Pop. 7000. It has a great trade in butter, cattle, rye, and buckwheat, being the chief market for a large district of country. The principal manufactures are spinning flax, weaving linens, sail-cloth, and coarse striped woollen fabrics. There are also corn, saw, and oil mills, breweries, &c. The union of several important water-ways with the Mepeller Diep, through which they flow into the Zuider Zee, brings a large shipping-trade to the town.

The moss-land throughout the province of Overysseel produced, in 1862, peat to the value of upwards of £200,000, the greatest part of which is forwarded from M. to Amsterdam and other cities of the Netherlands. M. is about nine centuries old, and has often suffered the evils of war, being favourably situated for receiving a garrison.

MEQUINEZ. See MIKNAS.

MERCANTILE LAW. This is the only branch of municipal law which, from the necessity of the case, is similar, and in many respects identical, in all the civilised and trading countries of the world. In determining the relations of the family, the church, and the state, each nation is guided by its own peculiarities of race, of historical tradition, of climate, and numberless other circumstances, which are almost wholly unaffected by the conditions of society in the neighbouring states. But when the arrangements for buying, selling, and transmitting

commodities from state to state alone are in question, all men are very much in the same position. The single object of all is that the transaction may be effected in such a manner as to avoid what in every case must be sources of loss to somebody, and by which no one ultimately is a gainer—viz., *disputes and delay*. At a very early period in the trading history of modern Europe, it was found that the only method by which these objects could be attained was by establishing a common understanding on all the leading points of mercantile, and more particularly of maritime law. This was effected by the establishment of those maritime codes of which the most famous, though not the earliest, was the *Consolato del Mare*. It is sometimes spoken of as a collection of the maritime laws of Barcelona, but it would seem rather to have been a compilation of the laws and trading customs of various Italian cities—Venice, Pisa, Genoa, and Amalfi, together with those of the cities with which they chiefly traded—Barcelona, Marseille, and the like. That it was published at Barcelona towards the end of the 13th c., or the beginning of the 14th, in the Catalonian dialect, is no proof that it originated in Spain, and the probability is that it is of Italian origin. As commerce extended itself to the north-western coasts of Europe, similar codes appeared. There was the *Guidon de la Mer*, the *Rôles d'Oléron*, the *Usages de Damme*, and, most important of all, the Ordinances of the great Hanseatic League. As the central people of Europe, the French early became distinguished as cultivators of maritime law, and one of the most important contributions that ever was made to it was the famous ordonnance of 1681, which formed part of the ambitious, and in many respects successful legislation and codification of Louis XIV. See *CODE*. All these earlier attempts at general mercantile legislation were founded, as a matter of course, on the Roman civil law, or rather on what that system had borrowed from the laws which regulated the intercourse of the trading communities of Greece, perhaps of Phœnicia and Carthage, and which had been reduced to a system by the Rhodians.

From the intimate relation which subsisted between Scotland and the continent of Europe, the lawyers of Scotland became early acquainted with the commercial arrangements of the continental states; and to this cause is to be ascribed the fact that down to the period when the affairs of Scotland were thrown into confusion by the rebellions of 1715 and 1745, mercantile law was cultivated in Scotland with much care and success. The work of Lord Stair, the greatest of all the legal writers of Scotland, is particularly valuable in this department.

In England, the case was very different. After the loss of her French provinces, the legal system of England became wholly insular, and there was no branch in which it suffered more in consequence of being thus cut off from the general stream of European progress than the law-merchant. It was Lord Mansfield who, whether guided by the wider traditions of his original country, or deriving his views from the source from which these traditions sprung, viz., the Roman law, as modified and developed by continental jurisprudence, introduced those doctrines of modern commercial law which English lawyers have since developed with so much acuteness and logical consistency. Many attempts have recently been made to assimilate the commercial laws of England and Scotland, and a commission of lawyers of both countries was recently appointed for the purpose. One of the most important results of their deliberations was the Mercantile Law Amendment Act, 19 and 20 Vict. c. 60.

MERCATOR'S PROJECTION, or **MERCATOR'S CHART**. See *MAP*.

MERCHANTS' MARKS. In the middle ages, it was the practice for merchants, traders, and others to whom the proper use of heraldry was not conceded, to be allowed by the heralds to bear devices indicative of their trades or occupations. A cutler might bear his knife, a tailor his shears, a mason his trowel and compasses. These insignia were in strictness ordered to be borne only in 'targets hollow at the chief flanks,' yet we often find them on shields, and sometimes even impaled and quartered with arms. Merchants, along with a monogram of their initials, often bore a mark composed of a cross and a figure resembling the Arabic numeral 4 turned backwards—perhaps a symbol of the Holy Trinity, though it has also been explained to represent the mast and yard of a ship. The insignia of their companies were frequently borne by merchants in a chief above their marks, and occasionally quartered with them. These merchants' marks were probably the origin of the trade brands and marks of our own time. Many of them are to be seen sculptured on the walls and roofs of the churches of the 14th and 15th centuries, and engraved on monumental brasses both in England and on the continent. Seals with merchants' marks are occasionally found appended to conveyances of land.

MERCIA. See *HEPTARCHY*.

MERCURY. See *HERMES*.

MERCURY, or **QUICKSILVER** (symb. Hg, equiv. 100, sp. gr. 13·6), is one of the so-called noble metals, and is remarkable as being the only metal that is fluid at ordinary temperatures. It is of a silvery white colour, with a striking metallic lustre. When pure, it runs in small spherical drops over smooth surfaces; but when not perfectly pure, the drops assume an elongated or *tailed* form, and often leave a gray stain on the surface of glass or porcelain. Moreover, the pure metal, when shaken with air, presents no change upon its surface; while, if impure, it becomes covered with a gray film. It is slightly volatile at ordinary temperatures, and at 662° it boils, and forms a colourless vapour of sp. gr. 6·976. Hence it is capable of being distilled; and the fact of its being somewhat volatile at ordinary temperatures, helps to explain its pernicious effects upon those whose trades require them to come much in contact with it—as, for example, the makers of barometers, looking-glasses, &c. At a temperature of -39°, it freezes, when it contracts considerably, and becomes malleable. In consequence of the uniform rate at which it expands when heated, from considerably below 0° to above 300°, it is employed in the construction of the mercurial thermometer.

All mercurial compounds are either volatilised or decomposed by heat; and when heated with carbonate of soda, they yield metallic mercury. Native or virgin quicksilver only occurs in small quantity, usually in cavities of mercurial ores. Of these ores, by far the most important is *cinnabar* (q. v.). There are two means of obtaining the metal from the cinnabar: the ore may be burned in a furnace, in which case the sulphur is given off as sulphurous acid, and the mercury is collected in a condensing chamber; or the ore may be distilled with some substance capable of combining with the sulphur—as, for example, with slaked lime or iron filings.

The M. imported into this country is usually almost chemically pure. If the presence of other metals is suspected, it may be pressed through leather, re-distilled, and then digested for a few days in dilute cold nitric acid, which exerts little action on the M., if more oxidisable metals are

MERCURY AND MERCURIALS.

present. The M., after being freed from the nitric acid by washing with water, is chemically pure.

There are two oxides of M., the black suboxide (Hg_2O) and the red oxide (HgO). Both of these lose all their oxygen when heated, and form salts with acids. The *black suboxide*, although a powerful base, is very unstable when isolated, being readily converted by gentle warmth, or even by mere exposure to light, into red oxide and the metal ($\text{Hg}_2\text{O} = \text{HgO} + \text{Hg}$). The most important of its salts is the nitrate ($\text{Hg}_2\text{O}, \text{NO}_3 + 2\text{Aq}$), from whose watery solution ammonia throws down a black precipitate known in pharmacy as *Mercurius solubilis Hahnemanni*, from its discoverer, and consisting essentially of the black suboxide with some ammonia and nitric acid, which are apparently in combination. Of the *red oxide*, the most important salts are the nitrate ($\text{HgO}, \text{NO}_3 + 8\text{Aq}$); the sulphate (HgO, SO_4), which is employed in the manufacture of corrosive sublimate; and the basic sulphate ($3\text{HgO}, \text{SO}_4$), which is of a yellow colour, and is known as *Turpeth Mineral*.

The haloid salts of M. correspond in their composition to the oxides. Of the most important of these—the chlorides—there are the subchloride (Hg_2Cl), well known as Calomel (q. v.), and the chloride (HgCl), or corrosive sublimate.

The *chloride* (formerly termed the bichloride, when calomel was regarded as the protochloride, and the equivalent of Hg was regarded as 200 instead of 100), when crystallised from a watery solution, occurs in long white glistening prisms; but when obtained by sublimation, it occurs in white transparent heavy masses, which have a crystalline fracture, and chink with a peculiar metallic sound against the sides of the bottle in which they are contained. This salt melts at 509° , and volatilises unchanged at about 570° . It has an acrid metallic taste. It is soluble in 16 parts of cold, and in less than three parts of boiling water, and dissolves very freely in alcohol and in ether. Corrosive sublimate enters into combination with the alkaline chlorides, forming numerous distinct compounds. (A double chloride of ammonium and M., represented by the formula $3\text{H}_2\text{NCl}, \text{HgCl} + \text{Aq}$, has been long known as *sal alembrothi*.) It combines with oxide of M. in various proportions, forming a class of compounds of great interest in theoretical chemistry, termed *oxychlorides of mercury*. On adding a solution of corrosive sublimate to a solution of ammonia in excess, a compound, which, from its physical characters, is termed *white precipitate*, is thrown down, which is generally supposed to be a compound of chloride with amide of M., $\text{HgCl}, \text{HgNH}_2$ (Kane). Chloride of M. coagulates albumen, and combines with the albuminous tissues generally, forming sparingly soluble compounds. Hence, in cases of poisoning with the salt, the white of raw eggs is the best antidote; and for the same reason corrosive sublimate is a powerful antiseptic, and is employed to preserve anatomical preparations.

Amongst the most important tests for this substance, which is not unfrequently used as a poison, may be mentioned—1. Iodide of potassium, which, when added to a crystal or to a watery solution of chloride of M., gives rise to the formation of a bright scarlet iodide of mercury. 2. The galvanic test, which may be applied in various ways, of which the simplest is the 'guinea and key test,' devised by Wollaston. He placed a drop of the fluid suspected to contain corrosive sublimate on a guinea, and simultaneously touched it and the surface of the guinea with an iron key; metallic M. was deposited on the gold in a bright silvery stain. 3. Precipitation on copper, and reduction. To apply this test, we acidulate the suspected fluid with a few drops of

hydrochloric acid, and introduce a little fine copper gauze, which soon becomes coated with mercury. On heating the gauze in a reduction tube, the M. is obtained in well-defined globules.

With iodine and bromine, M. forms two iodides and bromides, corresponding in composition to the chlorides. Both the iodides are used in medicine; the bromides are of no practical importance. The *subiodide* (Hg_2I) is a green powder formed by triturating 5 parts of iodine with 8 of M., and is of far less interest than the *iodide* (HgI), which is most simply obtained by precipitating a solution of corrosive sublimate by a solution of iodide of potassium. The precipitate is at first salmon-coloured, but soon changes into a brilliant scarlet crystalline deposit.

Sulphur forms two compounds with M.—viz., a subsulphide (Hg_2S), a black powder of little importance, and a sulphide (HgS), which occurs naturally as Cinnabar (q. v.). *Sulphide of M.* is thrown down as a black precipitate by passing sulphuretted hydrogen through a solution of a persalt of M. (corrosive sublimate, for example). When dried and sublimed in vessels from which the air is excluded, it assumes its ordinary red colour. The well-known pigment *vermilion* is sulphide of M., and is sometimes obtained from pure cinnabar, but is more frequently an artificial product.

M. unites with most metals to form Amalgams (q. v.), several of which are employed in the arts.

Of the numerous organic compounds of M., it is unnecessary to mention more than the fulminate (described in the article FULMINIC ACID, q. v.) and the cyanide (HgCy), which may be prepared by dissolving the red oxide of M. in hydrocyanic acid, and is the best source from which to obtain cyanogen.

The uses of M. are so numerous that a very brief allusion to the most important of these must suffice. It is employed extensively in the extraction of gold and silver from their ores by the process of amalgamation. Its amalgams are largely employed in the processes of silvering and gilding, and some (as those of copper and cadmium) are employed by the dentist for stopping teeth. It is indispensable in the construction of philosophical instruments, and in the laboratory in the form of the mercurial bath, &c. It is the source of the valuable pigment vermilion. The use of its chloride in anatomical preparations has been already noticed; it is similarly found that wood, cordage, and canvas, if soaked in a solution of this salt (1 part to 60 or 80 of water), are better able to resist decay when exposed to the combined destructive influence of air and moisture. The uses of M. and its preparations in medicine are noticed in a separate article.

MERCURY AND MERCURIALS, MEDICINAL USES OF. Liquid mercury is no longer used in medicine, although, until lately, it was occasionally given with the view of overcoming, by its weight, obstructions in the intestinal canal. There are, however, many preparations which owe their value to *extinguished mercury*; that is to say, to mercury triturated with chalk, saccharoid matters, oil, &c., till globules can no longer be detected in it. It is possible that, in these cases, the metal is partly reduced to the state of suboxide. Amongst these preparations must be placed *Mercury with Chalk*, or *Gray Powder* (*Hydrargyrum cum Creta*), which is the mildest and best mercurial to administer to infants and children, the dose varying with the age; *Blue Pill* (q. v.); and the various ointments, liniments, and plasters of mercury. *Calomel* (termed, in some of the pharmacopœias, *Hydrargyri Chloridum*, for the same reason that corrosive sublimate, as already mentioned, is termed in the

same works *Hydrargyri Bichloridum*) is perhaps more given than any other medicine of this class, and may be regarded, in so far as its actions are concerned, as a type of mercurials generally. Given in small doses, the first effects of these medicines are observed in the increase of the various secretions, as, for instance, of the saliva (see SALIVATION), of the various fluids poured into the intestinal canal,* and sometimes of the urine. When continued in small doses for some time, they cause the absorption of morbid fluids, and even of morbid products that have assumed a partially solid form. The following are some of the diseases in which they are of most importance: (1), in *internal congestions*, as of the liver, &c., to increase the secretions, and hence relieve the vessels of the affected organ; (2), in various *acute inflammations*, especially of serous Membranes (q. v.), of the structure of the liver and of the lungs, &c.; (3), in numerous forms of *chronic inflammation*; (4), in *dropsies*, dependent upon inflammation of serous membranes or disease of the liver, but not in dropsy from disease of the kidneys, where they are generally injurious; (5), in numerous *chronic affections* in which an alterative action is required; and (6) as a purgative (to be followed by a black draught), when a patient is in the condition popularly known as bilious (in this case, blue pill is usually as efficacious as calomel).

In *syphilis*, mercurials were at one time universally prescribed; now they are not considered essential to the cure of this disease, except in comparatively few cases.

If calomel, blue pill, or any other mercurial be given in too large a dose, or for too long a period, most serious consequences may result—such as, very profuse salivation, with swelling of the tongue and gums, and loosening of the teeth; purging; certain skin affections; disease of the periosteum and of the bones (formerly ascribed to syphilis, but in reality often due to the supposed remedy); and a low febrile condition (termed mercurial erythiam), accompanied with great general prostration.

The doses of calomel for an adult vary from 3 to 6 grains when taken as a purgative. If the object is to affect the system generally, as in a case of acute inflammation, small doses (half a grain to two grains, combined with a little opium) should be given several times a day; while as an alterative, still smaller doses (not sufficient at all to affect the mouth) should be prescribed. The *Compound Calomel Pill* popularly known as *Plummer's Pill* (in which the calomel is associated with oxysulphide of antimony and guaiacum) is a most valuable alterative in chronic skin-diseases—a five-grain pill to be taken every night.

Corrosive sublimate (the *Bichloride* of the pharmacopoeias, and *Oxymuriate* of the older chemists), although a very powerful irritant poison, is extremely useful in very small doses as an alterative in many chronic affections of the nervous system, the skin, &c. The dose varies from one-thirtieth to one-eighth of a grain; the average dose of its pharmacopoeial solution, the *Liquor Hydrargyri Bichloridi*, being one drachm, which contains one-sixteenth of a grain of the salt. This medicine should always be given on a full stomach.

The above are the chief mercurial preparations that are given internally. Certain external applications require a few remarks. The plasters, ointments, and liniments are absorbed by the skin, and act in the same manner as mercurials taken internally.

* It is very doubtful whether, as is generally believed, mercurials increase the secretion of the essential constituents of the bile. The watery portion is undoubtedly, and the colouring matter probably, increased.

White Precipitate Ointment is the universal remedy for the destruction of lice, and is a useful stimulating application in chronic skin-diseases. *Ointment of Nitrate of Mercury*, popularly known from its yellow colour as *Citrine*, or *Golden Ointment*, is, when sufficiently diluted, a most useful stimulating application in inflammation of the eyelids, in indolent ulcers, &c.; and the *Ointment of Nitric Oxide of Mercury* is similar in its action. The precipitated suboxide that occurs in *Black Wash*, and its use as a local application, are described in the article LINTIMENTS.

The *toxicological* relations of the mercurial compounds must be briefly glanced at. There are cases on record in which, probably from some peculiarity of constitution, ordinary and even small doses of the milder mercurials have caused death; thus, Christison mentions a case in which two grains of calomel destroyed life by severe salivation and by ulceration of the throat; and similar cases in which small doses of gray powder, blue pill, and calomel have proved fatal, are recorded by Taylor in his *Medical Jurisprudence*. The preparations employed for the purpose of poisoning are mainly corrosive sublimate, and white and red precipitates, corrosive sublimate being used in at least four-fifths of the cases. The symptoms produced by a poisonous dose of this salt come on immediately, there being during the act of swallowing an intense feeling of constriction, and a burning heat in the throat, while a metallic taste is left in the mouth. Violent pain in the stomach and abdomen is felt in a few minutes, and vomiting of mucus and blood, and purging, follow. The pulse becomes small, frequent, and irregular, the tongue white and shrivelled, the skin cold and clammy, the respiration difficult, and death is preceded by fainting or convulsions. Any dose exceeding two grains would probably prove fatal to an adult, unless vomiting were induced, or the whites of eggs administered. Death commonly ensues in from one to five days, but may take place in less than half an hour, or not for three weeks or more.

MERCURY, Dog's (*Mercurialis*), a genus of plants of the natural order *Euphorbiaceae*, having unisexual flowers, a tripartite perianth, 9–12 stamens, two simple styles, and a dry two-celled fruit with two seeds. The species are not numerous. The COMMON DOG M. (*M. perennis*) is very common in woods and shady places in Britain. It has a perfectly simple stem, about a foot high, with rough ovate leaves, and axillary loose spikes of greenish flowers. It turns a glaucous black colour in drying, and the root contains two colouring substances, one blue, and the other carmine; so that it may probably become of importance in dyeing. It is very poisonous. The mercury which some old writers mention as a pot-herb is not this plant, but *Chenopodium Bonus Henricus*.—ANNUAL DOG M. (*M. annua*) is a much rarer British plant, and less poisonous. The leaves are indeed eaten in Germany, as spinach.—A half-shrubby species (*M. tomentosa*), found in the countries near the Mediterranean, has enjoyed an extraordinary reputation from ancient times; the absurd belief mentioned by Pliny being still retained, that if a woman after conception drink the juice of the male plant, she will give birth to a boy, and if of the female plant, her offspring will be a girl—the male plant, however, being mistaken for the female, and the female for the male.

MERGANSER (*Mergus*), a genus of birds of the family *Anatida*, having a slender, straight, much compressed bill, hooked at the tip, and notched at the edges, almost furnished with teeth.

MERGUI—MERINO.

See **BILL**. The species are all inhabitants of the seas and coasts of northern regions, but migrate southwards in winter. The Goosander (q. v.) is the largest and best known British species. The **RED-BREASTED M.** (*M. serrator*) is plentiful in the northern parts of Britain, at least in winter, and is found in all the northern parts of the world. It is not much smaller than the goosander, which it much resembles.—The **HOODED M.** (*M. cucullatus*), a smaller species, only about 18 inches in entire length, is a very rare visitant of Britain, but is very plentiful in North America.

MERGUI, a town and seaport of Mergui, one of the Tenasserim Provinces, British Burmah, stands on an island in the delta of the Mergui River. Lat. 12° 27' N., long. 98° 42' E. It is about three miles in circuit, and is surrounded by a stockade. Its harbour is spacious and secure. Exports: sapan wood, dried fish, ivory, &c. Pop. 8000.

MERGUI ARCHIPELAGO, a group of islands in the Gulf of Bengal, lying off the southern shores of the Tenasserim Provinces, in lat. from 9° to 13° N. The islands are mountainous, some of them rising to 3000 feet above sea-level. Pearls are found on the coasts of many of them; and edible birds'-nests, which are sold to the Chinese and Malays, who visit the group annually for the purpose of procuring them, are one of the chief articles of export.

MERIDA, the capital of Yucatan, is situated on a barren plain, 25 miles from the Gulf of Mexico, in lat. 20° 50' N., long. 89° 40' W. It occupies the site of a former native city, and was founded by the Spaniards in 1542. M. has a university, a cathedral, and 13 churches. Its port is Sisal, with which it communicates by a good road. Its trade and manufactures are not extensive. Pop. 23,575, the great body of whom are Indians and half-bloods.

MERIDA (anc. *Augusta Emerita*), a small, decaying town of Spain, in the province of Estremadura, rises on the right bank of the Guadiana, 32 miles east of Badajoz. It is unique in Spain, and is in some points a rival of Rome itself, on account of the number and magnitude of its remains of Roman antiquity. The Guadiana is here crossed by a Roman bridge of 81 arches, and with a length of 2575 feet, and a breadth of 26 feet. It was erected by Trajan. There is another Roman bridge over the Albarregas, 450 feet long, and 25 feet wide, still quite perfect, in spite of the traffic of 17 centuries. There are also remains of a castle built by the Romans; and among the other most noteworthy monuments of antiquity are an old half-Roman, half-Moorish palace, the Casa de los Corvos, constructed out of a temple dedicated to Diana, several aqueducts, an ancient theatre, and a circus. M. was built 23 years B. C., and flourished in great splendour, until, in 1229, it was taken from the Moors, after which it began to decline. Pop. 3800.

MERIDEN, township and village in Connecticut, United States of America, 18 miles north-east of New Haven, containing an academy and several manufactories. Pop. in 1860, 7426.

MERIDIAN (Lat. *meridies*, mid-day), the name given to the great circle of the celestial sphere which passes through both poles of the heavens, and also through the zenith and nadir of any place on the earth's surface. Every place on the earth's surface has consequently its own meridian. The meridian is divided by the polar axis into two equal portions, which stretch from pole to pole, one on each side of the earth. It is mid-day at any place on the earth's surface, when the centre of the sun comes upon the meridian of that place; at the same instant it is mid-day at all places under the same half

of that meridian, and midnight at all places under the opposite half. All places under the same meridian have therefore the same longitude (see **LATITUDE AND LONGITUDE**). Stars attain their greatest altitude when they come upon the meridian; the same thing is true approximately of the sun and planets; and, as at this point the effect of refraction upon these bodies is at a minimum, and their apparent motion is also more uniform, astronomers prefer to make their observations when the body is on the meridian. The instruments used for this purpose are called *meridian circles*. See **CIRCLE, MURAL**.

MERIDIAN MEASUREMENT. The determination of the form and size of the earth from the measurement of an arc of a meridian, has been a favourite problem with mathematicians from the earliest times, but up to the middle of last century, their operations were not carried on with exactness sufficient to render their conclusions of much value. Since that time, however, geodesy has so rapidly progressed, owing to the invention of more accurate instruments, and the discovery of new methods, that the measurement of the meridian can now be performed with the utmost accuracy imaginable. The *modus operandi* is as follows: Two stations, having nearly the same longitude, are chosen; their latitude and longitude are accurately determined (the error of a second in latitude introduces a considerable error into the result), and the direction of the meridian to be measured ascertained; then a base line is measured with the greatest accuracy, as an error here generally becomes increased at every subsequent step; and then, by the method known as **TRIANGULATION** (q. v.), the length of the arc of the meridian contained between the parallels of latitude of the two stations is ascertained. As the previously found latitudes of its two extremities give the number of degrees it contains, the average length of a degree of this arc can be at once determined; and also—on the supposition that the length of a degree is uniform—the length of the whole meridional circumference of the earth. This operation of meridian measurement has been performed at different times on a great many arcs lying between 68° N. lat. and 38° S. lat., and the results shew a steady though irregular increase in the length of the degree of latitude, as the latitude increases. On the supposition that this law of increase holds good to the poles, the length of every tenth degree of latitude in English feet is as in the following table:

Degree of Latitude.	Length of Degree in English Feet.	Degree of Latitude.	Length of Degree in English Feet.
0°	369,732	50°	364,862
10°	369,843	60°	365,454
20°	369,158	70°	366,937
30°	363,641	80°	366,929
40°	364,233	90°	366,361

This result shews that the earth is not spherical, as in that case the length of all degrees of latitude would be alike, but of a more or less spheroidal form—that is, having its curvature becoming less and less as we go from the extremity of its greater or equatorial diameter to the lesser or polar axis. See **EARTH**. It was by the measurement of a meridional arc that, in 1792—1799, the length of a quadrant of the earth's circumference was determined, in order to form the basis of the French metrical system (see **METRE**).

MERINO, an important breed of sheep, originally Spanish, but now widely diffused throughout Europe, and constituting a great part of the wealth of Australia. The M. has large limbs, and the male

MERINO—MERLIN.

has large spiral horns, which do not rise above the head; the skin of the neck is loose and pendulous; the cheeks and forehead bear wool; the fleece is fine, long, soft, and twisted in silky spiral ringlets, abounding in oil, which attracts dust, so that it has



Merino Sheep.

generally a dingy appearance. The fleece is sometimes black, and black spots are apt to appear even in the most carefully bred flocks. The M. sheep fattens slowly, and owes its value altogether to the excellence of its wool. It has not been found profitable in Britain, where the production of mutton is a great part of the object of the sheep-farmer.—Many of the flocks of merinos in Spain are fed on the mountains in summer, and on the plains in winter.

MERINO. See WOOLLEN MANUFACTURE.

MERIONETH, a maritime county of North Wales, is bounded on the W. by Cardigan Bay, and on the N. by the counties of Caernarvon and Denbigh. Area, 385,291 acres; pop. (1861) 38,963. The coast-line of the county is 38 miles in extent, and is indented by several inlets, as the Traeth Mawr, Barmouth Bay, and the estuary of the river Dovey. The coast immediately south of the town of Harlech rises into cliffs, is skirted by sands, and fringed by three dangerous sand-banks at some distance out to sea. M. is the most mountainous county in Wales, although its peaks do not rise to the height of some of those in Caernarvonshire. The chain comprising the highest peaks runs from north-west to south-east, and its summits are Arran Mowddy (2955 feet) and Cader Idris (q. v.). The county is watered by the Dee, which flows north-east, and by the Mawddach and the Dovey, which reach the sea after a south-west course. M. contains no plains. The soil is in general poor, and suited only for pasturage. Limestone and slates especially are quarried very extensively, and lead and copper mines are worked to some extent. Capital, Dolgelly (q. v.).

MERIVALE, JOHN HERMAN, an English scholar and translator, was born at Exeter in 1779, studied at St John's College, Cambridge, and was called to the bar in 1805. He contributed largely to Bland's *Collections from the Greek Anthology*, published in 1813, and brought out a second edition himself in 1833. From 1831 to his death in 1844, he held the office of Commissioner of Bankruptcy. Among his other literary performances may be mentioned *Poems Original and Translated* (1841), and *Minor Poems of Schiller* (1844).—M., the REV. CHARLES, son of the preceding, was born in 1809, studied at St John's College, Cambridge, where he took his degree in 1830, and was successively scholar, fellow, and tutor. He has acquired a great reputation as

an author by his *History of the Romans*, 6 vols. 1850—1858.—Another son, HERMAN, born in 1805, holds the office of Under-secretary of State for the Colonial Department.

MERLE D'AUBIGNÉ, JEAN HENRI, a popular ecclesiastical historian, was born at Eaux-Vives, near Geneva in Switzerland, 16th August 1794, studied there and at Berlin—under Neander—and subsequently became pastor of the French Protestant Church in Hamburg. Thence, after a residence of five years, he proceeded to Brussels, became chaplain of King William, who, after the revolution of 1830, invited him to Holland, as tutor to the Prince of Orange. M., however, declined the offer, and returning to Geneva, took part in the institution of a new college for the propagation of orthodox theology, in which he was appointed Professor of Church History. With the exception of some visits to England and Scotland, where he has numerous readers and admirers, he has remained constantly at Geneva. The work which has given him so widespread a reputation is his *Histoire de la Réformation au Seizième Siècle* (1835, et seq.). It is written with the utmost vivacity, is undoubtedly picturesque, and sometimes even eloquent. The knowledge of the subject possessed by the writer is very considerable, and his sentiments are inspired by an evangelical piety; but the work has been censured by adverse critics as one-sided, pretentious, and as compressing the broad stream of new religious life, which then watered Germany and Europe, into narrow theological channels. Its popularity, however, has been immense. More than 300,000 copies of the English translation have been sold in Great Britain and America. Among M. D.'s other productions are—*Le Luthéranisme et la Réforme* (Par. 1844); *Germany, England, and Scotland* (1848); *Le Protecteur, ou la République d'Angleterre aux Jours de Cromwell* (1848).

MERLIN (*Falco aesalon* or *Hypotriorchis aesalon*), the smallest of the British *Falconidae*, scarcely exceeding a black-bird in size, but very bold and powerful, and possessing all the characters of the true falcons, with the distinction of large hexagonal scales on the front of the tarsi. It is of a bluish ash colour above; reddish yellow on the breast and



Merlin (*Falco aesalon*), Male.

belly, with longitudinal dark spots, the throat of the adult male white. The wings reach to two-thirds of the length of the tail. It builds its nest on the

ground, and is fond of localities where large stones are plentiful, on which it is often to be seen perched, and is therefore often called the *Stone Falcon*. It is common in most parts of Europe, is found in Asia and North America, and extends southwards in Africa, even to the Cape of Good Hope. It was of great repute in the days of falconry, being very easily trained, and flying readily at its quarry. It was therefore often used for taking partridges and wood-pigeons. It is a very lively bird, and often utters a harsh scream. It usually flies low and very rapidly, threading its way, if necessary, through branches and leaves, but it will also follow its prey in mounting upwards to a great height.

MERLIN, the name of an ancient Welsh prophet and enchanter, who is believed to have flourished during the decline of the native British power in its contest with the Saxon invaders. Both the Cambrian and the Strathclyde Britons boasted of a M. who was, in all probability, the same personage decked out in different legendary guise.—The Cambrian M., called *M. Emrys* or *Ambrosius*, is said by Geoffrey of Monmouth, in his *Historia Brittonum*, to have lived in the 5th c., to have sprung from the intercourse of a demon with a Welsh princess, and to have displayed the possession of miraculous powers from infancy. He is alleged to have been the adviser of King Vortigern, and subsequently of Ambrosius, Uterpendragon, and the great King Arthur. He is often alluded to by our older poets, especially Spenser, in his *Fairy Queen*, and also figures in Tennyson's *Idylls of the King*. He has been made the subject of a metrical romance, of which there is a manuscript copy in the Advocates' Library in Edinburgh. (For an analysis of this romance, see Ellis's *Specimens of Early English Metrical Romances*.) A collection of prophecies attributed to him appeared in French (Paris, 1498), in English (Lond. 1529 and 1533), and in Latin (Venice, 1554); and their existence is traceable at least as far back as the time of the poet Lawrence (*circa* 1360).—The Strathclyde, or—if we may be allowed an expression which anticipates history—the *Scottish M.*, called Merlin the Wyllt, or Merlin Caledonius, is placed in the 6th c., and appears as a contemporary of St Kentigern, Bishop of Glasgow. His grave is still shewn at Drummelzier on the Tweed, where, in attempting to escape across the river from a band of hostile rustics, he was impaled on a hidden stake. A metrical life of him, extending to more than 1500 lines, professedly based on Armoric materials, and incorrectly ascribed to Geoffrey of Monmouth, was published by the Roxburghe Club in 1830. His prophecies—published at Edinburgh in 1615—contain those ascribed to the Welsh Merlin.

MERLON, in Fortification, is the portion of the parapet between two embrasures. Its length is usually from 15 to 18 feet.

MERMAID (i. e., sea-maid), an imaginary inhabitant of the sea. The upper parts of mermaids are represented as resembling those of a human being, generally of a female—although the *Merman* is also sometimes heard of—whilst the body terminates in a tail like that of a fish. There is an evident affinity between the stories concerning mermaids and those concerning the sirens and tritons, perhaps also the nereids, of the ancients. The probability is that these stories have originated in the appearance of seals, walruses, and perhaps still more of the herbivorous cetacea, in regions where they are rare, or to persons unaccustomed to see them. 'Large allowance must be made for the workings of an excited imagination, in situations of solitude and apprehension, on the unexpected appearance of an

extraordinary and unknown object.' Many of the stories concerning mermaids belong to the northern parts of the world, where the herbivorous cetacea are of rare occurrence, and perhaps some of the solitary seals have often given occasion to them. But the herbivorous cetaceans do occasionally wander into the British, and probably even into more northern seas. Sir James Emerson Tennent says concerning the Dugong (q. v.): 'The rude approach to the human outline, observed in the shape of the head of this creature, and the attitude of the mother while suckling her young, holding it to her breast with one flipper, while swimming with the other, holding the heads of both above water; and when disturbed, suddenly diving and displaying her fish-like tail—these, together with her habitual demonstrations of strong maternal affection, probably gave rise to the fable of the mermaid; and thus that earliest invention of mythical physiology may be traced to the Arab seamen and the Greeks, who had watched the movements of the dugong in the waters of Manaar.' It is right, however, that we should bear in mind the possibility of the existence in the ocean of cetaceans not yet known to naturalists.—The mermaid is a not unfrequent heraldic bearing. In the heraldry of France, she is called a Siren, and in Germany she is occasionally furnished with two fishy tails.

MERMAID'S GLOVE (*Halichondria palmata*), a sponge pretty common in the British seas, and the largest of British sponges. It grows in deep water, and is sometimes two feet in height. It receives its

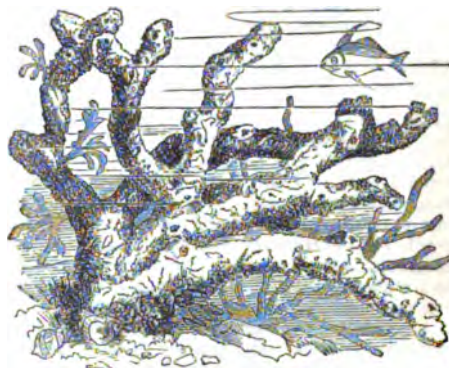

Mermaid's Glove (*Halichondria palmata*).

name from the somewhat finger-like arrangement of its branches. It is not slimy, and has a very porous surface; rough, with myriads of minute fragile spiculae. Its colour is yellowish.

MER'Œ. See ETHIOPIA.

MERO'PIDÆ. See BEE-EATER.

MEROVINGIANS, the first dynasty of Frankish kings in Gaul. The name is derived from Merwig or Merovaens, who ruled about the middle of the 5th c., having united a few tribes under his sway. His grandson, Chlodwig or Clovis (q. v.), greatly extended his dominions, and on his death, divided his kingdom among his four sons, one of whom, Chlotar or Clotaire I., re-united them under his own sway in 558. On his death, in 561, the kingdom was again divided into four parts—Aquitaine, Burgundy, Neustria, and Austrasia. His grandson, Clotaire II., again united them in 613; but after his death, in 628, two kingdoms, Neustria and Austrasia, were formed, in both of which the Merovingian kings retained a merely nominal

power, the real power having passed into the hands of the mayors of the palace.—The dynasty of the M. terminated with the deposition of Childeric IV., in 752, and gave place to that of the Carolingians (q. v.), sprung from the Austrasian mayor of the palace.—The chief authority for the earlier parts of the history of the M. is Gregory of Tours. See also Thierry's *Recits mérovingiens* (Par. 1839), and Pertz, *Geschichte der meroving. Hausmeier* (Leip. 1819).

MERRIMAC, a river of New England, U.S., rising in New Hampshire, and falling into the Atlantic Ocean at Newburyport, after a course of about 120 miles. It receives several small tributaries, and has numerous falls, affording immense water-power, on the principal of which are the manufacturing towns of Nashua and Manchester, in New Hampshire, and Lowell and Lawrence, in Massachusetts. Navigable 15 miles to Haverhill.

ME'RSEBURG, a town of Prussian Saxony, capital of a circle of the same name, on the Saale, 60 miles south-south-east of Magdeburg. The cathedral, a noble specimen of medieval architecture, is surmounted by four beautiful towers, and has one of the largest organs (with 4000 pipes) in Germany. It contains the monument of Rudolf of Swabia, an aspirant to the imperial title, who was here defeated and slain (1080) by Henry IV.; a bronze plate in low relief, probably the oldest medieval effigy extant. The castle—a picturesque edifice, mostly of the 15th c.—was once a residence of the Saxon princes. Cotton and woollen goods, paper, and tobacco are here manufactured, and bleaching and brewing are carried on. The beer of M. is famous. Pop. 11,837. It was near this town that the emperor Henry the Fowler gained his famous victory over the Hungarians in 934.

ME'RSEY, an important river of England, separates, in its lower course, the counties of Cheshire and Lancashire, and has its origin in the junction of the Thame and Goyt, on the borders of Derbyshire, east of Stockport. It flows in a west-south-west direction, and is joined on the right by the Irwell from Manchester, at which point it becomes navigable for large vessels. Besides the Irwell, the chief affluents are the Bollin and the Weaver from Cheshire. At its junction with the Weaver, the M. expands into a wide estuary, which forms the Liverpool channel. The estuary is about 16 miles long, and from 1 to 3 miles broad; opposite Liverpool, it is a mile and a quarter in width, with a considerable depth at low water. It is much obstructed by sandbanks; but the excellent system of pilotage in practice here renders the navigation comparatively secure. Congers, shrimps, flounders, and sparlings abound in the river and estuary. Entire length with the estuary, nearly 70 miles.

MERTHYR-TY'DVIL is a thriving town of about 50,000 inhabitants, forming with Aberdare a parliamentary borough, the population of which, in 1861, was 83,844. It is on the northern border of the county of Glamorgan, abutting upon the county of Brecknock, and surrounded by lofty hills. It is built upon the river Taff, 500 feet above sea-level, 24 miles from its mouth and port at Cardiff; and it includes the junctions of the greater and lesser Taff, the Morlais, and the Dowlais, streams which there unite to constitute the main river. M. is the seat of the iron trade of Glamorgan, as represented by the great works of Dowlais, Cyfarthfa, and Plymouth, and in a less degree by that of Penyarden. It also contains large collieries, and is celebrated, with Aberdare, for the excellence of its coal for steam-engines. The annual make of

finished iron of these works, chiefly in the shape of rails, merchant-bars, and, from Dowlais, of girders and ship-plates, may be stated roughly at 170,000 tons. The exports of coal are considerable, and are increasing, but the chief consumption is within the works. The population are all directly dependent upon the works, there being no other trade or manufacture. Railways branch from M. to Brecon, to Swansea, to Cardiff and the new port of Penarth, and to Hereford. The borough was created by the Reform Act, and returns one member. Its chief town-officer is the headborough of the lordship, called the 'High Constable,' and its government is vested in a Local Board under the Public Health Act. Dowlais contains some fine public buildings, but M. is at present deficient in this respect. Though a busy, it is not a striking place, having risen very rapidly with the local trade, and having attained nearly its present dimensions before it was under any but the ordinary parochial government. There are, however, symptoms of improvement. A copious water-supply has been recently laid on, and the infantile mortality, long extraordinary, has been reduced within moderate limits. The people, chiefly Welsh, are industrious, and, on the whole, very orderly. There are 6 established churches, and about 40 dissenting chapels.

MERTON COLLEGE, Oxford. The House of the Scholars of Merton, commonly called M. C., the model of all the secular colleges, was first founded in Malden in Surrey by Walter de Merton, Bishop of Rochester, and Lord High Chancellor, in 1264, for the maintenance of 20 scholars in the schools of Oxford, and of a warden and three or four ministers of the altar, who were to manage the property. In 1270, he transferred his warden and ministers to Oxford—thereby not only founding his own college, but contributing in no small degree to fix the university in its present locality. The fellows were to be as many as the means of the house could maintain, and after some changes, this number was fixed by Archbishop Laud at 24. They were to be elected first and chiefly from the founder's kin; but this was from an early period evaded, and the commissioners of 1852 speak of 'a common belief in the university that the elections to fellowships at Merton were formerly determined by personal interest.' In 1380, Dr Wylliot, Chancellor of Exeter, endowed twelve *portionists*, or postmasters as they are now called, equivalent to the scholars of other colleges; and in 1604, John Chamber, fellow of Eton, endowed two more—restricted, however, to foundationers from Eton. By the ordinances under 17 and 18 Vict. c. 81, considerable changes were made—six fellowships were suspended, of which two were assigned to increase the postmasterships, &c., and four to the endowment of the Linacre professorship of physiology, of value £800 per annum. The remaining 18 are thrown open, and are not to exceed £250 per annum, exclusive of rooms, until the original number of 24 is restored; after which, however, they may rise to £300 per annum, but not beyond. All the postmasterships on Wylliot's foundation, and four scholarships founded by Henry Jackson in 1753, are likewise thrown open, and are tenable for 20 terms from election; but the postmasterships on the foundation of John Chamber are only to be thrown open in default of candidates from Eton being found duly qualified. This college possesses 17 benefices, to some of which, however, certain other patrons present in turn.

MERU, in Hindu Mythology, a fabulous mountain in the centre of the world, 80,000 leagues high. It is the most sacred of all mythical mountains, the

abode of Vishnu, and endowed with all imaginable charms.

MERULIDÆ, or **TURDIDÆ**, a family of birds of the order *Inesores*, sub-order *Dentirostres*, having arched and compressed bills, which are pointed and notched, but not strongly. They are regarded by many naturalists as intermediate between the *Laniadæ* (Shrikes, &c.) and the *Sylviadæ* (Warblers, &c.). The species are very numerous, and are arranged in many genera. They are very widely distributed over the globe, some of them being found in cold and some in warm climates. Some are migratory; a few species are gregarious at all seasons, many are gregarious only in winter. They generally build their nests in trees. They feed chiefly on soft animal and vegetable substances, as berries, insects, and worms. Many of them are birds of very sweet song; some are remarkable for their imitative powers. To this family belong thrushes (among which are reckoned the black-bird, redwing, fieldfare, ring-ouzel, &c.), orioles, mocking-birds, dippers, &c.

MESAGNA, a town of the Neapolitan province Terra di Otranto, situated amidst scenery of oriental beauty, 27 miles north-west of Lecce, and surrounded by strong walls. The district around is fruitful, and yields delicious oil, which forms an important article of the trade of Messagna. Pop. 7500.

MESEMBRYACEÆ, or **FICOIDEÆ**, a natural order of exogenous plants, both herbaceous and shrubby, but all succulent. As defined by some botanists, it includes the orders *Tetragoniaceæ*, *Sesuviaceæ*, &c., of others. Of the more restricted *M.*, about 400 species are known, a few of which are natives of the south of Europe, but none are British; the greater number belong to South Africa and the South Sea Islands.—The Ice Plant (*q. v.*) belongs to this order. The leaves of some species, when burned, yield soda in great abundance. Large quantities of barilla are made from them in the Canary Islands, in Spain, and in Egypt. The seeds of some, as *Mesembryanthemum crystallinum* (the Ice Plant) and *M. geniculiflorum*, are ground into flour to make bread. *M. geniculiflorum* is used as a pot-herb in Africa. The fruit of *M. edule* (Hottentot's Fig) is eaten in South Africa, and that of *M. æquilaterale* (Fig's-faces) in Australia.—*M. emarcidum* is called *Kou* by the Hottentots, who beat and twist up the whole plant, allow it to ferment, and chew it like tobacco. When newly fermented, it is narcotic and intoxicating.—Some species of *Mesembryanthemum* are now common annuals in flower-gardens in Britain.

MESENTERY, **MESENTERIC DISEASE**.—The mesentery derives its name from being connected to the middle portion (*Gr. meson*) of the small intestine (*enteron*). It is a broad fold of peritoneum (the great serous membrane of the abdomen), surrounding the jejunum and the ileum, and attached posteriorly to the vertebral column. Its breadth between the intestinal and vertebral borders is about four inches; its attachment to the vertebral column is about six inches in length, and its intestinal border extends from the duodenum to the end of the small intestine. It serves to retain the small intestines in their place, while it at the same time allows the necessary amount of movement, and it contains between its layers the mesenteric vessels, the lacteal vessels, and mesenteric glands. These glands are 100 to 150 in number, and are about the size of an almond. They exert an organising action on the contents of the lacteals, the chyle being more abundant in fibrine and in corpuscles after it has passed through them. Hence, it is obvious that disease of these glands

must always seriously affect the process of assimilation. The most important affection of these organs is their scrofulous or tubercular degeneration, which gives rise to the disease known as *Tabes Mesenterica*, a disease most common in childhood, but confined to no period of life. In the great majority of cases, it is associated with, and often marked by, other results of the tubercular or scrofulous diathesis, such as pulmonary consumption, tubercular peritonitis, scrofulous disease of the spine, rickets, &c.; but sometimes the mesenteric glands seem almost exclusively affected, in which case the disease becomes sufficiently distinct to allow of easy detection. The leading symptoms are acceleration of the pulse, occasional fever, especially towards evening, loss of colour and flesh, derangement of the digestive organs (constipation or diarrhoea, and occasional vomiting), a steady pain in the region of the navel, increased by pressure; but perhaps the most characteristic symptom is tumefaction and hardness of the abdomen, with general emaciation. The enlarged glands can sometimes be detected by a careful examination with the hand, especially in advanced cases. The progress of the disease is generally slow, but at length hectic fever sets in, the emaciation becomes extreme, dropsical effusion appears, and the patient dies exhausted, if not cut off by the access of some acute inflammation.

The treatment mainly consists in the administration of cod-liver oil, or, if the stomach is too irritable to bear that medicine, of iodide of potassium, combined with some bitter infusion, the bowels being at the same time carefully attended to. The application of stimulating liniments, or of iodine ointment, to the abdomen is often of great service. When the disease has advanced to a considerable extent, remedies are of little use, except to palliate some of the more urgent symptoms.

Independently of the disease that has just been noticed, inflammation of these glands is by no means uncommon, when the mucous membrane of the small intestine is ulcerated, as, for example, in typhoid or enteric fever.

ME'SHID, an important city of Persia, capital of the province of Khorassan, in a fertile and well-cultivated plain, on the Tejend, in lat. 36° 17' N., long. 59° 40' E. It is by far the most important town of the north-east of Persia, being the centre of numerous converging routes. The city presents a surprising and beautiful view from a distance. Above the walls, which are of vast circuit, shine the gilded dome of one of the most splendid mosques of the East, the beautiful minarets of the tomb of Imaum Riza, a follower of Ali, and the summits of other sacred buildings. *M.*, as the chief seat of the great sect of the Shiites, is of nearly equal importance with Mecca, the sacred city of the orthodox Mohammedans, and hence it abounds in 'holy' men, arrayed in green turbans and sashes, who instruct the pilgrims visiting the city. The town carries on manufactures of woollen goods and of metal-wares, especially sword-blades, gold work, and articles of jewellery. It is a famous place of pilgrimage, and a centre, to some extent, of education. Caravans arrive almost daily. Pop. 100,000. In the neighbourhood are the ruins of Thus, the old capital of Khorassan, which contains the tomb of the celebrated poet Firdûsi.

MESI'LLA, a town and valley on the Rio Grande, New Mexico, U.S., acquired of Mexico in 1834 by purchase, under the Gadsden treaty. Lat. 32° 17' N., long. 106° 45' W. It is a narrow, but fertile valley, on the southern overland route to California. The town, settled in 1850, had in 1860 a population of 2406.

MESMER, FRANZ (according to others, **FRIEDRICH-ANTON**), the founder of the doctrine of Animal Magnetism (q. v.), or Mesmerism, was born in 1733 or 1734, at a village near the Bodensee. He studied at Vienna, and there took the degree of Doctor of Medicine in 1766. About 1772, he began, along with Father Hell, to investigate the curative powers of the magnet, and was led to adopt the opinion, that there exists a power similar to magnetism, which exercises an extraordinary influence on the human body. This he called Animal Magnetism, and published an account of his discovery, and of its medicinal value, in 1775. Honours were conferred upon him in Germany. In 1778, he went to Paris, where he attracted much attention. His system obtained the support of members of the medical profession, as well as of others; but he refused two offers, one of an annual pension of 30,000 livres, and the other of 340,000 livres, to reveal his secret; and this, combined with other circumstances, gave rise to suspicion, and induced the government to appoint a commission, composed of physicians and naturalists, whose report was unfavourable to him. He now fell into disrepute, and after a visit to England, retired to Meersburg, where he spent the rest of his life in complete obscurity. He died March 5, 1815.

MESMERISM. See **ANIMAL MAGNETISM**.

MESNE LORD is, in English Law, a lord who is himself a tenant to some other lord, called a lord paramount. The phrase is, however, not now used, because subinfeudation was abolished in the time of Edward I.—**MESNE PROCESS** was the name given to writs which issued in respect of a pending action before final judgment was given.—**MESNE PROFITS** are the profits or rents drawn by a person who is wrongfully in possession of real property, and who is afterwards ejected, in which case the mesne profits are recoverable, along with the estate itself.

MESOPOTA'MIA (Gr. *mesos*, middle, and *potamos*, a river), the region between the Euphrates and the Tigris; but the name is generally applied to the northern part of this region, which is called by the Arabs Al-Jesira (the Island). The northernmost districts of M. are mountainous, being penetrated by the southern spurs of the mountains of Armenia; all the rest is a plain, rarely broken by rocky heights. This plain is dry steppe, green with vegetation only in the wet season; but wherever it is naturally watered, or artificially irrigated, it displays fertility. The inhabitants consist chiefly of Turks, Kurds, Turcomans, and Yesids, with Armenians in the north, and Syrians and Arabs in the plains. The chief occupation of the people is the feeding of cattle; and of the civilisation of ancient times, or even of that which prevailed in a later period (during the Ayubite rule), few or no traces now exist. M. forms a part of the Turkish empire, and is divided into several eyalets or governments. For the history of the country, see **ASBYRIA**, **BABYLONIA**.

MESOZOIC (Gr. middle-life), a term introduced by Professor Phillips to designate the group of geological periods, the fossil remains of which differ equally from those of the Palaeozoic (ancient-life) and Cainozoic (newer-life) epochs. It is synonymous with the more generally employed term Secondary, and includes the rocks of the Triassic, Oolitic, and Cretaceous periods.

MESPILOS. See **MEDLAR**.

MESS (Fr. *meat*, Old Fr. *mes*, Ital. *messo*, a dish, from Lat. *misum*, portion, or served up) originally signified a dish or portion of food; but is used in the British army and navy in the sense of a number

or association of officers or of men taking their meals together. In societies consisting entirely of the male sex, and of one set of men continually thrown together, it is a very important social point that the mess should be well regulated. There are consequently stringent rules—both of the service and of mutual etiquette—laid down for its government. One officer acts as caterer, receives subscriptions from the several members, charges the wine to those who drink it, &c.; a steward has charge of the more menial department, arranging for the cooking, purchase of viands, servants, rations, &c.

In the navy, the Admiralty lend the plate and glass; in the army, such expenses are met by the mess fund, which is kept up by a contribution not exceeding thirty days' pay, or difference of pay, on the appointment or promotion of an officer, and an annual subscription from each officer not exceeding eight days' pay. Of course, both in army and navy, each officer has to pay periodically (usually weekly) his share of the general expense for provisions, &c. In the navy, this periodical expense is limited to £3 a month per head for the ward-room mess, and £1, 10s. in the gun-room. In the army, there is no specific limit, but commanding officers are enjoined to enforce proper economy. Government assists the mess of regiments serving at home, and on certain foreign stations where the necessaries of life are expensive, with an annual allowance of £25 for each troop or company. The whole of this allowance is to be applied in aid of the cost of the first allowance of wine, and towards reducing the daily expense of the mess, &c. The annual vote for this allowance is about £25,000.

In regiments, there is the officers' mess, to which all the officers of the regiment are bound to subscribe their regulated entrance-fee; but it is optional with married officers to use it or not, and if they elect not to do so, they are exempted from the annual contribution, and only pay for their share of the consumption on the special occasions when they may attend. The sergeants have also a mess, when the commanding officer can succeed in establishing one. It is considered necessary for discipline that these messes should be quite exclusive, though, in continental armies, and especially the French, the case is different, the utmost familiarity being encouraged between all ranks when off duty. The social equality of officers and men, due to conscription and promotion from the ranks, suffices to account for this difference of system. The sergeants draw their *Rations* (q. v.), supplementing them at their discretion; the officers can draw them or not (through their messman), but on foreign stations they almost invariably do so. Of course, for every such ration drawn, the usual stoppage is made from pay.

There is no mess for staff-officers with an army, unless they form private arrangements among themselves.

In the British navy, if the ship be small, there is one general mess—the ward-room—to which all the officers must belong. If the vessel have a considerable complement, there is the ward-room mess (of which the captain is not an effective member, as he dines in his own suite of cabins), for the commander, lieutenants, master, chaplain, paymaster, marine officers, surgeon, assistant-surgeon, and chief engineer; the gun-room, for sub-lieutenants, second masters, midshipmen, cadets, and master's assistants; and the engineers' mess (governed by the rules for the gun-room), for engineer officers below the rank of chief-engineer. Officers or civilians voyaging in a ship of war as passengers are ordinarily elected honorary members of the mess to which their rank would entitle them. Rations are not issued to members of a mess; but each is granted,

in lieu thereof, an allowance of £1 a month, with the power of purchasing ship's provisions at government rates.

Common seamen and common soldiers, in the navy and army respectively, *mess* together in tables comprising a certain number, according to their ratings or squads; but this has no reference to the technical meaning of messing as applied to officers, and is merely for the purpose of economy of fuel and labour in the cooking of their rations.

MESSALI'NA, VALERIA, the daughter of Marcus Valerius Messala Barbatius, and wife of the Roman emperor Claudius, a woman infamous for her lasciviousness, her avarice, and the atrocities which she perpetrated. Taking advantage of the weakness and stupidity of the emperor, she played the adulteress without restraint, and unrelentingly caused all to be put to death who stood in the way of her unhallowed gratifications. The best blood of Rome flowed at her pleasure. Among her victims were the daughters of Germanicus and Drusus, Justus Catonius, M. Vincius, Valerius Asiaticus, and her confederate Polybius. She went so far in vice as to offer her charms for sale like a common prostitute; and at last, during a temporary absence of the emperor, she publicly married one of her favourites, C. Silius, upon which Narcissus, one of the emperor's freedmen, represented to him that M. was aiming at his destruction, and received orders for her execution. She was put to death by Enodius, a tribune of the guards, in the gardens of Lucullus, 48 A.D. Her name has become a by-word for crime and lust.

MESSENGERS, KING'S (QUEEN'S), officers employed by secretaries of state to convey dispatches at home and abroad. In former days, their occupation consisted, to a considerable extent, in serving the secretaries' warrants for the apprehension of persons accused of high treason and other grave offences against the state, nor was it unusual for them to keep the prisoners whom they apprehended at their own houses. They are now principally employed in foreign service.

MESSENGERS-AT-ARMS, the officers who execute the process and letters of the Courts of Session and Justiciary in Scotland. They are appointed by, and are under the control of the Lyon King-at-Arms (q. v.). Act 1587, c. 46, contains various provisions regarding these officers, which shew that, prior to that period, the Lyon exercised jurisdiction over them, both as to their admission and the trial of complaints against them. There are a certain number of messengers-at-arms in every county of Scotland, amounting in all, at present, to about one hundred.

MESSE'NIA, a district in the south-west of the Peloponnesus, bounded on the E. by Laconia, on the N. by Arcadia and Elis, and on the S. and W. by the sea. It was composed chiefly of extensive plains, watered by the *Pamisos* and other streams. Those plains were famous for their fertility, and particularly for their wheat-harvests. At an early period, after the Doric conquest, it rose to power and opulence. Its chief cities were Messene, Methone, and Pylus. It is chiefly noted for its two wars with Sparta, known as the Messenian Wars, the first of which (according to the common chronology) lasted from 743 to 724 B.C.; and the second from 685 to 668 B.C. In both instances, the Messenians were defeated, and in consequence, a great part of them emigrated to Sicily, where they took possession of Zancle, which then received the name of Messana, the present Messina. After the lapse of 300 years, Epaminondas invited their descendants back to Greece, and they joyfully

responded to his invitation (369 B.C.), on which occasion the new city of Messene was built.

MESSIAH (Heb. *Mashiach*), equivalent to the Greek *Christos*, the Anointed, designates, in the Old Testament, the great deliverer and Saviour, whom the Jews expected to be sent by God, not only to restore their country to the power and splendour which it exhibited in the days of David, but even, by compelling the Gentiles to acknowledge the supremacy of the theocratic people, to raise it to the summit of universal dominion. This large conception, however, first begins to develop itself after the time of Solomon; for the oldest biblical records in their Messianic indications refer rather to the high degree of prosperity which the chosen people were to expect *for themselves*. This expectation, already visible in the Abrahamides, appeared for a moment to have realised itself in the conquest of Canaan; but the subsequent, and often disastrous wars (in the period of the 'Judges' and of Saul), as well as the internal feuds and dissensions of the Hebrews themselves—left it, in point of fact, unfulfilled. Nevertheless, the hope of the appearance of the M. had rooted itself strongly in the people, and during the glorious and peaceful reigns of David and Solomon, had so grown and enlarged, that even after the secession of Israel, and during the momentous ages that elapsed until its destruction as a kingdom, not only was the hope of a universal world-sovereignty, and of an extraordinary degree of prosperity, warmly cherished, but it was also confidently expected that God would raise up a branch from the stem of David as the M., the founder of the national prosperity, and the bringer-in of the all-embracing theocracy. That branch was declared to be 'the anointed of the Lord,' and since David applied that epithet to himself, the Jews transferred it to the deliverer whom they expected, and called him 'Son of David.' The prophetic writings contain many such allusions to the M., whose coming was expected shortly, and even during the time of the generation then living, whose birthplace, in congruity with his Davidic descent, was announced to be Bethlehem, and who, it was believed, was to be endowed with Divine attributes. These prophetic allusions are commonly termed **MESSIANIC PROPHECIES**. Along with such, the prophets associated the idea of a forerunner (Elijah, Jeremiah, or Moses), whose function was to prepare the people for the appearance of the Messiah. The coming of the Messianic kingdom was to be preceded by a period of severe misfortune and bitter sorrows, the purpose of which was the reconciliation of the people with God (Isaiah i. 25, &c.; Joel iii.; Dan. ix.; Zech. xiii.). These sorrows are called the woes of the M.: they are minutely described in the second book of Ezechiel—an apocryphal work. Hence sprung up the idea of a suffering M.—widely diffused among the Jews—who, by enduring grief and shame, should make atonement for the people, and reconcile them with God. This conception was greatly strengthened by the picture in Isaiah (chapters lii. and liii.), of a 'servant of God,' which, in fact, is generally regarded as the most distinct prophecy of the Saviour. Hence the step further of considering the M. an offering and sacrifice for the sins of the people, was an easy one; yet, on the other hand, it is singular that no trace of this is found in the Apocrypha, not to mention the popular belief of the Jews, that the M. was to live for ever (John xii. 34), that a crucified Saviour was a stumbling-block to them (1 Cor. i. 23), that even the disciples of Jesus did not comprehend his allusions to his death, and that their faith in him as the M. was for long dim and doubtful. In fact, this popular belief of the Jews was the very reason why they

did not recognise Jesus as the Messiah. In the later Judaism (as it shews itself in the Talmud), the conceptions of the M. are rich in singularities. It was believed that the true M., the son of David, would be preceded by another Messiah, a son of Joseph, or Ephraim, who should suffer death for men as a sin-offering. Century after century, the Jews have expected the former, and repeatedly have they risen and placed themselves under the standard of dreamers, fanatics, and impostors, who took to themselves the sacred name; as, for example, BAR-COCHBA (q. v.) in the 2d c.; one Moses in the Isle of Candia, in the 5th c.; one Julian in Palestine, in the 6th c.; several in Persia and Arabia in the 12th c.; and as late as the 18th c., Sabatai Zevi, in Aleppo. Even yet, the hope of a M. is not dead in the hearts of the strict Talmudistic Jews.

The crucial question of theology, however, is not the form in which the doctrine (so to speak) of the M. was held by the Jews. All rational students of Scripture, whether 'orthodox' or 'heterodox,' now admit that its growth was gradual, and that it acquired precision and definiteness of outline in the course of ages from its first rude phase, among the pastoral princes of the Syrian wilderness, down to that sublime, yet shadowy personality—the Man of Sorrows—that continually floats before the vision of the 'Younger Isaiah.' The grand question is: Was this doctrine essentially a Divine inspiration, an objective truth of God, or only a lofty conception of the religious soul? The strict rationalistic theologians maintain—and endeavour to prove by an analytic examination of the Gospels—that Jesus assumed the dignity of M., either to accommodate himself to a rooted conception of his countrymen, or partly because he had come to believe it himself—a conclusion, it is said, at which he might arrive quite honestly, since he felt that the truth which he taught was the real and only 'kingdom of God,' and that therefore he was justified in applying to himself all that was said (tropically) by the prophetic poets in old times concerning him who should usher in this 'golden age' of the world's faith. The mass of orthodox theologians, on the other hand, regarding the so-called Messianic prophecies of the Old Testament as positive, divinely suggested (perhaps, even on the part of their authors, *conscious*) predictions of Jesus Christ, repudiate the principle of accommodation, or even spiritual application, and try to shew that the Saviour accepted the Messianic prophecies as literally and exclusively applicable to him. The historico-spiritual school, represented in Germany by men like Neander, Rothe, Tholuck, &c., and in England, generally speaking, by the divines of the 'Broad Church' party, occupy a middle position between these two extremes: with the rationalists, they hold that the Old Testament doctrine of the M. was gradually developed, contains many human elements, and does not imply any knowledge of the historical Jesus on the part of those who announce it; with the 'orthodox,' on the other hand, they assert that the doctrine is the expression of a fact, not of a sentiment—that Jesus of Nazareth was actually the Son of God, the appointed M., and that in him the so-called Messianic prophecies were fulfilled in a far higher sense than ever the prophets could have dreamed. It will thus be seen that the rationalists resolve the doctrine of the M. into a merely *subjective* religious idea; while the orthodox, and also the historico-spiritual school of theologians, hold that the doctrine was the expression of a divine fact—the *substance* of a heavenly faith.

MESSINA, a city of Sicily, chief town of the province of same name, one of the most ancient and

most important cities of the island, is charmingly situated on the strait of M., encircled by a zone of abrupt conical rocks, and commands a view of Calabria on the continent. Pop. 94,133. The town is enclosed by old walls, and has several fine squares and wide lava-paved streets. The harbour, which is formed by a projecting tongue of land curved in the form of a sickle (whence its primitive name, Zancle—Gr. sickle—see MESSINA), is about four miles in circumference, and can contain a thousand ships; it is defended by a citadel and six forts; the depth is sufficient to admit vessels of large size; and the quays are spacious. The trade of M., chiefly in silk, oil, wine, coral, fruits, linseed, fish, &c., although less extensive than formerly, is still an important source of wealth to Sicily. The chief imports are cotton and woollen manufactures, hard-wares, and other articles of colonial produce. The damasks and satins of M. are excellent, and the fisheries important. M. has steam-boat communication with Naples, Marseille, and Malta. In the 15th c., M. was a renowned seat of learning; and in the 16th c., a famous school of painting was founded there by Pelidoro da Caravaggio. In modern times, it has undergone terrible vicissitudes, having been ruthlessly bombarded by the royal forces on several occasions during the war of independence in 1848.

MESSINA, STRAITS OF (Ital. *Faro di Messina*, Lat. *Mamertinum fretum*), between Italy and Sicily, are 22 miles in length, and vary from 2½ to 10 miles in breadth. A strong current runs through the strait, which is of great depth. See SCYLLA AND CHARYBDIS.

ME'SSUAGE, the legal term used in English law to describe a dwelling-house and piece of land adjoining.

METACENTRE. See HYDROSTATICS.

METAL (in Heraldry). The field of the escutcheon and the charges which it bears may be of metal as well as of colour; and the two metals in use among heralds are gold and silver, known as or and argent. It is a rule of blazon that metal should not be placed on metal, or colour on colour.

ME'TALLURGY is the art of extracting metals from their ores. The operations are partly mechanical and partly chemical. Those processes which depend principally on chemical reactions for their results have reference chiefly to the roasting and smelting of ores, and are described under the heads of the different metals. But there are certain preliminary operations of a mechanical kind which metallic ores undergo, such as crushing, jigging, washing, &c., which we shall describe here, as they are essentially the same for the ores of lead, copper, tin, zinc, and indeed most of the metals. (For IRON, see that head.)

Ores are first broken up with hammers into pieces of a convenient size for crushing or stamping. Waste material, such as pieces of rock, spar, &c., which always accompany ore, are as far as possible picked out by hand, and the ore itself arranged in sorts according to its purity. Various kinds of apparatus, such as riddles, sieves, &c., are then used for separating it into different sizes, in order to secure a uniform strain on the crushing machinery.

Figs. 1 and 2 represent one of the most approved forms of a crushing-mill. The ore is raised by means of small wagons, *a*, to the platform *b*, where it is ready to be supplied to the crushing-rollers *r* through the opening *c*. These rollers are mounted in a strong iron frame, held together by wrought-iron bars, and bolted to strong beams. Their distance apart is regulated by means of the lever *d*, to which a weight *e* is attached. The

bearings of the rollers slide in grooves, so that when any extra pressure is put upon them by a large or hard piece of ore, the lever rises, and allows the space

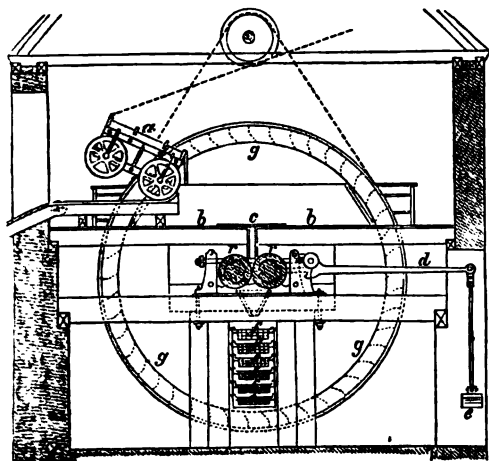

Fig. 1.—Ore Mill :
End view of the crushing rollers, sieves, and bucket-wheel.

between the rollers to widen. The crushed ore falls upon a series of sieves, *f*, which are made to vibrate. These have meshes increasing in fineness as they descend; and the upper two are so wide that pieces of ore too large to pass through them are conducted

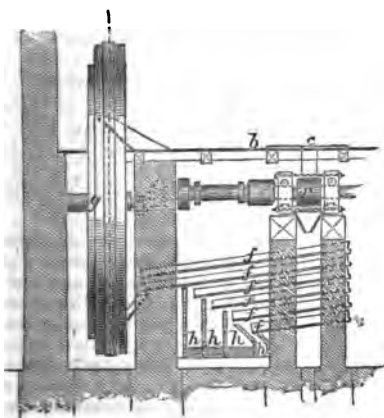

Fig. 2.—Ore Mill :
Side view of the crushing rollers, sieves, and bucket-wheel.

into the lower part of the bucket-wheel *g*, and raised again to the platform to be recrushed. The lower four sieves separate the remaining portion of the crushed ore into different degrees of fineness, which is collected in the pits *h*.

Instead of crushing-rollers, sometimes a stamping-mill is used, especially for tin ore, which require to be reduced to a fine powder. The stamping-mill consists of a series of upright shafts with a weighty piece of iron at the bottom of each. They are raised by means of an axle with projecting cams, and then falling by their own weight, act like hammers.

After being crushed, the ore is washed and sifted on a jiggling sieve. One of its simplest forms is shown in fig. 3. The ore is placed on the table *a*, from which the sieve *b* is filled. It is then immersed in a tub of water *c*, and a jiggling motion communi-

cated to it by a workman alternately raising and lowering the handle *d*. This effects two purposes—it washes the ore, and it separates the material into two layers: the upper consists of the lighter spar and other impurities, which are raked off; and

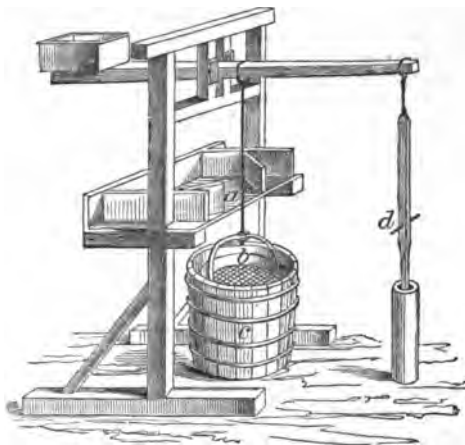

Fig. 3.—Jiggling Sieve.

the lower consists of the heavier and purer portions of the ore, which are now ready for the roasting furnace.

It will be apparent that in the bottom of the tub there must be a quantity of more or less valuable ore, which, from its fineness, has fallen through the sieve. This is called sludge or slime; and the minute particles of ore it contains are recovered either by simply forming an incline on the ground, and washing it with a current of water, or by using an inclined table, such as is shown in fig. 4, called a *sleeping-table*. Ore which has been reduced to powder at the stamping-mill, as well as slime, is washed by this apparatus. The material is put into the chest *a*, which is placed in a sloping position, and is supplied with water on turning the stop-cock *b*. The current carries the contents of the chest through the opening at the bottom, and spreads it,



Fig. 4.—Sleeping Table.

with the aid of a series of stops, or small bits of wood *c*, over the surface of the table *d*. A stream of water is then kept flowing over the table till the earthy impurities are all carried down into the trough *e*, the pure particles of the ore remaining, by reason of their greater specific gravity, near the top of the table, whence they are removed to be smelted. Sometimes the table is suspended by chains, and receives a succession of blows at the top from a *buffer*, moved by cams on the same principle as the stamping-mill. This arrangement is found of great advantage in dressing very poor ores.

METALS, METALLOIDS.

The variety of machinery and apparatus used in dressing ores is very great, and they pass under different names in different districts, but they are all very similar in principle to those we have described.

METALS, METALLOIDS. Although each metal is considered in a separate article, there are various points regarding the general physical and chemical characters of these bodies, and the method of classifying them, which require notice.

It is not easy to define a metal. All the elements are usually divided by chemists into two groups—viz., the non-metallic bodies or metalloids, and the metals; the list of non-metallic bodies containing all those elements in which the characteristic properties of the bodies popularly known as metals (such as silver, gold, iron, &c.) are wanting; these characteristic properties being their metallic lustre, their opacity, and their capacity of conducting heat and electricity. The non-metallic elements are 14 in number—viz., oxygen, hydrogen, nitrogen, sulphur, selenium, tellurium, phosphorus, chlorine, bromine, iodine, fluorine, carbon, boron, and silicon, of which five are gases, one a liquid, and the rest are solids at ordinary temperatures.

The division of the elements into these two great groups is, however, not based upon any definite scientific grounds, and it is still an open question whether some of the metalloids, as, for example, tellurium and silicon, should not be placed amongst the metals. The non-metallic bodies or metalloids being only remarkable as a group for their negative properties, require no special consideration, and we therefore proceed to notice the general properties of the metals.

The following are the most important of the physical properties of the metals.

1. All metals, unless when they are in a finely pulverised form, exhibit more or less of the characteristic lustre termed metallic. Two of the non-metallic elements, iodine and carbon, in some forms, present also a metallic lustre. 2. All metals are good conductors of heat and electricity, although in very unequal degrees. 3. With the exception of mercury, all the metals are solid at ordinary temperatures. With the exception of gold, copper, calcium, and strontium, the metals are more or less white, with a tendency to blue or gray. Most of them have been obtained in crystals, and probably all of them are capable of crystallising under certain conditions. 4. Metals are remarkable for their opacity, and, with the exception of gold, do not transmit light, even when they are reduced to extremely thin leaves. 5. All the metals are fusible, although the temperatures at which they assume the fluid form are very different (see FUSING POINTS); and some of them, as mercury, arsenic, cadmium, zinc, &c., are also volatile. 6. Great weight, or a high specific gravity, is popularly but erroneously regarded as a characteristic of a metal; while platinum, osmium, and iridium (the heaviest bodies known in nature), are more than 20 times as heavy as water, lithium, potassium, and sodium are actually lighter than that fluid. 7. Great differences are observable in the hardness, brittleness, and tenacity of metals. While potassium and sodium may be kneaded with the finger, and lead may be marked by the fingernail, most of them possess a considerable degree of hardness. Antimony, arsenic, and bismuth are so brittle that they may be easily pulverised in a mortar; while others, as iron, gold, silver, and copper, require great force for their disintegration. Taking iron and lead as representing the two extremes of tenacity, it is found that an iron wire will bear a weight 28 times as heavy as a leaden wire of the same diameter. See DUCTILITY, MALLE-

ABILITY. 8. It is a remarkable property of the metals, that none of them are capable of being dissolved without undergoing chemical change. Sulphur, phosphorus, iodine, &c., may be dissolved, and after the evaporation of the solvent, may be re-obtained with all their original properties; but this is never the case with metals.

Amongst the chief chemical properties of metals we next notice:

Their strong affinities to certain of the non-metallic elements. All the metals, without exception, combine with oxygen, sulphur, and chlorine, and often in several proportions, forming oxides, sulphides (formerly termed sulphurets), and chlorides. Many of them combine with bromine, iodine, and fluorine. The other compounds of this nature, excepting carbide (formerly carburet) of iron, or steel, and the hydrides of arsenic and antimony (commonly known as arseniuretted and antimoniu- retted hydrogen), which are of importance in toxicology, may be passed over without notice.

The metallic oxides are, without exception, solid bodies, insoluble in water, and usually present a white or coloured earthy appearance. Hence the old name of *metallic calx* for these oxides.

Those oxides which are termed basic possess the property of directly uniting with the so-called oxy-acids (such as sulphuric, nitric, carbonic, and silicic acid), and of forming a new chemical compound of the second order, termed a *salt* (q. v.).

The compounds of the metals with chlorine, iodine, bromine, and fluorine, such, for instance, as chloride of sodium, or common salt (ClNa), are termed Haloid Salts (q. v.). The same metal may often combine both with chlorine and with oxygen in more than one proportion. For example, we have subchloride of mercury (Hg_2Cl); suboxide of mercury (Hg_2O); chloride of mercury (HgCl); oxide of mercury (HgO). For the compounds of the metals with sulphur, see SULPHIDES OF THE METALS.

Metals enter into combination with one another when they are fused together, and such combinations are termed *Alloys* (q. v.), unless when mercury is one of the combining metals, in which case, the resulting compound is termed an *amalgam*. It is doubtful whether all alloys are true chemical compounds. Definite compounds of the metals with each other do, however, certainly exist, and are sometimes found native, as, for example, the crystallised silver and mercury compound represented by the formula AgHg_2 .

In consequence of their strong affinities for the metalloids, the metals are seldom found in a free or uncombined state, even in the inorganic kingdom, and never in animals or plants. The more common metals, in consequence of their strong affinity for oxygen and sulphur, are very rarely met with in the uncombined state; but some of those which are less abundant, such as gold, silver, and platinum, are found uncombined, in which case the terms *native* and *virgin* are applied to them; and other metals, as mercury and copper, occur both in a free and in a combined state. Many native alloys are found, but the ordinary sources of the metals are oxides, sulphides, chlorides, and carbonates, sulphates, and other salts. These are termed the *ores* of the metals. The methods of obtaining the metals from their various ores fall under the head of METALLURGY.

Various classifications of the metals have been suggested by different chemists. The following is probably one of the most convenient:

I.—The *Light Metals*, subdivided into—

1. The metals of the alkalis—viz., potassium, sodium, cesium, rubidium, lithium.

2. The metals of the alkaline earths—viz., barium, strontium, calcium, magnesium.

3. The metals of the true earths—viz., aluminium, glucinum, zirconium, yttrium, erbium, terbium, thorium, cerium, lanthanum, didymium.

II.—The *Heavy Metals*, subdivided into—

1. Metals whose oxides form powerful bases—viz., iron, manganese, chromium, nickel, cobalt, zinc, cadmium, lead, bismuth, copper, uranium, thallium.

2. Metals whose oxides form weak bases or acids—viz., arsenic, antimony, titanium, tantalum, niobium (or columbium), tungsten, molybdenum, tin, vanadium, osmium.

3. Metals whose oxides are reduced by heat—noble metals—viz., mercury, silver, gold, platinum, palladium, iridium, ruthenium, rhodium, osmium.*

METAMORPHIC ROCKS. Few of the deposits forming the crust of the earth remain in the condition in which they were deposited. By infiltration of a cementing fluid, by pressure, or by some other indurating agency, sand has become converted into sandstone, and clay and mud into shale. In some strata, this operation has been carried still further. There is a class of rocks, including gneiss, mica-schist, clay-slate, marble, and the like, which, while certainly of aqueous or mechanical origin, have, by intense molecular action, become more or less crystalline. To them, the convenient name *Metamorphic* (Gr. transformed) Rocks has been given by Lyell.

The *Metamorphic Rocks* were formerly considered to be the fundamental strata of the earth's crust. The original incandescent mass, it was said, losing its heat by radiation, a solid uneven crust of granite was formed. As soon as the ordinary atmospheric and aqueous agencies began to operate, a disintegration took place, and the abraded materials, carried down by the waters, were deposited in the basins which contained the boiling sea. It was thought that this not only accounted for the condition in which the *Metamorphic Rocks* now exist, but for the remarkable undulations and contortions so characteristic of these strata. Gneiss and the allied crystalline schists were accordingly placed as the lowest sedimentary strata in a division equivalent to the *Paleozoic Period*, and called the *Azoic*, because they were destitute of organic remains, the conditions in which they were formed being opposed to the existence of animals.

It is now, however, known that *Metamorphic Rocks* occur as contemporaneous deposits in all epochs of the earth's geological history. In Canada and in the Hebrides, they are of Laurentian age; in the Highlands of Scotland, Cambrian and Silurian; in Devon and Cornwall, Old Red Sandstone and Carboniferous; and in the Alps, Oolitic and Cretaceous, and in some parts even Tertiary. Although deposits of such various ages have been thus altered, the resulting rocks are in structure and composition very similar; their ultimate constituents do not differ from those of ordinary clays and sandstones. In all of them, silica forms the largest proportion, consisting of about 60 to 70 per cent.; alumina follows next, and then other substances in smaller quantities, such as lime, soda, potash, iron, &c. This similarity of composition, and the abundance of clays and sandstones, suggest the supposition that the *Metamorphic Rocks* may be nothing more than these deposits greatly altered; this is confirmed by many observed instances, in which

* The discovery of a new metal, *Indium*, has been announced as these pages are passing through the press. Like cesium, rubidium, and thallium, it has been discovered by the spectroscope. Nothing is yet known regarding its general properties, and therefore its place, in so far as classification is concerned, cannot be assigned.

aqueous strata are continuous with, and gradually change into, *Metamorphic Rocks*. The granite of Dartmoor has intruded itself into the slate and slaty sandstone, twisting and contorting the strata. Hence some of the slate rocks have become micaceous; others more indurated, having the characters of mica-slate and gneiss; while others, again, appear converted into a hard-zoned rock, strongly impregnated with felspar. In some places in the Eastern Pyrenees, the chalky limestone becomes crystalline and saccharoid as it approaches the granite, and loses all trace of the fossils which it elsewhere contains in abundance. These illustrations tell of changes occurring in the proximity of granite, and it has been consequently somewhat hastily concluded that this rock, coming up in a molten condition from below, has, by the radiation of its heat, produced the metamorphosis. But the observed stratigraphical position of granite, its sometimes passing by insensible degrees into gneiss, and the experiments of Solly and Bryson on its internal structure, shew without doubt that this rock is, at least in many places, an extreme result of metamorphic action, and not the cause of it. To call the energy producing these results metamorphic or molecular action, is simply to hide our ignorance—we get a name, but nothing more. To speak dogmatically on a subject so obscure, is a sign of the same ignorance. The following, however, are the most probable agents that, together or separately, produced these remarkable changes:

1. *Heat*.—From whatever source derived, heat does exist, either distributed universally, or occurring locally in the mass of the earth; and where it exists, thermo-electric influences induce action, which, carried on over immense series of years, might produce in the end great changes. It is generally maintained that granite is the result of crystallisation from perfect fusion, and that the strata converted into gneiss must have been reduced to a state of semi-fusion. But we know of crystallisation taking place in the most compact amorphous solids without any approach to fusion, as in the axles of railway-carriages; and of metamorphic action without semi-fusion, as in the highly indurated bottoms of bakers' ovens, in which the clay is subjected to a long-continued though not a great heat; or in the sandstone floor of an iron furnace, which, from long contact with the molten iron, loses its colour, becomes white and hard, and breaks with a porcelanic fracture, having, indeed, been changed into quartz rock. Besides, the frequent occurrence of cavities in the rock crystals of granite containing a fluid which fills them only when the temperature is raised to at least 94° F., shews that the crystal could not have been formed at a higher temperature. We are therefore safe in maintaining, that the heat was not in all cases so great as to produce fusion.

2. *Pressure*.—This alone is sufficient to effect the consolidation and induration of aqueous deposits, converting clay or sand into solid stone. When heat is added to pressure, greater activity is likely to be the result. The undulatory movements of the earth's crust, by carrying down to great depths deposits formed on the surface, bring them under the influence of pressure, heat, and thermo-electricity, and at the same time elevate rocks that have been thus acted upon.

It is thought that heated water may be also a powerful agent, especially when it is subjected to great pressure.

These and other agents, then, operating through immense intervals of time, set in motion chemical attraction, whereby the various substances which entered into the composition of the sedimentary

deposits rearranged themselves as they are found in the Metamorphic Rocks.

The description of the various Metamorphic Rocks will be found under their different names, viz., GNEISS, QUARTZITE, MICA-SCHIST, CLAY-SLATE, and MARBLE.

METAMORPHOSIS (Gr. change of form) denoted, in the mythology of the ancients, those transformations of human beings into beasts, stones, trees, and even into fire, water, &c., in fables of which that mythology abounded. The origin and significance of such fables it is often impossible to determine. Some of them probably originated in observation of the wonderful transformations of nature; some in a misapprehension of the metaphors employed by the older poets; and some, perhaps, in mere superstition and love of the marvellous. The wild imagination of the Orientals filled their mythologies with metamorphoses in the greatest number; and the classic mythology approaches to them in this respect. They were the theme of some of the poets and other Greek authors of the Alexandrine period, and of Ovid among the Latin classics. The mediæval literature of Europe, especially of Germany, in its fairy tales and other forms of folk-lore, is also wonderfully rich in metamorphoses.

METAMORPHOSIS OF ANIMALS. This term is applied to changes which certain animals undergo after their escape from the envelope of the egg, and which are of such a nature as essentially to alter the general form or the mode of life of the individual.

The most remarkable metamorphoses occur in the Batrachians, Crustaceans, Insects, and Tape-worms, and are briefly noticed in the articles on those classes of animals. For an excellent general account of the metamorphoses of animals, the reader is referred to a series of articles by De Quatrefages in the *Revue des Deux Mondes* for 1853.

METAMORPHOSIS OF ORGANS, in Botany, a subject of so much importance, that it has been exalted to the rank of a distinct branch of botanical science, under the name of *Morphology* or *Vegetable Morphology*. Attention to it is essential to a philosophical study of botany; yet it may almost be said that nothing was known either of its facts or its laws, till the poet Goethe proclaimed them to the world in his treatise entitled *Die Metamorphose der Pflanzen*, in 1790. Linnæus had, indeed, called attention to the development of organs, and the changes which they undergo, and had made this the subject of a *thesis* entitled *Prolepsis Plantarum* in 1760; but, in a manner very unusual with him, he mixed up with his observations and philosophical speculations certain fanciful suppositions, the falsehood of which soon becoming apparent, caused all the rest to be neglected. Wolf afterwards extricated the true from the fanciful in the views of Linnæus, and gave them greater completeness; but he introduced the subject only incidentally in a paper on comparative anatomy, which failed to attract the attention of botanists, and probably had never been seen by Goethe, whose discovery, apparently altogether original, is one of the finest instances on record of acute observation combined with philosophical generalisation.

The metamorphosis of organs is noticed in the articles on particular organs. It is only necessary here to make a very general statement of its facts and laws. A plant is composed of the *axis* and its *appendages*; the *axis* appearing above ground as the stem and branches, below ground as the root; the *appendages* being entirely above ground, and essentially *leaves*; all organs which are not formed of the

axis being modified leaves. The proof of this consists very much in the gradual transition of one organ into another, manifest in some plants, although not in others; as of leaves into bracts, one of the most frequently gradual transitions; of leaves into sepals, as seen in the leaf-like sepals of many roses; of sepals into petals, as seen in the petal-like sepals of lilies, crocuses, &c.; of petals into stamens, as seen in water-lilies; and even of stamens into pistils, often exemplified in the common house-leek. The proof is confirmed and completed by observation of the monstrosities which occur in plants, particularly in the frequent return of some part of the flower to its original type, the leaf, and in the conversion of one part of the flower into another, which is often the result of cultivation, and is particularly illustrated in *double* flowers, the increase of the number of petals being the result of the conversion of stamens into petals.

A flower-bud being a modified leaf-bud (see **BUD**), and a flower therefore the development of a modified leaf-bud, the parts of a flower correspond in their arrangement with the leaves on a branch. But peculiar laws govern the development of organs in each species of plant. Thus, the leaves in one are opposite; in another, alternate; in another, whorled; all depending on the law which governs the growth of the *axis* in relation to the development of leaves, which is very constant in each species; and in like manner the parts of the flower are developed in whorls around an abbreviated terminal portion of the *axis*, the energies of the plant being here directed to the reproduction of the species, and not to the increase or growth of the individual. The fruit itself, being formed from the pistil, is to be regarded as formed of modified leaves. Goethe truly says: 'The pod is a leaf which is folded up and grown together at its edges, and the capsule consists of several leaves grown together; and the compound fruit is composed of several leaves united round a common centre, their sides being opened so as to form a communication between them, and their edges adhering together.'

The metamorphosis of organs has been investigated with great diligence and success, and beautifully elucidated by Miquel, Lindley, Schleiden, and other botanists.

METAMORPHOSIS OF TISSUE. See **TISSUE**.

METAPHOR (Gr. *metaphora*, a transference), a figure of speech, by means of which one thing is put for another which it only resembles. Thus, the Psalmist speaks of God's law as being 'a light to his feet and a lamp to his path.' The metaphor is therefore a kind of comparison, in which the speaker or writer, casting aside the circumlocution of the ordinary similitude, seeks to attain his end at once, by boldly identifying his illustration with the thing illustrated. It is thus of necessity, when well conceived and expressed, graphic and striking in the highest degree, and has been a favourite figure with poets and orators, and the makers of proverbs, in all ages. Even in ordinary language the meanings of words are in great part metaphors; as when we speak of an *acute* intellect, or a *bold* promontory.

METAPHYSICS, a word of uncertain origin, but first applied to a certain group of the philosophical dissertations of Aristotle (see **ARISTOTLE**). As since employed, it has had various significations, and more especially two—a larger and a more confined. In the more confined sense, it is allied to the problems of the Aristotelian treatise, and is concerned with the ultimate foundations of our knowledge of existing things. What is the nature of our knowledge of the external world, seeing that mind cannot properly know what is not in contact with

itself? has been asked by philosophers, and answered in various ways; and this is the great question of metaphysics (see PERCEPTION, COMMON SENSE). The name 'Ontology' has been applied to the same inquiries into our cognizance of existences out of ourselves. But as the solution of this difficult question was found to involve an investigation into the nature of the human mind, it became allied with the science whose object it is to describe fully and systematically the laws and properties of our mental constitution—a science called by the various names of Psychology, Mental Philosophy, Moral Philosophy; and hence Metaphysics came to be an additional name for this more comprehensive department. The word is employed at the present day by writers of repute in both meanings. Thus, Ferrier's *Institutes of Metaphysic* is occupied solely with the questions connected with knowledge, or the nature of our perception of an external world; his explanatory title is, *The Theory of Knowing and Being*. On the other hand, Mansel's *Metaphysics* is divided into two parts—PSYCHOLOGY, or the science of the facts of consciousness, which expresses the science of mind generally; and ONTOLOGY, or the science of the same facts considered in their relation to realities existing without the mind—that is, the problem of Perception, or Metaphysics in the narrower sense.

METASTASIO (originally TRAPASSI), PIETRO, one of Italy's most admired poets, was born at Rome in 1698, of humble parents, and gave early evidence of his genius by his boyish improvisations. M. having attracted the casual notice of Gravina, a famous juriconsult of the day, the latter undertook the entire education and career of the youth, whose paternal name of Trapassi became thenceforward Grecised into Metastasio, both words being identical in signification. The young poet speedily advanced in classical and general knowledge; and to his patron's enthusiastic devotion to the Greek drama, may doubtless be traced much of the after-bent of M.'s own poetical tastes. By the early death of Gravina, M. was placed in possession of considerable property. In 1724, he published one of his most celebrated dramas, *La Didone*, which, with *Il Catone* and *Il Siroe*, conferred on the poet a European name. In 1730, M. accepted the post of poet-laureate to the imperial court of Vienna. During his sojourn in Vienna, M. composed his *Giuseppe Ricinocinto*, *Il Demofonte*, and the *Olimpiade*. He died at Vienna in 1782. M. was distinguished for the generosity, integrity, and candour of his nature, the sincerity of his friendships, and the disinterested warmth of his sentiments. His works are innumerable, embracing 63 dramas, 48 cantatas, besides a vast number of elegies, canzonette, sonnets, and translations. They enjoy unexampled popularity among all grades of his countrymen; in their pure classical subjects and forms, the educated student finds instruction and delight; while their facile musical grace and verbal simplicity adapt them to the popular appreciation of the artless beauties of poetry. The best editions of M. are those of Turin (1757, 14 vols.); Paris (1755, 12 vols.); Paris (1780, 12 vols., large 8vo); Genoa (1802, 6 thick vols.); Mantua (1816—1820, 20 vols.).

METAYER (Ital. *metà*, Fr. *moitié*, half), in French, is the cultivator of a *metairie*, or farm, the tenant of which gives the landlord a portion of the produce as his rent. In some of the older French dictionaries, such as that of Trevoux, the word is said to apply to any kind of farmer, but in the oldest dictionary of French and English, Cotgrave's, the word is thus interpreted: 'Properly one that takes ground, to the halves, or binds

himself by contract to answer unto him of whom he holds them half, or a great part of the profits thereof.' The term has lately got a meaning in political economy on account of some eminent writers having raised the question, whether this arrangement between landlord and tenant is not so much more advantageous than any other, both to the parties immediately concerned, and to the public at large, that it ought to be specially encouraged. Sismondi appears to have been the first to open this wide view of the influence of the practice, and he has given a chapter to its consideration in his *Political Economy* (b. iii. chap. 5). He says what cannot be denied, that such an arrangement was a great improvement on mere serfdom, which gave the cultivator no interest in the produce of his industry. But in giving the reasons for his admiration of the system as one which provides in the general case for the wants of the peasant while relieving him of all anxiety about markets and prices, he admits that a metayer peasantry never advance beyond the humble, happy, and contented lot which immediately falls to them. It is a system, therefore, inconsistent with the application of large capital to cultivation, and consequently with the extraction of the highest value which the soil can yield. A tenant will hesitate to lay £50 worth of guano on his fields if half the additional crop it will bring goes to his landlord. To those who maintain that the moral effect of the system is beneficial, this will be no argument against it, but to the political economist it is an argument against the practicability of the system in a rich money-making agricultural country. Where there is an enterprising peasantry without capital it is a valuable resource; a great portion of the valuable agricultural districts of Scotland were thus brought into cultivation by improvers whose rent was a portion of the crop. But while these very districts in a great measure owe their present prosperity, and the existence of a set of capitalist-farmers to such a system of cultivation pursued with more energy than M. Sismondi considers natural to it, there is no doubt that the substitution of such an arrangement for money-rent would now be a very serious waste.

METELLUS, the name of a Roman family of the plebeian gens Cæcilia, which rose to be one of the first families of the Roman nobility.—One of the most distinguished members of the family was QUINTUS CÆCILIUS M. MACEDONICUS, who received his surname from his victory over Andrisicus, an aspirant to the throne of Macedonia (148 B.C.). His life was considered by ancient writers an example of the greatest felicity. He died 115 B.C.—Another was QUINTUS CÆCILIUS M. NUMIDICUS, who twice defeated Jugurtha in Numidia (109 B.C.), and was celebrated for his integrity of character, but was superseded in his command by Marius. His son, QUINTUS CÆCILIUS M., surnamed *Pius*, joined Sulla in 83 B.C., but sought to moderate the severity of his proscriptions. He, too, bore a distinguished character for virtue.—QUINTUS CÆCILIUS M. CRETICUS conquered Crete, and reduced it to a Roman province (67 B.C.).—QUINTUS CÆCILIUS M. PIUS SCIPIO, sometimes called QUINTUS SCIPIO, and sometimes SCIPIO M., was a son of Publius Cornelius Scipio, who was adopted by one of the Metelli, and became the father-in-law of Pompey, and his zealous partisan. He commanded under him at Pharsalus, maintained war on his behalf for some time in Africa; and after the battle of Thapsus (46 B.C.), died by his own hand.

METEMPSYCHOSIS. See TRANSMIGRATION OF SOULS.

METEOROLOGY.

METEOROLOGY (Gr. *metēōra*, meteors, or atmospheric phenomena) was originally applied to the consideration of all appearances in the sky, both astronomical and atmospheric; but the term is now confined to that department of natural philosophy which treats of the phenomena and modifications of the atmosphere as regards weather and climate. The leading points of this wide subject will be found under such heads as AEROLITES, ATMOSPHERE, BAROMETER, BOILING, CLOUDS, DEW, ELECTRICITY, EVAPORATION, FOG, HAILSTONES, HALOS, HOAR-FROST, LIGHTNING, MAGNETISM, RAIN, SNOW, STORMS, &c. We confine ourselves here to a historical sketch of the science.

Owing to the complexity of the phenomena, meteorology is the most difficult and involved of the sciences, and seems, indeed, at first sight, almost incapable of being reduced to a science at all. On this account, the only procedure admissible in the first place is long and patient observation, and a faithful recording of facts.

From the nature of the subjects which make up the science, it may be inferred that they occupied men's minds from a remote antiquity. The splendid and ever-varying panoramas of the sky, and the changes of temperature through the days and the seasons, with all the other elements constituting the weather, and thus powerfully affecting the necessities and comfort of man, are of a nature well fitted to arrest his attention. From the time spent in the open air in the early ages, and from the imperfect protection afforded against the inclemency of the seasons, those appearances which experience proved to precede a change of weather would be eagerly recorded and handed down. In this way, many most valuable facts were ascertained and passed current from hand to hand; and, perhaps, there is no science of which more of the leading facts and inferences have been from so early a period incorporated into popular language.

Aristotle was the first who collected, in his work *On Meteors*, the current prognostics of the weather. Some of these were derived from the Egyptians, who had studied the science as a branch of astronomy, while a considerable number were the result of his own observation, and bear the mark of his singularly acute and reflective mind. The next writer who took up the subject was Theophrastus, one of Aristotle's pupils, who classified the opinions commonly received regarding the weather under four heads, viz, the prognostics of rain, of wind, of storm, and of fine weather. The subject was discussed purely in its popular and practical bearings, and no attempt was made to explain phenomena whose occurrence appeared so irregular and capricious. Cicero, Virgil, and a few other writers also wrote on the subject without making any substantial accessions to our knowledge; indeed, the treatise of Theophrastus contains nearly all that was known down to comparatively recent times. Partial explanations were attempted by Aristotle and Lucretius, but as they wanted the elements necessary for such an inquiry, being all but totally ignorant of every department of physical science, their explanations were necessarily vague, and often ridiculous and absurd.

In this dormant condition, meteorology remained for ages, and no progress was made till proper instruments were invented for making real observations with regard to the temperature, the pressure, the humidity, and the electricity of the air. The discovery of the weight and pressure of the atmosphere made by Torricelli in 1643, was undoubtedly the first step in the progress of meteorology to the rank of a science. This memorable discovery disclosed what was passing in the more elevated

regions of the atmosphere, and thus the elevations and depressions of the barometric column largely extended our knowledge of this subtle element. See **BAROMETER**.

The invention and gradual perfecting of the Thermometer (q. v.) in the same century, formed another capital step; as without it, nothing could be known, beyond vague impressions, regarding temperature, the most important of all the elements of climate. This great invention soon bore excellent fruit. Fahrenheit constructed small and portable thermometers, which, being carried by medical men and travellers over every part of the world, furnished observations of the most valuable description—the comparative temperature of different countries became known, and the exaggerated accounts of travellers with regard to extreme heat and cold were reduced to their proper meaning. Little less important was the introduction of the Hygrometer (q. v.), first systematically used by De Saussure (died 1799) and afterwards improved by Dalton, Daniell, and Koerner. From the period of the invention of these instruments, the number of meteorological observers greatly increased, and a large body of well-authenticated facts of the utmost value was collected. The climates of particular parts of the earth were determined, and the science made great and rapid advances by the investigations undertaken by distinguished philosophers into the laws which regulate the changes of the atmospheric phenomena.

The theory of the trade-winds was first propounded by Geörgy Hadley in the *Philosophical Transactions* for 1735; and it may be mentioned as a remarkable fact, that, for about half a century, it remained quite unnoticed, when it was independently arrived at by Dalton, and published in his essays.

The publication of Dalton's *Meteorological Essays*, in 1793, marks an epoch in meteorology. It is the first instance of the principles of philosophy being brought to bear on the explanation of the intricate phenomena of the atmosphere. The idea that vapour is an independent elastic fluid, and that all elastic fluids, whether alone or mixed, exist independently; the great principles of motion in the atmosphere; the theory of winds, their effect on the barometer, and their relation to temperature and rain; observations on the height of clouds, on thunder, and on meteors; and the relations of magnetism and the aurora borealis—are some of the important questions discussed in these remarkable essays, with an acuteness, a fulness, and a breadth of view that leave nothing to be desired.

One of the most interesting and fruitful subjects of inquiry that engaged the attention of meteorologists was dew. The observations on this subject were first collected and reduced to a perfect theory by Dr Wells. See **Dew**.

In 1823, Daniell published his *Meteorological Essays and Observations*, which, while adding largely to our knowledge in almost every department of the subject, are chiefly valuable as bearing on the hygrometry of the atmosphere. Though the practical advantages which he anticipated would flow from it have not been realised, yet this difficult and still obscure department of meteorology stands indebted to him more than to any other philosopher. The law of the diffusion of vapour through the air, its influence on the barometric pressure, and its relations to the other constituents of the atmosphere, are among the least satisfactorily determined questions in meteorology. Since this element is so important as an indicator of storms and other changes of the weather, and since so much remains still to be achieved, it is to be hoped that it will soon be more thoroughly investigated. A most

METEOROLOGY.

important addition has lately been made to our knowledge of the vapour of the atmosphere by Professor Tyndall, in his experiments on radiant heat, especially as regards the gases. The vapour of water is there shewn to exert extraordinary energy as a radiator and absorbent of heat; and hence the vapour dissolved in the air acts the part of a covering or protection to the earth. As it is, to a great extent, impervious to solar and terrestrial radiation, it follows that if the air were quite drained of its moisture, the extremes of heat and cold would be so intense and insufferable, that all life would instantly perish, there being no screen shielding the earth from the scorching glare of the sun by day, and from the equally scorching and blighting effects of its own radiation by night. It is to be expected that this great discovery will soon throw light on many questions of meteorology.

Electrical observations have been, of all meteorological observations, perhaps the least productive, partly owing to their scantiness, from the expense and trouble attending them, and partly, no doubt, to the free and bad use made of the name of electricity by crude theorists in explaining phenomena of which it would have been wiser to have confessed their ignorance. But the brilliant discoveries which have recently been made on the mutual relations of heat, motion, electricity, magnetism, and the other forces of matter, lead us to indulge the hope that the application of these results to meteorology will be attended with discoveries equally brilliant and important.

Humboldt's treatise on *Isothermal Lines* (1817) constitutes a notable epoch in experimental meteorology. Dové has since continued the investigation, and in his splendid work, *On the Distribution of Heat on the Surface of the Globe*, has given charts of the world, shewing the temperature for each month and for the year, and also charts of abnormal temperatures. It is scarcely possible to overestimate the value of this work, for though, to a considerable extent, the lines are hypothetical, there can be no doubt that a close approximation to the march of mean temperature and its distribution over the earth through the year, has been arrived at. The idea has been carried out with greater fullness of detail by the United States' government in the beautiful and elaborate series of charts of temperature and rainfall given in the *Army Meteorological Register* for 1855. In these charts, the temperature and rainfall in the different seasons for every part of the United States, deduced from accurate observations, may be seen at a glance. It is to be hoped that other governments will undertake the preparation and publication of similar charts, the value of which can hardly be overestimated.

The establishment of meteorological societies during the last fourteen years must also be commemorated as contributing in a high degree to the solid advancement of the science which, more than any other, must depend on extensive and carefully conducted observation. In this respect, the United States stand pre-eminent, the observers there numbering nearly 800. Great Britain is also well represented in the English and Scottish societies, which together number about 150 observers. In France, Germany, and Russia, the science is also being widely cultivated. For the last three years, owing to the disastrous flooding of the Rhone, an inquiry has been carried on, having for its object the determination of those causes which affect the rainfall in the basins of the Rhone and Saône. Observers in Germany and Great Britain have been secured to co-operate with the French observers, and under the able management of M. Fournet, it may be expected that important conclusions respecting the

rainfall and the progress of storms will be arrived at, and means devised to avert the calamity of these great floods, by timely warning being given of their approach.

A special object of meteorological societies is to ascertain the degrees of heat, cold, and moisture in various localities, and the usual periods of their occurrence, together with their effects on the health of the people, and upon the different agricultural productions; and by searching into the laws by which the growth of such products is regulated, the agriculturist may be enabled to judge with some degree of certainty whether any given article can be profitably cultivated.

But perhaps none of the arts have benefited to so large an extent by the labours of meteorologists as navigation. The knowledge thus acquired of the prevailing winds over the different parts of the earth during the different seasons of the year—and the regions of storms and calms—and the laws of storms, have both saved innumerable lives, and by pointing out the most expeditious routes to be followed, shortened voyages to a remarkable degree. In connection with this, the name of Captain Maury (q. v.) deserves special commendation for the signal service he has rendered to navigation.

Another fruit of the multiplication of meteorological stations is the prediction of storms and 'forecasts' of the weather, which have been carried on in the United States, and with particular ability and success by Admiral Fitzroy in England. Admiral Fitzroy's 'forecasts' are based on telegrams which he receives every morning from about thirty selected stations in Great Britain and Ireland, and on the continent, from Copenhagen as far south as Lisbon. These telegrams give the exact state of the barometer, thermometer, hygrometer, and rain-gauge, with the direction and force of the wind, and appearance of the sky, at each of these thirty stations at nine in the morning. In the event of there being any storm or other atmospheric disturbance at one or more of these places, a full and accurate description of it is thus conveyed to London; and it is thence the duty of Admiral Fitzroy to consider the direction in which the storm is moving, so as to enable him to give warning of its approach by special signals. But in addition to warnings of storms, there are also given daily 'forecasts' of the weather likely to occur in the different districts of Great Britain for the two following days, and which are in like manner founded on the state of the atmosphere at distant points, keeping in view the atmospheric currents known generally to prevail at that particular time of the year. As the cost of this system is about £2000 annually, a severe test was applied, at the instance of the Treasury, from July 1861 to June 1862, for the purpose of ascertaining whether the expenditure was justified by the success attending it. During the first six months, 413 signals were hoisted, and in 214 cases a storm occurred where a warning was given. It must not be inferred that in the remaining 199 cases there was no storm anywhere; all that is meant is, that no storm occurred at the places where the signal was given; but a storm may have occurred, and probably did occur, in some other part of the country. Now that the system has been longer in use, it may be presumed that the signals are given from a better knowledge of the movements of the atmosphere, and that if the test were again applied, the correspondence would be found more frequent. Since the barometric depression is in almost all cases spread over a wider area than the storm which accompanies it, and since the storm occasionally passes into the upper regions of the atmosphere, so as not to be felt on the earth's surface at that place,

it is obvious that a considerable time must yet elapse before a sufficiently intimate knowledge of the movements of the air be acquired in order to indicate with certainty the particular places where the storm will break out, and where it will not. The problem to be practically worked out is this: Given the telegrams from the stations shewing the exact meteorological conditions prevailing over the included area, with indications of a storm approaching in a certain direction, to determine, not the probable area over which the tempest will sweep, but the precise localities which will altogether escape, the places where the storm will rage, and the places where it will not touch the earth, but pass innocuously into the upper regions of the atmosphere; its continuance, its violence, and the particular directions from which the wind will blow at the places visited by the storm while it lasts. Considerable progress has already been made towards the solution of this difficult problem; and if a complete solution be impossible, it is not too much to expect that such an approximation will be arrived at as will render it foolhardy to disregard the warnings given.

But these predictions only extend to a few days. Does the present state of the science afford any grounds to hope that prediction for longer periods will yet be attained? Weather-registers extending over long periods give no countenance whatever to the notion, that there are regularly recurring cycles of weather on which prediction may be based. Further, the manner in which good and bad seasons occur in different places with respect to each other, shews clearly that they have no direct or immediate dependence on any of the heavenly bodies, but that they depend directly on terrestrial causes. Thus, while the summer of 1861 was almost unprecedentedly wet and cold in Scotland, the same summer was hot and dry to a degree equally unprecedented on the continent of Europe, and particularly in Italy; and such examples may be multiplied almost *ad infinitum*.

The consideration that the equatorial and polar currents of wind at any locality must ultimately balance each other, would appear, from recent observation, to give ground for prediction extending over very considerable intervals. Thus, a wet summer was predicted for Britain in 1862, from the circumstance of a most unusual prevalence of east winds in the spring of that year. An almost incessant continuance of south-west winds followed, which discharged themselves in deluges of rain, clouded skies, and a consequent low temperature. As these south-west winds continued with little intermission till the spring of 1863, less than the usual quantity of south-west winds was expected during the summer, which was accordingly looked forward to as likely to be fine and warm—a prediction which was fully realised, more especially for the earlier part of the season.

The following are a few standard works on Meteorology, in addition to those already referred to: L. F. Kaerntz's *Meteorology*, translated from the German (Lond. 1845); Dr Ernst Erhard Schmid's *Lehrbuch der Meteorologie* (Leipzig. 1860); Professor Espy's *Fourth Report on Meteorology* (Washington, 1857); Drew's *Meteorology*, a useful handbook (Lond. 2d ed. 1860); Herschel's *Meteorology* (Edinb. 1861); D. P. Thompson's *Introduction to Meteorology* (Edinb. 1849).

METHODISTS, the name originally given, about the year 1729, by a student of Christ-Church to the brothers Wesley, and several other young men of a serious turn of mind, then members of different colleges of Oxford, who used to assemble together on particular nights of the week chiefly for religious conversation. The term was selected, it is believed,

in allusion to the exact and *methodical* manner in which they performed the various engagements which a sense of Christian duty induced them to undertake, such as meeting together for the purpose of studying Scripture, visiting the poor, and prisoners in Oxford jail, at *regular* intervals. Subsequently, it came to be applied to the followers of Wesley and his coadjutors, when these had acquired the magnitude of a new sect; and though their founder himself wished that 'the very name,' to use his own words, 'might never be mentioned more, but be buried in eternal oblivion,' yet it has finally come to be accepted by most, if not all of the various denominations who trace their origin mediately or immediately to the great religious movement commenced by John Wesley. For an account of the origin and earlier development of Methodism, see articles on the brothers WESLEY and WHITEFIELD. We confine ourselves here to a brief notice of its organisation, doctrine, and present condition.

1. *Organisation*.—This appears to have been partly improvised by Wesley to suit the exigencies of his position. It was not a theoretical and premeditated, but a practical and *extempore* system. In the *Rules of the Society of the People called Methodists*, drawn up by himself, he says: 'In the latter end of the year 1739, eight or ten persons came to me in London, who appeared to be deeply convinced of sin, and earnestly groaning for redemption. They desired (as did two or three more the next day) that I would spend some time with them in prayer, and advise them how to flee from the wrath to come, which they saw continually hanging over their heads. That we might have more time for this great work, I appointed a day when they might all come together, which from thenceforward they did every week, viz., on Thursday, in the evening.' This he calls 'the first Methodist Society.' Its numbers rapidly increased, and similar 'societies' were soon formed in different parts of England, where the evangelistic labours of the Wesleys had awakened in many minds 'a desire to flee from the wrath to come, and be saved from their sins'—the only condition, we may remark, required of any for admission into these societies. In order to ascertain more minutely how the work of salvation was progressing in individual cases, Wesley subdivided the societies into 'classes,' according to their respective places of abode, each class containing about a dozen persons, under the superintendence of a 'leader,' whose duties are partly religious and partly financial. 1. He has to see each person in his class: once a week, 'to inquire how their souls prosper,' and to encourage, comfort, or censure, as the case may require. 2. To collect the voluntary contributions of his class, and pay it over to the 'stewards' of the society, and to give the ministers all necessary information regarding the spiritual or bodily condition of those under his leadership. For preaching purposes, on the other hand, the societies were aggregated—a certain number of them constituting what is called a circuit. This now generally includes a town, and a rural circle of ten or fifteen miles. To each circuit, two, three, or four ministers are appointed, one of whom is styled the 'superintendent;' and here they labour for at least one year, and not more than three. Every quarter, the classes are visited by the ministers, who make it a point to converse personally with every member; at the termination of which proceeding, a 'circuit-meeting' is held, composed of ministers, stewards, leaders of classes, lay-preachers, &c. The stewards (who are taken from the societies) deliver their collections to a circuit-steward, and the financial business of the body is here publicly

settled. At this quarterly meeting, candidates for the office of the ministry are proposed by the president, and the nomination is approved or rejected by the members. Still larger associations are the 'districts,' composed of from ten to twenty circuits, the ministers of which meet once a year, under the presidency of one of their number, for the following purposes: 1. To examine candidates for the ministry, and to try 'cases' of immorality, heresy, insubordination, or inefficiency on the part of the clergy. 2. To decide preliminary questions concerning the building of chapels. 3. To investigate and determine the claims of the poorer circuits to assistance from the general funds of the body. 4. To elect a representative to the committee of Conference, whose duty is to nominate ministers for the different stations for the ensuing year—their appointments, however, being subject to the revision of Conference. In all the financial and other purely *secular* business of the districts, laymen (such as circuit-stewards and others) deliberate and vote equally with the clergy. The supreme Methodist assembly is the 'Conference.' The first was held in 1744, when John Wesley met his brother Charles, two or three other clergymen, and a few of the 'preachers'—men whom his zeal and fervour had induced to abandon their secular employments, and devote themselves to declaring the message of the Gospel. The purpose for which he called them together was, he says, 'for the sake of conversing on the affairs of the "societies" and the result of our consultations we set down to be the rule of our future practice.' In the course of his life, Wesley presided at forty-seven of these annual assemblies. The Conference now consists of 100 ministers, mostly seniors, who hold their office according to arrangements prescribed in a Deed of Declaration, executed by John Wesley himself, and enrolled in Chancery. But the representatives previously mentioned, and all the ministers allowed by the district committees to attend—who may or may not be members of the legal Conference—sit and vote usually as one body, the 100 confirming their decisions. In this assembly, which is exclusively clerical, every minister's character is subjected to renewed and strict scrutiny, and if any charge be proved against him, he is dealt with accordingly; candidates for the ministry are examined both publicly and privately, and set apart to their sacred office; the entire proceedings of the inferior courts (if we may so call them) are finally reviewed; and the condition, requirements, and prospects of the body are duly considered.

2. Doctrine and Worship.—Under this head, not much requires to be said. Wesleyan Methodists claim to be considered *orthodox, Protestant, and evangelical*. The propriety of the last two appellations will probably not be disputed, but a rigid Calvinist might object to the first. They accept the *articles* of the English Church, but believing these articles to have been framed on a basis of *comprehension*, they consider themselves at liberty to accept them in an Arminian sense. It must not, however, be supposed that they are out-and-out Arminians. Their great distinguishing doctrine is the universality and freedom of the atonement; hence they reject the Calvinistic doctrine of predestination (which they conceive to be incompatible with the former), but while they maintain the freedom of the will and the responsibility of man, they also maintain his total fall in Adam, and his utter inability to recover himself. If these two appear to the human understanding to conflict, it is nevertheless asserted that the Bible teaches both; and it is objected to high Calvinism, that in its anxiety to be logical, it has shewn itself unscriptural. Pro-

minence is also given by the Wesleyan M. to certain points of religion, some of which are not altogether peculiar to them. They insist on the necessity of men who profess to be Christians feeling a *personal interest* in the blessings of salvation—i. e., the assurance of forgiveness of sins and adoption into the family of God. This, however, is not to be confounded with a certainty of *final salvation*. They believe the Spirit of God gives no assurance to any man of that, but only of *present pardon*. In harmony with this view, they reject the doctrine of the necessary perseverance of the saints, and hold that it is fearfully possible to fall from a state of grace, and even to perish at last after having 'tasted of the heavenly gift,' and having been 'made partakers of the Holy Ghost.' They also maintain the perfectibility of Christians, or rather the possibility of their entire sanctification as a privilege to be enjoyed in this life. But Wesley 'explains' that 'Christian perfection does not imply an exemption from ignorance or mistake, infirmities or temptations; but it implies the being so crucified with Christ as to be able to testify, "I live not, but Christ liveth in me."' He regards the sins of a 'perfect' Christian as 'involuntary transgressions,' and does not think they should be called 'sins' at all, though he admits that they need the atoning blood of Christ. The Wesleyan Methodists in their religious services use more or less the English liturgy; the morning service being read in many of their chapels, and the sacramental offices being required in all. They observe a 'watch-night' on the eve of the New Year, on which occasion the religious services are protracted till midnight, and their chapels are generally crowded to excess; and in the beginning of the year they hold a 'covenant-service,' at which congregations stand up to a man (though this form is not invariable), and solemnly vow to serve the Lord. But even the ordinary religious services in some places are frequently marked by an ebullition of fervent feeling on the part of the audience, which has a very singular effect upon a stranger.

3. History.—The history of Methodism is for many years the history of Christian effort to evangelise the neglected 'masses' of England. The labours of Wesley, and of those whom he inspired to imitate his example, were of the noblest description, and met with remarkable success. The reformation of life which his preaching produced, for example, among the Kingswood colliers and the Cornwall wreckers, is a testimony to the power of religion which cannot be too highly estimated. The zeal which has inspired the body in regard to foreign missions, although in the highest degree honourable, is only the logical development of their efforts at home—for they originally regarded their society in England as simply a vast 'home mission,' and neither Wesley nor his followers desired to consider themselves a 'sect,' a new church, in the common usage of the term, but were warmly attached to the old national church, and considered themselves among her true children. When Wesley died (1791), his 'societies' had spread over the United Kingdom, the continent of Europe, the States of America, and the West Indies, and numbered 80,000 members. Since then, they have largely increased, and, according to the latest official returns, the membership (including the numbers in foreign missions, embracing continental India, Northern Europe, China, Asia Minor, the South Sea and West India Islands) amounts to 526,554 (of whom 329,704 belong to Great Britain, and 21,953 to Ireland), and the number of ministers, 1899. The annual income of 'The Wesleyan Methodist Missionary Society' is upwards of £140,000; it has more than 4600 chapels and

preaching-rooms; about 800 ordained missionaries and assistant-missionaries; 1300 catechists, interpreters, day-school teachers, &c.; 15,000 gratuitous co-operators; and about 150,000 scholars. It also supports eight printing-establishments.

The Wesleyan M. have two theological colleges for the training of ministers, one at Richmond Hill, Surrey, and another at Didsbury, South Lancashire, besides the establishments at Sheffield and Taunton, and two schools for the education of sons of Wesleyan ministers. The Methodist Book-room is situated in the City Road, London, and issues hundreds of thousands of religious publications (tracts, &c.) monthly. The newspapers and other periodicals professedly in connection with the body are the larger and smaller *Magazines*, the *Christian Miscellany*, *Wesleyan Sunday School Magazine*, monthly *Exercises on Scripture Lessons*, *Early Days*, the *Watchman*, the *Methodist Recorder*, and the *London Quarterly Review*. Among the more eminent Methodist authors may be named the two Wesleys, Fletcher, Benson, Clarke, Moore, Watson, Drew, Edmondson, Sutcliffe, Jackson, Treffry, Rule, Nichols, Smith, and Etheridge.

METHODIST EPISCOPAL CHURCH, the name given to the Society of Wesleyan M. in the United States of America, where the first members of that body—immigrants from Ireland—established themselves as a religious society in New York in the year 1766. In the course of a year or two, their numbers had considerably increased, and they wrote to John Wesley to send them out some competent preachers. Two immediately offered themselves for the work, Richard Boardman and Joseph Pilmoor, who were followed in 1771 by Francis Asbury and Richard Wright. The agitations preceding the War of Independence, which soon afterwards broke out, interrupted the labours of the English Methodist preachers in America, all of whom, with the exception of Asbury, returned home before the close of the year 1777; but their place appears to have been supplied by others of native origin, and they continued to prosper, so that, at the termination of the revolutionary struggle, they numbered 43 preachers and 13,740 members. Up to this time, the American Wesleyan M. had laid no claim to being a distinct religious organisation. Like Wesley himself, they regarded themselves as members of the English Episcopal Church, or rather of that branch of it then existing in America, and their 'preachers' as a body of irregular auxiliaries to the ordained clergy. 'Episcopal churches,' we are informed, 'are still standing in New York and elsewhere, at whose altars Embury, Pilmoor, Boardman, Strawbridge, Asbury, and Rankin, the earliest Methodist preachers, received the holy communion.' But the recognition of the United States as an independent country, and the difference of feelings and interests that necessarily sprung up between the congregations at home and those in America, rendered the formation of an independent society inevitable. Wesley became conscious of this, and met the emergency in a manner as bold as it was unexpected. He himself was only a presbyter of the Church of England, but having persuaded himself that in the primitive church a presbyter and a bishop were one and the same order, differing only as to their official functions, he assumed the office of the latter, and, with the assistance of some other presbyters who had joined his movement, he set apart and ordained the Rev. Thomas Coke, D.C.L., of Oxford University, bishop of the infant church, September 2, 1784. Coke immediately sailed for America, and appeared, with his credentials, at the Conference held at Baltimore, December 25 of the same year. He was unanimously recognised by the assembly of preachers,

appointed Asbury coadjutor bishop, and ordained several preachers to the offices of deacon and elder. Wesley also granted the preachers permission (which shews the extensive ecclesiastical power he wielded) to organise a separate and independent church under the Episcopal form of government: hence arose the 'Methodist Episcopal Church in the United States of America.' Nevertheless, there were not a few who were dissatisfied with the Episcopal form of government. This feeling grew stronger and stronger, until, in 1830, a secession took place, and a new ecclesiastical organisation was formed, called the METHODIST PROTESTANT CHURCH, whose numbers, at the seventh general conference (1858), amounted to 90,000 members and 2000 preachers. In 1842, a second secession took place, chiefly on the question of slavery—the seceders pronouncing all slave-holding sinful, and excluding slave-holders from church membership and Christian fellowship; and in 1843, a meeting was held at Utica, New York, where a new society was constituted and named the WESLEYAN METHODIST CONNECTION OF AMERICA, whose members, in 1858, amounted to 20,000, and its preachers to 300. But in 1844 a far larger and more important secession took place on the same question, when the whole of the Methodist societies in the southern or slave-holding states, conceiving themselves aggrieved by the proceedings instituted at the general conference of New York (1844) against the Rev. James O. Andrew, D.D., one of the bishops, and a citizen of Georgia, who had married a lady possessed of slaves, resolved to break off connection with their northern brethren. Hence originated the METHODIST EPISCOPAL CHURCH, SOUTH, whose numbers, in 1859, were as follow: Travelling preachers, 2661; local preachers, 5177; white members, 511,601; coloured members, 197,348; Indians, 4236; total, 721,023. Its missionary labours are chiefly confined to the Southern States, and embrace the plantation-negroes, Indians, Germans, and other poor whites. It supports 21 'colleges,' several newspapers and periodicals, and pays great attention to Sunday-schools.

Returning to the English Wesleyan M., we now proceed to mention the various secessions from the parent body in the order of time.

1. THE METHODIST NEW CONNECTION.—This society detached itself from the older one in 1797. Its doctrines and order are the same; the only difference being that it admits one layman to each minister into the Conference, and allows them to share in the transaction of all business both secular and spiritual. These laymen are chosen either by the circuits, or by 'guardian representatives' elected for life by the Conference. In 1859, the numbers of the New Connection were: members, 26,396; preachers, 186. It has also a mission in Canada, embracing about 5000 members.

2. PRIMITIVE METHODISTS, vulgarly designated RANTERS, were formed into a society in 1810, though the founders had separated from the old society some years before. The immediate cause of this separation was a disagreement as to the propriety of camp-meetings for religious purposes; and also upon the question of females being permitted to preach. A third point of difference is the admission to their conference of two lay delegates for every minister. In 1859, their numbers were: members, 123,863; preachers, 610.

3. INDEPENDENT METHODISTS, who separated in 1810. They are chiefly distinguished by their rejection of a paid ministry, and number in England and Scotland: members, 4000; preachers, 290; scholars, 6000.

4. BIBLE CHRISTIANS, also called BRYANITES, were formed by a local preacher named Bryan, who

METHUEN TREATY—METHYL.

seceded from the Wesleyans in 1815. The only distinction between them and the original body appears to be that the former receive the eucharistic elements in a sitting posture. In 1859, their numbers were: members, 21,666; preachers, 169.

5. UNITED FREE CHURCH METHODISTS have been recently formed by the amalgamation of two sects of nearly equal numerical strength. The older of these, called the WESLEYAN ASSOCIATION, originated in 1834 in the removal of one or two influential ministers from the original connection. Points of difference subsequently appeared with regard to the constitution of the conference.—The younger sect, called the WESLEYAN REFORM ASSOCIATION, took its rise in 1849 through the expulsion of several ministers from the parent body on a charge of insubordination, and being founded on the same principles as the last-mentioned community, arrangements were entered into for their union, which was subsequently effected. Church independency, and freedom of representation in the annual assembly, are two of the most prominent distinctive traits in the organisation of the United Methodist Free Church. Their united numbers in 1863 were: members, 63,674; ministers, 224; local preachers, 2921; Sunday scholars, 121,223; Sunday-school teachers, 20,041.

This is perhaps also the most convenient place to notice the WELSH CALVINISTIC METHODISTS. They are not a secession from the followers of Wesley, but originated partly in the preaching of his friend and fellow-evangelist, Whitefield, and partly in that of Howel Harris, a Welsh clergyman of the Church of England. Whitefield was a Calvinist; Wesley, as we have seen, was on some points decidedly Arminian. A difference arose between them on the subject of election. Henceforward their paths lay in different directions. Whitefield, however, did not form a religious sect; and after his death (1769), his followers, being left without any distinct bond or organisation, either followed the leading of the Countess of Huntingdon (q. v.), or became distributed among other denominations, a large portion, especially in Wales, becoming absorbed in the new society gradually forming itself through the preaching of Howel Harris and his coadjutors. This body, however, was not formally constituted a religious society till the beginning of this century. Its government is pretty similar to that of the Wesleyan Methodists. In 1859, its numbers were: members, 58,577; preachers, 207. They support a home mission among their countrymen in England and at the mines in Lanarkshire, and have also a station at Brittany, and two in Bengal.

METHUEN TREATY, a commercial treaty between England and Portugal in 1703, so-called in consequence of being negotiated by Paul Methuen of Corsham, English ambassador at Lisbon. It was agreed, by the treaty, that the wines of Portugal should be received by England at a rate of one-third less duty than those of France. In 1836, the Portuguese government relinquished the stipulations of the treaty.

METHYL is an organic radical homologous with Ethyl (q. v.), being the lowest term in the series $C_2H_5 + n$, n in this case being equal to 2. Its formula is C_2H_5 ; but in its free state, two atoms unite to form a single molecule, so that free methyl is more accurately represented by $(C_2H_5)_2$. It is a colourless gas, of specific gravity 1.036; it burns with a very feeble bluish flame, and is not liquefied at a temperature of 0°. It is obtained by acting upon iodide of methyl with zinc, in the same manner as in the preparation of ethyl.

Like ethyl, it forms a very numerous class of compounds, of which the following are the most

important: *Hydride of Methyl* (C_2H_5, H), known as *Light Carburetted Hydrogen* (q. v.), *Marsh-gas*, and *Fire-damp*, may be obtained either naturally or artificially. As a natural product, it sometimes issues from fissures in coal-seams, rushing forth as if under high pressure. These discharges of this gas are termed 'Blowers' by the miners, and it is by the combustion of this fire-damp that the terrific explosions which occasionally take place in coal-pits are caused. For its combustion, twice its volume of oxygen (and consequently ten times its volume of air) is required; the resulting compounds being one volume of carbonic acid and two of steam. The vitiated air thus produced, which is utterly unfit for respiration, is known as the *after-damp* or *choke-damp*, and is as much dreaded as the explosion itself. Hydride of methyl is also one of the gaseous exhalations from marshes and stagnant pools; and the bubbles that rise to the surface when the mud at the bottom of a pond is stirred up, consist chiefly of this gas. It may be prepared artificially by strongly heating a mixture of crystallised acetate of soda, hydrate of potash, and powdered quicklime. It is a colourless, inodorous, tasteless gas, which may be breathed without apparent injury if well diluted with air. *Hydrated Oxide of Methyl* (C_2H_5, O, HO), known also as *Methylic Alcohol*, *Wood Spirit*, and *Pyroxylic Spirit* (under which title its properties are described), is the strict homologue of vinous or ethylic alcohol (C_2H_5, O, HO). *Oxide of Methyl* (C_2H_5, O), or *Methylic Ether*, corresponds to the ordinary, or, correctly speaking, the ethylic ether, and, like the latter, is produced by the distillation of a mixture of methylic alcohol and sulphuric acid. Oxide of methyl, like oxide of ethyl, combines with acids to form a class of ethereal salts, or compound ethers, as they are termed by some chemists—as, for example: Acetate of Methyl (or methyl-acetic ether), C_2H_5, O, C_2H_3, O_2 ; Butyrate of Methyl (or methyl-butyric ether), C_2H_5, O, C_4H_7, O_2 ; Nitrate of Methyl (or methyl-nitric ether), C_2H_5, O, NO_2 ; Salicylate of Methyl (or methyl-salicylic ether), C_2H_5, O, C_7H_5, O_2 . The last-named compound may not only be obtained by distilling a mixture of pyroxylic spirit with salicylic and sulphuric acids, but occurs ready formed in the vegetable kingdom, constituting the essential oil procured from the *Betula lenta*, a species of birch, and from the *Gaultheria procumbens*, or *Winter Green*.

Methyl may be made to enter into combination with bromine, iodine, chlorine, and fluorine, the bromide and iodide of methyl being colourless fluids, and the chloride and fluoride colourless gases. Amongst the most interesting of the numerous methyl compounds must be mentioned the artificial bases or alkalies, which can be obtained from ammonia by the substitution of one, two, or three equivalents of methyl for one, two, or three of the equivalents of hydrogen contained in the ammonia.

If only one equivalent of hydrogen is replaced by methyl, the resulting compound is $NH_2(C_2H_5)$ or C_2H_5N , an extremely alkaline gas known as *methylamine*, or *methylia*, which is more soluble in water than any other known gas; water at 55° dissolving 1160 times its bulk. It is a frequent product of the destructive distillation of nitrogenous substances; and it is present when many natural alkaloids, such as narcotine and morphia, are distilled with caustic potash. The product resulting from the substitution of two equivalents of methyl for two of hydrogen, and known as *dimethylamine*, closely resembles methylamine. When the three equivalents of hydrogen are replaced by three of methyl, the resulting compound is $N(C_2H_5)_3$, or $C_6H_{15}N$, a colourless gas, which is known as *trimethylamine*, or *trimethylia*, and has a disagreeable

fishy odour. It occurs in large quantity in herring-brine, and has been detected in the spirit in which anatomical preparations have been long kept. It has also been found in *Chenopodium vulvaria* (or Stinking Goose-foot), in the flowers of *Crataegus oxyacantha* (or Common Hawthorn), and in ergot of rye.

METHYLATED SPIRIT consists of a mixture of alcohol, of specific gravity 0.830, with 10 per cent. of Pyroxylic (q. v.) or wood-spirit. This addition of wood-spirit renders it unfit for drinking, although it scarcely interferes with its power as a solvent. It is allowed by the excise to be sold duty-free for manufacturing purposes, and for preserving specimens in museums.

METONIC CYCLE, so called from its inventor, Meton, who flourished at Athens about 432 B. C., is a cycle of 19 years, at the end of which time the new moons fall on the same days of the year, and eclipses recur in nearly the same order. This arises from the circumstance, that 19 solar years are nearly equal to 235 lunations, their average values being 6939.68835 and 6939.60249 days respectively.

METONYMY (Gr. *metonymia*, signifying a change of name) is a figure of speech by which one thing is put for another to which it bears an important relation, as a part for the whole, the effect for the cause, the abstract for the concrete, &c. For example, '*Lying lips* are an abomination to the Lord.' This figure is very expressive, and is much used in proverbial and other pithy modes of speech.

METOPÉ, the space, in the frieze of the Doric order, between the triglyphs—generally ornamented with figures, or bulls' heads, or pateræ.

METRA, an ingenious pocket-instrument, invented by Mr Herbert Mackworth, about 1858. It combines the thermometer, climometer, goniometer, anemometer, level, plummet, scales, &c., so that, by its assistance, travellers or engineers can at once record their observations. It enables us to determine the dip of rocks, angles of crystals, temperature, rate of wind, to take levels of large surfaces, determine latitude, and a variety of other matters connected with physical science. As a pocket-instrument, it is of great value.

METRE (Gr. *measure*) is that regulated succession of certain groups of syllables in which Poetry (q. v.) is usually written. A greater or less number of groups forms a *line* or *verse* (Lat. a turning), and in modern languages, the verses usually rhyme with one another; although this is not at all essential to the notion of metre. See **RHYME**, **BLANK VERSE**. In the classic languages, metre depended upon the way in which long and short syllables were made to succeed one another. English metre depends, not upon the distinction of long and short, but upon that of *accented* and *unaccented* syllables. Thus, in the lines,

The cu'r|few to'lls | the kne'll | of pá'rt|ing dá'y—

Wa'rriors and | chi'e'fs, should the | sha'ft or the | swo'rd—
the accents occur at regular intervals; and the groups of syllables thus formed constitute each a metre, or measure. The groups of long and short syllables composing the metres of classic verse, were called *feet*, each foot having a distinctive name. The same names are sometimes applied to English measures, an accented syllable in English being held to be equivalent to a long syllable in Latin or Greek, and an unaccented syllable to a short.

Every metre in English contains one accented syllable, and either one or two unaccented syllables. As the accent may be on the first, second, or third syllable of the group, there thus arise five distinct

measures, two dissyllabic and three trisyllabic, as seen in the words—1, fo'lly (corresponding to the classic Trochee); 2, reca'll (Iambus); 3, te'rribly (Dactyle); 4, confu'sion (Amphibrachys); 5, absen-tee' (Anapaest).

These measures are arranged in *lines* or *verses*, varying in length in different pieces, and often in the same piece. The ending measure of a line is frequently incomplete, or has a supernumerary syllable; and sometimes one measure is substituted for another. All that is necessary is, that some one measure be so predominant as to give a character to the verse. Constant recurrence of the same measure produces monotony. The following lines exemplify the five measures:

1st Measure.

Ri'ch the | trea'sure.

Be'tter | ai'xty | yea'r's of | Eu'rope | tha'n a | cy'cle | of | Ca'tha'y.

2d Measure.

Al'o'ft | in a w'ful sta'te.

The pro'p'ler stu'd'y of | manki'nd | is ma'n.

3d Measure.

Bi'rd of the | wi'l'derness.

Wa'rriors and | chi'e'fs, should the | sha'ft or the | swo'rd.

4th Measure.

The de'w of | the mo'rn'ing.

O you'ng Loch|inva'r has | come on't of | the we'st.

5th Measure.

As they ro'ar | on the sho're.

The Assy'r|ian came do'wn | like a wo'lf | on the fo'ld.

It is instinctively felt that some of these measures are better suited for particular subjects than others. Thus, the first has a brisk, abrupt, energetic character, agreeing well with lively and gay subjects, and also with the intense feeling of such pieces as *Scotts' wha ha'e*. The second is by far the most usual metre in English poetry; it occurs, in fact, most frequently in the ordinary prose-movement of the language. It is smooth, graceful, and stately; readily adapting itself to easy narrative, and the expression of the gentler feelings, or to the treatment of severe and sublime subjects. The trisyllabic metres, owing to the number of unaccented syllables in them, are rapid in their movement, and calculated to express rushing, bounding, impetuous feelings. They are all less regular than the dissyllabic metres. One of them is frequently substituted for another, as in the opening of Byron's *Bride of Abydos*:

Kn'o'ye the | la'nd where the | cy'press and | my'rle
Are e'mbles | of dee'ds that | are do'ne in | their
cli'me;
Where the ra'ge | of the vu'l'ture, the lo've | of the
tu'r'tle—

where each of the three lines is in a different metre. In addition to this irregularity, one of the unaccented syllables is often wanting. For instance, in Mrs Hemans's poem, *The Voice of Spring*:

I co'me, | I co'me! | ye have call'd | me lo'ng;
I co'me | o'er the mou'n'tains with li'ght | and so'ng—

the first line has only one measure of three syllables, although the general character of the versification is trisyllabic.

In a kind of verse introduced by Coleridge, and used occasionally by Byron and others, the unaccented

MÈTRE—METROPOLIS LOCAL MANAGEMENT ACT.

syllables are altogether left out of account, and the versification is made to depend upon having a regular number of accents in the line:

There i's not wi'nd enou'g to twi'r'l
The o'ne red le'af, the la'st of its cla'n,
That da'nces as o'ften as da'nce it ca'n
On the to'pmost twi'g that looks u'p at the sky'.

Here there are four accents in each line, but the number of syllables varies from eight to eleven.

To scan a line or group of lines, is to divide it into the measures of which it is composed.

The variety of combinations of metres and rhymes that may be formed, is endless; but a few of the more usual forms of English versification have received special names, and these we may briefly notice.

Octosyllabics are verses made up each of four measures of the second kind of metre, and therefore containing eight (*octo*) syllables:

With fru'it|less la'|bour, Cla'|ra bou'nd
And stro've | to sta'nch | the gos'h'ing wo'und.

Scott's poems are mostly in octosyllabics, and so is *Hudibras*, and many other pieces.

Heroic is a term applied to verses containing five metres of the second kind, or ten syllables. Heroics either rhyme in couplets, or are without rhymes, constituting blank verse. Many of the chief narrative and didactic poems in the English language are in rhyming heroics; as those of Chaucer, Dryden, Pope, Cowper, &c. Milton's two great poems, Young's *Night Thoughts*, Thomson's *Seasons*, Cowper's *Task*, Wordsworth's *Excursion*, and many others, are written in blank heroics. Metrical dramas are almost always in blank verse; in which case there is frequently a supernumerary syllable, or even two, at the end of the line:

To be, | or not | to be, | that is | the ques'tion :
Whether | 'tis nobler | in | the mind | to suffer.

In *Elegiacs*, the lines are of the same length and the same measure as in heroics; but the rhymes are alternate, and divide the poem into quatrains or stanzas of four lines, as in Gray's *Elegy*. The Spenserian stanza, popularised by Spenser in the *Fairy Queen*, and much used by Byron, differs from common heroics only in the arrangement of the rhymes, and in concluding with an Alexandrine (q. v.).

Service metre, also called *common metre*, is the form of versification adopted in the metrical Psalms, in many hymns, and other lyrical pieces. From being frequently employed in ballads, this metre is also called *ballad metre*. The first and third lines often rhyme, as well as the second and fourth.

Such are some of the more usual and definite forms of versification. In many poems, especially the more recent ones, so much licence is assumed, that it is difficult to trace any regular recurrence or other law determining the changes of metre, or the lengths of the lines; the poet seeks to suit the modulation at every turn to the varying sentiments. But it may be questioned whether much of this refinement of art is not thrown away, upon ordinary readers at least, who, failing to perceive any special suitableness, are inclined to look upon those violent departures from accustomed regularity as the results of caprice.

The kind of verse called *Hexameter* is described under its own name.

MÈTRE, the basis of the 'metrical' or modern French system of weights and measures, and the unit of length. The first suggestion of a change in the previous system dates as far back as the time of

Philippe le Bel; but up till 1790, no important change had been effected. On the 8th May 1790, proposals were made by the French government to the British, for the meeting of an equal number of members from the Academy of Sciences and the Royal Society of London, to determine the length of the simple pendulum vibrating seconds in lat; 45° at the level of the sea, with the view of making this the unit of a new system of measures. The British government, however, did not give this proposal a favourable reception, and it fell to the ground. The French government, impatient to effect a reform, obtained the appointment by the Academy of Sciences of a commission composed of Borda, Lagrange, Laplace, Monge, and Condorcet, to choose from the following three, the length of the pendulum, of the fourth part of the equator, and of the fourth part of the meridian, the one best fitted for their purpose. The commission decided in favour of the last—resolving that the $\frac{1}{10,000,000}$ th of a quadrant of the meridian (the distance from the equator to the pole, measured as along the surface of still water) be taken for the basis of the new system, and be called a 'mètre.' Delambre and Mechain were immediately charged with the measurement of the meridian between Dunkerque and Barcelona; and the result of their labours was referred to a committee of twenty members, nine of whom were French, the rest having been deputed by the governments of Holland, Savoy, Denmark, Spain, Tuscany, and the Roman, Cisalpine, Ligurian, and Helvetic republics. By this committee, the length of the mètre was found to be 443,296 Parisian lines, or 39,370,7904 English inches; and standards of it and of the kilogramme (see GRAMME) were constructed, and deposited among the archives of France, where they still remain. The 'metrical system' received legal sanction 2d November 1801. The following are the multiples and fractions of the mètre which are in common use, expressed in English measure:

	English Inches.	English Feet.	English Yards.
Millimètre,	0.0393707904		
Centimètre,	393707904		
Decimètre,	3.93707904		
MÈTRE,	39.3707904	= 3.2808993	= 1.093633
Decamètre,	393.707904	= 32.808992	= 10.93633
Hectomètre,	3937.07904	= 328.08992	= 109.3633
Kilomètre,	39370.7904	= 3280.8992	= 1093.633
Myriamètre,	393707.904	= 32808.992	= 10936.33

From the mètre, the other principal units of measure and weight are at once derived. See **ARE**, **LITRE**, **GRAMME**, **FRANC**.

METRONOME, a valuable small machine for indicating the correct time or speed at which a musical composition should be played. It was invented in 1815 by Mälzel, the inventor also of the automaton trumpeter. See **AUTOMATON**. The test of a correct metronome is, that when set at 60 it shall beat seconds.

METRO'POLIS LOCAL MANAGEMENT ACT. The metropolis of the United Kingdom, owing to its immense size, has been regulated for ædile and sanitary purposes chiefly by special acts, one of which is called the Metropolis Local Management Act. It had long been subject to a special Building Act, which laid down minute regulations as to the formation of streets, alteration and building of houses; and the Metropolis Buildings Act still contains a code applicable to building regulations, the chief principle of which is, that no person can build or make alterations till they have been duly approved by the inspectors, whose duty it is to see that certain conditions have been complied with as regards the public safety. In 1855, a great change was made in the internal economy of the metropolis, by the Metropolis Local Management Act, which

created the Metropolitan Board of Works, and provided it with extensive powers of drainage, sewerage, lighting, cleaning, removing nuisances, and general improvements, and with powers also to rate the occupiers of houses for the expenses of the general management. Formerly, each vestry did what it thought proper within its own parish, and there was no uniformity observed in the details of management. But the above act contained a code of laws affecting numerous details of street and city life. One important function was the systematic construction of sewers and the removal of nuisances. No new building is now allowed to be built without sufficient drains and water-closets. Paving is enforced in most cases.

METROPOLITAN, in Church Law, the bishop of a *metropolis*, [or 'mother city,' upon which other episcopal cities are in some sense dependent. The gradations of the hierarchy, on which this dependence is founded, are of very early origin, and may, it is alleged, be traced, at least in germ, in the letters of St Paul to Timothy and to Titus. The commentaries of the Fathers, (as Chrysostom, 15 *Hom. in 1 Tim.*, and Eusebius, *Hist. Eccles.* l. iii. c. iv.) recognise it as of apostolic institution. The jurisdiction of metropolitans, according to the ancient law of the church, was very considerable, and extended over all the bishops of that province of which the metropolitan see was the capital. It was their privilege not only to summon and preside over provincial councils, to consecrate the provincial bishops, but also to decide certain causes, and in other ways to exercise authority within the sees of their suffragans. Recent canons have very much restricted their powers. The metropolitan is distinguished from an ordinary archbishop by his having suffragan bishops subject to him, which is not necessarily the case of an archbishop.

In the united churches of England and Ireland the Archbishops of Canterbury and York in England, and those of Armagh and Dublin in Ireland, are metropolitans. In the newly-constituted hierarchy of the Roman Catholic Church in England, the Archbishop of Westminster has the rank of metropolitan. In the Roman Catholic Church of Ireland, the Archbishops of Armagh, Dublin, Cashel, and Tuam all possess the same rank.

METTERNICH, CLEMENS WENZEL NEPOMUK LOTHAR, Prince von Metternich, and Duke of Pontella, an eminent Austrian diplomatist and statesman, born at Coblenz, 15th May 1773. His father, FRANZ GEORG KARL, Count von Metternich, was also an Austrian diplomatist, and an associate of Kaunitz. He represented a very ancient and distinguished family, whose original seat was in Jülich. Young M. was educated at the university of Strasbourg, and afterwards studied law at Mainz and travelled in England. In 1795, he married the grand-daughter and heiress of the celebrated minister Kaunitz, by whom he acquired large estates. His diplomatic career commenced at the congress of Rastadt, which he attended as representative of the Westphalian counts. His rise was very rapid: he added to the advantages of his birth and connections, a more than ordinary share of diplomatic ability, with the most graceful and winning manners. In 1801, he became Austrian ambassador at Dresden; and on the outbreak of the third coalition war, he negotiated the treaty of alliance between Austria, Prussia, and Russia. In 1806, he went as ambassador to Paris, and concluded, in 1807, the treaty of Fontainebleau, very favourable to the interests of Austria; but on the outbreak of the war between France and Austria in 1809, he was detained some time ere he could obtain his passport. In course

of that year, he succeeded Count Von Stadion as Minister of Foreign Affairs, concluded the treaty of peace with the French minister Champagny, and accompanied the Empress Maria Louisa to Paris. He guided the course of Austria amidst the difficulties of 1812—1813. He maintained at first a temporising policy and a scheme of an armed mediation of Austria; but the obstinacy of Napoleon reduced him to the necessity of adopting at last a decided step, and led him to resolve upon that declaration of war by Austria against France, which took place in August 1813, and he subsequently conducted with great ability the negotiations which ended in the completion of the quadruple alliance. On the eve of the battle of Leipzig, the emperor of Austria bestowed upon him the princely dignity. He was afterwards employed in almost all the chief diplomatic affairs of that eventful time; and after the congress of Chatillon and negotiations with the Count d'Artois, he went to Paris, and signed the convention of Fontainebleau with Napoleon, went to England to negotiate concerning a new quadruple alliance, and attended the congress of Vienna, of which he was unanimously elected president. He signed, as Austrian plenipotentiary, the second peace of Paris 20th November 1815. After this, he continued still to conduct the diplomacy of Austria, and in 1821 was appointed chancellor (*Haus-, Hof- und Staatskanzler*), and in 1826 succeeded Count Zichy in the presidency of ministerial conferences on home affairs. His efforts were now earnestly directed to the maintenance of peace in Europe, and the preservation of the existing state of things in the Austrian dominions by the strictest measures of police and severe despotism. The revolutionary movement of 1848 breaking forth with sudden violence, caused the aged minister to flee from Austria, and to seek refuge in England; nor did he return to Vienna till the end of 1851, when he received great marks of honour and favour from the emperor; but although sometimes consulted, he was never again asked to undertake the cares of office. He died at Vienna, 11th June 1859. The general opinion respecting M. has been well expressed by the *Times* newspaper: 'He was renowned rather than great, clever rather than wise, venerated more for his age than his power, admired but not lamented. His son Richard became ambassador at the Court of Napoleon III., after the peace of Villafranca.'

METTRAY. The Reformatory of M. is the true parent of all institutions intended to reform and restore to society, and not merely to punish, juvenile delinquents. M. Demetz, a member of the Parisian bar, struck with the evils and hardship attending the committal to prison of young, and, considering their training and habits, scarcely responsible criminals, there to languish hopelessly for a time, and then to emerge worse than when they entered, resolved, in conjunction with the Vicomte Breignères de Courteilles, to found a school which should have for its object the reformation of this class of offenders. In 1839, accordingly, the Reformatory, or, as it is called, the Colony of Mettray, was set on foot, about five miles from the city of Tours in France. From that day to this, M. Demetz has, by his assiduous labours and self-devotedness, rendered to France and Europe one of the greatest benefits that could be conferred on society, by proving that, by agricultural and other labours of industry, and well-considered rules of organisation and discipline, the neglected and criminal may be trained to take their place honestly and honourably in society. The children consist wholly of orphans, foundlings, and delinquents; and of 1815 pupils, who, since its foundation, have definitively left the colony, 871

METZ—MEXICO.

became agricultural labourers, 421 workmen, 435 soldiers, and 88 sailors; the relapses into crime being only 3·81 per cent. The success of this establishment is to be attributed not solely to the excellent training and close supervision at M. itself, but to the care which is taken to preserve the link between the authorities and those who have left the colony. The payment made by the state is only 7d. a day for children sent under judicial sentence; the large extra expenditure necessarily incurred being defrayed from charitable contributions from the individuals constituting the 'Paternal Society of Mettray.'

METZ, an important city of France, a fortress of the first rank, and the strongest on the north-eastern frontier, is the capital of the department of Moselle. It is situated on the Moselle at its confluence with the Seille. The rivers, which are crossed by 17 bridges, afford water-power to several mills. It is surrounded by a system of fortifications. The military establishments of the town are numerous and important. There are six barracks; a hospital, said to be the most beautiful in France, and capable of containing 1800 patients; several immense provision-magazines; two military schools, the one for artillery, and the other for engineering; a school for the practice of these arts; two arsenals, and a powder-mill. Its streets are wide and clean, and it contains numerous spacious squares. The cathedral, a Gothic edifice, begun in 1014, and finished in 1546, is remarkable for its boldness, lightness, and elegance, and has a beautiful spire of open work, 373 feet in height. The church of Notre-Dame-de-la-Ronde is a noteworthy structure. Its choir was built in 1130. M. contains also many other noble edifices and institutions, religious, civil, and military. Its industry is active, the chief employments being lace-making, tanning, embroidering, and the manufacture of brushes, clothing for the army, flannels, pins, and canes; there are also brass and copper foundries. Pop. 56,388.

M., known to the Romans by the name of *Divodurum*, was the chief town of a people called the *Meditratici*, whose name it took at a later date. In the 5th c., the corrupted form *Mettis* first came into use, whence the modern Metz. M. was destroyed by the Huns in 452. At the death of Clovis, it became the capital of Austrasia, and later the capital of Lorraine. In 985, it became a free imperial town. It was finally secured to France by the peace of Westphalia in 1648.

MEURTHE, a department in the north-east of France, formed out of the province of Lorraine, extends immediately south of the department of Moselle. Area, 1,505,954 acres, half of which are under tillage, and 40,455 in vineyards; population (1862) 428,643. Its surface is undulating and picturesque; while along the eastern border run the Vosges Mountains, rising in one point to 1148 feet in height. The chief rivers are the Moselle, and its affluents the Meurthe (from which the department derives its name), the Madon, the Seille, &c. This department is no less remarkable for the beauty of its scenery than for the fertility of its soil and the variety of its productions. In average years, 400,000 quarters of wheat and 20,064,000 gallons of wine are produced. The arrondissements are Nancy, Château-Salins, Lunéville, Sarrebourg, and Toul. The capital is Nancy.

MEUSE, a frontier department in the north-east of France. Area, 1,536,107 acres, of which 828,302 are under tillage, and 34,349 in vineyards. Pop. (1862) 306,540. The surface is traversed from south-east to north-west by two parallel ranges of hills,

which form the right and left bank of the river Meuse (see MAAS), and separate it from the basin of the Seine on the west, and from that of the Moselle on the east. The Meuse, the Ornain, and the Aire, are the chief rivers. The soil is generally poor, except in the valleys of the principal rivers, which are remarkably fertile and well cultivated. The usual crops are raised in average quantities. 22,000,000 gallons of wine (red and white) are made annually. The four arrondissements are Bar-le-Duc, Commercy, Montmédy, and Verdun. The capital is Bar-le-Duc.

MEXICO constitutes the south-west extremity of North America, and occupies a portion of the isthmus which connects the latter with the south part of the American continent. It is bounded on the N. by the territories of the United States, on the W. by the Pacific Ocean, on the S. by the Pacific and Central America, and on the E. by the Gulf of Mexico. The area of M. is about 850,000 square miles, and the population (according to the somewhat untrustworthy data of the census of 1857), 8,137,853. The following table gives the names of the provinces (with their several areas and populations) into which the republic of M. is divided, in accordance with the constitution of 1857:

Provinces.	Sup. Area in Square Miles.	Pop. in 1857.	Chief Towns.
Agua Calientes,*		86,329	
Chiapa.	19,026·80	167,473	San Christobal, 6000
Chihuahua.	102,645·90	164,073	Chihuahua, . 14,000
Colima.	3,305·40	62,109	Colima, . 31,000
Durango.	49,390·50	144,331	Durango, . 22,000
Guanajuato.	12,419·40	729,103	Guanajuato, 48,000
Guerrero.	29,123·89	570,000	Tixtla, . 4,000
Jalisco.	60,122·10	804,058	Guadalajara, 63,000
Mexico.	15,865·50	1,029,629	Toluca, . 12,000
Michoacan.	26,173·30	534,585	Morelia, . 25,000
Nuevo Leon and Coahuila.	81,015·90	213,369	Monterrey, 13,000 Saltillo, . 19,000
Oajaca.	33,123·30	525,938	Oajaca, . 25,000
Puebla.	14,017·80	658,609	Puebla, . 71,000
Queretaro.	2,431·80	165,156	Queretaro, . 29,000
San L. Potosi.	31,905·30	397,189	San Louis, 40,000
Sinaloa.	34,049·40	160,060	Culiacan, . 12,000
Sonora.	131,117·70	139,374	Ures, . 7,000
Tabasco.	16,853·50	70,628	S. Juan B., . 4,000
Tamaulipas.	30,334·90	109,673	Victoria, . 5,000
Tlaxcala.	1,833·30	90,158	Tlaxcala, . 3,000
Vera Cruz.	25,536·00	349,125	Vera Cruz, . 8,000
Yucatan.	45,822·00	668,623	Merida, . 40,000
Zacatecas.	31,915·80	226,789	Zacatecas, 25,000
District of } Mexico, }	100·80	269,534	Mexico (1858), 200,000
California.	58,364·20	12,000	La Paz, . 5,000

Physical Character, &c.—The great mass of the Mexican territory consists of an elevated plateau, formed by an expansion of the Cordilleras of Central America (q. v.), from which terraced slopes descend with a more or less rapid inclination towards the Atlantic on the east, and the Pacific on the west. This vast tract, which extends from 18° to 32° N. lat., and from 95° to 115° W. long., comprises one of the richest and most varied zones in the world; for while its geographical position secures to it a tropical vegetation, the rapid differences of elevation which characterise it, afford it the advantages of temperate climates, in which all the varieties of our European flora and fauna can come to perfection; and it thus combines within its limits an almost unparalleled exuberance and multiplicity of natural products. The table-lands of M. lie at elevations varying from 5000 to more than 9000 feet above the level of the sea, and exhibit great differences of

* The province of Agua Calientes belonged till 1858 to the province of Zacatecas, and its area and population are given together with those of that province.

level and varieties of soil. They generally incline northward, and are for the most part girt in by low mountain chains, among which rise individual lofty peaks, as Coffre de Perote (13,400 feet), Orizava (17,370 feet), and others; while they are intersected by higher ranges, above which tower a few cones, as Istacciuatl, the White Woman (15,700 feet), and the volcano of Popocatepetl, or the Smoking Mountain (17,880 feet). These volcanoes and several others of less note, lying within the parallels of 18° 15' and 19° 30' N. lat., form a transverse volcanic band between the two oceans, and do not follow the inclination of the central chain, as is the case in the volcanoes of South America. Volcanoes also occur isolated, as, for instance, in the plain of Mixtecapan, 2900 feet above the sea, where, in 1759, the volcano of Jorullo, which still emits smoke, was formed after an eruption by which a surface of many square miles was raised several feet above the level of the plain; in fact, every part of the Mexican territory betrays the volcanic nature of its formation, although neither earthquakes nor any other active phenomena have of late been of frequent occurrence. The principal chain, intersecting the table-land, is the Sierra Madre, or Tepe Suena, in which lie the chief gold and silver mines, and which, after traversing the states of Queretaro and Guanajuato, divides into three main branches, the central of which forms the water-shed between the Pacific Ocean and the Gulf of Mexico. In addition to these great chains, the Mexican territory is intersected by numerous lesser ranges, which on the Pacific side break up the terraced declivities into innumerable deeply-cleft valleys, which assume almost the character of steep ravines near their junction with the narrow littoral plains of the Pacific Ocean. Violent storms rage on this coast, blowing from the south-west during the hot months, when the climate is as prejudicial to whites as on the Mexican Gulf, although it is not visited by the yellow fever. M. may be said to be generally deficient in navigable rivers; for although some of the largest have a course of more than 1000 miles, few are free from rapids. The Rio Santiago, or Rio Grande, with a course of 500 miles, is broken near Guadalajara by 60 falls in the space of less than three miles; the Rio Grande del Norte, which forms in its lower courses the boundary between M. and the United States, has a winding course of nearly 1800 miles, but it is only navigable for small sailing-vessels to Matamoras, 60 miles from its mouth, where a bar and numerous shoals prevent the passage of large vessels. A similar remark applies to the majority of the rivers which fall into the Gulf of Mexico. The eastern coast generally presents great obstacles to navigation, as it is low and sandy, unbroken by bays or inlets, and lined by sandbanks several miles in width; the only points of access being the mouths of rivers, which are not good roadsteads, as, with few exceptions, the rivers have little water, except at the rainy season, which generally sets in about June, accompanied by overpowering heat, during the prevalence of which the yellow fever, or *vomito prieto*, rages like a pest in all the low lands. M. is on the whole badly supplied with water; and since the Spaniards have discontinued the system of irrigation, which was followed by the Aztec races with so much success, many tracts have become barren, and unsuited for the purposes of human occupation. A great portion of the table-lands can only be used for pasture. Springs are rare, and many of the rivers flow in deep mountain-beds, without receiving smaller tributaries, while the rapid evaporation on a light soil, covering porous rocks, leaves the surface dry and hot, and unable to support any

vegetation beyond the cactus and some low grasses. The plains, moreover, contain the beds of numerous dry salt lakes, but this is chiefly the case on the north and east of the table-land. The western parts of the plateaux between 100° and 102° W. long. (known as the Baxio) yield, by careful irrigation, rich crops of maize and wheat, and rank among the most fertile agricultural districts of Mexico. They are, however, here and there interrupted by sterile tracts, either covered by stones, and then known as 'pedregal,' or with lava, when they are characterised as a *mal pais* (bad country). In contrast with these unprofitable districts, the plains are occasionally broken by depressions of the soil, known as *Barrancas*, descending sometimes 1000 feet, and measuring several miles across, which are covered with a luxuriant vegetation of trees and shrubs, and watered by small streams running through the middle of the valley. M. has numerous lakes, but few of any importance; that of Chapala in Jalisco is one of the most considerable, being more than 90 miles long.

Climate, Products.—The differences of climate, depending upon the different degrees of altitude, are so great in M., that the vegetable products of this vast country include almost all that are to be found between the equator and the polar circle. In the course of a few hours, the traveller may experience every gradation of climate, embracing torrid heat and glacial cold, and pass through different zones of vegetation, including wheat and the sugar-cane, the ash and the palm, apples, olives, and guavas. The Spaniards, on their first occupation of M., distinguished its great climatic divisions under the characteristic names, which are still retained, of the *Tierras Calientes* (hot or littoral lands), *Tierras Templadas* (temperate lands), and *Tierras Frias* (cold or high lands). The mean annual heat of the *Tierras Calientes* is 77°; and the soil, which is generally fertile, produces maize, rice where water can be procured for irrigation, bananas, pine-apples, oranges, manioc; and sarsaparilla, jalap, and vanilla in the littoral swampy forests. This tract has only two seasons—the winter, or season of north winds, and the summer, or season of breezes. In the former, the hurricanes are the terror of navigators, but the coast is clear of yellow fever, which prevails in the hot season. On the medium elevations of the *Tierras Templadas*, the temperature is extremely equable, varying only from about 70° to 80° F.; the climate healthy, and wherever water is abundant, a perpetual summer reigns, yielding a varied and active vegetation, which embraces all the cereals, fruits, and vegetables of Central and Southern Europe, amongst which maize, oranges, lemons, grapes, and olives are produced in the most exuberant abundance. The *Tierras Frias*, which would scarcely have been characterised as cold by discoverers belonging to a less southern climate than Spain, possess a generally temperate climate, the mean annual heat ranging between 66° and 68° F.; but on the highest of the table-lands, the air is keener, and the soil more arid, and agriculture is limited to the cultivation of barley and of the agave, or Mexican aloe, which held the place of the vine among the ancient Aztecs, and is still extensively cultivated for the sake of its juice, which is made into the fermented drink known under the name of *pulque*. In addition to the vegetable products already referred to, M. yields coffee, tobacco—whose growth is, however, limited by governmental restrictions—yams, capsicums, pepper, pimento, indigo, ipecacuanha, dragon's-blood, copaiva, fan-palms, india-rubber trees, mahogany, rosewood, ebony, &c.

The products of the mines, which rank among the richest in the world, include the precious metals.

The gold-mines of M. occur principally on the west side of the Sierra Madre, north of 24° N. lat., and, until the discovery of the metal in Australia, their yield surpassed the produce of any other part of the world. Silver mines abound in M., and the argentiferous veins, which may be said to intersect every part of the western declivities of the Andes, occur in some places, as in the *Vela Madre* lode at Guanajuato, in beds varying from 10 to 50 yards in depth; the precious metal being in these cases intermixed with sulphur compounds, antimony, and arsenic. But although these mines possess the additional special advantage of being situated in fertile districts, affording abundant food to miners and their cattle, their working has been very imperfectly carried on, owing to the unsettled state of the country. At the close of the last, and the beginning of the present century, the annual value of the gold and silver of M. was upwards of £6,000,000, of which $\frac{1}{10}$ ths were yielded by the silver; but the political disturbances, preceding and consequent on the wars of independence, have very considerably reduced this sum, which has probably never been reached since M. was finally separated from the mother-country. In addition to gold and silver, M. yields tin, antimony, mercury, copper, lead, iron, and zinc; while carbonate of soda, used in smelting silver, is found crystallised on the surface of several lakes, and occurs, together with common salt, in dry seasons, on the more arid parts of the surface of the elevated table-lands.

Cattle, horses, asses, mules, and sheep abound in M., where, in consequence of the extent and excellence of the pasture-grounds, all the domestic animals introduced from the Old World have multiplied excessively. Buffaloes feed in the lower plains; goats and sheep are plentiful; the tapir, wolf, American lynx, jaguar, wild-cat, several species of the skunk, the brown porcupine, stag, deer, &c., are to be found. Parrots, humming-birds, and wild game birds, including turkeys, are abundant; and almost all the lakes yield large quantities of fish. The cochineal insect and the silk-worm are reared with great success on the table-land of Mixtecapan.

Commerce, &c.—Notwithstanding the enormous advantages presented by her natural productions, and the important geographical position which she occupies between the Atlantic and the Pacific, M., owing to her unsettled government, and the consequent insecurity of life and property, has shewn a retrograde movement in regard to commerce since the establishment of her independence; and the annual value of her trade is now estimated at only about six or seven millions sterling, the imports amounting to about $\frac{1}{10}$ ths, and the exports to $\frac{1}{10}$ ths of that sum. The precious metals constitute, it is estimated, nearly $\frac{1}{10}$ ths of the exports, the remainder being made up by productions of the soil, and industrial products, such as cotton, woollen, and silk goods, soap, leather, saddlery, gold and silver lace, cigars, brandy, &c. England, France, Hamburg, and Lübeck, and the United States of America, are the principal powers with which M. maintains relations of foreign commerce, while the city of Mexico is the chief focus of internal trade, and Vera Cruz the principal port for maritime commerce. For the number of ships entering and clearing the ports of M., see **VERA CRUZ and TAMPICO**. The financial condition of M. has been allowed to fall into such disorder, since the establishment of independence, that the expenditure has been continually increasing beyond the receipts; but as no details of the department of finance have been published since 1856, and those made known before that period were not trustworthy, it is impossible to give thoroughly reliable figures. According to the printed estimates,

the receipts in 1856 were 8,500,000 piastres; the expenditure, 13,126,239 piastres; deficit, 4,626,239 piastres. But according to the authorities cited by M. Chevalier in his recent work, *Le Mexique, Ancien et Moderne* (Paris, 1863), the receipts amounted to as much as 16 million piastres, while the expenditure exceeded that sum by $\frac{1}{4}$ million piastres, half the receipts being absorbed by the budget for the war expenses. The national debt is reported to have amounted in 1858 to 145 million piastres.

Army, Navy, &c.—In accordance with the old constitution of M., the standing army was to consist of 26,000 men, with a reserve of 65,000 men; but this number, which had fallen to nearly half the required force in 1855, has been so extensively reduced since that period by continual civil wars, that, according to Spanish authorities, the government of President Juarez, on the breaking out of hostilities with the French in 1862, was unable to bring into the field more than 5000 infantry, 800 cavalry, and 9500 of the national guard. The navy consisted of only some 300 men, while the fleet numbered only 9 small ships-of-war, carrying in all between 30 and 40 cannon. Education in M. is in the lowest possible condition, even among the wealthier classes, although the various military dictators who have wielded supreme power have all in turn drawn up elaborate schemes for the general instruction of the people. There is a university in the city of Mexico, but its management, like that of every other public institution, is in a disorganised state, and in the hands of the clergy.

Religion, &c.—The Roman Catholic is the dominant church of M., to the almost entire practical exclusion of any other. M. has 1 archbishop and 11 bishops. The administration of justice is inefficient, the courts venal, and all the subordinate officers of the law corrupt. Brigandage and smuggling endanger personal security, and seriously damage the resources of the nation.

The supreme power of the state was, in 1858, vested in the hands of Benito Juarez, who was to bear the title of Constitutional President, and administer public affairs in conjunction with a legislative congress, composed of a chamber of senators and a lower house of representatives. Each province was to elect two senators and one deputy to every 40,000 inhabitants, and was, moreover, to have a separate provincial legislative chamber, presided over by its governor. At present (from causes set forth in the historical portion of this article) there are two governments in M., that of President Juarez, whose seat is (1863) at San Luis Potosi, and that of the Provisional Regency of the Mexican Empire, whose seat is at Mexico. The latter was appointed by the *Junta Superior del Gobierno*; which was itself constituted (16th June 1863) by a decree of Marshal Forey, leader of the French army of invasion. It is composed of 35 members. This Junta at the same time established, under French influence, an *Assembly of Notables*, whom it charged with deciding in the name of the people what form of government M. should adopt. On the 10th of July 1863, this body, by an overwhelming majority, decided in favour of a constitutional hereditary monarchy, and that the new ruler should bear the title of Emperor of Mexico. According to popular report, the person selected for this new dignity is the Archduke Maximilian of Austria, brother of the emperor of Austria, and son-in-law of King Leopold of Belgium.

History of Mexico.—The history of ancient M. exhibits two distinct and widely-differing periods, the former of which, that of the Toltecs, appears to have begun in the 7th, and ended with the 12th c.; while the second, that of the Aztecs, began

in the year 1200, and may be said to have been closed by the conquest of Cortes in 1519; for although the race has maintained occupation of the Mexican territory, its existence as a nation ceased with the Spanish domination. The origin and primitive seats of the Toltecs are shrouded in mystery; and all that we learn of this people is, that they came from the north, from some undefined locality, which they designated Tullan, and from whence they brought to the valley of Mexico the first elements of civilisation. Their laws and usages stamp them as a people of mild and peaceful instincts, industrious, active, and enterprising. They cultivated the land, introduced maize and cotton, made roads, erected monuments of colossal dimensions, and built temples and cities, whose ruins in various parts of New Spain still attest their skill in architecture, and sufficiently explain why the name Toltec should have passed into a synonym for architect. They knew how to fuse metals, cut and polish the hardest stones, fabricate earthenware, and weave various fabrics: they employed hieroglyphics for the record of events, were acquainted with the causes of eclipses, constructed sun-dials, devised a simple system of notation, and measured time by a solar year, composed of 18 months of 20 days each, adding 5 complementary days to make up the 365, and intercalating $12\frac{1}{4}$ days at the expiration of every 52 years, which brought them within an almost inappreciable fraction to the length of the tropical year, as established by the most accurate observations. These and other arts, with a mild form of religion, and a simple but just mode of administering the laws, the Toltecs bequeathed to the Aztecs, who engrafted upon the civilisation of their predecessors many fierce and sanguinary practices in their religious, and many puerile usages in their social life. Nothing is known of the exact time, and still less of the manner and causes of the departure of the Toltecs from M.; but it has been conjectured that they went towards the south, and that the colossal architectural remains of the cities of Palenque, Uxmal, and Mitla, in Central America, are the work of their hands. The Aztecs, as we have said, imparted to the institutions of the Toltecs a tinge of their own sombre cruelty, and produced an anomalous form of civilisation, which astonished the Spaniards by its mingled character of mildness and ferocity. Like the Toltecs and the Chichmecs, a rude tribe who had succeeded them, the Aztecs came from the north, and after wandering from place to place, founded in 1325 the city of Tenochtitlan, or Mexico. On the arrival of the Spaniards, their empire was found to extend from ocean to ocean, stretching on the Atlantic from 18° to 21° N. lat., and on the Pacific from 14° to 19° N. lat. Their government was an elective empire, the sovereign being selected from the brothers of the deceased prince, or, in default of them, from his nephews. Their laws were severe, but justice was administered in open courts, the proceedings of which were perpetuated by means of picture-written records.

The Aztecs believed in one supreme invisible creator of all things, the ruler of the universe, named Taotl—a belief, it is conjectured, not native to them, but derived from their predecessors, the Toltecs. Under this supreme being stood 13 chief and 200 inferior divinities, each of whom had his sacred day and festival. At their head was the patron god of the Aztecs, the frightful Huitzilopochtli, the Mexican *Mara*. His temples were the most splendid and imposing; in every city of the empire his altars were drenched with the blood of human sacrifice. Cortes and his companions (see DIAZ) were permitted by Montezuma to

enter that in the city of Mexico, and to behold the god himself. 'He had a broad face, wide mouth, and terrible eyes. He was covered with gold, pearls, and precious stones; and was girt about with golden serpents. . . . On his neck, a fitting ornament were the faces of men wrought in silver, and their hearts in gold. Close by were braziers with incense, and on the braziers three real hearts of men who had that day been sacrificed' (Hulse's *Spanish Conquest in America*, vol. II, book x., chap. 4). The smell of the place, we are told, was like that of a slaughter-house. To supply victims for these sacrifices, the emperors made war on all the neighbouring and subsidiary states, or in case of revolt in any city of their dominions, and levied a certain number of men, women, and children by way of indemnity. The victims were borne in triumphal processions and to the sound of music, to the summit of the great temple, where the priests, in sight of assembled crowds, bound them to the sacrificial stone, and opening the breast, tore from it the bleeding heart, which was either laid before the image of their gods, or eaten by the worshippers, after having been carefully cut up and mixed with maize. In the years immediately preceding the Spanish conquest, not less than 20,000 victims were annually immolated. These atrocities were inconspicuously blended with milder forms of worship, in which fruits, flowers, and perfumes were offered up amid joyous outbursts of song and dance. According to their mythology, Taotl, who delighted in these purer sacrifices, had once reigned in Anahuac (a name which at first probably applied only to the country in the immediate vicinity of the capital, though afterwards it was applied to the whole Aztec empire) in the golden age of the world, but being obliged, from some unexplained cause, to retire from earth, he departed by way of the Mexican Gulf, promising to return. This tradition accelerated the success of the Spaniards, whose light skins and long dark hair and beards were regarded as evidences of their affinity with the long-looked-for divinity. The Mexican priesthood formed a rich and powerful order of the state, and were so numerous that Cortes found as many as 5000 attached to the great temple of Mexico. The education of the young of both sexes remained till the age of puberty in the hands of the priests and priestesses; and the sacerdotal class were thus able to exercise a widely-diffused influence, which, under the later rulers, was almost equal to that of the emperor himself. The women shared in all the occupations of the men, and were taught, like them, the arts of reading, writing, ciphering, singing in chorus, dancing, &c., and even initiated in the secrets of astronomy and astrology.

On the arrival of Cortes, in 1519, the Aztec throne was occupied by Montezuma, an energetic prince, who, after his election to the throne, which for several generations had been occupied by his ancestors, made successful war on the powerful and highly-civilised neighbouring state of Tlascalala, and on Nicaragua and Honduras; after a time, however, he grew indolent, and alienated the affections of his subjects by his arrogance and exactions, and by his unremitting devotion to the services of the temples. According to the oracles which he frequently consulted, great changes were impending over the empire, the return of Quetzalcoatl was near at hand, and the fall of his race was impending. The tidings of the arrival on the coast of the expedition of Grigalva in 1518 terrified Montezuma and his priestly councillors; and when the hieroglyphic reports of his provincial officers announced the landing in the following year of Cortes and his companions, he endeavoured to propitiate the dreaded strangers by sending an embassy charged with

MEXICO.

valuable gifts to meet them. The road to success was thus open to the Spanish captain, who, with a handful of men, advanced from St Juan de Ulloa to M., and gradually subdued the entire empire of the Aztecs, whose power crumbled to dust before the greater energy and superior civilisation of their Christian invaders. In 1540, M. was united with other American territories under the name of New Spain, and governed by viceroys appointed by the mother-country. The intolerant spirit of the Catholic clergy led to the suppression of almost every trace of the ancient Aztec nationality and civilisation, while the strict system of sequestration enforced in M. crippled the resources of the colony; yet notwithstanding these drawbacks, M. ranked first among all the Spanish colonies in regard to population, material riches, and natural products. It may be said to have vegetated for nearly three centuries in a state of semi-quiet prosperity, interrupted by few disturbances of any kind until the year 1810, when the discontent, which had been gaining ground against the vice-regal power during the war of the mother-country with Napoleon, broke into open rebellion under the leadership of a country priest named Hidalgo. The defeat and subsequent execution of the latter in 1811 put a partial stop to the insurrection; but the atrocities committed under the sanction of the new viceroy, Calleja, exasperated the people, and gave an irresistible impulse to the revolutionary cause. Guerrero and Iturbide in turn gained signal advantages over the Spaniards. For a time, Iturbide maintained a self-established imperial rule over the colony; but on the downfall consequent on his tyrannical abuse of power, a constitutional mode of government was inaugurated, and in 1824 the independence of M., which had chosen a federal republican form of government, was finally established, and in the following year definitely recognised by every foreign power, except Spain. The Mexican war was stained with excesses and atrocities on both sides; but it must be confessed that the Spaniards gained an unenviable pre-eminence in regard to the wanton cruelty which characterised their method of conducting hostilities. With them the war was one of extermination, every commander being allowed, at his own discretion, to hunt down and slaughter the insurgents like brutes. The welfare of the new republic was unhappily disturbed by constant outbreaks of civil war under the leadership of the Escoscos, or aristocratic faction, and the Yorkinos, or democrats; and the history of the quarter of a century during which M. has exercised independent power, leaves little to recount beyond ever-recurring acts of violence, and the rapid and summary deposition of one president after another. In 1836, Texas secured its independence of the Mexican republic, for which it had struggled for several years, and at the same period differences arose with France, which were, however, brought to a peaceful conclusion after the taking of Vera Cruz in 1838 by the French troops. In 1841, General Santa Anna, on the retirement of Bustamente, succeeded in regaining the direction of affairs, from which he had been more than once deposed, and under the title of Dictator, exercised the power of an autocratic ruler. In 1845, M. was compelled to recognise the independence of Texas, which was incorporated with the United States, whose troops having entered the Mexican territory, provoked a declaration of war on the part of the Mexican government. Hostilities were carried on with great energy by both parties until 1848, when peace was finally concluded, after several bloody engagements had been fought without any definite result on either side; and the city of Mexico had been stormed and taken by the Ameri-

cans under General Scott. In 1852, after Santa Anna and Herrera had been in turn deposed and recalled to power, a revolutionary movement of more than ordinary importance brought General Cevallos for a time to the head of affairs; but, when the insubordination and arrogance of the soldiery threatened universal anarchy, Santa Anna was again recalled, 17th March 1853. Having reorganised the army, and suppressed by the most cruel severity the insurrection of the federals, he declared himself President for life, and thus again rekindled civil war. In 1855, he had to flee from the country. Since then, utter confusion has prevailed. Santa Anna was succeeded by General Alvarez, who held office for about two months, after whom came General Comonfort, who was forced to resign in 1858; when a General Zuñiga assumed supreme power, but was almost immediately deposed by a General Robles. This person also proving a futility, Benito Juarez was elected; but his claims were contested by General Miramon—the head of the priestly and Conservative party—and the country was plunged in civil war. The acts of wanton aggression and flagrant injustice perpetrated on foreigners in M. during this period of internal disorder, during which the Cortes passed an act suspending all payments to foreigners for two years, could not fail to draw upon the Mexican government the serious remonstrance of those European powers whose subjects had just cause of complaint; and the result was to bring a fleet of English, French, and Spanish ships into the Mexican Gulf for the purpose of enforcing satisfaction. In December 1861, the British minister left M., and the Spaniards disembarked a force at Vera Cruz, and took possession of the fort of St Juan d'Ulloa, a step which was soon followed by the arrival before the former city of the allied fleet. A proclamation, signed by the commanders-in-chief of the three naval divisions, and addressed by them to the Mexican people, elicited no satisfactory reply; and steps were accordingly taken to advance at once upon the capital. This measure alarmed the provisional government of M., and brought about an armistice, with a view of negotiating a treaty for the future regulation of commercial intercourse between M. and the great European powers. This treaty was drawn up and provisionally ratified by the different commanders, but not confirmed on the part of France, and consequently the French troops retained occupation of the Mexican territory after the English and Spaniards had declined to join in further hostile demonstrations. In April 1862, the French emperor formally declared war against the government of Juarez, who had assumed arbitrary rule as president of the republic. The French, who have already spent £3,000,000 on the Mexican expedition, have not met with the sympathy and welcome from the people at large which the assumed unpopularity of Juarez had led them to anticipate; and, although the taking of Puebla and other decided successes have given them a firmer footing in the country, it is evident that whatever grievances the Mexican nation may have against their government, they entertain a deeply-rooted hatred against foreigners, and are certainly not at present prepared to welcome with cordial unanimity the thorough reorganisation of their political system, which the European powers, with France at their head, are initiating for the country.—Comp. *Le Mexique, Ancien et Moderne*, par Michel Chevalier (Hachette, 1863).

MEXICO (CITY). Mexico, or Mejico, the capital of the republic, is situated in 19° 20' N. lat., and 99° 5' W. long., at an elevation of nearly 7500 feet above the level of the sea, in the valley of

Tenochtitlan, 2½ miles west of Lake Tezcuco. The pop. was, in 1858, 200,500. This beautiful city, which is built on the site of the ancient Tenochtitlan of the Aztec empire, is situated on an extensive plateau, having an area of more than 1700 square miles, surrounded by lofty mountains, and including five lakes within its area. The principal streets, which all converge towards the great square of Mexico, are regularly and well laid-out, broad, clean, and well-paved and lighted; but the buildings, both private and public, are low, and of a light style of architecture, in consequence of water being found in many parts of the city at only a few feet below the surface, and partly from apprehension of earthquakes. The Plaza Mayor, one of the finest squares of the western world, contains the cathedral, a spacious and imposing building, erected on the ruins of the great *teocalli*, or temple of the Aztec god Mixitli, and adorned with the *tellenda*, a circular stone, covered with hieroglyphics, by which the Aztecs used to represent the months of the year. The palace of the Cortes, in the same square, consists of various buildings appropriated to offices of state, government schools, and public institutions of various kinds, but like everything else in Mexico, has been suffered gradually to fall to decay since the evacuation of the Spaniards. Mexico contains fourteen churches, nearly fifty monasteries and convents, and numerous charitable institutions; the fine hospital has been converted into a barrack; and the university and academy of fine arts, both of which contain valuable collections of Aztec antiquities, are gradually being diverted from their original purpose. There is a theatre, and a circus for bull-fights; and in addition to the ordinary *alameda* or public walk of a Spanish city, Mexico is remarkable for the extent and beauty of its *paseos*, or raised paved roads, planted with double rows of trees, which diverge far into the country from every quarter of the city. Mexico still boasts a few of the water-gardens for which the ancient city was so celebrated, and although no longer floating, as in the days of the Aztecs, they form attractive objects in the midst of the surrounding swamps, which, by the negligence of the Mexicans, have been suffered to increase in the vicinity of the lakes. The trade of Mexico is chiefly a transit-trade, although it has a few manufactures, as cigars of superior quality, gold-lace, hats, carriages, saddlery, &c.; and these articles, together with gold and silver, and some of the numerous valuable natural products of the Mexican plain, it transports, chiefly by means of mules, to Vera Cruz and other ports, importing in return the manufactured goods of Europe and various colonial products.

MEXICO, GULF OF, a basin of the Atlantic Ocean, the estimated extent of which is 800,000 English square miles, is closed in by the United States on the north, by Mexico on the west and south, and its outlet on the east is narrowed by the jutting peninsulas of Yucatan and Florida, which approach within 500 miles of each other. Right in the middle of this entrance is planted the island of Cuba, dividing the strait into two—the Strait of Florida, 120 miles wide, between Cuba and Florida, and the Strait of Yucatan, 105 miles wide, between Cuba and Yucatan. The former or northern entrance connects the gulf with the Atlantic Ocean; the latter or southern, with the Caribbean Sea. The depth of water is supposed nowhere to exceed three-fourths of a mile, yet the gulf contains few islands—the Florida Keys, the deltas of the Mississippi, and a few on the coast of Yucatan, being the most important of them. The shores, which are very sinuous, form numerous bays, the largest of which is the Bay of Campeachy

(q. v.). The coasts are mostly low and sandy or marshy, and are lined with numerous lagoons; good harbours are consequently not numerous, the best being those of Vera Cruz, New Orleans, Pensacola, and Havana. The gulf is visited by violent northern gales called *nortes*, which prevail from September to March, when they attain their maximum force, and then immediately terminate. The most remarkable feature in connection with the Gulf of M. is the *Gulf Stream* (q. v.), which enters it by the southern channel, passes round it, and emerges through the Strait of Florida. Owing partly to the presence of this heated current, the temperature of the gulf is 8° or 9° higher than that of the Atlantic in the same latitude.

MEYERBEER, JAKOB, commonly called GIACOMO MEYERBEER, a celebrated musical composer of the present day, was the son of a wealthy Jewish banker, and was born at Berlin, September 5, 1794. He was a precocious child, playing tunes on the piano spontaneously (it is said) as early as his fifth year. He began to study dramatic composition under Bernhard Anselm Weber; and in 1810 entered the school of Vogler at Darmstadt, where he formed an intimate friendship with the renowned Karl Maria von Weber. While at Darmstadt, he wrote a cantata, *Gott und die Natur*. Subsequently, he composed an opera, *Jephtah*, produced at Munich in 1812; but though warmly admired by his friends, Vogler, Weber, and others, it fell flat on the audience, and was considered a failure. He now proceeded to Vienna, where he acquired a brilliant reputation as a pianist; but another opera which he produced here by command of the court, *Die beiden Khalifen*, was no more successful than the previous one. Italian music was the rage at the time, and nobody had a chance who did not imitate Rossini. M. was induced by his friend Salieri to visit Italy, where he became an enthusiastic convert to the new Italian school, and began the composition of a series of operas which proved highly popular. We may mention his *Romilda e Constanza* (performed at Padua in 1819), *Semiramide* (Turin, 1819), *Emma di Resburgo* (Venice, 1820), the first of M.'s compositions that excited a furor; *Margherita d'Anjou* (1822), *Esule di Grenada* (1823), and *Crociato* (Venice, 1825). The last of these afforded, perhaps, the most decisive proofs of the high genius of its author, and was received with great applause in Paris, whither M. now proceeded, and took up his residence. In 1831, was produced, after numerous rehearsals, his *Robert le Diable*, which caused an excitement 'perhaps unparalleled in the history of the Parisian stage;' while it was received with nearly as great enthusiasm in England, Italy, Austria, and Russia; and in 1836, *Les Huguenots*, in which he reached the climax of his fame. His next opera, *Le Prophète*, did not appear till 1849, but it fairly sustained the author's reputation. Since then, M.'s principal productions have been *Pierre le Grand* (1854) and *Dinorah* (1858). Died 1864.

MEZEN, or MEZENE, a district town in the government of Archangel, European Russia, 50 miles from the mouth of the river of the same name, remarkable for the salmon and herring fisheries which supply St Petersburg with frozen fish during winter.

MEZEN, or MEZENE, a river in the north of European Russia, rises in the north of the government of Vologda, and flows north-west into the White Sea, having a course of about 450 miles.

MEZÖ-TUR, a town of Hungary, on the Berettyo, an affluent of the Körös, 60 miles south-west of Debreczen. Pottery is made, and there is an important market. Pop. 15,680.

MEZZANINE, a low story introduced between two higher ones, or occupying a part of the height of a portion of a high story. The term is also applied to the small windows used to light such apartments.

MEZZOFANTI, GIUSEPPE CARDINAL, a remarkable linguist, was born, 17th September 1774, at Bologna, where he received his education, and subsequently (1815) received the office of university librarian. In 1831, he settled in Rome, and was advanced to the dignity of a Monsignore; in 1833, he was appointed secretary of the College of the Propaganda; then keeper of the Vatican Library; and in 1838, he was raised to the dignity of cardinal. He died, 15th March 1849, at Rome. M.'s European reputation was founded, not on any literary or learned works that he wrote, but on the almost miraculous extent of his linguistic acquisitions. Towards the end of his life, he understood and spoke fifty-eight different tongues. As early, indeed, as 1820, Lord Byron called him 'a walking polyglott, a monster of languages, and a Briareus of parts of speech.' He was not in the strict sense a critical or scientific scholar; yet, although his linguistic skill lay chiefly in verbal knowledge, his acquirements in other departments were by no means inconsiderable. See Russell's *Life of Cardinal Mezzofanti* (Lond. 1858).

MEZZOTINTO. See ENGRAVING.

MIAGAO, a town in the island of Panay, one of the Philippine Isles, in the province of Iloilo. The inhabitants, who are industrious, comfortable, and well educated, are estimated at 31,000 in number.

MIAKO, one of the great imperial cities of Japan, and the ecclesiastical capital, is situated in the south-west of the island of Nipon, in the midst of an extensive plain, and about 30 miles from Osaca. This city, where the Mikado or spiritual emperor and suzerain of the empire reigns supreme, is the great stronghold of Sintoism, the ancient religion of Japan—of temple-worship, priests, monks, ceremonies, and ritualism. Some of the temples are of great size and splendour. M. is also the headquarters of literature, science, and art. The imperial palace, on the northern side of the city, is, together with its ward, a town of itself. The city is connected with the river Yedogana by a canal. The population has been variously estimated at from 500,000 to 1,000,000.

MIA MI, a river of Ohio, United States of America, rises by several branches in the western centre of the state, and after a south-south-west course of 150 miles through one of the richest regions of America, and the important towns of Dayton and Hamilton, empties itself into the Ohio River, 20 miles west of Cincinnati. It is sometimes called the Great M., to distinguish it from the Little M., a smaller river, which runs parallel to it, 15 to 25 miles east, through the Miami Valley.

MIA'SMA (Gr. pollution; in the plural, *Miasmata*), or **MALARIA**. It is proved by the experience of all ages that there is an intimate connection between marshy districts and certain diseases, especially the various forms of intermittent and remittent fever; but the exact nature of the noxious agent, and the circumstances on which its formation and extrication depend, are even at the present day not altogether established. It is clearly neither heat nor moisture, for the crews of clean ships, when cruising in the tropics at a distance from land, are usually very healthy; nor is it any known gas extricated from the marsh, for the gases collected by stirring up marshes (carbonic acid, nitrogen, oxygen, and carburetted

hydrogen) may be inspired without giving rise to any symptoms resembling those produced by malaria. It may be regarded as an established fact, that the noxious agent is a product of vegetable decomposition occurring under certain conditions of heat and moisture. That vegetable decomposition is the source of the poison, is inferred from various circumstances. For example, this special morbid influence is nowhere so powerful as in the deltas and along the banks of large tropical rivers which, in their flood, bring down the washings of the soil, full of vegetable remains, which, upon the subsidence of the waters, are left reeking in the hot sun. Again, the poison has been traced, in various places in Italy, France, and the Netherlands, to the practice of steeping flax in stagnant waters, and even in streams; and in India, it was formerly the custom, after extracting the colouring matter, to throw the remains of the indigo into large heaps, which, in the course of three years, became excellent manure: it was found, however, that these heaps, alternately soaked by the heavy rains and heated by a tropical sun, decomposed and emitted miasmata precisely similar in their effects to those produced by marshes. Marsh-miasmata are seldom evolved at a temperature under 60°, but at and above 80° they are prevalent and severe; and the nearer we approach the equator, the more violent, as a general rule, do they become. Although moisture is necessary to the evolution of miasmata, an excess of it often acts as a preventive, and by impeding the access of atmospheric air, retards or prevents decomposition. This explains the apparent anomaly of an uncommonly rainy season producing opposite effects in different localities, sometimes not far distant from one another. Thus, in the West Indies, a very rainy season induces general sickness in the dry and well-cleared island of Barbadoes; while at Trinidad, whose central portions are 'a sea of swamp,' and where it rains nine months in the year, the excessive rain is a preservative from sickness; for in the seasons when rain falls only eight months or less, the swamps become dry and exposed to the sun, and severe remittent fevers are sure to follow.

Chemistry has hitherto failed in detecting any special ingredient to which the air evolved by marshes owes its poisonous qualities. The air collected in the most poisonous districts gives, on analysis, the same gases existing in the same proportions as normal air, nor (if we except the observations of Boussingault, which have not been confirmed by other chemists) does it give evidence of the presence of any organic body.

The infecting distance of this poison is a subject of great practical importance; and both the altitudinal range and the horizontal spread have to be noticed. In Italy, it is estimated that an altitude of about 1500 feet assures an exemption from marsh-poison; while in the West Indies, an elevation of at least 2000 feet is necessary. From observations made by Sir Gilbert Blane during the ill-fated Walcheren expedition, it appears that, in Europe, the horizontal spread of marsh-miasmata over fresh water is less than 3000 feet; but over salt water—at all events, in the tropics—the horizontal range is greater. The extent to which the poison may spread horizontally over land, is a much more complicated question, and depends, to a great extent, upon the nature of the soil. The effect of trees in intercepting miasmata is very remarkable, and is probably due partly to their condensing the vapours of the marsh, and partly to their altering the direction of the current of air. Pope Benedict XIV. caused a wood to be cut down which separated Villatri from the Pontine Marshes, and in consequence, for many

years, there was a most severe and fatal fever in a district previously healthy; and the same results have in many other cases followed the removal of trees.

In districts where this poison exists, it is found by experience that those who go out of their houses only during the day, after the morning fogs have dispersed, and before the evening mists appear, often escape the bad effects; and a full meal, with a few grains of quinine, should be taken before exposure to the morning air by travellers in a malarious district.

Dr Wood of Philadelphia has pointed out the extraordinary and very important fact, that miasmata are neutralised, decomposed, or in some other way rendered innocuous by the air of large cities. Though malarious diseases may rage around a city, and even invade the outskirts, yet they are unable to penetrate into the interior, and individuals who never leave the thickly-built parts almost always escape. What it is in the air of the city which is thus incompatible with malaria, is unknown; but very probably it is connected with the results of combustion, for the fire and smoke of camps are asserted to have had the same effects.

MIAUTSÉ, the aborigines or hill-tribes of China. From the dawn of Chinese history, we find the people of the plains contending against those of the high lands, and to the present day the hardy mountaineers have maintained their independence. They consist of numerous tribes, occupying large portions of Kwang-se, Kwei-chow, Yun-nan, Sze-chuen, and adjacent provinces. Some of them own Chinese sway; other tribes are absolutely independent. They are smaller in size and stature, and have shorter necks, and their features are somewhat more angular than the Chinese. Their dialects are various, and wholly different from the Chinese. Dr Macgowan describes them as skilful in the manufacture of swords. He has shewn that the M. of Western China and the Karens or hill-tribes of Burmah are identical.—Reports of Dr Macgowan's Lectures.

MICA (from the same root with Lat. *mico*, to glitter), a mineral consisting essentially of a silicate of alumina, with which are combined small proportions of silicates of potash, soda, lithia, oxide of iron, oxide of manganese, &c., according to which and the somewhat varying external characters, numerous species have been constituted by mineralogists. COMMON M., also called POTASH M., contains a notable but variable proportion of silicate of potash; it contains also a little fluorine. It is a widely diffused and plentiful mineral, entering largely into the composition of granite, mica-slate, and some other rocks, veins and fissures of which it also often fills up. It has a strong, and often almost metallic lustre. It is remarkable for the readiness with which it splits into thin elastic plates, which are generally transparent. The thinness and elasticity of these plates readily distinguish them from those of talc, and of the laminated variety of gypsum; they are also devoid of the greasy feel of talc. They are sometimes not more than one 300,000th part of an inch in thickness, are generally quite transparent, and are therefore much used in setting objects for the microscope. Plates of M. of large size are also used in Siberia, Peru, and Mexico as a substitute for glass in windows. Large plates, often a yard in diameter, are found in these countries, and in Norway and Sweden. M. is advantageously substituted for glass in lanterns, as it bears sudden changes of temperature better than glass, and in ships-of-war, as it is not liable to be broken on the discharge of cannon. Another use of M. is for

making an artificial aventurine; it is also employed in a powdered state to give a brilliant appearance to walls, and as a sand to sprinkle on writing. In the state of a very fine powder, it is known as *Cat's Gold* or *Cat's Silver*, according to its colour. It is usually colourless, but sometimes white, gray, green, red, brown, black, and rarely yellow, owing to the presence of iron, manganese, chrome, fluorine, &c., in its composition. It is sometimes found in beautiful crystals, which are generally rhombic or six-sided tables.—LITHIA M., or LEPIDOLITE, contains lithia in small proportion. It is often of a rose colour, or a peach-blossom colour. It is used for ornamental purposes. It is found in several places in Britain.—MAGNESIA M., or BIOTITE, contains about as much magnesia as alumina. It is often dark green.

MICA-SCHIST is, next to gneiss, one of the most abundant of the Metamorphic Rocks (q. v.). It consists of alternate layers of mica and quartz, but is sometimes composed almost entirely of the thin and shining plates or scales of mica, and from this it passes by insensible gradations into clay-slate. The quartz occurs pure in thin layers like vein-quartz. Garnets are in some districts abundant in this rock, making up a large proportion of the whole mass. Mica-schist is believed to be a highly altered shale or clay deposit, and the component minerals, including the garnets, to have been developed under the influence of metamorphic action from materials already existing in the unaltered strata. In many places, the mica-schist has a finely corrugated or wavy structure.

MICAH, the sixth (third in the lxx.) of the twelve minor prophets (Micyahu: Who is like unto Jah?), probably a native of Moresheth, prophesied during the reigns of Jotham, Ahaz, and Hezekiah, and was therefore contemporary with Isaiah, and Hosea, and Amos.—The Book of M. is regarded as divisible into three parts, each commencing with 'Hear ye,' organically connected, however, with each other, and shewing even a progressive development of idea in the mind of the writer. The destruction of Samaria (Israel), the danger and subsequent captivity of Judah; the wickedness of the rulers, the punishments that overtake the land, the glorious restoration of the theocracy; Jehovah's 'controversy with his people' on account of their sins, his warnings, his exhortations, and his sublime promise of forgiveness, form the principal points of M.'s prophecies, which relate to the invasions by Shalmaneser, Sennacherib, the Babylonian exile, the return, and the re-establishment of the theocracy under Zerubbabel. The style of M. is clear, vivid, concise, yet richly poetical; some passages, especially in the beginning and the last two chapters, are among the noblest in the Old Testament. The play upon words noticeable in Isaiah is also a marked feature of this writer.

MICHAEL ANGELO (BUONAROTTI), who, in an age when Christian art had reached its zenith, stood almost unrivalled as a painter, sculptor, and architect, was born in 1474 at Chiusi, in Italy. He was of noble origin, having descended on his mother's side from the ancient family of Canossa, in Tuscany, while the Buonarotti had long been associated with places of trust in the Florentine republic. M. A. learned the rudiments of painting from Bertoldo, a pupil of Domenico Ghirlandaio; and having been admitted as a student into the seminary which was established by Lorenzo the Magnificent for the study of ancient art in connection with the collections of statuary in the Medicean Gardens, he attracted the notice of Lorenzo by the artistic skill with which he had restored the mutilated head of a

laughing faun, and was received into the palace of the Medici, where he spent several years. Lorenzo's death in 1492, and the temporary reverses which befell the Medici family in consequence of the incapacity of his successor, Piero, led M. A. to retire to Bologna, whence he soon removed to Rome, whither his fame had preceded him. His earliest original works were a Kneeling Angel, executed for the grave of St Dominic, at Bologna; the statues of Bacchus and David at Florence; and a magnificent group representing the *Mater Dolorosa*, which was placed in St Peter's, at Rome. Next in order of time, and, according to some of his contemporaries, first in merit, ranks M. A.'s great cartoon for the ducal palace at Florence, which, together with the pendant executed by Leonardo da Vinci, has long since perished. This work, which represented a scene in the wars with Pisa, when a number of young Florentines, while bathing in the Arno, are surprised by an attack of the Pisans, shewed so marvellous a knowledge of the anatomical development of the human figure, and such extraordinary facility in the powers of execution, that it became a study for artists of every land, and by its excellence created a new era in art. Pope Julius II. called M. A. to Rome, and commissioned him to make his monument, which was to be erected within St Peter's. Although this work was never completed on the colossal scale on which it had been designed, and was ultimately erected in the church of St Pietro ad Vincula, it is a magnificent composition, and is memorable for having given occasion to the reconstruction of St Peter's on its present sublime plan, in order the better to adapt it to the colossal dimensions of the proposed monument. The pope insisted upon M. A. painting with his own hand the ceiling of the Sistine Chapel, and, although unwillingly, he began in 1508, and completed within less than two years his colossal task, which proved one of the most marvellous of his works. The subjects of these cartoons are taken from the book of Genesis, while between these and the representations of the persons of the Saviour's genealogy are colossal figures of prophets and sibyls. M. A.'s genius was too often trammelled by the unworthy tasks in which Leo X. and successive popes engaged him, the former having employed him for years in excavating roads for the transportation of marble from Carrara, and in other ignoble labours. The Florentines and Bolognese vied with the pontiffs in trying to secure his services; and to his skill as an engineer Florence was indebted for the plans of the fortifications by which she was enabled for a prolonged time to resist the attempts of the Medici to recover possession of the city after their expulsion from it. On the surrender of Florence, he returned to Rome, where his great picture of the Last Judgment was painted for the altar of the Sistine Chapel. This colossal fresco, nearly 70 feet in height, which was completed in 1541, was regarded by contemporary critics as having surpassed all his other works for the unparalleled powers of invention and the consummate knowledge of the human figure which it displayed. After its completion, M. A. devoted himself to the perfecting of St Peter's, which, by the touch of his genius, was converted from a mere Saracenic hall into the most superb model of a Christian church. He refused all remuneration for this labour, which he regarded as a service to the glory of God. M. A. died in 1563, at Rome, but his remains were removed to Florence, and laid within the church of Santa Croce. His piety, benevolence, and liberality made him generally beloved; and in the history of art, no name shines with a more unsullied lustre than that of Michael Angelo.—See Vasari's *Vite de' Pittori* (Rome, 1563,

1823), and the English translations of that work.

MICHAEL VI., surnamed PALÆOLOGUS, emperor of Constantinople. See PALÆOLOGUS.

MICHAELIS, JOHANN DAVID, one of the most eminent and learned biblical scholars of the 18th c., was born on 27th February 1717, at Halle, where his father, Christian Benedict Michaelis, a theologian and orientalist of some distinction, was a professor. After completing his studies at his native university, he travelled in England and Holland, where he made the acquaintance of several celebrated scholars. In 1746, he became a professor of philosophy at Göttingen, and took an active part in the formation of a scientific association there. From 1753 to 1770, he was one of the editors of the *Göttinger gelehrten Anzeigen*, and for some years he filled the office of librarian to the university. During the Seven Years' War, he was occupied in making preparations for an expedition of discovery in Arabia, which was afterwards made by Niebuhr. In the latter years of his life, he was almost always in the professorial chair or at his desk. He died on 22d August 1791. M. was a man of vast attainments in history and archæology, and his labours were of great importance in the departments of Biblical Exegesis and History. He may be regarded as among the earliest of the critical school of German theologians, but he lived at too early a period to acquire anything like a consistent or systematic theory of the genesis of the Hebrew Scriptures. He loved to rationalise in details, and was never quite certain what to think about inspiration; at all events, he seeks constantly to prove how thoroughly human the Mosaic legislation was, though he does not exactly deny its claims to being considered a Divine revelation. Many of his pupils became professors, and disseminated his principles through the German universities.

M.'s chief works are his *Einleitung in die göttlichen Schriften des Neuen Bundes* (2 vols. Güt. 1750; English by Bishop Marsh); his *Mosaische Recht* (6 vols. Frankf. 1770—1775; English by Dr Alexander Smith, 1814); and his *Moral* (3 vols. Güt. 1792—1823). See his *Lebensbeschreibung von ihm selbst abgefasst* (Rinteln und Leip. 1793).

MICHAELMAS DAISY. See ASTER.

MICHAELMAS DAY, one of the English quarter-days for payment of rent by tenants—viz., 29th September. Michaelmas term is one of the four legal terms during which the English courts of law and equity sit daily for despatch of business. It begins on the 2d, and ends on the 25th November. Michaelmas Head Court is the name given in Scotland to the annual meeting of heritors or freeholders of each county to revise the roll of freeholders, the duties being now discharged by the Commissioners of Supply.

MICHELET, JULES, a brilliant French historian, born at Paris 21st August 1798. He studied with great success under Villemain and Leclerc, and at the age of 23 became a professor in the Collège Rollin, where he taught history, philosophy, and the classics. In 1826, he published *Les Tableaux Synchroniques de l'Histoire Moderne*, and was named Master of Conferences (*Maître des Conférences*) at the *Ecole Normale*. After the revolution of 1830, he was chosen head of the historic section, intrusted with the care of the archives of the kingdom, assistant to Guizot at the Sorbonne, and tutor to the Princess Clémentine, daughter of the French king, and published several valuable books, such as *Précis de l'Histoire Moderne* (1833, of which there have been more than 20 editions), *Précis de l'Histoire de France jusqu'à la Révolution Française*

(the 7th edition of which appeared in 1842), *Mémoires de Luther* (1835), *Origines du Droit Français* *cherchées dans les Symboles et Formules du Droit Universel* (1837). In 1838, he succeeded Daunau in the Collège de France, and Comte Reinhard in the professorship of Moral Philosophy. He now plunged into controversy with all the vivacity and impetuosity of his nature. The Jesuits were the grand objects of his dislike; and eloquence, sarcasm, sentiment, and history were all brought to bear upon them with brilliant effect. Three books were the fruits of his polemic: *Des Jésuites*, in conjunction with Edgar Quinet (1843); *Du Prêtre, de la Femme, et de la Famille* (1844); *Du Peuple* (1846). In 1847 appeared the first volume of his *Histoire de la Révolution*; and it was finished in 1853, in 6 vols. When the affair of 1848 broke out, acting more wisely than most of his learned *confrères*, he declined to take an active part in political struggles, and has since quietly pursued his literary avocations. He, however, lost his situation in the Archives Office after the *coup d'état*, by refusing to take the oath of allegiance to Louis Napoleon. His more recent works are *L'Oiseau* (1856), *L'Insecte* (1857), *L'Amour* (1858), and *La Femme* (1859), all of which are marked by exquisite beauty of style, grace of imagination, and suggestiveness of sentiment. His master-piece, however, is his *Histoire de France*, begun in 1833, of which the 12th volume appeared in 1860.

MICHIGAN, one of the United States of America, lying in lat. 41° 40'—48° 20' N., and long. 82° 25'—90° 34' W. It is bounded on the N. by Lake Superior and St Mary's River; E. by Lake Huron, River and Lake St Clair, Detroit River and Lake Erie; S. by the states of Ohio and Indiana; and W. by Lakes Michigan and Wisconsin, and has an area of 56,243 square miles, or 35,995,520 acres. It is divided into 73 counties. The capital is Lansing; the chief towns are Detroit, Ann Arbor, Monroe, Grand Haven, Kalimazoo, Marshall, &c. The state is divided by Lakes Michigan and Huron into two irregular peninsulas—the upper, a wild and rough region of mountains and forests, containing about one-third the area of the state, lies between the northern portions of Lakes Michigan and Huron, and Lake Superior; while the lower is nearly enclosed in a vast horse-shoe bend of Lakes Michigan, Huron, Erie, and the connecting straits and rivers. In the upper peninsula are the Porcupine Mountains, rising to a height of 2000 feet, with sandy plains and forests. The southern is a level, rich, fertile country of prairies and oak-openings, watered by numerous rivers, as the Grand, Kalimazoo, Muskegon, Saginaw, &c. The lower peninsula is of limestone strata, with coal and gypsum; the upper, of azoic formations, with metamorphic slates, gneiss rocks, trap, and rich mines of copper and iron. The climate is mild in the southern, and cold and bleak in the northern regions. The southern portion produces wheat, maize, fruits, butter, cheese, and wool in great abundance. Vast quantities of pine-lumber are exported from the northern half of the state. The principal manufactures are flour and woollens. The extensive coast and rivers afford great facilities to navigation, while four railways traverse the state. The government is similar to those of the other states, and the school-system is based on that of Prussia, with abundant-revenues from public lands. The university of M. at Ann Arbor has 28 professors, and a foundation of 1,000,000 acres of land. The only charge to students is 10 dollars admission, and 5 dollars annual fee.—Detroit was settled by the French in 1610, who also established a trading port at Mackinaw at about the same period. The British took Detroit in 1812, but restored it at the

end of the war. The state was admitted to the Union in 1837. Pop., in 1830, 31,639; in 1840, 212,267; in 1850, 397,654; in 1860, 749,112.

MICHIGAN, a lake in the United States of America, the second in size of the five great fresh-water lakes, and the only one lying wholly in the United States, having Michigan on the N. and E., and Wisconsin on the W. It is 320 miles long, 70 miles in mean breadth, and 1000 feet in mean depth. It is 578 feet above the level of the sea, and has been found by accurate observations to have a lunar tidal wave of three inches. It is the outlet of numerous rivers, and is connected by a canal, and sometimes by flooded rivers, with the Mississippi, which is believed to have been its ancient outlet. Its principal harbours are those of Chicago, Milwaukee, and Grand Haven; and its bold and, at certain seasons, dangerous shores are guarded by 23 light-houses. It forms, with the lower lakes and the St Lawrence, a natural outlet for one of the richest grain-growing regions in the world.

MICROCOSM AND MACROCOSM. The belief, current in ancient times, that the world or cosmos was animated, or had a soul (see ANIMA MUNDI), led to the notion, that the parts and members of organic beings must have their counterparts in the members of the cosmos. Thus, in a hymn ascribed to Orpheus, the sun and moon are looked upon as the eyes of the animating godhead, the earth and its mountains as his body, the ether as his intellect, the sky as his wings. The natural philosophers of the 16th c.—Paracelsus at their head—took up this notion anew in a somewhat modified shape, and considered the world as a human organism on the large scale, and man as a world, or cosmos, in miniature; hence they called man a *microcosm* (Gr. little world), and the universe itself, the *macrocosm* (great world). With this was associated the belief, that the vital movements of the microcosm exactly corresponded to those of the macrocosm, and represented them, as it were, in copy; and this led naturally to the further assumption, that the movements of the stars must exercise an influence on the temperament and fortunes of men. See ASTROLOGY.

MICROCOSMIC SALT is a tribasic phosphate of soda, oxide of ammonium, and water, which crystallises with 8 equivalents of water, its formula being $\text{NaO}, \text{H}_2\text{NO}, \text{HO}, \text{PO}_3 + 8\text{Aq}$. It is prepared by mixing a hot solution of 6 parts of phosphate of soda with a concentrated solution of 1 part of muriate of ammonia, when the microcosmic salt crystallises in large transparent prisms, while common salt remains in solution. On the application of heat, it first loses its water of crystallisation, and then its oxide of ammonium and basic water, so that only metaphosphate of soda remains, which, from its ready fusibility into a colourless glass, is valuable as a flux in blow-pipe experiments. See BLOW-PIPE. This salt occurs in decomposed urine.

MICROLESTES (Gr. little robber), a genus of fossil insectivorous mammals, whose remains supply the earliest evidence of the existence of warm-blooded quadrupeds on the globe. As yet, nothing but a few teeth have been found, in the bone-beds of the Upper Triassic system in Würtemberg, and of apparently the same age near Frome, in Somersetshire. They apparently belonged to small insectivorous animals, but no living quadruped presents any close affinity to them.

MICROMETER (Gr. *mikros*, little; *metron*, measure) is an instrument used for the measurement of minute distances and angles. There are many different forms of micrometer, depending on different principles, but they may be divided into two

MICROMETER—MICROSCOPE.

sections, according as they are applied to Physics or Astronomy. Of the former section are the Vernier (q. v.) and the Micrometer Screw, the latter instrument being merely a screw with a very regular thread, and a large round head, which is carefully graduated, generally to sixtieths, and furnished with an index. It is easily seen that if one complete turn of the screw advance its point $\frac{1}{60}$ th of an inch, then a turn sufficient to pass the index from one graduation to another will only advance it $\frac{1}{120}$ th of an inch, &c. This is the micrometer used in the construction and graduation of instruments. Of those which are applied to astronomical purposes, the most simple is a short tube, across the opening of which are stretched two parallel threads, which can be made to approach or recede from each other by means of screws. These two threads are crossed by a third perpendicularly, and the whole apparatus is placed in the focus of a lens. The distance of two stars is found by adjusting the two parallel threads, one to pass through the centre of each star, taking care that the threads are placed perpendicular to the line joining the stars, and finding how many turns and parts of a turn of the screw are required to bring the wires to coincide. The angle of position of two stars is also obtained by turning round the instrument till the third wire, which is normally horizontal, bisects both stars, and reading off on the circumference the arc passed over. *Fraunhofer's suspended annular micrometer* consists merely of a steel ring surrounded by a flat rim of glass, and the position of the star is deduced from the time when it crosses the ring and its path while within it. In the commencement of this century, the Abbé Rochon substituted for the wire micrometer one constructed of two prisms of rock-crystal or Iceland spar, substances capable of double refraction. These prisms were fixed together with their axes of crystallisation at right angles to each other, to increase the deviation of the two images, and the micrometer thus constructed was placed *within* the focus of the object-glass of a telescope, thus giving two images to be observed by the eye-piece. The distance between these images depends on the relative positions of the eye, the micrometer, and the object; and consequently, after the instrument has been graduated, all that is required to determine the apparent diameter of a heavenly body, is to move the crystal backwards or forwards, till the two images appear to touch, and the graduation corresponding to the place of the crystal, gives the required result. This form of micrometer has been improved by Arago, Dollond, and others.

Many other micrometers, particularly several of Fraunhofer's, might be mentioned, but their principles are very similar to those above described.

MICROSCOPE (Gr. *mikros*, small, and *skopeo*, I see) is an instrument for enabling us to examine objects which are so small as to be almost or quite undiscernible by the unaided eye. Its early history is obscure; but as it is quite evident the property of magnifying possessed by the lens must have been noticed as soon as it was made, we are quite safe in attributing its existence in its simplest form to a period considerably anterior to the time of Christ. At this period, and for many centuries later, the microscope consisted of a single lens, and was of the rudest character, and seems to have been used principally for concentrating the heating power of the sun's rays.

An object to be magnified requires simply that it be brought nearer to the eye than when first examined, but as the focal distance of the eye ranges from 6 inches to 14 inches—10 inches being the average focal distance—it follows that a limit to

the magnifying power of the eye is attained whenever the object to be examined is brought so near. If, however, we blacken a card, and pierce a hole in it with a fine needle, and then examine a minute object, as, for instance, the wing of an insect held about an inch from the card, we shall see it distinctly, and that too magnified about ten times its size. This is explained by the fact, that the pin-hole limits the divergence of the pencil of rays, so that the eye can converge it sufficiently on the retina to produce a distinct impression. The impression so got is faint; and did not the blackened card exclude all other light, it would be lost. If we now remove the blackened card without either removing our eye or the object under examination, it will be found that the insect's wing is almost invisible, the unassisted eye being unable to see clearly an object so near as one inch; thus demonstrating the blackened card with the needle-hole in it to be as decided a magnifying instrument as any set of lenses, by enabling the eye to approach within an inch of the object. This description of magnifying power only applies to the simple microscope, where we look at the object directly, and not to the compound microscope, where we look at an image formed by one lens, that image being viewed and magnified by another lens as an original object.

By the apparent size of an object is understood the angle formed by two lines drawn from the centre of the eye to the extremities of the object, which is larger when the object is nearer the eye than when further removed. This angle is called the angle of vision, and is quite distinct from the angle of the pencil of light, by which the object is seen. The focal length of a lens determines its magnifying power. The object to be examined is placed in its focus, so that the light which diverges from each point may, after refraction by the lens, proceed to the eye in lines as nearly parallel as is necessary for distinct vision. Thus, in fig. 1, AB is

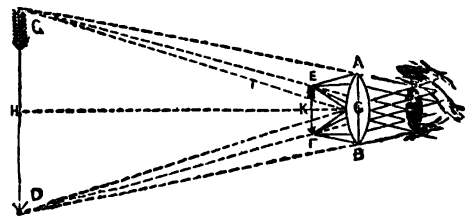

Fig. 1.

a double convex lens, in the focus of which we have drawn an arrow, EF, to represent the object under inspection. The cones drawn from its extremities are portions of the rays of light diverging from these points, and falling on the lens. These rays, if not interrupted in their course by the lens AB, would be too divergent to permit their being brought to a focus upon the retina by the lenses which constitute the eye. But as they are first passed through the lens AB, they are bent into nearly parallel lines, or into lines diverging from some points within the limits of distinct vision, as from CD. Thus bent, these rays are received by the eye as if proceeding from the larger arrow CD, which we may suppose to be ten inches from the eye, and then the ratio of the length of the virtual image to that of the real arrow (nearly 10 to 1) gives the magnifying power of the lens in question. The ratio of CD to EF is the same as that of HG to KG. Now, HG is the distance of distinct vision, and KG the focal length of the lens, so that the magnifying power of a lens is obtained by dividing the distance of distinct vision (ten inches for most

individuals) by its focal length. Thus, if the focal length of a lens be $\frac{1}{4}$ inch, the magnifying power is $\frac{10}{\frac{1}{4}} = 40$. This supposes that the distance between the eye and the lens is so small as not materially to interfere with the correctness of this statement.

We have supposed the whole of the light to enter the eye through the lens AB (fig. 1), but we must now state that so large a pencil of light passing through a single lens would be so distorted by its spherical figure, and by the chromatic dispersion of the glass, as to produce a very indistinct and imperfect image. This is so far rectified by applying a stop to the lens, so as to allow only the central portion of the pencil to pass. But while such a limited pencil would represent correctly the form and colour of the object, so small a pencil of light is unable to bear diffusion over the magnified picture, and is therefore incapable of displaying those organic markings on animals or plants which are often of so much importance in distinguishing one class of objects from another. Dr Wollaston was the first to overcome this difficulty, which he achieved by constructing a doublet (fig. 2), which consists of two plano-convex lenses, having their focal lengths in the proportion of 1 to 3, and placed at a distance best ascertained by experiment. Their plane sides are placed towards the object, and the lens of shortest focal length next the object.



Fig. 2.

By this arrangement, the distortion caused by the first lens is corrected by the second, and a well-defined and illuminated image is seen. Dr Wollaston's doublet was further improved by Mr Holland, who substituted two lenses for the first in Dr Wollaston's doublet, and retained the stop between them and the third. This combination, though generally called a triplet, is virtually a doublet, inasmuch as the two lenses only accomplish what the anterior lens did in Dr Wollaston's doublet, although with less precision. In this combination (fig. 3) of lenses, the errors are still further reduced by the close approximation of the lenses to the object, which causes the refractions to take place near the axis, and thus we have a still larger pencil of light transmitted, and have also a more distinct and vivid image presented to the eye.



Fig. 3.

the axis, and thus we have a still larger pencil of light transmitted, and have also a more distinct and vivid image presented to the eye.

Simple Microscope.—By this term we mean an instrument by means of which we view the object through the lens directly. These instruments may be divided into two classes—those simply used in the hand, and those provided with a stand or frame, so arranged as to be capable of being adjusted by means of a screw to its exact focal distance, and of being moved over different parts of the object. The single lenses used may be either a double convex or a plano-convex. When a higher power is wanted, a doublet, such as we have already described, may be employed, or a Coddington lens, which consists (fig. 4) of a sphere in which a groove is cut and filled up with opaque matter. This is perhaps the most convenient hand lens, as it matters little, from its spherical form, in what position it is held. In the simple microscope, single or combined lenses may be employed, varying from a quarter to two inches. There are many different kinds of stands for simple microscopes made, but as they are principally used for dissection, the most important point next to good glasses is to secure a firm large stage for supporting the objects under



Fig. 4.

examination. When low powers alone are used, the stage-movements may be dispensed with; but when the doublet or triplet is employed, some more delicate adjustment than that of the hand is necessary.

Compound Microscope.—We have already said that in the compound microscope the observer does not view the object directly, but an image or picture of the object is formed by one lens or set of lenses, and that image is seen through another lens. The compound microscope consists essentially of two lenses, an object and an eye lens; but each of these may be compounded of several lenses playing the part of one, as in the simple microscope. The eye-lens is that placed next the eye, and the object-lens that next the object. The former is also called the ocular, and the latter the objective. The object-glass is generally made of two or three achromatic lenses, while the eye-piece generally consists of two plano-convex lenses, with their flat faces next the eye, and separated at half the sums of their focal lengths, with a diaphragm or stop between them.

The following diagram (fig. 5) explains the manner in which the compound microscope acts. We have here represented the triple achromatic objective, consisting of three achromatic lenses combined in one tube, in connection with the eye-piece, which consists of the field-glass FF, and the eye-glass EE. Three rays of light are represented as proceeding from the centre, and three from each end of the object. These rays would, if not interfered with, form an image at AA; but coming in contact with the field-glass FF, they are bent, and made to converge at BB, where the image is formed, at which place a stop or diaphragm is placed to intercept all light, except what is required to form a distinct image. From BB, the rays proceed to the eye-glass exactly as they do in the simple microscope, and as we have explained in fig. 1. The image therefore formed at AA is viewed as an original object by an observer through the eye-piece EE. The lens FF is not essential to a compound microscope; but as it is quite evident that the rays proceeding to AA would fall without the eye-lens EE, if it was removed, and only a part of the object would thus be brought under view, it is always made use of in the compound microscope.

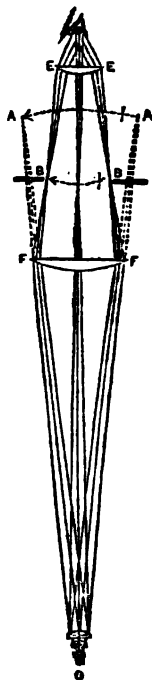

Fig. 5.

A mirror is necessary for reflecting the light on the object under observation, and for this purpose is generally supported on trunnions underneath the stage. The best instruments are supplied with six or seven object-glasses, varying in magnifying power from 20 to 2500 diameters. The eye-pieces supplied are three in number, each of which consists of two plano-convex lenses, between which a stop or diaphragm is placed, half-way between the two lenses. As the magnifying power of a compound microscope depends on the product of the magnifying powers of the object-glass and the eye-piece, it follows that its power may be increased or diminished by a change in either or both of these glasses. In the mechanical arrangements, it is of importance to have the instrument so constructed, that while every facility is afforded for making observations

MICROSCOPE.

and easy means of adjustment, there should also be great steadiness, without which, indeed, no satisfactory results will be obtained. These ends are achieved in various ways, of which fig. 6 is one

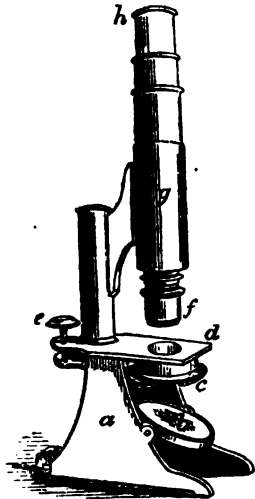

Fig. 6.

of the simplest: *a*, brass stand, supported on three feet; *b*, mirror supported on trunnions; *c*, diaphragm, pierced with circular holes of various sizes, to regulate the admission to the object of reflected light from the mirror; *d*, stage-plate, on which the object is placed; *e*, screw, with milled head for fine adjustment; *f*, the object-glass or objective; *g*, brass tube in which the body of the instrument is moved, so as to effect the coarse adjustment; *h*, the eye-piece, or ocular.

The microscope has now become so important an instrument in education, that almost every department of science in which it can be employed has a special treatise explaining and illustrating its use; and many branches of science have instruments peculiarly their own. Thus, chemists, anatomists, zoologists, &c., have each an instrument which they value as being peculiarly adapted for their special fields of inquiry and observation. From this instrument the chemist, and natural philosophers generally, have derived great assistance in studying the different kinds of crystals; for, by means of it, they can not only observe and recognise the great variety of forms that exist, but at any moment, and with little trouble, they may witness the process of crystallisation, and leisurely study it. The question now is, not to what science can the microscope with advantage be applied, but rather, which one of them all can get on without it. Those sciences in which it is most used, and for which it has done most, are anatomy, botany, zoology, medicine, mineralogy, and geology. In the practice of medicine all medical men who aim at a scientific treatment of disease have fully recognised how useful it has been as an agent in diagnosis. In the detection of crime and the vindication of innocence, it is no less useful, as by means of it we can with certainty determine whether a suspicious stain, found, for instance, on the clothing of an individual charged with murder, has been caused by the blood of one of the lower animals or by that of a human being. In like manner, we can determine whether hair found in similar circumstances belongs to a human being or not. That such knowledge must often be of service in directing justice to correct conclusions as to the innocence or guilt of a suspected person, will be obvious.

Of the most striking and interesting additions which the microscope has made to our knowledge, we may particularise what it has revealed to us of the development of the embryo in plants and animals; and of the relation between the symptoms of disease and deranged organic structure. It has also enabled us to distinguish the difference existing between substances that have a similar chemical reaction (e. g., the various kinds of starch, as flour, potato, sago, &c.), and thus we are provided with

an agent quick in detecting adulteration; and not to mention more, we are enabled, through the knowledge of minute structure which it has furnished, to refer almost any animal, living or extinct, to its class in the animal kingdom, if we have merely a tooth or a fragment of a bone subjected to the penetrating inspection of a good instrument.

A few hints to amateur observers may not be out of place here. In choosing an instrument, the simpler it is the better. The essential point to attend to is, to have good glasses, which are generally tested by their power of shewing some very minute markings, such as we find on diatoms. The circumference of the field of view should not be tinged with colour, and the definition should be as good at the edge as at the centre. The beginner should use low powers in preference to high ones; and if his glasses are good, he will do well, as we have found by experience, to use a low object-glass and a high eye-glass. By means of this arrangement, he will procure a much better illuminated picture than if the powers of the glasses were reversed. The room in which observations are made should be light, and, if possible, with the window in a northern aspect, and free from the shadows of trees, &c. The table must be steady on which the microscope is placed, and when not in use, the instrument should be covered by means of a glass shade. Besides the microscope, the observer requires a few oblong glass slides with cells formed on them by a circle of asphalt, or wax dissolved in turpentine or other matter. Or the cell may be ground out of the oblong glass. He also requires a few circles of thin glass to cover them, when his preparations are under view. And for making sections, dissecting, and the various manipulatory operations attending the use of the microscope, he requires, moreover, a pair of forceps, a knife, or, perhaps better, a razor ground flat on the one side, a few needles fixed in handles, and two or three hair-pencils. For viewing opaque objects with advantage, a bull's-eye lens, is necessary. So equipped, the observer is able to begin examinations of texture at once with pleasure and advantage. Begin with simple objects, such as pollen and thin slices of the cuticle of flowers, mosses, and different kinds of starch, such as *tous le mois*, buck yam, cycas, arrow-root, &c., and notice particularly their different characters.

Microscopes vary much in price, from 5s. to upwards of £100. A good serviceable dissecting simple microscope may be had from any philosophical instrument-maker for from 9s. to 15s. Compound microscopes are more expensive, but a wonderfully good instrument for beginners can be had at 30s. It has one eye-glass and three object-glasses, and magnifies from 70 to 200 diameters. If a superior instrument is wished—one suited for most purposes of observation and research—any one of the following will be found well worth the price:—The microscope of Oberhauser, with a joint, so that it may be inclined at any angle, has two eye-pieces, two object-glasses, magnifies from 50 to 450 diameters, and costs £7, 10s.; Nacet's microscope has three eye-pieces, three object-glasses, magnifies from 50 to 750 diameters, and costs £8, 15s.; Smith and Beck's educational microscope has two eye-pieces, two object-glasses, magnifies from 50 to 350 diameters, and costs £10; Ross supplies microscopes from £5 to £100, with various number of glasses.

For a more complete account of the different kinds of microscopes, and the various purposes to which they are applied, see Quakett *On the Microscope* (1855); Carpenter *On the Microscope* (1862); Hogg *On the Microscope* (1855); and *How to work with the Microscope* (1864), by Beale.

MIDAS, a common name of the more ancient Phrygian kings, of whom Midas, the son of Gordius and Cybele, is the most famous. He was a pupil of Orpheus. Among the many legends regarding him is one, that Bacchus granted his wish, that whatever he touched might become gold; from which so great inconvenience ensued, that he was glad to get himself relieved from the burden by washing, at the command of the god, in the Pactolus, the sands of which became thenceforth productive of gold. Another legend represents him as having offended Apollo by assigning the prize in a musical competition to Pan, and as having therefore been endowed by him with a pair of ass's ears, which he concealed under his Phrygian cap, but which were discovered by his servant.

MIDDELBURG, a town of the Netherlands, capital of the province of Zeeland, in the island of Walcheren. It is connected with the sea by a canal, five miles long, which admits ships of heavy burden. In 1796, the population amounted to 17,600; in 1815, it had fallen to 13,114; and has now increased again to 16,200. The city is nearly circular, and a league in circumference, surrounded by a broad canal. In former times, M. was one of the leading mercantile cities of the United Provinces, sending many ships to the East and West India, America, and all European ports, founding the colonies of Surinam, Berbice, Essequibo, Demerara, &c.; but the opening of the Scheldt for Antwerp, and other causes, have reduced the foreign trade to single ships to Java. Many of the inhabitants are wealthy, which, with its being the meeting-place of the provincial states of Zeeland, and possessing a considerable trade in grain, salt, &c.—making beer, vinegar, starch, leather, having snuff, chocolate, oil and saw mills, and foundries—make it still a city of importance. It is the finest city of the northern provinces, having handsome houses, ornamented with gardens, and the canals and streets shaded with trees. The Town-house, founded in 1468, has a beautiful tower, and is decorated with 25 colossal statues of Counts and Countesses of Holland. At the beginning of the 12th c., an abbey was founded, which was, later, enriched by Willem II., Count of Holland and Zeeland. The buildings are now occupied as the meeting-place of the provincial states.

M. does not date further back than the 9th century. In 1574, the Spaniards, under Mondragon, were compelled by famine to give up M., after having defended it for 22 months against Prince Willem I. Though troops are stationed in M., it is no longer tenable against an enemy.

MIDDLE AGES, the designation applied to the great historic period between the times of classic antiquity and modern times. The beginning and close of this period are not very definite. It is usual, however, to regard the middle ages as beginning with the overthrow of the Western Roman Empire in the year 476; and there is a pretty general concurrence in fixing on the Reformation as the great event which brought this period to a close. It began with the rise of the Frankish upon the ruins of the ancient Roman Empire, and with the commencement of civilisation among the barbarous tribes which had taken possession of the former Roman provinces. In course of it, the different nations of modern Europe were formed, and their political and social systems developed. It was a period of much superstition, in connection with which much religious enthusiasm very extensively prevailed, manifested in many great religious endowments, in magnificent ecclesiastical buildings, in pilgrimages, and, above all, in the Crusades. In

the earlier parts of this period, the Church was much occupied in the extension of its bounds in the north of Europe, where heathenism still subsisted, and the means employed were not always consistent with the spirit of Christianity. During the middle ages, the hierarchy acquired enormous power and wealth, and the papacy rose from comparatively small beginnings to its utmost greatness. During the middle ages, chivalry had its rise and decline, modifying, and in many respects tending to refine the feelings and usages of society. From the earlier part of this period, the aristocracy of modern Europe dates the commencement of its existence, and in the lapse of centuries the towns acquired rights, privileges, and liberties. The feudal system was formed, and, ere the close of the middle ages, it had begun to be modified almost everywhere by the influences which proceeded from the towns; and the *states* existed, under various modifications, and with various degrees of power, in most of the countries of Europe. In some countries, particularly in France, the contest between the towns and the aristocracy had begun to result in the establishment of despotism; in others, the sovereigns, resting on the support of the people in their assertion of their own authority over the turbulent nobility, made concessions favourable to the subsequent development of civil liberty. Towards the close of the middle ages, the revival of letters, the increase of knowledge, and the formation of a wealthy and influential class in society, distinct alike from the aristocracy and the peasantry, tended, even before the Reformation, both to the diminution of the power of the hierarchy and the decay of the feudal system. See Guizot's *Histoire de la Civilisation*; Rüh's *Handbuch der Geschichte des Mittelalters*; and Hallam's *History of the Middle Ages*.

MIDDLE BASE AND MIDDLE CHIEF. See **POINTS OF ESCUTCHEON**.

MIDDLE LATITUDE SAILING. See **SAILINGS**.

MIDDLE TEMPLE, one of the four English Inns of Court, having the exclusive privilege of calling persons to the bar. See **INNS OF COURT**.

MIDDLESBROUGH, a thriving and important manufacturing town, river-port, and municipal borough of England, in the North Riding of Yorkshire, at the mouth of the Tees, about 20 miles south-west of Durham. The town is of recent growth, the first house having been built in 1830. It was at first intended by the M. proprietors as a port for the shipment of coal, but it is now chiefly known as a rapidly progressing centre for the iron manufacture, one firm alone employing 7000 hands. There are also chemical, brass, engine, and bottle works, potteries, and blast-furnaces, and rope-walks; ship-building is also carried on, and iron-stone is quarried in the vicinity. In 1862, 4637 vessels, of 503,623 tons, entered and cleared the port. Pop. of municipal borough (1861), 18,992. The local census, taken in 1863, gives nearly 23,000 inhabitants.

MIDDLESEX, the metropolitan county of England, in the south-east of the country, bounded on the N. by Hertford, and on the S. by Surrey, and about 60 miles inland (westward) from the North Sea, with which it communicates by the river Thames. Next to Rutland, it is the smallest of the English counties, its area being only 180,136 statute acres; but its population is inferior only to that of Lancashire, and was, in 1861, 2,206,485. The surface is on the whole level, with gentle undulations. The Thames, which forms its southern boundary, and its affluents, are the only rivers of the county. Two of these, the Colne and the Lea, form respectively the western and the eastern boundaries of the

county. The surface is also traversed by the Grand Junction and Regent's Canal, and the New River, an artificial cut intended to supply the capital with water. The soil is in general poor, with the exception of a tract along the banks of the Thames, which consists of a good fertile loam. The county is chiefly occupied in grass and hay farms, and in market-gardens, the produce of which is sent to supply the metropolis. Parliamentary elections of members for Middlesex are held at Brentford, which is the county town. There are no other towns of importance except London (q. v.).

MIDDLETON, a small manufacturing town of Lancashire, England, a station on the Manchester and Leeds Railway, on a tributary of the Irwell, six miles north-north-east of Manchester. Pop. (1851), 5740; (1861), 9876. It is chiefly dependent upon its manufactures of cotton cloth and silks, many of its brocaded fabrics being sold as goods of Spitalfields manufacture. Print and dye works are also in operation.

MIDDLETON, a small decaying market-town of Ireland, in the county of Cork, and 13 miles by railway east of the city of that name. It contains a college founded in 1696, noticeable as the place in which John Philpot Curran was educated, and still of considerable reputation, and carries on a general trade. Pop. (1861) 3378.

MIDDLETON, CONYERS, D.D., a well-known divine and scholar of the Church of England, was born in 1683, at Richmond, in Yorkshire. He studied at Cambridge, where he took the degree of B.A. in 1702, was elected a fellow in 1706, and shortly after married a lady of fortune. His life was a series of bitter, and, on the whole, not very creditable controversies, though he is said to have been rather a likeable person in private. His first and most formidable opponent was Richard Bentley (q. v.); afterwards, his polemics were chiefly of a theological character. The views he expressed and defended were generally such as to draw down upon him the imputation of being an 'infidel in disguise,' though some of them—such as that the Jews borrowed some of their customs from Egypt, and that the primitive writers in vindicating Scripture found it necessary sometimes to recur to allegory—are now established beyond all doubt; while a third opinion, viz., that the Scriptures are not of absolute and universal inspiration, has since M.'s day been adopted by many of the most learned and accomplished divines even of his own church. M. died at Hildersham, in Cambridgeshire, July 28, 1750. His principal writings are *The History of the Life of M. Tullius Cicero* (2 vols. 1741), a work both interesting and valuable, but neither very impartial nor quite accurate. His celebrated *Letter from Rome, shewing an exact Conformity between Popery and Paganism; or the Religion of the present Romans derived from that of their Heathen Ancestors* (1729), provoked the most violent indignation among Roman Catholics, and is still read with interest. All his pamphlets, treatises, &c. were collected and published under the title of *Miscellaneous Works* (4 vols. Lond. 1752—1757), and contain much that is curious and valuable on theological and antiquarian topics.

MIDDLETOWN, a city and township in Connecticut, United States of America, at the head of navigation, on the right bank of the Connecticut River, 23 miles from its mouth. It is a well-built town, with a handsome custom-house, Wesleyan university, episcopal seminary, 16 churches, 3 banks, 3 cotton factories, foundries, mills, &c. Pop. of township, 8683; of city, 5183.

MIDDLEWICH, a small market-town of England, Cheshire, on the Grand Trunk Canal, 20 miles

east of Chester. Salt is extensively made; boat-building is carried on, and brick-works are in operation. Pop. (1863) 3347.

MIDGE, the common name of many species of small dipterous insects, of the family *Tipulidae*, much resembling gnats, but having a shorter proboscis. Their larvae are aquatic; the perfect insects are often very annoying both to human beings and to cattle. The little pink-coloured tortuous worm known to anglers as the *Blood-worm*, frequent in water-barrels and in the mud near the edges of ponds and ditches, is the larva of a species of *M.* (*Chironomus plumosus*), a little larger than the common gnat, very abundant in Britain, particularly in marshy situations. The larva is much sought after both by birds and fishes, and is a very tempting bait for the latter. The pupa is cylindrical, with respiratory organs on the sides of the thorax. When the insect is ready to quit its pupa case, it rises to the surface of the water, and there remains suspended for a short time; the perfect insect, when it has issued from the case, also stands for a short time on the surface of the water. The genus is remarkable for the long hairs with which the antennae of the male are furnished.—Another genus of Midges (*Simulia*) contains many species which are most tormenting to men and cattle, by entering the ears and nostrils, and alighting on the eyelids. Several species are British. They swarm on marshes and damp heaths in the warmer months. But none of them is nearly so mischievous as a species (*S. columbaschenis*) found on the banks of the Danube, and so plentiful, that horses and cattle are often suffocated by the numbers which get into the wind-pipe.

MIDHURST, a market-town and parliamentary borough of England, in Sussex, on the Rother, a navigable tributary of the Arun, 50 miles south-west of London. Here are the ruins of an old castle of the Bohuns, lords of M.; and within half a mile east of the town stood Cowdry House, the seat of the Montagues, which, with the exception of the gatehouse, was burned down in 1793. M. returns one member to parliament. Pop. (1861) of parliamentary borough, 6405.

MIDIANITES, an Arab race, descended, according to Scripture, from Midian, the son of Abraham by Keturah. They occupied the greater part of the country between the north side of the Arabian Gulf and Arabia Felix as far as the Plains of Moab. Others more civilised (if not, indeed, of Cushite origin) dwelt in the vicinity of the Sinaitic peninsula, and carried on a trade, particularly with Egypt. To the latter, we may presume, belonged Jethro, priest or 'sheik' of Midian—the father-in-law of Moses. The M. were very troublesome neighbours to the Israelites till Gideon's victory over them. Their national god was Baal-Peor.

MIDRASH (Heb. *darash*, to search, explain the Scriptures) is the general name given to the exposition of the Old Testament, which, for about 1500 years, formed the centre of all mental activity, both in and out of the schools, among the Jews after the Babylonian exile. The prohibitions and ordinances contained in the Mosaic records, to which a precise meaning was, not in all cases, attached, were, according to certain hermeneutical rules, specified and particularised, and further surrounded by traditional ordinances and inhibitions: Halacha (q. v.) = rule by which to go, or the binding, authoritative, civil, and religious law. The chief codes of this are the Mishna (q. v.), Gemara (q. v.), Sifra (an amplification on Leviticus), Sifri (on Numbers and Deuteronomy), and Mechilta (on a portion of Exodus). Another branch of

the Midraah, however, is the Haggada (q. v.), a kind of free poetical homiletics on the whole body of the Old Testament (the Halacha being chiefly confined to the Pentateuch). The chief collections of that part of the Midraah are Midraah Rabba, 700—1100 A. D. (on Pentateuch and Megilloth), and Pesikta (700), the extracts from which (Jalkut, Pesikta Rabbati, Sutarra, &c.) only are known, the original itself never having been printed.

MIDSHIPMAN, the second rank attained by combatant officers in the royal navy. After two years' service as naval cadet, the aspirant becomes a midshipman, which is rather an apprenticeship for his after-naval career than any really effective appointment. The midshipman's time is principally devoted to receiving instruction, both in the ordinary subjects of a gentleman's education, and in the special professional duties of a naval officer. After 1½ year's service as such, the midshipman is required to pass a qualifying examination in geography, history, and general knowledge; and, two years later, he must pass in French conversation, and in seamanship, steam, and gunnery. He then becomes a Sub-lieutenant (q. v.); and if 19 years of age, is eligible for promotion to lieutenant, whenever opportunity offers.

A midshipman only receives 1s. 9d. a day (£31, 18s. 9d. per annum); he is consequently dependent on his friends for more or less pecuniary assistance until he becomes a sub-lieutenant.

MIDSUMMER DAY, one of the four English quarter-days for payment of rent by tenants, viz. 24th June. See **LANDLORD AND TENANT**.

MIDSUMMER EVE. See **JOHN'S (ST) EVE**.

MIDWIFE, MIDWIFERY. Midwife (Anglo-Saxon, *med-wif*, meaning probably a woman hired for *mede*, or reward) is the name applied to a woman who assists in parturition or delivery. From this is derived the term *Midwifery*, for that department of medical science which concerns itself with delivery, and its allied subjects. Writers who prefer words derived from Latin and Greek roots to such plain old English words as midwifery, have substituted for it *Obstetrics* (Lat. *obstetriz*, a woman who stands near, a midwife), and *Tokology* (Gr. *tokoa*, child-birth), or *Gynaecology* (Gr. *gynē*, woman); for a male practitioner in this line of the medical art, the French name *accoucheur* is used; and recently, an obnoxious new verb, *to accouch* (Fr. *accoucher*, to deliver a woman), has made its appearance in medical literature.

Midwifery, as a branch of medical science, is understood to include the study of the anatomy of the parts of the female body concerned; the doctrine of conception and of sterility, and the signs and duration of pregnancy; parturition in all its varieties; and the diseases peculiar to the puerperal state. To enter into details of such matters, would be out of place in this work. With regard to parturition itself, it may be interesting to remark, that in a vast majority of cases the labour is what is called 'natural'; that is, the child presents itself in the normal position, and unaided nature completes the delivery within twenty-four hours with safety to the mother and child. Dr Smellie calculated that 990 in 1000 are 'natural' labours; and the later statistics of Dr Collins, based on 15,850 cases, give a similar result—viz., 983 in 1000.

'Unnatural' labour arises either from malformation, disease, or weakness on the part of the mother, or from abnormal conditions of the child; and manual or instrumental aid becomes necessary to prevent the labour from being dangerously prolonged, or—in the more extreme cases—to render delivery at all possible. Of instrumental applica-

tions, by far the most important and frequent is that of the Forceps (q. v.), which is not intended to injure either mother or child. In 123,295 cases of labour attended by British practitioners, there were 342 forceps cases, or 1 in 360; of these, about 1 in 21 proved fatal to the mother, while 1 child in 4 was lost. In Craniotomy, the head of the child is intentionally destroyed, with a view to save the life of the mother, the death of both being otherwise inevitable. Among British practitioners, this operation is not often resorted to; it proves fatal to about one mother in 5½. See also **CÆSAREAN OPERATION**.

History.—From all the passages in the Scriptures where midwifery is referred to, it is plain that women were the only practitioners of this art amongst the Hebrews and the Egyptians (see Gen. xxxv. 17, and xxxviii. 28, and Ex. i. 15—21), and it is equally certain that the Greeks and Romans confided this branch of medicine to women. Phanarete, the mother of Socrates, was a midwife; and Plato explains the functions and mentions the duties undertaken by these women. The Greek and Roman physicians were not ignorant of midwifery, for Hippocrates refers to the necessity of turning the child in certain cases, although his doctrines on this point, as also on the management of the placenta, are replete with danger; and Celsus, nearly four centuries later, treats of the mechanism of labour with great clearness. A gradual increase in the knowledge of this subject may be traced in the writings of Aëtius and Paulus Ægineta, who advocates the operation of craniotomy in certain cases. Rhazes seems to have been the first to advocate the rupture of the membranes, when, by their toughness, they impede labour; and Avicenna gave the first description of an instrument partially resembling the more modern forceps.

At the commencement of the 16th c., Eucharius Rhodion published a little book, which soon acquired a great celebrity. It was translated from the original High-German into Latin, French, and English, and is remarkable as being the first book published on this subject in England. Its title is, *The Byrth of Mankynde, otherwise named the Woman's Book*, by Thomas Raynold, Physician (London, 1540), and it contains no external evidence that it is a mere translation. In 1573, Ambrose Paré published a small work, in which he shewed that foot-presentations were not dangerous, and that in mal-presentations it was better to deliver by the feet than to attempt to bring down the head.

In the early part of the 17th c., the *sage-femme* (the French term corresponding to our English midwife) of Marie de Medicis published a collection of observations on midwifery. About this time (probably about 1640), Dr Paul Chamberlen, an English physician, invented* the forceps with separate blades, such as are now used. The Chamberlen family (the father and three sons) did not, however, publish their discovery; considering that they had a right to use the secret in the way most to their own advantage; and the exact nature of their instruments was not known till 1815, when the tenant of a house near Maldon, in Essex, where Dr Peter Chamberlen, one of the sons, had resided more than a century previously, accidentally discovered a concealed space, in which were, *inter alia*, a collection of obstetric instruments, including a double-bladed forceps and a vectis, which are now in the possession of the London

* The exact date of this important invention is not known, but in 1647, Dr Peter Chamberlen published a pamphlet entitled *A Voice in Rhama*, in which he speaks of his father's (Dr Paul Chamberlen) discovery for the saving of infantile life. Hence the forceps must have been invented in the first half of the 17th century.

Medico-Chirurgical Society. Although Chamberlen's celebrated *arcamum* was doubtless the double-bladed forceps, he seems, therefore, also to have been the discoverer of the vectis or lever. In 1668, Mauriceau's Treatise appeared, which ran through seven editions, and was for a long time the standard work on the subject. He gives a very full account of the process of labour; and his book having been translated into English, in 1672, by Hugh Chamberlen, became widely known in this country. This seems to have been the time when men began to engage generally in the practice of midwifery; Harvey, the Chamberlens, and others, taking it up in England; while La Vallière, the mistress of Louis XIV., did much to establish the practice in France, by employing Julian Clement, a surgeon of high reputation, in her first confinement in 1663.

The last point requiring notice in the history of midwifery in the 17th c., is the discovery of the use of ergot of rye in accelerating parturition. In 1688, Camerarius stated that midwives in some parts of Germany were in the habit of employing it for this purpose; but it is not till 1774 that we find any further reference to the use of this drug.

In the early part of the 18th c., different varieties of forceps, closely resembling Chamberlen's instrument, were invented by Giffard, Chapman, and others; Chapman being, as it is believed, the first public teacher of midwifery in London. About the middle of this century, lived Sir Richard Manningham, who devoted himself to this branch of the profession, and established a small hospital for the reception of parturient women, which was the first of the kind in the British dominions. It is scarcely necessary to enter into further historical details, as midwifery was by this time fully recognised as a branch—although then and long subsequently, considered as the lowest branch—of medicine. The names of Smellie, William Hunter, Denman, and Bland in England, and of Astruc and Baudeloque in France, are well-known as promoters of various departments of the art of midwifery towards the close of this century.

In the present century, the art of midwifery has steadily progressed. The by-laws precluding practitioners in midwifery from the Fellowship of the London College of Physicians, and other equally offensive rules in other institutions, have been repealed; there are professors of, or lecturers on midwifery in all our medical schools (excepting at the universities of Oxford and Cambridge); and a knowledge of this department of medicine is now required from every candidate for the medical profession. And not only are the members of the medical profession compelled to be as well versed in midwifery as in medicine or surgery, but the ignorant midwives of past times are now replaced by comparatively well-educated nurses, with diplomas, certifying that they have regularly attended lectures on midwifery, and have taken personal charge of a certain number of labours, under the superintendence of a qualified teacher. And that properly educated women are capable of undertaking all the responsibilities of this department of practice, is shewn by such cases as those of Mesdames Boivin and Lachapelle, who (to use the words of Professor Velpeau), 'although the pupils of Baudeloque, were not afraid to shake off, to a certain extent, the yoke of his scientific authority, and whose high position and dignity form the starting-point of a new era for the science of obstetrics in Paris.'

MIGNET, FRANÇOIS AUGUSTE ALEXIS, a French historian, was born 8th May 1796, at Aix in Provence, studied law in his native city along with Thiers, and went to Paris in 1821, to devote himself to a literary life. He found employment in writing for

the public journals, and having given lectures on Modern History, which were received with great approbation, he was induced to write his *Histoire de la Révolution Française* (2 vols. Par. 1824; 10th edition, 1840), a work in which that great event is regarded less in its moral than its philosophical aspects. It has therefore been reproached with leading to fatalism. His style is brilliant, but academic. After the revolution of 1830, he became a Counsellor of State, and Keeper of the Archives of the Ministry of Foreign Affairs; but lost these offices in 1848, since which time he has lived in retirement. He has edited *Négociations relatives à la Succession d'Espagne sous Louis XIV.* (4 vols. Par. 1836—1842), to which he prefixed a masterly historic introduction. Among his later works are *Histoire de Marie Stuart* (2 vols. Par. 1851), and *Charles Quint, son Abdication, son Séjour et sa Mort au Monastère de Yuste* (1854). For more than thirty years, he has been engaged on a *Histoire de la Réforme, de la Ligue et du Règne de Henri IV.*, in the preparation of which he is said to have collected hundreds of volumes of manuscript correspondence.

MIGNONETTE (*Reseda odorata*), a plant of the natural order *Resedaceæ*, a native of the north of Africa, in universal cultivation on account of the delicious fragrance of its flowers. It is, according to circumstances and the mode of cultivation, an annual or a perennial, and even half-shrubby plant, with lanceolate entire or trifid leaves, and erect terminal racemes of small whitish flowers, which have the calyx 6-parted, and as long as the corolla; the capsules 3-toothed. It is to be seen during summer in almost every garden, and during winter in almost every green-house in Britain; it is often cultivated in flower-pots in apartments, and no flower is so common in the boxes which are placed outside of windows in towns. Yet it was first introduced into England by Lord Bateman, who brought it from the Royal Garden at Paris in 1752; nor had it then been long known in France. It rapidly became a universal favourite throughout Europe. The French name *M.*, now its popular name everywhere, signifies *Little Darling*. What is called *Tree M.*, is not even a distinct variety, but merely the common kind trained in an erect form, and prevented from early flowering by pinching off the ends of the shoots.—Weld (q. v.) belongs to the same genus.

MIGRATIONS OF ANIMALS, which must not be confounded with their diffusion over a more or less extended area, are apparently always guided by an instinct operating on all, or nearly all, the individuals of a species, and leading them to move in a definite direction in search of food or (in the case of fishes) of a fit position for spawning.

Among mammals, such migrations are comparatively rare. The most remarkable instance is that of the Lemmings, which at no definite epochs, but generally once or twice in a quarter of a century, traverse Nordland and Finnmark in vast hosts, ending their career in the Western Ocean, into which they enter, and come to a suicidal end; or, taking a direction through Swedish Lapland, are drowned in the Gulf of Bothnia. M. Martins, who was a member of the great scientific Scandinavian expedition, seems to doubt the generally entertained view of these animals casting themselves into the Western Ocean, and believes that most of them perish from the cold in crossing the rivers, while many are killed by dogs, foxes, and a species of Horned Owl (*Strix brachyotos*), which in large numbers always accompanies these emigrations.

According to Gmelin, the Arctic Fox (*Vulpes lagopus*) always accompanies the lemmings in such

numbers that, on this ground, it is entitled to be considered a migratory animal; but independently of these special migrations, it is stated by Sir James Ross that 'the young generally migrate to the southward late in the autumn, and collect in vast multitudes on the shores of Hudson's Bay; they return early the following spring to the northward, and seldom again leave the spot they select as a breeding-place.'

The Spring-bok (*Antidorcas Eucore*) is accustomed to make pilgrimages from one spot to another in the vast plains of Southern Africa. Herds of many thousands are led by their chiefs in these migrations, and the wonderful density of the moving mass may be imagined from the fact, that a flock of sheep has been inextricably entangled and carried along without the possibility of escape. Want of water is said to be the cause of these migrations, but Dr Livingstone thinks that there must be other causes.

The occasional incursions of wolves, in very severe winters, into districts in which they are not commonly found, and the long excursions of large groups of monkeys (*Entellus* and *Rhesus*), hardly fall within the scope of this article.

Many of the cetacea are probably migratory. 'The migrations of the Porpoise (*Phocaena communis*) appear—says Marcel de Serres in his prize-essay, *Des Causes des Migrations des divers Animaux*, p. 63—to be as periodic as those of certain species of birds. During the winter, they constantly proceed from north to south; and when they feel the warmth of summer, they turn northwards. Thus they are common in summer in Greenland, while they are rare on our own coasts, where they abound in winter.'

The number of species of birds that periodically migrate is so great that it is impossible to find space for a list of them. Marcel de Serres, in the work already quoted, gives a 'Tableau de l'Epoque des Passages des Oiseaux,' which extends over nearly 100 pages. See BIRDS OF PASSAGE. The desire for a suitable temperature, and the search for their proper food, are the apparent causes stimulating birds to these migrations; and in most instances, especially in the case of insectivorous birds, the food is intimately associated with the temperature.

The migrations of many species of fishes are as remarkable for their regular periodicity as those of birds. In some cases, fishes that are produced in fresh-water streams migrate to the ocean, and after spending some time in salt water, return (generally, with singular instinct, to their own birthplace) to fresh water to propagate their species. Some of these fishes—as, for example, the Lamprey (*Petromyzon marinus*)—spend most of their lives at sea, and others, as the salmon, in fresh water. The remarkable migrations formerly, but erroneously supposed to be made by herrings, are noticed in the article on that fish. Many fishes of the same family as the herring, the *Clupeidae*—as, for example, the sprat and pilchard—leave the deep sea for shallow water during the spawning period, when they approach our coasts in vast shoals. All such migrations as these seem mainly due to a reproductive impulse. See FISHES, LAND-CRAB.

Amongst insects, the Locust (*Locusta migratoria*) is most remarkable for its migrations. These insects are probably produced much more abundantly some years than others, and as in such years their birthplace cannot afford them sufficient vegetation, they are led to migrate in search of food. Some idea of the occasional extent of their wanderings may be formed from the fact that, in the early part of 1810, myriads of locusts appeared in Bengal, from whence they proceeded westward completely across the

great Indian peninsula to Guzerat and the neighbouring provinces, from whence they pursued their course southwards towards Bombay, the whole period of their migration extending over between two and three years; while, in relation to their numbers, Captain Beaufort calculated a swarm that appeared at Sardinia, in Asia Minor, in 1811, at upwards of 168,000,000,000,000.

MIGUEL, DOM MARIA EVARIST, born at Lisbon 26th October 1802, was the third son of John VI. of Portugal. He spent his early years in Brazil, unrestrained and uneducated. When he returned with the royal family to Portugal in 1821, he could neither read nor write, and shewed no talent for anything but fencing. He joined his mother, Charlotte Joachime of Spain, in her plots for the overthrow of the constitution and the establishment of a despotic government; part of the scheme being, that his weak father should be either formally deposed, or virtually deprived of all power. The aged Marquis de Loulé, the faithful servant of the king, having been removed out of the way by assassination, M., as Infant-generalissimo, caused the ministers to be arrested, 30th April 1824, and his father to be closely watched in his palace; but the plot failed, and M. and his mother were banished. He led for some time a remarkably wild and profligate life in foreign countries. After the death of his father in 1826, the queen's party set forth a claim to the throne on his behalf, as his elder brother, Dom Pedro, was emperor of Brazil; and on 2d May 1826, Pedro resigned the crown of Portugal in favour of his eldest daughter, Donna Maria da Gloria, proposing that her uncle Miguel should be her husband, and regent of the kingdom till her majority, to all which M. agreed. But Queen Joachime's party had everything prepared for the restoration of absolutism. M. was declared king of Portugal. War ensued, and at first M. was victorious. He carried into full effect the principles of his party by a system of the most severe repression of all liberalism, and signalised himself by the most extreme tyranny of every kind, whilst his own life was one of the wildest excess. In 1832, Dom Pedro took Oporto, and his arms gradually prevailing, M. was obliged to sign a capitulation at Evora, on 26th May 1834, by which he resigned all claim to the throne of Portugal, and agreed to retire altogether from the country. But scarcely had he been conveyed to Genoa, when he protested against this deed, and consequently all his estates in Portugal were confiscated, and an annual pension which had been secured to him was stopped. He went to Rome, where the papal government acknowledged him as rightful king of Portugal, solely because he had petted the Portuguese priesthood in his war against the national liberties. Latterly he lived at the castle of Bronnbach, in Baden, where he died Nov. 1866.

MIKLOSICH, FRANZ, the most learned living Slavist, was born at Luttenberg, in the Slavic part of Styria, 20th November 1813. After studying law at the university of Grätz, he went, in 1838, to Vienna to practise as an advocate; but in 1844 obtained a situation in the Imperial Library, which was more congenial to his tastes. In 1850, he was appointed Professor of Slavic in the High School of Vienna. His principal works are—*Radices Linguae Palaeoslovenicæ* (Leip. 1845); *Lexicon Linguae Palaeoslovenicæ* (Vienna, 1850); *Vergleichende Grammatik der Slav. Sprachen* (Vienna, first vol. 1852), a work which has done for Slavic what the works of Grimm and Diez have done for the German and Romanic languages.

MIKNAS, ME'QUINEZ, or MEKNAZA, a town in the province of Fez, in Morocco, 38 miles

west-by-south from the town of Fez, stands in a fertile valley near the Sebu. It is surrounded by triple walls, and a moat, is neat and well built, and contains the finest imperial palace in Morocco. This vast pile, erected by the Sultan Muley Ismail, is built of marble, and the surrounding grounds are laid out in gardens, said to be the most beautiful in Morocco, and here and there adorned with fountains. M. is the summer residence of the sultan. Pop. estimated at from 15,000 to 55,000, who carry on an extensive trade in native produce. The chief manufactures are of painted earthenware and leather. In the vicinity, are large plantations of olives.

MILAN (Ital. *Milano*), the chief city of Lombardy, stands on the river Olona, in the centre of the great plain of Lombardy, and including the suburb of Corpi Santi, had a population (1862) of 242,457. From its position, it derives great commercial advantages, being situated on the line of the chief routes of the central Alps, while its fine canal-system opens for it communication with the principal rivers of Italy. The *Naviglio Grande*, or Grand Canal, connects M. with the Ticino, and the Martesana Canal with the Adda. The city, which is almost circular, is encompassed on three sides by walls and low ramparts; it has a circuit of about 7½ miles, and is entered by 10 gates. Notwithstanding its great antiquity, M. possesses but few remains of its early splendid structures, in consequence of the many calamitous wars by which it has been ravaged. Modern M. is one of the most opulent and populous cities of Italy; its best streets are regular, wide, and well paved, and kept with scrupulous care; the dwellings are commodious and tasteful, though of a less imposing character than the great feudal Tuscan houses. M. abounds in churches worthy of note: of these, the principal is the famous Gothic cathedral, the *Duomo*, which, with the exception of St Peter's in Rome, is the most magnificent ecclesiastical structure of Italy. It has a façade of white Carrara marble, and is adorned by 106 pinnacles, and 4500 statues, besides a variety of carvings of unsurpassable beauty. In form, it is a Latin cross, with a length of 485, and a breadth of 252 feet. The height of the dome is 355 feet. Its foundation was laid in 1386 by Gian Galeazzo Visconti, and during its erection, many of the greatest European architects contributed designs for its embellishment. Within it, Napoleon was crowned king of Italy in 1805. Besides the *Duomo*, may be mentioned the church of St Ambrose (founded by that saint in the 4th c.), the most ancient in M., containing inscriptions, sarcophagi, and monuments full of antiquarian interest, and the one in which the German emperors were crowned kings of Italy; the Dominican church of *Santa Maria delle Grazie*, which contains in its refectory the famous 'Cenacolo,' or 'Last Supper,' by Leonardo da Vinci; and that of San Carlo Borromeo (1847); of St Nazaro, which possesses several master-pieces of the best schools of Italian art; and of St Sebastiano, once a Roman temple.

Among the secular buildings of M., the most noteworthy is the magnificent Brera Palace, formerly a Jesuit college, and now used for public schools of the fine arts, with the official name of Palace of Arts and Sciences. Within its vast precincts, this unique institution includes an academy of art, a choice gallery of paintings, of the Bolognese and Lombard schools, a fine collection of casts for modelling purposes, a splendid public library, containing 140,000 volumes, and a rare collection of manuscripts, medals, and antiquities; it has also attached to it an observatory and a botanical garden. Besides the Ambrosian (q. v.), there are several large private libraries. Among the scientific and artistic institutions of M.

are the Museum of Natural History, the schools of surgery and medicine, especially that of veterinary practice, the celebrated Conservatory or school of music, and a military geographical institute, well known for the excellence of the maps it has issued. The educational establishments include four gymnasia, besides normal schools, technical schools, conventual schools, and a seminary. The charitable institutions are numerous and splendidly endowed, having an aggregate property of upwards of £7,000,000 sterling; the *Ospedale Maggiore*, or Great Hospital, founded by the ducal house of Sforza in 1456, accommodates 2000 patients, and annually admits upwards of 20,000. The Trivulzi Hospital, endowed by the Trivulzio family, maintains and clothes 600 aged pensioners. The Milanese places of amusement are on as grand a scale as the other public buildings of the city, the first in point of celebrity being the theatre of *La Scala*, which can accommodate 3600 spectators. The *Corso*, or chief street of M., is the universal fashionable promenade of the inhabitants; and the famous arcade, or *Galleria di Cristoforo*, with its brilliant shops and cafés, is also a favourite place of evening resort, and on account of its gay appearance has been called 'Little Paris.' M. carries on an immense inland trade in silk, grain, rice, and cheese, and has considerable manufactures of silk goods, ribbons, cutlery, and porcelain.

M. (Lat. *Mediolanum*) was originally a town or village of the Insubrian Gauls. It was conquered by the Romans 222 B. C., received the Latin franchise about 89 B. C., and the full Roman franchise 49 B. C. Under the Romans, it became a conspicuous centre of wealth and civic influence; its citizens were noted for their refined manners and literary tastes, and the public buildings for their beauty and elegance. In the beginning of the 4th c., it was selected as the residence of the imperial court by Maximian. M. was sacked by the Huns (under Attila) in 452, by the Goths (under the brother of Vitiges) in 539, and passed to the Longobards and Franks previous to its subjection by the German empire. After 961, it was long governed by dukes in the name of the emperors. The feuds of the Guelphs and Ghibellines distracted M., like all the other Italian cities. Supreme power became eventually vested in the Ghibelline Visconti, by whom the ascendancy of M. was extended over the whole of Lombardy. From 1545 to 1714, M. submitted to the successive predominance of France and Austria. Under Bonaparte, it was declared the capital of the Cisalpine Republic, of the Italian Republic, and, finally, of the Kingdom of Italy. In 1815, M. was restored to Austria, and continued the capital of the Austro-Italian kingdom until the annexation of Lombardy to Piedmont, in 1859, by the peace of Villafranca.

MILA'ZZO (anc. *Mylæ*), a fortified seaport on the north coast of the island of Sicily, 18 miles west of Messina. Pop. 8000. Situation unhealthy. Chief exports, tunny, wine, silk, fruits, corn, oil, and liqueurs. The town is irregularly built, and is considered almost impregnable, owing to the great natural strength of its position and the extent of its military works and citadel. Garibaldi, with 2500 men, defeated 7000 Neapolitans here on the 20th of July 1860, and compelled the garrison to evacuate the fortress.

MILDEW (Ger. *Mehltau*, meal-dew), a term of somewhat vague application to certain diseased states of plants caused or characterised by the growth of small parasitical fungi, and also to spots on cloth, paper, &c., and even on the surface of glass and other inorganic substances, produced by

the growth of minute fungi. The mildew fungi are numerous, and the name mildew is often given to many that are also known by other names, as BLIGHT, BRAND, BUNT, RUST, &c.; see these heads; see also BOTRYTIS and OIDIUM. Different species or families of plants have their own peculiar parasites; several kinds of parasitic fungus being, however, often known to infest one plant. Probably, the name mildew originally belonged to those moulds which form white mealy patches on leaves. Some of these belong to the genus *Erysiphe*, which exhibits fleshy somewhat gelatinous masses, becoming globose *sporangia*, filled with spore-containing *asci*, and surrounded by a flocky *mycelium*, often spreading widely over the leaves and other parts of plants. Maples are sometimes covered with a mildew of this kind, so as to be quite hoary. Similar mildews are often seen on pease and other leguminous plants; also on umbelliferous plants. Sulphur has been found effectual in curing some of these mildews.—Many of the most destructive mildews are of a red or brown colour, as the mildew of the pear, *Aecidium cancellatum*, that of the barberry, *Aecidium Berberidis*, &c.; whilst some are almost black, as the corn mildew, *Puccinia graminis*, by which the crops are in some years greatly injured.

Whether mildew is the consequence of unfavourable weather and of fungi attacking an already weakened plant, or is the consequence of infection by spores of fungi brought through the air or soil to a plant previously healthy, is not yet well ascertained; and probably the one may be sometimes the case, and sometimes the other. There is no doubt that many kinds of mildew appear chiefly towards the close of summer on leaves in which vegetable life has already in a great measure lost its power.

MILE, the largest terrestrial measure of length in common use among the British and most continental nations, is derived from the Roman *milliare*, which contained 1000 paces (*mille passuum*) of 5 Roman feet each, the pace being the length of the step made by one foot. The Roman foot being between 11.65 and 11.62 English inches, the Roman mile was thus less than the present English mile by from 142 to 144 yards. The length of the modern mile in different countries exhibits a remarkable diversity, not satisfactorily accounted for. Before the time of Elizabeth, scientific writers made use of a mile of 5000 English feet, from the notion that this was the Roman mile, forgetting the difference in value between the English and Roman foot. The present statute mile was incidentally defined by an act passed in the 35th year of the reign of Elizabeth to be '8 furlongs of 40 perches of 16½ feet each'—i. e., 1760 yards of 3 feet each; and it has since retained this value. The *geographical or nautical mile* is the 60th part of a degree of the equator, and is employed by the mariners of all nations; but in Germany, the geographical mile denotes $\frac{1}{4}$ th part of a degree of the equator, or 4 nautical miles. The following table gives the length, in English statute miles, of the various miles that have been or are commonly used:

	Eng. Miles.
English geographical mile,	= 1.153
German geographical mile,	= 4.611
Tuscan mile,	= 1.097
Ancient Scotch mile,	= 1.187
Irisl mile,	= 1.273
German short mile,	= 3.997
Prussian mile,	= 4.680
Danish mile,	= 4.684
Hungarian mile,	= 5.178
Swiss mile,	= 5.201
German long mile,	= 5.753
Hanoverian mile,	= 6.668
Swedish mile,	= 6.648
The French kilomètre,	= 0.621
and 29 kil. = 18 English statute miles nearly.	

MILETTUS, anciently, the greatest and most flourishing city of Ionia, in Asia Minor. It was situated at the mouth of the Mæander, and was famous for its woollen manufactures, and for its extensive trade with the north. Before being forcibly colonised by the Ionians, it appears to have been inhabited by Carians. M. early founded a number of colonies on the Black Sea and in the Crimea, possessed a fleet, which sailed to every part of the Mediterranean, and even ventured into the Atlantic, and maintained long and expensive wars with the Lydian kings. The 'Milesians' were believed to be the purest representatives of the Ionians in Asia. After the conquest of Lydia by the elder Cyrus, it was subdued with the whole of Ionia. It continued, however, to flourish till it was excited to rebellion against the Persians in the Ionian war, and was destroyed 494 B.C. It was rebuilt, but never reacquired its former importance. M. has an honourable place in the history of Greek literature, being the birthplace of the philosophers Thales, Anaximander, and Anaximenes, and of the historians Cadmus and Hecataeus.

MILFORD, a parliamentary borough (contributory to Pembroke) and seaport of South Wales, in the county of Pembroke, on the north shore of the Haven of the same name, 7 miles east-north-east of St Ann's Head. The Haven is said to be unequalled as a harbour by any other in the world. It is formed by an estuary running inland for 17 miles to Langwin (which is easily reached by vessels of 2000 tons), and varying from 1 to 2 miles in breadth. It is protected from winds by a girdle of undulating hills, is deep (from 15 to 19 fathoms in most parts, while the spring-tides rise 25 feet), easy of access, and capable of anchoring the whole fleet of England in safety. Its distance, however, from the Channel, the highway of British commerce, is a serious disadvantage. The merits of the Haven have been recognised from the earliest times; but the rise of the town of M. may be said to have begun with the present century, when docks and quays, together with a mail packet-station for Ireland, a dockyard, ship-building slips, and an arsenal, were established here, only, however, to be removed in 1814. Since that time, with only occasional gleams of prosperity, M. has been in a declining condition; but the recent opening of the Milford Railway, and the construction of docks and wharfs to be commenced forthwith, will doubtless give an impetus to its progress. It has recently become a favourite resort for sea-bathing, and is evincing signs of improvement generally. In 1862, 2701 vessels, of 370,319 tons, entered and cleared the port. Pop. (1861) 3007.

MILFORD, a village of Massachusetts, United States of America, 34 miles south-west of Boston, having 6 churches, a manufactory of machinery, and large boot and shoe manufactures. Pop. (1860) 9132.

MILHAU, or MILLAU, a town of France, in the department of Aveyron, in a rich and fertile dale on the right bank of the Tarn, 55 miles north-west of Montpellier. During the 16th and 17th centuries, it was one of the strongholds of the Calvinists. Leather and gloves are manufactured, and there is a good trade in wool, timber, hides, cheese, and wine. Pop. 11,250.

MILITARY ACADEMY, ROYAL, an establishment at Woolwich, through which must pass all candidates for the Royal Artillery and Royal Engineers. The age for entrance is 16, and the vacancies are open to public competition. The pupils are denominated military cadets, and the parents or guardians have to make a considerable

payment in regard to each, so long as they remain at the Academy; the annual charge for the son of a civilian being £120, that for the son of a naval or military officer less, according to the rank of the father. When the term of instruction—which comprises the subjects of a thorough general education, the higher mathematics, fortification, gunnery, and military duty—is completed, the cadets compete for the vacancies in the Engineers and Artillery, those who pass the best examination being allowed the refusal of the former corps. Those who obtain commissions in the Engineers proceed to Chatham for further instruction (with military pay, however) in their professional functions. The Artillery cadets at once join the Royal Artillery as lieutenants. The vote for the Royal Military Academy for the year 1863—1864 is £41,872, of which sum about one-half will be made up to the Exchequer by the payments for pupils and a contribution from the Indian government.

MILITARY ASYLUM, ROYAL, an educational government institution at Chelsea, near, but wholly distinct from, the Royal Hospital for Pensioned Soldiers. Its object is the suitable education for trade, &c., of 500 male children—generally orphans—of British soldiers. For these, there are a model school and an infant school, and the boys have a completely military organisation, with scarlet uniform, band, &c. As a result of their training, a large proportion of the pupils ultimately volunteer into the army. The school was originally established in 1803 by the late Duke of York, whence it is still commonly known as the 'Duke of York's School.' Originally a similar school for soldiers' daughters was included, but was not found to answer, and has been discontinued. Attached to the school is a training establishment for military schoolmasters, known as the Normal School. The total cost of the whole institution is about £14,500 per annum.

MILITARY FRONTIER (Ger. *Militärgrenze*), a border crown-land of the Austrian empire, is bounded on the N. by Croatia, Slavonia, and the Wojwodschaff; on the E. by Transylvania and Wallachia; on the S. by Turkey and Dalmatia; and on the W. by the Adriatic. Area, 12,800 square miles; pop. 1,064,922. In lat. it extends from 44° 18' to 46° 45' N., and in long. it may be said to reach from about 15° to about 23° E. The breadth of the crown-land, which is considerable at the eastern and western extremities, diminishes to only a few miles in the centre. The western division has an average elevation of upwards of 2000 feet; and the western coast, for the distance of 74 miles, is occupied by sharp naked rocks. Toward the east, the land declines, and all the important rivers—of which the Danube, the Unna, and the Save are the chief—flow eastward. The climate is severe in the highlands in the west, but mild in the lower districts towards Slavonia. Of the whole surface, 9702 square miles are under cultivation; and maize, wheat, oats, fruits, and vegetables, are the principal productions. Cattle-rearing is not pursued to any very great extent, and the mineral riches of the crown-land are not of very great importance.

The M. F. owes its origin as a crown-land to the necessity of having a permanent body of defenders on the borders during former wars, and especially during wars with the Turks. In the 15th c., the Austrians had gained from the Turks certain tracts of territory on the banks of the Save and Danube. These tracts they colonised, making it, however, a condition that the colonists must render military service against the Turks. Thus originated the Capitanate of Zeugg, during the reign of Mathias

Corvinus. The Warasin Frontier originated in the same manner under Ferdinand I. In the 17th c., the Petrinier Frontier, which at a later period received the name of the Banat Frontier, was erected. The military stations along the frontier serve a threefold purpose—the defence of the country, the prevention of smuggling, and the prevention of the spread of contagious disease into the territories of the Austrian empire. The inhabitants of this crown-land enjoy peculiar privileges. Their immigrant ancestors received only the temporary use of lands consigned to them; but in 1850, a law was passed making over the land to the occupiers as their own property. This right of property does not belong, however, to individuals, but to the family in a united sense. The oldest member of a family (called the *Hausvater*) is intrusted with the management of the land; his partner (the *Hausmutter*) ranks equal with him, and they each receive a double share of the profits for the year, as recompense for the management of the estate. A family of this sort is called a Border-house (*Grenzhaus*). All who are able to bear arms are sworn to the service from their 20th year. The soldier of the frontier, who is clothed as well as armed and supplied with ammunition by government, finds it his duty not only to watch and protect the frontier, but to preserve peace and order in the interior, and to go on foreign service when required. Only the smaller portion of the forces of the M. F. is retained in readiness for active service, while the remainder pursue their ordinary employments. To facilitate the accomplishment of the purposes aimed at by the M. F., the *cordon*, a series of guard-houses along the whole frontier, affording accommodation to from four to eight men, as well as larger ones, accommodating twelve men and a junior officer, has been instituted. Within this line are the officers' posts. Without announcing himself at the posts, no one is allowed to pass the boundary; and after permission is given, the passenger must remain a longer or shorter time at the quarantine establishment, in order that all introduction of disease may be prevented.

MILITARY ORDERS, religious associations which arose from a mixture of the religious enthusiasm and the chivalrous love of arms which almost equally formed the characteristics of mediæval society. The first origin of such associations may be traced to the necessities of the Christian residents of the Holy Land, in which the monks, whose first duty had been to serve the pilgrims in the hospital at Jerusalem, were compelled, by the necessity of self-defence, to assume the character of soldiers as well as of monks. See JOHN (St), KNIGHTS OF. The order of the Templars (q. v.) was of similar origin. Those of Alcantara and Calatrava in Spain had for their immediate object the defence of their country against the Moors. These orders, as well as that of Avis in Portugal, which was instituted with a similar view, followed the Cistercian rule, and all three differed from the Templars and the Knights of St John in being permitted by their institute to marry once. The same privilege was enjoyed in the Savoyard order of Knights of St Maurice and the Flemish order of St Hubert. On the contrary, the Teutonic Knights, who had their origin in the Crusades (see GRAND MASTER), were bound by an absolute vow of chastity. With the varying conditions of society, these religious associations have at various times been abolished or fallen into disuse; but most of them still subsist in the form of orders of knighthood, and in some of them, attempts have recently been made to revive, with certain modifications, the monastic character which they originally possessed.

MILITARY SCHOOLS—MILITARY TRAIN.

MILITARY SCHOOLS, as regards the British army, are divisible into several classes: 1. Those for the education of officers already in the service; of these, there are the Staff College (q. v.), and the establishment at Chatham for training Engineer officers. 2. Professional schools common to officers and men will be found under **GUNNERY, SCHOOL OF, and MUSKETRY, SCHOOLS OF**. 3. Schools for the professional education of candidates for commissions; for these, reference should be made to **MILITARY ACADEMY, ROYAL**, and to **SANDHURST MILITARY COLLEGE**. 4. The schools for men in the ranks and for their children are described under **SCHOOLS, REGIMENTAL**; while the instruction provided for their sons or orphans is shewn under **MILITARY ASYLUM, ROYAL**.

The Military Schools of foreign countries deserve considerable attention, especially those of France, where a military commission is one of the best scholastic prizes looked forward to. In France, no attempt is made to impart general education at the military seminaries; a boy is required to have a thorough general knowledge before he can be admitted to these institutions. Being open to universal competition, and being the only channel—or nearly so—to the best employment under the state, the great military schools, by the high standard required for them, give great impetus to general education throughout the empire, and the Lycées, or public schools, adapt their course of instruction to the anticipated competition. In the army, two-thirds of the line commissions, and one-third of those for the scientific corps, are given to non-commissioned officers, but very few of these rise beyond the rank of captain; the remaining commissions in the line and scientific corps, and all appointments to the staff, are given by competition, after a careful course of professional education. The candidates in open competition are placed according to merit either in the Infantry School of St Cyr, or the celebrated Polytechnique; at both colleges, they have the right, if they need it, to partial or entire state support. From the School of St Cyr, the more promising pupils pass to the Staff School, and thence, after a thorough course, to the *Etat Major* of the army; the remaining students pass as subalterns into the line. The pupils of the Polytechnique, which is entered after the age of 17 years, have annually about 160 valuable prizes open to them. The first 30 to 40 candidates usually select civil employment under the crown, such as the '*Ponts et Chaussées*;' those next in merit choose the Artillery and Engineers, and pass through a technical course at the School of Application at Metz. The remaining students either fail to qualify, and leave the school, or have to content themselves with commissions in the line, subordinate situations in the government, civil or colonial service, or they retire into civil life altogether.

In actual service, there are schools for the men, who are also taught trades and singing. The standard of education among French soldiers is far higher than among their English brethren, as the conscription draws the men from all classes of society.

The Prussian system of military education differs from that of France in that competition is but sparingly resorted to; and the object is to give a good general and professional education to all the officers, rather than a specially excellent training to a selected few. Aspirants for commissions must enter in the ranks, and within six months pass a good examination in general and liberal knowledge; if, however, the candidate has been educated in a cadet-house—which is a semi-military school for

youths—and has passed properly out of it, this examination is dispensed with. After some further service, the aspirant goes for nine months to one of three 'Division Schools,' where he completes his professional education. If he pass the standard here required, he is eligible for the next vacancy, but cannot be commissioned, unless the officers of the corps are willing to accept him as a comrade. The Artillery and Engineer schools do for those services what the Division Schools do for the line. The culmination of Prussian military education is the Staff School, open to competition for all the officers of the army, and presenting the highest prizes in the profession. In all the schools, the candidates study at the expense of the state, or receive great auxiliary grants.

The Austrian system is very elaborate, and commences at an early age—boys intended for military service beginning their professional, almost contemporaneously with their general education. There are schools for training for non-commissioned officers and for officers; and senior departments for imparting more extended instruction to both classes. Candidates for appointment as non-commissioned officers pass by competition through the lower houses, where they remain till 11 years old; the upper houses, which detain them till 15; and the school companies, whence, after actual apprenticeship to service, a few pupils pass to the academies for aspirants for commissions, and the others are draughted into the service as non-commissioned officers. For officers, boys are pledged to the service by their parents at the age of 11, when they are placed in cadet-schools; after which, the state takes charge of them. At about 16, the boys pass, according to qualification, to the line or scientific corps academies; and four years later, into those services themselves. The young officer's chance of entering the Staff School—and therefore the staff—depends upon his place at the final academic examination. The competition observed throughout the course of military education is said to impart great vigour to the tuition.

In the Italian army, the system so nearly approaches that of France, that a separate description is unnecessary. It need only be stated that the educational status of the Italian officers is considered high.

MILITARY SECRETARY, an officer on the personal staff of generals in high command. His duties are to conduct the correspondence of his chief, and to transact a great amount of confidential business, which would dangerously occupy the time of the general himself. The military secretary to the Commander-in-Chief at the Horse Guards receives £2000 per annum, and is usually a general officer. To a commander-in-chief in the field, he is for the most part below that rank, and receives only the staff pay of £346, 15s.; while to a general commanding a division only, an *Assistant Military Secretary*, at £173, 7s. 6d. per annum, is allowed. This staff pay is of course additional to the officer's regimental or unattached pay.

MILITARY TRAIN, a highly important corps of the army, of which the function is to transport the provisions, ammunition, and all other matériel, together with the wounded in time of battle. It was formed after the Crimean war, on the dissolution of the Land-Transport Corps (q. v.). It at present (1863) comprises six battalions, in all 1840 officers and men; and its annual cost for pay, &c., is £71,331. The corps ranks after the Royal Engineers, and is classed as Mounted Infantry, the officers receiving infantry rates, and the men cavalry rates of pay. The commissions have, to

this time, been purchasable as in the line, and officers can exchange between the Military Train and other purchase regiments; but the corps is now in course of being gradually transformed into a seniority corps, as the Artillery and Engineers. The men are armed with carbine and sword, but rather for defensive than aggressive purposes. Attached to each battalion are 160 horses, with proportionate wagons and ambulances.

It is proper to observe that the Military Train constitutes only the nucleus of a transport service for a large army, and that in time of war it would be expanded by the addition of thousands of horses or mules, and the incorporation of many hundred drivers, &c. The advantage of possessing even a few men ready trained, and capable of directing the movements of others, was amply demonstrated by the failures of the Crimea in 1854—1856; so that parliament votes ungrudgingly the expense of this corps, although in time of peace it is comparatively without employment.

MILITELLO, a city of Sicily, in the province of Catania, and 21 miles south-west of the town of that name. Pop. 8000. It stands on a mountain in a somewhat unhealthy situation. In its vicinity there are important salt lagoons.

MILITIA (Lat. *miles*, a soldier) has now the acquired meaning of the domestic force for the defence of a nation, as distinguished from the regular army, which can be employed at home or abroad in either aggressive or defensive operations. Every nation has a reserve, under its law military, upon which its defence would fall, on the discomfiture of the regular army; but the system differs in each country. France has her Gardes Nationaux; Prussia, the Landwehr, &c.; and with the exception perhaps of the United States during peace, none are formed on the model of the British militia.

The militia is a constitutional force raised under the sanction of parliament, in which the people—in theory at least—wage their own bodies for the defence of their own soil, and in which they depute the sole leadership and command to the sovereign and the crown nominees. Organised by counties and cities, it is essentially a local force: the property qualification for its officers connects it with the land, while the command of the sovereign effectually combines in it the interests of the three estates. Under the Anglo-Saxons, all men were required to bear arms, as a sort of body-rent for the land they held; but no special organisation being adopted, efficiency was rarely attained in the use of arms. This the nation found to its cost when the Danes overran it during Alfred's reign. That great king, to prevent a similar occurrence, established the militia or *fyrd*, making land the basis of numbers, but the family system that of discipline: so many families were a tything, ten tythings a hundred, and hundreds were united into county powers, each under its *heretoch*, dux, or duke. Each section of the community had not only to furnish its quota in time of war, but also to provide arms, keep them in repair, and to undergo so many days' training every year. This arrangement subsisted in more or less vigour until the Conquest; then the feudal troops at first rendered the militia unnecessary; but it never ceased wholly to exist. When the crown began to contend with the Norman barons, it naturally found its most powerful instrument in reviving the Saxon militia, and the English yeomanry became thenceforth the fear of England's enemies, and a guarantee for the gradual enfranchisement of the people. Henry II. established 'an assize of arms,' at which every holder of land was bound to produce one or more men fully equipped, and capable of

fighting in the national defence. The arms were annually inspected, and it was illegal to sell, lend, or pawn them. This annual assembly of the *fyrd* or militia is first recorded after the Conquest in 1181; by the statute of Winchester in 1285, Edward I. revised the scale of arms for the several ranks. Further alterations to suit the advances in the art of war took place in 1558 (4 and 5 Ph. and M. c. 2). In 1604, James I. (1 Jac. c. 25) abolished the *fyrd*, and substituted 'Trained (commonly called Train) Bands,' to the number of 160,000 men—a force partaking of the nature of militia and volunteers, but deficient in discipline and drill. During the civil war of Charles I., the train bands or militia mostly sided readily with the parliament. Up to this time, the command had never by any law been definitely assigned to the crown or to any other body. After the Restoration, the loyal parliament of Charles II. immediately reorganised the militia—essentially on its present footing—and declared as law that 'the sole supreme government, command, and disposition of the militia is, and by the laws of England ever was, the undoubted right of his majesty and his royal predecessors.' As, however, the crown from this time began to depend for its support upon a mercenary army, and as the local status of the militia officers must always render the militia a force dependent on parliamentary influence and ties, the militia was much neglected until 1757, when a large portion of the regular army being absent in the Seven Years' War, it was carefully organised for the defence of the kingdom. Several militia acts have been subsequently passed, but rather with a view to consolidating the militia laws of England, Scotland, and Ireland, and to effect minor changes necessary for the growth of the institution, than to remodel in any essential degree the constitution of the force. The acts under which the militia is now organised are the 42 Geo. III. c. 90 and 91; 49 Geo. III. c. 120; 15 and 16 Vict. c. 50; 17 and 18 Vict. c. 13, 105 and 106; and 18 and 19 Vict. c. 57, 100, and 106. The present law stands thus: The sovereign appoints lords lieutenant of counties; each of these in his own county is empowered to appoint deputy-lieutenants, and to call out, embody, and command the militia, for which he selects and appoints the officers. The officers from and above the rank of captain must be men of substance, being required to shew that they are worth £600 a year for colonels, £400 for lieutenant-colonels, £300 for majors, and £200 for captains.

The force to be provided by each county—known as its 'quota'—is fixed by government in proportion to the population, &c. The numbers must be provided in some way. In practice, they are raised by voluntary recruitment; but should volunteering fail, a levy by ballot would be made upon all the inhabitants of the locality between the ages of 18 and 35. The power of making this ballot always exists, and would have by law to be enforced, but for the Militia Ballot Suspension Act, which, when the measure is unnecessary, is passed from year to year. Many classes are exempt from the ballot, as peers, soldiers, volunteers, yeomanry, resident members of universities, clergymen, parish schoolmasters, articulated clerks, apprentices, seafaring men, crown employes, free watermen of the Thames; in England, any poor man with more than one child born in wedlock; in Scotland, any man with more than two lawful children, and not possessed of property to the value of £50; in Ireland, any poor man not worth £10, or who does not pay £5 per annum for rent, and has more than three lawful children under the age of 14.

The militia are bound to assemble annually for

MILITIA—MILK.

28 days, for training purposes; and the government can embody the whole, or part of the force, at any national crisis. The regiments were embodied almost without exception during the Russian war of 1854—1856, and to a considerable extent at the time of the Indian Mutiny, 1857—1859. The quota of the United Kingdom is about 120,000 men, but not above two-thirds of that number can be considered as effective. They may not be sent out of the kingdom, except they volunteer, and then only by special permission of parliament. As a defensive or garrison force, setting free the regular army for aggressive operations, the militia is a most valuable institution; and in times of war, it has ever been found an admirable training-school whence soldiers volunteer into the permanent forces.

A militia volunteer receives bounty, payable partly on joining, and partly in instalments after each training period. When out for training, or embodied for permanent duty, the officers and men receive the same pay as regular troops of corresponding arms of the service, and are under the Mutiny Act and Articles of War, except that no punishment can extend to life or limb. The officers rank with, but junior to, their brethren of the regular army; the great distinction in appearance between regular and militia troops being, that in the former the appointments are all of gold-lace, and in the latter, of silver; the buttons being similarly distinguished. The force is divided into Heavy, Light, Rifles, and Highland Infantry, and into Artillery, the latter being generally limited to coast counties, and being very highly esteemed by the authorities.

The celebrated Local Militia was instituted in England and Scotland in 1808, and suspended in 1816. It consisted of a force for each county six times as numerous as the proper militia quota, comprising, of course, many classes, which, from age or other circumstances, were ineligible for the militia. These troops could only be marched beyond their respective counties in the event of actual invasion. Their numbers reached, in 1811, to 213,000 men.

The present annual cost of the militia (1863—1864) amounts to £751,084 for effective services, and £32,786 for non-effective services. As a constitutional precaution, the estimates were formerly prepared—at least nominally—by a committee of the House of Commons; but as the check was of no real advantage, it was abolished by a resolution of the House in 1863, and thenceforward the Minister of War includes the charge among the many services provided for in his department.

MILK is an opaque white fluid secreted by the mammary glands of the females of the class *Mammalia*, after they have brought forth their young, and during the period in which their offspring are too immature to live upon ordinary food. It is devoid of odour, except for a short time after its extraction; is of a slightly sweet taste, most commonly of a slightly alkaline reaction (except in the *Carnivora*, in which it is acid); and its average specific gravity (in the case of human milk) is 1032.

When milk has been allowed to stand for some time, a thick, fatty, yellowish-white stratum (the cream) forms upon its surface. When this is removed, the fluid below (popularly known as 'skim-milk') is found to be of greater specific gravity, and of a more bluish-white tint. Milk does not coagulate on boiling, but a membrane or film of coagulated caseine, containing fat corpuscles, forms upon its surface. If milk be allowed to stand for some days exposed to air at the ordinary temperature, it gradually begins to exhibit an

increasing acid reaction, from the formation of lactic acid from the milk-sugar; while the caseine becoming coagulated by the action of the lactic acid, is separated in the form of 'curds,' and the fluid gradually assumes the form of a thickish pulp. The ordinary means of obtaining the caseine (which exists in solution in the milk) in the form of curds is by the addition of a piece of rennet (the dried stomach of the calf, which acts as powerfully as any acid. The curds thus separated form the basis of cheese, while the fluid portion left after their removal is known as the 'whey.'

When examined under the microscope, the milk appears as a clear fluid, containing fat globules (the milk globules, as they are usually called) in suspension. They commonly vary from $\cdot 0012$ to $\cdot 0018$ of a line in diameter. They are each invested with a delicate coat of caseine, which prevents their running together. By *churning*, the surrounding envelopes become ruptured, and the contents are made to unite, forming *butter*. In addition to milk globules, colostrum globules (see *COLOSTRUM*), which are irregular conglomerations of very small fat globules, occur in the milk for the first three or four days after delivery.

The following table, which is based on the researches of Vernois and Becquerel, represents the density and composition of 1000 parts of milk in various animals:

	Density.	Water.	Solid Constituents.	Caseine and Sugar in 1000 Parts.	Sugar.	Fat (Butter).	Salts.
Woman,	1032.67	889.08	110.92	39.24	43.64	26.66	1.38
Cow,	1033.38	864.06	135.94	55.19	38.03	36.12	6.64
Mare,	1033.74	904.30	85.70	33.35	38.76	24.36	5.23
Ass,	1034.57	890.13	109.88	35.65	50.46	18.23	5.24
Goat,	1033.83	844.90	155.10	35.14	36.81	56.87	6.18
Ewe,	1040.98	839.32	167.68	69.78	39.43	61.31	7.16
Bitch,	1041.62	772.08	227.92	116.88	16.29	87.93	7.80

The actual caseine which in the preceding analyses is associated with the undefined group of substances termed *extractive matters*, ranges from 27 to 35 in 1000 parts of healthy human milk, while in the colostrum it amounts to 40; in the milk of the cow it is somewhat higher; while in that of the bitch, and probably of all carnivorous animals, it is more than trebled. It is found in the case of women that the quantity of the caseine increases with the free use of animal food, and diminishes upon vegetable diet.

The fatty matters range from 25 to 43 in 1000 parts of women's milk, while in cows' milk they average, according to Lehmann, 45; and in bitches' milk, rise to 110. These fatty matters, which collectively form butter, consist of an admixture of 68 per cent. of margarine, 30 per cent. of oleine, and 2 per cent. of an admixture of fats, which, on saponification, yield butyric, caproic, caprylic, and capric acids. The milk which is last yielded is much richer in fat than that which is first drawn.

The sugar, or lactine, whose properties are described in the article *SUGAR OF MILK*, varies in human milk from 32 to 62 in 1000 parts, and in cows' milk from 34 to 43. The milk of bitches, when fed on a purely animal diet, often contains no traces of sugar; but if they are fed on vegetable or mixed food, a considerable quantity of sugar is found. The salts in women's milk range from 0.6 to 2.5 in 1000 parts, and in cows' milk from 3.5 to 8.5. That a peculiar selective power is exerted by the mammary gland, is shewn by the following table, which shews the comparative analyses of

MILK-FEVER—MILL.

the ashes of cows' milk and of cows' blood, each reckoned for 100 parts:

	Ash of Milk.	Ash of Blood.
Chloride of potassium,	14.18	none
Chloride of sodium,	4.74	38.82
Potash,	23.46	11.44
Soda,	6.96	29.09
Phosphoric acid,	28.40	7.74
Lime,	17.34	1.90
Magnesia,	2.20	0.78

Why the potassium and sodium compounds stand in this inverse relation to one another in these two fluids, is not accurately known. The abundant supply of phosphoric acid, lime, and magnesia in the milk, is doubtless for the purpose of building up the infant skeleton.

The milk is liable to tolerably regular changes at different periods of lactation; for example, the sugar is deficient during the first month, and is in excess from the eighth to the tenth month; the caseine is in excess during the first two months, and is most deficient between the tenth and eleventh month; the butter is considerably in excess during the first month, and slightly so for the next two months; while the salts are most abundant during the first month, but present no regular law of decrease. Hence, it will readily be seen that in the selection of a wet-nurse, one of the leading requirements should be, that her milk should be of the same age as that of the mother's. Various medicines, as, for example, iodide of potassium, iodide of mercury, and quinine, have been detected in the milk, after being taken by the mother; and many cases are on record in which strong mental impressions, as fear or anger, acting on the mother, have so far poisoned the milk as to cause immediate convulsions in the infant.

The daily quantity of milk is dependent upon various conditions, such as bodily constitution, food, &c. Lamprière determined the quantity of milk secreted in definite times by a large number of women, and found as a mean for each breast between fifty and sixty grammes (the gramme being 15.4 grains) in the course of two hours, assuming that the secretion continues at a uniform rate.

In those cases in which a wet-nurse cannot be obtained, it is expedient to modify cows' milk, so as to make it resemble that of women. The main differences are, that the former contains more caseine, and less sugar and water than the latter. By exposing cows' milk to a gentle heat in a wide open vessel, we obtain a film of caseine which may be removed (more than once, if necessary); on then adding sugar (sugar of milk, if procurable) and water, we obtain a good imitation of the human secretion.

In the article on DIGESTION, the uses of the leading ingredients of the milk in relation to nutrition are sufficiently noticed. The milk of cows is extensively used as an article of diet both for healthy persons and invalids, and it enters largely into all hospital, prison, and workhouse dietaries. In patients with a tendency to consumption, or in whom that disease has already manifested itself in its early form, cream is often of great service, especially when the stomach cannot bear cod-liver oil.

The adulterations to which milk is often subjected are noticed in the article FOOD, and the instruments used for testing the purity of this fluid are briefly referred to in the article GALACTOMETER. Water is by far the commonest adulteration, and if it has been added in large quantity, the fraud may be detected by evaporating a small weighed quantity of the milk (say 500 grains) to dryness, and ascertaining whether the due proportion of solid constituents is left.

Various methods have been proposed for the preservation of milk for sea-voyages, &c. Moore's Essence of Milk is prepared by the addition of a little sugar and the evaporation of the fluid, at a temperature of 110°, to one-fourth of its bulk, when it is put in small tin-cases, soldered down, steeped in boiling-water for a time, and taken out to cool. This preparation keeps good for a long time. Blatchford's Solidified Milk is prepared by mixing 112 lbs. of milk with 28 lbs. of white sugar and a little bicarbonate of soda. The mixture is evaporated under certain conditions, till it assumes the form of a creamy powder, which is cooled, weighed into parcels of 1 lb. each, and compressed into brick-shaped masses, which must be triturated and mixed with warm water when required for use. Grimwade's Desiccated Milk is prepared by mixing the fluid with a little sugar and alkali, and evaporating it till it is as thick as dough; it is then dried, crushed, and bottled. At the meeting of the British Association in 1859, the Abbé Moigno described four methods employed in France for the preservation of milk, of which the most valuable seemed those of Maber and De Pierre. For details regarding these methods, we must refer to the abbé's paper. He found milk prepared by Maber's process perfectly good after having been kept between five and six years. The milk prepared by De Pierre's process, unlike the other preparation, is liquid. A specimen of it, the age of which was not stated, which the abbé brought to Aberdeen, was pronounced by Professor Christison to be perfectly fresh and sweet.

MILK-FEVER, in the lower animals, comes on within a few days after parturition. One variety, common to most animals, consists in inflammation of the membranes of the womb and bowels, and is produced by exposure to cold, overdriving, or injury during labour; it is best treated by oil and laudanum, tincture of aconite, and hot fomentations to the belly. The other variety, almost peculiar to the cow, attacks animals in high condition, that are good milkers, and have already borne several calves; it consists in congestion and inflammation of the brain and large nervous centres, and impairs all the vital functions, leading to dulness, loss of sensation and motion, and stupor. Blood must be drawn early, whilst the cow is still standing and sensible. Later, it only hastens death. A large dose of physic, such as a pound each of salts and treacle, a drachm of calomel, an ounce of gamboge, and two ounces of ginger, should at once be given, solid food withheld, clysters of soap, salt, and water thrown up every hour, cloths wrung out of boiling water applied along the spine, the teats drawn several times daily, and the animal frequently turned. Although treatment is uncertain, prevention is easily insured by milking the cow regularly for ten days before calving, feeding sparingly on laxative unstimulating food, giving several doses of physic before, and one immediately after calving; and when the animal is in very high condition, and prone to milk-fever, bleeding her a day or two before calving.

MILK VETCH. See ASTRAGALUS.

MILKY-WAY. See GALAXY.

MILKWORT. See POLYGALA.

MILL. This word is now used in a general way as a name for almost all kinds of manufactories, as well as for grinding machinery; but we shall only describe here the arrangements of an ordinary flour-mill, adding a brief notice of the edge-mill in use for grinding oil-seeds and some other substances.

From time immemorial, corn has been ground by a pair of stones. The earliest and rudest handmills

were no doubt somewhat like that shewn in fig. 1, which is a representation of one sent home by Dr Livingstone, the African traveller, from the banks

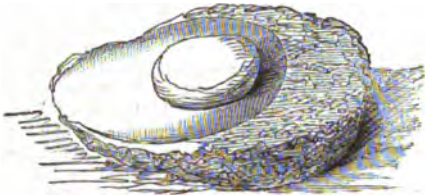

Fig. 1.—African Handmill.

of the Shire, in South Africa. He describes it as 'a mill such as Sarah used, when told by her lord to do the thing handsomely and in a hurry for the strangers—i. e., a big stone worn hollow by the operations of grinding. The upper stone is grasped by both hands, and the weight of the body brought down on it as it is shoved to the lower part. . . . The meal is made very fine.' The next step in advance of this was the quern or handmill, still in use in the Shetland Isles, the Farøes, and other places. The old quern scarcely differs from a pair of modern millstones, except in the stones being small enough to allow of the upper one being turned by the hand, instead of by wind, water or steam power.

The millstones which are now all but universally used for grinding corn are made from buhr-stone, a form of silica like flint in hardness, but not so brittle. This rock is only found in abundance in the mineral basin of Paris and some adjoining districts, and belongs to the Tertiary formation. It is of a cellular texture, and is frequently full of silicified shells and other fossils. Millstones are usually from four to six feet in diameter, and are each made up of a number of pieces strongly cemented and bound together with iron hoops. One six feet in diameter, of fine quality, will cost about £50. The grinding surface of each stone is furrowed or grooved in the manner shewn in fig. 2, the grooves being cut perpendicularly on the one side, and with a slope on the other. A pair of stones

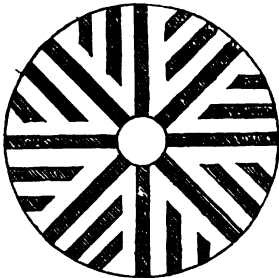

Fig. 2.—Millstone, shewing Grinding Surface.

are used together, and both being furrowed exactly alike, the sharp edges of the grooves on the one come against those on the other, and so cut the grain to pieces.

Fig. 3 shews a section of a flour-mill reduced to its simplest elements. The millstones are at *a*, the lower of which is firmly fixed, it being a matter of importance to have this done securely; and the upper is made to revolve, on a shaft which passes up

through the lower one, at a speed of one hundred revolutions per minute more or less. Motion is communicated by the spur-wheel *b*, which is driven by a water-wheel or other power. The corn, previously cleaned, is supplied to the millstones by means of the hopper *c*, connected with which there is a valve, *d*, for regulating the supply. Passing through a hole in the centre of the upper millstone, it comes in between the two, where it is ground, and thrown out on all sides by means of the centrifugal force. The millstones are, of course, enclosed, and the flour passes down through the spout *e*, to the worm at *f*, which, while it cools the ground corn, carries it along to elevators *g*. These raise it up to the floor, on which the silk-dressing machine, *h*, is placed. This is a cylinder, which was formerly made of wirecloth of various degrees of fineness, and consequently separated the flour into different qualities—the finest passing through the first portion, the second passing

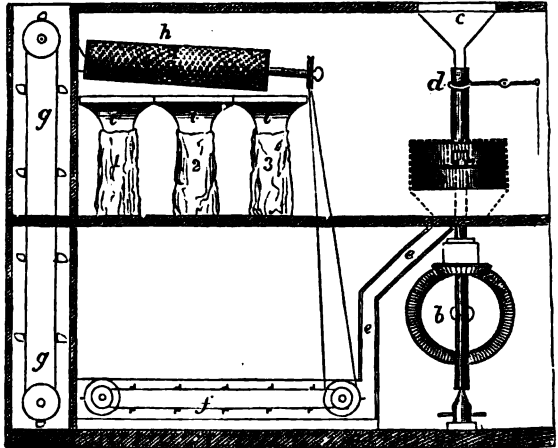

Fig. 3.—Elementary Section of a Flour-mill.

through the next, and so on; but no part of it large enough in the openings to let through the bran, which passed out at the end. Silk is now preferred for dressing the flour, and wire-machines for separating the bran into different kinds. Hoppers, *i*, are placed below the dressing-machine, by means of which the flour and bran are filled into sacks. No. 1, being fine flour; No. 2, seconds; and No. 3, bran.

Having now explained the essential parts of a flour-mill, we shall proceed to describe, as briefly as possible, the extent and arrangements of the one belonging to Messrs Tod at Leith, one of the largest in the country, so as to give an idea of the great extent of some of our new flour-mills. The mill-proper is a building about 150 feet long, 50 feet broad, and 65 feet high. At one end of it is placed a steam-engine of 350 horse-power, which works all the machinery of the mill. This communicates motion to a series of shafts and wheels occupying the ground-floor, belts being used as much as possible for driving the wheels instead of spur-gear, so as to avoid a shaking motion. On the second floor are placed the millstones, of which there are no less than 36 pairs, arranged in two lines along the room. Of this number, 3 pairs are generally being redressed, and a small crane is placed beside each, to lift and replace it when necessary. The wheat is supplied silently by centrifugal feeders to the stones, which are tightly encased, and there is a spout from each pair communicating with an air-exhausting fan for withdrawing the dust, which is

deposited in a separate room, so that the mill is kept remarkably clean. On the third floor are situated the hoppers for feeding the millstones. The fourth floor contains iron rollers for partially crushing the wheat before being supplied to the millstones, a plan almost universally adopted in Germany and some parts of France, although rarely in this country. This floor also contains silk and wire dressing machines. On the fifth floor are placed the first silk-dressing machine, and also smut-machines for cleaning the wheat previous to grinding, which are somewhat similar to thrashing-machines. The sixth and highest floor also contains smut-machines. All these machines are connected in the most skillful manner by means of elevators ascending through all the floors; and along each, where necessary, there runs, in a horizontal direction, an Archimedean screw, so that the grain or the flour can be conveyed to any of the machines without the assistance of hand-labour. Even in the filling of the sacks, there is an ingenious arrangement by which an eccentric wheel lifts and lets them fall again, so that each may be thoroughly filled.

In an adjoining wing of the mill, there are spacious and airy granaries and stores, with elevators, tackle for raising and lowering sacks, shoots for loading, and every requisite appliance. This mill converts wheat into flour at the rate of about 500 sacks a day of 24 hours—a quantity nearly sufficient to supply bread for the entire population of a city like Edinburgh. The great government mill of St Maur is the most remarkable mill in France.

There is a form of mill in use for some purposes

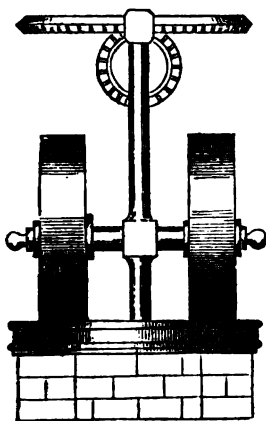

Fig. 4.—Edge-stone Mill.

where the millstones are vertical, as shown in fig. 4, and called the edge-stone mill. It is sometimes, though rarely, used for grinding corn; but is much employed for crushing oil-seeds and for grinding dye-stuffs, sugar, chemicals, and a multitude of other substances. The stones are generally of some hard rock, such as granite or sandstone, and from 5 to 7 feet in diameter. For such purposes as grinding clay or loam, they are usually made of cast iron, and of a smaller size. The stones revolve in opposite directions, sometimes

upon a fixed stone or metal bed, and at other times it is the bed-plate itself which revolves, and in so doing turns the edge stones which rest upon it.

MILL, in Law. The owner of a mill situated on the bank of a stream is entitled to have the use of the stream undiminished in volume; and if the other riparian owners above interfere with the stream by diminishing its volume, thereby causing injury to the mill, the mill-owner has a right of action against the party so acting.

MILL, JAMES, was the son of a small farmer, and was born in the neighbourhood of Montrose, Scotland, 6th April 1773. He studied, with a view to the church, at the university of Edinburgh, where he distinguished himself in Greek and in Moral and Metaphysical Philosophy. He was licensed to preach in 1798; but instead of following out the ministry, he went to London in 1800, where he settled as a literary

man. He became editor of the *Literary Journal*, which after a time was discontinued; and wrote for various periodicals, including the *Eclectic* and the *Edinburgh Review*. In 1806, he commenced his *History of British India*, which he carried on along with other literary work, and published in the winter of 1817—1818. The impression produced by this masterly history on the Indian authorities was such, that, in 1819, the Court of Directors of the Company appointed him to the high post of Assistant-examiner of Indian Correspondence, notwithstanding the then unpopularity of his well-known radical opinions. The business assigned to his care was the Revenue department, which he continued to superintend till four years before his death, when he was appointed head of the Examiner's office, where he had the control of all the departments of Indian administration—political, judicial, and financial—managed by the Secret Committee of the Court of Directors. Shortly after his appointment to the India House, he contributed the articles on Government, Education, Jurisprudence, Law of Nations, Liberty of the Press, Colonies, and Prison Discipline to the *Encyclopædia Britannica*. These essays were reprinted in a separate form, and became widely known. The powers of analysis, of clear statement, and of the thorough-going application of principles, exhibited in these articles, had probably never before been brought to bear on that class of subjects. In 1821—1822, he published his *Elements of Political Economy*, a work prepared primarily with a view to the education of his eldest son, John Stuart Mill. In 1829, his *Analysis of the Human Mind* appeared. His last published book was the *Fragment on Mackintosh*, brought out in 1835. He was also a contributor to the *Westminster Review* and to the *London Review*, which, after a few numbers, was merged in the *London and Westminster*.

Not long after he settled in London, he made the acquaintance of Jeremy Bentham, and for a number of years he and his family lived during the summer in Bentham's country-house. Although he must have derived much benefit from his intercourse with the great law-reformer, he was not a mere disciple of Bentham, but a man of profound and original thought, as well as of great reading, in all the departments of moral, mental, and political philosophy. His conversation was impressive to a remarkable degree, and he gave a powerful intellectual stimulus to a number of young men, some of whom (including his own son, and Mr Grote, the historian of Greece) have since risen to eminence. He took a leading part in the founding of University College, London. He died at Kensington, 23d June 1836.

MILL, JOHN STUART, son of the preceding, was born in London on the 20th of May 1806. He was educated at home by his father. In 1820, he went to France, where he lived for upwards of a year, making himself master of the French language, and occasionally attending public lectures on science. He lived for some time at Paris, in the house of the French economist, Jean Baptiste Say, where he made the acquaintance of many men distinguished then, or afterwards, in letters and in politics. He spent part of his time in the south of France, in the house of Sir Samuel Bentham, brother to Jeremy Bentham. During this stay in France, he laid the foundation of his great familiarity with, and interest in, the politics as well as the literature of the French nation. In 1823, he entered the India House, and became a clerk in the Examiner's office, where his father was Assistant-examiner. For thirty-three years he continued to be occupied in the department of the office named the Political, or the transactions

of the Company with the native states; although he occasionally acted in other departments, as Public Works and Education. In 1831, he was appointed Assistant-examiner, but without any change in his duties, and he held that office till 1856, when, on the retirement of Mr Peacock, the Examiner, and Mr Hill, the first-assistant, he was appointed to Mr Peacock's place at the head of the department. He was understood to have energetically assisted the directors in opposing the measure for the transfer of the India government to the crown, which was carried in 1858. He was offered by Lord Stanley a seat at the new Indian Council, but declined on the score of failing health, and retired from office in October of the same year, on a compensating allowance.

Mr Mill became an author at a very early age, and besides a considerable amount of periodical writing, has produced an extensive and important series of works. His first publications consisted of articles in the *Westminster Review*; and in 1827, he edited Bentham's work entitled *Rationale of Judicial Evidence*. He took an active part in the political discussions that followed the revolution of 1830 in France, and the Reform-Bill movement in England, and from 1835 to 1840 was editor, and along with Sir W. Molesworth, proprietor of the *London and Westminster Review*, where many articles of his own appeared. In 1843, he published his *System of Logic*; in 1844, *Essays on some Unsettled Questions of Political Economy*; in 1848, the *Principles of Political Economy*; in 1859, an essay on *Liberty*; in 1860, a selection from his contributions to reviews, under the title of *Discussions and Dissertations*; and in 1863, a small work on *Utilitarianism*.

Considering the range, the originality, and the precision of his writings, Mr Mill may be looked upon as one of the foremost thinkers of his time.

MILLAIS, JOHN EVERETT, A.R.A., a celebrated English painter, was born at Southampton in 1829, entered the Royal Academy at the age of eleven, and in 1847 carried off the gold medal for his picture of 'The Tribes of Benjamin seizing the Daughters of Shiloh,' exhibited, in the following year, at the British Institution. Before this period, he had acquired a considerable reputation among younger painters by his avowed antipathy to the principles of art which then prevailed. His views were shared in by other students, such as Holman Hunt (q. v.), Dante Rossetti (q. v.), and Charles Collins, and a sort of artistic fraternity was formed, which obtained the name of the *Pre-Raphaelite School*. M.'s reputation rests mainly on the pictures produced during the last decade. Of these, the principal are: 'Our Saviour' (1850), 'Mariana in the Moated Grange' (1851), 'The Huguenot' and 'Ophelia' (1852), 'The Order of Release' and 'The Proscribed Royalist' (1853), 'The Rescue' (1855), 'Autumn Leaves' (1856), 'The Heretic' (1858), 'Spring Flowers' (1860). His 'Black Brunswicker' was exhibited in 1861. Opinions differ in regard to M. as an *artist*. No respectable critic, however, denies or even doubts his wonderful gift of subtle imagination and deep sentiment. He is profoundly poetical, and has probably never been surpassed in his power of representing intense feeling and thought through the medium of colour and composition; but his perverse affectation, and proud contempt for what he regards as 'conventionalism,' have marred the finest of his productions, and made his future position extremely doubtful.

MILLEDGEVILLE, capital of Georgia, United States of America, on the west bank of the Oconee River, 150 miles north-west of Savannah, in a rich cotton country. It has a state-house, governor's

residence, state buildings, and several churches. Pop. about 2500.

MILLENNIUM (Lat. a thousand years' time) designates a certain period in the history of the world, lasting for a long indefinite space (vaguely a thousand years), during which the kingdom of Messiah will, according to tradition, be visibly established on the earth. The idea originated proximately in the Messianic expectations of the Jews; but more remotely, it has been conjectured, in the Zoroastrian doctrine of the final triumph of Ormuzd over Ahriman, and was connected by the Christians with the *Parousia*, or Second Coming of Christ. The notion of a Golden Age, preserved by the converts from heathenism to Christianity, as well as the oppression and persecutions to which they were long subjected by the state authorities, were naturally calculated to develop and strengthen such hopes. The chief basis of the millenarian idea in Judaism as well as in Christianity, however, is the ardent hope for a visible divine rule upon earth, and the identification of the church with that of which it is merely a symbol. In the 1st c. of the church, millenarianism (the Greek equivalent of which, *chiliasm*, from *chiliot*, a thousand, is the term employed by the Fathers) was a widespread belief, to which the book of Daniel, and more particularly the pictorial predictions of the Apocalypse (chaps. xx. and xxi.), gave an apostolical authority; while certain prophetic writings, composed at the end of the 1st and the beginning of the 2d c.—such as the *Testament of the Twelve Patriarchs*, the *Fourth Book of Esdras*, the *Revelation of Saint Peter*, &c.; also the *Christian Sibylline Books*, the *Epistle of Barnabas*, the *Shepherd of the Pseudo-Hermas*, several Midrashim, Targums, and other works of a partly legendary character embodied in the *Talmud*—lent it a more vivid colouring and imagery. The unanimity which the early Christian teachers exhibit in regard to millenarianism, proves how strongly it had laid hold of the imagination of the church, to which, in this early stage, Immortality and future Rewards were to a great extent things of this world as yet. Not only the heretic Cerinthus, but even the orthodox doctors—such as Papias, Bishop of Hierapolis, Ireneus, Justin Martyr, &c.—delighted themselves with dreams of the glory and magnificence of the millennial kingdom. The *Sibylline Books*, for instance, hold that the earth will be cultivated throughout its length and breadth, that there will be no more seas, no more winters, no more nights; everlasting wells will run honey, milk, and wine, &c. &c. Papias, in his collection of traditional sayings of Christ (*Kuriakôn Logiôn Exêgêsis*), indulges in the most monstrous representations of the rebuilding of Jerusalem, and the colossal vines and grapes of the millennial reign. Every vine will bear 10,000 branches, every branch 10,000 shoots, every shoot 10,000 sprigs, every sprig 10,000 bunches, every bunch 10,000 berries, every berry 36 times 25 gallons of wine; and if a Saint come to pluck a berry, they will all cry out: 'Pluck me, O Saint, I am better, and praise the Lord through me.' The *Talmud* calculates the height of the men of the millennium to be, as before the Fall, of 200—900 yards; the moon shall be, according to a prophetic dictum, like the sun; the sun shall be increased 343 times; and every Israelite will beget as many children as there were Israelites going out from Egypt—60,000. Each grape will be large enough to fill the biggest ship. Above all, however, the land of Israel will be free again, and the primitive worship restored with unheard-of splendour. 'Such a chiliasm,' Neander justly remarks, could only 'promote a fleshly eudaimonism;' and indeed

ere long it called into more energetic activity the opposition of Gnostic spiritualism. According to the general opinion, which was as much Christian as Jewish, the millennium was to be preceded by great calamities, reminding us in some degree of the Scandinavian Ragnarök (or 'Twilight of the Gods'). The personification of evil appeared in *Antichrist*, the precursor of Christ (identified, during the 1st c., with Nero), who would provoke a frightful war in the land of Magog (Ezek. chaps. xxxviii. and xxxix.) against the people Gog, after which the Messiah—some say a double Messiah, one the son of Joseph, vanquished in the strife; the other, the victorious son of David—would appear, heralded by Elias, or Moses, or Melchizedek, or Isaiah, or Jeremiah, and would bind Satan for a thousand years, annihilate the goddess heathen, or make them slaves of the believers, overturn the Roman empire, from the ruins of which a new order of things would spring forth, in which the 'dead in Christ' would arise, and along with the surviving saints enjoy an incomparable felicity in the city of the 'New Jerusalem,' which was expected to descend literally from heaven. To the innocence which was the state of man in Paradise, there was associated, in the prevalent notions of the millennium, the finest physical and intellectual pleasures.

In the Mosaic account of creation, we find the primitive ground for making the victorious era of the church last a thousand years. That account was regarded by the Jews and by the Judaic Christians as a type of the destinies of creation. Now, by a strictly literal interpretation of the 4th verse of the 90th Psalm, it was supposed that a day of God was arithmetically equal to a thousand years; hence the six days of creation were understood to indicate that the earth would pass through 6000 years of labour and suffering, to be followed by a seventh day—that is, 1000 years of rest and happiness. In the Book of Revelation (chap. xx.) this view is presented. Still, the rabbinical traditions differ widely among themselves as to the duration of the happy period. Instead of 1000 years, some of them count 40, 70, 90, 365, 400, 600, 2000, or 7000, or so many years as have elapsed from the creation of the world or the flood. The Gospel of Nicodemus makes it 500 years, &c. In fact, the systems of apocalyptic chronology were of a varied and somewhat arbitrary cast—according as their originators laid greater stress upon the Apocalypse, the Book of Daniel, the Song of Songs, the Jewish 'Gematria,' or Computation of Letters—a very plausible art in itself—or on astronomy, astrology, 'natural phenomena,' and the like.

The lapse of time chilling the ardour of the primitive Christian belief in the nearness of the *Parousia*, had without doubt also the tendency to give a more shadowy, and therefore a more spiritual aspect to the kingdom over which the expected Messiah was to reign. The influence of the Alexandrian philosophy contributed to produce the same result. Origen, for example, first started the idea, that instead of a perpetual opposition of Paganism to Christianity—instead of a final and desperate conflict between the two—instead of an insolent triumph on the part of the saints, and a servile submission on the part of the unbelievers, the real progress and victory of Christianity would consist in the gradual spread of the truth throughout the world, and in the voluntary homage paid to it by all secular powers. This was an immense advance on the views previously entertained. It is owing largely to Origen and his disciple Dionysius that more spiritual conceptions of the millennium finally established themselves in the church; at all events, they furnished the Fathers with the majority of their arguments.

Yet even in the Egypto-Alexandrian Church, millenarianism, in its most literal form, was widely diffused, and was only eradicated by the great wisdom and moderation of Dionysius. The Montanists (q. v.) generally, as might be expected from the enthusiastic tendencies of the sect, were extreme millenarians or chiliasts, and, being considered a heretical sect, contributed largely to bring Chiliasm into discredit, or, at all events, their own carnal form of Chiliasm, which Tertullian himself attacked. Caius, the Presbyter, in his 'Disputation' against the Montanist Proclus, traces its origin to the hated heretic Cerinthus, whom he accuses of forging a certain revelation, which he passed off as the work of an apostle. From his description of this revelation, it is almost certain—strange as it may appear—that he alludes to the canonical Apocalypse. Lactantius, in the beginning of the 4th c., was the last important church Father who indulged in chiliastic dreams, while among its earlier advocates may be mentioned chiefly Nepos, Methodius, Korakion, Apollinarius, Victorinus, &c. In the 5th c., St Jerome and St Augustine expressly combated certain fanatics who still hoped for the advent of a millennial kingdom whose pleasures included those of the flesh. But from this time, the church formally rejected millenarianism in its sensuous 'visible' form, although the doctrine every now and then made its reappearance, especially as a general popular belief, in the most sudden and obstinate manner. Thus the expectation of the *Last Day* in the year 1000 A. D. re-invested the doctrine with a transitory importance; but it lost all credit again when the hopes, so keenly excited by the Crusades, faded away before the stern reality of Saracenic success, and the predictions of the *Everlasting Gospel*, a work of Joachim de Floris, a Franciscan abbot (died 1212), remained unfulfilled.

At the period of the Reformation, millenarianism once more experienced a partial revival, because it was not a difficult matter to apply some of its symbolism to the papacy. The Pope, for example, was *Antichrist*—a belief still adhered to by some extreme Protestants. Yet the doctrine was not adopted by the great body of the Reformers, but by some fanatical sects, such as the Anabaptists and by the Theosophists of the 17th century. During the civil and religious wars in France and England, when great excitement prevailed, it was also prominent. The *Fifth Monarchy Men* of Cromwell's time were millenarians of the most exaggerated and dangerous sort. Their peculiar tenet was, that the millennium *had* come, and that *they* were the saints who were to inherit the earth. The excesses of the French Roman Catholic Mystics and Quietists terminated in chiliastic views. Among the Protestants, it was during the *Thirty Years' War* that the most enthusiastic and learned chiliasts flourished. These may—broadly—be brought under the three chief heads of *Essegetical* Chiliasts, who, by some biblical dates, endeavoured to compute the predicted time; *Alchemistic* or *Kabbalistic* Chiliasts, who endeavoured to hasten the period by some mystical discovery; and *Politico-theocratic* Chiliasts, who wished to reduce the governments of the world to a biblical standard. See ANABAPTISTS, MÜNZER. The awful suffering and widespread desolation of that time, led pious hearts to solace themselves with the hope of a peaceful and glorious future. Since then the penchant which has sprung up for expounding the prophetic books of the Bible, and particularly the Apocalypse, with a view to present events, has given the doctrine a faint semi-theological life, very different, however, from the earnest, practical faith of the first Christians. Among the foremost chiliastic teachers of modern centuries are to be

mentioned Ezechiel Meth, Paul Felgenhauer, Bishop Comenius (*Lux in Tenebris*, 1657); Professor Jurien (*L'accomplissement des Prophéties*, 1686); Serarius (*Assertion du Règne de Mille Ans*, &c., ab. 1670); Poirer (*Economie Divine*, 1687); J. Mede (*Clav. Apocal.* 1627); while Thomas Burnet and W. Whiston endeavoured to give chiliasm a geological foundation, but without finding much favour. Spener, on account of his *Hoffnung besserer Zeiten*, has been accused of chiliasm; no less Joachim Lange (*Licht und Recht*); and Swedenborg employed apocalyptic images to set forth the transfigured world of the senses. Latterly, especially since the rise and extension of missionary enterprise, the opinion has obtained a wide currency, that after the conversion of the whole world to Christianity, a blissful and glorious era will ensue; but not much stress—except by extreme literalists—is now laid on the nature or duration of this far-off felicity. In fact, the common Christian conception of a millennium without a visibly present Christ, as held at the present day, is little different, so far as results are concerned, from the belief of philosophers in the perfectibility of the race. The essence of both conceptions is the cessation of sin and sorrow, the prevalence of holiness and happiness. But this departs widely from the 'ancient hope of the church'—a kingdom of visible majesty, with Jesus and the saints ruling the world from Jerusalem, the central city of the earth!

Great eagerness and not a little ingenuity have been exhibited by many persons in fixing a date for the commencement of the millennium. The celebrated theologian, Johann Albrecht Bengel (*Erklärte Offenbarung; Reden für's Volk*), who, in the 18th c., revived an earnest interest in the subject among orthodox Protestants, asserted from a study of the prophecies that the millennium would begin in 1836. This date was long popular. Bengel's general millenarianism was adopted by Oetinger (d. 1782), and widely spread throughout Germany in a more or less poetic form by Hahn, Crusius, Jung Stilling, Lavater, and Hess (*Briefe über die Offenb. Joh.*). Some of the greatest of the more recent German theologians are millenarians, such as Rothe, Delitzsch, Hoffmann, Kurtz, Hebart, Thiersch, Nitzsch, P. Lange, and Ebrard. Swedenborg, to whom reference has already been made, held that the last judgment took place in 1757, and that the New Church, or 'Church of the New Jerusalem,' as his followers designate themselves—in other words, the millennial era, then began. In America, considerable agitation was excited by the preaching of one William Miller, who fixed the second advent of Christ about 1843. Of late years, the most noted English millenarian is Dr John Cumming, who places the end of the *present dispensation* in 1866 or 1867; but as that time is drawing near without any millennial symptoms, he is understood to have modified his original views considerably, and now conjectures that the beginning of the millennium will not differ so much after all from the years immediately preceding it, as people commonly suppose.—See Corrodi's *Kritische Geschichte des Chiliasmus* (Zurich, 1794, 4 vols.); Calixtus, *De Chiliasmo cum antiquo tum pridem renato Helmet.* (1692, 4to); Klee, *Tentam. Hist. crit. de Chil. prim. æc. Herbip.* (1825); Münter, *Dogmengeschichte*, &c. A really good history of Chiliasm, however, is as yet a desideratum.

MILLEPEDE, a popular name of many kinds of *Myriapoda*, of the order *Chilognatha*, and chiefly of the families *Julidae* (see *JULUS*) and *Polydesmidae*. In the latter family, the feet are arranged in numerous groups along both sides; otherwise, they much resemble the *Julida*. The largest species are found

in warm climates, and some of them are brightly coloured; but small species of both families are common in Britain; and some of them, as *Polydesmus complanatus*—which is lilac-coloured, flattened, and from a quarter to half an inch in length—are very destructive to the roots of plants. Doubt has been expressed if they attack roots perfectly healthy; but, at all events, they take advantage of incipient decay, and greatly extend and accelerate it. The application of salt, lime, nitrate of soda, &c., has been often recommended as a preventive of their ravages.—The name *PRILL M.* is often given to those shorter *Chilognatha*, of the family *Glomeridae*, which, when disturbed, roll themselves up into an almost globular form, like the crustacean called armadillo. *Glomeris marginata* is common in Britain, under stones and among moss. Some of the tropical species are large and finely coloured.

MILLER, HUGH, a distinguished geologist, was born in Cromarty, in the north of Scotland, October 10, 1802. He was descended from a family of sailors, and lost his own father by a storm at sea when he was only five years of age. In consequence of this misfortune, he was brought up chiefly under the care of two of his mother's uncles, one of whom ('Uncle Sandy') imbued him with a taste for natural, and the other ('Uncle James') for traditional history. He acquired a good knowledge of English at the Cromarty grammar-school. Before his 11th year, he had read those glorious romances of childhood, *Jack the Giant-killer*, *Jack and the Bean-stalk*, *Sinbad the Sailor*, *The Yellow Dwarf*, and *Aladdin and the Wonderful Lamp*, besides several other works of higher literary pretensions. As he grew older, he became extremely fond of the great English poets and prose writers. From his 17th to his 34th year, he worked as a common stonemason, devoting his leisure hours to independent researches in natural history, and to the extension of his literary knowledge. In 1829, he published a volume, entitled *Poems written in the Leisure Hours of a Journeyman Mason*, which was followed, a few years afterwards, by *Scenes and Legends of the North of Scotland*. His attention was soon drawn to the ecclesiastical controversies which were agitating Scotland, and his famous *Letter to Lord Brougham* on the 'Auchterarder Case,' brought him prominently into notice. In 1840, he went to Edinburgh as editor of the *Witness*, a newspaper started in the interest of the Non-intrusion party in the Church of Scotland; and, in the course of the same year, published in its columns a series of geological articles, which were afterwards collected under the title of *The Old Red Sandstone, or New Walks in an Old Field*. These articles were very remarkable, both in a scientific and literary point of view. They contained a minute account of the author's discovery of fossils in a formation believed, until then, to be destitute of them, and written in a style which was a harmonious combination of strength, beauty, and polish. At the meeting of the British Association in the same year (1840), he was warmly praised by Murchison and Buckland, and, in fact, his discoveries were the principal topic of discussion among the savans. His editorial labours during the heat of the Disruption struggle were immense, and so seriously injured his health, that for some time he had to give up all literary activity. About 1846, he resumed his pen, and became the most vigorous and eloquent writer in the service of the newly-constituted Free Church. After ten years of hard, earnest, fagging toil, his brain gave way, and, in a moment of aberration, he put an end to his own existence, at Portobello, near Edinburgh, on the night of the 23d or morning of the 24th December 1856. M.'s principal works, besides those already

mentioned, are: *First Impressions of England and its People*; *Footprints of the Creator, or the Asterolepis of Stromness*, designed as a reply to the *Vestiges of the Natural History of Creation*; *My Schools and Schoolmasters, or the Story of my Education*; and *Testimony of the Rocks*, the last of which is an attempt to reconcile the geology of the Pentateuch with the geology of nature, by the hypothesis, that the days mentioned in the first chapter of Genesis do not represent the actual duration of the successive periods of creation, but only the time occupied by God in unrolling a panoramic vision of these periods before the eyes of Moses in the Mount.

M.'s services to science have undoubtedly been great, but he is even more distinguished as a man than as a savant. Honest, high-minded, earnest, and hugely industrious, a true Scot, a hearty, but not a sour Presbyterian (for he loved Robert Burns as much as he revered John Knox), there are few men of whom his country has better reason to be proud than 'the stone-mason of Cromarty.'

MILLER'S THUMB. See BULLHEAD.

MILLET, a grain, of which there are several kinds, the produce of species of *Panicum*, *Setaria*, and allied genera. The genus *Panicum* contains many species, natives of tropical and warm temperate countries, and some of which, as *Guinea Grass* (q. v.), are amongst the largest fodder grasses. The flowers are in spikes, racemes, or panicles; the glumes very unequal, one of them often very minute; each spikelet containing two florets, one of which is often barren. The genus *Setaria* has a spikelike panicle, with two or more bristles under the glumes of each spikelet.—**COMMON M.** (*Panicum miliaceum*) is an annual grass, three or four feet high, remarkably covered with long hairs, which stand out at right angles. It has a much-branched nodding panicle; the spikelets are oval, and contain only one seed. It is a native of the East Indies, but is extensively cultivated in the warmer parts of Europe and other quarters of the world. It succeeds only in those climates in which wine can be produced. It is called *Warree*, *Cheena*, and *Kadi-kane* in India. The grain, which is very nutritious, is only about one-eighth of an inch in length. It is used in the form of groats, or in flour mixed with wheat-flour, which makes a good kind of bread; but bread made of M. alone is brittle and full of cracks. Poultry are extremely fond of millet. The straw is used for feeding cattle.—Other species, *P. miliare*, *P. frumentaceum*, and *P. pilosum*, are cultivated in different parts of India, chiefly on light and rather dry soils, yielding very abundant crops.—**GERMAN M.**, or *MOHAR* (*Setaria Germanica*), and **ITALIAN M.** (*S. Italica*), regarded by many as varieties of one species, and probably originally from the East, although now naturalised in the south of Europe, are cultivated in many of the warmer parts of Europe, in India, and other countries. Italian M. is three or four feet in height; German M. much dwarfed, and its spike comparatively short, compact, and erect; and less valuable as a corn-plant. The grains of both are very small, only about half as long as that of Common M.; but they are extremely prolific, one root producing many stalks, and one spike of Italian M. often yielding two ounces of grain. The produce is estimated as five times that of wheat. Italian M. is called *Koangoonie*, *Kala-kangnee*, and *Kora-kang* in India. The grain of these millets is imported into Britain for feeding cage-birds, and for use as a light and pleasant article of food, although for this purpose it is little used in Britain, whilst it is very extensively used in soups, &c., in the south of Europe. It does not

make good bread. To the same tribe of grasses belong the genera *Paspalum*, *Pennisetum*, *Penicillaria*, *Digitaria*, and *Milium*—species of which are cultivated in different parts of the world for their grain. *Paspalum exile* is the *Fundi* (q. v.) of Africa; and *P. scrobiculatum* is the *Koda* of India, where it is cultivated chiefly on poor soils. *Penicillaria spicata*, or *Pennisetum typhoideum*, is very extensively cultivated in Africa, and to a considerable extent in India. Its cultivation has been introduced into the south of Europe. It succeeds best on light soils. Its Indian name is *Bajree*. It often receives the names **EGYPTIAN M.** and **GUINEA CORN.** It has a somewhat spiked cylindrical panicle.—*Pennisetum distichum* abounds in Central Africa, on the southern borders of the Great Desert, where it is called *Uzak*, and is described by Barth as causing much inconvenience to the traveller, the little bristles which are attached to its seeds making them stick like burs to the clothes; they also pierce the skin, and cause sores, so that it is necessary to be provided with small pincers for their extraction, and none even of the wild roving natives is ever without such an instrument. But its seed is a common and pleasant article of food, in some places the principal food of the people, and a pleasant beverage is made from it.—*Digitaria sanguinalis* is called **POLISH M.**, being cultivated in cottage-gardens in Poland, where the grain is used like rice. It is a common grass in many parts of Europe, although very rare in Britain. The spikes in this genus are compound, and from their appearance give it the names *Digitaria* and *Finger-grass*.—The **M. GRASS** (*Milium effusum*) of Britain, occasionally found in shady woods, is a very beautiful grass, three or four feet high, with a spreading pale panicle of small flowers; and has been much recommended for cultivation as a forage grass, and for the sake of its very abundant small seeds, an excellent food for game. Another species of the same genus (*M. nigricans*) is the *Maize de Guinea* of Peru, where its seeds, after being dried by heat, are converted into a very white flour, a pleasant article of food; and a beverage called *ullpu* is made from them.—The name **INDIAN M.** is sometimes given to *Durra* (q. v.), but it belongs to a different tribe of grasses from the true millets.

MILLRIND, or **FER DE MOULIN**, in Heraldry, a charge meant to represent a mill-iron, originally a mere variety in designating the cross moline, but accounted a distinct charge by some heralds.

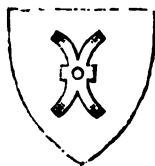

Millrind.

MILMAN, HENRY HART, D.D., an English poet and ecclesiastical historian, was the youngest son of Sir Francis Milman, physician to George III., and was born in London, 10th February 1791. He was educated at Eton, and afterwards at Brasenose College, Oxford, where he took the degree of M.A., obtained the Newdegate Prize in 1812, published *Fazio, a Tragedy* (which was successfully brought upon the stage at Covent Garden), in 1815; took orders in 1817, and, shortly after, was appointed vicar of St Mary's, Reading. In the following year appeared his *Samor, Lord of the Bright City, an Heroic Poem*, which was followed in 1820 by the *Fall of Jerusalem*, a beautiful dramatic poem, with some fine sacred lyrics interspersed. In 1821, M. was chosen Professor of Poetry at Oxford, and published three other poems in the course of the same year—*The Martyr of Antioch*, *Belshazzar*, and *Anne Boleyn*. His *Sermons at the Bampton Lecture* appeared in 1827, and his *History of the Jews* (3 vols.) in 1829. The last of these works did not bear

the author's name; it was written in so liberal and tolerant a spirit, that ecclesiastics of the stricter sort could hardly fail to be offended. Its weak point was a want of adequate learning, especially in the department of biblical criticism. A new edition, greatly improved, and more critical, yet still far from being very accurate, or built on solid foundations, with an interesting preface, has been recently (1863) published. In 1840 appeared a collected edition of his *Poetical Works*, containing some other pieces besides those already mentioned. The same year witnessed the publication of his *History of Christianity from the Birth of Christ to the Abolition of Paganism in the Roman Empire* (3 vols.). In 1849 he was made Dean of St Paul's; and in 1854 published his master-piece, *History of Latin Christianity, including that of the Popes to the Pontificate of Nicholas V.* (3 vols.). It is a work of great learning, liberality, and chastened eloquence; it displays a broad grasp of human nature in its religious workings; something of the philosopher, and still more of the poet, is seen in the strong and vivid spirit of sympathy with which he deals with men of the most different opinions. The work secured for its author a position in the first rank of English historians. M., besides, edited Gibbon, and contributed extensively to the *Quarterly Review*. He died in 1868.

MILNE-EDWARDS, HENRI, the most eminent living representative of the French school of natural history, was born at Bruges in 1800. His father was an Englishman. M. studied medicine at Paris, where he took his degree of M.D. in 1823, but abandoned medicine to devote himself to natural history. He was first appointed Professor of Natural History in connection with the *Lycée Henri Quatre*, and afterwards to the Museum and the *Faculté des Sciences*, of which he is now President. In 1838, he was elected a member of the Academy of Sciences (section of Anatomy and Zoology); and in 1854 was chosen a member of the *Académie de Médecine*. He is also a member of many other societies, French and foreign, and an officer of the Legion of Honour. M. is distinguished for his extensive knowledge of comparative anatomy and physiology, as well as of zoology. Passing over some of his early works, which, though valuable, are thrown into the shade by his later ones, we come to his *Monograph on the Crustacea* (1837—1841), which is universally regarded as of pre-eminent merit, not only for its richness of detail, but also for the value of the general doctrines relating to homologies, development, geographical distribution, and other points of the highest physiological interest. In 1840, an improved edition of his *Elements of Zoology*, a work in 4 vols., and containing 600 illustrations, began to appear. In 1841, he published his researches on the Compound Ascidian Mollusca, which have led to an entirely fresh appreciation of some of the most important points in the history of that group, such as, that *propagation by gemmation*, which had been previously supposed to be a zoophytic character, is equally true of the lower mollusca. In other departments of science, M. has been equally successful; but it is to the invertebrate animals that his chief attention has been given, and in each of the three Cuvierian sub-kingdoms, *Articulata*, *Mollusca*, and *Radiata*, his researches have been so important, that what he has accomplished for either alone would suffice to establish for him a high scientific reputation. In 1856, M. obtained the Copley Medal of the Royal Society of London. His last publication of importance is his *Lectures on Physiology*, and on the *Comparative Anatomy of Men and Animals* (1855—1857).

MILNER, JOSEPH, an ecclesiastical historian who

once occupied a respectable place in literature, was born near the town of Leeds, in Yorkshire, January 2, 1744. He studied at Catharine Hall, Cambridge, where he took the degree of B.A. in 1766, and afterwards became head-master of the grammar-school at Hull. In this capacity, his success was very great. Shortly after, he was appointed lecturer in the principal church of the town, and in 1797, vicar of Holy Trinity Church. He died November 15th of the same year. M.'s principal work is his *History of the Church of Christ*, of which he lived to complete 3 vols., reaching to the 13th c. (1794); a fourth volume, reaching to the 16th c., was edited from his MSS. by his brother, DE ISAAC MILNER, Dean of Carlisle, who also published a complete edition of his brother's works in 8 vols., 1810. The principles on which *The History of the Church of Christ* is written are of the narrowest kind; the scholarship is poor, the literary merit still poorer, and the critical insight poorest of all. It deserves mention only for the estimation in which it was formerly held, at a time when the English Church seemed sunk in ignorance and stupor.

MILNES, RICHARD MONCKTON, BARON HOUGHTON, English poet and politician, descended from an old Yorkshire family, was born in 1809, and educated at Trinity College, Cambridge. He entered parliament as M.P. for Pontefract in 1837, and continued to represent that borough until the close of the parliamentary session of 1863, when he was called to the Upper House by the title of Baron Houghton. In the House of Commons he began life as a Conservative, but afterwards allied himself to the Liberal party, and was a faithful follower of Lord Palmerston, when his foreign policy and high-handed dealings at the Foreign Office led to the temporary estrangement of that statesman from the Whigs. M. has distinguished himself, however, rather by his philanthropic labours, and his speeches on behalf of the Italians, Poles, and other oppressed nations, than by his devotion to party politics. He has been the advocate of public education and religious equality. He carried, in 1846, a bill for establishing Reformatories, and has taken a great interest in the reform of the criminal classes. M. has also cultivated the muse with grace and success. He has travelled much in oriental countries, and is the author of *Memorials of a Tour in Greece*, and also of poems called *Palm Leaves*, in which a poetical halo is thrown around the manners and domestic institutions of the East. His *Poems of Many Years*, and *Poems Historical and Legendary*, contain many simple and elegant effusions. In 1849, he edited the *Life, Letters, and Literary Remains of John Keats*. He has written *Thoughts on Purity of Election*, and many political and literary articles for periodical publications.

MILO, of Croton, in Magna Græcia (q. v.), an athlete famous for his great strength, who lived, according to Herodotus, in the time of Darius Hystaspes, about 520 B. C. Among other displays of his strength, he is said to have on one occasion carried a live ox upon his shoulders through the stadium of Olympia, and afterwards to have eaten the whole of it in one day; and on another (reversing the story of the Hebrew Samson), to have upheld the pillars of a house in which Pythagoras and his scholars were assembled, so as to give them time to make their escape when the house was falling. He is said to have lost his life through too great confidence in his own strength, when he was getting old, in attempting to split up a tree, which closed upon his hands, and held him fast until he was devoured by wolves.

MILREE', MILREI, or MILREA, a Portuguese silver coin and more of account, contains 1000 rees, and is valued at 4s. 10½d. sterling. The coin is commonly known in Portugal as the *corôa*, or 'crown,' and is (since 24th April 1835) the unit of the money-system in that country. It is used in Brazil. The half-*corôa*, or half-*milrei*, of 500 rees, is also used in both countries. The name 'milrei' was used in Portuguese accounts long before any coin representing its value existed.

MILTIADES, a celebrated Athenian general, 'tyrant of the Chersonese,' yet, as Byron sings, 'freedom's best and bravest friend.' Forced by Darius to flee from his dominions, he took refuge at Athens, and on the second Persian invasion of Greece, his military talents being of a high order, he was chosen one of the ten generals. He particularly distinguished himself by the great victory which he gained at Marathon (q. v.) with a small body of Athenians and 1000 Plataeans (29th September, 490 B. C.) over the Persian host, under Datis and Artaphernes. By this victory, the Greeks were emboldened for the heroic struggle which they made in defence of their country and their liberty. M. being intrusted with the command of an armament for the purpose of retaliating on the Persians, made an attack on the island of Paros in order to gratify a private enmity; but failing in the attempt, he was, on his return to Athens, condemned to pay a heavy fine as an indemnification for the expenses of the expedition. Being unable to do this, he was thrown into prison, where he died of a wound received at Paros. The fine was exacted after his death from his son Cimon (q. v.).

MILTON, JOHN, an English poet, was born in Bread Street, London, on the 9th December 1608. His father was of an ancient Catholic family, but was disinherited on becoming Protestant. He followed the occupation of a scrivener, by which, according to Aubrey, 'he got a plentiful estate,' and was a man of great musical accomplishment, being the composer, among other things, of the two well-known psalm-tunes *Norwich* and *York*. From him his son derived his matchless ear, and that strict integrity of character for which he is as famous as for his verse.

M. was carefully nurtured and educated. He was first placed under the care of a private tutor named Young, a Scotchman by birth and education; and at the age of twelve, was sent to St Paul's School, London, and afterwards to Christ's College, Cambridge. According to the University Register, he was admitted 12th February 1624—1625. He took his degree of M.A.; and having relinquished the idea of following divinity or law, he left Cambridge in 1632, and went to live at his father's house at Horton, in Buckinghamshire. There, in serenity of mind and passion, he lived five years, reading the Greek and Latin poets, and composing *Comus*, *Lycidas*, *Arcades*, *L'Allegro*, and *Il Penseroso*. On the death of his mother in 1637, he went abroad, visiting the chief Italian cities, and making the acquaintance of Grotius and Galileo. While travelling, being made aware that clouds were gathering in the political atmosphere at home, he returned in 1639, and engaged himself with the tuition of his nephews—on which portion of M.'s life, Dr Johnson could not help looking with 'some degree of merriment.' In 1641, he engaged in the controversies of the times, and in the course of that and the following year, he issued the treatises *Of Reformation*, *The Reason of Church Government urged against Prelacy*, *Prelatical Episcopacy*, and *An Apology for Smeectymnus*. In 1643, he married rather suddenly Mary, daughter of Richard Powell, an Oxfordshire

royalist, but the union did not at first prove happy. His wife, who had been accustomed to 'dance with the king's officers at home,' found her husband's society too austere and philosophic for her gay tastes. After the severe honeymoon was over, she obtained permission to visit her relatives till Michaelmas; but when Michaelmas came, she refused to return. Stern and proud, M. repudiated her at once; and the matrimonial disagreement made the world the richer by four *Treatises on Divorce*. A reconciliation, however, took place, which, we have no reason to doubt, was both genuine and permanent. Mary Powell died in 1652—1653, leaving him three daughters, Ann, Mary, and Deborah, of whose undutifulness and ingratitude we have latterly many complaints. In 1644 he produced his *Tractate on Education* and his *Areopagitica*—a flame of eloquence at which one may warm one's hands yet. After the execution of Charles, he was appointed Latin secretary to the Council of State, with a salary of £290. In his new position, his pen was as terrible as Cromwell's sword. In *Bikonoklastes*, he made a savage but effective reply to the famous *Eikon Basilike*; and in his *Pro Populo Anglicano Defensio* he assailed his opponent, Claude de Saumaire, better known as *Salmasius*, with such a storm of eloquence and abuse, that the latter, who died at Spa in 1653, is believed to have lost his life through chagrin. M. at least flattered himself with having 'killed his man.' His second wife, whom he married 12th November 1656, was a daughter of Captain Woodcock of Hackney. She died in childbed in February 1658, and her husband has enshrined her memory in an exquisitely pure and tender sonnet.

Unceasing study had affected his eyesight, and about 1654, M. became totally blind. After the Restoration, he retired from affairs; he was obnoxious to the reigning power, and it is said that he was once in custody of the serjeant-at-arms. On the publication of the Act of Oblivion, he married his third wife, Elizabeth Minshull, and shortly after removed to a house in Artillery Walk, when he was busy with *Paradise Lost*. This great poem was originally planned as a mystery, then some idea of treating it as a drama haunted the author's mind; finally, however, he resolved to write an epic poem on the Fall of Man. The poem was published in 1667. He received five pounds from his publisher, and a promise of other five pounds when 1300 copies should have been sold. In 1670, he published his *History of England*. Next year, he printed *Paradise Regained* and *Samson Agonistes*. He died on Sunday, the 8th November 1674, and was buried next his father, in the chancel of St Giles, at Cripplegate. He left property to the value of £1500.

M. was, above all English poets, stately and grandiose. He arrived early at the knowledge of his powers, and did not scruple, in one of his prose tracts, to inform his readers that he purposed to write a poem which would be considered one of the glories of his country. Drawn away for a time by the heats of controversy and by official tasks, he never forgot his pledge, and redeemed it at last in old age, blindness, and neglect. In comparison, other poets are like sailing-ships, at the mercy of the winds of Passion and Circumstance; he resembled the ocean-steamer, which, by dint of internal energy, can pierce right through the hurricane. Never, perhaps, was a mind more richly furnished. His careless 'largess' is greater than the fortunes of other men. His *Comus* is the very morning-light of poetry; while in his great epic there is a massiveness of thought, a sublimity of imagery, a pomp of sound—as of rolling organs and the outbursting of cathedral choirs—which can be found nowhere else.

His great passages echo in the mind as if loath to die. Of all great writers, he is perhaps the one for whom we are conscious of the least personal affection, and this arises from a certain hauteur and severity which awes—which repels some natures. He infects his reader with his own seriousness. He is withdrawn from the ordinary world of men, but it is as an Alp is withdrawn—by vastness, by solitariness of snows, by commerce with heaven.

MILWAU'KEE, a city of Wisconsin, United States of America, on the western shore of Lake Michigan, at the mouth of Milwaukee River or Creek, which forms its harbour. The town, beautifully built with light yellow bricks, crowns a high bluff on the lake, and contains county buildings, custom-house, and post-office, 33 churches, 9 public schools, female college, chamber of commerce, 8 banks, 7 insurance companies, 2 orphan asylums, a convent, hospital of sisters of charity, 42 hotels, 8 daily papers, 4 of which are in German. Four railways connect the city with a country of great fertility. In 1859, among the exports were 300,000 barrels of flour, 5,000,000 bushels of wheat, and great quantities of other agricultural products. Pop. in 1860, 45,254.

MĪMĀNSĀ (from the Sanscrit *mān*, to investigate; hence, literally, investigation) is the collective name of two of the six divisions of orthodox Hindu philosophy. See **SANSKRIT LITERATURE**. It is distinguished as *Pūrva-* and *Uttara-mīmāṃsā*, the latter being more commonly called *Vedānta* (q. v.), while the former is briefly styled *Mīmāṃsā*. Though the M. is ranked, by all native writers, with the five other philosophical systems, the term philosophy—as understood in a European sense—can scarcely be applied to it; for the M. is neither concerned with the nature of the absolute or of the human mind, nor with the various categories of existence in general—topics dealt with more or less by the other five philosophies; its object is merely to lay down a correct interpretation of such Vedic passages as refer to the Brāhmanic ritual, to solve doubts wherever they may exist on matters concerning sacrificial acts, and to reconcile discrepancies—according to the M., always apparent only—of Vedic texts. The foundation of this system is therefore preceded by a codification of the three principal Vedas—the R'ik, Black-Yajus, and Sāman—and by the existence of schools and theories which, by their different interpretations of the Vedic rites, had begun to endanger, or, in reality, had endangered a correct, or at least authoritative understanding of the Vedic texts. It is the method, however, adopted by the M. which imparted to it a higher character than that of a mere commentary, and allowed it to be looked upon as a philosophy; for, in the first place, the topics explained by this system do not follow the order in which they occur in the Vedic writings, especially in the Brāhma'na portion of the Vedas (q. v.); they are arranged according to certain categories, such as authoritativeness, indirect precept, concurrent efficacy, co-ordinate effect, &c.; and secondly, each topic or case is discussed according to a regular scheme, which comprises the proposition of the subject-matter, the doubt or question arising upon it, the *primā-faciē* or wrong argument applied to it, the correct argument in refutation of the latter, and the conclusion devolving from it. Some subjects treated of in the M., incidentally as it were, and merely for the sake of argument, belong likewise more to the sphere of philosophic thought than to that of commentatorial criticism, such, for instance, as the association of articulate sound with sense, the similarity of words in different languages, the

inspiration or eternity of the Veda, the invisible or spiritual operation of pious acts, &c. The reputed founder of this system is Jaimini—of unknown date—who taught it in twelve books, each subdivided into four chapters, except the third, sixth, and tenth books, which contain eight chapters each; the chapters, again, are divided into sections, generally comprising several Sūtras or aphorisms, but sometimes only one. The extant commentary on this obscure work is the *Bhāṣya* of 'Sabara-swāmin, which was critically annotated by the great M. authority, Kumārila-swāmin. Out of these works, which, in their turn, quote several others, apparently lost, has arisen a great number of other writings, explaining and elucidating their predecessors. The best compendium, amongst these modern works, is the *Jaimintya-nyāya-māla-vistara*, by the celebrated Mādhavāchārya (q. v.).

MIMES, the name given by the ancients to certain dramatic performances, in which, with little attempt at art, scenes of actual life were represented, sometimes in improvised dialogue. The Greek mimes appear to have been invented by the Greeks of Sicily and Southern Italy. They were a favourite amusement of convivial parties, the guests themselves being generally the performers. Sophron of Syracuse, about 420 B. C., composed many in the Doric dialect, which were much admired, and which Plato was accustomed to read.—The Roman mimes were not borrowed from the Greek, but were of native Italic growth. They were not only far ruder and coarser, but in some respects they were essentially different—the dialogue occupying a smaller place, and mere gesture and mimicry predominating. The humour and satire, however, were often genuine, though rough, and even indecent, and they were greatly relished by all classes; even the patrician Sulla was fond of them.

MIMOSEÆ, a sub-order of *Leguminosæ*, one of the largest natural orders of exogenous plants; distinguished by regular flowers and petals valvate in bud. About 1000 species are known, all natives of warm climates, a few only extending beyond sub-tropical regions in the southern hemisphere. The genera *Acacia* (q. v.) and *Mimosa* are the best known. To



Mimosa Nilotica.

the latter genus belong the Sensitive Plants (q. v.). Some of the larger species of M. are valuable timber trees. The **TALHA** (*Mimosa ferruginea*) is one of the most common trees of Central Africa. They are also trees of great beauty. Some species of the genus *Prosopis*, natives of the western parts of

South America, are remarkable for the abundance of tannin in their pods.

MIMULUS, a genus of plants of the natural order *Scrophulariaceae*, having a prismatic 5-toothed calyx, a somewhat bell-shaped corolla, of which the upper lip is bifid and the lower lip trifid, the lobes not very unequal, two long and two short stamens, and a stigma of two lamellae, which close together upon irritation. The species are mostly herbaceous plants, natives of America. Some of them are very frequent in flower-gardens, and many fine varieties have resulted from cultivation. They sometimes receive the name of *Monkey-flower*. One species, *M. luteus*, a native of Peru and Chili, has become naturalised in many parts of Britain. The little yellow-flowered **MUSK PLANT**, now so common in gardens and on window-sills in Britain, is *M. moschatus*, a native of Oregon and other north-western parts of America.

MINA, or **MNA**, the name of a Greek weight and money denomination, derived from an oriental word *maneh*, signifying 'weight.' The mina contained 100 Drachms (q. v.), and was the sixtieth part of a talent; consequently, as a *weight*, it was equivalent to about $1\frac{1}{4}$ of a pound avoirdupois, varying in different districts to the extent of one-third of a pound more or less, following the fluctuations of the talent itself. As a *money of account*, it preserved the same relation to the talent, and was worth £4, 1s. 3d. See **TALENT**.

MINA BIRD (*Eulabes Indicus* or *Gracula Indica*), a species of Grakle (q. v.), or of a nearly allied genus, a native of many parts of the East Indies, about the size of a common thrush, of a deep velvety black colour, with a white mark on the base of the quill-feathers of the wings, yellow bill and feet, and two large bright yellow wattles at the back of the head. The bill is large, conical; the upper mandible a little curved, and sharp-pointed. The food of the M. B. consists of fruits and insects. It is very lively and intelligent, and possesses a power of imitating human speech, excelled by none of the parrots. It has sometimes been trained to repeat sentences of considerable length. It is therefore in great request, and is often brought to Europe.—Another and larger species is found in Sumatra and some of the other eastern islands, possessing the same power of articulation. It is highly prized by the Javanese.

MINARET, **MINAR**, a tall turret, used in Saracenic architecture. It contains a staircase, and is divided into several stories, with balconies from which the priests summon the Mohammedans to prayer—bells not being permitted in their religion—and is terminated with a spire or ornamental finial. The minarets are amongst the most beautiful features of Mohammedan architecture, and are an invariable accompaniment of the Mosques (q. v.). In India, *Minars*, or pillars of victory, are frequently erected in connection with mosques; some of these are lofty and splendid monuments, that of Kootub, at Old Delhi, being 48 feet 4 inches in diameter at base, and about 250 feet high. They are often built on a plan of a star-like form, and are divided into stories by projecting balconies, like the minarets.

MINCH, the channel which separates the island of Lewes from the counties of Cromarty and Ross, in the north-west of Scotland. Its shores are exceedingly irregular, and its average width is about 23 miles. The *Little Minch*, which separates the island of Skye from that of North Uist and the neighbouring islands in the Outer Hebrides, is upwards of 15 miles in width.

MINCIO (anc. *Mincius*), a river of Northern Italy, a continuation of the Tyrolese stream, the

Sarca, emerges from Lake Garda at Peschiera, and after a course of about 38 miles through the province of Mantua, which it separates from Verona, falls into the Po, 8 miles below the city of Mantua. The M. has constituted an important basis of operation during the wars between Italy and Austria.

MIND. Having adverted in various other articles—**EMOTION**, **INTELLECT**, **WILL**, &c.—to the chief component parts of our mental constitution, all that is necessary under the present head is to consider the definition or precise demarcation of mind as a whole. In this subject, we cannot resort to the common method of defining, which is to assign something more simple and fundamental than the thing to be defined; as when we define gravity to be an *attractive force*, the notions of force and attraction being supposed to be more intelligible than gravity. Mind can be resolved into nothing more fundamental than itself; and therefore our plan must be, to call attention to those individual facts or experiences that are pointed at by the name, and to circumscribe, in some way or other, the whole field of such experiences. For an example of mind, we should probably refer each person to his pleasures and pains, which are a class of things quite apart and peculiar; we should also indicate thoughts or ideas, as mental elements; also exercises of will or voluntary action. There is a sufficient community of nature in those various elements to cause them to be classed by themselves, under a common designation, namely, mind. If any one could be made aware of all the phenomena that have received this designation, he would of course know the meaning in the detail; but this is not enough. Mind being a general or comprehensive name, we ought to see distinctly the common character or attribute pervading all those particular phenomena; the recognition of this common character is the knowledge of mind in general, or the determination of its defining attribute. For the settling of this common attribute, we have another great resource, besides comparing the individual facts, that is, to determine the opposite, or contrast of mind. Now the usually assigned contrast is matter; but more precisely, it is extension, or *the extended*, including both inert matter and empty space. When we are conscious of anything as having the property of Extension, our consciousness is occupied with the object world, or something that is not mind. When we are feeling pleasure or pain, remembering, or willing, we are not conscious of anything extended; we are said to be in a state of subjective consciousness, or to be exhibiting a phenomenon of mind proper. Hence, philosophers are accustomed to speak of the *in-extended mind*, as distinguished from the outer or object world. In one sense, everything that we can take cognizance of is mind or self; we cannot by any possibility transcend our own mental sphere; whatever we know, is our own mind; hence the idealism of Berkeley, which seemed to annihilate the whole external universe. But this large sense of mind is not what is usually meant, and whatever view we take of the reality of the external world, we must never merge the distinction between the consciousness of the Extended—which is also coupled with other truly object properties, as inertia, for matter—and the consciousness of the Inextended, as constituting our feelings and thoughts. This opposition is fundamental and ineradicable, and is expressed in language by a variety of designations; mind and not mind, subject and object, internal and external. The laws and phenomena of the Extended are set forth in the sciences of the external world—Mathematics, Mechanics, Chemistry, &c.; the laws of the Mind proper, or the Subject consciousness, are quite distinct in their nature, and are embodied

in a separate science, called Mental Philosophy, Psychology, &c.

MINDANA'O. See PHILIPPINE ISLANDS.

MINDEN, a Prussian town, in the province of Westphalia, lies on the Weser, in 52° 20' N. lat., and 8° 40' E. long., and is a fortified, closely built city, with a population of 15,000. M., which ranks as one of the oldest towns in Germany, has a stone bridge across the river, originally erected in 1513, and possesses several ancient churches, the most noteworthy of which are the present Roman Catholic Church, completed in 1072, and the cathedral founded at the close of the 12th century. A battle was fought near M. in 1759, in which the French were defeated by an army of Anglo-Hanoverian troops.

The Hanoverian town of M. or *Münden* is situated in the district of Hildesheim, within the province of Göttingen, and at the confluence of the Fulda and Werra. Pop. 6000. M. lies in one of the most picturesque and fruitful parts of Hanover. It has several good manufactories of china, earthenware, sugar, tobacco, and linen, with a noted linen-market. There are alum-works and good coal-mines in the immediate neighbourhood; and it has an extensive river transport-trade in millstones, corn, and timber. M. possesses several architectural remains, indicative of its former more prosperous condition.

MINERAL CHAMELEON. See MANGANESE.

MINERAL KINGDOM, the inorganic portion of nature. Under this term, however, are not included the inorganic products of organic beings, as sugar, resins, &c., although substances more remotely of vegetable or even animal origin are reckoned among minerals, as coal, fossils, &c. To the Mineral Kingdom belong liquid and gaseous, as well as solid substances; water, atmospheric air, &c., are included in it. All the chemical elements are found in the Mineral Kingdom, from which vegetable and animal organisms derive them; but many of the compounds which exist in nature belong entirely to the vegetable and animal kingdoms, and are produced by the wonderful chemistry of life.

MINERAL RESINS. See RESINS, MINERAL.

MINERAL TALLOW, or **HATCHETINE**, a remarkable substance found in several places in Britain, Germany, Siberia, &c., soft and flexible, yellowish white, or yellow, resembling wax or tallow, often flaky like spermaceti, inodorous, melting at 115°–170° F., and composed of about 86 carbon and 14 hydrogen.

MINERAL WATERS. This term is usually applied to all spring waters which possess qualities in relation to the animal body different from those of ordinary water. Mineral waters have been used as remedial agents from a very early period. The oldest Greek physicians had great faith in their curative power, and the temples erected to *Æsculapius* were usually in close proximity to mineral springs; they had recourse to the sulphurous thermal springs of Tiberias (now Tabareah), which are still used by patients from all parts of Syria in cases of painful tumour, rheumatism, gout, palsy, &c., and to the warm baths of Calirrhoe, near the Dead Sea, which are mentioned by Josephus as having been tried by Herod in his sickness. We are indebted to the Romans for the discovery not only of the mineral thermic springs in Italy, but of some of the most important in other parts of Europe, amongst which may be named Aix-la-Chapelle, Baden-Baden, Bath, Spa in Belgium, and many others; and Pliny, in his *Natural History*, mentions a very large number of mineral springs in almost all parts of Europe.

The therapeutic action of mineral waters, or of spas, as they are frequently termed, depends chiefly upon their chemical composition and their temperature, although a variety of other circumstances, as situation, elevation, climate, geological formation, mean temperature, &c., have an important bearing upon the success of the treatment.

The best time for undergoing a course of mineral waters is, in the majority of cases, the months of June, July, August, and September. There are, however, exceptions depending upon climate; for example, at Gastein, celebrated for its thermal springs, the weather is changeable and stormy in June and July, but pleasant in May, August, and September. Early rising is usually advisable during a course of mineral waters, and, as a general rule, the water should be drunk before breakfast, at intervals of about a quarter of an hour between each tumbler, moderate exercise being taken in the intervals. In many cases, bathing is of even greater importance as a remedial agent than drinking. Baths are generally taken between breakfast and dinner; and should never be taken soon after a full meal. The time during which the patient should remain in the bath varies very much at different spas, and the directions of the local physician should be strictly attended to on this point. It is impossible to determine beforehand how long a course of mineral waters should be continued, as this entirely depends upon the symptoms observed during treatment. As a general rule, the treatment should not be protracted beyond the space of six weeks or two months, but on this point the patient must be solely guided by the physician resident at the spa. It cannot be too forcibly impressed upon the patient, that indulgence in the pleasures of the table, and excesses of any kind, frequently counteract the salutary effects of the waters, while perfect mental relaxation is an important auxiliary to the treatment. It will be seen from remarks on the nature of the cases likely to receive benefit from the various kinds of mineral waters, that spas are only suitable for patients suffering from *chronic disorders*.

No classification of mineral waters based upon their chemical composition can be strictly exact, because many springs are, as it were, intermediate between tolerably well characterised groups. The following classification, which is adopted by Dr Althaus, in his *Spas of Europe* (Lond. 1862), is perhaps the most convenient: 1. Alkaline Waters; 2. Bitter Waters; 3. Muriated Waters; 4. Earthy Waters; 5. Indifferent Thermal Waters; 6. Chalybeates; 7. Sulphurous Waters.

1. The Alkaline Waters are divisible into: (a) *Simple Alkaline Acidulous Waters*, of which the chief contents are carbonic acid and bicarbonate of soda. The most important spas of this class are the thermal springs of Vichy and the cold springs of Fachingen, Gailnau, and Bilin. These waters are useful in certain forms of indigestion, in jaundice arising from catarrh of the hepatic ducts, in gall-stones, in renal calculi and gravel, in gout, in chronic catarrh of the respiratory organs, and in abdominal plethora. Vichy (q. v.) may be taken as the representative of this class of springs. (b) *Muriated Alkaline Acidulous Waters*, which differ from the preceding sub-group in additionally containing a considerable quantity of chloride of sodium. The most important spas of this kind are the thermal springs of Ems, and the cold springs of Selters, Luhatschowitz, and Salsbrunn. They are useful in chronic catarrhal affections of the bronchial tubes, the stomach, and the intestines, and the larynx; and the Ems waters possess a high reputation in certain chronic diseases of the womb and adjacent organs. (c) *Alkaline Saline Waters*, of

MINERAL WATERS—MINERALOGY.

which the chief contents are sulphate and bicarbonate of soda. The most frequented of these spas are the warm springs of Carlsbad and the cold springs of Marienbad. Patients suffering from abdominal plethora are those most frequently sent to these spas, which often prove of great service, if the stagnation of the blood is owing to habitual constipation, pressure from accumulated feces, or congestion of the liver, unconnected with diseases of the heart or lungs. These waters, especially those of Carlsbad, afford an excellent remedy for the habitual constipation which so frequently arises from sedentary occupations; the result being much more permanent than that produced by strong purgative waters.

2. The chief contents of the Bitter Waters are the sulphates of magnesia and soda; and the best known spas of this class are those of Püllna, Seidschütz, Sedlitz, Friedrichshall, and Kissingen; although there are two English spas—namely, the bitter water of Cherry Rock, near Kingswood, in Gloucestershire, and the Purton Spa, near Swindon, in Wiltshire—which are, by their chemical composition, admirably suited for the treatment of many cases of disease, and may perhaps even prove superior to the continental spas of this class.—Althaus, *op. cit.* p. 360. These waters act both as purgatives and diuretics, and may therefore be used advantageously in the numerous cases in which it is advisable to excite the action both of the bowels and kidneys.

3. The Muriated Waters are divisible into: (a) *Simple Muriated Waters*, of which the chief contents are a moderate quantity of chloride of sodium or common salt. The chief spas of this class are Wiesbaden and Baden-Baden, which are hot; those of Soden (in Nassau), of Mondorf (near Luxembourg), and of Canstatt (near Stuttgart), which are tepid; and those of Kissingen, Homburg, and Cheltenham, which are cold. They are chiefly employed in cases of gout, rheumatism, scrofula, and abdominal plethora. (b) *Muriated Lithia Waters*, of which the chief contents are the chlorides of sodium and lithium. The discovery of lithia in some of the Baden-Baden springs is so recent that there is as yet no sufficient experience concerning their therapeutic action. In gout, they first aggravate the pain, but then give relief; and in periodic headache, they have been found serviceable. (c) *Brines*, whose chief contents are a large amount of chloride of sodium. Amongst the spas of this kind, those of Rehme, in Westphalia, and Mannheim, in Hesse, have the greatest reputation. They are mostly employed for bathing, and are often of much service in scrofula, anemia, rheumatism, certain forms of paralysis, and catarrh of the mucous membranes. (d) *Iodo-bromated Muriated Waters*, in which, besides a moderate quantity of chloride of sodium, the iodides and bromides of sodium and magnesium are contained in an appreciable quantity. Kreuznach is the most celebrated of the spas of this class. Its waters are used both for drinking and bathing, and are of service in scrofulous infiltrations of the glands, in scrofulous ulcers, in chronic inflammation of the uterus and ovaries, &c. The waters of Hall, in Austria Proper, are also of this class, and have a high reputation in cases of bronchocele or goitre.

4. *Earthy Waters*, of which the chief contents are sulphate and carbonate of lime. The most important waters of this class occur at Wildungen, Leuk, Bath, Lucca, and Pisa. The Wildungen water, which is exported in large quantities, is, according to Dr Althaus, 'a capital diuretic, and not only promotes the elimination of gravel and renal calculi, but by its tonic action on the mucous membrane of the urinary passages, serves to prevent

the formation of fresh concretions. It is also much used for chronic catarrh of the bladder, neuralgia of the urethra and neck of the bladder, dysuria, and incontinence of urina.' The baths of Leuk, in which many patients remain nine hours daily (viz., from 4 A.M. to 10 A.M., and from 2 P.M. to 5 P.M.), until an eruption appears, are chiefly used in chronic skin diseases. The waters of Bath, Pisa, and Lucca, which are thermal, are useful in chronic skin diseases, scrofula, gout, rheumatism, &c.

5. *Indifferent Thermal Waters*, which usually contain a small amount of saline constituents. Of the spas of this class, the most important are Gastein (95° to 118°), Töplitz (120°), Wildbad (96°), Warmbrunn (100°), Clifton (86°), and Buxton (82°). Their most striking effects are to stimulate the skin and excite the nervous system. 'They are especially used in chronic rheumatism and atonic gout; in diseases of the skin, such as prurigo, psoriasis, lichen; in neuralgia and paralysis due to rheumatic and gouty exudations, to parturition, or to severe diseases, such as typhoid fever and diphtheria; in hysteria; and in general weakness and marasmus.'—Althaus, *op. cit.* p. 421.

6. *Chalybeate Waters*, which are divisible into: (a) *Simple Acidulous Chalybeates*, whose chief contents are carbonic acid and bicarbonate of protoxide of iron; and (b) *Saline Acidulous Chalybeates*, whose chief contents are sulphate of soda and bicarbonate of protoxide of iron. These waters are considered in a special article. See CHALYBEATE WATERS.

7. *Sulphurous Waters*, which contain sulphuretted hydrogen or metallic sulphides (sulphurets), or both. The most important sulphurous thermals are those of Aix-la-Chapelle, Baden (near Vienna), Bärèges, Eaux-Chaudes, and Bagnères de Luchon; whilst amongst the cold sulphurous springs, those of Nenn-dorf (in Electoral Hesse) and Harrogate are of great importance. They are extensively used in chronic diseases of the skin, and are of service in many cases in which exudations require to be absorbed, as in swellings of the joints, in old gunshot-wounds, and in chronic gout and rheumatism. In chronic laryngeal and bronchial catarrh, they frequently give relief, and in chronic poisoning by lead or mercury, they favour the elimination of the poison, although to a far less degree than iodide of potassium taken internally. The sulphurous waters are employed externally and internally, and mineral mud-baths are believed by many physicians to form a valuable auxiliary to this treatment.

For further information on this subject, the reader is referred to the work of Dr Althaus (of which free use has been made in this article), and to the *Dictionnaire Général des Eaux Minérales et d'Hydrologie Médicale* of MM. Durand-Fardel, Le Bret, and Lefort.

MINERALOGY (Fr. *miner*, to dig, mine; Gael. *meinn*; Wel. *mon*, ore, mine), the science which treats of minerals. But it does not embrace all that relates to the mineral kingdom. *Simple minerals* alone, or homogeneous mineral substances, are regarded as the subjects of mineralogy; rocks formed by the aggregation of simple minerals, and their relations to each other, are the subjects of Geology (q. v.). This limitation of the term mineralogy is comparatively recent. Geology or geognosy was formerly included in it. The arrangement and description of simple minerals according to their external characters, has been called by Werner and others *Oryctognosy*, but the term has fortunately fallen into disuse. Nor is the study of mere external characters sufficient in mineralogy. The chemical composition of minerals equally demands attention. In the classification of minerals, some mineralogists, as Mohs and Jameson, have regarded only the

external characters, and some, as Berzelius, only the chemical composition; but the results have been unsatisfactory, and the present tendency is in favour of a system which seeks to constitute natural groups by having regard to both.

Some minerals being of great use, and others highly valued for their beauty, have received much attention from the earliest ages. But the ancient naturalists describe few minerals. The first attempt at scientific mineralogy was by George Agricola in the 16th century. The systems of the Swedes Wallerius and Cronstedt, in the latter half of the 18th c., were the first worthy of the name. That of Werner followed, and was extensively adopted. The discoveries of Haüy in crystallography, and the progress of chemistry, gave mineralogy a new character; and then sprung up two schools of mineralogists, one resting chiefly on external characters, and the other on chemical composition.

The chemical classification of minerals is rendered difficult by the endless variety of combination and proportion in the elements of which they are composed, the presence of substances not essential to the mineral, and yet more or less affecting its characters, and the frequent impossibility of determining what is to be deemed essential, and what accidental. Chemical purity is almost never found in nature. Even the purest diamond, when burned, leaves some traces of ash; and the various colours of diamond, quartz, and other minerals are due to the presence of substances which are often in so small quantity as not to affect their crystalline forms or other physical properties. Again, some minerals of identical chemical composition differ in their crystallisation, so that an arrangement founded upon it would separate them too widely. There are also many minerals which are often found in an uncrystallised state, and others which are always so. In the arrangement of minerals into natural groups, their chemical composition, although not alone to be regarded, is of the first importance, so that the place of a new mineral in the system can never be determined without analysis; and in determining the nature of a mineral, chemical tests, such as the application of acids, are continually resorted to. It is also necessary to know its specific gravity, and how it is acted upon both by a moderate heat and by the blowpipe. An examination of the crystalline forms, with measurement of the angles of the crystals, is often sufficient to distinguish minerals which have otherwise much resemblance. The cleavage of crystals is also important, a readiness to split in planes parallel to certain of their faces only, by which the primitive form of the crystal may be ascertained. Minerals not crystallised exhibit important varieties of structure, as laminated, fibrous, granular, &c. Certain peculiarities of form are also frequently characteristic of uncrystallised minerals, as mamillary, botryoidal, &c. Minerals exhibit, when broken, very different kinds of fracture, as even, conchoidal, splintery, &c. Opacity, translucency, and transparency, are more or less characteristic of different kinds: electric and magnetic properties demand attention; and very important characters are derived from lustre, which in some minerals is metallic, in others semi-metallic, in others pearly, vitreous, &c. Colour is not generally of much importance, but in some minerals it is very characteristic. Hardness and tenacity are very important, and are of all various degrees. A few fluid, and even a few gaseous substances, are included in mineralogical systems. Unctuousity and other peculiarities to be ascertained by the touch, are very characteristic of some minerals; peculiarities of taste and smell belong to others.

Mineralogy has very important relations with

geology, which cannot be studied without regard to the mineral constituents of rocks. The mineral composition of soils greatly affects vegetation and agriculture. The economical uses of minerals are also very important and various. It is enough merely to allude to coal, lime, salt, and the metallic ores. Naphtha, petroleum, bitumen, asphalt, &c. are of well-known utility; and a high value has always been attached to gems and other ornamental stones.

MINERVA, the name of a Roman goddess, identified by the later Græcising Romans with the Greek *Athene*, whom she greatly resembled, though, like all the old Latin divinities, there was nothing anthropomorphic in what was told concerning her. Her name is thought to spring from the same root as *mens* (the mind) and *monere* (to warn or advise); and the ancient Latin scholar and critic, Varro, regarded her as the impersonation of divine thought—the plan of the material universe of which Jupiter was the creator, and Juno the representative. Hence all that goes on among men, all that constitutes the development of human destiny (which is but the expression of the divine idea or intention), is under her care. She is the patroness of arts and trades, and was invoked alike by poets, painters, teachers, physicians, and all kinds of craftsmen. She also guides heroes in war; and, in fact, every wise idea, every bold act, and every useful design, owes something to the high inspiration of this virgin goddess. Her oldest temple at Rome was that on the Capitol, but she had another on the Aventine. Her festival was held in March, and lasted five days, from the 19th to the 23d inclusive.

ATHENE, or PALLAS ATHENE, the Greek goddess corresponding, as we have said, to the Roman Minerva, was one of the few truly grand ethical divinities of Greek mythology. Different accounts are given of her origin and parentage, probably from the jumbling together of local legends; but the best known, and in ancient times, the most orthodox version of the myth represented her as the daughter of Zeus and Metis. Zeus, we are told, when he had attained supreme power after his victory over the Titans, chose for his first wife Metis (Wisdom); but being advised by both Uranus and Gæa (Heaven and Earth), he swallowed her, when she was pregnant with Athene. When the time came that Athene should have been born, Zeus felt great pains in his head, and caused Hephestus (Vulcan) to split it up with an axe, when the goddess sprang forth—fully armed, according to the later stories. Throwing aside the thick veil of anthropomorphism which conceals the significance of the myth, we may see in this account of Athene's parentage an effort to set forth a divine symbol of the combination of power and wisdom. Her father was the greatest, her mother the wisest of the gods. She is literally born of both, and so their qualities harmoniously blend in her. It is possible that the constant representation of her as a strictly maiden goddess, who had a real, and not a merely prudish antipathy to marriage, was meant to indicate that qualities like hers could not be mated, and that, because she was perfect, she was doomed to virginity. She was not, however, a cold unfeeling divinity; on the contrary, she warmly and actively interested herself in the affairs of both gods and men. She sat at the right



Minerva :
From Colossal Head in
British Museum.

hand of Zeus, assisting him with her counsels; she helped him in his wars, and conquered Pallas and Encelados in the battles of the giants. She was the patroness of agriculture, invented the plough and rake, introduced the olive into Attica, and (in harmony with her character as the personification of active wisdom) taught men the use of almost all the implements of industry and art; and is said to have devised nearly all feminine employments. Philosophy, poetry, and oratory were also under her care. She was the protectress of the Athenian state, was believed to have instituted the court of justice on Mars' Hill (the Areiopagus). As a warlike divinity, she was thought to approve of those wars only which were undertaken for the public good, and conducted with prudence; and thus she was regarded as the protectress in battle of those heroes who were distinguished as well for their wisdom as their valour. In the Trojan wars, she favoured the Greeks—who, in point of fact, were in the right. Her worship was universal in Greece, and representations of her in statues, busts, coins, reliefs, and vase-paintings were and are numerous. She is always dressed, generally in a Spartan tunic, with a cloak over it, and wears a helmet, beautifully adorned with figures of different animals, the ægis, the round Argolic shield, a lance, &c. Her countenance is beautiful, earnest, and thoughtful, and the whole figure majestic.

MINERVINO, a town of the Neapolitan province of Bari, called the *Balcony of Puglia*, from the extensive view it commands of several cities. It stands on a fine hill, and enjoys excellent air. Pop. 7200.

MINES, in Law. In England and Ireland, the crown has the right to all mines of gold and silver; but where these metals are found in mines of tin, copper, iron, or other baser metal, then the crown has only the right to take the ore at a price fixed by statute. As a general rule, whoever is the owner of freehold land, has a right to all the mines underneath the surface, for his absolute ownership extends to the centre of the earth. When the land is given by will or otherwise to a tenant for life, while a third party has the reversion, then the tenant for life is held to be entitled not to open mines which have never before been opened, but to carry on such as have been open, and are going mines. So in the case of a lease of lands for agricultural purposes, if nothing is said as to mines, the tenant is not entitled to open any mines, for that would be committing waste. It is not uncommon for one person to be owner of the surface of the land, and another to be owner of the mines beneath; or several persons may be owners of different kinds of mines lying above each other in the different strata. Many questions have been raised lately between railway companies and mine-owners as to their respective rights and liabilities. When a railway passes through a mining country, it is generally optional with the owner to sell to the company merely the surface of the lands, reserving to himself the mines beneath; and it is usually provided that, if ever the owner work his mines so near to the railway as to endanger its stability, the company must have notice of that fact, and then, if necessary, may purchase the mines immediately under the railway. But the courts have determined that even though the owner of the land reserve his right to minerals, he is nevertheless prevented, by common law, from working the mines immediately under the railway, so as to endanger the use of the railway. In these matters the law of Scotland does not at all differ, though, as to other points of the

common law, some differences of no great importance occur. See Paterson's *Compendium of English and Scottish Law*.

The practical working of mines and collieries in any part of Great Britain has been controlled by certain recent acts of parliament, with a view to insure the greater safety of the persons working them, and to prevent the employment of women and children. Thus, the owners of mines are prohibited, by the statute 5 and 6 Vict. c. 15, from employing any female whatever in any underground operation. Moreover, boys under 12 years of age cannot be lawfully employed, under a penalty to be incurred by the owner of £10. No proprietor or worker of a mine or colliery is allowed to pay the wages of the men at any tavern, public-house, beer-shop, or place of entertainment, or any office or outhouse connected therewith. No person under the age of 18 is to be employed at the entrance of any mine, to have charge of the steam-engine or windlass, or other machinery and tackle for letting down and bringing up the men. Inspectors are appointed by government for the express purpose of visiting mines, and seeing that the statutes are complied with. The statutes in question now apply not only to coal-mines and collieries, but to mines of ironstone and of the coal-measures. Whenever an inspector, on examination, finds anything dangerous or defective in the mine, he is bound to give notice to the owner, so that it may be amended. In case of accidents occurring in the mine, caused by explosion, and resulting in loss of life or bodily injury, the owner is bound, within twenty-four hours thereafter, to send notice to the Secretary of State, and to the district inspector of mines, specifying the probable cause of the accident.

MINES, MILITARY, constitute at once one of the most important departments in military engineering, and a very formidable accessory both in the attack and defence of fortresses. A military mine consists of a gallery of greater or less length, run from some point of safety under an opposing work, or under an area over which an attacking force must pass, and terminating in a chamber which, being stored with gunpowder, can be exploded at the critical moment. Mines are of great use to the besiegers in the overthrow of ramparts and formation of a breach; the *countermines* of the besieged in undermining the glacis over which the assaulting column must charge, and blowing them into the air, or in destroying batteries erected for breaching, are equally serviceable. But far above the actual mischief wrought by the mine—often very great—is its moral influence on the troops, and especially on the assailants. The bravest soldiers, who advance without flinching to the very mouth of the cannon *which they see*, will hesitate to cross ground which they suppose to be undermined, and on which they may be dashed to destruction in a moment, without the power of averting the *unseen danger*. The first employment of mines was very ancient, and merely consisted in obtaining an entrance to the interior of towns by passing beneath the defences; but this soon fell into disuse, the chances of success being merely those of introducing a body of men before the besieged discovered the mine. The next use occurred during the middle ages, and was more destructive. The miners went no further than beneath the wall, then diverged to either side, and undermined the wall, say for about 100 feet. During the process, the wall was sustained by timber-props; and these being ultimately set on fire, the wall fell; and the besiegers, who had awaited the opportunity, rushed in at the breach. This use of mines of *attack* necessitated those of *defence*, which obtained in medieval times, and have ever since kept, the

MINES.

name of 'countermines.' The earliest subterranean defence consisted of a gallery surrounding the fort in advance of the foot of the wall, and termed an 'envelope-gallery.' From this the garrison would push forward small branches or tributary galleries, whence they could obtain warning of the approach of hostile miners, and by which they succeeded, at times, in overthrowing the battering-rams or towers of the besiegers.

Two centuries appear to have elapsed between the introduction of gunpowder into European warfare and its application to subterranean operations. The first instance of this occurred in 1503, at the siege of the Castello del Uovo, in the Bay of Naples, which a French garrison had succeeded in holding for three years against the combined Spanish and Neapolitan forces. At length, a Spanish captain, Pedro Navarro, devised a gallery into the rock, which he stored with powder, whereof the explosion, hurling portions of the rock and many of the besieged into the sea, caused the immediate capture of the place. At once the use of mines of attack spread throughout Europe; and so irresistible were they soon considered, that it was not unusual for the besieger, after preparing his mine, to invite the besieged to inspect it, with the view of inducing the latter at once to surrender. Defence soon availed itself of the new power, and retaining the envelope-gallery as a base, ran small countermines in many directions, to ascertain by hearing the approach of the enemy's sappers—his work being audible, to a practised ear, at a horizontal distance of 60 feet. Small charges were then exploded, which, without creating surface disturbance, blew in the approaching gallery, and buried the sappers in its ruins. Thus commenced a system of subterranean warfare, requiring the greatest risk and courage, in which the operator was in constant danger of being suffocated. Of course, in such a system, the balance of advantage lay with the besieged, who had ample opportunities, before the siege commenced, of completing his ramifications in every direction, and, if desirable, of retvetting them with masonry, which much diminished the chance of being blown in; while the assailant, no longer able to cross the glacis by an open zigzag trench, was compelled to engage in a most uncertain subterranean advance. The French engineer Belidor, in the 18th c., restored the advantage to the attack, by demonstrating that the explosion of a very large mass of powder in a mine which had not yet entered the labyrinth of defensive mines, effected the destruction of the latter for a great space round, clearing the way with certainty for the hostile advance. Although the primary purpose of a mine is the explosion of a charge of powder, they are often used as a means of communication between different works, or between different parts of the same work, some being constructed of size sufficient to permit the passage of four men abreast, of horses, and of artillery.

It is, of course, impossible, in such a work as this, to give even an outline of the professional part of military mining; but the article would be incomplete without some allusion to the main principles.

Mines are either vertical—when they are called *shafts*—horizontal, or inclined, in either of which cases, they are 'galleries,' the word 'ascending' or 'descending' being added, if there be inclination. The dimensions range from the 'great gallery,' six feet six inches by seven feet, to the 'small branch'—the last diminutive of the gallery—which has but two feet six inches height, with a breadth of two feet. The most frequent work is the 'common gallery,' four feet six inches by three feet, which is considered the easiest for the miner.

The sapper's tools are numerous, but most in

request are his shovel, pickaxe, and above all, his 'push-pick' (see fig. 1); he has besides a barrow, a small wagon, a lamp, and other accessories. As he advances, it is necessary to line his gallery, always at the top, and almost always at the sides. This he does either by frames—which resemble door-frames, and serve to retain horizontal planks or 'sheeting' in position against the earth—or by cases somewhat resembling packing-cases, of little depth, which are used to form the sides and top. With cases,



Fig. 1.—Push-pick: Length, 1 foot 10 inches.

advance one foot and a half per hour; while with frames, the progress is barely more than half that amount.

When a mine is exploded, the circular opening on the surface is called the *crater*; the *line of least resistance* is the perpendicular from the charge to the surface; the half-diameter of the crater is its radius; and the *radius of explosion* is a line from the charge to the edge of the crater, on the hypotenuse of the triangle, the revolution of which would form the cone. When the diameter equals the line of least resistance, the crater is called a one-lined crater; when it doubles that line, a two-lined crater; and so on. The common mine

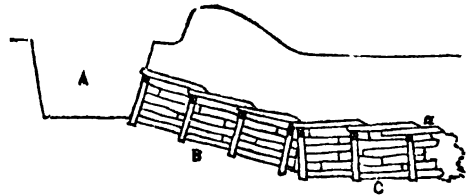

Fig. 2.—Mine supported by Frames, in process of construction from a Trench: A, trench; B, descending gallery; C, gallery; a, roofing plank not yet pushed out to its full length.

for ordinary operations is the two-lined crater; and for this the charge of powder should—in ground of average weight and tenacity—be in pounds a number equal to one-tenth of the cube of the line of least resistance in feet; for example, at a depth of 18 feet, the charge should consist of 583 pounds. In sur-charged mines, or globes of compression, as introduced by Belidor, vastly greater charges are employed, and craters of six lines are sometimes produced. The rules, in these cases, for computing the charges vary exceedingly, according to different engineers, and in every case are very complicated. Previous to the explosion, the gallery is filled up behind the charge, or *tamped*, with earth, sand-bags, &c., to prevent the force of the powder wasting itself in the mine. This tamping must extend backwards for one and a half or twice the length of the line of least resistance. The mine is commonly fired by means of a powder-hose, composed of strong linen, enclosed in a wooden pipe laid carefully through the tamping, or by wires from a voltaic battery.

In the annexed figure (fig. 3), is shown a system of countermines. The magistral gallery, AAA, is immediately within the wall of the counterscarp, through orifices in which it derives light and air, and by its loopholes, the defenders can take in rear any enemy who might obtain momentary possession of the ditch. Further in advance, and

reached by galleries of communication B, is the envelope-gallery C, from which radiate the listeners D, D. To prevent the enemy's advances, these

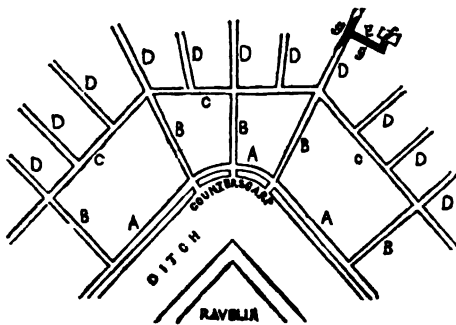

Fig. 3.—System of Countermines:

AAA, magistral gallery; BBB, galleries of communication; CCC, envelope gallery; DDD, listeners; E, branch ending in chamber *f*.

listeners should not be more than about 54 feet apart. Besides listening, they are used for aggressive purposes, such as driving branches and blowing in or up hostile works. Modern engineers object to the envelope-gallery, as affording too good a base to the enemy, should he obtain possession of it; and either dispense with it altogether, or merely retain it in short sections. At suitable points among the mines, small magazines for tools and powder are formed; and at about every 30 yards, loop-holed doors of great strength are made, to stop the advance of an enemy, should he break into the galleries.

In the course of their excavations, hostile miners frequently meet, or approach within a few feet. It becomes, then, merely a question of time which shall destroy the other; shells, pistols, pikes, and petards, as well as small mines, being used with murderous effect.

Provision is made for pumping foul air out of mines; but such military works are in general badly ventilated.

MINGHETTI, CAVALIERE MARCO, a distinguished Italian writer and statesman, and present (1864) prime minister of Italy, was born at Bologna, on the 8th November 1818. He belonged to an opulent commercial family, and on the termination of his studies, entered on an extensive continental tour, with the object of closely investigating the political, social, and economical institutions of France, Germany, and more especially of Britain. On his return from travelling, he published his maiden essay, inculcating the great commercial advantages of free trade, as existing in England, and espousing with warmth the economical views of Richard Cobden. In 1846, M. opened his political career by starting a journal of liberal tendencies, soon after the advent of Pius IX. to power; in 1847, he was elected member of the *Consulta delle Finanze*, and in 1848 became minister of public works. Having speedily lost faith in papal progression, M. withdrew from office, and joined the army of Charles Albert in Lombardy, where he was warmly received by the king, and appointed captain. After the battle of Goito, he was promoted major; and for his bravery in the engagement of Custoza, he received from the king the cross of the Knights of St Maurizio. On the conclusion of the war, M. resumed his study of political economy, and gained the confidence of Cavour, by whom he was consulted during the conferences of Paris. He subsequently became

secretary for foreign affairs, and only resigned with Cavour on the peace of Villafranca. In 1860, under the presidency of Cavour, M. became minister of the interior, a post he still occupied at the death of Cavour. In 1863, he succeeded Farini as prime minister. His chief work is *Della Economia pubblica e delle sue Attinenze Colla morale, e Col diritto*, published in 1859.

MINHO, a province of Portugal. See **ENTRE DOURO E MINHO**.

MINHO (Span. *Miño*, anc. *Minius*), a river of Spain and Portugal, rises in the north-east of Galicia, in lat. about 43° 20' N., long. about 7° 15' W. Its course is south-west through the modern Spanish provinces of Lugo and Orense, after which, continuing its course, and forming the northern boundary of the Portuguese province of Minho, it falls into the Atlantic Ocean. Its length, exclusive of windings, is 130 miles, and it is navigable for small craft 23 miles above its mouth.

MINIATURE-PAINTING, or the painting of portraits on a small scale, originated in the practice of embellishing manuscript books. See **MANUSCRIPTS, ILLUMINATION OF**. As the initial letters were written with red lead (Lat. *minium*), the art of illumination was expressed by the Low Lat. verb *miniare*, and the term *miniatura* was applied to the small pictures introduced. After the invention of printing and engraving, this delicate art entered on a new phase; copies, in small dimensions, of celebrated pictures came to be in considerable request, and, in particular, there arose such a demand for miniature-portraits, that a miniature, in popular language, is held to signify 'a very small portrait.' Soon after their introduction, miniature-portraits were executed with very great skill in England. Holbein (b. 1498, d. 1554) painted exquisite miniatures, and having settled in London, his works had great influence in calling forth native talent. The works of Nicholas Hilliard (b. at Exeter 1547, d. 1619) are justly held in high estimation. Isaac Oliver (b. 1556, d. 1617) was employed by Queen Elizabeth and most of the distinguished characters of the time; his works are remarkable for careful and elaborate execution; and his son, Peter Oliver, achieved even a higher reputation. Thomas Flatman (b. 1633, d. 1688) painted good miniatures. Samuel Cooper (b. London 1609, d. 1672), who was, with his brother Alexander, a pupil of his uncle, Hoskins, an artist of reputation, carried miniature-painting to high excellence. Cromwell and Milton sat to him—he was employed by Charles II.—and obtained the highest patronage at the courts of France and in Holland. Till within these few years, miniature-painting continued to be successfully cultivated in Britain; but it has received a severe check since photography was invented, and most of the artists of the present time, who exercised their talents in this exquisite art, have left it for other branches of painting. As to technical details, the early artists painted on vellum, and used body-colours, that is, colours mixed with white or other opaque pigments, and this practice was continued till a comparatively late period, when thin leaves of ivory, fixed on card-board with gum, were substituted. Many of the old miniature-painters worked with oil-colours on small plates of copper or silver. After ivory was substituted for vellum, transparent colours were employed on faces, hands, and other delicate portions of the picture, the opaque colours being only used in draperies and the like; but during the present century, in which the art has been brought to the highest excellence, the practice has been to execute the entire work, with the exception of the high lights in white drapery,

with transparent colours. In working, the general practice is to draw the picture very faintly and delicately with a sable hair-pencil, using a neutral tint composed of cobalt and burned sienna. The features are carefully made out in that way, and then the carnations, or flesh-tints, composed of pink, madder, and raw sienna, gradually introduced. The drapery and background should be freely washed in, and the whole work is then brought out by hatching, that is, by painting with lines or strokes, which the artist must accommodate to the forms, and which are diminished in size as the work progresses. Stippling, or dotting, was a method much employed, particularly in early times; but the latest masters of the art preferred hatching, and there are specimens by old masters, Perugino, for instance, executed in that manner.

MINIM, the name of one of the notes in modern music, the value of which is the half of a semibreve.

MINIMS (Lat. *Fratres Minimi*, Least Brethren), so called, in token of still greater humility, by contrast with the *Fratres Minores*, or Lesser Brethren of St Francis of Assisi (q. v.), an order of the Roman Catholic Church, founded by another St Francis, a native of Paula, a small town of Calabria, about the middle of the 15th century. Francis had, as a boy, entered the Franciscan order; but the austerities of that rule failed to satisfy his ardour, and on his return from a pilgrimage to Rome and Assisi, he founded, in 1453, an association of Hermits of St Francis, who first lived in separate cells, but eventually were united in the conventual life in 1474, and established in several places in Calabria and Sicily. Francis was also invited into France by Louis XI., and founded houses of his order at Amboise and at Plessis-les-Tours. In Spain, the brethren took the name of 'Fathers of Victory,' in memory of the recovery of Malaga from the Moors, which was ascribed to their prayers. It was not till very near the close of the life of Francis that he drew up the rule of his order. It is exceedingly austere, the brethren being debarred the use not only of meat, but of eggs, butter, cheese, and milk. Notwithstanding its severity, this institute attained considerable success; its houses, soon after the death of Francis (1502), numbering no fewer than 450. It has reckoned several distinguished scholars among its members; but in latter times, the order has fallen into decay, being now limited to a few houses in Italy, the chief of which is at Rome. The superiors of convents in this order are called by the curious name of *Corrector*, the general being styled *Generalis Corrector*. A corresponding order of females had its origin about the same time, but this order also has fallen into disuse.

MINING is a general term for the underground operations by which the various metals and other minerals are procured. It has been practised to some extent from the remotest times, as is proved by the reference to it in the 28th chapter of the book of Job. In its proper sense, the art was certainly known to the ancient Phœnicians and Egyptians, and also to the Greeks and Romans. Mining operations were carried on in Britain by the latter at the time of the Roman Conquest. After the Norman Conquest, Jews, and, at a later time, Germans were largely employed in our mines. The use of gunpowder as a blasting material was begun in 1620, and led the way to many improvements in mining. But until the introduction of powerful engines for pumping water, about the beginning of the 18th c., the miner could not proceed far with underground works. See STEAM-ENGINE.

There are two principal methods of mining: one of which is adopted where the mineral occurs in

veins or lodes, as copper and lead ore; and the other where the mineral occurs in more or less parallel beds, as coal. Mining in alluvial deposits is a third method, but less extensively practised.

In mines like those of Cornwall and Devonshire, where most of the copper and tin of Great Britain, and also some of the lead is obtained, the ores occur in veins filling cracks or fissures in the rocks. Such veins are termed lodes, to distinguish them from veins of quartz and other non-metallic minerals. Lodes are very irregular in size, and in the directions they take, though they usually follow one general line.

Fig. 1 shows a portion of a lode, where *a* represents the main or 'champion' lode, and *b* the



Fig. 1.—Portion of a Lode or Mineral Vein.

branches, called *feeders*, *shoots*, and *strings*. Mineral veins sometimes extend for several miles through a country; but they expand and contract so much, and split up into so many branches, that it is perhaps uncertain whether the same lode has ever been traced for more than a mile. Veins seldom deviate more than 45 degrees from a perpendicular line, and descend to unknown depths. They penetrate alike stratified and unstratified rocks. Those veins which run east and west have been observed to be the most productive.

Fig. 2 shows a section of a Cornish mine across the lodes *l, l, l*; *a* is the engine-shaft, in which are the pumps and the ladders for ascent and descent; *b, b* are *whim-shafts* for raising the ore,

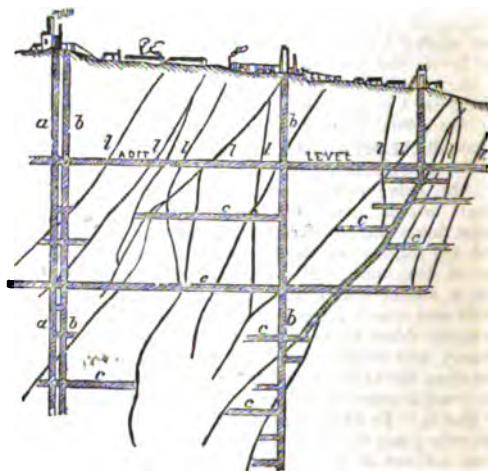

Fig. 2.—Cross-section of a Cornish Mine.

which is done by means of buckets. The adit, or day-level, is a long passage to which the water of the mine is pumped up and conveyed away. Some adits are made to traverse several mines. The great adit which drains the mines of Glennap and Redruth, in Cornwall, is 30 miles long. At *c, c, c*, are cross cuts, by which the workings on the different lodes are connected.

Fig. 3 is a partial section in the direction of a lode, and therefore at right angles to fig. 2. It

shews the horizontal galleries, termed *levels*, *a*, which are driven upon the lode, and some of the small upright shafts, called *winces*, *b*. Levels are

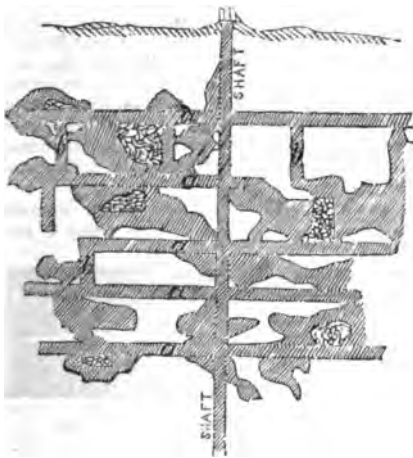

Fig. 3.

generally about ten fathoms (60 feet) apart. They are rarely perpendicular above each other, as they follow the inclination of the vein. In the section, the richer portions of the lode, termed 'bunches,' are shewn shaded; and where these have been removed, and their place filled with rubbish, angular fragments are represented. This is necessary to prevent the sides of workings from falling in. The bottom of the engine shaft is the lowest portion of the mine. It is called the *sump*, and is the place where the water from the various levels and workings collects, in order to be pumped up to the adit. The galleries and shafts in an extensive mine are very numerous, making it altogether a very complicated affair. The shafts, however, have all distinct names, and the levels are known by their depth in fathoms, so that particular places are as easily found as streets in a town. The underground workings of the Consolidated Mines, which are the largest in Cornwall, being a conjunction of four mines, are 55,000 fathoms, or 63 miles, in extent. In working out the lode between one level and another, the miner usually goes upwards, it being easier to throw down the ore than to raise it up. He works with the light of a candle, stuck with clay to the side of the mine. His tools are few—namely, a pick, a hammer, and some wedges where the vein is soft and friable; but it is generally hard enough to require blasting, in which case he uses a *borer* or *jumper*, and some smaller tools for cleaning and stemming the hole which is made. The ore is filled into wagons, and then drawn along the gallery to the shaft, to be raised to the surface in *kibbles*.

A vein may be 30 or 40 feet thick, and so poor in ore as not to be worth working; and, on the other hand, it may be only a few inches thick, and yet its richness may amply repay the labour of extracting it. In extensive mines, portions of the ore are here and there left in the lode, so as to furnish a steady supply when other parts are unproductive. These are called the *eyes* of the mine. When such portions are wholly removed, in the case of abandoning the mine, or from any other cause, the operation is termed *picking out the eyes of the mine*.

The old plan of ascending and descending the mines by ladders, so destructive to the health of the miners, is still largely in use. The ladders were

formerly made perpendicular, and 50 feet long, but are now generally reduced to 25 feet, and set with a slope. There is a platform at the bottom of each called a *sollar*, with a man-hole in it leading to the next ladder beneath. Some of the Cornish mines are half a mile deep, so that it takes the miner an hour to reach the surface after he is done with his work; most of the journey being accomplished on wet, slippery ladders. The bad effects of the fatigue so produced is augmented by the fact, that the men come from a constant temperature of 80° or 90° F. below, to one of perhaps 30° or 40° on the surface.

A great improvement on the ladder system is now in operation in several of the deep Cornish mines. It is a method first introduced into the deep mines of the Harz, and called the *Fahr-kunst*. The plan of this 'man-engine' is this. Two rods descend through the depth of the shaft, and upon these bracket-steps are fixed every 12 feet. The rods move up and down alternately through this distance by means of a reciprocating motion. Fig. 4 represents the arrangement when the rods are at rest. If the miner wishes to ascend, he places himself on the step *a* of the rod A, and is raised by the first movement of this rod to the level of *b* on the rod B (see fig. 5), to which he now

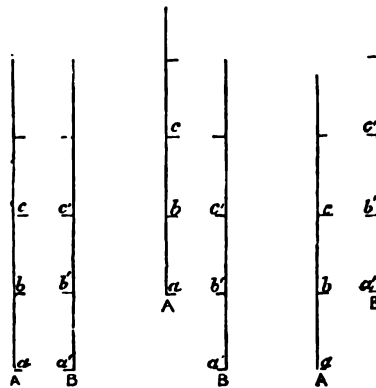

Fig. 4.

Fig. 5.

Fig. 6.

Diagrams to illustrate 'Man-engine.'

crosses. The next movement raises the rod B, and brings the step *b'* up to the level of *c* on A (fig. 6), to which he next crosses; and so, ascending stage by stage, he reaches the top. The descent is, of course, accomplished in the same way.

Some of the Cornish pumping-engines are very large and powerful. The cylinder of one of the largest is 7 feet 6 inches in diameter. With the expenditure of one bushel of coal, it can raise 100,000,000 lbs. weight one foot high; this is called its 'duty.' It lifts nearly 800 gallons of water per minute, and its cost was about £8000.

In Cornwall, the miners are divided into two classes: one of them called *tributers*, who take a two months' contract of a portion of the lode, the price being a certain percentage on the dressed ore they produce; the other called *tutmen*, who are employed in sinking shafts, driving levels, &c., and are paid so much per fathom.

A detailed analysis of one of the largest Cornish copper mines, published some years ago, shews that in that year it produced, in round numbers, 16,000 tons of ore, realising £90,000, and yielding a net profit of about £16,000. It employed about 700 miners, 300 labourers, 300 boys, and 300 women and girls. The cost for coal was £1800; for malleable iron and steel, £1300; for foundry castings, £2000;

MINING.

for ropes, £1000; for candles, £1800; for gunpowder, £2000; and for timber nearly £3000.

Mining for Coal.—The minerals of the carboniferous formation, at least those which occur in beds or strata, as coal and clay ironstone, are mined, as has been already said, in a different way from metallic veins. Originally deposited in a horizontal position, they have been so altered by movements in the earth's crust, that they are rarely found so now. They are more generally found lying in a kind of basin or trough, with many minor undulations and dislocations. But however much twisted out of their original position, the different seams, more or less, preserve their parallelism, a fact of great service to the miner, since beds of shale, or other minerals, of a known distance from a coal-seam, are often exposed when the coal itself is not, and so indicate where it may be found.

The great progress made of late years in the science of geology has made us so minutely acquainted with all the rock formations above and below the coal-measures, that it is now a comparatively easy matter to determine whether, in any given spot, coal may or may not be found. Nevertheless, large sums are still occasionally, as they have in past times been very frequently, wasted in the fruitless search for coal, where the character of the rocks indicates formations far removed from coal-bearing strata.

When there are good grounds for supposing that coal is likely to be found in any particular locality, before a pit is sunk, the preliminary process of 'Boring' (q. v.) is resorted to, in order to determine whether it actually does exist there, and if in quantity sufficient to make the mining of it profitable. The usual mode of 'winning' or reaching the coal is to sink a perpendicular shaft as at *a*, fig. 7; but sometimes a level or cross-cut mine *b*,

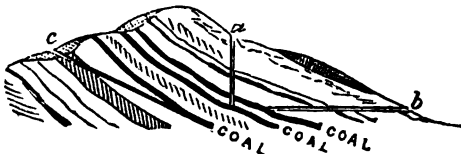

Fig. 7.—Diagram shewing methods of 'winning' the Coal.

and at other times, an inclined plane or 'dook' *c*, is adopted. Before the introduction of pumping-engines, all coal-workings were drained by means of a level mine (*b*) called a *day-level*, driven from the lowest available point on the surface, and no coal could be wrought at a lower depth than this, because there were no means of removing the water.

When the shaft has been sunk to the necessary depth, a level passage, called the *dip-head*, or *main-level*, is first driven on each side, which acts as a roadway or passage, and, at the same time, as a drain to conduct the water, which accumulates in the workings, by means of a gutter on one side, to the lodgment at the bottom of the shaft. This level is the lowest limit of the workings in the direction of the dip, and from it the coal is worked out along the rise of the strata till the outcrop at the surface is reached, unless some fault, trap dyke, or other cause should stop the workings sooner. There are two principal methods of mining the coal. One is called the 'stoop-and-room' system, and is used for thick seams; the other is called the 'long-wall' system, and is adopted for seams under four feet in thickness. Fig. 8 represents a portion of a mine wrought on the *stoop-and-room* plan, where the coal is taken out in parallel spaces of say 15 feet wide, intersected by a similar series of passages, at right angles. Between these 'rooms,' as they

are called, 'stoops' of coal, about 30 feet each way, are left for the support of the 'roof' of the seam. Larger stoops are left at the bottom of the

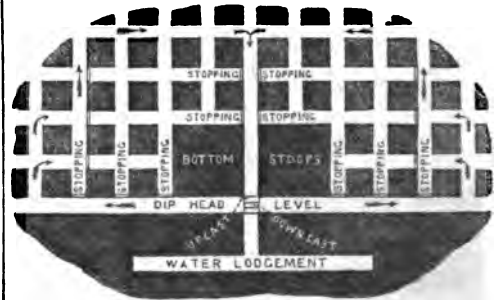

Fig. 8.—Plan of part of a Coal Mine, shewing 'Stoop-and-Room' Workings.

shaft, in order to secure greater stability there. There is a modification of this plan adopted at Newcastle, called the 'board-and-pillar' method, by which a certain number of the stoops or pillars are removed altogether, after which the roof falls in, and forms a mass of ruins, termed a 'goaf.'

The *long-wall* system consists in extracting the entire seam of coal at the first working, the overlying strata being supported by the waste rock from the roof of the workings. It is necessary, however, to leave large stoops at the bottom of the shaft for its support, as in the stoop-and-room method. In long-wall workings, roads of a proper height and width require to be made for communication with the different parts of the mine. Along the sides of these roads, walls are built, from stone got in the workings, so as to maintain them in a proper state for traffic and ventilation.

The collier's usual mode of extracting the coal from its bed is this: With a light pick, he undercuts the coal-seam, technically termed 'holing,' for two or three feet inwards, and then, by driving in wedges at the top of the seam, he breaks away the portion which has been holed. Blasting is occasionally, but not often resorted to. The coal, when separated from its bed, is put on small hutches, which are generally drawn by horses, but sometimes by engine-power, along the roads to the bottom of the shaft, and hoisted to the surface.

The shaft is perhaps the most important portion of the workings of a coal-pit. The section shewn in fig. 9 represents the principal parts of one. The upper part shews the pit-head arrangements, the central part shews the force-pump, &c., and the lower part shews the pit bottom arrangements. To make the section complete, the reader must imagine a great depth to intervene at the gaps *A* and *B*. There are four divisions in this shaft: the two centre ones, *a, a*, are used for sending up and down the men and the coal; the one on the right side, *b*, contains the pumps; and the remaining one on the left, *c*, is for withdrawing the vitiated air from the mine, and has usually a furnace at the bottom of it. This arrangement is adopted where there is only one shaft to a mine. Where there are two, the second one is used as a ventilating shaft for the foul air. Since the dreadful accident at the Hartley Colliery, in January 1862, in which over 200 persons lost their lives by the beam of the engine giving way, and by its fall breaking in the sides of, and thus closing up the shaft, an act of parliament has been passed making it imperative to have two shafts, or at least two outlets, to every coal-mine, as a means of escape, in case of an accident to one of them.

MINING—MINISTER.

The cages *d, d*, by which the colliers ascend and descend, are also used for raising the coal. They

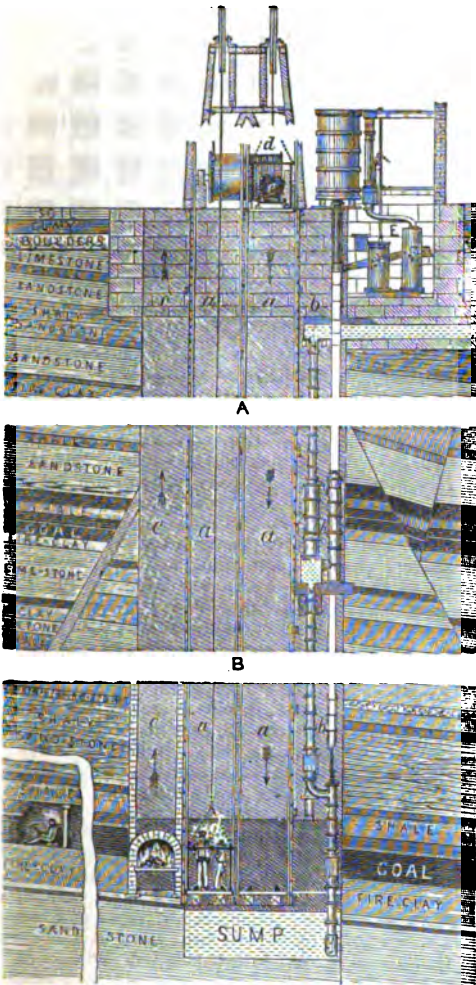

Fig. 9.—Vertical Section of the Shaft of a Coal-pit, with a Detached Portion, shewing a Miner at work on the Coal Seam.

are merely square plats of timber, with rails across them, for the convenience of running off and on the coal-hutches, *e*, and with a light iron frame, by which they are suspended to a flat wire-ropes. On each cage there are iron clasps, which slide up and down on guide-rods, and thus keep it from swinging to and fro in the shaft. This plan is now being introduced into the Cornish mines, where it has been usual to let the buckets or kibbles for raising the mineral swing free in the shaft. In the figure, two miners are shewn standing on one cage at the bottom of the shaft, and the other is at the top, with a coal-hutch upon it. The accidents resulting from the raising and lowering of the cages are numerous; many of them happen by the carelessness of the engine-man in not stopping the cage when it reaches the mouth of the pit, and so allowing it to be upset by overwinding. Many accidents also happen from the rope breaking. To prevent this, numerous 'safety-cages' have been invented, most of which depend on the action of a spring, which is held in a certain position while the cage is sus-

ended by the rope; but should the latter snap, the spring is suddenly relieved, and then grasping the guide-rods, prevents the cage from falling. It is found in practice, however, that the springs are so liable to get out of order, that they very often fail at the moment when they are required.

The steam-engine, *E*, works the pumps, in this case by a direct action, the pump-rods being attached to the piston-rod. The engine also winds up the cages, one of which ascends while the other descends—the barrel and other arrangements for which are shewn in the figure.

The proper ventilation of any mine, but especially of a coal-mine, is of very great importance. It clears the mine of the dangerous gases, fire-damp and foul-damp, dries the subterranean roadways, and furnishes the miners with a supply of pure air. Some idea of the general mode of ventilating a mine will be obtained by referring to fig. 9, where the arrows pointing downwards indicate the *downcast* shaft, and the arrows pointing upwards, the *upcast* one; and to the plan, fig. 8, where the atmospheric air, entering by the downcast shaft, passes along the roadways, as indicated by arrows. A number of doors and stops secure the travelling of the current in a proper direction, so as to reach the furthest recesses of the mine. It then returns by the upcast shaft, where, as has been already stated, it is usual to keep a furnace burning, to aid in withdrawing the impure air. It is very difficult, however, to secure efficient ventilation through all the zigzag windings of a mine; hence the frequent, and sometimes terrible explosions of fire-damp, or light carburetted hydrogen, which explodes when mixed with a certain proportion of atmospheric air; hence, also, the occasional accumulation of foul-damp (carbonic acid) in some pits, which suffocates any one breathing it. This deadly gas is always produced in large quantity by an explosion of fire-damp, and chokes many who have survived the violence of the explosion. Many collieries are so free of fire-damp, that the miners work with naked lights—generally small tallow-lamps stuck in their caps; but in others it is necessary to use the Safety Lamp (q. v.).

Besides the already mentioned sources of accident, there is the sudden falling-in of pieces from the roof of the workings. The following summary from the government inspector's returns for ten years, shews the number of lives lost, in proportion to the quantity of coal raised :

Total tons of coal raised in Great Britain	605,154,940
from 1850 to 1860,	
Total number of lives lost in ditto,	8,468
Average tons of coal raised to each life lost,	71,480

To shew the magnitude of some of the large coal-mines, it may be stated that the Hetton Colliery, in Durham, yields 800,000 tons in the year, employs about 1000 men and 300 boys underground, and 300 people at the surface. The Monkwearmouth pit, near Newcastle, is the deepest in England—its depth being 1900 feet. Its face-workings are two miles from the bottom of the shaft. The sinking of some of the more difficult shafts has cost from £50,000 to £80,000 each.

MINISTER, a public functionary who has the chief direction of any department in a state. See **MINISTRY**. Also the delegate or representative of a sovereign at a foreign court to treat of affairs of state. Every independent state has a right to send public ministers to, and receive them from, any other sovereign state with which it desires to preserve relations of amity. Semi-sovereign states have generally been considered not to possess the *ius legationis*, unless when delegated to them by the state on which they are dependent. The right of

confederated states to send public ministers to each other, or to foreign states, depends on the nature and constitution of the union by which they are bound together. The constitution of the United Provinces of the Low Countries and of the German Empire preserved this right to the individual states or princes, as do the present constitutions of the German and Swiss Confederations. The constitution of the United States either greatly modifies or entirely takes away the *jus legationis* of each individual state. Every sovereign state has a right to receive public ministers from other powers, unless where obligations to the contrary have been entered into by treaty. The diplomatic usage of Europe recognises three orders of ministers. Ministers of the first order possess the representative character in the highest degree, representing the state or sovereign sending them not only in the particular affairs with which they are charged, but in other matters: they may claim the same honours as would belong to their constituent, if present. This first class of diplomatic agents includes papal legates and nuncios, and ambassadors ordinary and extraordinary. A principle of reciprocity is recognised in the class of diplomatic agents sent. States enjoying the honours of royalty send to each other ministers of the first class; so also in some cases do those states which do not enjoy them; but it is said that no state enjoying such honours can receive ministers of the first class from those who are not possessed of them.

Ministers of the second and third order have not the same strictly representative character; their representation is not held to go beyond the affairs with which they are charged. They are, however, the natural protectors of the subjects of the state or country sending them in the country to which they are sent. Ministers of the second class include envoys, whether simply so styled, or denominated envoys extraordinary, also ministers plenipotentiary and papal internuncios. The third class of ministers does not differ from the second in the degree of their representative character, but only in the diversity of their dignity, and the ceremonial with which they are received. This class comprehends ministers, ministers resident, ministers *chargés d'affaires*, such consuls as are possessed of a diplomatic character, and those *chargés d'affaires* who are sent to courts to which it is not wished to send agents with the title of minister. Ministers of the third class have, for the most part, no letters-credentialed from the sovereign, and are accredited only by letters to the foreign minister or secretary of the country to which they are sent.

Besides these orders of ministers, there are other diplomatic agents occasionally recognised—as deputies sent to a congress or confederacy of states, and commissioners sent to settle territorial limits or disputes concerning jurisdiction. These are generally considered to enjoy the privileges of ministers of the second and third order. Ministers-mediators are ministers sent by two powers, between which a dispute has arisen, to a foreign court, or congress, where a third power, or several powers, have, with the consent of the two powers at variance, offered to mediate between them.

Diplomatic agents, except, as already mentioned, those of the third class, are accredited by a letter to the sovereign of the country to which they are sent. The letter of credence is usually despatched under a *cachet volant*—i. e., a seal which does not close the letter; or else, in addition to the principal letter, an authenticated copy is sent, which the diplomatic agent on his arrival presents to the Minister or Secretary for Foreign Affairs, as his right to demand an audience of the sovereign; the original is pre-

sent to the sovereign. Ministers sent to a congress or diet have usually no credentials, but merely a full power, of which an authenticated copy is delivered into the hands of a directing minister, or minister-mediator. A minister of the first class is received to both public and private audiences by the sovereign to whom he is accredited; a minister of the second class generally to private audiences only. Diplomatic agents are entitled to conduct negotiations either directly with the sovereign, or with the minister or secretary for foreign affairs. The latter course is the more usual, and generally the more convenient.

The title 'Excellency' has, since the peace of Westphalia, been accorded to all diplomatic agents of the first class; and in some courts it is extended to ministers of the second class, or at least those sent by the great powers. See AMBASSADOR, ENVOY, CONSUL. Under AMBASSADOR, the immunities and privileges enjoyed by diplomatic agents are explained.

MINISTRY, the body of ministers of state, or persons to whom the sovereign or chief magistrate of a country commits the executive government.

It is a principle of the constitution of Great Britain, that 'the king can do no wrong;' that is to say, the sovereign personally is irresponsible for his acts, the real responsibility resting with the administrative government. The 'King's Council,' or PRIVY COUNCIL, were the earliest advisers of the sovereign in matters of state; but when this body came, in course of time, to be found too large for the dispatch of business, its duties were transferred to a small committee of privy councillors selected by the king. As late as in Charles I.'s time, all the more important resolutions of the crown were taken after deliberation and assent of the Privy Council. An unsuccessful attempt was made in the reign of Charles II. to restore the council to its original functions. Its numbers were limited to thirty; and it was intended that this limited council should have the control of the whole executive administration, superseding any interior cabinet. But the council was found too extensive for an effectively working ministry, and the former arrangement was restored. The CABINET or MINISTRY is now but a committee of the Privy Council; and its exclusive right to discuss and determine the plans and business of the government has been often said not to be recognised by the law, a position which, however, was disputed by Lord Campbell, who maintained that, 'by our constitution, it is in practice a defined and acknowledged body for carrying on the executive government of the country.' Proclamations and orders still issue from the Privy Council; and it is occasionally assembled to deliberate on public affairs, when only those councillors who are summoned attend. The cabinet is a merely deliberative body; its members collectively have no power to issue warrants or proclamations; but all important measures which engage the attention of the government, whether regarding matters domestic, foreign, or colonial, and all plans of action, whether purely administrative, or to be carried out in parliament, must be proposed, considered, and adopted by the cabinet. The sovereign intrusts the formation of a ministry to a statesman, who selects for the members of his cabinet those who are attached to his political views. He generally places himself at the head of the government as First Lord of the Treasury, and in popular language, he is called the Premier, or Prime Minister. The Lord Chancellor, the Chancellor of the Exchequer, the Secretaries of State for Home, Foreign, Colonial, and Indian affairs, the Secretary at War, and the President of the Council, are necessarily members of the cabinet; and with them are associated the heads of various other important

departments of government, including generally the First Lord of the Admiralty, the President of the Board of Trade, the Postmaster-general, the President of the Poor-law Board, the Chancellor of the Duchy of Lancaster, and occasionally the Chief Secretary for Ireland. The Premier has sometimes held the office of Chancellor of the Exchequer in conjunction with that of First Lord of the Treasury. A privy councillor of great political weight is sometimes called into the cabinet without office, and takes the post of Lord Privy Seal. Her Majesty's ministers include the following, who have usually no seat in the cabinet: the Chief Secretary for Ireland, the First Commissioner of Works, the Vice-president of the Board of Trade, the Vice-president of the Committee on Education, the Commander-in-chief, the Lord Chamberlain, the Steward, the Master of the Horse, the Master of the Buckhounds, the Comptroller of the Household, the Lord Lieutenant of Ireland, the Attorney-general and Solicitor-general of England, the Lord Advocate and Solicitor-general of Scotland, and the Attorney-general and Solicitor-general of Ireland. Occasionally, but exceptionally, the Commander-in-chief, and the Lord Chief Justice of England, have been members of the cabinet. A ministry is often spoken of as the ministry of the person who is at its head.

Meetings of the cabinet are held on the summons of any one of its members, usually at the Foreign Office. Its proceedings are secret and confidential, and no record is kept of its resolutions, which are carried into effect by those of its members to whose departments they severally belong. As the acts of a ministry are at all times liable to be called in question in parliament, it is necessary that the heads of the chief departments should have seats in either House, in order to be able, when required, to give prompt explanations.

A government exists only so long as it can command the confidence of parliament. The sovereign has the power to dismiss his ministers whenever they cease to possess his confidence, but such a change would be useless without the support of the House of Commons, who, by withholding their support, could paralyse all the functions of government. A sovereign has sometimes got rid of a ministry with whose policy he was dissatisfied, by dissolving parliament, and appealing to the country. Where a ministry cannot command the confidence of parliament, they resign, and a statesman of some other political party is sent for by the sovereign, and authorised to form a new cabinet. All the adherents of a ministry filling political offices resign along with it, as also the great officers of the court, and those officers of the royal household who have seats in either house of parliament. Sometimes officers holding lucrative appointments which do not necessitate resignation, have retired, as a manifestation of adherence to their political friends. In addition to the ministers already named, the following adherents of the ministry go out of office on a change of government: the three junior Lords of the Treasury, the two Secretaries of the Treasury, the four parliamentary Under-secretaries of State, the Paymaster-general, the Master-general of the Ordnance, the Surveyor-general of the Ordnance, the five junior Lords of the Admiralty, the first Secretary of the Admiralty, the Chief Commissioner of Greenwich Hospital, the President and Parliamentary Secretary of the Poor-law Board, the President of the Board of Health, the Vice-chamberlain, the Captain of the Gentlemen-at-arms, the Captain of the Yeomen of the Guard, the Lords in Waiting, the Mistress of the Robes, the Treasurer of the Household, the Chief Equerry, or Clerk Marshal, the Judge Advocate-general, and the

Lord Chancellor for Ireland. The private secretary to a minister loses office on a change, his appointment being a purely personal one; and some changes are generally, though not always made in ambassadors extraordinary.

In 1839, when Viscount Melbourne's ministry resigned, Sir Robert Peel, who was intrusted by the Queen with the formation of a new ministry, proposed that, in order to give public proof of her Majesty's confidence, the change should include the chief appointments held by the ladies of Her Majesty's household. The Queen, counselled by Lord Melbourne, refused her consent to this proposal, on the ground of its being contrary to the latest precedents of the reign of Queen Anne. Sir Robert, however (with whose opinion the Duke of Wellington expressed concurrence), considered the change a necessary one; and as he refused to undertake the formation of a government without its being adopted, the result was that Lord Melbourne and his colleagues were reinstated. At a council held on their resuming office, it was resolved, 'That for the purpose of giving to the administration the character of efficiency and stability, and those marks of the constitutional support of the crown that are requisite to enable it to act usefully to the public service, it is reasonable that the great officers of the court, and situations in the household held by members of parliament, should be included in the political arrangements made in a change of the administration. But they are not of opinion that a similar principle should be applied or extended to the offices held by ladies in Her Majesty's household.'

MINIUM (Lat. red-lead). See LEAD.

MINK. See WEASEL.

MINNESINGERS, a designation applied to the earliest lyric poets of Germany in the 12th and 13th centuries, and derived from the word *Minne*, or love, which was at first the predominating, and almost sole subject treated of in their productions. The works of the M. are for the most part superior to those of their more generally known contemporaries, the troubadours, both in regard to delicacy of sentiment, elegance and variety of rhythmical structure, and grace of diction. Henry of Veldig, who flourished in the beginning of the 12th c. at the court of the Swabian, Frederick Barbarossa, Emperor of Germany, is regarded as the father of the M., and Walther von der Weide, who was born about 1170, as the last of this great vocal band, which included emperors, princes, nobles, and knights. Many of their productions have of course perished, although, in addition to a very large collection of poems by anonymous M., we still possess some remains of the songs of more than 150 known composers. Among the most celebrated of these, special notice is due to Wolfram von Eschenbach (q. v.), Henry von Ofterdingen, Hagenau, Hartmann von der Aue (q. v.), Gottfried von Strasburg (q. v.), Otto von Botenlauben, Truchsess von St Gall, and Ulrich von Lichtenstein—men of noble houses, who, although they belonged to every part of Germany, wrote almost exclusively in the Swabian dialect, which, during the brilliant days of the Fredericks and Conrads of the House of Swabia, was the language of the court in Germany. Among the few other forms of German employed by the M., the one next in favour was the Thuringian, adopted in compliment to Hermann, Landgraf of Thuringia, who, next to the princes of the Swabian dynasty, was the most munificent patron of the M. during the period of their renown, in the early part of the 13th century. Besides songs in praise of women, the M. composed odes on public or private occasions of lament or joy, distiches or axioms, and *Wachlieder*,

or watch-songs, in which the lover was represented as expostulating with the watchman, who kept guard at the gate of the castle within which his lady-love was imprisoned, and trying to persuade him to grant him admittance to her presence. These songs and odes were recited by the composer, to his own accompaniment on the viol; and as few of the M. could write, their compositions were preserved mostly by verbal tradition only, and carried by wandering minstrels from castle to castle throughout Germany, and even beyond its borders. As the variety of rhythm and complicated forms of versification affected by the M., more especially towards the decline of their art, rendered it difficult to retain by memory the mass of Minnesota which had been gradually accumulated, these itinerant musicians finally made use of written collections, a practice to which alone we are indebted for the many beautiful specimens of early German lyrical poetry which we yet possess. The glory of the M. may be said to have perished with the downfall of the Swabian dynasty, under which greater liberty of thought and word was allowed among Germans than they again enjoyed for many ages; and in proportion as the church succeeded in re-asserting its sway over the minds of men, which it had lost under the rule of the chivalric Fredericks, freedom of speech and action was trammelled, and song and poetry contemned. Paraphrases of Scripture, hymns, and monkish legends, took the place of the chivalric songs of the nobly born M., and German poetry was for a time almost annihilated.

In the 14th c., the art of Minnesong was partially revived, although under a rude and clumsily elaborated form, by the *Master-singers*; a body of men belonging to the burgher and peasant classes, who, in accordance with their artisan habits, formed themselves into guilds or companies, which bound themselves to observe certain arbitrary laws of rhythm. Nuremberg was the focus of their guilds, which rapidly spread over the whole of Germany, and gained so firm a footing in the land, that the last of them was not dissolved at Ulm till 1839. As the title of Master was only awarded to a member who invented a new form of verse, and the companies consisted almost exclusively of uneducated persons of the working-classes, it may easily be conceived that extravagances and absurdities of every kind speedily formed a leading characteristic of their modes of versification; attention to quantity was, moreover, not deemed necessary, regard being had merely to the number of the syllables, and the relative position and order of the verses and rhymes. Their songs were lyrical, and sung to music; and although, as before remarked, each master was bound to devise a special *stole* or order of rhymes for each of his compositions, these stoles were subjected to a severe code of criticism, enacted by the *Tabulatur*, or rules of the song-schools. Among the few Masters who exhibited any genuine poetic feeling, the most noted were Heinrich Mûgeln, Michael Behaim, and the Nuremberg shoemaker, Hans Sachs, who prided himself on having composed 4275 *Bar* or Master Songs. See Tieck's *Minnelieder aus dem Schwabeschen Zeitalter* (Berl. 1803), and Taylor's *Lays of the Minne and Master Singers* (Lond. 1825).

MINNESOTA, one of the United States of America, lies in lat. 43° 30'—49° N., and long. 89° 29'—97° 5' W. It is 380 miles in extreme length from north to south, and from 183 to 337 from east to west, containing an area of 81,259 square miles. It is bounded on the N. by the British possessions, from which it is separated by the chain of lakes and rivers connecting the Lake of the Woods with Lake Superior, and by the

49th parallel of latitude; E. by Lake Superior and Wisconsin; S. by Iowa; and W. by Dakota Territory (q. v.), from which it is partly divided by the Red River of the North. It contains 68 counties, and its chief towns are St Paul, the capital, St Anthony, Stillwater, Winona, Hastings, &c. M. contains the summit of the central table-land of the North American continent, where, within a few miles of each other, are the sources of rivers which find their outlets in Hudson's Bay, the Gulf of St Lawrence, and the Gulf of Mexico. The state is abundantly watered by the Mississippi, Minnesota, Red River of the North, Rainy Lake River, and their branches, and has more than 1500 miles of navigable rivers. The country abounds also in lakes and ponds. The sources of the great rivers are 1680 feet above the level of the sea. Though the most northerly state in the Union, M. is one of the most beautiful, fertile, and salubrious. The winters are long and cold, but equable, and the country is rich in fertile lands and forests. The clear waters are stored with fish, and game is abundant. The scenery is varied and beautiful. The Falls of St Anthony on the Mississippi afford abundant water-power. Near these is the beautiful cascade of the Minnehaha, or Laughing Water, 45 feet perpendicular, and a cavern, explored to the depth of 1000 feet. M. began to be settled in 1845, though it was explored by the French, and trading-posts established, in 1680. The chief route to the British settlements of the Red River of the North lies through Minnesota. 1200 miles of railway have been commenced, for which grants of government lands have been made to the extent of nearly four and a half millions of acres. The state government was organised in 1858. Powerful Indian tribes still occupy the western and northern portions of the state, and some of these, excited by the reports of the civil war, and the failure of the government agents to pay their annuities, fell upon the settlers in 1862, and committed great atrocities. A large number were taken prisoners, of whom many were hanged. Pop. in 1850, 6077; in 1860, 173,855.

MINNESOTA, or ST PETER'S RIVER, rises near the eastern boundary of Dakota Territory, United States of America, runs south-east 300 miles, to South Bend, then north-east 120 miles, and falls into the Mississippi at Mendota. It is navigable for 40 miles by steam-boats.

MINNOW (*Leuciscus phoxinus*), a small fish of the same genus with the roach, dace, chub, &c., of a more rounded form than most of its congeners, a common native of streams with gravelly bottoms in most parts of Britain. It seldom exceeds three inches in length, the head and back of a dusky olive colour, the sides lighter and mottled, the belly white, or, in summer, pink. Minnows swim in shoals, feed readily either on animal or vegetable substances, if sufficiently soft, and are said to be very destructive to the spawn of salmon and of trout. Very young anglers generally begin their sport by catching minnow. The M. is a fish of very pleasant flavour. A casting-net affords the means of taking it in sufficient abundance. It is a favourite bait for pike and large trout or perch.

MINOR, a term used in Music. 1. In the nomenclature of intervals. The interval between any note and another is named according to the number of degrees between them on the scale, both notes included. The interval between C and E is called a third; that between E and G is also a third; but these intervals are unequal, the one consisting of four semitones, the other of three; the former is therefore distinguished as a major, the latter as a minor interval. 2. The term is also

applied to one of the two modes in which a musical passage may be composed. The scale of the minor mode differs from that of the major mode in the third of its key-note being a minor instead of a major third. See MUSIC, MODE.

MINOR is, in Scotch Law, the term describing a person who, if a male, is between the ages of 14 and 21; and if a female, is between 12 and 21. In the preceding period, he or she is called a Pupil. In England, the technical term is an Infant (q. v.), which includes all persons, male and female, under the age of 21. In Scotland, a minor is for many purposes *sui juris*, and can marry without anybody's consent, and can also make a will of movable property. For the purposes, however, of managing his real property and making contracts, curators are often necessary. See INFANT, RESTITUTION, CURATOR.

MINOR BARONS. The word baron, in the earliest period of feudalism, signified one who held lands of a superior by military tenure. The superior might be the sovereign, or he might be an earl or other eminent person, who held of the sovereign. According as he was the one or the other, the baron was, in the earliest sense of the distinction, a greater or lesser baron. At the Conquest, a large part of the soil of England was parcelled by William the Norman among his military retainers, who were bound in return to perform services, to do homage, and to assist in administering justice, and in transacting the other business done in the court of the king. 400 of these tenants-in-chief of the crown are enumerated in Domesday (q. v.), including among them 'vicecomites' and 'comites,' who together constituted the body of men called the Barons of England. As the sovereign was entitled to demand from the barons military service, homage, and attendance in the courts, so, many of the principal barons, particularly such of them as were earls, had military tenants, from whom they in turn received homage and assistance in administering justice in their baronial courts. These tenants were barons of the barons, or, in the earliest sense, minor barons; but by the usage of England, from the Conquest downwards, they were seldom called barons, that term having been generally restricted to the former class, the holders of land direct from the crown, who were next, to the king in dignity, formed his army and his legislative assembly, and obtained the Great Charter from King John. The subinfeudation which produced the minor barons was checked by a statute of Edward I., directing that all persons acquiring lands from a subject should hold, not of that subject, but of his superior.

Out of the 'commune concilium' of the king, at which all his barons were bound to attend, arose the parliament. It is not till the close of Henry III.'s, or beginning of Edward I.'s reign that we find a select number instead of the whole barons attending. The exact period of the change, and the way in which it was made, are still among the obscure points of English history; it has been thought that after the rebellion which was crushed at the battle of Evesham, Henry III. summoned only those barons who were most devoted to his interest. From this period, a new distinction between major and minor barons arose, the latter term being no longer applied to the barons of the barons, but to those barons of the crown who were no longer summoned by writ to parliament. The word baron was more and more used in the restricted sense of a baron of parliament, and the right or duty of attendance came in process of time to be founded, not on the tenure, but on the writ.

In Scotland, the barons (or lairds) were such persons as held their lands directly of the crown.

They were the king's advisers, witnessed his charters, and possessed a civil and criminal jurisdiction. All had to give attendance in the Scottish parliament, which consisted of the earls and barons sitting together. After the reign of James I., some of the more powerful barons appear more exclusively as lords of parliament, those whose incomes were below a certain amount obtaining a dispensation from attendance: yet all possessed a right to attend parliament till 1587, when the barons not specially created lords of parliament were required, in place of personally attending, to send representatives of their order from each sheriffdom. The term baron, however, still continued in Scotland to be applied to the whole body of tenants *in capite*, such of them as were lords of parliament being distinctively major, and the others minor barons; but all continuing up to 1747 to possess an extensive civil jurisdiction, and a criminal jurisdiction, from which only treason and the four pleas of the crown were excluded. The representative minor barons sat in the same House with the major barons, and their votes continued down to the union to be recorded as those of the 'Small Barrounia.'

MINORCA, the largest of the Balearic Isles (q. v.), after Majorca, from which it is distant 25 miles north-east. It is 31 miles long, and 13 miles in greatest breadth, with an area of about 300 square miles. Pop. 31,443. Its coast, broken into numerous bays and inlets, is fringed with islets and shoals, and its surface, less mountainous than that of Majorca, is undulating, rising to its highest point in Mount Toro, 4793 feet above sea-level. Its productions are similar to those of the larger island, although it is neither so fertile in soil nor so well watered as Majorca. The chief towns are Port Mahon, the capital (q. v.), and Ciudadela, the former capital, with a pop. of about 4000.

MINORITES, a name of the Franciscan order (q. v.), derived from the original later denomination adopted by their founder, *Frates Minores*. This name has left its trace in the popular designation of several localities both in English and foreign cities.

MINOS, the name of two mythological kings of Crete. The first is said to have been the son of Jupiter and Europa, the brother of Rhadamanthus, the father of Deucalion and Ariadne, and, after his death, a judge in the infernal regions.—The second of the same name was grandson of the former, and son of Lycastus and Ida. To him the celebrated *Laws of Minos* are ascribed, in which he is said to have received instruction from Jupiter. He was the husband of that Pasiphaë who gave birth to the Minotaur (q. v.) Homer and Hesiod know of only one Minos, the king of Cnossus, and son and friend of Jupiter.

MINOTAUR (i. e., the Bull of Minos), one of the most repulsive conceptions of Grecian Mythology, is represented as the son of Pasiphaë and a bull, for which she had conceived a passion. It was half-man half-bull, a man with a bull's head. Minos, the husband of Pasiphaë, shut him up in the Cnossian Labyrinth, and there fed him with youths and maidens, whom Athens was obliged to supply as an annual tribute, till Theseus, with the help of Ariadne, slew the monster. The M. is, with some probability, regarded as a symbol of the Phœnician sun-god.

MINSK, a government and province of Western or White Russia, lies south-east of Wilna, and contains 33,987 square miles, with a population of 986,471, composed chiefly of Russians, Lithuanians, Poles, and Jews, with a small percentage of Tartars and gipsies. Five-sevenths of the population profess the Greek religion. The chief articles of export

are timber, salt, and corn, which are brought by river-carriage to the Baltic and Black Sea ports. The principal manufactures are fine cloths, linen, and sugar. The soil is not fertile, and is covered to a large extent with woods and marshes, while in many other places it is a sandy waste, but in general the native products suffice for the wants of the inhabitants. The climate is very severe in winter. Cattle and sheep breeding are pursued with tolerable success. The inhabitants of the south or marshy portion of the province are subject to that dreadful disease, the *Plica Polonica* (q. v.).

MINSK, the chief town of the government of the same name, is situated on the Svislocz, an affluent of the Beresina. It is mostly built of wood, but has many handsome stone edifices, among which are the Greek and Roman Catholic cathedrals and seminaries, the church of St Catharine, a number of educational and philanthropic establishments, a public library, and a theatre. The chief manufactures are woollen cloth and leather. Pop. 27,063, many of whom are Jews.

MINSTER. See **MONASTERY.**

MINT (*Mentha*), a genus of plants, of the natural order *Labiates*; with small, funnel-shaped, 4-fid, generally red corolla, and four straight stamens. The species are perennial herbaceous plants, varying considerably in appearance, but all with creeping root-stocks. The flowers are whorled, the whorls often grouped in spikes or heads. The species are widely distributed over the world. Some of them are very common in Britain, as **WATER M.** (*M. aquatica*), which grow in wet grounds and ditches, and **CORN M.** (*M. arvensis*), which abounds as a weed in cornfields and gardens. These and most of the other species have erect stems. All the species contain an aromatic essential oil, in virtue of which they are more or less medicinal. The most important species are **SPEARMINT**, **PEPPERMINT**, and **PENNY-ROYAL**.—**SPEARMINT** or **GREEN M.** (*M. viridis*), is a native of almost all the temperate parts of the globe; it has erect smooth stems, from one foot to two feet high, with the whorls of flowers in loose cylindrical or oblong spikes at the top; the leaves lanceolate, acute, smooth, serrated, destitute of stalk, or nearly so. It has a very agreeable odour.—**PEPPERMINT** (*M. piperita*), a plant of equally wide distribution in the temperate parts of the world, is very similar to spearmint, but has the leaves stalked, and the flowers in short spikes, the lower whorls somewhat distant from the rest. It is very readily recognised by the peculiar pungency of its odour and of its taste.—**PENNY-ROYAL** (*M. pulegium*), also very cosmopolitan, has a much-branched prostrate stem, which sends down new roots as it extends in length; the leaves ovate, stalked; the flowers in distant globose whorls. Its smell resembles that of the other mints.—All these species, in a wild state, grow in ditches or wet places. All of them are cultivated in gardens; and peppermint largely for medicinal use and for flavouring lozenges. *Mint Sauce* is generally made of spearmint; which is also used for flavouring soups, &c. A kind of *M.* with lemon-scented leaves, called **BERGAMOT M.** (*M. citrata*), is found in some parts of Europe, and is cultivated in gardens. Varieties of peppermint and horse-mint (*M. sylvestris*), with *crisped* or *inflato-rugose* leaves, are much cultivated in Germany under the name of **CURLED M.** (*Krause-mintze*); the leaves being dried and used as a domestic medicine, and in poultices and baths. All kinds of *M.* are easily propagated by parting the roots or by cuttings. It is said that mice have a great aversion to *M.*, and that a few leaves of it will keep them at a distance.

Peppermint, Penny-royal, and Spearmint, are used in medicine. The pharmacopœias contain an *aqua, spiritus*, and *oleum* of each of them; the official part being the herb, which should be collected when in flower. *Peppermint* is a powerful diffusible stimulant, and, as such, is antispasmodic and stomachic, and is much employed in the treatment of gastrodynia and flatulent colic. It is also extensively used in mixtures, for covering the taste of drugs. *Penny-royal* and *spearmint* are similar in their action, but inferior for all purposes to peppermint. The ordinary doses are from one to two ounces of the *aqua*, a drachm of the *spiritus* (in a wine-glassful of water), and from three to five drops of the *oleum* (on a lump of sugar).

MINT (Lat. *moneta*), an establishment for making coins or metallic money (see **MONEY**). The early history of the art being traced under the head **NUMISMATICS**, the present article is mostly confined to a sketch of the constitution of the British mint, and of the modern processes of coining as there followed.

The earliest regulations regarding the English mint belong to Anglo-Saxon times. An officer called a reeve is referred to in the laws of Canute as having some jurisdiction over it, and certain names which, in addition to that of the sovereign, appear on the Anglo-Saxon coins, seem to have been those of the moneymen, or principal officers of the mint, till recently, an important class of functionaries, who were responsible for the integrity of the coin. Besides the sovereign, barons, bishops, and the greater monasteries had their respective mints, where they exercised the right of coining, a privilege enjoyed by the archbishops of Canterbury as late as the reign of Henry VIII., and by Wolsey as Bishop of Durham, and Archbishop of York.

After the Norman Conquest, the officers of the royal mint became to a certain extent subject to the authority of the exchequer. Both in Saxon and Norman times, there existed, under control of the principal mint in London, a number of provincial mints in different towns of England; there were no fewer than 38 in the time of Ethelred, and the last of them were only done away with in the reign of William III. The officers of the mint were formed into a corporation by a charter of Edward II.; they consisted of the warden, master, comptroller, assay-master, workers, coiners, and subordinate.

The seignorage for coining at one time formed no inconsiderable item in the revenues of the crown. It was a deduction made from the bullion coined, and comprehended both a charge for defraying the expense of coining, and the sovereign's profit in virtue of his prerogative. In the reign of Henry VI., the seignorage amounted to 6*d.* in the pound; in the reign of Edward I., 1*s.* 2*d.* By 18 Car. II. c. 5, the seignorage on gold was abolished, and has never since been exacted. The shere, or remedy, as it is now called, was an allowance for the unavoidable imperfection of the coin.

The function of the mint is in theory to receive gold in ingots from individuals, and return an equal weight in sovereigns; but, in point of fact, gold is now exclusively coined for the Bank of England; for, though any one has still the right to coin gold at the mint, the merchant or dealer has ceased to obtain any profit for so doing, as the Bank is compelled to purchase all gold tendered to it at the fixed price of £3, 17*s.* 9*d.* an ounce. The increment on the Assay (q. v.), or on the fineness of the metal, which augments the standard weight, and therefore the value of the gold, is a more considerable source of profit to the importer of gold. The ordinary trade assay, on which the importer purchases the bullion, does not by usage come closer than $\frac{1}{4}$ th of a carat grain or $\frac{7}{4}$ grains per lb. troy. Before being coined,

the gold is subjected to a second and more delicate assay at the mint, and the importer receives the benefit of the difference, amounting to about $\frac{1}{4}$ th of a carat grain = $3\frac{1}{2}$ troy grains, or nearly 8d. per lb. weight.

Silver, which was formerly, concurrently with gold, a legal tender to any amount, has, by 56 Geo. III. c. 68, ceased to be so. There is a seignorage on both silver and copper money, amounting in silver to 20 per cent., when the price of silver is 5s. per ounce, which, however, from the tear and wear of the coin, brings small profit to the crown. On the copper coinage, the seignorage is no less than 100 per cent. on the average price of copper. The profits of the seignorage, formerly retained by the master of the mint, to defray the expense of coinage, have, since 1837, been paid into the Bank, to the credit of the Consolidated Fund.

A new mint was erected on Towerhill in 1810. In 1815, some alterations were made in its constitution; and in 1851 a complete change was introduced in the whole system of administration. The control of the mint is now vested, subject to the instructions of the Treasury, in a master and a deputy-master, and comptroller. The mastership, which had, in the early part of the present century, become a political appointment, held by an adherent of the government, has been restored to the position of a permanent office, the master being the ostensible executive head of the establishment. The operative department is intrusted to the assayer, the melter, and the refiner. The moneyers, who from early times till a very recent period were in the enjoyment of extensive corporate privileges and exemptions, were contractors with the crown for the execution of the coinage. Their office was abolished with the recent change of system; and the contracts with the crown are now entered into by the master of the mint, who also makes subordinate contracts for the actual manufacture of the coin. Other contracts are taken by the medallists of Birmingham, where one firm especially, that of Ralph Heaton & Co., whose machinery is said to excel that of the Royal Mint in efficiency, not only manufactures coin for our own, but also takes large contracts from foreign governments both in copper and silver. Another firm assisted in making the bronze coinage of this country lately issued. These firms have no special privileges, but tender for the government contracts when offered in the usual way, and give the necessary securities.

Processes of coining.—Down to the middle of the 16th c., little or no improvement seems to have been made in the art of coining from the time of its invention. The metal was simply hammered into slips, which were afterwards cut up into squares of one size, and then forged round. The required impression was given to these by placing them in turn between two dies, and striking them with a hammer. As it was not easy by this method to place the dies exactly above each other, or to apply proper force, coins so made were always faulty, and had the edges unfinished, which rendered them liable to be clipped. The first great step was the application of the screw, invented in 1553 by a French engraver of the name of Brucher. The plan was found expensive at first, and it was not till 1662 that it altogether superseded the hammer in the English mint. The chief steps in coining as now practised are as follows: The gold or silver to be coined is sent to the mint in the form of *ingots* (Ger. *eingiessen*, Du. *ingieten*, to pour in, to cast), or castings; those of gold weighing each about 180 oz., while the silver ingots are much larger. Before melting, each ingot is tested as to its purity by *Assaying* (q. v.), and then weighed, and the results carefully recorded. For melting the gold, pots or

crucibles of plumbago are used, made to contain each about 1200 oz. The pots being heated white, in furnaces, the charge of gold is introduced along with the proper amount of copper (depending upon the state of purity of the gold as ascertained by the assay), to bring it to the standard, which is 22 parts of pure gold to 2 of copper (see *ALLOY*). The metal when melted is poured into iron moulds, which form it into bars 21 inches long, $1\frac{1}{2}$ inch broad, and 1 inch thick, if for sovereigns; and somewhat narrower, if for half-sovereigns. For melting silver (the alloy of which is adjusted to the standard of 222 parts of silver to 18 of copper), malleable iron pots are used, and the metal is cast into bars similar to those of gold.

The new copper, or rather bronze coinage, issued in 1860, is an alloy consisting of 95 parts of copper, 4 of tin, and 1 of zinc. The coins are only about half the weight of their old copper representatives. The processes of casting and coining the bronze are essentially the same as in the case of gold and silver.

The operation of *rolling* follows that of casting. It consists in repeatedly passing the bars between pairs of rollers with hardened steel surfaces, driven by steam-power; the rollers being brought closer and closer as the thickness becomes reduced. At a certain stage, as the bars become longer, they are cut into several lengths; and to remove the hardness induced by the pressure, they are annealed. The finishing rollers are so exquisitely adjusted that the *fillets* (as the thinned bars are called) do not vary in thickness in any part more than the ten-thousandth part of an inch. The slips are still further reduced in the British mint at what is called the 'draw-bench,' where they are drawn between steel dies, as in wire-drawing, and are then exactly of the necessary thickness for the coin intended.

The fillets thus prepared are passed to the tryer, who, with a hand-punch, cuts a trial-blank from each, and weighs it in a balance; and if it vary more than $\frac{1}{4}$ th of a grain, the whole fillet is rejected.

For cutting out the *blanks* of which the coins are to be made, there are in the British mint twelve presses arranged in a circle, so that one wheel with driving cams, placed in the centre, works the whole. The punches descend by pneumatic pressure, and the fillets are fed into the presses by boys, each punch cutting out about 60 blanks a minute. The scrap left after the blanks are cut out, called *scissel*, is sent back to be remelted.

Each blank is afterwards weighed by the automaton balance—a beautiful and most accurate instrument, which was added to the mint about ten years ago. It weighs 23 blanks per minute, and each to the 0.01 of a grain. The standard weight of a sovereign is 123.274 grains, but the mint can issue them above or below this to the extent of 0.2568 of a grain, which is called the *remedy*. Blanks which come within this limit are dropped by the machine into a 'medium' box, and pass on to be coined. Those below the required weight are pushed into another box to be remelted, but those above it into another, and are reduced by filing. The correct blanks are afterwards rung on a sounding iron, and those which do not give a clear sound are rejected as dumb.

To insure their being properly milled on the edge, the blanks are pressed edgeways in a machine between two circular steel-plates, which raises the edges, and at the same time secures their being perfectly round. After this they are annealed to soften them, before they can be struck with dies; they are also put into a boiling pot of dilute sulphuric acid, to remove any oxide of copper from the

surface. Subsequently, they are washed with water, and dried with great care in hot sawdust, and finally in an oven at a temperature slightly above boiling water. Without these precautions, the beautiful bloom upon new coin could not be secured.

We now come to the press-room, where the blanks receive the impression which makes them perfect coins. The coining-press is shewn in the fig. and

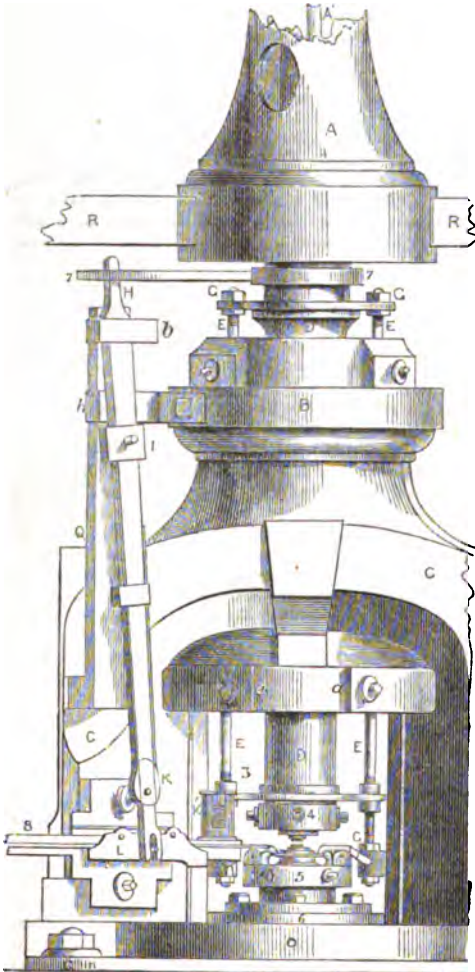

Coining-press.

there are eight of them in all, ranged in a row upon a strong foundation of masonry. CCB is the massive iron frame into which the screw D works, the upper part B being perforated to receive it. On the bottom of this screw the upper steel die is fixed by a box, the lower die being fixed in another box attached to the base of the press. The dies have, of course, the obverse and reverse of the coin upon them. See DIE-SINKING. The blank coin is placed on the lower die, and receives the impression when the screw is turned round so as to press the two dies forcibly towards each other. A steel ring or collar contains the coin while it is being stamped, which preserves its circular form, and also effects the milling on the edge. In cases where letters are put on the edge of a coin, a collar divided into segments working on centre-pins, is used. On the proper

pressure being applied, the segments close round, and impress the letters on the edge of the coin.

The screw of the press is put in motion by means of the piece A, which is worked by machinery driven by steam-power, and situated in an apartment above the coining-room. The steam-engine exhausts an air-chamber, and from the vacuum produced, an air-engine works a series of air-pumps, which communicate a more exact and regular motion to the machinery of the stamping-presses than by the ordinary condensing engine. The loaded arms RR strike against blocks of wood, whereby they are prevented from moving too far, and run the risk of breaking the hard steel dies by bringing them in contact. The press brings down the die on the coin with a twisting motion, but if it were to rise up in the same way, it would abrade the coin; there is, in consequence, an arrangement which, by means of a wide notch in the ring 3, allows the die to be raised up a certain distance before it begins to turn round with the screw.

On the left side of the figure, the arrangement for feeding the blanks and removing the coins as they are stamped, is shewn. A lever HIK, moving on a fulcrum I, is supported by a bar Q, fixed to the side of the press. The top of this lever is guided by a sector 7 fixed upon the screw D. In this sector there is a spiral groove, which, as the screw turns round, moves the end H of the lever to or from the screw, the other end K being moved at the same time either towards or away from the centre of the press. The lower end of the lever moves a slider L, which is directed exactly to the centre of the press, and on a level with the upper surface of the die. The slider is a thin steel-plate in two pieces united by a joint, and having a circular cavity at the end, which, when its limbs are shut, grasps a piece of coin by the edge. This piece drops out on the limbs separating. There is a tube at K which an attendant keeps filled with blank pieces; it is open at the bottom, so that the pieces rest on the slider. When the press is screwed down, the slider is drawn back to its furthest extent, and its circular end comes exactly beneath the tube. A blank piece of coin now drops in, and is carried, when the screw rises, to the collar which fits over the lower die. The slider then returns for another blank, while the upper die descends to give the impression to the coin. Each time the slider brings a new blank to the die, it at the same time pushes off the piece last struck. An arrangement of springs lifts the milled collar to enclose the coin while it is being struck.

It is found on examining the coins that about 1 in 200 is imperfectly finished; these being rejected, the rest are finally weighed into bags, and subjected to the process of *picking*. This consists in taking from each bag a certain number of sovereigns or other coins, and subjecting them to a final examination by weight and assay, before they are delivered to the public.

MINUET, the air of a most graceful dance, originally from Poitou, in France. It is performed in a slow tempo. The first minuet is said to have been composed by Lully the Elder, and was danced by Louis XIV. in 1653 at Versailles with his mistress. The music of the minuet is in $\frac{3}{4}$ time, and is still well known in England by the celebrated *Minuet de la Cour*, which is frequently introduced in stage performances.

MINUTE, a rough draft of any proceeding or instrument; so called from being taken down shortly and in *minute* or small writing, to be afterwards ingrossed. See INGROSS.—MINUTE, in Law, is a memorandum or record of some act of a court or of parties; in the latter sense, it is used chiefly in

Scotland, as in the case of minute of agreement, minute of sale, &c.

MINUTE, the 60th part of an hour; also the 60th part of a degree of a circle. See **SEXAGESIMAL ARITHMETIC**.—**MINUTE**, in Architecture, is the 60th part of the diameter of the shaft of a classic column, measured at the base. It is used as a measure to determine the proportions of the order.

MI'OCENE (Gr. less recent), a term introduced by Lyell to characterise the Middle Tertiary strata, which he supposes to contain a smaller proportion of recent species of mollusca than the newer Pliocene, and more than the older Eocene. He estimates the proportion of living to fossil species in the Miocene at 25 per cent.

Strata of this age occur in Britain in two limited and far separated localities—in the island of Mull, and at Dartmoor in the south-east of England. In this last district, they exist at Bovey Tracey, in a flat area of ten miles long by two miles broad, and consist of clay interstratified with beds of imperfect lignites. Pengelly and Heer have recently examined the strata of this small basin, and have found that all the plants are of Miocene age, and belong to the same species as those found in similar deposits, not only on the continent, but in Iceland, Greenland, and Arctic America. Their *facies* indicates a warmer climate than the present, and the geographical range of the species is unexampled in the existing flora. The Mull beds are situated at the headland of Ardton, and consist of interstratified basalts, ashes, and lignites. There are three leaf-beds, varying in thickness from 1½ to 2½ feet, separated by two beds of ash, the whole resting on, and covered by strata of basalt. The whole thickness is 131 feet. It is supposed that the leaf-beds were deposited in a shallow lake or marsh, in the vicinity of an active volcano. One of the beds consists of a mass of compressed leaves without stems, and accompanied with abundant remains of an equisetum, which grew in the marsh into which the leaves were blown. The leaves belong to dicotyledons and conifers, and are of species similar to those of Bovey Tracey.

The Fahluns of France are of this age, as are also part of the Mollassi of Switzerland, and the Mayence and Vienna basins. Of the same period are the highly fossiliferous deposits in the Sewalik Hills, India, containing the remains of several elephants, a mammoth, hippopotamus, giraffe, and large ostrich, besides several carnivora, monkeys, and crocodiles, and a large tortoise, whose shell measured 20 feet across. The European beds contain the remains of the *Dinotherium* (q. v.).

MIRABEAU, HONORÉ GABRIEL RIQUETTI, COMTE DE, was born 9th March 1749, at Bignon, near Nemours. He was descended, by his own account, from the ancient Florentine family of Arrighetti, who being expelled from their native city in 1268, on account of Ghibelline politics, settled in Provence. Jean de Riquetti or Arrighetti purchased the estate of Mirabeau in 1562; his grandson, Thomas, happened to entertain here, in 1660, Louis XIV. and Cardinal Mazarin, on which occasion he received from the monarch the title of Marquis Victor Riquetti. Marquis de Mirabeau (born 1715, died 1789), the father of Honoré, was a vain and foolish man, wasted his patrimony, wrote books of philanthropy and philosophy, as *L'Ami des Hommes* (5 vols. Par. 1756), and was a cruel tyrant in his own house. He procured no fewer than fifty-four *lettres de cachet* at different times against his wife and his children. Honoré, his eldest son, was endowed with an athletic frame and extraordinary mental abilities, but was of a fiery temper, and disposed to every kind of excess. He became a lieutenant in a

cavalry regiment; but continued to prosecute various branches of study with great eagerness, whilst outrunning his companions in a career of vice. An intrigue with the youthful wife of an aged marquis brought him into danger, and he fled with her to Switzerland, and thence to Holland, where he subsisted by his pen, amongst other productions of which, his *Essai sur le Despotisme* attracted great attention. Meanwhile, sentence of death was pronounced against him; and the French minister, at his father's instigation, demanding that he should be delivered up to justice, he and his paramour were apprehended at Amsterdam, and he was brought to the dungeon at Vincennes, and there closely imprisoned for 42 months. During this time he was often in great want, but employed himself in literary labours, writing an *Essai sur les Lettres de Cachet et les Prisons d'état*, which was published at Hamburg (2 vols. 1782), and a number of obscene tales, by which he disgraced his genius, although their sale supplied his necessities. After his liberation from prison, he subsisted chiefly by literary labour, and still led a very profligate life. He wrote many effective political pamphlets, particularly against the financial administration of Calonne, receiving pecuniary assistance, it was said, from some of the great bankers of Paris; and became one of the leaders of the Liberal party. When the States-general were convened, he sought to be elected as a representative of the nobles of Provence, but was rejected by them on the ground of his want of property; and left them with the threat that, like Marius, he would overthrow the aristocracy. He purchased a draper's shop, offered himself as a candidate to the Third Estate, and was enthusiastically returned both at Aix and Marseille. He chose to represent Marseille, and by his talents and admirable oratorical powers soon acquired great influence in the States-general and National Assembly. Barnave well characterised him as 'the Shakspeare of eloquence.' He stood forth as the opponent of the court and of the aristocracy, but regarded the country as by no means ripe for the extreme changes proposed by political theorists, and laboured, not for the overthrow of the monarchy, but for the abolition of despotism, and the establishment of a constitutional throne. To suppress insurrection, he effected, on 8th July 1789, the institution of the National Guard. In some of the contests which followed, he sacrificed his popularity to maintain the throne. The more that anarchy and revolutionary frenzy prevailed, the more decided did he become in his resistance to their progress; but it was not easy to maintain the cause of constitutional liberty at once against the supporters of the ancient despotism and the extreme revolutionists. The king and his friends were long unwilling to enter into any relations with one so disreputable, but at last, under the pressure of necessity, it was resolved that M. should be invited to become minister. No sooner was this known, than a combination of the most opposite parties, by a decree of 7th November 1789, forbade the appointment of a deputy as minister. From this time forth, M. strove in vain in favour of the most indispensable prerogatives of the crown, and in so doing exposed himself to popular indignation. He still continued the struggle, however, with wonderful ability, and sought to reconcile the court and the Revolution. In December 1790, he was elected president of the Club of the Jacobins, and in February 1791, of the National Assembly. Both in the Club and in the Assembly, he displayed great boldness and energy; but soon after his appointment as president of the latter, he sank into a state of bodily and mental weakness, consequent upon his great exertions and his continued debaucheries, and

died 2d April 1791. He was interred with great pomp in the church of Saint Genevieve, the 'Pantheon;' but his body was afterwards removed, to make room for that of Marat. A complete edition of his works was published at Paris in 9 vols. in 1825—1827. His natural son, Lucas Montigny, published *Mémoires Biographiques, Littéraires et Politiques de Mirabeau* (2d edit. 8 vols. Par. 1841), the most complete account which we have of his life. See also Carlyle's sketch of Mirabeau in his *Miscellaneous Essays*, and his *French Revolution*.

MIRACLE, a term commonly applied to certain marvellous works (healing the sick, raising the dead, changing of water into wine, &c.) ascribed in the Bible to some of the ancient prophets, and to Jesus Christ, and one or two of his followers. It signifies simply that which is wonderful—a thing or a deed to be wondered at, being derived directly from the Latin *miraculum*, a thing unusual—an object of wonder or surprise. The same meaning is the governing idea in the term applied in the New Testament to the Christian miracles, *teras*, a marvel, a portent; besides which, we also find them designated *dunamis*, powers, with a reference to the power residing in the miracle-worker; and *semeia*, signs, with a reference to the character or pretensions of which they were assumed to be the witnesses or guarantees. Under these different names, the one fact recognised is a deed done by a man, and acknowledged by the common judgment of men to exceed man's ordinary powers; in other words, a deed *supernatural*, above or beyond the common powers of nature, as these are understood by men.

In the older speculations on the subject, a miracle was generally defined to be a violation or suspension of the order of nature. While, on the one hand, it was argued (as by Hume), that such a violation or suspension was absolutely impossible and incredible; it was maintained, on the other, that the Almighty, either by his own immediate agency, or by the agency of others, could interfere with the operation of the laws of nature, in order to secure certain ends, which, without that interference, could not have been secured, and that there was nothing incredible in the idea of a law being suspended by the Person by whom it had been made. The laws of nature and the will or providence of God were, in this view, thus placed in a certain aspect of opposition to each other, at points here and there clashing, and the stronger arbitrarily asserting its superiority. Such a view has, with the advance of philosophical opinion, appeared to many to be inadequate as a theory, and to give an unworthy conception of the Divine character. The great principle of Law, as the highest conception not only of nature, but of Divine Providence, in all its manifestations, has asserted itself more dominantly in the realm of thought, and led to the rejection of the apparently conflicting idea of 'interference,' implied in the old notion of miracle. Order in nature, and a just and uncapricious will in God, were felt to be first and absolutely necessary principles. The idea of miracle, accordingly, which seems to be now most readily accepted by the advocates of the Christian religion, has its root in this recognised necessity.

All law is regarded as the expression, not of a lifeless force, but of a perfectly wise and just will. All law must develop itself through natural phenomena; but it is not identified with or bound down to any necessary series of these. If we admit the mainspring of the universe to be a living will, then we may admit that the phenomena through which that will, acting in the form of law, expresses itself, may vary without the will varying or the law being broken. We know absolutely nothing of the mode

of operation in any recorded miracle; we only see certain results. To affirm that these results are either impossible in themselves, or necessarily violations of natural law, is to pronounce a judgment on imperfect data. We can only say that, under an impulse which we must believe proceeds from the Divine will, in which all law exists, the phenomena which we have been accustomed to expect have not followed on their ordinary conditions. But from our point of view we cannot affirm that the question as to *how* this happens is one of interference or violation; it is rather, probably, one of higher and lower action. The miracle may be but the expression of one Divine order and beneficent will in a new shape—the law of a greater freedom, to use the words of Trench, swallowing up the law of a lesser.

Nature being but the plastic medium through which God's will is ever manifested to us, and the design of that will being, as it necessarily must be, the good of his creatures, that theory of miracle is certainly most rational which does not represent the ideas of laws and of the will of God as separate and opposing forces, but which represents the Divine will as working out its highest moral ends, not against, but through law and order, and evolving from these a new issue, when it has a special beneficent purpose to serve. And thus, too, we are enabled to see in miracle not only a wonder and a power, but a sign—a revelation of Divine character, never arbitrary, always generous and loving, the character of one who seeks through all the ordinary courses of nature and operation of law to further His creatures' good, and whose will, when that end is to be served, is not restricted to any one necessary mode or order of expression. Rightly interpreted, miracle is not the mere assertion of power, or a mere device to impress an impressible mind; it is the revelation of a will which, while leaving nature as a whole to its established course, can yet witness to itself as above nature, when, by doing so, it can help man's moral and spiritual being to grow into a higher perfection.

The evidence for the Christian miracles is of a twofold kind—external and internal. As alleged facts, they are supposed to rest upon competent testimony, the testimony of eye-witnesses, who were neither deceived themselves, nor had any motive to deceive others. They occurred not in privacy, like the alleged supernatural visions of Mohammed, but for the most part in the open light of day, amidst the professed enemies of Christ. They were not isolated facts, nor wrought tentatively, or with difficulty; but the repeated, the overflowing expression, as it were, of an apparently supernatural life. It seems impossible to conceive, therefore, that the apostles could have been deceived as to their character. They had all the means of scrutinising and forming a judgment regarding them that they could well have possessed; and if not deceived themselves, they were certainly not deceivers. There is no historical criticism that would now maintain such a theory; even the most positive unbelief has rejected it. The career of the apostles forms throughout an irrefragable proof of the deep-hearted and incorruptible sincerity that animated them. The gospel miracles, moreover, are supposed in themselves to be of an obviously Divine character. They are, in the main, miracles of healing, of beneficence, in which the light equally of the Divine majesty and of the Divine love shines—witnessing to the eternal life which underlies all the manifestations of decay, and all the traces of sorrow in the lower world, and lifting the mind directly to the contemplation of his life.

MIRACLE PLAYS. See **MYSTERIES.**

MIRAGE—MIRROR.

MIRAGE, a phenomenon extremely common in certain localities, and as simple in its origin as astonishing in its effects. Under it are classed the appearance of distant objects as double, or as if suspended in the air, erect or inverted, &c. One cause of mirage is a diminution of the density of the air near the surface of the earth, produced by the transmission of heat from the earth, or in some other way; the denser stratum being thus placed *above*, instead of, as is usually the case, *below* the rarer. Now, rays of light from a distant object, situated in the denser medium (i. e., a little above the earth's level), coming in a direction nearly parallel to the earth's surface, meet the rarer medium at a very obtuse angle, and (see REFRACTION) instead of passing into it, are reflected back to the dense medium; the common surface of the two media acting as a mirror. Suppose, then, a spectator to be situated on an eminence, and looking at an object situated like himself in the denser stratum of air, he will see the object by means of directly transmitted rays; but besides this (see fig. 2), rays from the object will be reflected from the upper surface of the rarer stratum of air beneath his eye. The image produced by the reflected rays will appear inverted, and below the real object, just as an image reflected in water appears when observed from a distance. If the object is a cloud or portion of sky, it will appear by the reflected rays as lying on the surface of the earth, and bearing a strong resemblance to a sheet of water; also, as the reflecting surface is



Fig. 1.

irregular, and constantly varies its position, owing to the constant communication of heat to the upper stratum, the reflected image will be constantly varying, and will present the appearance of a water surface ruffled by the wind. This form of mirage, which even experienced travellers have found to be completely deceptive, is of common occurrence in the arid deserts of Lower Egypt, Persia, Tartary, &c.

In particular states of the atmosphere, reflection of a portion only of the rays takes place at the surface of the dense medium, and thus double images are formed, one by reflection, and the other by refraction—the first inverted, and the second erect. The phenomena of mirage are frequently much more strange and complicated, the images being often much distorted and magnified, and in some instances occurring at a considerable distance from the object, as in the case of a tower or church seen over the sea, or a vessel over dry land, &c. The particular form of mirage known as *looming*, is very frequently observed at sea, and consists in an excessive apparent elevation of the object. A most remarkable case of this sort occurred on the 26th of July 1798, at Hastings. From this place the French coast is fifty miles distant; yet, from the sea-side the whole coast of France from Calais to near Dieppe was distinctly visible, and continued so for three hours. In the Arctic regions it is no uncommon occurrence for whale-fishers to discover the proximity of other ships by means of their images seen elevated in the air, though the ships themselves may be below the horizon. Generally, when the ship is above the horizon, only one image, and that inverted, is found; but when it is wholly or in great part below the horizon, double images (see fig. 1), one erect and the other inverted, are frequently seen. The faithfulness and distinctness

of these images at times may be imagined from the fact, that Captain Scoresby, while cruising off the coast of Greenland in 1822, discovered the propinquity



Fig. 2.

of his father's ship from its inverted image in the sky. Another remarkable instance of M. occurred in May 1854, when, from the deck of H. M. screw-steamer, *Archer*, then cruising off Oesel, in the Baltic, the whole English fleet of nineteen sail, then nearly thirty miles distant, was seen as if suspended in the air upside down. Beside such phenomena as these, the celebrated *Fata Morgana* (q. v.) of the Straits of Messina sinks into insignificance. The *Spectre of the Broken*, in Hanover, is another celebrated instance of mirage. Its varieties are indeed numberless, and we refer those who wish for further information to Brewster's *Optica*, Biot's *Traité de Physique*, and for the mathematical theory of the mirage to the works of Biot, Monge, and Wollaston. See also REFLEXION and REFRACTION.

MIRANDOLA, a town of Northern Italy, in the province of Modena, and 20 miles north-north-east of the city of that name. It stands in the midst of a low-lying and somewhat unhealthy flat, and contains numerous churches, a cathedral, and a citadel. Rice is much cultivated in the vicinity, and the breeding of silk-worms is an important branch of industry. Pop. variously stated at from 6000 to 10,000.

MIRECOURT, a town of France in the department of Vosges, in a picturesque district, 20 miles south of Nancy. It is famous for its manufactures of lace, and of church-organs and stringed musical instruments. Pop. 5368.

MIRFIELD, a manufacturing village of the West Riding of Yorkshire, England, three miles east of Dewsbury. The manufactures are fancy and other woollen fabrics, and cotton goods. It is one of the chief railway centres in the country. Pop. (1861) 9263.

MIRPU'R, a flourishing town of India, in Sindh, on the left bank of the Piniari, 45 miles south of Hyderabad. It contains a fort capable of accommodating 200 men, and which commands the route from Hyderabad to Cutch. The surrounding district is fertile and well cultivated. Pop. 10,000.

MIRROR, a reflecting surface, usually made of glass, lined at the back with a brilliant metal, so as strongly to reflect the image of any object placed before it. When mirrors were invented, is not known, but the use of a reflecting surface would become apparent to the first person who saw his own image reflected from water; and probably for ages after the civilisation of man commenced, the still waters of ponds and lakes were the only mirrors; but we read in the Pentateuch of mirrors of brass being used by the Hebrews. Mirrors of

brass were in very common use amongst the ancient Egyptians, Greeks, and Romans, of which many specimens are preserved in museums. Praxiteles taught the use of silver in the manufacture of mirrors in the year 328 B. C. Mirrors of glass were first made at Venice in 1300; and judging from those still in existence—of which one may be seen at Holyrood Palace, in the apartments of Queen Mary—they were very rude contrivances, compared with modern ones. It was not until 1673 that the making of mirrors was introduced into England. It is now a very important manufacture; and mirrors can be produced of any size to which plate-glass can be cast. After the plate of glass is polished on both sides, it is laid on a perfectly level table of great strength and solidity, usually of smooth stone, made like a billiard-table with raised edges; a sheet or sheets of tinfoil sufficient to cover the upper surface of the glass are then put on, and rubbed down smooth, after which the whole is covered with quicksilver, which immediately forms an amalgam with the tin. The superfluous mercury is then run off, and a woollen cloth is spread over the whole surface, and square iron weights are applied, until the whole presents a compact mass of iron of two or three pounds to the square inch. After this pressure has been continued a day and night, the weights and the cloth are removed, and the glass is removed to another table of wood with a movable top, which admits of the glass being slightly inclined at first, and the inclination gradually increased, until the unamalgamated quicksilver has perfectly drained away, and only the surface of perfect amalgam remains coating the glass, and perfectly adherent to it. From eighteen days to a month are required to complete this process.

MIRZA, a contraction of *Emir Zadah*, 'son of the prince,' is, when *prefixed* to the surname of the individual, the common title of honour among the Persians; but when *annexed* to the surname, it designates a prince or a male of the blood-royal.

MIRZAPUR, a town of Hindustan, capital of the district of the same name, on the right bank of the Ganges, which is here half a mile wide, and crossed by a ferry, 40 miles south-west of Benares. It has some manufactures of carpets, cottons, and silks, and is the greatest cotton-mart in India. Pop. about 80,000.—The *district of M.*, in the *North-west Provinces*, is watered by the Ganges and the Son. Lat. 23° 50'—25° 30' N.; long. 82° 11'—83° 39' E. Area, 5235 square miles. Pop., almost exclusively Hindus, 1,104,315. The chief productions, beside the usual cereals, are cotton, indigo, and sugar. The climate is, on the whole, unhealthy for Europeans.

MISDEMEANOUR is one of the technical divisions of crimes, by the law of England and Ireland. The usual division of crimes is into treason (which generally stands by itself, though, strictly speaking, included in), felony, and misdemeanour. The offence of greatest enormity is treason, and the least is misdemeanour. The original distinction between felony and misdemeanour consisted in the consequences of a conviction. A party convicted of felony, if capital, forfeits both his real and personal estate; if not capital, his personal estate only. A party convicted of misdemeanour forfeits none of his property. The distinction is not kept up between the two classes of crimes by any greater severity of punishment in felony, for many misdemeanours are punished as severely as some felonies. But it has been the practice of the legislature, when creating new offences, to say whether they are to be classed with felony or misdemeanour; and when this is done,

the above incidents attach to the conviction accordingly.

MISENO, a promontory of the province of Naples, 9 miles south-west of the city of Naples. On the outskirts of the promontory are the extensive ruins of the ancient city of Misenum, including a vast church and theatre. M. is much visited on account of its wonderful grotto Draconara, and a curious subterranean building or labyrinth, called the Hundred Chambers, supposed to have been anciently employed as dungeons.

MISERERE, the name by which, in Catholic usage, the 50th Psalm of the Vulgate (51st in authorised version) is commonly known. It is one of the so-called 'Penitential Psalms,' and is commonly understood to have been composed by David in the depth of his remorse for the double crime which the prophet Nathan rebuked in the well-known parable (2 Sam. xii.). Another opinion, however, attributes this psalm to Manasses, or to some of the psalm-writers of the Captivity. The Miserere is of frequent occurrence in the services of the Roman Church; and in the celebrated service of Tenebræ, as performed in the Sixtine Chapel at Rome, it forms, as chanted by the pope's choir, one of the most striking and impressive chants in the entire range of sacred music. It is sung on each of the three nights in Holy Week (q. v.) on which the office of Tenebræ is held, with different music on each of the three occasions, the three composers being Bai, Bainsi, and the still more celebrated Allegri.—Miserere is also the name of one of the evening services in Lent, which is so called from the singing of that psalm, and which includes a sermon, commonly on the duty of sorrow for sin.

MISERERE, a projection on the under side of the seats of the stalls of mediæval churches and



Miserere:
From Billing's *Carlisle Cathedral*.

chapels, &c. They are usually ornamented with carved work, and are so shaped, that when the seats-proper are folded up, they form a small seat at a higher level, sufficient to afford some support to a person resting upon it. Aged and infirm ecclesiastics were allowed to use these during long services.

MISFEASANCE, in Legal Language, means the doing of a positive wrong, in contradistinction to nonfeasance, which means a mere omission. Acts

are sometimes followed with different legal consequences, according as they fall under the head of misfeasance or nonfeasance.

MISHNA (from Heb. *shama*, to learn; erroneously held to designate Repetition) comprises the body of the 'Oral Law,' or the juridico-political, civil, and religious code of the Jews; and forms, as such, a kind of complement to the Mosaic or Written Law, which it explains, amplifies, and immutably fixes. It was not, however, the sole authority of the schools, and the masters, on which these explanations and the new ordinances to which they gave rise depended, but rather certain distinct and well-authenticated traditions, traced to Mount Sinai itself. No less were certain special letters and signs in the Written Law appealed to in some cases, as containing an indication to the special, newly issued, or fixed prohibitions or rules. See **HALACHA**. The Mishna (to which the Toseftas and Boraithas form supplements) was finally redacted, after some earlier incomplete collections, by Jehudah Hanassi, in 220 A. D., at Tiberias. It is mostly written in pure Hebrew, and is divided into six portions (*Sedarim*): 1. *Zeraim* (Seeds), on Agriculture; 2. *Moed* (Feast), on the Sabbath, Festivals and Fasts; 3. *Nashim* (Women), on Marriage, Divorce, &c. (embracing also the laws on the Nazirah and Vows); 4. *Nezikin* (Damages), chiefly civil and penal law (also containing the ethical treatise *Aboth*); 5. *Kadashim* (Sacred Things), Sacrifices, &c.; description of the Temple of Jerusalem, &c.; 6. *Tehoroth* (Purifications), on pure and impure things and persons. See also **TALMUD**.

MISKO'LOZ, the principal town in the county of Borsod, Hungary, situated at the extremity of a beautiful valley, 25 miles north-east of Erlau. It is connected with Debreczin by railway, and contains numerous churches, two gymnasia, and other educational institutions. Wine and melons are extensively cultivated. From the iron obtained in the vicinity, the best steel in Hungary is made. The chief trade is in wine. Pop. 26,000.

MISNOMER is the giving of a wrong name to a party in a suit. Formerly, the objection of misnomer was of some importance, but now is of none, as it is easily cured by amendment.

MISPRISION is, in English Law, a clerical error made in drawing up a record of a court of law.

MISREPRESENTATION, in point of law, or, as it is most frequently termed, fraudulent misrepresentation, is that kind of lie for which courts of law will give redress. It consists in a wilful falsehood as to some material thing connected or not with some contract; the object being that the party deceived should act upon it as true. The legal result is, that if the party so relying on its truth and acting on it suffer damage, he can sue the deceiver for such damage. It has sometimes been supposed that the deceit or misrepresentation must have reference to some contract, or arise out of some confidential relation between the parties, and that the party making it should have some private interest to serve; but this is a mistake; and recent cases have established, that if a person wilfully—i. e., either not knowing anything at all one way or the other about the matter, or knowing the real truth, misrepresent something, with the intention that a stranger should act on such misrepresentation, and such stranger does so act on it, and suffer damage, then the right of action accrues to the deceived party. One remarkable exception to this doctrine, however, occurs in the case of the contract of marriage, where either party has in general no remedy whatever against the other for misrepresentations as

to his or her property, connections, &c. It is not necessary that the misrepresentation should be made in writing, in order to give rise to the action, except in cases where the party gives representations as to the conduct, credit, ability, trade, or dealings of a third party, in order that such third party shall obtain credit, money, or goods thereby. The doctrine of misrepresentation has acquired great consequence of late, owing to the extension of the system of joint-stock companies, and the practice of the directors and officers publishing, or being parties to fraudulent reports, accounts, and circulars as to the credit and stability of such undertakings. It is now settled, that not only every director, but every clerk in the service of the directors, who knowingly and wilfully concurs and takes a part in publishing or circulating such false reports, whereby strangers are led to believe and act on them, and thereby suffer pecuniary loss, is liable to an action of damages at the suit of such strangers. It is also a general rule affecting contracts (other than marriage), that misrepresentation in some material point bearing on the contract, and likely to induce the party to enter into such contract, will render the contract void; but in order to make a trifling misrepresentation have the same effect, the party must warrant such representation to be true; in which case, whether trifling or not, or whether wilful or not, a misrepresentation avoids the contract; and this is generally the case in contracts of life and fire insurance. Against such a practice, Lord St Leonards lately remonstrated, as one involving great hardship to the class of insurers, who, after paying premiums for years, find at last their security gone. Another class of fraudulent misrepresentations, of great consequence, and now brought within the criminal law to a large extent, is that of counterfeiting trade-marks, as to which, see **TRADE-MARKS**.

MISSE DI VO'CE, a term used in the art of singing, meaning the gradual swelling and again diminishing of the sound of the voice on a note of long duration.

MISSEAL, the volume containing the prayers used in the celebration of the Mass. Anciently, considerable variety in minor details prevailed among the books in use in different countries, and even in different churches of the same country. With the view of restoring uniformity, the pope, in virtue of a decree of the Council of Trent, in 1570, ordered that all churches which had not, for a clearly ascertained period of 200 years, enjoyed an uninterrupted use of a peculiar service-book of their own, should thenceforth adopt the Roman Missal. Of this exemption, several churches in Germany, France, and even in Italy, availed themselves; but in later times, the great majority have conformed to the Roman use. The Roman Missal has twice since that date been subjected to revision and correction—in 1604 by Clement VIII., and in 1634 by Urban VIII. The latter recension still continues in use. The missals of the oriental rites differ from that of the Roman Church, each having for the most part its own proper form. See **LITURGY**.

MISSIONS, enterprises of the Christian Church for the conversion of the nations to Christianity, by sending to them teachers called *missionaries*.

The first Christians displayed great zeal in preaching the gospel to the heathen; Christian teachers continued to go forth for this purpose into heathen countries until about the 9th c., and although other and less worthy means were too often employed, the labours of Palladius in Ireland, of Columba in Scotland, of Augustine in England, of Gallus and Emmeran in Alemannia, of Kilian

in Bavaria, of Willibrod in Franconia, of Swidvrit in Friesland, of Siegfried in Sweden, of Boniface in Thuringia and Saxony, of Adalbert in Prussia, of Cyril and Methodius amongst the Slavonians, and of many such early missionaries, were unquestionably very instrumental in the extension of Christianity in Europe. After the Reformation, the Roman Catholic Church, roused to activity by its losses and dangers, not only sent forth missionaries to confirm its adherents in Protestant countries, and to win back Protestants, but also sought to repair its losses by new acquisitions from the vast domain of heathenism. With this view, the *Congregatio de Propaganda Fide* was constituted by Gregory XV. in 1622, and the *Collegium de Propaganda Fide* (see PROPAGANDA) by Urban VIII. in 1627, and in a number of places, institutions, called *seminaries*, were established for the training of missionaries. The principal Roman Catholic missions are those to the East Indies and China. Jesuit missionaries earnestly prosecuted their work amongst the Indians of South America, from the middle of the 16th c. to the middle of the 18th, when they were expelled by the Portuguese and Spanish governments, because their political power had become too formidable. They are accused of administering baptism with too great readiness, so that their success as Christian missionaries is not, perhaps, to be estimated according to the numbers whom they baptized; but they were certainly successful in extending civilisation amongst the Indians, particularly of Paraguay. Jesuit missions to India and Japan were founded by Francis Xavier (q. v.) in the middle of the 16th century. In Japan, the missionaries made great progress at first; and in 1682 they boasted of 150,000 converts, 200 churches, and 59 religious houses of their order in that empire; but ere the middle of the 16th c., the whole work had been overthrown, and every missionary expelled. In China, similar rapid success was enjoyed, and was followed by a similar period of persecution, although the destruction effected was more partial than in Japan, and the Church of Rome continued to subsist in China, its missionaries and members enduring great hardships, and many of them evincing their sincerity even by their death. There are not a few Roman Catholics in China at the present time. In the 17th c., the Jesuits boasted of the vast success of their mission in Madura, a province of Southern India; but it was found to be rather apparent than real, and to have been attained by a compromise of Christianity and the employment of unworthy means, so that, after long contests in the papal court, a decision was pronounced against the Jesuits, and their connection with Madura was dissolved in the middle of the 18th century.

For a long period after the Reformation, the Protestant Church seems to have been little sensible of the duty of labouring for the propagation of Christianity; nor was it until the present century that missionary zeal began to be largely developed. In the middle of the 17th c. (1647), indeed, an act of the English parliament established the *Society for Propagating the Gospel in Foreign Parts*, and at the close of the century (1698), the *Society for Promoting Christian Knowledge* was established. A few missionaries laboured with zeal and success among the North American Indians, in which field the names of Eliot and Mayhew are particularly distinguished in the 17th c., and that of Brainerd in the 18th; but the commencement of more systematic and continuous missionary enterprise may be reckoned from the establishment of the first Protestant mission to India, which did not take place till the beginning of the 18th c., when Bartholomew Ziegenbalg and another were sent thither

by Frederick IV. of Denmark, and settled in a small territory then belonging to Denmark on the coast of Coromandel. The mission in the south of India soon received the support of the English *Society for Promoting Christian Knowledge*, and was maintained and extended chiefly by that Society during the whole of the 18th century. Amongst the missionaries who have laboured in this field, the name of Swartz is particularly distinguished; and the success which attended his exertions, and the influence which he acquired in the country, were equally remarkable. He died in 1798. Since that time, the missionary work in the south of India has been carried on with continued success, and by the missionaries of a number of societies. Greater progress has been made there than in any other part of India, nor, indeed, was the work commenced in any other part of India till almost a century later.—The Moravian Church early entered upon missionary enterprise, and was the first Protestant Church which did so in its united or corporate character; and very successful missions of the United Brethren were planted in the 18th c. at the Cape of Good Hope, in the West Indies, and in Labrador. Greenland had previously been made the field of similar enterprise by missionaries from Norway. The mission to Greenland was founded by Hans Egede (q. v.), in 1721, and has been maintained to the present day. Its success has been such, that the greater portion of the Greenlanders have now been converted to Christianity, and much of the rudeness of their former manner of life has disappeared.—Towards the close of the 18th c., some of the great missionary societies still existing in England were formed—the *Baptist Missionary Society* in 1792, the *London Missionary Society* in 1795. About the same time, the *British and Foreign Bible Society*, and the *Religious Tract Society*, were formed, which have co-operated with all the missionary societies as most important auxiliaries. The *Baptist Missionary Society*, immediately after its formation, sent missionaries to the north of India. Dr Carey was one of its first, and also one of its most eminent missionaries. India is now a field of labour for many missionary societies, not only of Britain, but also of America and of the continent of Europe. The *London Missionary Society* sent its first missionaries to the South Sea Islands, and the mission was maintained for about 16 years, amidst many difficulties, without any apparent success; but its success was afterwards great and rapid, first in Tahiti, and afterwards in other islands, so that now many of the islands of the South Seas are entirely Christian. The *London Missionary Society* soon entered also upon other fields of labour, and now maintains missions to many parts of the world. It was at first composed of members of almost all Protestant denominations; but the formation of other societies, and the engagement of churches as such in missionary enterprise—as the Wesleyan Methodist Church, the Church of Scotland, &c.—have left this Society now in a great measure to the English Independents. Since the commencement of the present century, a number of missionary societies have been formed in Britain, of which the *Church Missionary Society*, formed by members of the Church of England, is one of the most important, and has sent forth missionaries to many fields. Their labours have been particularly successful in New Zealand, in the west of Africa, and in the vicinity of Hudson's Bay. They have recently occupied Abyssinia as a field of missionary labour, and their missionaries have contributed much to our knowledge of the eastern and central parts of Africa; whilst Dr Livingstone, a missionary of the *London Missionary Society*, has, with a primary regard to the extension of missions,

explored a vast and previously unknown region in the south. The Wesleyan Methodists have planted their missions in many parts of the world. They have been particularly successful in the Fiji Islands, and in the kingdom of Ashanti, in Africa.—The American Board of Commissioners for Foreign Missions was formed in 1810, and was soon followed by other missionary societies in America, some of which rival those of Britain in magnitude and importance. One of the first enterprises of the American Board was the mission to the Sandwich Islands, founded in 1819, which has resulted in the general Christianisation of these islands, and in their civilisation to a degree which, considering the shortness of the time, may well be regarded with admiration. The American Baptist Missionary Society has occupied Burmah and the Eastern Peninsula as one of its principal spheres of labour, and there its missionaries have enjoyed remarkable success in the Christianisation and civilisation of the people called Karens, which must be esteemed one of the great triumphs of modern missionary enterprise. Since the beginning of the present century, a number of Protestant missionary societies have also been formed on the continent of Europe, of which the first was that of Basel, in 1816, and the next was that of Berlin, in 1823; and some of these have also maintained successful missions in heathen countries. The success of missions has hitherto, however, been only such as to encourage those whose expectations rest upon another foundation, not to satisfy their hopes. The instances of most marked and extensive success are those which have been already noticed, and that of Madagascar, where missionaries of the London Missionary Society enjoyed the protection and favour of King Radama I., and the church planted by them continued to exist, notwithstanding severe persecution, and the martyrdom of not a few of its members, during the next reign, and must be regarded, with reference to the whole circumstances of its origin and history, as a wonderfully flourishing church at the present day. In the south of Africa, also, important results have been attained. Access has recently been obtained to China, and a number of Protestant churches and societies have entered energetically upon that field. Preparation had been previously made for this, by missionary labours amongst the Chinese in the Eastern Peninsula, and by the study of the language, the compilation of grammars and dictionaries, and the translation of the Bible into the Chinese language. Indeed, it must be reckoned as among the services rendered to mankind by Christian missionaries in modern times, that they have not only translated the Bible and other religious books into many languages, but have reduced many barbarous tongues to writing, and have prepared grammars and dictionaries, thereby contributing not a little, independently of their highest aim, to the promotion of knowledge, civilisation, and the welfare of the human race.

The progress of Christian missions to Mohammedan countries has hitherto been very small, although numerous converts from Mohammedanism, as well as from heathenism, have been made in India. Missions to the Jews have for more than 20 years engaged not a little of the attention of some portions of the Christian Church, particularly in England and Scotland. Missions have been planted in places where Jews are numerous, and already with considerable success.

MISSISSIPPI, one of the south-western United States of America, lies in lat. 30° 13'—35° N., and long. 88° 7'—91° 41' W. It is 332 miles from north to south, and from 78 to 118 miles from east to west, containing an area of 47,156 square miles. It

is bounded N. by Tennessee, E. by Alabama, S. by the Gulf of Mexico and East Louisiana, and W. by the rivers Pearl and Mississippi. The state also includes a cluster of islands in the Gulf, of which the principal are Horn, Deer, and Ship Islands. There are 60 counties. The principal towns are Jackson (the capital), Natchez, Vicksburg, and Columbus. There are 88 miles of sea-coast, but no good harbours. The surface is undulating, and generally very fertile, with river-bottoms of great productiveness. The sea-coast is sandy, but well timbered with live oak, magnolia, and pine, and is considered one of the most healthy districts in the world. The state borders for 500 miles on the Mississippi, and is drained by its tributaries, the Yazoo, Black, Sunflower, &c., and by the Pearl and Pascagoula, flowing into the Gulf of Mexico. The country is of the Tertiary and Upper Secondary formations, with great alluvial valleys; the climate semi-tropical; the chief productions, cotton, sugar, maize, wheat, sweet potatoes, peaches, figs, oranges, &c. In its forests are found the deer, puma, bear, wolf, wild-cat, parquets, wild turkeys, and pigeons, with fish and alligators in the rivers. The state is well provided with railways, and has immense wealth and resources. In 1850, with a population of 606,526, it produced 200,000,000 lbs. of cotton, and 22,000,000 bushels of Indian corn. It had 780 public schools, 171 academies, 11 universities and colleges, 1016 churches, 50 periodicals, 260 paupers, and 46 convicts. This region was traversed by De Soto in 1542. La Salle descended the Mississippi in 1682, and claimed the country for France; in 1698, M. d'Iberville formed settlements on the coast at Ship Island and Biloxi. Natchez was settled in 1700; but in 1728 this settlement was destroyed by the Natchez tribe of Indians, who were afterwards defeated, and the survivors sold into slavery in St Domingo. M. was admitted to the Union in 1817; it seceded in 1861, and joined the Southern Confederacy. In 1863, the city of Vicksburg, after a long and gallant defence, was forced, by famine, to surrender to General Grant; and Jackson, the capital, was taken, and partially destroyed by the Federals, and some of the finest regions of the state laid waste. Pop. in 1860, 791,396, of which the slaves numbered 436,696.

MISSISSIPPI (Indian, *Miche Sepe*, Great River, literally, Father of Waters), a river of the United States of America, the principal river of North America, and, including its chief branch, the Missouri, the longest in the world, rises in the highlands of Minnesota, in a cluster of small lakes, and near the sources of the Red River of the North, and the rivers which flow into Lake Superior, in lat. 47° 10' N., long. 94° 54' W. Its sources are 1680 feet above the Gulf of Mexico, into which it enters. Its general course is southerly, with numerous windings, giving it a length of 2986 miles to its mouth, in lat. 29° N., long. 90° W., from which, to the source of the Missouri, is 4506 miles. The M. and its branches drain an area of 1,226,600 square miles. It is navigable to the Falls of St Anthony, 2200 miles, and by smaller boats above the falls; or by the Missouri, 3950 miles, and has 1500 navigable branches, the chief of which are the Red River, 340 miles from its mouth; the Yazoo, 534 miles; the Arkansas, 700 miles; the Ohio, 1053 miles; the Missouri, 1253 miles. The M. River forms a portion of the boundaries of ten states, having the southern part of Minnesota, Iowa, Missouri, Arkansas, and most of Louisiana on the west bank; and Wisconsin, Illinois, Kentucky, Tennessee, and Mississippi on the east. The chief towns situated on its banks are New Orleans,

Natchez, Vicksburg, Memphis, St Louis, Quincy, Keokuk, Galena, St Paul. The Upper M., above the junction of the Missouri, flows through a picturesque and beautiful country. The great lower valley is 500 miles long, and from 30 to 50 wide. The delta, through which flow its numerous bayous, is 150 miles wide. The alluvial plain through which the river winds has an area of 31,200 square miles; and the delta, 14,000 square miles, all of which, except a few bluffs, is protected by levees, or embankments, from frequent inundations. The descent of the plain is 320 feet, or 8 inches per mile. The river, at high water, is higher than the plain, and the banks higher than the swamps of the interior. The great floods rise 40 feet above low water at the head of the plain, and 20 feet at New Orleans, and for the whole distance the river averages 3000 feet wide, and is from 75 to 120 deep. There is no apparent increase from the largest branches, and it is estimated that 40 per cent. of the floods are lost in the great marshes. Thousands of acres of land upon the banks are annually carried away by the current, with their growth of timber.

MISSISSIPPI SCHEME. The gigantic commercial scheme commonly known by this name was projected in France by the celebrated John Law (q. v.) of Lauriston, in 1717, and collapsed in 1720. Its primary object was to develop the resources of the province of Louisiana and the country bordering on the Mississippi, a tract at that time believed to abound in the precious metals. The company was incorporated in August 1717, under the designation of the *Company of the West*, and started with a capital of 200,000 shares, of 500 livres each. They obtained the exclusive privilege of trading to the Mississippi, farming the taxes, and coining money. The prospectus was so inviting, that shares were eagerly bought; and when, in 1719, the company obtained the monopoly of trading to the East Indies, China, the South Seas, and all the possessions of the French East India Company, the brilliant vision opened up to the public gaze was irresistible. The *Company of the Indies*, as it was now called, created 50,000 additional shares, but a rage for speculation had seized all classes, and there were at least 300,000 applicants for the new shares, which consequently rose to an enormous premium. Law, as director-general, promised an annual dividend of 200 livres per share, which, as the shares were paid for in the depreciated *billets d'état*, amounted to an annual return of 120 per cent. The public enthusiasm now rose to absolute frenzy, and Law's house, and the street in front of it, were daily crowded with applicants of both sexes and of all ranks, who were content to wait for hours, nay, for days together, in order to obtain an interview with the modern Plutus. While confidence lasted, a factitious impulse was given to trade in Paris; the value of manufactures was increased fourfold, and the demand far exceeded the supply. The population is said to have been increased by hundreds of thousands, many of whom were glad to take shelter in garrets, kitchens, and stables. But the regent had meanwhile caused the paper circulation of the national bank to be increased as the M. S. stock rose in value, and many wary speculators, foreseeing a crisis, had secretly converted their paper and shares into gold, which they transmitted to England or Belgium for security. The increasing scarcity of gold and silver becoming felt, a general run was made on the bank. The M. S. stock now fell considerably, and despite sundry desperate efforts, which were attended with momentary success, to keep up its credit, it continued to fall steadily and rapidly. In

February 1720, the National Bank and the Company of the Indies were amalgamated, but though this gave an upward turn to the share-market, it failed to put the public credit on a sound basis. Several useless attempts were made to mend matters; and those suspected of having more than a limited amount (fixed by a law passed at the time) of gold and silver in their possession, or of having removed it from the country, were punished with the utmost rigour. The crisis came at last. In July 1720, the bank stopped payment, and Law was compelled to flee the country. A share in the M. S. now with difficulty brought twenty-four livres. An examination into the state of the accounts of the company was ordered by government; much of the paper in circulation was cancelled; and the rest was converted into 'rentes' at an enormous sacrifice.

MISSIVE, in Scotch Law, is a memorandum. See **MINUTE**; **LETTERS**.

MISSOLO'NGHI, also **MESOLONGHI**, a small town of Greece, in the government of *Ætolia*, on the northern shore of the Gulf of Patras, 24 miles west of Lepanto. It is chiefly memorable for the two sieges which it underwent during the war of independence in the early part of the present century. In 1822, it was invested by land and sea by the Turks, who, after a siege of two months, were compelled to withdraw. In 1826, it was again besieged by an overwhelming Ottoman force; and after ten months of resistance and suffering, its garrison, reduced from 5000 to 3000 fighting-men, cut their way through the ranks of the enemy, carrying with them a great number of the women and children. The Turks then entered the town, which was all but totally destroyed. Here Lord Byron died in 1824. Pop. about 4000.

MISSOURI, one of the United States of America, in lat. 36° 30'—40° 30' N., and long. 89° 2'—95° 52' W., being 277 miles from north to south, and from 200 to 312 miles from east to west, having an area of 67,380 square miles, or 43,123,200 acres. It is bounded N. by Iowa; E. by the Mississippi River; S. by Arkansas; and W. by Nebraska Territory, Kansas, and the Indian Territory. M. has 112 counties. Its chief towns are Jefferson City (the capital), St Louis, Booneville, Hannibal, Independence, Lexington. Its chief rivers are the Mississippi, which borders the state for 470 miles; the Missouri, which forms a portion of its western boundary, and passes through it from west to east; and its affluents, the Osage, Gasconade, &c. The country south of the Missouri River is undulating, rising into mountains toward the borders of Arkansas; the northern portion of the state is level prairie-land, with rich bottoms, and high picturesque bluffs on the rivers. The geological formations range between the Lower Silurian and Upper Coal. There are porphyritic rocks in the south; in the centre, coal-measures, with veins of an aggregate thickness of 500 feet, highly bituminous, and immense deposits of iron, with lead and iron in limestone formations. The winters are long and severe, the summers hot, with sudden changes. Much of the land is very fertile, producing maize, wheat, hemp, tobacco, the peach, nectarine, grape, &c. Cotton is grown in the southern counties. A large German population has introduced wine-making. The chief manufactures are ironworks, distilleries, and breweries. St Louis has a large trade, and the western towns supply caravans or trains to New Mexico, Utah, and California. The state has appropriated 24,000,000 dollars to railways, four lines of which branch out from St Louis, and one crosses the northern part of the state. There are 11

universities and colleges, several medical and ecclesiastical seminaries, about 1000 churches, and 70 newspapers. This state was formerly a portion of Upper Louisiana. St Genevieve was settled in 1755, by emigrants from Canada and Spain. St Louis, a French trading-post, in 1775, had 800 inhabitants. The country was purchased by President Jefferson in 1803; and in 1821, after a great contest, was admitted into the Union as a slave state, under what was called the Missouri Compromise, which admitted M., but prohibited slavery north of the northern boundary of Arkansas, 36° 30' N. lat. In 1861, M. joined with the Seceded States, and became a scene of civil war and violent partisan conflicts. Pop. in 1820, 66,586; in 1840, 383,702; in 1860, 1,182,317, of whom 114,965 were slaves.

MISSOURI (Mud River), a river of the United States of America, and chief affluent of the Mississippi, rises in two forks, the Jefferson and Gallatin, in the Rocky Mountains, Dakota Territory, lat. 45° N., long. about 112° W. Its course is first northerly for 500 miles, then easterly 1200, then south-easterly to the mouth of the Kansas, and easterly to its junction with the Mississippi. Its length from its source to the Mississippi is 3096 miles; to the Gulf of Mexico, 4506. It is navigable at high water to the Great Falls, 2540 miles from the Mississippi. It is a turbid, rapid stream, with a vast number of tributaries, the chief of which are the Osage, the Kansas, the Platte, the Cheyenne, the Yellowstone. The Upper M. is remarkable for its scenery; at 411 miles from its source, it enters the Gates of the Rocky Mountains, a gorge of 5½ miles, between perpendicular walls 1200 feet high, and 450 feet apart. At the Great Falls, 145 miles below, the river falls 357 feet in a series of rapids and cascades, 16½ miles long. The largest fall is 87 feet, and the scenery is full of grandeur.

MISTAKE is a ground in law for having a contract reformed, and may be set up in some cases as a defence; but a mere mistake as to the legal effect of a deed or contract is in general not regarded as a ground for redress. When money has been paid by a mistake as to some important fact, it may be recovered back from the party to whom it was so paid by an action for money had and received; but if the mistake was made in a matter of law, it cannot be recovered back.

MISTLETOE (Anglo-Sax. *mistellan*, Ger. *mistel*; the *tan* of the Anglo-Saxon name means a tine or prong, a shoot of a tree; *mistel* is of uncertain etymology, but probably the same, in meaning at least, as the Latin *viscus*), a genus (*Viscum*) of small parasitical shrubs of the natural order *Loranthaceæ*. This order is exogenous, and contains more than 400 known species, mostly tropical and parasites. The leaves are entire, almost nerveless, thick and fleshy, and without stipules. The flowers of many species are showy. The calyx arises from a tube or rim, which sometimes assumes the appearance of a calyx, and is so regarded by many botanists; what others deem the coloured calyx being viewed by them as a corolla of 4 or 8 petals or segments. Within this are the stamens, as numerous as its divisions, and opposite to them. The ovary is one-celled, with a solitary ovule; the fruit one-seeded, generally succulent.—The only British species of this order is the **COMMON M.** (*V. album*), a native also of the greater part of Europe, growing on many kinds of trees, particularly on the apple, and others botanically allied to it, as the pear, service, and hawthorn; sometimes, also, on sycamores, limes, poplars, locust-trees, and firs, but very rarely on oaks (contrary to the common belief). It is very plentiful in some parts of the south of England, its evergreen leaves

giving a peculiar appearance to the orchards in winter, when the bushes of M. are very conspicuous among the naked branches of the trees; but it is very local. It is not a native of Scotland, though found naturalised in various places. The stems are

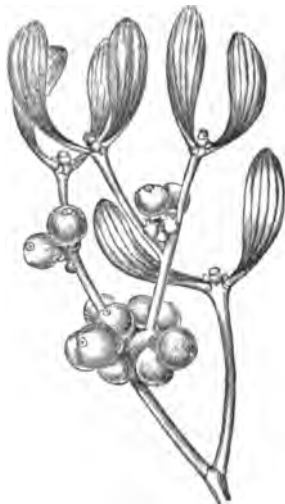

Mistletoe (*Viscum album*).

dichotomous (i. e. divide by forking); the leaves are opposite, of a yellowish-green colour, obovate-lanceolate, obtuse. The flowers are inconspicuous, and grow in small heads at the ends and in the divisions of the branches, the male and female flowers on separate plants. The berries are about the size of currants, white, translucent, and full of a very viscid juice, which serves to attach the seeds to branches, where they take root when they germinate, the radicle always turning towards the branch, whether on its upper or under side. The M. derives its nourishment from the living tissue of the tree on which it grows, and from which it seems to spring as if it were one of its own branches. The berries are a favourite food of thrushes. Bird-lime is made from them and from the bark. The M. was intimately connected with many of the superstitions of the ancient Germans and of the British Druids. In the northern mythology, Balder is said to have been slain with a spear of mistletoe. Among the Celts, the M. which grew on the oak was in peculiar esteem for magical virtues. Traces of the ancient regard for the M. still remain in some old English and German customs, as kissing under the M. at Christmas. The M. was at one time in high repute as a remedy for epilepsy and convulsions, but it seems to possess no decided medicinal properties.—*Loranthus Europæus*, a shrub very similar to the M., but with flowers in racemes, is plentiful in some parts of the south of Europe, and very frequently grows on oaks.—*L. odoratus*, a Nepalese species, has very fragrant flowers.

MISTRAL, **MISTRAOU**, or **MAESTRAL**, the Provençal designation of the *Caurus* or *Corus* of the Romans, is a north-west wind which at certain seasons of the year prevails on the south coast of France. Its approach is heralded by a sudden change of the temperature, from the most genial warmth to piercing cold; the air is felt to be purer, and more easily inhaled, the azure of the sky is undimmed by cloud, and the stars shine by night with extraordinary and sparkling brightness; this last appearance is an infallible prognostic. The Mistral

then comes in sudden gusts, struggling with the local aerial currents, but its fast increasing violence soon overcomes all opposition. In a few hours, it has dried up the soil, dispersed the vapours of the atmosphere, and raised a dangerous tumult among the waters of the Mediterranean. The Mistral blows with its greatest force from the end of autumn to the beginning of spring, and causes much damage to the fruit-trees in blossom, and often to the field-crops. It is a terror to the mariners of the gulfs of Lyon and Valence, and even the most hardy seaman makes all haste to a harbour of refuge. The most probable cause of the Mistral is the derangement of atmospheric equilibrium produced by the cold condensed air of the Alps and Cevennes rushing in to supply the vacuum produced by the expansion of the air in the warm southern provinces of France, and on the surface of the Mediterranean. This wind is very appropriately denominated by the Italians *Maestro*.

MISTRETTA, a town of the island of Sicily, 67 miles west-south-west of Messina, capital of a district. Pop. 8400. It occupies a healthy situation near the northern coast, in the vicinity of the river Nebroden.

MITAKSHARĀ is the name of several commentatorial works in Sanscrit, for instance, of a commentary on the text-book of the Vedānta philosophy, of a commentary on the Mīmāṃsā work of Kumārila, of a commentary on the Br̥hadāraṇyaka (see *VEDA*), &c. The most renowned work, however, bearing this title is a detailed commentary by Vijnānes'wara (also called Vijnānanātha), on the law-book of Yājñavalkya (q. v.); and its authority and influence are so great that 'it is received in all the schools of Hindu law from Benares to the southern extremity of the peninsula of India as the chief groundwork of the doctrines which they follow, and as an authority from which they rarely dissent' (cf. two treatises on the Hindu Law of inheritance, translated by H. T. Colebrooke, Calcutta, 1810). Most of the other renowned law-books of recent date, such as the *Smṛiti-Chandrikā*, which prevails in the south of India, the *Chintāmanī*, *Vīramitrodaya*, and *Mayūkha*, which are authoritative severally in Mithilā, Benares, and with the Mahrattas, generally defer to the decisions of the M.; the *Dāyabhāga* of Jimtāvāhana alone, which is adopted by the Bengal school, differs on almost every disputed point from the M., and does not acknowledge its authority. The M., following the arrangement of its text-work, the code of Yājñavalkya, treats in its first part of duties in general; in its second, of private and administrative law; in its third, of purification, penance, devotion, and so forth; but, since it frequently quotes other legislators, expounding their texts, and contrasting them with those of Yājñavalkya, it is not merely a commentary, but supplies the place of a regular digest. The text of the M. has been edited several times in India. An excellent translation of its chapter 'On Inheritance' was published by Colebrooke in the work above referred to; and its explanation of Yājñavalkya is followed by the same celebrated scholar in his *Digest of Hindu Law* (3 vols. Calcutta and London, 1801), when translating passages from this ancient author.

MITE, a name sometimes given to the *Acarides* generally (see *ACARUS*); sometimes only to those of them which have the feet formed for walking, and the mouth not furnished with a sucker formed of lancet-like plates, as in the *Ticks* (q. v.), but with mandibles. All of them are small creatures; the species are very numerous; they feed chiefly on decaying animal and vegetable substances, or are

parasitical on quadrupeds, birds, and insects. The *CHEESE M.* (*Acarus domesticus*, figured in the article *ACARUS*) is one of the best known species; another is the *FLOUR M.* (*A. farinae*), too common among flour, in both of which the body is covered with hairs very large in proportion to its size, and capable of a considerable amount of motion. The *SUGAR M.* (*A. saccharinus*) swarms in almost all soft sugar; but refined and crystallised sugar seems to defy its mandibles, and is free of it. The surface of jelly and preserves, when it has begun to become dry, is often covered with multitudes of very small mites. A species of M. is the cause of Itch (q. v.); and many of the lower animals are infested by parasites of this tribe. Beetles may often be seen absolutely loaded by a species which preys on them; and bird-fanciers regard with the utmost horror the *RED M.*, which lurks in crevices of cages and aviaries, and sucks the blood, and eats the feathers of their inmates.

MITFORD, MARY RUSSELL, a well-known English authoress, was the only child of a physician, and was born at Alresford, Hants, December 16, 1786. At the age of ten, she was sent to a boarding-school at Chelsea, and also placed under the guidance and tuition of a Miss Rowden, a lady of a literary turn, who had already educated Lady Caroline Lamb, and was destined to be the instructress of Miss Landon and of Fanny Kemble. During the five years she spent here, she read with avidity, studying the tragic authors of France, Shakspeare, and the early dramatists of England. At the age of fifteen, she returned home, and before she was twenty, she published three volumes of poetry. These having been severely castigated by the *Quarterly Review*, she applied herself to writing tales and sketches for the magazines. The profession she had adopted from taste she was obliged to continue from necessity, for the spendthrift habits of her father, a good-natured but careless gentleman, had exhausted a competent fortune, and left him dependent on his daughter. The first volume of *Our Village* appeared in 1824, and the series of five volumes was completed in 1832. Of the more important of her dramatic works, *Julian* was first performed in 1823; the *Foscari* in 1826; and *Rienzi* in 1828—all of them, and especially the last, with success. Among her other important works, are *Recollections of a Literary Life* (3 vols. 1852); *Atherton* (a novel, 3 vols. 1854) and *other Tales*; and in 1854, she also published a collected edition of her Dramatic Works, in two volumes. In 1838, she received a pension from government, but neither this nor the growing ill-health of her later years, induced her to relax her literary industry. She died at her residence, Swallowfield Cottage, near Reading, January 10, 1855.

Successful both as a compiler and an author, Miss M. has produced many interesting volumes; but her fame—if the admiring respect for an amiable lady and a woman of graceful literary genius may be so called—rests chiefly on the sketches of country life which compose *Our Village*. These sketches are chiefly memorable for their style, which, if not witty, is vivacious, genial, and humorous; the outcome at once of a good heart, an active brain, and a fine fancy.

MITFORD, WILLIAM, was born in London, February 10, 1744, and studied at Queen's College, Oxford, but left the university without taking his degree. In 1761, he succeeded to the family estate; and in 1769, became a captain in the South Hampshire Militia, in which capacity he made the acquaintance of Gibbon, then a major of the same,

by whose advice and encouragement he was induced to undertake a history of Greece. M.'s first work, entitled *An Inquiry into the Principles of Harmony in Languages, and of the Mechanism of Verse, Modern and Ancient*, appeared in 1774; but by far his most important publication was his *History of Greece*, the first volume of which appeared in 1784, and the last in 1818. It is a pugnacious, opinionative, one-sided, and even fanatical production. The author is an intense hater of democracy, and can be seen in Philip of Macedon nothing but a great statesman, and in Demosthenes, nothing but an oratorical demagogue. Yet his zeal, which so often led him astray, also urged him, for the very purpose of substantiating his views, to search more minutely and critically than his predecessors into certain portions of Greek history, and the consequence was that M.'s work held the highest place in the opinion of scholars until the appearance of Thirlwall and Grote. He died February 8, 1827.

MITHRAS (cf. Sanscrit *Mitram*, friend), the highest of the twenty-eight second-class divinities of the ancient Persian Pantheon, the *Ized* (Zend. *Yasata*) or Genius of the Sun, and ruler of the universe. Protector and supporter of man in this life, he watches over his soul in the next, defending it against the impure spirits, and transferring it into the realms of eternal bliss. He is all-seeing and all-hearing, and, armed with a club—his weapon against Ahriman and the evil *Devas*—he unceasingly ‘runs his course’ between heaven and earth. The ancient monuments represent him as a beautiful youth, dressed in Phrygian garb, kneeling upon an ox, into whose neck he plunges a knife; several minor, varying, allegorical emblems of the sun and his course, surrounding the group. At times, he is also represented as a lion, or the head of a lion. The most important of his many festivals was his birthday, celebrated on the 25th of December, the day subsequently fixed—against all evidence—as the birthday of Christ. The worship of M. early found its way into Rome, and the mysteries of M. (*Hierocoracia*, *Coracia Sacra*), which fell in the spring equinox, were famous even among the many Roman festivals. The ceremonies observed in the initiation to these mysteries—symbolical of the struggle between Ahriman and Ormuzd (the Good and the Evil)—were of the most extraordinary and to a certain degree even dangerous character. Baptism and the partaking of a mystical liquid, consisting of flour and water, to be drunk with the utterance of sacred formulas, were among the inaugurative acts. The seven degrees—according to the number of the planets—were, 1. Soldiers; 2. Lions (in the case of men), or Hyænas (in that of women); 3. Ravens; 4. Degree of *Perseus*: 5. of *Oromios*: 6. of *Helios*: 7. of *Fathers*—the highest—who were also called *Eagles and Hawks*. At first, of a merry character—thus the king of Persia was allowed to get drunk only on the *Fest of the Mysteries*—the solemnities gradually assumed a severe and rigorous aspect. From Persia, the cultus of M. and the mysteries were imported into Asia Minor, Syria, Palestine, &c., and it is not unlikely that in some parts human sacrifices were connected with this worship. Through Rome, where this worship, after many vain endeavours, was finally suppressed in 378 A.D., it may be presumed that it found its way into the west and north of Europe; and many tokens of its former existence in Germany, for instance, are still to be found, such as the M. monuments at Hedernheim, near Frankfurt-on-the-Maine, and at other places. Among the chief authorities on this subject are *Anquetil du Perron*, *Creuzer*, *Silvestre de Sacy*, *Lajard*, *O. Müller* (*Denkmäler d. alten Kunst*). See **GUÉBRES**, **PARSEES**, **ZENDAVESTA**.

MITHRIDATES (more properly, **MITHRADATES**, a name formed from the Persian *Mithras*, or *Mithra*, ‘the sun,’ and an Aryan root *da*, to give; hence ‘sun-given’ or ‘sun-born’ princes), the name of several kings of Pontus, Armenia, Commagene, Parthia, and the Bosphorus, all of whom have sunk into insignificance, with the exception of M. VI. of Pontus, surnamed **EUPATOR** and **DIONYSUS**, but more generally known as **M. THE GREAT**. Little is known of his early career. He succeeded his father, probably about 120 B. C., while under 13 years of age, and soon after subdued the tribes who bordered on the Euxine, as far as the Chersonesus Taurica (Crimea), and after the death of Parysatis, incorporated the kingdom of the Bosphorus with his dominions. The jealous behaviour of the Romans, and the promptings of his own ambitious spirit, now incited him to invade Cappadocia and Bithynia, but a wholesome fear of the power of the Great Republic induced him to restore his conquests. The *First Mithridatic War* was commenced by the king of Bithynia (88 B. C.), who, at the instigation of the Romans, invaded Pontus. M. sent an ambassador to Rome to complain of this treatment, but he was sent back with an evasive reply. M. immediately commenced hostilities, and his generals repeatedly defeated the Asiatic levies of the Romans, and he himself took possession of Bithynia, Cappadocia, Phrygia, and the Roman possessions in Asia Minor, the inhabitants of which last hailed him as a deliverer. By his orders, a great massacre of the Romans took place, in which, according to one account, 80,000, and according to another, 150,000 were slain. He also sent three powerful armies to aid the Greeks in their rebellion, but the disastrous battles of Chæronea and Orchomenus broke his power in that country. He was, however, driven from Pergamus (85 B. C.) by Flavius Fimbria, and reduced to the necessity of making peace with Sulla, relinquishing all his conquests in Asia, giving up 70 war-galleys to the Romans, and paying 2000 talents. The wanton aggressions of Murena, the Roman legate, gave rise to the *Second Mithridatic War*, in 83 B. C. M. was wholly successful in this war, but peace was concluded on the *status quo*, 81 B. C. M. felt, however, that this was merely a truce, and lost no time in preparing for a third contest, in alliance with Tigranes, king of Armenia, the next most powerful monarch of Asia. Tigranes seized Cappadocia, 76 B. C., and M., in the following year, invaded Bithynia, commencing the *Third Mithridatic War*. M. formed an alliance with Sertorius (q. v.), and obtained the services of Roman officers of the Marian party, who trained his army after the Roman manner. The arms of M. were at first successful; but afterwards the Roman consul Lucullus (q. v.) compelled him to take refuge with Tigranes, 72 B. C. Lucullus then conquered Pontus, defeated Tigranes, 69 B. C., at Tigranocerta, and both Tigranes and M. at Artaxata, 68 B. C. M., however, recovered possession of Pontus. After the war had lingered for some time, Cneius Pompeius (see **POMPEY**), completed the work of Lucullus, 66 B. C., defeating M. on the Euphrates, and compelling him to flee to the Bosphorus. Here his indomitable spirit prompted him to form a new scheme of vengeance, which was, however, frustrated by the rebellion of his son, Pharnaces, who besieged him in Panticapæum. Deeming his cause hopeless, M. put an end to his own life, 63 B. C. M. was a specimen of the true eastern despot, but he possessed great ability, and extraordinary energy and perseverance. His want of success was owing not to his defects as a general, but to the impossibility of raising and training an army capable of coping with the Roman legions, and his

system of tactics during the third Mithridatic war plainly shews his thorough conviction of this fact. He had received a Greek education at Sinope, could speak no less than 25 different languages and dialects, and possessed considerable love for the arts, of which his magnificent collections of pictures, statues, and engraved gems were a proof. In the estimation of the Romans, he was the most formidable opponent they ever encountered, and occasional reports of his various successes spread the utmost terror among them.

MITRE, the point or line of union of mouldings meeting at an angle.

MITRE (Lat. *mitra*, also *infula*), the head-dress worn in solemn church services by bishops, abbots, and certain other prelates in the Western Church. The name, as probably the ornament itself, is borrowed from the orientals, although, in its present form, it is not in use in the Greek Church, or in any other of the churches of the various eastern rites. The western mitre is a tall, tongue-shaped cap, terminating in a twofold point, which is



Mitre.

supposed to symbolise the 'cloven tongues,' in the form of which the Holy Ghost was imparted to the apostles, and is furnished with two flaps, which fall behind over the shoulders. Opinion is much divided as to the date at which the mitre first came into use. Eusebius, Gregory of Nazianus, Epiphanius, and others speak of an ornamented head-dress, worn in the church; but there is no very early monument or pictorial representation which exhibits any head-covering at all resembling the modern mitre. From the 9th c., however, it is found in use, although not universally; and instances are recorded in which the popes grant permission to certain bishops to wear the mitre; as, for example, Leo IV. to Anshar, Bishop of Hamburg, in the 9th century. The material used in the manufacture of the mitre is very various, often consisting of most costly stuffs, studded with gold and precious stones. The colour and material differ according to the festival or the service in which the mitre is used, and there is a special prayer in the consecration service of bishops, used in investing the new bishop with his mitre. The mitre of the pope is of peculiar form, and is called by the name *Tiara* (q. v.). Although the mitre properly belongs to bishops only, its use is also permitted by special privilege to certain abbots, to provosts of some distinguished cathedral chapters, and to a few other dignitaries. See Binterim, *Denkwürdigkeiten der Kirche*, 1 B. 2 Th., p. 348.

The mitre, as an ornament, seems to have descended in the earliest times from bishop to bishop. Among the Cottonian MSS., is an order, dated 1st July, 4 Henry VI., for the delivery to Archbishop Chichely of the mitre which had been worn by his predecessor. It was in some cases a very costly ornament. Archbishop Pecheham's new mitre, in 1288, cost £173, 4s. 1d. In England, since the Reformation, the mitre is no longer a part of the episcopal costume, but it is placed over the shield of an archbishop or bishop, instead of a crest. The mitre of a bishop has its lower rim surrounded with a fillet of gold; but the Archbishops of Canterbury and York are in the practice of encircling theirs with a ducal coronet, a usage of late date and doubtful propriety. The Bishop of Durham

surrounds his mitre with an earl's coronet, in consequence of being titular Count Palatine of Durham, and Earl of Sedburgh. Before the custom was introduced of bishops impaling the insignia of their sees with their family arms, they sometimes differed their paternal coat by the addition of a mitre. Mitres are rare as a charge in heraldry, but are sometimes borne as a crest, particularly in Germany, to indicate that the bearers were feudatories, or dependancies of ancient abbays.

MITSCHERLICH, EILHARD, a distinguished Prussian chemist, was born at Neuende, near Jena, in 1794, and died at Berlin in 1863. In 1811, he proceeded to the university of Heidelberg, where he devoted himself to history, philology, and oriental languages; and he continued the study of these subjects at Paris and Göttingen. It seems to have been at the last-named university that (1814 or 1815) he first turned his attention to geology and mineralogy, chemistry and physics, and it was not till 1818, when he was at Berlin, that he selected chemistry as his special study. His observations on the striking similarity between the crystalline form and the chemical composition of the arseniates and the phosphates, led to his discovery of the law of Isomorphism (q. v.), the importance of which was so fully recognised by Berzelius, that he invited the young chemist, in 1819, to Stockholm, where he studied till 1821, when, on the death of Klaproth, he was, on the strong recommendation of Berzelius, appointed to the vacant chair of chemistry at Berlin. One of his earliest discoveries after his appointment was that of the double crystalline form of sulphur, the first observed case of Dimorphism. See DIMORPHOUS. His investigations regarding the formation of artificial minerals, and his memoirs on Benzine and on the Formation of Ether must be classed amongst his most important contributions to chemistry; but it is mainly on the discovery of Isomorphism and Dimorphism that his reputation will finally rest. His principal work is his *Lehrbuch der Chemie*, begun in 1829, and concluded in 1841. It has passed through five editions, and is especially valuable for the clear and simple way in which he has brought mathematics and physics to bear upon the subject. He was an honorary member of almost all the great scientific societies, and received the gold medal from the Royal Society of London for his discovery of the law of Isomorphism.

MITTAU, or **MITAU**, the chief town of the government of Courland, in European Russia, is situated on the right bank of the Aa, 25 miles south-west of Riga, and was founded in 1271 by the grand master of the Teutonic Knights. It was annexed to Russia in 1795. Pop. 22,900, the majority of whom are Germans by birth or descent, 1000 are Jews, and only a few Russians. The town is indifferently built, the houses being chiefly of wood, and painted of a green or brown colour. The most important buildings are the old castle—now the seat of the governor of the province—four churches, an astronomical observatory, a public library, a museum, and a number of educational and charitable institutions. As regards commerce and industry, the town occupies only the third place in the government, its principal product being articles of japanned iron and tin; there is an export trade in hemp, flax, and corn. M. is the winter residence of the gentry of the surrounding country, and was for some time the abode of Louis XVIII.

MITTIMUS, an English law-term for a writ by which a record is transferred out of one court into another.

MITYLENÉ. See **LESBOS**.

MIXED MARRIAGES—MIXED RACES.

MIXED MARRIAGES. In various countries of Europe, marriages between persons of different religions belief have either been prohibited or put under restrictions. The canon law forbade marriages between Christians and non-Christians; at one time, it merely discouraged, at another altogether prohibited the marriage of orthodox Christians with heretics. Subsequently to the Reformation, papal dispensations were in use to be granted for marriages between Catholics and Protestants, with the condition annexed, that the children should be brought up in the Catholic faith. During the latter part of the 17th c., parents seem to have been left at liberty to make what agreement they pleased on this head; and in default of their making any, it was presumed that the children would follow the religion of their father. In the middle of the 18th c., the validity of mixed marriages, even when celebrated by the civil magistrate, was recognised by the papal court; and under Napoleon's rule, they became common, without stipulations as to the children. The events of 1815 restored sufficient influence to the Roman Catholic Church, to enable the clergy to put in force a rule by which they could refuse to celebrate such marriages without an assurance that the children would be brought up Catholics. By the law of many of the German states, the clergyman of the bride was the only person who could competently officiate, and an engagement of this kind was often not only repugnant to the father as a Protestant, but illegal. Conflicts followed between the civil and ecclesiastical authorities, which have sometimes been obviated by the priest, on whom the law imposes the celebration of the marriage, not pronouncing the nuptial benediction, but giving his presence as a witness along with two other witnesses when the parties declared themselves husband and wife—a kind of marriage whose validity is perfectly recognised by the canon law. In Spain, marriages between Catholics and Protestants have sometimes taken place in this way, avoiding the stipulations otherwise necessary regarding the children.

There is a great diversity in the present state of the law of mixed marriages in different parts of Germany. In Prussia, according to the letter of the law, the children must be brought up in the faith of their father, and no compacts to the contrary are allowed; but practically, the law is evaded, no one having a recognised interest to object to the fulfilment of such agreements. In Austria, in the general case, either the clergyman of the bridegroom or of the bride may officiate at a marriage; but in marriages between Catholics and Protestants, the interposition of the Catholic priest is required; he need, however, not give the sacerdotal benediction; his passive assistance is sufficient, either in taking the declaration of the parties, which is followed by a Protestant ceremony, or by being present at the Protestant ceremony as a witness. When the husband is Catholic, all the children must be brought up Catholics; when the husband is Protestant, and the wife Catholic, the sons follow the father, and the daughters the mother. In Bavaria, mixed marriages may be performed either by Protestant or Catholic clergymen; and the spouses have it in their power to make what arrangements they please regarding the children before or after marriage, failing which, they are brought up in the religion of their father. In Electoral Hesse, the sons must follow the father, the daughters the mother. The husband's clergyman is the proper person to officiate, but if he refuse to do so without exacting a pledge regarding the children, the Protestant pastor is authorised to act. The same rule regarding the clergyman applies to Saxony, but

arrangements between the spouses as to the religion of the children are there given effect to; failing any such, the father's faith is the rule. In Hanover, the will of the father is the absolute rule. In Nassau, the children are brought up in their father's faith till the age of fourteen, when they are at liberty to choose for themselves. In the remaining states of Germany, the stipulations of the parents made before, not after marriage are given effect to; and in default of these, the father's religion is adhered to. In Denmark, stipulations may be made before or after marriage, and can be altered by mutual consent of the parents, or in some cases even after the death of one of them. In Slesvig-Holstein, a Protestant requires special leave to contract marriage with a person of another faith. Mixed marriages were, till lately, altogether prohibited in some of the Catholic cantons of Switzerland, but they are now authorised in all the cantons by the federal laws. It is generally the clergyman of the husband's creed who officiates, but at Zürich the ceremony is performed in both churches. In most cases, the children are required to be educated in the religion of their father.

In most German states, marriages between Christians and Jews or Mohammedans are interdicted; but since 1849, the prohibitions have in individual cases been dispensed with. In Denmark, such marriages have been permitted, on condition of the children being brought up Protestants. In Russia, the members of both Greek and Roman communions are prohibited from intermarrying with non-Christians: members of the orthodox Greek Church cannot marry Greek sectaries; but when an orthodox Russian marries a Protestant or Catholic, the benediction must be given in the Greek Church, and the children baptized in the Greek communion. When the parents are of different religions, but neither belongs to the Greek Church, ante-nuptial stipulations will be given effect to; if none have been made, the sons follow the father's faith, the daughters the mother's.

In France, the law regards marriage as a purely civil contract, and recognises only the civil celebration, which is completely separated from the religious rite. As the faith of the parents is not taken cognizance of, questions regarding the religious education of the children cannot arise before the civil tribunals.

The only restriction to which mixed marriages are now subjected in any part of the United Kingdom is imposed by act 19 Geo. II. c. 13, applicable to Ireland only, that a marriage celebrated by a Catholic priest between a Roman Catholic and a Protestant, or a person who within twelve months has been or professed to be a Protestant, or between two Protestants, is null.

MIXED RACES. The subject of *mixed races* is one intimately connected with an enlarged study of ethnology. It involves a consideration of the phenomena attendant upon the sexual union between individuals belonging to different varieties of the human race; as, for instance—adopting the classification of Blumenbach—between the European and the negro or the American Indian; or between the American Indian and the negro; or between any of these three and individuals belonging to the Malay and Mongolian varieties. It is well understood that such unions are in general prolific; and not only so, but that their offspring is likewise prolific; and this fact is much relied upon by some ethnologists, as an argument in favour of the unity of the human race. They reason thus: Were the different varieties of mankind distinct species, as has been frequently alleged, then it would necessarily follow that the offspring of such unions would prove

MIXED RACES—MNE MOSYNE.

as unfruitful as those between the horse and the ass, the goat and the sheep, the wolf and the dog; and similarly with respect to the hybrids among birds, insects, and plants. To sum up, in the words of Dr Prichard, the best exponent of this school of ethnology: 'It seems to be the well-established result of inquiries into the various tribes of organised beings, that the perpetuation of hybrids, whether of plants or animals, so as to produce new and intermediate tribes, is impossible. Now, unless all these observations are erroneous, or capable of some explanation that has not yet been pointed out, they lead, with the strongest force of analogical reasoning, to the conclusion, that a number of different tribes, such as the various races of men, must either be incapable of intermixing their stock, and thus always fated to remain separate from each other, or, if the contrary should be the fact, that all the races to whom the remark applies, are proved by it to belong to the same species.' Dr Prichard further observes, that so far from such unions between members of different varieties of the human race proving unfruitful, or their offspring unfruitful, the very opposite is the case, as, for instance, in unions between the negro and the European, the most strongly marked varieties of our race. 'If we inquire,' he says, 'into the facts which relate to the intermixture of negroes and Europeans, it will be impossible to doubt the tendency of the so-called Mulattoes to increase. The men of colour, or the mixed race between the Creoles and the negroes, are in many of the West India Islands a rapidly increasing people, and it would be very probable that they will eventually become the permanent masters of those islands, were it not for the great numerical superiority of the genuine negroes. In many parts of America, they are also very numerous.' It is to America, indeed, both north and south, that we must chiefly look for the numerous and varied phenomena resulting from this intermixture of races; for there we have not only the negro and the European mingling their blood, but the negro and the American Indian, the European and the Indian, and the offspring of each of these with the offspring of the other, or with members of either of the parent stocks; added to which, of late years, the Chinese (of Mongolian race or variety) have appeared upon the scene, thus contributing greatly to the number of what are termed *human hybrids*. All these, however, are not equally fertile; and with respect even to the Mulattoes, it is alleged by writers of the Morton school of ethnology that they do not perpetuate themselves for many generations. 'Nature,' says Squier, rather dogmatically, 'perpetuates no human hybrids—as, for instance, a permanent race of Mulattoes.' And Dr Nott, adopting the classification of species laid down by Dr Morton—namely, *Remote Species*, in which hybrids are never produced; *Allied Species*, which produce, *inter se*, an unfertile offspring; and *Proximate Species*, which produce with each other a fertile offspring—is of opinion that it is only by the union of southern or dark-skinned Europeans with negroes that thoroughly prolific Mulattoes are engendered, which is not the case in unions occurring between individuals of the Anglo-Saxon and negro races. In arriving at this conclusion, we cannot help thinking that the author has been helped forward by the strong prejudice existing in the Southern States against all taint of negro blood. A more impartial writer, Professor Wilson, in his *Prehistoric Man*, observes: 'There are upwards of four millions of people of African blood in the United States, and certainly not less than ten millions throughout the continent and islands of North and South America, and

of these the larger proportion consists of hybrids. . . . It is impossible to determine with certainty how far the hybrid coloured population of the United States is capable of permanency, either by the development of a fixed hybrid type, or by continuous fertility, until the predominant primary type reasserts its power, by their return to that of the original white or black parent, so long as the mixed breed is constantly augmented in the Southern States by means at variance with the natural and moral relations of social life.' As it is, the weight of evidence appears to be in favour of Dr Prichard's view; but until the doctrine of hybridity is better understood, and a more satisfactory answer to the vexed question, 'What is species?' has been supplied to us, we must deem it idle to pronounce dogmatically on the subject. See HYBRID and SPECIES. We conclude with a list of half-castes given by Dr Tachudi, 'with a few additions from other sources,' printed in the appendix to Professor Wilson's valuable work just mentioned.

Father.	Mother.	Half-caste.
White, . . .	Negro, . . .	Mulatto.
White, . . .	Indian, . . .	Mestizo.
Indian, . . .	Negro, . . .	Chino.
White, . . .	Mulatta, . . .	Cuarteron.
White, . . .	Mestiza, . . .	{ Creole, only distinguished from the white by a pale brown complexion.
White, . . .	Chinese, . . .	Chino-blanco.
White, . . .	Cuarterona, . . .	Quintero.
White, . . .	Quintera, . . .	White.
Negro, N. A., . . .	Indian, . . .	Zambo or Cariboco.
Negro, S. A., . . .	Indian, . . .	Mameluco.
Negro, . . .	Mulatta, . . .	Zambo-negro or Cabra.
Negro, . . .	Mestiza, . . .	Mulatto-osouro.
Negro, . . .	Chinese, . . .	Zambo-Chino.
Negro, . . .	Zamba, . . .	{ Zambo-negro (perfectly black).
Negro, . . .	Cuarterona, . . .	Mulatto (rather dark).
Negro, . . .	Quinterona, . . .	Pardoc.
Indian, . . .	Mulatta, . . .	Chino-osouro.
Indian, . . .	Mestiza, . . .	{ Mestizo-claro (frequently very beautiful).
Indian, . . .	China, . . .	Chino-oholo.
Indian, . . .	Zamba, . . .	Zambo-claro.
Indian, . . .	China-oholo, . . .	{ Indian (with short frizzly hair).
Indian, . . .	Cuarterona, . . .	Mestizo (rather brown).
Indian, . . .	Quintera, . . .	Mestizo.
Mulatto, . . .	Zamba, . . .	Zambo.
Mulatto, . . .	Mestiza, . . .	{ Chino (of rather clear complexion).
Mulatto, . . .	China, . . .	Chino (rather dark).

MIXTURES are officinal preparations, extempore in their nature, some of which—as, for example, *Mistura Camphora*, *Mistura Cretae*, and *Mistura Ferri Composita*—are very extensively used in medical practice, either as vehicles for more active remedies, or for their intrinsic value.

MI'ZEN, or MIZZEN, the sternmost of the masts in a three-masted vessel, and also the smallest of the three. Above it, are the mizen-topmast, the mizen-top-gallant-mast, and the mizen-royal. It supports the usual yards, and, in addition, the gaff and boom of the Spanker (q. v.). A rear-admiral hoists his pendant at the mizen.

Although the word mizen is now applied adjectively to the several parts, it appears formerly to have been the name of a large triangular sail carried in the stern, and thence to have become the distinguishing title of the mast which bore that sail. The name is probably from It. *mezzano*, mean, in the middle; in opposition to a square sail which lies across the vessel.

MNEMO'NICS. See MEMORY.

MNEMO'SYNE, in Classical Mythology, the goddess of Memory, and the mother of the nine Muses (q. v.), whom she bore to Jupiter. The principal seat of her worship was at Eleutherae, in Boeotia.

MOA, the name given by the New Zealanders to the large wingless or struthious birds (see *BREVI-PENNES*) of which the bones are found imbedded in the sands of the seashore, in swamps, forests, river-beds, and limestone caves, and of which traditions subsist among them as birds living in their country. The largest bones belong to the genus *Dinornis* (q. v.), others to *Palapteryx* (q. v.); and with them are found bones of a large bird (*Aptornis*) resembling a swan, supposed to be now extinct, also of the existing species of *Apteryx* (q. v.) and of *Notornis* (q. v.), much smaller birds. It is generally supposed that no large moas have been seen alive since about 1650; but it has recently been again alleged that some have been seen, and rewards have been offered for the capture of them. They are represented by the New Zealanders as stupid, fat, indolent birds, living in forests, mountain fastnesses, &c., and feeding on vegetable food. Their feet are said to have been adapted for digging. They seem to have been extirpated, or nearly so, for the sake of their flesh, feathers, and bones. The bones were made into fish-hooks, the skulls were used for holding tattooing-powder. The eggs were eaten. The leg-bones of the moas were filled with marrow, and not with air, as those of other birds.

MO'ABITES, a pastoral people, who inhabited the mountainous country east of the lower part of the Jordan and of the Dead Sea. Their *cultus* was characterised by many very odious rites, among which was human sacrifice. In the time of the Judges, the Jews were for eighteen years under the yoke of the M., who were afterwards made tributary by David, but, about 900 a. c., shook off their allegiance to the Jewish kings, and after the Assyrians invaded the land of Judah, took part with the Chaldeans against the Jews. The writings of the prophets are full of denunciations against the Moabites. Their name no longer exists, and the remnants of the people have long been included among the Arabs.

MOAT, the ditch round the ramparts of a fortress, may be either wet—i. e., full of water—or dry. In the latter, which is the commoner case, the depth should not be less than 12 feet, nor the width under 24. The more perpendicular the walls, so much the greater will be the obstruction to the enemy. In regular works, the walls are usually revêted with masonry, that at the foot of the rampart being the scarp or escarp, and that below the covered way the counterscarp. Further particulars relative to the moat and its extreme importance will be found under **DITCH** and **FORTIFICATION**.

MOBILE, the principal city and only seaport of Alabama, United States of America, is situated on the west side of Mobile River, and at the head of Mobile Bay, which opens into the Gulf of Mexico. It is built with broad shaded streets on a sandy plain, rising gradually from the river, with a fine Custom-house and Post-office, City Hall and Market-house, Theatre, Odd Fellows' Hall, Cathedral, 23 churches, 3 orphan asylums, several hospitals, a medical college; and in the suburbs, St Joseph's College (a Jesuit institution), and a Convent of the Visitation, and Academy for Young Ladies. M. has several ship-yards, foundries, and cotton-presses. Its chief business is the export of cotton, brought down the Alabama and Tombigbee rivers, and the Mobile and Ohio Railway. The average export for five years preceding the Civil War was 632,308 bales. Its harbour, defended by Fort Morgan, would be, with a deeper channel, one of the best on the Gulf. Its entire exports, in 1859, were over

30,000,000 dollars. M. was settled by the French in 1702. Pop. in 1860, 29,259.

MOBILE, a river and bay of Alabama, United States of America. The river is formed by the confluence of the Alabama and Tombigbee, 50 miles above Mobile, which lies at its mouth. It is a sluggish stream, with low banks, and several channels. The bay is 30 miles from north to south, and 10 or 12 from east to west. The entrance from the Gulf of Mexico, 3 miles wide, is defended by Fort Morgan and Fort Gaines.

MO'BILE, **MOBILISE**, an adjective and verb, used respectively in regard to continental armies, to designate a state of readiness for taking the field, and the act of making ready for such an operation. The process consists in augmenting a regiment from its peace to its war complement, in calling in men on furlough, in organising the staff of divisions and brigades, constituting the commissariat, medical, artillery, and transport services, and in accumulating provisions and munitions. As the work of mobilising an army causes great and inevitable expense, it is only resorted to when hostilities appear imminent.

MOBILIER, **CRÉDIT**. On the 18th November 1852, the French government sanctioned the statutes of a new bank under the name of the *Société Générale de Crédit Mobilier*. The name was intended as a contrast to the *Société de Crédit Foncier*, which are of the nature of land banks, and advance money on the security of real or immovable property; while the *Crédit Mobilier* proposed to give similar aid to the owners of movable property. The declared object of this bank is especially to promote industrial enterprises of all kinds, such as the construction of railways, sinking of mines, &c. Various privileges were conferred upon it under its charter; in especial, it was allowed to acquire shares in public companies, and to pay the calls made upon it in respect of such shares, by its own notes or obligations; also to sell or give in security all shares thus acquired. The operations of the society were conducted upon a very extensive scale. In 1854, it subscribed largely to the government loan on account of the Russian War, to the Grand Central Railway Company, to the General Omnibus Company of Paris, and to various other important undertakings. The dividend for this year was 12 per cent. In 1855, it lent two sums to the government—the one of 250, and the other of 375 millions of francs. Its operations were vast during this year, and the dividends declared amounted to 40 per cent. The directors had not hitherto availed themselves of their privilege of issuing their own obligations, but this they now resolved on doing. They proposed to issue two kinds—the one at short dates; the other at long dates, and redeemable by instalments. The proposed issue was to amount to 240 millions of francs, but the public became alarmed at the prospect of so vast an issue of paper-money, so that, in March 1856, the French government deemed it necessary to prohibit the carrying out of the proposed scheme. This was a severe blow to the institution. In 1856, its dividends did not exceed 22 per cent.; in 1857, they were only 5 per cent.; in 1859, they rose to 7½ per cent.; in 1860 and 1861, they were 10 per cent. The *Crédit Mobilier* has undoubtedly been highly useful in developing the industrial power of France, but its operations have been hazardous, and had they not been checked in time, they would in all probability have ended in disaster. The principal objects of the *Crédit Mobilier* are met by banks in Scotland by what is there termed the Cash-credit system.

MO'CHA, the most strongly fortified seaport, and once the capital, of the province of Yemen, in Arabia. It is situated on the Red Sea, at the head of a little bay near the Strait of Bab-el-Mandeb, and 130 miles west-north-west of Aden (q. v.). All round the shore is a hot sandy waste. The principal trade is in coffee, of which 10,000 tons (of the finest quality) are annually exported to Jiddah, Suez, and Bombay. Other exports are dates, gums, balm, ivory, senna, &c. Pop. 5000.

MOCHA STONES are pieces of agate or of chalcedony, containing dendritic infiltrations, often assuming appearances very like finely ramified con-fervæ, &c. They receive the name Mocha Stone because, when they first became known in Europe, they were brought from Mocha. Of the same nature with *M. S.* are *Moss Agates*. The resemblance of the enclosed infiltrations to plants is often merely accidental, but it appears to be sometimes really due to plants, which were enclosed in the cavity in which the silicious mineral itself was formed.

MOCKING-BIRD, or MOCKING-THRUSH (*Mimus* or *Orpheus*), a genus of birds of the family *Merulidae*, having a more elongated form than the true thrushes, a longer tail, shorter wings, and the upper mandible more curved at the tip. They are all American. The best known species, the *M.* of the United States (*M. polyglottus*), is about the size



Mocking-bird (*Mimus polyglottus*).

of the song-thrush; the upper parts of a dark brownish ash colour, the wings and tail nearly black, the under parts brownish white. The *M.* is common in almost all parts of America, from the south of New England to Brazil; north of the Delaware, it is only a summer visitant, but in more southern regions it is found at all seasons. It is one of the most common birds of the West Indies, and its exquisite song fills their groves with melody by night, for which reason it is there very generally known as the Nightingale. By day, the *M.* is generally imitative, excelling all birds in its power of imitation, now taking up the song of one bird, and now of another, and often deceiving the most practised ear by its perfect performance. By night, its song is for the most part natural. It does not confine itself, however, to musical strains; it seems to take equal pleasure in repeating the harshest cries of the feathered tribes; and in domestication readily adds to its accomplishments the imitation of almost any sound which it is accustomed to hear, passing from one to another with great rapidity, so as to produce an incomparable medley. The *M.* readily learns to whistle a tune, even of considerable length, but there is no well authenticated instance of its imitating the

human voice. The barking of a dog, the mewing of a cat, the crowing of a cock, the cackling of a hen, the creaking of a wheel-barrow, are all within the compass of its powers. During its performances, it spreads its wings, expands its tail, and throws itself about, as if full of enthusiasm and enjoyment. The *M.* is vocal at all seasons of the year. It enjoys almost everywhere the protection of man, and often makes its nest in a tree or bush close beside a house. Two or three broods are produced in a year. The male is extremely attentive to his mate, and manifests extraordinary courage in driving away enemies from the nest. Mocking-birds often assemble on such occasions, and birds of prey, far superior to them in size and strength, are compelled to retreat. Snakes are killed by reiterated blows on the head, and cats learn to consider the vicinity of a mocking-bird's nest unsafe. The food of the *M.* consists chiefly of berries and insects. Another species of *M.* is found in the Rocky Mountains, and species of the same genus are among the finest song-birds of the temperate parts of South America.

MODE, in Music. Every musical passage is referrible to and forms part of a succession of sounds having some appreciable relation to one another. This succession of sounds is called the Scale, and is a series of steps leading from a given note called the Key-note, or Tonic (q. v.), to its octava. The steps or degrees of the scale are of unequal size, and on the place of the smaller ones or semitones depends the mode of the music. Taking our natural



Major Mode.

Minor Mode.

scale, there are only two notes in it which can satisfy the ear as key-notes—viz, C and A. In the major mode, with C as key-note, the semitone or small interval falls between the third and fourth sounds; in the minor mode, with A as key-note, it falls between the second and third sounds; in the former case, the third of the key-note is a major third, in the latter a minor third. The minor mode further requires to be modified by occasionally sharpening its sixth and seventh, in order to be pleasing to modern ears. The scale of the major mode is derived from simpler harmonic proportions than that of the minor. Melodies composed in the latter mode have generally more or less of a plaintive or melancholy character. For the theory of these modes, see **MUSIC**. Ancient musicians admitted of a greater variety of modes. The Greeks had six, designated the Dorian, Phrygian, Lydian, Mixo-Lydian, Ionic, and Æolian. The Ionic is the modern major, the Æolian the minor mode; the others are more or less intolerable to a modern ear. They are used to a limited extent in the music of the Greek Church, and in the Ambrosian Chant.

MODELLING is the process of preparing the original pattern or design from which a work in sculpture is to be cast or carved: the technical details will be found under **SCULPTURE**. Modelling is also practised by medallists; the head or figure intended to be cut in the die being first modelled in relief with wax on a piece of slate. Goldsmiths, silversmiths, and jewellers also model intricate and artistic forms and ornaments of pieces of plate, to be cast and chased by them, or in which jewels are to be set. Wax is the substance used when delicacy and minuteness are required. Modelling is also a branch of the potter's trade. Flaxman

modelled for Wedgwood numerous figures and groups in wax. For large models, the material employed is potter's clay, which, when used by sculptors, is mixed with a portion of sandstone, finely pulverised, to make it work freely.

MODENA (anc. *Mutina*), capital of the former duchy of same name, a fortified city of Northern Italy, 24 miles west-north-west of Bologna. Pop. 31,052. It stands between the rivers Secchia and Panaro, in a pleasant plain, noted for its rich soil and salubrious air, and from its surrounding ramparts commands fine views of the Apennines. Although the social life of M. is somewhat stagnant, it is nevertheless a most agreeable city. It lies on the famous Via *Æmilia* (see *EMILIAN PROVINCES*), by which it is divided into the old and new city, and is connected by a navigable canal with the rivers Secchia and Panaro. Amongst the public buildings, may be noted the cathedral of St Geminianus, the patron of the city, a structure of the purely Lombard style. The campanile or belfry is one of the great towers of Italy; it is a square turreted structure, 315 feet in height, its entire façade being in white marble. The ducal palace, a picturesque structure of the 17th c., is adorned with an infinity of galleries, courts, and marble arches; it contains the splendid *Biblioteca Estense*, numbering 100,000 volumes, and 3000 rare MSS.; also the valuable *Este* archives, a most important collection of mediæval records, collections of coins and medals of great antiquity, and an observatory. Schools of theology, law, medicine, and mathematics have replaced the university, suppressed in 1821; there are also fine museums of natural history, a botanic garden, theatres, and good public baths. The trade of M. is unimportant: the manufactured products are confined to linen and woollen fabrics, leather, hats, paper, glass, and pottery, besides silk manufactured to a much less extent than formerly. M. is the birthplace of the great anatomist Fallopius, and the antiquary Sigonio.

The ancient history of M. affords evidence that it enjoyed at an early period a considerable degree of prosperity; the splendour, wealth, and arts of the city of M. being mentioned by Cicero, Pliny, and Strabo. In modern times, M. has shared more or less the various vicissitudes which befell Italy, and participated in the great internecine feuds of the country. In 960, a member of the great House of Este was proclaimed Marquis of Modena, and in 1452 the then reigning marquis was created duke by the Emperor Frederick III. In 1796, M. formed part of the Cisalpine Republic, but was restored in 1814 by the congress of Vienna to the reigning family. The duchy had at that time an area of 2310 square miles, and a population of 586,000. In 1848, the Duke of Modena was temporarily deprived of his rights; and in 1860, the population definitively expelled their unpopular ruler, who carried off all the property and valuables within his reach, including the silver handles of the palace doors. M. has now become a province of the kingdom of Italy.

MODERATOR, a term used in Scotch ecclesiastical law to describe the chairman or president of a Presbyterian church-court.

MODICA, the Mohac of the Saracens, a city of the island of Sicily, in the province of Val di Noto, 30 miles from Syracuse. Pop. 22,000. The city, which stands perched amidst rocks, contains several fine buildings, and, notwithstanding the humidity of the climate, the sanitary condition of the inhabitants seems satisfactory. The soil of the surrounding district is the most productive of Sicily, and yields vast quantities of corn, tobacco, oil, wine,

hemp, which, with cheese, wool, soda, and butter, form the chief export trade of the place. The valley of Ipsica, or Ispica, in the vicinity of M., contains remarkable rocks, in which numerous dwellings are excavated.

MODILLION, an ornamental bracket (*a* in fig.), much used in classic architecture, especially in the cornices of the Corinthian and Composite styles.

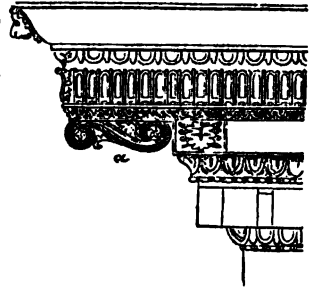

Modillion.

MODULATION, in Music. When in the course of a melody the key-note is changed, and the original scale altered by the introduction of a new sharp or flat, such change is called modulation. Much of the pleasure of music is derived from a judicious use of modulation. The art of good modulation from one key to another consists in the proper choice of intermediate chords. Sudden transitions, without intermediate chords, should be employed but sparingly, and in peculiar circumstances. Every piece of music is composed in a particular key, in which it begins and ends, which generally predominates over any other keys that may be introduced in the course of the composition.

MODULE, in Classic Architecture, an arbitrary measure for determining the proportions of the various members of the orders. The diameter, semi-diameter, or one-third of the diameter are most frequently used; the first being usually divided into 60 parts (or minutes), the second into 30 parts, and the third into 20 parts.

MODULUS, a constant coefficient or multiplier, by means of which one series or system of quantities can be reduced to another similar series or system. Thus we have the modulus of Elasticity (q. v.), of Friction (q. v.), and of systems of Logarithms (q. v.). The system of logarithms which is universally accepted as the primary is Napier's, and from it all other systems are deduced in the following manner: Let *N* be a number of which the Napierian logarithm is *b*, *e* being the Napierian base, it is required to find the logarithm of *N* to some other base *a*. Let *x* be this logarithm, then (see *LOGARITHMS*) $N = e^b = a^x$, and taking the Napierian logarithms of both sides of this equation, $b \log_e e = x \log_e a$, or (since $\log_e e = 1$) $b = x \log_e a$, therefore $x = \frac{b}{\log_e a}$; i.e., $\log_a N = \frac{\log_e N}{\log_e a} = \frac{1}{\log_e a} \times \log_e N$.

This multiplier, or 'modulus,' $\frac{1}{\log_e a}$, is independent of *N*, and is therefore constant for the reduction of all Napierian logarithms to the system whose base is *a*. If *a* = 10, the multiplier becomes $\frac{1}{\log_{10} 10}$, the modulus of Briggs's, or the common system of logarithms, and is equal to $\frac{1}{2.30258509} = .4342944 \dots$

MODUS, in English Law, means a peculiar custom by which lands become exempted from payment of tithes on paying some composition or equivalent.

MÖEN, a Danish island in the Baltic Sea, separated from Seeland on the north-west by the *Ulfesund*, and from Falster on the south-west by the *Grönsund*.

It is 19 miles long, by about 5 miles in average breadth. Area, 84 square miles. Pop. about 15,000, who are supported by agriculture, fisheries, and commerce. It has been called the Switzerland of Denmark, and is remarkable for the irregularity of its surface. The soil is fruitful. Its chief town and seaport, Stege, has a population of 1934.

MÆRIS LAKE, the ancient name of a sheet of water in Egypt, now known as *Birket-el-Kerân*, or *El-Korn* ('The Lake of the Promontory'), is situated in the province of Fayûm, about 60 miles south-west of Cairo; extreme length from north-east to south-west, 30 miles; breadth, 6 miles: it was formerly much larger. Its average depth is 12, and its greatest ascertained depth 28 feet. On the north and west, its shores are rocky, but on the south, flat and sandy. It is connected with the Nile by a canal called *Bahr-Jusuf* ('The River of Joseph'). The waters are brackish, on account of their being impregnated with the alkaline salts of the desert, and with the muriate-of-lime depositions of the surrounding hills. In the time of the Pharaohs, the revenue derived from the fisheries was applied to the maintenance of the queen's wardrobe and perfumes. Under the Persians, they were let (during the season of the inundations, when the canal fed the lake) at £150 a day. At present, however, they only yield about £84 a year.

MÆSIA, an ancient Roman province, bounded by the Danube on the N., the Black Sea on the E., the mountain-chains of *Hæmus* (Balkan) and *Orbelus* on the S., that of *Scardus* and the rivers *Drinus* (Drina) and *Savus* (Save) on the W. The river *Ciabrus* (Cibriz) divided it into two parts, of which the Eastern (*Mæsia Inferior*) is the present Bulgaria, and the Western (*Mæsia Superior*) is Servia. Its original inhabitants were mostly of Thracian race. Gaulish or Celtic invaders settled in Western Mæsia about 277 B.C., under the name of *Scordisci*. The Romans first came in contact with the tribes of M. after the conquest of Macedonia, when C. Scribonius Curio forced his way as far north as the Danube, and gained a victory over the Mæsians (75 B.C.), but the country was not completely subjugated till 29 B.C. It was made a Roman province in the reign of Augustus, and flourished for more than two centuries, but as a frontier province it was much exposed to hostile invasions, and required a line of fortresses and stations all along the south bank of the Danube. In 250 A.D., the Goths made an irruption into the country, and defeated and slew the Roman emperor, Decius. In the following year, and about the end of the 4th c., it was given up to them by the Emperor Theodosius I. Slavonian tribes settled in M. in the 6th and 7th centuries.

MÆSO-GOTHS, the name given to the Goths, who in the 3d c. settled in Lower Mæsia at the mouth of the Danube. *Ulfilas* (q. v.) was a Mæso-Goth. The name, however, became of more general use to designate those who remained in Mæsia after the great migration in the beginning of the 5th century.

MO'FAT, a market-town and favourite watering-place of Scotland, in the county of Dumfries, stands in the upper part of the broad and beautiful valley of the Annan, and is surrounded by hills of moderate elevation. It is two miles from the Beattock station, on the Caledonian Railway, and 19 miles north-north-east of Dumfries. Among other public edifices are the baths and the reading and assembly rooms. The mineral springs, the principal of which, like that of Harrogate, is saline and sulphurous, are highly celebrated; but perhaps the greatest attrac-

tions of the place are its salubrious air and exquisite environs. During the season, the town is increased in population by from 800 to 1000 visitors, to suit whose convenience great numbers of elegant villas, commanding fine views of the neighbouring country, have been erected. Pop. (1861) 1491.—The Moffat Hills extend between the counties of Lanark and Peebles in the north, and Dumfries in the south; highest summit Hartfell, 2650 feet. See *Black's Guide to Moffat* (Edin. 1860).

MOGADO'RE, or **SUERRA**, a fortified town, and the principal seaport of Morocco, 130 miles west-south-west of the city of that name, on the Atlantic Ocean. Pop. about 20,000. It is the port of the capital, and was founded in 1760, on the site of an old Portuguese fort. It stands on a rocky promontory, opposite an island of the same name, long a haunt of pirates, which forms the harbour, and is said to be the best built town of the kingdom. Its streets are regular, though narrow, and it consists of two parts, each surrounded by water. The quarter called the Fortress contains the custom-house, and the treasury, and is the residence of the pasha, the vice-consuls, and the Christian merchants. The town is defended by four batteries on the island, and by a fort on the land-side; the walls are also defensible. M. is the seat of considerable trade; it exports wool, gum, hides, feathers, gold-dust, and hardwares. In 1861, 92 vessels (of which 48 were British), of 22,181 tons, and cargoes valued at £208,263, entered, and 87 vessels (of which 46 were British), of 22,063 tons, and cargoes valued at £254,476, cleared the port.

MOGU'L, GREAT, the popular designation of the emperor of Delhi, as the impersonation of the powerful empire established in Hindustan by the Mongols (q. v.), who were called *Moguls* by the Persians. The first Great Mogul was Baber, the great-grandson of Timûr, who founded the Mongul empire in Hindustan in 1526. In 1803, the Great Mogul was deprived of his throne; in 1827, of even the appearance of authority, becoming a mere pensioner of the British; and in 1858, Mohammed Bahadûr, the last of the dynasty, was condemned, and transported for complicity in the Indian mutiny.

MOHA'CS, a market-town of Hungary, 110 miles south-south-west of Pesth, on the western arm of the Danube. It contains a gymnasium, has an important cattle-market, is a station for steam-boats on the Danube, and the seat of considerable trade in wine, coal, timber, and agricultural produce. Pop. 9400. It owes its historical importance to the great battle fought here, 29th August 1526, between Lewis II. of Hungary, with 25,000 Hungarians, and the Sultan Soliman, at the head of about 200,000 Turks. The battle resulted in the disastrous defeat of the Hungarians, who lost their king, 7 bishops, many nobles, and dignitaries, and upwards of 22,000 men. A second battle was fought here on the 12th August 1687, when the Turks in their turn were defeated, by an Austro-Hungarian army under Charles of Lorraine.

MO'HAIR, the wool of the Angora goat (see **GOAT** and **ANGORA**), a native of Asia Minor. Few animals have so beautiful a covering as the fine, soft, silky, long, and always pure white wool of this goat. Each animal, at the annual clip in April or May, yields from 2 lbs. to 4 lbs. of wool. It is only within the last twelve or fourteen years that this wool has been in great request in Britain, but its development as an article of trade has been simultaneous with that of Alpaca. See **WOOLLEN MANUFACTURES**.

MOHAMMED.

MOHAMMED (Arab. *the Praised* *), the name taken, at a later period, by the founder of Islam. He was originally called *Halabi*. He was born about the year 570 A. D., at Mecca, and was the son of Abdallah, of the family of the Hâshim; and of Amina, of the family of Zuhra, both of the powerful tribe of the Koreish, but of a side-branch only, and therefore of little or no influence. His father, a poor merchant, died either before or shortly after M.'s birth, whom his mother then (according to a doubtful tradition) is supposed to have handed over, after the fashion of her tribe, to a Beduin woman, that she might nurse him in the salubrious air of the desert. In consequence of the repeated fits of the child, however, which were ascribed to demons, the nurse sent him back in his third year. When six years old, he also lost his mother. His grandfather, Abd-Al-Mutallib, adopted the boy; and when, two years later, he too died, M.'s uncle, Abu Talib, though poor himself, took him into his house, and remained his best friend and protector throughout his whole life. The accounts which have survived of the time of his youth are of too legendary a nature to deserve credit; certain, however, it seems to be that he at first gained a scanty livelihood by tending the flocks of the Meccans, and that he once or twice accompanied his uncle on his journeys to Southern Arabia and Syria. In his 25th year, he entered the service of a rich widow, named Chaddja, likewise descended from the Koreish, and accompanied her caravans—in an inferior capacity, perhaps as a camel-driver—to the fairs. Up to that time, his circumstances were very poor. Suddenly his fortune changed. The wealthy, but much older, and twice widowed Chaddja offered him her hand, which he accepted. She bore him a son, Al-Kâsim—whence M. adopted the name Abu Al-Kâsim—and four daughters: Zainab, Rukaija, Umm Kulthûm, and Fâtima; and afterwards a second son, whom he called Abd Manâf, after an idol worshipped among his tribe. Both his sons, however, died early. M. continued his merchant's trade at Mecca, but without much energy, spending most of his time in solitary contemplations. In his 35th year, he is said to have, by chance only, been chosen arbiter in a quarrel about the replacing of the sacred black stone in the Kaaba (q. v.); but not before his 40th year is there anything really important to be told of his life.

Before, however, entering on the weighty events of the subsequent period, it is by no means unimportant to advert to such traits of M.'s outward appearance as are yet recoverable. He was of middle height, rather lean, but broad shouldered, and altogether of strong build; slightly curled black hair flowed round his strongly developed head; his eyes, overhung with thick eyelashes, were large and coal-black; his nose, large and slightly bent, was well formed. A long beard added to the dignity of his appearance. A black mole between his shoulders became afterwards among the faithful 'the seal of prophecy.' In his walk, he moved his whole body violently, 'as if descending a mountain.' His gait and presence were altogether of an extremely imposing nature. In his 40th year M. received his first 'revelation,' or, in other words, became first aware that he had a 'mission.' About the year 600 A. D., Christianity had penetrated into the heart of Arabia, through Syria on the one, and Abyssinia on the other hand. Judaism no less played a prominent part in the peninsula, chiefly in its northern parts, which were dotted over with Jewish colonies, founded by emigrants after the

destruction of Jerusalem; and round about Yathrib (Medina). Besides these two all-important religious elements, several sects, remnants of the numerous ancient sects which had sprung up everywhere during the first Christian centuries: Sabians, Mandæans, &c., on the frontiers of Syria and Babylonia, heightened the religious ferment which, shortly before the time of M., had begun to move the minds of the thoughtful. At that time there arose, according to undoubted historical accounts, several men in the Hedjaz (Waraka, Obeid Allah, Othman, Zayd, &c.), who preached the futility of the ancient pagan creed, with its star-worship, its pilgrimages, and festive ceremonies, its temples and fetiches. It had in reality long ceased to be a living faith, and only the great mass of the people clung to it as to a sacred inheritance from times immemorial. The unity of God, the 'ancient religion of Abraham,' was the doctrine promulgated by these forerunners of M., and many of those who, roused by their words, began to search for a form of religion which should embody both the traditions of their forefathers and a purer doctrine of the Divinity, turned either to Judaism or to Christianity. The principal scene of these missionary labours was Mecca, then the centre of the pilgrimages of most of the Arabian tribes, and where, from times immemorial, long anterior to the city itself, the Kaaba (q. v.), Mount Arafat, the Valley of Mina, &c., were held sacred—the Koreish, M.'s tribe, having the supreme care over these sanctuaries, ever since the 5th century. It was under these circumstances that M. felt 'moved' to teach a new faith, which should dispense with idolatry on the one, as with Judaism and Christianity on the other hand. He was 40 years of age, as we said, when he received the first 'divine' communication in the solitude of the mountain Hirâ, near Mecca. Gabriel appeared to him, and in the name of God commanded him to 'read'—that is, to preach the true religion, and to spread it abroad by committing it to writing (Sur. xvi.). How far M. was a 'prophet,' in the common sense of the word, has been the subject of endless and utterly futile discussions in the Christian world. That he was no vulgar impostor, is now as generally recognised as that other once popular doctrine, that he was in league with the devil, is rejected by thinking men. What part his epilepsy had in his 'visions,' we are not able to determine. Certain it is that, after long and painful solitary broodings, a something—not clearly known to himself—at times moved him with such fearfully rapturous vehemence, that, during his revelations, he is said to have roared like a camel, and to have streamed with perspiration; his eyes turned red, and the foam stood before his mouth. The voices he heard were sometimes those of a bell, sometimes of a man, sometimes they came in his dreams, or they were laid in his heart. Waraka, one of his wife's relatives, who had embraced Judaism, spoke to him of the Jewish doctrine, and told him the story of the patriarchs and Israel; not so much as it is told in the Bible, but in the Midrash; and the gorgeous hues of the legendary poetry of the latter seem to have made as deep an impression on M.'s poetical mind as the doctrine of the unity of God and the *morals*—in its broad outlines—of the Old Testament, together with those civil and religious laws, scriptural and oral, which are either contained as germs or fully developed in this record. Christianity exercised a minor influence upon him and his spiritual offspring. All his knowledge of the New Testament was confined to a few apocryphal books, and with all the deep reverence before Jesus, whom, together with Moses, he calls the greatest prophet, next to himself, his notions of the Christian religion and its founder were excessively

* Or, according to Deutsch, whose view is fully corroborated and adopted by Sprenger in his recent *Leben und Lehre Mohammads*, in allusion to Hag. ii. 7, the *predicted Messiah*.

vague. For some details on these points, however, we must refer to KORAN and MOHAMMEDANISM.

His first revelation he communicated to no one, it would appear, except to Chadidja, to his daughters, his stepson Ali, his favourite slave Zaid—whom he had probably freed and adopted by this time—and to his friend the prudent and honest Abu Bekr. His other relatives rejected his teachings with scorn. Abu Lahab, his uncle, called him a fool; and Abu Talib, his adoptive father, although he never ceased, for the honour of his family, to protect him, yet never professed any belief in M.'s words. In the fourth year of his mission, however, he had made forty proselytes, chiefly slaves and people from the lower ranks; and now first some verses were revealed to him, commanding him to come forward publicly as a preacher, and to defy the scorn of the unbelievers. With all his power, he now inveighed against the primeval superstition of the Meccans, and exhorted them to a pious and moral life, and to the belief in an all-mighty, all-wise, everlasting, indivisible, all-just, but merciful God, who had chosen him as he had chosen the prophets of the Bible before him, so to teach mankind that they should escape the punishments of hell, and inherit everlasting life. God's mercy—this was a primitive doctrine, common to the whole East—was principally to be obtained by prayer, fasting, and almsgiving. The belief in the sacredness of the Kaaba and the ceremonies of the pilgrimage was too firmly rooted in his and the people's minds not to be received into the new creed; but certain barbarous habits of the Beduins, such as the killing of their new-born daughters, were ruthlessly condemned by Mohammed. The prohibition of certain kinds of food also belongs to this first period, when he as yet entirely stood under the influence of Judaism; the prohibition of gambling, usury, &c., probably being of a somewhat later date. Whether he did or did not understand the art of writing and reading at the commencement of his career, is not quite clear; certain it is that he pretended not to know it, and employed the services of amanuenses for his Koranic dicta, which at first consisted merely of brief, rhymed sentences in the manner of the ancient Arabic soothsayers. [KORAN.] The Meccans did not object to his doings; they considered him a common 'poet' or 'soothsayer,' who, moreover, was not in his right senses, or simply a liar. Gradually, however, as the number of his converts increased, they began to pay more and more attention to his proceedings; and finally, fearing mostly for the sacredness of Mecca, which the new doctrine might abolish, thus depriving them of their chief glory and the ample revenues of the pilgrimages, they rose in fierce opposition against the new prophet and his adherents, who dared 'to call their ancient gods idols, and their ancestors fools.' Many of the converted slaves and freedmen had to undergo terrible punishments; and others suffered so much at the hands of their own relatives, that they were fain to revoke their creed; so that the prophet himself advised his followers to emigrate to Abyssinia. M. himself, although protected by the strong arm of Abu Talib, was yet at that time so low-spirited and fearful, that he even raised the idols, which hitherto he had represented as nought, to intermediate beings between God and man—a dictum, however, which he soon revoked, as an inspiration of Satan, thereby increasing the hatred of his adversaries, at whose head stood two members of the family of Machzum, no. Walid and Abulhakam Amr (called by Mohammed the Father of Foolishness), and who in every The mitl to throw ridicule on him. At last it that of necessary that he should be put beyond the highly celebraresecutors, and Abu Talib hid him in

a fortified castle of his own in the country. Hamza, his uncle, and Omar, formerly a bitter enemy of M., and who afterwards, with M. and Abu Bekr, became the third head of Islam, continued in the meantime to spread the new doctrine. The Koreish now demanded that M. should be delivered into their hands; but Abu Talib steadfastly refused to comply with their wishes; a feud thereupon broke out between their family and that of the Hashemites, and M. and all the members of his family, except, perhaps, Abu Lahab, were excommunicated. After the space of three years, however, the 'peace party' in Mecca brought about a reconciliation, and M. was allowed to return. A great grief befell him at this time—his faithful wife Chadidja died, and, shortly afterwards, his uncle Abu Talib, and, to add to his misery, the vicissitudes of his career had reduced him by this time to poverty. An emigration to Tائف, where he sought to improve his position, proved a failure; it was with great difficulty that he escaped with his bare life. During this epoch, he had the well-known dream of his journey to Jerusalem and in the heavens on the back of the Borak (Miraj), the relation of which caused even his staunchest adherents to smile at his hallucination. Shortly after his return from Tائف, he married Sauda, and afterwards so increased the number of his wives, that at his death he still left nine, of whom Ayishah, the daughter of Abu Bekr, and Hafsa, the daughter of Omar, are best known. In the midst of his vain endeavours to find a hearing in his own city, and those near it, he succeeded, during a pilgrimage, in converting several men from Medina, whose inhabitants had long been accustomed to hear from the mouths of the numerous Jews living in the city and its neighbourhood the words Revelation, Prophecy, God's Word, Messiah: to the Meccans mere sounds without any meaning. The seed sown into the minds of these men bore a fruitful harvest. The next pilgrimage brought twelve, and the third more than seventy adherents to the new faith from Medina, and with these he entered into a close alliance. M. now conceived the plan to seek refuge in the friendly city of Medina, and about 622 (ten, thirteen, or fifteen years—according to the different traditions—after his first assuming the sacred office) he fled thither, about one hundred families of his faithful flock having preceded him some time before, accompanied by Abu Bekr, and reached, not without danger, the town, called thence Medinat Annabi (City of the Prophet), or Medina 'City,' by way of eminence; and from this flight, or rather from the first month of the next Arabic year, dates the Mohammedan Era (Hedjrah). Now everything was changed to the advantage of the prophet and his religion; and if formerly the incidents of his life are shrouded in comparative obscurity, they are, from this date, known often to their most insignificant details. Formerly a despised 'madman or impostor,' he now assumed at once the position of highest judge, lawgiver, and ruler of the city and two most powerful Arabic tribes. His first care was directed towards the consolidation of the new worship, and the inner arrangements in the congregation of his flock; his next chief endeavour was to proselytise the numerous Jews who inhabited the city, to whom, besides having received their principal dogmas into his religion, he made many important concessions also in the outer observances of Islam, and concluded alliances with many of their tribes; but he was sorely disappointed in his hopes to convert them. They ridiculed his pretension to be the Messiah, and so enraged him by their constant taunts, that he soon abrogated his concessions, and became their bitterest adversary up to the hour of

MOHAMMED.

his death. The most important act in the first year of the Hedjrah was his permission to go to war with the enemies of Islam in the name of God—a kind of manifesto chiefly directed against the Meccans. Not being able at first to fight his enemies in open field, he endeavoured to weaken their power by attacking the caravans of the Koreish on their way to Syria. Being successful enough to disturb their trade, and, at the same time, to conclude alliances with the adjoining Beduin tribes, he at last dared to break even the peace of the sacred month of Radjab, and with this the signal to open warfare was given. A battle, the first, between 314 Moslems and about 600 Meccans was fought at Badr, in the second year of the Hedjrah; the former gained the victory, and made many prisoners. A great number of adventurers now flocked to M.'s colours, and he successfully continued his expeditions against the Koreish and the Jewish tribes, chiefly the Beni Keinuká, whose fortified castles he took after a long siege. Notwithstanding a severe loss which he suffered in the battle near Ohod, in which he himself was dangerously wounded, his power increased so rapidly that in the sixth year of the Hedjrah already he was able to proclaim a public pilgrimage to Mecca. Although the Meccans did not allow this to be carried out, he gained the still greater advantage that they concluded a formal peace with him, and thus recognised him as an equal power and belligerent. He was now allowed to send his missionaries all over Arabia, and even beyond the frontiers, without any hindrance; and in the following year he had the satisfaction of celebrating the pilgrimage for three days undisturbed at Mecca. Shortly afterwards, during his expeditions against the Jews of Chaibar and Fadak, M. very nearly lost his life: a Jewess, Zainab by name, a relative of whom had fallen in the fight against him, placed a poisoned piece of roast meat before him, and although he merely tasted it, he yet, up to his death, suffered from the effects of the poison. His missionaries at this time began to carry his doctrines abroad, to Chosroes II., to Heraclius, to the king of Abyssinia, the Viceroy of Egypt, and the chiefs of several Arabic provinces. Some received the new gospel; but Chosrú Parvis, the king of Persia, and Amru the Ghassanide, rejected his proposals with scorn, and the latter had the messenger executed. This was the cause of the first war between the Christians and the Muslims, in which the latter were beaten with great loss by Amru. The Meccans now thought the long-desired moment of revenge at hand, and broke the peace by committing several acts of violence against the Chuzaites, the allies of Mohammed. The latter, however, marched at the head of 10,000 men against Mecca, before its inhabitants had had time to prepare for the siege, took it, and was publicly recognised by them as chief and prophet. With this the victory of the new religion was secured in Arabia. While, however, employed in destroying all traces of idolatry in the besieged city, and fixing the minor laws and ceremonies of the true faith, M. heard of new armies which several warlike Arabic tribes marched against him, and which were concentrated near Talf (630). Again he was victorious, and his dominion and creed extended further and further every day. From all parts flocked the deputations to do homage to him in the name of the various tribes, either as the messenger of God, or at least as the Prince of Arabia, and the year 8 of the Hedjrah was therefore called the year of the Deputations. Once more he made most extensive preparations for a war against the Byzantines; but not being able to bring together a sufficient army, he had to be satisfied with the

homage of a few minor princes on his way to the frontiers, and to return without having carried out his intention. Towards the end of the 10th year of the Hedjrah he undertook, at the head of at least 40,000 Muslims, his last solemn pilgrimage to Mecca, and there (on the Mount Arafat) instructed them in all the important laws and ordinances, chiefly of the pilgrimage; and the ceremonies observed by him on that occasion were fixed for all times. [HAJJ.] He again solemnly exhorted his believers to righteousness and piety, and chiefly recommended them to protect the weak, the poor, and the women, and to abstain from usury.

Returned from Mecca, he occupied himself again with the carrying out of his expedition against Syria, but fell dangerously ill very soon after his return. One night, while suffering from an attack of fever, he went to the cemetery of Medina, and prayed and wept upon the tombs, praising the dead, and wishing that he himself might soon be delivered from the storms of this world. For a few more days he went about; at last, too weak further to visit his wives, he chose the house of Ayesshah, situated near a mosque, as his abode during his sickness. He continued to take part in the public prayers as long as he could; until at last, feeling that his hour had come, he once more preached to the people, recommending Abu Bekr and Usma, the son of Zaid, as the generals whom he had chosen for the army. He then asked, like Moses, whether he had wronged any one, and read to them passages from the Koran, preparing the minds of his hearers for his death, and exhorting them to peace among themselves, and to strict obedience to the tenets of the faith. A few days afterwards, he asked for writing materials, probably in order to fix a successor to his office as chief of the faithful; but Omar, fearing he might choose Ali, while he himself inclined to Abu Bekr, would not allow him to be furnished with them. In his last wanderings he only spoke of angels and heaven. He died in the lap of Ayesshah, about noon of Monday the 12th (11th) of the third month, in the year 11 of the Hedjrah (8th of June 632). His death caused an immense excitement and distress among the faithful, and Omar, who himself would not believe in it, tried to persuade the people of his still being alive. But Abu Bekr said to the assembled multitude: 'Whoever among you has served Mohammed, let him know that Mohammed is dead; but he who has served the God of Mohammed, let him continue in his service, for he is still alive, and never dies.' While his corpse was yet unburied, the quarrels about his successor, whom he had not definitively been able to appoint, commenced; and finally, Abu Bekr received the homage of the principal Muslims at Medina. M. was then buried in the night from the 9th to the 10th of June, after long discussions, in the house of Ayesshah, where he had died, and which afterwards became part of the adjoining mosque.

This, in briefest outline, is M.'s career. We have not been able to dwell, as we could have wished to do, with any length, either on the peculiar circumstances of his inner life, which preceded and accompanied his 'prophetic' course, nor on the part which Idolatry, Judaism, Christianity, and his own reflection respectively, bore in the formation of his religion; nor have we been able to trace the process by which his 'mission' grew upon him, as it were, and he, from a simple admonisher of his family, became the founder of a faith to which now above 130 millions are said to adhere. The articles KORAN and MOHAMMEDANISM contain some further details on his doctrine and its history. We have, in addition to the few observations on the points indicated at the beginning,

only to reiterate, that a man of Mohammed's extraordinary powers and gifts is not to be judged by a modern common-place standard; and that the manners and morals of his own time and country must also be taken into consideration. We are far from overrating his character. He was at times deceitful, cunning, even revengeful and cowardly; and generally addicted beyond limit to sensuality. But all this does not justify the savage and silly abuse which has been heaped upon his name for centuries by ignorance and fanaticism. Not only his public station as prophet, preacher, and prince, but also his private character, his amiability, his faithfulness towards friends, his tenderness towards his family, and the frequent readiness to forgive an enemy; besides the extreme simplicity of his domestic life (he lived, when already in full power, in a miserable hut, mended his own clothes, and freed all his slaves), must be taken into consideration; and, to do him full justice, his melancholic temperament, his nervousness, often bordering on frenzy, and which brought him to the brink of suicide, and his being a poet of the highest order, with all the weaknesses of a poet developed to excess, must not be forgotten. Altogether, his mind contained the strangest mixture of right and wrong, of truth and error. Although his self-chosen mission was the abolition of superstition, he yet believed in Jins, omens, charms, and dreams, and this is an additional reason against the, as we said, now generally abandoned notion, that he was a vulgar designer, who by no means deceived himself about those revelations which he pretended to have received. And however much the religion of Islam may, rightly or wrongly, be considered the bane and prime cause of the rottenness of eastern states and nations in our day, it must, in the first place, not be forgotten that it is not necessarily Islam which has caused the corruption, as indeed its ethics are for the most part of the highest order; and in the second place, that Mohammed is not to be made responsible for all the errors of his successors. Take him all in all, the history of humanity has seen few more earnest, noble, and sincere 'prophets'—using the word prophet in the broad human sense of one irresistibly impelled by an inner power to admonish, and to teach, and to utter austere and sublime truths, the full purport of which is often unknown to himself.

The most important European biographies of M. are those of Sprenger, Weil, Muir, Nöldeke, Reinaud. See also KORAN, MOHAMMEDANISM, SUNNA.

MOHAMMED, the name of four sultans of Turkey, of whom the most noted is **MOHAMMED II.**, surnamed *Bujuk* or **THE GREAT**, the conqueror of Constantinople. He was born at Adrianople in 1430, and succeeded his father, Amurath II., in 1450. His first acts were the murder of his two brothers, and the suppression of a rebellion in Karaman. Having thus secured himself on the throne, he bent all his energies to the accomplishment of the great project which had always been kept prominently in view by his predecessors—the capture of Constantinople. This city was now the sole remnant of the once mighty empire of the Cæsars; and after more than a year spent in preparations, M. commenced the siege, 6th April 1453, with an army of 258,000 men, and a fleet of 320 vessels. The Greeks, aided by a gallant band of 2000 strangers, under Gian Justiniani, a noble Genoese, long maintained an obstinate resistance. On the morning of the 29th May, a combined attack was made by land and sea without success; but the retirement from the ramparts of Justiniani, who had been severely wounded, and despaired of a successful defence, caused a panic among his followers, and the simultaneous charge of

a chosen body of janizaries, with M. himself at their head, was irresistible. Constantine XIII. died in the breach, and the Turks poured in over his corpse to plunder and devastate his capital. M. now transferred the seat of his government to Constantinople, and sought to win back the inhabitants by promising them the free exercise of their religion. He next reduced the kingdoms of Morea and Trebizond, offshoots of the Greek empire, obtained possession of Servia on the death of its last prince, and made formidable preparations for the invasion of Hungary. Belgrade was the first point of attack; and with 100,000 men, supported by a fleet of 200 ships on the Danube, M. sat down before its walls. The enormous ordnance which had done such good service at Constantinople, were employed to batter the ramparts; but the valour, skill, and activity of the defenders foiled his utmost efforts. John Hunyady (q. v.), who, with 5000 chosen troops, had reinforced the garrison, destroyed or captured all his vessels, and soon after, by a sudden sally, defeated his army, and carried off the battering-train, compelling him to raise the siege, 6th August 1456. His next enterprise was the invasion of Epirus, where Scanderbeg had hitherto successfully defied the sultan's power. Three Turkish armies were destroyed in rapid succession, and a fourth and fifth under M. himself met with no greater success; but the death of the gallant Epirote, in 1467, removed the only obstacle to the success of the sultan's plans, and Epirus was forthwith annexed to Turkey. The latter half of M.'s reign was also fruitful in important achievements, but our space will permit only a cursory notice of them. He reduced the Khan of the Crimea to the condition of a vassal, deprived the Genoese of Caffa, and the Venetians of Friuli, Istria, Negropont, and Lemnos; but the Knights of St John repelled him from Rhodes, and the Venetians from Scodra. He carried his arms into Italy, and took Otranto, but died in 1481 at Nicomedia, while on the way to join his son Bajazet, who was warring with the Persians and Egyptians. His frequent contests with the former of these nations had always interfered very much with the successful prosecution of his designs of conquest in Europe. M. was possessed of great abilities; he was brave, enterprising, and sagacious; nor was he deficient in learning, for he spoke four languages fluently, was well versed in geography, ancient history, and the natural sciences, and was practically acquainted with the fine arts. But the brilliancy of his career, and the occasional generosity and even magnanimity which he shewed, cannot obliterate the recollection of those acts of cruelty and treachery which have justly branded him as the most ruthless tyrant of the House of Osman. As the founder of the Turkish power in Europe, his memory has always been revered by the Turks.

MOHAMMEDANISM, the religion founded by Mohammed, or, according to him, the only orthodox creed existing from the beginning of the world, and preached by all the prophets ever since Adam. It is also called *Islâm*, Resignation, entire Submission to the will and precepts of God. In its exclusively dogmatical or theoretical part, it is *Imân*, Faith; in its practical, *Dîn*, Religion (by way of eminence). The fundamental principles of the former are contained in the two articles of belief: 'There is no God but God; and Mohammed is God's Apostle.' The Mohammedan doctrine of God's nature and attributes coincides with the Christian, in so far as he is by both taught to be the Creator of all things in heaven and earth, who rules and preserves all things, without beginning, omnipotent, omniscient, omnipresent, and full of mercy. Yet, according to

the Mohammedan belief, he has no offspring: 'He begetteth not, nor is he begotten.' Nor is Jesus called anything but a prophet and apostle, although his birth is said to have been due to a miraculous divine operation; and as the Koran superseded the Gospel, so Mohammed, Christ. The crucifixion is said to have been executed upon another person, Christ having been taken up unto God before the decree was carried out. He will come again upon the earth, to establish everywhere the Moslem religion, and to be a sign of the coming of the day of judgment. Next to the belief in God, that in angels forms a prominent dogma. Created of fire, and endowed with a kind of incorporeal body, they stand between God and man, adoring or waiting upon the former, or interceding for and guarding the latter. The four chief angels are 'The Holy Spirit,' or 'Angel of Revelations'—Gabriel; the special protector and guardian of the Jews—Michael; the 'Angel of Death'—Azraël (Raphael, in the apocryphal gospel of Barnabas), and Israfil—Uriel, whose office it will be to sound the trumpet at the Resurrection. It will hardly be necessary, after what we said under MOHAMMED, to point out, in every individual instance, how most of his 'religious' notions were taken almost bodily from the Jewish legends; his angelology, however, the Jews had borrowed themselves from the Persians, only altering the names, and, in a few cases, the offices of the chief angelic dignitaries. Besides angels, there are good and evil genii, the chief of the latter being Iblis (Despair), once called Azazel, who, refusing to pay homage to Adam, was rejected by God. These Jips are of a grosser fabric than angels, and subject to death. They, too, have different names and offices (Peri, Fairies; Div, Giants; Takvins, Fates, &c.), and are, in almost every respect, like the Shédim in the Talmud and Midrash. A further point of belief is that in certain God-given Scriptures, revealed successively to the different prophets. Four only of the original one hundred and four sacred books: viz, the Pentateuch, the Psalms, the Gospel, and the Koran, are said to have survived; the three former, however, in a mutilated and falsified condition. Besides these, a certain apocryphal gospel, attributed to St Barnabas, and the writings of Daniel, together with those of a few other prophets, are taken notice of by the Moslems, but not as canonical books. The number of prophets, sent at various times, is stated variously at between two and three hundred thousand, among whom 313 were apostles, and six were specially commissioned to proclaim new laws and dispensations, which abrogated the preceding ones. These were Adam, Noah, Abraham, Moses, Jesus, and Mohammed—the last the greatest of them all, and the propagator of the final dispensation. The belief in the resurrection and the final judgment is the next article of faith. The dead are received in their graves by an angel announcing the coming of the two examiners, Monker and Nakir, who put questions to the corpse respecting his belief in God and Mohammed, and who, in accordance with the answers, either torture or comfort him. This, again, is the Jewish 'Chibbut hakkeber,' the Beating of the Grave, a hyperbolical description of the sufferings during the intermediate state after death (purgatory). The soul, awaiting the general resurrection, enters according to its rank, either immediately into paradise (prophets), or partakes, in the shape of a green bird, of the delights of the abode of bliss (martyrs), or—in the case of common believers—is supposed either to stay near the grave, or to be with Adam in the lowest heaven, or to remain either in the wall of Zem-Zem, or in the trumpet of the resurrection. According to others, it rests in the shape of a white

bird under the throne of God. The souls of the infidels dwell in a certain well in the province of Hadramaut (Heb. Chambers of Death), or, being first offered to heaven, then offered to earth, and rejected by either, subject to unspeakable tortures until the day of resurrection. Concerning the latter, great discrepancy reigns among the Mohammedan theologians. Mohammed himself seems to have held that both soul and body will be raised, and the 'Bone Luz' of the Jewish Haggadah was by him transformed into the bone Al Ajb, the rump-bone, which will remain uncorrupted till the last day, and from which the whole body will spring anew, after a forty days' rain. Among the signs by which the approach of the last day may be known—nearly all taken from the legendary part of the Talmud and Midrash, where the signs of the coming of the Messiah are enumerated—are the decay of faith among men, the advancing of the meanest persons to highest dignities, wars, seditions, and tumults, and consequent dire distress, so that a man passing another's grave shall say: 'Would to God I were in his place!' Certain provinces shall revolt, and the buildings of Medina shall reach to Yahab. Again: the sun will rise in the west, the Beast will appear, Constantinople will be taken by the descendants of Isaac, the Anti-Christ will come, and be killed by Jesus at Lud. There will further take place a war with the Jews, Gog and Magog's (Jajug and Majuj's) eruption, a great smoke, an eclipse, the Mohammedans will return to idolatry, a great treasure will be found in the Euphrates, the Kaaba will be destroyed by the Ethiopians, beasts and inanimate things will speak, and finally, a wind will sweep away the souls of those who have faith, even if equal only to a grain of mustard seed, so that the world shall be left in ignorance. The time of the resurrection, even Mohammed could not learn from Gabriel: it is a mystery. Three blasts will announce it: that of consternation, of such terrible powers, that mothers shall neglect the babes on their breasts, and that heaven and earth will melt; that of examination, which will annihilate all things and beings, even the angel of death, save paradise and hell, and their inhabitants; and forty years later, that of resurrection, when all men, Mohammed first, shall have their souls breathed into their restored bodies, and will sleep in their sepulchres until the final doom has been passed upon them. The day of judgment, lasting from one to fifty thousand years, will call up angels, genii, men, and animals. The trial over, the righteous will enter paradise, to the right hand, and the wicked will pass to the left, into hell; both, however, have first to go over the bridge Al Sirat, laid over the midst of hell, and finer than a hair, and sharper than the edge of a sword, and beset with thorns on either side. The righteous will proceed on their path with ease and swiftness, but the wicked will fall down headlong to hell below—a place divided into seven stories or apartments, respectively assigned to Mohammedans, Jews, Christians, Sabians, Magians, idolaters, and—the lowest of all—to the hypocrites, who, outwardly professing a religion, in reality had none. The degrees of pain—chiefly consisting in intense heat and cold—vary; but the Mohammedans, and all those who professed the unity of God, will finally be released, while unbelievers and idolaters will be condemned to eternal punishment. Paradise is divided from hell by a partition (Orf), in which a certain number of half-saints will find place. The blessed, destined for the abodes of eternal delight (Jannat Aden, Heb. Gan Eden)—of which it is, however, not quite certain whether it is created already—will first drink of the Pond of

the Prophet, which is supplied from the rivers of paradise, whiter than milk, and more odoriferous than musk. Arrived at one of the eight gates, they will be met by beautiful youths and angels; and their degree of righteousness (prophets, religious teachers, martyrs, believers) will procure for them the corresponding degree of happiness. It may, however, not be superfluous to add, that, according to the Mohammedan doctrine, it is not a person's good works or merits which gain his admittance, but solely God's mercy; also that the poor will enter paradise five hundred years before the rich; and that the majority of the inhabitants of hell are women. As to the various felicities which await the pious (and of which there are about a hundred degrees), they are a wild conglomeration of Jewish, Christian, Magian, and other fancies on the subject, to which the Prophet's own exceedingly sensual imagination has added very considerably. Feasting in the most gorgeous and delicious variety, the most costly and brilliant garments, odours and music of the most ravishing nature, and above all, the enjoyment of the Hûr Âl Oÿûn, the black-eyed daughters of paradise, created of pure musk, and free from all the bodily weaknesses of the female sex, are held out as a reward to the commonest inhabitants of paradise, who will always remain in the full vigour of their youth and manhood.* For those deserving a higher degree of recompense, rewards will be prepared of a purely spiritual kind—i. e., the 'beholding of God's face' (Shechinah) by night and by day. A separate abode of happiness will also be reserved for women, but there is considerable doubt as to the manner of their enjoyment. That they are not of a prominently spiritual nature, is clear from the story of the Prophet and the old woman. The latter solicited Mohammed to intercede with God that she might be admitted into paradise, whereupon he replied that old women were not allowed in paradise, which dictum—causing her to weep—he further explained by saying that they would first be made young again. The last of the precepts of pure faith taught by Mohammedanism is the full and unconditional submission to God's decree [ISLAM], and the predestination of good and evil, which is found from the beginning inscribed on a 'preserved table.' Not only a man's fortunes, but his deeds, and consequently his future reward or punishment, are irrevocably, and thus unavoidably, pre-ordained (Fate): a doctrine which is not, however, taken literally by all Moslems, but which has no doubt contributed largely to the success of Islam, by inspiring its champions with the greatest indifference and contempt for the dangers of warfare; their destiny being immutably fixed under any circumstances.

Thus far, briefly, the Iman, dogmatical or theoretical part of Islam. The Din, or practical part,

* 'The whole earth will be as one loaf of bread, which God will reach to them like a cake; for meat they will have the ox Balâm and the fish Nûn, the lobes of whose livers will suffice seventy thousand men. Every believer will have eighty thousand servants and seventy-two girls of paradise, besides his own former wives, if he should wish for these, and a large tent of pearls, jacinths, and emeralds: three hundred dishes of gold shall be set before each guest at once, and the last morsel will be as grateful as the first. Wine will be permitted, and will flow copiously, without inebriating. The righteous will be clothed in the most precious silks and gold, and will be crowned with crowns of the most resplendent pearls and jewels. If they desire children, they shall beget them, and see them grow up within an hour. Besides the ravishing songs of the angel Israfil and the daughters of paradise, the very trees will, by the rustling of their boughs, the clanging of bells suspended from them, and the clashing of their fruits, which are pearls and emeralds, make sweetest music.'

which contains the ritual and moral laws, inculcates as the chief duties the following four: prayer, almsgiving, fasting, and pilgrimage.

Prayer, 'the key of paradise,' comprises also certain religious purifications, as the most necessary preparations to the former. They are of two kinds: the *Ghusl*, or total immersion of the body, required as a religious ceremony, on some special occasions; and the *Wudu*, a partial ablution, to be performed immediately before the prayer. This is of primary importance, and consists of the washing of hands, face, ears, and feet up to the ankles—a proceeding generally accompanied at each stage by corresponding pious sentences, and concluded by the recital of the 97th chapter of the Koran. In the case of water being beyond reach, dry dust or sand may supply its place. 'The practice of religion being founded on cleanliness, it is not sufficient that the believer himself should be purified, but even the ground or the carpet upon which he prays must be as clean as possible, and the use of a special prayer-carpet (Seggadéh) is therefore recommended. Every Mohammedan is obliged to pray five times in the space of every twenty-four hours. The prayer (Salah) itself consists partly of extracts from the Revealed Book, the Koran (Fard), partly of pieces ordained by the Prophet without allegation of a divine order (Sunnah). The first time of prayer commences at the Maghrib, or about sunset; the second, at the Eshâ, or nightfall; the third, at the Subh, or daybreak; the fourth, at the Duh, or about noon; the fifth, at the Asr, or afternoon. The believers are not to commence their prayers exactly at sunrise, or noon, or sunset, lest they might be confounded with the infidel Sun-worshippers. These several times of prayer are announced by the Mu'addins (q. v.) from the minarets or madnehs of the mosques. Their chant, sung to a very simple but solemn melody, sounds harmoniously and sonorously down the height of the mosque, through the mid-day din and roar of the cities, but its impression is one of the most strikingly poetical in the stillness of night; so much so, that even many Europeans cannot help congratulating the Prophet on his preferring the human voice to either the Jewish trumpet-call of the time of the Temple, or the Christian church-bells. The day-call (the Adan) consists chiefly of the confession of faith (God is most great—Mohammed is God's apostle—come to prayer, come to security) repeated several times; the night-calls (Ua, the first; Ebed, the second), destined for persons who desire to perform supererogatory acts of devotion, are much longer. The believer often changes his posture during his prayers; and a certain number of such inclinations of head and knees, prostrations, &c., is called a *Rekah*. It is also necessary that the face of the worshipper should be turned towards the Kibleh, in the direction of Mecca (q. v.), the exterior wall of the mosque marking that direction being distinguished by a niche (Mehrab). All sumptuous and pompous apparel is laid aside before the believer approaches the sacred place; and the extreme solemnity and decorum, the unaffected humility, the real and all-absorbing devotion which pervades it, have been unanimously held up as an example to other creeds. Women, although not strictly forbidden to enter the mosque, yet are not practically allowed to pray there, lest their presence might be hurtful to true devotion. Besides these prayers, there are others ordained for special occasions, as on a pilgrimage, before a battle, at funerals, during an eclipse, &c. That the Moslems do not pray to Mohammed, but simply implore his intercession, as they do that of the numerous saints, the relatives of the Prophet, and the first

propagators of Islam, need, after what we said under MOHAMMED, not be dwelt upon here. For the particulars of the service in the Mosque, the reader is referred to that heading. It may be remarked in passing, that Mohammedanism has no clergy in our sense of the word, the civil and religious law being bound up in one. See also MOLLAH, MUFTI.

Next in importance stands the duty of giving alms. These are twofold—legal (Zekah) and voluntary (Sadakah; Heb. Zedakah, piety, righteousness); but the former, once collected by the sovereign, and applied to pious uses, has now been practically abrogated. The Sadakah is, according to the law, to be given once every year, of cattle, money, corn, fruits, and wares sold, at about the rate of from two and a half up to twenty per cent. Besides these, it is usual to bestow a measure of provisions upon the poor, at the end of the sacred month of Ramadán.

The duty of fasting follows. [FASTS.] During the whole month of Ramadán, the Moslem is commanded to refrain from eating, drinking, smoking, smelling perfumes, bathing, and every unnecessary indulgence in worldly pleasure, from daybreak until sunset. From that period till the morning, he is allowed to eat, drink, and enjoy himself. The Arabian years being lunar, it often happens that the Ramadán falls in midsummer, when the fasting, more especially the abstaining from drinking, is excessively mortifying. None are exempt from this duty save the sick, travellers, and soldiers in time of war; but they are bound to fast an equal number of days during some other months. Nurses and pregnant women are entirely free from fasting. It is Mohammed's special and express desire, that no one should fast who is not quite equal to it, lest he might injure his health, and disqualify himself for necessary labour. Of the other commendable fast-days, the Ashura, on the 10th of Moharram (the Jewish Jom Kippur), deserves special mention. There are very few Moslems who do not keep the Ramadán, even if they neglect their other religious duties; at all events, they all pretend to keep it most strictly, fasting being considered 'one-fourth part of the faith,' nay, 'the gate of religion.'

Of the fourth paramount duty of the Mohammedan—viz., the pilgrimage to Mecca—we have spoken both under that heading, and, more fully, in the article HAJJ. Suffice it here briefly to recapitulate, that the Kaaba (q. v.) is to be encompassed seven times, the celebrated black stone being kissed at each round, that Mount Arafat is to be visited, the sacrifice El-Fida (the Ransom, in memory of Ismael's sacrifice) to be performed, and a number of minor ceremonies to be gone through by the pilgrim, and that he who neglects to perform the sacred pilgrimage, 'might as well die a Jew or a Christian.'

To the 'positive' ordinances of Islam may also be reckoned the 'Saghir,' or minor, and 'Kebir,' or great festivals. [FESTIVALS.] The first (Al-Fetr, or breaking the fast), following immediately upon the Ramadán, begins on the first day of the month of Shawál, and lasts three days. The second (Eed Al-Kurban, or sacrifice) begins on the 10th of Dau'l Heggeh, when the pilgrims perform their sacrifice, and lasts three or four days. Yet, although intended to be the most important of the two, the people have in most places changed the order, and, by way of compensation for the previous fast, they make the lesser festival which follows the Ramadán the most joyful and the longest of the two. The day set aside for the weekly day of rest is the Friday—not, as is generally supposed, because both the Jewish Sabbath and the Christian Sunday were to be avoided, but because, from times long before

Mohammed, the people used to hold public assemblies for civil as well as religious purposes on that day. The celebration of the Moslem days of religious solemnity is far less strict than is the custom with the other Shemitic religions. Service being over, the people are allowed to return to their worldly affairs, if they cannot afford to give themselves up entirely to pleasure or devotion for the rest of the sacred period.

Thus far, briefly, the principal positive laws of Islam relating to faith and practice. We shall now touch upon the fundamental prohibitory laws contained in the Koran.

First of all, the drinking of wine, which includes all strong and inebriating liquors, as giving rise to 'more evil than good,' is rigorously forbidden; and although of late, chiefly through European influence, very many Moslems have lost their religious scruples on that score, and not only secretly, but openly indulge in spirits, yet the great bulk of the faithful refuse even to make use of the proceeds of the sale of wine or grapes. Some over-scrupulous believers even include opium, coffee, and tobacco in the prohibition; but general practice has decided differently. The prohibitory laws respecting food resemble closely those of Judaism: blood, the flesh of swine, further, animals which have died from disease or age, or on which the name of some idol has been invoked, or which have been sacrificed unto an idol, or which have been strangled, or killed by a blow, a fall, or by some other beast, are strictly forbidden. 'Pure' animals must be slaughtered according to certain fixed rules, and the name of God is to be invoked before the operation, without, however, the usual addition of the benevolent epithets, since these would ill befit the sufferings of a fellow-creature. Fish, birds, game are mostly allowed for food, yet there are in nearly all cases certain religious ceremonies to be observed, before they become fit for the believer's table.

All games subject to chance ('casting lots by arrows')—such as dice, cards, tables, bets, &c.—are considered so wicked, that a gambler's testimony is invalid in a court of law. (The Talmud only rejects the testimony of the habitual 'dice- [Kubia, i. e., Cube] gambler and better upon doves.') Chess and other games depending on skill—provided they do not interfere with the regular performance of religious duties, and that they are played without any stakes whatsoever—are allowed by the majority of Moslem theologians. Usury is strictly prohibited. Taking interest upon any loan, however large or small, or profiting in trade through any questionable means, save by buying and selling, is severely condemned.

To prevent the faithful from ever falling back into idolatry, the laws relating to images and pictures have been made very stringent. Whosoever makes an imitation of any living being in stone, wood, or any other material, shall, on the day of judgment, be asked to endow his creation with life and soul, and, on his protesting his inability of doing so, shall undergo the punishment of hell for a certain period.

The civil and criminal laws of Mohammedanism, founded both on the Koran and the Traditions (*Sunnah*), are, in some instances, where the letter of the written or oral precept allows of various explanations, or where the case in question is not foreseen, interpreted according to the opinion of one of the four great masters of Islam: Abu Hanifa, Malec Ibn Ans, Sháfel, Ibn Hanbal, within the pale of their respective sects. The principal points, however, upon which all Mohammedans agree are the following: Polygamy is allowed, not, as is commonly supposed, without any restriction, but: 'Take in marriage of the women who please you, two,

three, or four; but if ye fear that ye cannot act equitably, one; or those whom your right hands have acquired'—i. e., your slaves. These are the explicit words of the Koran (iv. 3), so that four wives, and a certain number of concubine slaves, is the whole extent to which a Moslem may legally go. The Prophet's example proves nothing to the contrary, since he was endowed with special privileges, and not subject to the common law in many respects. It is, moreover, added, as an advice, that to marry one or two is quite sufficient for a man, if he apprehend any inconvenience from a larger number of wives. A Moslem may, if urged by excessive love, or if unable to obtain a wife of his own creed, marry a Christian woman or a Jewess, but a Mohammedan woman is not, under any circumstances, to marry an unbeliever. In all cases, however, the child born of a Moslem, whatever the mother's faith, is a Moslem; nor does the wife, who is an unbeliever, inherit at her husband's death. Forbidden degrees are: the mother, daughter, sister, half-sister, aunt, niece, foster-mother, or a woman related to the faithful 'by milk in any of the degrees which would preclude his marriage with her, if she were similarly related to him by consanguinity;' the mother of his wife, even if he be not properly married to the latter yet; the daughter of his wife, if the latter still be his legal wife; his father's wife and his son's wife; or two sisters at the same time; or wives who stand to each other in the relation of aunt and niece; or the unemancipated slave, or another man's slave, if he have already a free wife. A simple declaration of a man and woman at the age of puberty, before two witnesses, of their intention to marry each other, and the payment of part of the dowry (which is indispensable, and must amount to at least ten dirhems, or about five shillings), is sufficient for a legal marriage. A girl under age is given away by her natural or appointed guardian, with or without her consent. To see the face of any woman who is neither his wife nor his concubine, nor belongs to any of the forbidden degrees, is strictly forbidden to the believer. Divorce is a comparatively light matter with the Mohammedans. Twice, a man may send away his wife and take her back again without any ceremony; the third time, however—if he unite the triple divorce in one sentence at once—he dare not receive her again in wedlock until she have been married properly to another man in the meantime. Mere dislike is sufficient reason for a man to dissolve the conjugal ties, and his saying: 'Thou art divorced,' or 'I divorce thee,' together with the payment of part of the wife's dowry, is all that is required from him by the law. A wife, on the other hand, is bound to her husband for ever, unless she can prove some flagrant ill-usage or neglect of conjugal duty on his part; and even then, she forfeits part, or the whole, of her dowry. A divorced woman is obliged to wait, like a widow, for a certain period before marrying again: if pregnant, until delivery; three months, or four months and ten days, according to circumstances. If she have a young child, she is to suckle it until it be two years old, and the father is to bear all the expenses of the maintenance of mother and child. A woman proving disobedient to her husband, may be declared by the kadi 'nashizah,' i. e., rebellious, and the husband is no longer bound to maintain her. Yet, he cannot be forced to divorce her under these circumstances, so that the woman is generally in so sore a plight that she is obliged to promise good-behaviour for the future, and the husband has then either to take her back to his house, or to set her free by a formal divorce. On the other hand, it often happens that a woman prefers a mere separa-

tion, to continuing to live with her husband; in which case she gets herself, of her own accord, inscribed a 'nashizah.' If a slave becomes a mother by her master, and he acknowledges the child to be his own, the latter is free, and the mother is to be emancipated at the master's death, and may not be given away, or otherwise disposed of by him, during his lifetime. A free person, wishing to marry his or her slave, must first emancipate this slave; and if the slave of another person has been married by a free man or woman, and afterwards becomes the latter's property, the marriage becomes illegal, and can only be renewed by a legal contract and emancipation.

The privilege of primogeniture does not exist in the Mohammedan law, but males generally receive a double share. A person may not bequeath more than one-third of his property, unless there be no legal heirs. Children, whether begotten with the legal wife, or slave, or concubine, or only adopted, and their descendants, are the first heirs; next come the claims of wives, parents, brothers, sisters, in their order. Where there is no legal heir, the property falls to the crown.

The law is very lenient towards debtors, the Koran recommending the creditor to remit a debt 'as alms.' Insolvency and inability to work for the discharge of the claim, solve all further obligations. The most conscientious performance of all private contracts, however, is constantly recommended in the Koran.

Murder is either punished with death, or by the payment of a fine to the family of the deceased, according to their own pleasure. There must, however, be palliating circumstances in the latter case. The Bedawis, however, have expanded the law of blood-revenge in a terrible manner, and up to this day the 'vendetta' often rages not only between family and family, but between whole tribes, villages, and provinces. Unintentional homicide is expiated by freeing a believer from slavery, and paying to the family a certain sum in proportion to the rank and sex of the deceased. He who has not the means of freeing a believer, is to fast for two months, by way of penance. According to the strict letter of the law, a man is not liable to capital punishment for killing his own child or an infidel; but, practically, no difference is generally made by the Mohammedan governments (chiefly the Turkish) in our day. Murder is punished with death, and no fine frees the culprit.

The Mosaic law of retaliation, in case of *intentional* wounds and mutilation, holds good also for Islam; that is (not, as has ignorantly been supposed, that the corresponding limb of the offender is to be cut off), a certain proportionate fine in money is to be paid to the injured. The payment for any of the single limbs of the human body—e. g., the nose—is the full price of blood, as for a homicide; for a limb which is found twice, like hand or foot, half; for a finger or toe, the tenth part, &c. Women and slaves have smaller claims. Injuries of a dangerous, or otherwise grievous nature, pay the full price; those of an inferior kind, however, bring the perpetrator within the province of the lash or cudgel, which is supposed to have 'come down from heaven, to be used by the judge for the promotion of virtue and duty.'

The Koran orders theft—of no less than the value of half-a-crown—to be punished by cutting off the chief offending limb: the right hand; the second theft is punishable by the loss of the left foot; the third, of the left hand; the fourth, of the right foot, &c.; but the ordinary punishments of imprisonment, hard labour, and the bastinado, have been substituted in our days. The property stolen must not, however, have been of easy access to the thief, nor

must it have consisted of food, since he may have taken this to satisfy the craving of his hunger.

Unchastity on the part of a woman was, in the commencement of Islam, punished by imprisonment for life, for which afterwards, however, stoning was substituted in the case of a married woman; and a hundred stripes and a year's exile in the case of an unmarried free woman; a slave to undergo only half of that punishment. Yet, it is necessary that he who accuses a 'woman of reputation' of adultery or fornication, shall produce four (male) witnesses, and if he be not able to do so, he is to receive fourscore stripes, nor is his testimony ever after to be received, for he is considered an 'infamous prevaricator'—unless he swear four times that he speaks the truth, and the fifth time imprecate God's vengeance if he speak false. Yet, even this testimony may be overthrown by the wife's swearing four times that he is a liar, and imprecating the fifth time the wrath of God upon herself, if he speak the truth. In the latter case, she is free from punishment; the marriage, however, is to be dissolved. Fornication in either sex is, by the law of the Koran, to be visited with a hundred stripes.

Infidelity, or apostasy from Islam, is a crime to be visited by the death of the offender, if he have been warned thrice without recanting. Severer still, that is, not to be averted by repentance or revocation of any kind, is the punishment inflicted for blasphemy—against God, Mohammed, Christ, Moses, or any other prophet. Instantaneous death is the doom of the offender; for if apostasy may be caused by error and misguidance, 'blasphemy is the sign of complete wickedness and thorough corruption of the soul.'

A further injunction of the Koran, for the carrying out of which, however, the time has well-nigh gone by, is that of making war against the Infidels. He who is slain while fighting in defence and for the propagation of Islam, is reckoned a martyr; while a deserter from the holy war is held up as an object of execration, and has forfeited his life in this world as well as in the world to come. At first, all the enemies taken in battle were ruthlessly slain; later, however, it became the law to give the people of a different faith against whom war was declared the choice of three things: either to embrace Islam—in which case they became Moslems at once, free in their persons and fortunes, and entitled to all the privileges of Moslems; or to submit to pay tribute—in which case they were allowed to continue in their religion, if it did not imply gross idolatry or otherwise offended against the moral law; or to decide the quarrel by the fortune of war—in which case the captive women and children were made slaves, and the men either slain, unless they became converts at the last moment, or otherwise disposed of by the prince. The fifth part of the spoil belongs 'to God,' that is, the Sanctuary (Kaaba, &c.), to the apostle and his kindred, to the orphans, the poor, and the traveller.

We need hardly urge, that the Koran is not a systematically arranged code, and that all the laws and regulations hitherto enumerated, although contained in it, either bodily or, as it were, in germs—further developed by the Sunna (q. v.)—are to a great extent only mentioned in an incidental manner, thrown together and mixed up, often in the strangest manner, with the most heterogeneous dicta, dogmas, moral exhortations, civil and criminal laws, &c., and are principally to be considered as supplementary to the existing laws and regulations which they either abrogated, confirmed, or extended, according to the pressing demand of circumstances during the Prophet's life. In cases for which subsequent ages found no written rules laid down by

the Prophet, traditional oral dicta were taken as the norm, and later still, precedents of the Khalifs were binding. Hence contradictions in theory and practice have crept in, according to the different traditions and decisions of the Imams or expounders of the Law, besides the various interpretations put upon the book itself within the pale of the different Mohammedan sects. The secular tribunals, therefore, not unfrequently differ in their decisions from the judicial tribunals; and the distinction between the written civil Law of the ecclesiastical courts and the common Law, aided by the executive power, is, fortunately for the cause of human culture, and the spread of civilisation, getting clearer and clearer every day.

That part of Islam, however, which has undergone (because not to be circumscribed and defined by doctors) the least changes in the course of time, and which most distinctly reveals the mind of its author, is also its most complete and its most shining part—we mean the ethics of the Koran. They are not found, any more than the other laws, brought together in one, or two, or three Surabs, but 'like golden threads' they are woven into the huge fabric of the religious constitution of Mohammed. Injustice, falsehood, pride, revengefulness, calumny, mockery, avarice, prodigality, debauchery, mistrust, and suspicion are inveighed against as ungodly and wicked; while benevolence, liberality, modesty, forbearance, patience and endurance, frugality, sincerity, straightforwardness, decency, love of peace and truth, and above all, trusting in God, and submitting to His will, are considered as the pillars of true piety, and the principal signs of a true believer. Nor must we omit to point out expressly that Mohammed never laid down that doctrine of absolute predestination and 'fatality' which destroys all human will and freedom, since the individual's deeds cannot alter one iota in his destiny either in this world or in the next. So far from it, foolhardiness is distinctly prohibited in the Koran (ii. 196). Caution is recommended. Prayer, the highest ceremonial law of Islam, is modified in case of danger. It is legal to earn one's livelihood on Friday after prayer, and to shorten the readings in the Koran for the sake of attending to business. All of which is enough to shew that the Moslem is not to expect to be fed pursuant to a Divine decree whether he be idle or not. On the other hand, a glance at the whole system of faith, built on hope and fear, rewards and punishments, paradise and hell, both to be man's portion according to his acts in this life, and the incessant exhortations to virtue, and denunciations of vice, are sufficient to prove that aboriginal predestination, such as St Augustine taught it, is not in the Koran, where only submission to the Lord's will, hope during misfortune, modesty in prosperity, and entire confidence in the Divine plans, are supported by the argument, that everything is in the hands of the Highest Being, and that there is no appeal against His absolute decrees.

And this is one instance of the way in which most of Mohammed's dicta have been developed and explained—both by sectarians and enemies within and without Islam—in such a manner that he has often been made to teach the very reverse of what he really did teach; and thus monstrosities now found in his creed, if carefully traced back to their original sources, will, in most cases, be seen to be the growth of later generations, or the very things he abrogated. That, again, the worst side of his character, the often wanton cruelty with which he pursued his great mission, the propagation of his faith, should by his successors have been taken as a thing to be principally imitated, is not to be wondered at, considering how brilliant the results of the policy

of the bloody sword had proved. Scarcely a century had elapsed after Mohammed's death, and Islam reigned supreme over Arabia, Syria, Persia, Egypt, the whole of the northern coast of Africa, even as far as Spain; and notwithstanding the subsequent strifes and divisions in the interior of this gigantic realm, it grew and grew outwardly, until the Crescent was made to gleam from the spires of St Sophia at Constantinople, and the war-cry 'Allah il Allah!' resounded before the gates of Vienna. From that time, however, the splendour and the power of Mohammedanism began to wane. Although there are counted about 130 millions this day all over the globe who profess Islam, and although it is, especially at this present juncture, making great progress among the African races, yet the number of real and thorough believers is infinitely small; and since it has left off conquering, it has lost also that energy and elasticity which promises great things. Its future fate will depend chiefly, we should say, on the progress of European conquest in the East, and the amount of Western civilisation which it will, for good or evil, import into those parts.

We cannot consider in this place what Islam has done for the cause of all humanity, or, more exactly, what was its precise share in the development of science and art in Europe. We refer to the special articles which treat of these subjects, and particularly to the biographies found in the course of this work of men eminent in every branch of human knowledge who have issued from the ranks of Islam. Broadly speaking, the Mohammedans may be said to have been the enlightened teachers of barbarous Europe from the 9th to the 13th century. It is from the glorious days of the Abbaside rulers that the real renaissance of Greek spirit and Greek culture is to be dated. Classical literature, would have been irredeemably lost, had it not been for the home it found in the schools of the 'unbelievers' of the 'dark ages.' Arabic philosophy, medicine, natural history, geography, history, grammar, rhetoric, and the 'golden art of poetry,' schooled by the old Hellenic masters, brought forth an abundant harvest of works, many of which will live and teach as long as there will be generations to be taught.

Besides the Koran, the Sunnah, and the native (Arabic, Persian, Turkish, &c.) writers on the foregoing subject, we mention as further references the works of the European scholars Maracci, Hyde, Prideaux, Chardin, Du Ryer, Reland, D'Herbelot, Sale, De Sacy, Hammer, Burckhardt, Sprenger, Burton, Muir, Garcin de Tassy, Lane, Weil, Geiger, Nöldeke, &c. See also KORAN, MOHAMMED, SHITES, SHAFITES, SUNNAH, &c.

MO'HAWK, a river of New York, United States, named from a tribe of Indians. It rises in Oneida county, 20 miles north of Rome, and runs east-south-east into the Hudson at Waterford, 10 miles above Albany. It is 135 miles long, and has numerous and picturesque waterfalls, especially at Little Falls, Cohoes, and Waterford, affording abundant water-power. In its populous valley are the Erie Canal and New York Central Railway.

MOHICANS, MOHEGANS, or MAHICANNI, once a powerful and warlike sub-tribe of North American Indians, of the great Algonquin family, which, in the 17th c., inhabited the territory north-west of Long Island Sound, and east of the river Hudson, now included in the states of New York, Connecticut, and Massachusetts. Being compelled to give way to the conquering Iroquois confederacy, they retired to the valley of the Housatonic River in Connecticut, and were consequently one of the first tribes who came into colli-

sion with, and were dispossessed of their territory by the early British settlers. They subsequently lived dispersed among the other tribes, and all traces of them have now nearly disappeared. Their name has become widely known through Mr J. Fenimore Cooper's celebrated novel, *The Last of the Mohicans*.

MOHILEV, or MOGILEV, a government of European Russia, lying between Minsk and Smolensk, contains 18,189 English square miles, with a population of 884,640. The inhabitants are mostly Rusniaks, though there are also many Russians, Germans, Jews, and even Bohemians. The country is generally a plain, with here and there an occasional undulation; the soil is very fertile, and the climate most agreeably mild. Agriculture has here reached a high degree of perfection, and the same may be said of arboriculture and horticulture. The natural pasturage is of fine quality, and affords abundant nourishment to immense herds of cattle. The forests are extensive. The country is watered by the Dnieper and its numerous affluents, which form the means of communication with the Black Sea ports, and of the transit of corn, timber, and masts, of which last large quantities are annually floated down to Kherson. Bog iron-ore is found in abundance. The inhabitants are celebrated for their activity and industry; and M., from its great natural advantages, has now become one of the richest provinces of Russia.

In early times, M. belonged to the territory of the Russian prince of Smolensk, but was subsequently conquered by the Grand Duke of Lithuania, and was, along with Lithuania, united to the kingdom of Poland. In 1772, it was seized by Russia at the first partition of Poland; and in 1796, was joined to the government of Vitebak, under the name of *White Russia*; but since 1802, it has formed a separate government.

MOHILEV, or MOGILEV, the capital of the government of the same name in European Russia, and one of the finest towns of Russia, is situated in the centre of the government, on the right bank of the Dnieper, 100 miles south-west of Smolensk. It is the seat of a Greek archbishop, and of the Roman Catholic primate of Russia and Poland, besides being the favourite residence of many of the Russian nobility. It possesses a fine Greek cathedral, built in 1780, 20 Greek, one Lutheran, and 4 Roman Catholic churches, several synagogues, and a variety of religious, educational, and charitable institutions. Its streets are wide, straight, and well paved, and there is a fine promenade bordered with trees, whence a beautiful view of the valley of the Dnieper is obtained. Pop. 19,119, of whom one-third are Jews. There is a large export trade to the chief ports of the Baltic and Black Seas.

MOHILEV, or MOGILOW, a district town on the south-west frontier of the government of Podolia, European Russia, is situated on the left bank of the Dniester, 50 miles east-by-south from Kaminetz. Pop. 8930. It carries on an active trade with the adjacent Russian provinces, and with the Turkish principalities of Moldavia and Wallachia. The climate is so mild, that silk and other products of warm climates are extensively produced.

MÖHLER, JOHANN ADAM, one of the most distinguished modern polemical divines of the Roman Catholic Church, was born of humble parentage, at Igersheim, in Würtemberg, May 6, 1796. He received his early education at the gymnasium of Mergentheim, whence, in his 17th year, he was transferred, for the higher studies, to the Lyceum

of Ellwangen; and soon afterwards entered upon the theological course in the university of Tübingen. He received priests' orders in 1819; and for a short time was employed in missionary duty; but in 1820, he returned to college-life, for two years was engaged as classical tutor; but, in 1822, the offer of a theological appointment in the university of Tübingen, finally decided his choice to the study of divinity. He was permitted, before entering on his studies, to spend some time in making himself acquainted with the routine of the theological courses of other universities—as Göttingen, Berlin, Prague, Vienna, and Landshut; and in 1823, he entered upon his new position. In 1828, in which year he was also admitted to the degree of Doctor of Divinity, he was appointed ordinary professor of theology. His earliest publication was a treatise *On the Unity of the Church* (1825), which was followed, in 1827, by a historico-theological essay on *Athanasius and the Church of his Time, in Conflict with Arianism*. But his reputation, both posthumous and among his own contemporaries, rests mainly on his well-known *Symbolism; or the Doctrinal Differences between Catholics and Protestants, as represented by their Public Confessions of Faith* (1832). This remarkable book at once fixed the attention of the theological world. It passed through five large editions in six years. It was translated into all the leading languages of Europe, and drew forth numerous criticisms and rejoinders, the most considerable of which is that of Dr F. C. Baur (q. v.), 1833. To this M. replied in 1834, by a work entitled, *Further Researches into the Doctrinal Differences of Catholics and Protestants*. The polemical bitterness evoked by these controversies made it desirable that M. should leave the university of Tübingen. He was invited to Breslau, and also to Bonn, but ultimately selected (1835) the university of Munich, then in the first flush of its efficiency, under King Louis. His first appointment was nominally the chair of Biblical Exegesis, but he really devoted himself to the department of Church History, in which his opening course was eminently successful; but, unhappily, a naturally delicate constitution began to give way under the constant fatigues of a student's life; and although he continued, under all these disadvantages, to maintain and to add to his reputation, and although, in 1837, the invitation to the Bonn professorship was renewed in still more flattering terms, he gradually sunk under consumption, and died April 12, 1838. His miscellaneous works were collected and published posthumously, in 2 vols. 8vo (1839—1840), by his friend, the now celebrated Dr Döllinger. M. may be regarded as at once the most acute and the most philosophical of the modern controversialists of his church. He deals more, however, with the exposition of the points and the grounds of the doctrinal differences of modern sects, than with the discussion of the scriptural or traditional evidences of the peculiar doctrines of any among them.

MO'IDORE, a former gold coin of Portugal, of the value of 4800 reis, or nearly 27s. sterling. It was also called *Lisbonine*.

MOIRE, the French name (formerly *mohère*, and supposed to be taken from the Eng. *mohair*, which is itself probably of Eastern origin) applied to silks figured by the peculiar process called watering. The silks for this purpose must be broad and of a good substantial make; thin and narrow pieces will not do: they are wetted, and then folded with particular care, to insure the threads of the fabric lying all in the same direction, and not crossing

each other, except as in the usual way of the web and the warp. The folded pieces of silk are then submitted to an enormous pressure, generally in a hydraulic machine. By this pressure, the air is slowly expelled, and in escaping, draws the moisture into curious waved lines, which leave the permanent marking called watering. The finest kinds of watered silks are known as *Moirés antiques*.—The same process has been applied to woollen fabrics called *Moreen*, which is only an alteration of the word *moire*.

MOIRÉE MÉTALLIQUE, a French term applied to tin-plate upon which a peculiar figuring like that caused by frost on windows is produced by dipping plates, in a heated state, into nitromuriatic acid, and then washing with water, to remove the acid. When dry, the plates are varnished or lacquered, and have a pretty effect. The cheapness and ease of the process have made it very common for inferior articles in tin.

MOISSAC, a town of France, in the department of Tarn-et-Garonne, on the river Tarn, 15 miles north-west of Montauban. The church of St Pierre dates from the year 1100, and contains some excellent carvings and curious fantastic sculptures. M. is the centre of an important trade in grain. Pop. 5815.

MOLA, a city and seaport of the Neapolitan province of Bari, delightfully situated among gardens and olive groves, on the Adriatic, 13 miles from Bari. It contains fine churches and other edifices, and excellent streets. From all accounts, it seems to have exceedingly little trade of any kind. Pop. 11,078.

MOLA'SSES. See SUGAR.

MOLD (anciently *Monte Alto*; Welsh, *Wyddgrug*), a parliamentary borough in the county of Flint, situated on the Alun, 12 miles west-south-west of Chester. Though Flint is the county town, the assizes and quarter-sessions for the county are held here. The town possesses a good market, a fine old church, and several dissenting chapels. It is connected with England by a branch of the Chester and Holyhead Railway. The neighbourhood abounds with mineral wealth, coal and lead being the principal produce; it has also numerous interesting relics of antiquity—e. g., so-called Druidic circles, Roman roads and encampments, Saxon earthworks, an eminence called *Bryn Beili* (formerly surmounted by a castle), and a castellated building known as the Tower of Rheinalt ab Gruffydd, the two latter having been scenes of frequent contentions between the English and Welsh. Many old families have mansions in the neighbourhood, whose pleasing variety of scenery renders it attractive. Pop. of parliamentary borough (1861), 3735.

MOLDAU (Bohemian, *Vitava*), the chief river of Bohemia, and an important tributary of the Elbe, rises in the Böhmerwald Mountains, on the south-west frontier, at an elevation of 3750 above the level of the sea, and flows south-east to Hohenfurth, where it bends northward, and pursues that direction to its confluence with the Elbe opposite Melnik, after a course of 276 miles. Its course to the point of confluence is longer than that of the Elbe, and the navigation of that river is greatly facilitated by the body of water which it contributes. It receives on the left, the Wotawa and the Beraun; and on the right, the Luschnitz and the Szawa. The chief towns on its banks are Krumau, Budweis, and Prague. It becomes navigable from Budweis.

MOLDAVIA AND WALACHIA, two states forming the so-called *Danubian Principalities*, which, since 23d December 1861, have been united under one

MOLDAVIA AND WALACHIA.

prince and one administration, and officially bear the single name of RUMANIA. Their political relations have always been so close, that it has been considered best to describe them together.

1. **MOLDAVIA** (Ger. *Moldau*, Turk. *Bogdan* or *Kera-Isak*) is bounded on the N. and E. by Russia, on the S. by Walachia and the Danube, and on the W. by the Austrian empire. Greatest length, from north-west to south-east, 280 miles; greatest breadth, 128; area, 20,118 square miles. The country forms, geographically, part of the great undulating pastoral plains or steppes of South Russia, except towards the west, where spurs from the Carpathians give it a somewhat mountainous character. It is watered by the Pruth, the Sereth, and the Danube, and is almost everywhere fertile, but war and oppression have hindered it from being properly cultivated. Nevertheless, it produces considerable quantities of grain, fruit, and wine. The forests of M. are also of great extent and importance. But the riches of the country consist mainly in its cattle and horses, of which immense numbers are reared on its splendid and far-stretching pastures; swine and sheep are also numerous; and the rearing of bees, owing to the multitude of lime-trees, is extensively carried on. The great plagues of the land are locusts and earthquakes. Minerals and precious metals are said to be abundant, but they have not as yet been worked. There are only a few salt-pits near Okna, in the Carpathian Mountains. Trade is almost exclusively in the hands of the numerous Jews, Armenians, Greeks, and Russians who have settled in the country. The capital of M. is Jassy (q. v.); but the great centre of trade is Galacz (q. v.), where, of late, several British merchants have established houses. The principal exports are wool, lambs' skins, hides, feathers, maize, tar, tallow, honey, leeches, cattle, and salt (in blocks); the imports are chiefly the manufactured products of Western Europe. M. is divided, for administrative purposes, into 13 circles, and contains 36 towns, 2016 villages, and a population of 1,600,000.

2. **WALACHIA**, the larger of the united Danubian Principalities, is bounded on the N. by the Austrian empire and Moldavia, on the E. and S. by the Danube, and on the W. by the Austrian empire and the Danube. Length from the western frontier to Cape Kaliakra on the Black Sea, 305 miles; greatest breadth, 130 miles; area, 27,930 square miles. The greater part of W. is quite flat; but in the north, where it borders on Hungary and Transylvania, it gradually rises up into a great mountain-wall, impassable save in five places. It is destitute of wood throughout almost its whole extent; and especially along the banks of the Danube, is covered with marshy swamps, miles upon miles in breadth. The principal river flowing through the country is the Aluta, which joins the Danube at Nikopol. The climate is extreme; the summer heats are intense; while in winter, the land lies under deep snow for four months. The soil of W. is among the richest in Europe, and would leave nothing to be desired, were it not for the ravages of locusts and the calamitous summer droughts. The principal products are corn, maize, millet, wine, flax, tobacco, and olive-oil. The vast treeless heaths afford sustenance to great herds of cattle, sheep, and horse. As in Moldavia, agriculture is an important branch of industry; and the swampy districts of the south are haunted by immense numbers of wild water-fowl. In minerals—especially gold, silver, copper, and rock-salt—the soil is rich, but only the last of these is extensively worked. The imports and exports are much the same as in Moldavia. W. is divided, for administrative purposes, into 17 circles,

and contains 36 towns, 3325 villages, and a population of 2,400,920. Capital, Bucharest.

Administration.—The ruler of the Principalities—officially called by the Sublime Porte, *Woiwood* (Prince); by the Turks generally, *Ijaier-Meffendi* (Lord of the Unbelievers); and by the Russians, *Hospodar* (Prince)—receives his investiture from the sultan, but is otherwise independent. By the treaty of Paris (30th March 1856) and the Convention (19th August 1859), M. and W. were politically united under one prince, with a special ministry for each country, two elective assemblies, and a central commission, which had its seat at Fokshani. But in November 1861, the sultan sanctioned the administrative union of the two states, during at least the lifetime of the present prince, Alexander John Couza; and in the following month, it was publicly proclaimed at Bucharest and Jassy. The central commission at Fokshani was abolished during the permanence of the union; and the two assemblies were amalgamated, and met for the first time at Bucharest, 24th January 1862. The government is constitutional. The ministry comprises a Minister of the Interior, of Finance, of Justice, of Worship and Instruction, of Public Works, of Control, and of War. Every circle has a court of First Instance, with two judges and a president; every village, a justice-of-peace court. Most of the villages, and many of the larger towns, belong to the *Bojars* (territorial nobles), and a large number are also in the hands of the clergy. The state-lands are farmed out. The bojar or landed proprietor is in general the only person competent to act as legislator or as a judge; but such towns as are not the property of the bojars (of which there are 6 in M., and 13 in W.), are governed by municipalities of their own election.

Religion.—The established religion of 'Rumania' is that of the Greek Church, but all forms of Christianity are tolerated, and their professors enjoy equal political rights. At the head of the Greek clergy, stand the metropolitan archbishops of M. and W., who are chosen by the general assembly of the different estates, confirmed in their office by the prince, and alternately preside in the Rumanian parliament. Every bishop is assisted by a council of clergy, and has a seminary for priests; the superintendent of the preaching clergy is the *Proto-papa* of the diocese. In M. there are 1795 churches, 3268 priests, 491 deacons; also 7622 married secular clergy, and 60 monasteries, of which the richest is that of Niamtz, with 1300 monks. In W., there are 4171 churches (of which 2587 are wooden), 36,638 persons belonging to the families of married priests, 10,749 deacons, 9500 monks and nuns, and 202 monasteries and nunneries. The property belonging to the priesthood of the Principalities is immense, and at present (1864) efforts are being made by the government of Prince Couza to have it secularised. The patron saint of W. is St Demetrius; and of M., St George.

Education is not in a very advanced condition. In W., there are 2358 district schools, with 52,140 pupils; 145 private schools, with 3429 pupils; and 18 normal schools, with 2358 pupils; besides these elementary schools, there is a gymnasium or high school in Bucharest, and another at Krajova. In the former city, there is also a college for philosophy, natural science, jurisprudence, and arboriculture. In M., education is (or at least was some years ago) in a much worse state; in 1844, there were only 14 elementary public schools, with 1244 pupils, in the whole land; besides a gymnasium at Jassy, where there are also numerous French boarding-schools. French is now the language of the highly educated circles, especially of the ladies (as Greek used to

be), but the state language and the proper national tongue is the Romanic.

Army.—The army of the united Principalities in 1860 amounted to 14,900 regulars, of whom 11,200 were infantry; besides which there were five battalions of frontier guards (7397 men), and 5600 mounted police; in all, 27,897.

Commerce.—The total value of the imports and exports of Walachia, in 1856, was estimated at 260,000,000 piastres (about £2,166,000); and of Moldavia, in 1858, at 245,000,000 piastres (about £2,041,000). In 1861, 2859 vessels, with a burden of 473,914 tons, entered the Sulina mouth of the Danube, and 2383, with a burden of 480,944 tons, cleared it.

Race, Language, and Literature.—The great majority of the inhabitants are known in Western Europe as Walachs, but they call themselves Romëni. The Walachs, however, are not confined to the Principalities, but inhabit also the southern part of Bukowina, the greater part of Transylvania, Eastern Hungary, a part of the Banat, Bessarabia, some districts in Podolia and Kherson, and portions of Eastern Servia. They are also found in Macedonia, Albania, and Thessaly. They are a mixed race, produced by the amalgamation of the Emperor Trajan's Roman colonists with the original Dacian population, and subsequently modified by Grecian, Gothic, Slavic, and Turkish elements. This mixture is seen in their language, three-fourths of the words of which are Latin (the Dacian has disappeared), while the remaining fourth is made up of words from the other four languages. Walachian literature is rich in popular songs; since the 16th c., many works in prose and verse have been printed, and of late years, two political journals in the Walachian tongue have been established, one at Bucharest, and another at Jassy. A *Grammatica Daco-Romana* was published by Johann. Alexi (Vienna, 1826), and a *Historia Lingue Daco-Romane* by Laurianus (Vienna, 1849). A large Latin-Romanic-Hungarian Dictionary was carefully executed by the Bishop of Fogarasch, Joh. Bob (3 vols. Klausenburg, 1839).

Social Condition.—Very recent statistics on this point are not attainable. In M., there are rather less, in W., considerably more than 3000 bojars, besides whom there is an extensive inferior nobility. In W., every twenty-eighth man is a nobleman; every one hundred and thirty-third, a merchant; and in the capital, every twentieth is a merchant. Very few of the nobles, but almost all the 7670 clergy, live on their lands. The free peasants, or yeomen, called *Resschs*, are not numerous—in all W., there are only 4634. Gipsy communities are an important element in the population; upwards of 150,000 of this mysterious race are serfs belonging to the rich bojars and the monasteries. In 1844, about 30,000 were emancipated, and settled in colonies in different parts of the land; they are ruled by a *Bataf*, or king of their own choice, of which every gipsy village has one: they call themselves *Romnitschel* or *Romni*. The great mass of the peasantry have no property or political rights; they are burdened with a heavy taxation, and consequently steeped in the deepest poverty. In fact, the bojars alone—the 'upper six thousand'—constitute the nation in a political sense. Nevertheless, the common people are on the whole good-humoured, frugal, sober, and cleanly; murder and larceny are almost unknown. Their dwellings, however, are, as may be supposed, of the most wretched description; composed chiefly of interlaced willow-witches, covered with mud, cane, and straw; but often, even in the large towns, especially in W., they are only of mud; a cloak serves for a bed, and the whole house-furniture is

comprised in a few kitchen-utensils. On the other hand, the palaces of the bojars contain all the comforts and luxuries of Western Europe. The streets in the towns are generally without pavements, and crooked; sometimes they are veritable mud-streams (and worse), in which the equipages of bojars and others fairly stick.

History.—In ancient times, M. and W. formed an important part of Dacia (q. v.), and the two countries have in general experienced the same vicissitudes. At the period of the migration of nations, and in the following centuries, they were the scene of the struggles between the Gothic, Hunnic, Bulgarian, and Slavic races—the Avari, Chazars, Petschenegi, Uzi, and Magyars, who alternately ruled or were expelled from the country. These peoples all left some traces (more or less) of themselves among the Romanised Dacian inhabitants, and thus helped to form that composite people, the modern Walachs, who, in the 11th c., were converted to the Christianity of the Eastern or Greek Church. Their incursions, however, frightfully devastated the country. In the 11th c., the Kumans, a Turkish race, established in M. a kingdom of their own. Two centuries later, the great storm of Mongols broke over the land. It now fell into the hands of the Nogai Tartars, who left it utterly wasted, so that only in the forests and mountains was any trace left of the native Walachian population. In the latter half of the 13th c., a petty Walach chief of Transylvania, Radu Negru of Fogarasch, entered W., took possession of a portion of the country, divided it among his bojars (noble followers), founded a senate of 12 members, and an elective monarchy; and gradually conquered the whole of Walachia. Rather less than a century later (1354), a similar attempt, also successful, was made by a Walach chief of the Hungarian Marmarosh, of the name of Bogdan, to re-people Moldavia. In the beginning of the 16th c., both Principalities placed themselves under the protection of the Porte, and gradually the bojars lost the right of electing their own ruler, whose office was bought in Constantinople. After 1711, the Turks governed the countries by Fanariot princes (see FANARIOTS), who in reality only farmed the revenues, enriched themselves, and impoverished the land. In 1802, the Russians wrested from Turkey the right of surveillance over the Principalities. A great number of the nobles—through family marriages with the Fanariots—were now of Greek descent, the court-tongue was Greek, and the religious and political sympathies of the country were the same. Hence the effort of the Principalities in 1821 to emancipate themselves from Turkish authority, which was only the prelude to the greater and more successful struggle in Greece itself. In 1822, Russia forced Turkey to choose the princes or hospodars of W. and M. from natives, and not from the corrupt Greeks of Constantinople; and after 1829, to allow them to hold their dignity for life. The Principalities were united, as has been already mentioned, under one ruler in 1858, and under one administration in 1861. Their annual tribute to the Porte amounts to 4,000,000 piastres (about £16,670), of which Moldavia pays 1,500,000, and Walachia 2,500,000.

MOLÉ, LOUIS MATTHIEU, COMTE, a French statesman, and a descendant of the famous French statesman and magistrate, Matthieu Molé (b. 1584; d. 1653), was born at Paris, 24th January 1781. His father, President of the Parliament of Paris, died by the guillotine in 1794. His mother was a daughter of Malaherbes. M. was for the most part his own preceptor, and displayed a wonderfully precocious love of hard work and independent reflection.

In 1805, he published *Essais de Morale et de Politique*, in which he vindicated the government of Napoleon on the ground of necessity. The attention of the Emperor was drawn to him; he was appointed to various offices in succession, and raised to the dignity of a count, and to a place in the cabinet. After Napoleon's return from Elba, he refused to subscribe the declaration of the Council of State banishing the Bourbons for ever from France, and declined to take his seat in the Chamber of Peers. In 1815, Louis XVIII. made him a peer, and he voted for the death of Ney. In 1817, he was for a short time Minister of Marine, but afterwards acted independently of party, and was one of the principal orators in the Chamber of Peers. In 1830, he became Minister of Foreign Affairs in Louis Philippe's first cabinet, but only for a short time. In 1836, he succeeded Thiers as prime minister; but in the eyes of the liberal party, he displayed too entire a devotedness to the wishes of the king, and thus rendered his ministry very unpopular, so that in 1839 he felt it necessary to resign. In 1840, he was chosen a member of the *Académie Française*. From that time he took little part in political affairs, but after the revolution of 1848 exerted himself, but in vain, to rally and unite the party of order in the assembly to which he had been elected. He died at Champlâtreux, 23d November 1855. M. was fiercely attacked and abused in the latter part of his political career, but it is not now believed that he was servile towards the court. He detested anarchy, and believed in the necessity of a strong government; but he loved genuine liberty, and always placed the constitution above the king. When Louis Napoleon's *coup d'état* extinguished the republic, M. proudly said, that henceforth he could have nothing to do with politics.

MOLE (*Talpa*), a genus of quadrupeds of the order *Insectivora*, and family *Talpida*. All the *Talpida* live chiefly underground, and their structure is adapted to their mode of life. In their general form, the character of their fur, the shortness of their limbs, the great muscular strength of the fore-parts, and great breadth of the fore-paws, the elongated head, the elongated and flexible snout, the smallness of the eyes, and the complete concealment of the ears, they all resemble the Common M. (*T. Europæa*), with which also they pretty nearly agree in the nature of their food, their mode of seeking it, their dentition, and the shortness of their alimentary canal.—The Common M. is abundant in most parts of Europe, except the utmost north and utmost south. In Britain, it is very plentiful, except in the north of Scotland; but is not found in Ireland nor in some of the Scottish islands. Instead of its ordinary uniform black colour, it is occasionally found yellowish white, or gray, and even orange. Its silky or velvety fur lies smoothly in every direction, the short hairs growing perpendicularly from the skin; a peculiarity which preserves it clean as the animal moves either backwards or forwards in its subterranean galleries. The fore-paws are not only very broad, but are turned outwards, for the better throwing back of the earth in burrowing. They are terminated by five long and strong claws. The phalangeal bones are remarkable for breadth, and an elongated bone of the carpus gives additional strength to the lower edge of the paw. The two bones of the forearm are fastened together. The shoulder-blades and the clavicles are very large; and the sternum has an elevated ridge as in birds and bats, for the attachment of powerful muscles. The muscles which move the head are also very powerful, and the cervical ligament is even strengthened by a peculiar bone; the M. making

much use of its flexible snout in burrowing. The hinder limbs are comparatively feeble, and the feet small, with five toes. The eyes are black and very small, capable of being partially retracted and exerted. The senses of hearing, taste, and smell are very strongly developed in the mole. The cutting-teeth are very small and sharp; the canines long and sharp; the true molars broad, with many sharp conical elevations. This dentition adapts the animal for feeding not only on worms and grubs, but also on frogs, birds, and small quadrupeds, which accordingly are its occasional prey, although earthworms are its chief food. The M. is an excessively voracious animal; digestion is rapid, and no long interval can be endured between meals, hunger soon ending in death. When pressed by hunger, it will attack and devour even one of its own kind; and its practice is immediately to tear open the belly of any bird or quadruped which it has killed, and, inserting its head, to satiate itself with the blood. In eating earthworms, it skins them with remarkable dexterity. In quest of them, it works its way underground, throwing up the earth in mole-hills; more rarely in the fine nights of summer it seeks for them on the surface of the ground, when it is itself apt to be picked up by an owl equally in want of food. The habitation of the M. is of very remarkable construction: a hillock of earth larger than an ordinary mole-hill, and containing two circular galleries, one above the other, with five connecting passages, and a central chamber which has access to the upper gallery by three passages; whilst about nine passages lead away from the lower gallery in different directions. The end of a passage entering a gallery

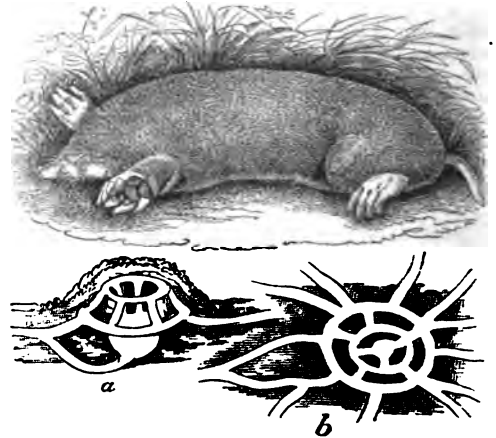

Mole (*Talpa Europæa*):

a, vertical section of the habitation of the mole; b, plan of ditto.

on one side is never opposite to the end of a passage entering on the other. To afford all facility of escape in case of any alarm, a passage leads at first downwards from the central chamber, and then upwards again till it joins one of the high roads which the M. keeps always open, which are formed by pressing the earth till it becomes smooth and compact, and are not marked by any mole-hills thrown up, and which not only serve for escape when necessary, but lead to those parts of the creature's appropriated domain where the ordinary mining for worms is to be prosecuted. The nest in which the female M. produces her young is not this habitation, but is formed generally under a mole-hill rather larger than usual, where two or three runs meet, and is lined with leaves and other warm materials. The M. breeds both in spring and

autumn, and generally produces four or five young at a birth. The attachment of the parent moles seems to be strong, but transitory.

It has been sometimes alleged that moles eat vegetable as well as animal food, and that they are injurious to farmers, by devouring carrots and other roots; but it appears rather that they only gnaw roots when in the way of their mining operations, or perhaps, also, in quest of grubs which they contain. Moles are generally regarded as a pest by farmers and gardeners, owing to the injury which mole-hills do to lawns and pastures, the burying up of young plants, and the disturbance of their roots. But they are certainly of use in the economy of nature in preventing the excessive increase of some other creatures; and probably also contribute to the fertility of some pastures, by the continual tillage which they carry on. Mole-traps of various kinds are in use, which are planted, if the mole-catcher is skilful, in the often-traversed roads of the animals. Mole-catching has long been a distinct trade in Britain.

The name *M.* is abbreviated from the old English name *Mouldwarp*, or *Mouldswarp*, still provincially used, and which is derived from the Anglo-Saxon *molde*, mould, and *weorpan*, to throw up.

Another species of *M.* (*T. cæca*) is found in the most southern parts of Europe; very similar to the Common *M.*, but rather smaller, and having the eye always covered by the eyelid, so as to justify Aristotle's statement, that the *M.* is blind.—A species, also very similar to the Common *M.*, is found in North America.

Among the other *Talpidae* are the CHANGEABLE *M.*, or CAPE *M.* (*Chrysochloris Capensis*) of South Africa, which is remarkable as the only one of the mammalia that exhibits the splendid metallic reflections so frequently seen in some other classes of animals; the SHREW *M.* (q. v.) and the STAR-NOSE (q. v.) of North America.

MOLE. See NÆVUS.

MOLE-CRICKET (*Gryllotalpa*), a genus of insects of the Cricket (q. v.) family (*Achetidae* or *Gryllidae*), remarkable for burrowing habits, and for the great strength and breadth of the fore-legs. The other legs are also large and strong, but of the



Mole-Cricket, and Eggs (*Gryllotalpa vulgaris*).

form usual in the family.—The best known species (*G. vulgaris*)—common in many parts of Europe, and pretty abundant in some places in England, but very local—is almost two inches long; of a velvety brown colour; the wings, when folded, do not cover much more than one-half of the abdomen, although large when expanded. It uses its fore-legs not only for digging burrows in earth, but for cutting through or tearing off the roots of plants which come in its

way. The *M.* feeds both on animal and vegetable substances, and often does no small injury to crops. The chirping, and somewhat musical call of the *M.*, produced in the same way as that of the common cricket, is heard chiefly in the end of spring and beginning of summer, and only in the evening or at night. In some parts of England, this sound has gained it the name of *Chur-worm*. Another local English name is *Croaker*.—The female *M.* prepares a curious nest, a rounded subterranean cell, about as large as a hen's egg, having a complicated system of winding passages around it, and communicating with it. In this cell, she deposits from 100 to 400 eggs. The young live for some time in society. They run actively, both in the larva and pupa states. The *M.* is very combative, and the victor generally eats the vanquished.—A species of *M.* (*G. didactyla*) does great injury to the plantations of sugar-canes in the West Indies.—A curious Indian insect, of a closely allied genus (*Schizodactylus monstroeus*), has prodigiously long wings, which, as well as the wing-covers, are rolled into spiral coils at the tips.

MOLE-RAT (*Spalax* or *Aspalax*), a genus of rodent quadrupeds of the family *Muridae*, having teeth almost like those of rats, but in many respects resembling moles, as in general form, shortness of limbs, concealment of ears, smallness or even rudimentary condition of eyes, and burrowing habits—although their food is altogether different, consisting wholly of vegetable substances, and chiefly of roots. One species (*S. typhlus*) inhabits the south of Russia and some parts of Asia. It is also known as the *Podolian Marmot*, *Blind Rat*, *Slepez*, *Zemni*, &c. The *M.* makes tunnels and throws up hillocks like the mole, but its hillocks are much larger.—Another species, found in the Malayan Archipelago, is as large as a rabbit.—Nearly allied is the COAST RAT or SAND MOLE of South Africa (*Bathyergus maritimus*), also as large as a rabbit, with other species of the same genus, also natives of South Africa, which drive tunnels through the sandy soil, and throw up large hillocks.

MOLESTATION, in Scotch Law, means disturbing the possession of heritage, and an action of molestation is a remedy for the trespass.

MOLESWORTH, SIR WILLIAM, RIGHT HONOURABLE (eighth baronet), English statesman, was born in 1810. Lineally descended from an old Cornish family of large possessions (the first baronet was president of the Council in Jamaica in the time of Charles II., and subsequently governor of that island), he early shewed promise of distinction. His university career at Cambridge was, however, cut short by his sending (under circumstances of great provocation) a challenge to his tutor to fight a duel. He continued his education at the university of Edinburgh, and subsequently at a German university. After making the usual tour of Europe, he returned home, and threw himself, in 1831, into the movement for parliamentary reform. Next year, although only just of age, he was elected member of parliament for Cornwall (East). He sat for Leeds from 1837 to 1841, and then remained out of parliament four years, during which interval he used to say he gave himself a second and sounder political education. He was the intimate friend of Bentham and James Mill, and was regarded as the parliamentary representative of the 'philosophical Radicals.' Having been a great admirer of Hobbes, he accumulated materials for a life of the 'Philosopher of Malmesbury,' which remains in MS. uncompleted. In 1839, he commenced and carried to completion, at a cost of many thousand pounds, a reprint of the entire miscellaneous and voluminous writings of that eminent author. The publication was a valuable

contribution to the republic of letters, and the works of Hobbes were placed by M.'s munificence in most of our university and provincial public libraries. The publication, however, did him great disservice in public life, his opponents endeavouring to identify him with the freethinking opinions of Hobbes in religion, as well as with the great philosopher's conclusions in favour of despotic government. In 1845, he was elected for Southwark (which he continued to represent until his death), and entered upon a parliamentary career of the greatest energy and usefulness. He was the first to call attention to the abuses connected with the transportation of criminals, and as chairman of a parliamentary committee brought to light all the horrors of the convict system. He pointed out the maladministration of the colonial office, explained the true principles of colonial self-government, prepared draught constitutions for remote dependencies, and investigated the true and natural relations between the imperial government and its colonial empire. M.'s views, although at first unpalatable to the legislature, have been adopted by successive administrations, and are now part and parcel of the colonial policy of Great Britain. In January 1853, he accepted the office of First Commissioner of Public Works, in the administration of the Earl of Aberdeen; and in 1855, the post of Secretary of State for the Colonies, in that of Viscount Palmerston. This appointment gave great satisfaction to our dependencies; but before he could give proof of his administrative capacity, he was (October 22, 1856) struck by the hand of death, while yet in the full vigour of life and intellect. He established the *London Review*, a new quarterly, in 1835; and afterwards purchased the *Westminster Review*, the organ of the 'philosophical Radicals.' The two quarterlies being then merged into one, under the title of the *London and Westminster*, M. contributed to it many able articles on politics and political economy.

MOLFETTA, a city of the Neapolitan province of Terra di Bari, situated on the Adriatic, 18 miles north-west of Bari; pop. 21,000. The neighbourhood yields excellent fruits, especially almonds and oranges, and has extensive olive plantations. Fish abound along the coast. The city contains a magnificent cathedral, and is partly enclosed by walls; it is conjectured that it occupies the site of some early forgotten town, from the numerous vases, urns, and other relics of antiquity found in its vicinity.

MOLIÈRE, JEAN BAPTISTE (properly, *Jean Baptiste Poquelin*—the name of Molière not having been assumed till he had commenced authorship), was born at Paris, 15th January 1622. His father, Jean Poquelin, was then an upholsterer, but subsequently became a valet-de-chambre to the king. Regarding the boyhood of M., almost nothing is known, but his credulous biographers have put together whatever traditional gossip they could find floating on the breath of society. Voltaire, while recording these *contes populaires*, as he calls them, pronounces them *très-faux*. All that we really are certain of is, that in his 14th year he was sent to the Jesuit *Collège de Clermont* in Paris, where he had for a fellow-student Prince Armand de Conti, and that, on leaving the *Collège*, he attended for some time the lectures of Gassendi. He was charmed, we are told, by the freedom of thought permitted in speculative science, and, in particular, conceived a great admiration for Lucretius, the Roman poet-philosopher, whom he undertook to translate. Of this translation, only a single passage remains, intercalated in the *Misanthrope* (act ii. scene 4). About 1641, he commenced the study of law, and appears to have even passed as an advocate; but the statement of

Tallement des Réaux that he actually ventured into the precincts of theology, is generally rejected. M. detested priests. So gay, humorous, and sharp-eyed a humanitarians would have felt quite miserable under the restraints of a monkish life. In 1645, he suddenly appeared upon the stage as member of a company of strolling players, which took the name of the *Illustre Théâtre*, and performed at first in the faubourgs of Paris, and afterwards in the provinces. For the next 12 years, we can only catch an occasional glimpse of him. He was playing at Nantes and Bordeaux in 1648, at Narbonne and Toulouse in 1649, at Lyon in 1653 (where his first piece, *L'Etourdi*, a comedy of intrigue, was brought out), at Lyon and Narbonne again in 1655, at Grenoble during the carnival, and also at Rouen in 1658. During these now obscure peregrinations, he seems, although an industrious actor, to have been also a diligent student. He read Plautus, Terence, Rabelais, and the Italian and Spanish comedies, besides—without which, indeed, all the rest would have been of little avail—making a constant use of his quick eyes as ever glittered in a Frenchman's head. At Paris, by the powerful recommendation of his old schoolfellow, the Prince de Conti, M.'s company got permission to act before the king, who was so highly pleased, that he allowed them to establish themselves in the city under the title of the *Troupe de Monsieur*. In 1659, M. brought out *Les Précieuses Ridicules*, the fine satire of which—lapsing at times, however, into caricature—was instantly perceived and relished. '*Courage, Molière!*' cried an old man on its first representation; '*voilà la véritable comédie.*' The old man was a prophet. Veritable comedy dated in France from that night. *Ménage*, the critic, is reported to have said to Chapelain the poet, as they were going out of the theatre: 'Henceforth (as St Remi said to Clovis), we must burn what we have worshipped, and worship what we have burned.' In 1660 appeared *Sganarelle, ou le Cocu Imaginaire*; and in 1661, *L'Ecole des Maris*—partly founded on the *Adelphi* of Terence, in which M. completely passes out of the region of farce into that of pure comic satire—and *Les Fâcheux*. In the following year, M. married Armande-Grésinde Béjart, either the sister or daughter (for it is still undetermined) of Madeleine Béjart, an actress of his troupe, with whom he had formerly lived in what the French politely call 'intimate relations.' That, however, there is the slightest ground for supposing that the great comedian incestuously married his own daughter, nobody now believes, though the revolting calumny was freely circulated even in M.'s lifetime. His literary activity continued as brisk as before. Among several pieces belonging to this year, the most celebrated is *L'Ecole des Femmes*, which excited, not without reason, the most violent indignation among the clergy and the devout, for there was an excessive indecency in the expression, and the author indulged in a caricature of religious mysteries that could not but be offensive. M. defended himself with incredible audacity in his *Impromptu de Versailles*. *Le Tartufe*, written in 1664, was prohibited from being brought upon the stage; but M. was invited by his literary friends, Boileau and others, to read it in a semi-public manner, which he did with the greatest approbation. In 1665, Louis XIV. bestowed a pension of 7000 livres on M.'s company, which now called itself the *Troupe du Roi*. Next year appeared *Le Misanthrope*, the most artistic of all his comedies; shortly after followed by *Le Médecin Malgré Lui*. When *Tartufe* was at last brought upon the stage in 1669, it obtained a superb success. The truth, the variety, the contrast of the characters, the exquisite art shewn in the management of the

incidents, the abundance of the sentiments, and the wonderful alternations of feeling—laughter, anger, indignation, tenderness, make this, in the opinion of most critics, M.'s master-piece. To the same year belongs *L'Avare*. In 1670 appeared *Le Bourgeois Gentilhomme*, a very pleasant satire on a very prevalent vice among wealthy tradesmen—viz., the vulgar ambition to pass for fine gentlemen. Then came *Les Fourberies de Scapin* (1671), followed by *Les Femmes Savantes* (1672), full of admirable passages; and *Le Malade Imaginaire* (1673), the most popular, if not the best of all M.'s comedies. While acting in this piece, he was seized with severe pains, which, however, he managed to conceal from the audience; but on being carried home, hæmorrhage ensued, and he expired at ten o'clock at night (17th February 1673). As M. had died in a state of excommunication, and without having received the last aids of religion—which, however, he had implored—the Archbishop of Paris refused to let him be buried in consecrated ground; but the king interfered—a compromise was effected, and he was privately interred in the cemetery of St Joseph, being followed to the tomb by a hundred of his friends with lighted torches. In 1792, his remains were transferred to the Museum of French Monuments, from which they were removed to Père Lachaise in 1817. M. ranks as the greatest French comic dramatist—perhaps the greatest of all comic dramatists. An excellent edition of his works, with a commentary, a preliminary criticism, and a life, is that by M. Auger of the French Academy (Paris, 1819—1825); but a still more complete one, containing some recently discovered pieces of M., is that by M. Aimé-Martin, commenced in 1845. The books devoted to M. and his works would themselves form a large library.

MOLINA, LOUIS, a celebrated Spanish Jesuit theologian, was born at Cuença, in New Castile, in the year 1535; and having entered the Jesuit Society in his 18th year, studied at Coimbra, and was appointed Professor of Theology at Evora, where he continued to teach for 20 years. He died at Madrid in 1600, in the 65th year of his age. M.'s celebrity is mainly confined to the theological schools. His principal writings are a commentary on the *Summa* of St Thomas (Cuença, 2 vols. 1593); a minute and comprehensive treatise *On Justice and Right* (Cuença, 6 vols. 1592; reprinted at Mainz in 1659); and the celebrated treatise on *The Reconciliation of Grace and Free-will*, which was printed at Lisbon in 1588, with an appendix, printed in the following year. Although it is to the last-named work that M.'s celebrity is mainly due, we must be content with a very brief notice of it. The problem which it is meant to resolve is almost as old as the origin of human thought itself, and had already led, in the 4th c., to the well-known PELAGIAN CONTROVERSY (q. v.). In reconciling with the freedom of man's will the predestination of the elect to happiness, and of the reprobate to punishment, M. asserts that the predestination is consequent on God's foreknowledge of the free determination of man's will, and, therefore, that it in no way affects the freedom of the particular actions, in requital of which man is predestined whether to punishment or to reward. God, in M.'s view, gives to all men sufficient grace whereby to live virtuously, and merit happiness. Certain individuals freely co-operate with this grace; certain others resist it. God foresees both courses, and this foreknowledge is the foundation of one or of the other decree. This exposition was at once assailed in the schools on two grounds—first as a revival of the Pelagian heresy, inasmuch as it appears to place the efficacy of grace in the consent

of man's will, and thus to recognise a natural power in man to elicit supernatural acts; second, as setting aside altogether what the Scriptures represent as the special election of the predestined, by making each individual, according as he freely accepts or refuses the grace offered to all in common, the arbiter of his own predestination or reprobation. Hence arose the celebrated dispute between the MOLINISTS and the THOMISTS (q. v.). It was first brought under the cognizance of the Inquisitor-general of Spain, by whom it was referred to Pope Clement VIII. This pontiff, in 1697, appointed the celebrated congregation, *De Auxiliis*, to consider the entire question; but notwithstanding many lengthened discussions, no decision was arrived at during the lifetime of Clement; and although the congregation was continued under Paul V., the only result was a decree in 1607, permitting both opinions to be taught by their respective advocates, and prohibiting each party from accusing the adversaries of heresy. The dispute, in some of its leading features, was revived in the Jansenist controversy (q. v.); but with this striking difference, that whereas the rigorous Jansenists denied the freedom of the will when acted on by efficacious grace, all the disputants in the scholastic controversy—even the Thomists—maintain that, in all circumstances, the will remains free, although they may fail to explain how this freedom is secured under the action of efficacious grace. See THOMISTS.

MOLINISM, the name given to the system of grace and election taught by Louis Molina (q. v.). This system has been commonly taught in the Jesuit schools; but a modification of it was introduced by the celebrated Spanish divine Suarez (q. v.), in order to save the doctrine of *special election*. Suarez held, that although God gives to all grace absolutely sufficient for their salvation, yet he gives to the elect a grace which is not alone in itself sufficient, but which is so attuned to their disposition, their opportunities, and other circumstances, that they infallibly, although yet quite freely, yield to its influence. This modification of Molina's system is called CONGRUISM. Molinism must not be confounded either with Pelagianism or semi-Pelagianism, inasmuch as Molinism distinctly supposes the inability of man to do any supernatural act without GRACE (q. v.).

MOLINOS, MICHAEL DE, was born of noble parentage at Patacina, in the kingdom of Aragon, December 21, 1627. He received holy orders and was educated at Pampeluna, and afterwards at Coimbra, at which university he obtained his theological degree. After a career of considerable distinction in his native country, M. went to Rome, where he soon acquired a high reputation as a director of conscience and a master of the spiritual life. His private character was in keeping with this public reputation. He steadily declined all ecclesiastical preferment, and confined himself entirely to his duties in the confessional, and in the direction of souls. An ascetical treatise which he published, under the title of *The Spiritual Guide*, added largely to the popularity which he had acquired in his personal relations; but there were not wanting many who, in the specious, but visionary principles of this work, discovered the seeds of a dangerous and seductive error. Among these, the celebrated preacher, F. Segneri, was the first who ventured publicly to call them into question; but his strictures were by the friends of M. ascribed to jealousy of the influence which M. had acquired with the people. By degrees, however, reports unfavourable to the practical results of this teaching, and even to the personal

conduct and character of M., or of his followers, began to find circulation; and eventually, in the year 1685, he was cited before the Holy Office, and submitted to close imprisonment and examination. In addition to the opinions contained in his book, a prodigious mass of papers and letters, to the number, it is said, of 20,000, found in his house, were produced against him, and he was himself rigorously examined as to his opinions. The result of the trial was a solemn condemnation of sixty-eight propositions, partly extracted from his *Spiritual Guide*, partly, it would appear, drawn from his papers or his personal professions. These doctrines M. was required publicly to abjure, and he was himself sentenced to close imprisonment, in which he was detained until his death in 1696, when he had entered on his 70th year. The opinions imputed to M. may be described as an exaggeration of the worst and most objectionable principles of QUIETISM (q.v.). According to the propositions which were condemned by the Inquisition, M. pushed to such an extreme the contemplative repose which is the common characteristic of Quietism, as to teach the utter indifference of the soul, in a state of perfect contemplation, to all external things, and its entire independence of the outer world, even of the actions of the very body which it animates; inasmuch that this internal perfection is compatible with the worst external excesses. These consequences are by no means openly avowed in the *Spiritual Guide*, but they appear to follow almost necessarily from some of its maxims, and they are said to have been plainly contained in the papers of M., which were produced at his trial, and to have been admitted by himself. After the death of M., no further trace of his teaching appears in Italy, but it was revived in more than one form in France.

MOLLAH, among the Turks, is the title of a superior judge. The Mollahs are divided into two classes: the first of these—four in number, from whom the Mollahs at the court of the Padishah are elected, possesses jurisdiction over the more important pashaliks (Adrianople, Brusa, Damascus, Cairo); and the second, who only hold their office for the space of a lunar month at a time, and the lowest rank of whom is formed by the naibs, over the inferior provinces, towns, and villages. The Mollah is an expounder of civil and criminal law, and of the religion of the state; he is therefore necessarily both a lawyer and an ecclesiastic. Under him is the Cadi or judge, who administers the law, and superior to him are the Kadhiasker and the Mufti (q.v.). They all are, however, subject to the Sheikh Al Islam or supreme Mufti. In Persia, the office of mollah is similar to what it is in Turkey; but his superior is there the 'Sadr,' or chief of the Mollahs. In the states of Turkestan, the Mollahs have the whole government in their hands.

MOLLASSE, an extensive Miocene or Middle Tertiary deposit, occupying the central lake-region of Switzerland between the Alps and the Jura. It consists chiefly of a loose sand, but at the foot of the Alps it usually takes the form of a conglomerate called 'Nagel-flue,' which is said to attain the astonishing thickness of from 6000 to 8000 feet in the Rhig, near Lucerne, and in the Speer, near Wesen. The mollasse contains a few shells and some vegetable remains, among which are several palms.

MOLLUSCA, one of the great animal sub-kingdoms, including so wide a range of distinct forms, that it is difficult to frame a definition that shall be applicable to all of them. The lowest forms, termed Polyzoa (q.v.) or Bryozoa, present so strong a

resemblance to zoophytes, that until recently they were associated with the latter; whilst, on the other hand, in some of the most highly organised of this sub-kingdom, the Cephalopoda, there is a decided approximation towards the vertebrated series, as is shown by the presence of a rudimentary cartilaginous skeleton, and by a peculiarity in the development of the embryo. The bilateral symmetry of external form which is almost universal in articulated and vertebrated animals, is here seldom met with; and taking them as a whole, the M. are characterised by the absence rather than by the presence of any definite form. The bodies of these animals are always of a soft consistence—a property to which they owe their name, which was devised for them by Cuvier, before whose time they were included in the *Vermes* of Linnæus's arrangement. The *shell*, when it exists, is not to be regarded as an exo-skeleton giving attachment to muscles, and regulating the form of the animal, but merely as an appendage designed for the protection of the body from which it derives its shape; indeed, it is only where the body is uncovered by a shell, or where the locomotive organs can be projected beyond it, that any active movements can be effected. The whole fabric is enclosed in a thick, soft, flexible skin, called the *mantle*, and it is on the surface of this envelope that the shell is formed by the development and subsequent calcification of epithelial cells. In many of the M., the shell is composed of a single piece, which is usually a spiral tube, closed at one end, and gradually increasing in size towards the open extremity, from which the animal is able to protrude itself. Shells of this description are called *univalves*. In others, the shell is composed of two pieces or valves, attached to each other at one point by a hinge, which is furnished with an elastic ligament that serves to open the valves, when it is not opposed by the action of the *adductor* muscles, whose office it is to keep the shell closed. Shells of this kind are termed *bivalves*. These differences in the character of the shell correspond with differences in the conformation of the animals inhabiting them. The bivalve M. exhibit no traces of a head, and hence are termed *Acephalous* M.; while the univalves have a distinct head, provided with organs of the special senses, and hence, by way of distinction, some writers have termed them *Cephalophora* (or head-bearing). Many M. are altogether unprovided with a shell, or have only a small calcareous plate embedded within the mantle. These are termed *naked* mollusca. It is worthy of notice that the young mollusc, while still in the egg, is almost always furnished with a delicate pellucid shell, even when it is ultimately to be naked, in which case the embryonic shell is cast off soon after the animal makes its escape from the egg. For the mode of formation, &c. of the shell, see SHELL.

The movements of many of the M. are executed by means of a muscular structure concentrated in some particular part or parts of the mantle, and termed the *foot*. In some (the Gasteropoda), the foot forms a sort of flattened disc, by the alternate contraction and expansion of different parts of which the animal can slowly crawl forwards; whilst in others (the free-moving bivalves) it is a tongue-like organ, which can be protruded between the valves, and by its sudden extension, after being previously bent upon itself, can enable its possessor (the common cockle, for example) to take considerable leaps. The foot is also the agent by means of which certain species burrow in the sand or mud, and others bore into the solid rock. Many M., however, are firmly attached to a single spot, except during their larval state; and as they do not require

a foot, we find it either altogether undeveloped (as in the oyster), or serving to support a glandular organ, from which filaments of silky or horny matter (called the *bysus*) are secreted, which serve to attach the animal (the common mussel, for example) to rocks, stones, &c., beneath the water. Many of the subdivisions of the M. present modes of locomotion altogether independent of a foot, as, for example, the *Biphora*, which are described in the article TUNICATA; those bivalves which possess a branchial or respiratory chamber, into which water is drawn, and again expelled by muscular action, a recoil being thus produced which serves to drive the animal through the water; the *Pteropoda* (q. v.), which are furnished with a pair of broad flattened fins (which may possibly be regarded as a modified foot) at the sides of the head, by means of which they swim with tolerable rapidity; and the *Cephalopoda*, in which the mouth is surrounded by a number of arms, which serve not only as organs of motion, but for the capture of prey.

The *nervous system* in the M. is developed in accordance with two distinct types. In the lowest group of this sub-kingdom (the Molluscoids), there is only a single ganglion with afferent and efferent

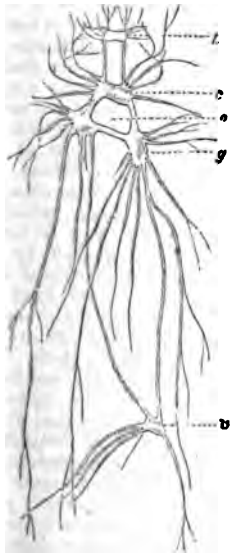

Fig. 1.—Nervous System of the *Aplysia*, a Gastropod Mollusc:

c, cerebral ganglia; g, thoracic or sub-oesophageal ganglia; o, nervous collar surrounding the oesophagus; l, labial ganglia; v, visceral ganglion.

fibres radiating in every direction; while in the higher groups there are several ganglia lying somewhat irregularly in different parts of the body, and communicating by nervous threads with a larger mass placed in the head, or in the neighbourhood of the oesophagus. This mass consists of several ganglia, which from their position are termed *supra-oesophageal*, and is united by filaments with other ganglia lying below the oesophagus, so as to form a ring or collar around that organ. The supra-oesophageal ganglia furnish the nerves to the special organs of the senses. Most of the M. possess special *organs of touch* in the form of lips or of special lobes around the mouth; of tentacles or arms upon the head, or of cirrhi upon other parts of the body; and in addition to these special organs, the skin appears to possess considerable sensibility.

When tentacles are present, they are either two or four in number; and they can be protruded and retracted at pleasure, as every one must have noticed in the case of these organs (popularly known as *horns*) in the snail. *Organs of sight* are not universally present. In many M., there is only a single rudimentary eye, while in others there is a large number of imperfect eyes (termed *ocelli*), which do not of necessity lie in the region of the head. In the higher M., there are two eyes, sometimes placed directly on the head, and sometimes on the tentacles; and in the highest group (the *Cephalopods*), the eyes are as fully developed as in fishes.

Organs of hearing, in a simple form, are almost

always present. They usually consist of round vesicles in the neighbourhood of the oesophageal ring, from which they receive a nervous filament. They contain a clear fluid and a small concretion of carbonate of lime, which is sometimes roundish, and sometimes of a crystalline form, and is in a perpetual state of vibration, in consequence of ciliary action in the interior of the vesicle. Whether there are any special *organs of smell and taste* in the M., is still undecided.

The organs of *vegetative life* (of digestion, circulation, &c.) are much more fully developed in the M. than those of *animal life*. The alimentary canal, which presents almost every variety of form from a simple cavity to a complicated intestine, is always



Fig. 2.—Anatomy of the Snail:

a, the mouth; bb, foot; c, anus; dd, lung; e, stomach, covered above by the salivary glands; ff, intestine; g, liver; h, heart; i, aorta; j, gastric artery; k, hepatic artery; l, artery of the foot; mm, abdominal cavity, supplying the place of a venous sinus; nn, irregular canal in communication with the abdominal cavity, and carrying the blood to the lung; oo, vessel carrying the blood from the lung to the heart.

provided with two distinct openings, a mouth and an anus, the latter being often situated (as in the *Gastropoda* and *Pteropoda*) on the right side of the anterior part of the body. The liver is always present, existing in a mere rudimentary form in the *Polyzoa*, constituting a large part of the body in the acephalous bivalve M. (as the mussel and cockle), and a still larger part in the *Gastropoda* (as the snail), while in the *Cephalopoda* it is constructed upon nearly the same plan as in fishes. Other secreting organs, such as salivary glands, pancreas, and urinary organs, are also present in the more highly developed mollusca.

The circulation of the blood is effected (except in the *Polyzoa*) by means of a distinct heart, which usually communicates with a regular, closed vascular system; but in some cases the venous system is imperfect, and the blood which has been transmitted by the arteries to the system in general is not confined within distinct vessels, but meanders through sinuses or passages excavated in the tissues, and through them it reaches the respiratory apparatus, whence it is transmitted by closed vessels (veins) to the heart. The blood is nearly colourless (sometimes of light blue or green tint), and contains but few floating corpuscles. In all but the very lowest M., there is a distinct respiratory apparatus, which, excepting in the case of the terrestrial *Gastropoda* (as, for example, the snail), is constructed with a view to aquatic respiration, and is composed of *branchia*, or gills. These branchia usually consist of a series of membranous plates (arranged like the leaves of a book or the teeth of a comb), over which the water flows. They are sometimes attached to the surface of the body, but are most commonly enclosed within the mantle, or placed in a cavity in its interior called the branchial or respiratory chamber. In many of the bivalves,

the openings for the ingress and egress of water are prolonged into tubes or syphons, which are sometimes of considerable length; the tube through which the water enters being termed the *oral* syphon, while that through which it escapes is termed the *anal* syphon (see fig. 3). In all the

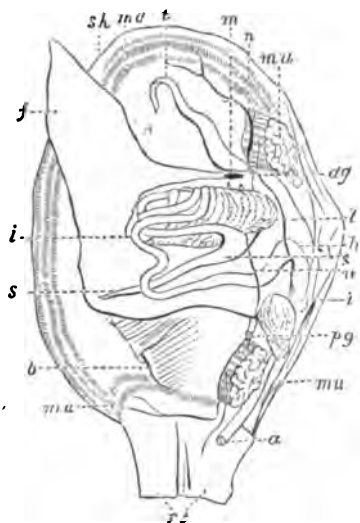

Fig. 3.—Anatomy of an Acephalous Mollusc (*Mactra*): *m*, mouth; *s*, stomach; *ü*, intestine; *ag*, anterior ganglia; *pp*, posterior ganglia; *mu*, muscles; *a*, anus; *A*, heart; *l*, liver; *f*, foot; *sh*, shell; *ma*, mantle; *b*, branchia; *t*, tentacula; *r*, oral, or respiratory syphon; *t*, anal syphon.

aquatic *M.* except the Cephalopoda, the renewal of the water in contact with the surface of the gills is mainly due to ciliary action. In the air-breathing gasteropodous *M.* (of which the snails and slugs are well-known examples), there is a pulmonary sac or bag, into which the air penetrates by an opening on the right side of the body near the neck.

There are considerable differences in the modes of propagation of the mollusca. In the Molluscoids—the Polyzoa and Tunicata—there is both propagation by gemmation (like that of Zoophytes, q. v.) and sexual reproduction, the sexes being distinct in the Polyzoa, and united in the same individual (constituting Hermaphroditism, q. v.) in the Tunicata. In the Lamellibranchiata, or bivalve *M.*, and in the Cephalopoda, the sexes are separate; while in the Gasteropoda the sexes are most commonly separate, although a considerable number are hermaphrodites, which, however, require mutual impregnation to fertilise the ova. The eggs vary greatly in form; in some cases, they are laid separately, but most commonly they are agglutinated together in a mass; while in some marine species many eggs are enclosed in a leathery capsule, while numerous capsules are united to form a large mass. A comparatively few *M.* produce living offspring, the ova being retained in the oviduct until the extrusion of the young animals.

The *M.* are widely diffused through time and space. They were amongst the earliest animal inhabitants of our globe, and are everywhere found in fresh and salt water (except at great depths), and in every latitude of the earth. The great majority are marine animals, and it is in the tropical regions that the largest and most beautiful forms are developed. It is impossible to form even an approximate estimate of the number of mollusca. According to Leunis (*Synopsis der drei Naturreiche; erster Theil*,

1860, p. 77), there are 16,732 living, and 4590 fossil species, exclusive of Polyzoa; and it is probable that only a small proportion of the naked or shell-less *M.* is yet known.

The uses of many species of *M.* for food are too well known to require notice; and as bait for fishing, mussels and some other *M.* are of great value.

The animals of this sub-kingdom are divisible into the Molluscoids and the true Mollusca, the former being distinguished from the latter by the very low development of the nervous system, which is composed of only a single ganglion, giving off nerves in different directions; and by their propagating by gemmation. The Molluscoids are divisible into: Class 1. POLYZOA or BRYOZOA. Examples—*Plumatella*, *Flustra*. Class 2. TUNICATA. Examples—*Ascidia*, *Salpa*. The true Mollusca are divisible into: Class 3. BRACHIOPODA or PALLIOBRANCHIATA. Example—*Terebratula*. Class 4. LAMELLIBRANCHIATA. Examples—*Oyster*, *Mussel*, *Cockle*. Class 5. GASTEROPODA. Examples—*Snail*, *Cowry*, *Limpet*, *Doria*. Class 6. PTEROPODA. Examples—*Clio*, *Hyalea*. Class 7. CEPHALOPODA. Examples—*Cuttle-fish*, *Nautilus*. The distinctive characters of these classes are given in separate articles.

The literature of this subject is very extensive. Amongst the most important works on the *M.* generally may be mentioned Cuvier, *Mémoires pour servir à l'Histoire et à l'Anatomie des Mollusques avec 35 pl.* (Paris, 1817, 4to); Lamarck, *Hist. Nat. des Animaux sans Vertèbres*, 2d edit., par Deshayes et Milne-Edwards (11 vols. 8vo); Woodward, *Manual of the Mollusca*; and the third volume of Bronn's great work, now in course of publication, entitled *Classen und Ordnungen des Thierreichs*; while for information on the *M.* of Great Britain, the reader is especially referred to Forbes and Hanley, *Molluscos Animals and their Shells* (4 vols. 8vo); Gosse, *A Manual of Marine Zoology for the British Isles*; and Alder and Hancock, *Nudibranchiate Mollusca* (published by the Ray Society).

Fossil Mollusca.—The hard shells of most *M.* fit them for long preservation, and make them the most frequent organic remains in the fossiliferous rocks from the Silurian upwards. The tunicata and the nudibranchiate gasteropods, having no hard parts that could be preserved, are without fossil representatives; the glassy and translucent fragile shell of the pteropoda is only known fossil from a few species in the Tertiary strata; unless, indeed, the comparatively large forms (*Conularia* and *Theca*) from the older rocks have been rightly referred to this order. The remaining four orders—the Cephalopoda, Gasteropoda, Brachiopoda, and Lamellibranchiata—have existed together from the earliest period. The tetrabranchiate Cephalopoda were developed in great profusion and variety in the Palæozoic and Secondary periods; and as they decreased, the dibranchiate group took their place, and continued to increase in numbers until it reached its greatest development in the seas of our own day. Of the chambered shells like the pearly nautilus, it is estimated that over 1400 species are known, of which only five or six exist in the ocean now; the cuttle-fishes and squids, on the other hand, are represented in the Secondary and Tertiary rocks by about 100 species, while at least twice as many are known as living species.

The living Gasteropoda exceed the fossil in the proportion of 4 to 3. This disproportion will appear greater when we remember that the fauna of the present seas is set against the faunas of some thirty different periods, yet it must not be forgotten that we can never be acquainted with more than a fraction of the entire animal life of any bypast

age. Almost contemporaneous with the first living organisms, this group has gone on increasing to the present time, when the numbers are so great that more than 8000 living species have been recorded. A genus of air-breathing univalves has been described by Lyell, from the coal-measures of Nova Scotia. A single species—a modern-looking *Physa*—has been obtained from the Purbeck limestone, the newest of the Secondary rocks. They are more frequent in Tertiary beds.

The Brachiopoda, or Lamp-shells, like the nautilus group, have their history chiefly written in the rocky tablets of the earth. Of 1300 known species, only 75 are living, and these are comparatively rare, or are at least found in inaccessible localities, whereas, in some periods of the earth's history, as when the chalk and mountain limestone beds were being formed, and especially during the Devonian period, the individuals abounded to an enormous extent. The genus *Lingula*, seven species of which live in the modern seas, can be traced through the intervening strata, down to the first fossiliferous bed, to which, indeed, it gives the name of 'Lingula Bed;' but this species, though externally not to be distinguished from the existing shell, has a pedicle groove in the ventral valve—a character sufficient, perhaps, for the establishment of a different genus. Indeed, none of the genera of the Palæozoic rocks still exist; the want of exact information is the only excuse for the continued application of the names of recent genera to the ancient inhabitants of the globe.

The Conchifera have been gradually increasing in numbers and importance from the earliest period, and they attain their maximum development in the existing seas. The more simple forms, with an open mantle, are common in the Palæozoic strata; the siphonated families, unknown in the older rocks, appear in considerable number in the Secondary strata, and continue to increase upwards. The recent species number about 3000, while the fossil are nearly twice as many.

MOLLWITZ, a village of Prussian Silesia, in the government of Breslau, seven miles west of Brieg. Pop. 619. To the east of it lies the celebrated battle-field where Frederick II. of Prussia gained his first victory over the Austrians under Marshal Neipperg, April 10, 1741. According to the usual account, Frederick, on seeing his right wing and centre thrown into confusion and routed, put spurs to his charger, and fled from the field; but the advance of three battalions of Prussian infantry stopped the Austrians, while by this time Marshal Schwerin, who commanded on the Prussian left, routed the Austrian right wing, and compelled the whole to retreat. The Austrians suffered immense loss in killed, wounded, and prisoners. The immediate result of this victory was an alliance between France and Prussia, to dissolve which Austria was compelled to surrender the province of Silesia to Frederick, in 1742.

MOLO, a city of the Philippine Islands, on an island of the same name, four miles from Iloilo. See PHILIPPINES. In ancient times, it was a Chinese colony, and is now occupied by Mestizos and their descendants, most of them having a mixture of Chinese blood. Pop. 16,428.

MOLOCH (more correctly **MOLECH**), also **MILKOM**, **MALKOM** (their king), from Heb. *Melech*, king, the chief Ammonite deity (the Chemosh of the Moabites), whose worship consisted chiefly of human sacrifices, purifications, and ordeals by fire, mutilation, perpetual virginity, and the like; practices specially inveighed against in the Mosaic records. Even the stranger who should devote his offspring to this idol was to be put to death by

stoning. It is not quite certain which was the particular manner of this sacrifice. Rabbinical tradition represents Moloch as a human figure of brass or clay, with a crowned bull's head, upon whose extended arms were laid the doomed children. A fire within the hollow statue soon scorched them to death, while their shrieks of agony were deadened by a loud noise made by the priests upon various instruments. But although this description nearly coincides with that of the statue of the Carthaginian Kronos, and although so late a traveller even as Benjamin de Tudela speaks of having seen the remains of an ancient Ammonite temple at Gebal, with the fragments of an idol somewhat corresponding to the above representation, yet nothing certain is known about this point at present; nay, even the burning of the children itself has been questioned; and it is contended, yet without much show of reason, that the victims were merely carried through two pyres of fire by way of solemn purification or baptism. It seems, however, certain that the worship of M., in whatever shape it may have been, was common throughout the Canaanite nations. The Carthaginians, through whom it was probably spread over the whole East, worshipped Kronos in rites of fire and bloodshed; and human beings, children or grown-up persons, prisoners or virgins, were, either on certain periodical festivals, or on sudden emergencies, offered up throughout almost all the lands and islands which the merchant-people of antiquity may be supposed to have touched at. The description of the Kronian statue, as given by classical writers, differs only in that small respect from the one given above, that the child fell, according to the former, from the hands of the god into a burning fire below, instead of being slowly burned to death. On fire-worship in general, which is the main idea of 'Moloch'—probably worshipped originally as the symbol of the sun—we have spoken under **GUEBRES**. The name itself gives no clue to its special nature, nor does any comparison with cognate roots lead any further. Molech, or Melech, is the supreme king or deity of the people, who have enthroned him as their tutelary god. Naturally, the princes of Ammon are the princes of *Malcham*—their (the Ammonites') king or god, and his priests were high in social rank.

Respecting the special history of this worship among the Israelites, we can only say that, although we do not see any more reason to presuppose its wide spread at early times (on account of the frequent occurrence of the word 'king' in doubtful passages), than there is the slightest ground for assuming (as has been done by Daumer and others) that the whole Mosaic religion originated in a Moloch-service (a notion which hardly required a serious refutation for its instant explosion)—yet there is no doubt that it had its secret, although few adherents, even before the Canaanite women in Solomon's harem reintroduced it publicly. The Valley of Hinnom and the Mount of Olives were the chief places of these abominable rites; the former being afterwards adopted as the name for Hell, even in Islam. Not until the time of Josiah was it rooted out from among the people. The word has now become a designation for a kind of irresistible dread influence, at whose shrine everything would be sacrificed, even as the deluded father offered his own child to the terrible idol.

MOLOGA, a district town in the west of the government of Jaroslav, in European Russia, is situated near the confluence of the Mologa and Volga, 68 miles west-north-west of Jaroslav. It is a town of great antiquity, and first belonged to the principality of Rostof, afterwards to Yaroslaf, but from 1321 till 1471, it had its own princes. There

MOLUCCAS.

was formerly an extensive fair at Mologa. At the present time, the timber-trade, and the carriage of goods by river-boats and rafts, occupy the majority of the inhabitants. Pop. (1859) 5044.—The river Mologa is one of the links between the Volga and the Neva.

MOLUCCAS, or **ROYAL ISLANDS**, properly so called, are Ternate, Tidore, Makian, Motir, and Batjan, lying to the west of Gilolo, and washed by the Moluccas Strait or Passage, which separates Gilolo from Celebes.—Ternate, the most important, lies in 0° 55' N. lat., and 127° 10' E. long., is 25 miles in circumference, and has a population of 7500, of whom 400 are Europeans. It was formerly the residence of sultans, who ruled over large territories, and could call out 100,000 fighting-men. The island is fertile and well watered, the natives peaceful. They cultivate rice, cotton, tobacco, &c., carry on trade with the adjacent islands, and build all sorts of vessels, from the light skiff and the tent-boat to the war-galley of 60 or 80 rowers, carrying two or more pieces of light artillery.—Tidore is south of Ternate, in 0° 45' N. lat., and 127° 25' E. long., 30 miles in circumference, and rises upwards towards the interior, having a population of 8000. The natives are less gentle, but more industrious than those of Ternate, and diligently cultivate the soil, weave, and fish. They are Mohammedans, and have many mosques. The sultans of Ternate and Tidore are subsidised by and subject to the Netherlands, being appointed by the governor of the M., and exercising their authority under the surveillance of the Resident.—Makian lies in 0° 18' 30' N. lat., and 127° 24' E. long., is very fertile, and, before the rooting out of the spice-trees, gave a large annual crop of cloves. Now it yields much sago, rice, tobacco, canary-oil, &c., and has important fishings.—Further north is the island of Motir, which is uninhabited, but formerly yielded a considerable quantity of cloves, and later, sent much earthenware to all the Spice Islands.

Batjan, the only remaining Royal Island, lies between 0° 13'—0° 58' S. lat., and 127° 22'—128° E. long., is 50 miles in length, and 18 in breadth, has many mountain peaks from 1500 to 4000 feet in height, the sources of numerous rivers. The greatest part of this beautiful island is covered with ebony, satin-wood, and other valuable timber-trees, which give shelter to numerous beautiful-plumaged birds, deer, wild hogs, and reptiles. Sago, rice, coconuts, cloves, fish, and fowls, are plentiful, and a little coffee is cultivated. Coal is abundant, gold and copper in small quantities. The inhabitants, who are lazy and sensual, are a mixed race of Portuguese, Spaniards, Dutch, and natives. These islands are all volcanic, Ternate being a mountain, sloping upwards to 7000 feet, to which Tidore bears a striking resemblance. Makian is an active volcano, which, so late as December 1861, threw forth immense quantities of lava and ashes, by which 326 lives were lost, and 15 villages in part or in whole destroyed. Motir is a trachyte mountain, 2296 feet in height; and Batjan, a chain with several lofty peaks. Total population of the M. Proper, 21,500.

To the south-west of Batjan lie the Obi group, consisting of Obi Major, Obi Minor, Typha, Goma, Pisang, and Maya, of which Obi Major, in 1° 35' S. lat., and from 127° to 128° E. long., is by far the largest, having an area of 598 square miles. It is hilly and fertile, being covered, like the smaller islands of the group, with sago and nutmeg trees. They are uninhabited, and serve as lurking-places for pirates and escaped convicts. In 1671, the Dutch built a block-house, called the Brill; and a few years later, the Sultan of Batjan sold the group

to them for 800 dollars; but the station being found unhealthy, the Company abandoned it in 1738.

The **MOLUCCAS**, or **SPICE ISLANDS**, in the broad use of the term, lie to the east of Celebes, scattered over nearly eleven degrees of lat. and long., between 3° S.—8° N. lat., and 126°—135° E. long., including all the territories formerly ruled over by the sultans of Ternate and Tidore. They are divided into the residencies of Amboyna (q. v.), Banda (q. v.), and Ternate; a fourth residency, under the governor of the M., being Menado (q. v.). Over the northern groups of the Spice Islands, the Netherlands exercise an indirect government, the sultans of Ternate and Tidore requiring to have all their appointments of native officials ratified by the Resident. The southern groups are directly under European rule. The residency of Amboyna contains that island, sometimes called *Ley-Timor*, or *Hitu*, from the two peninsulas of which it is formed, *Buru*, the *Uliassers* group, and the west part of *Ceram*. That of *Banda* includes the *Banda*, *Keffing*, *Key*, *Arru*, and other islands, also the eastern portion of *Ceram*. Under the residency of Ternate are placed the *M. Proper*, *Gilolo*, the neighbouring islands, and the north-west of *Papua*. Population ruled over by the governor of the M., 767,000.

Amboyna, the *Banda* and *Uliasser* Islands, chiefly supply the cloves, nutmegs, and mace which form the staple exports. The *Banda* Islands are *Neira* or *Banda-Neira*, *Great Banda*, *Ay* or *Way*, *Rhun*, *Rozingain*, and *Goenong-Api*, containing an area of 588 square miles. In 1857, pop. 6101, of whom 400 were Europeans; that of the whole residency, 110,302, including the eastern part of *Ceram*. The principal island of the group is *Neira*, south-east from Amboyna, in 4° 33' S. lat., and 130° E. long., separated by narrow straits from *Goenong-Api* on the west, and *Great Banda* on the east. The coast is steep, and surmounted by several forts and batteries, which command the straits and roadstead. The town of *Neira*, on the south side of the island, is the capital of the Dutch residency of *Banda*, has a Protestant church, school, and hospital. The *Banda* Islands have a rich soil, and are planted with nutmeg-trees, producing, in 1860, upwards of a million lbs. of nuts, and 275,586 lbs. of mace. The culture has nearly doubled since 1851. Pine-apples, the vine, banana, cocoa-nut, and other fruit-trees thrive, and are abundant. *Ay* is the prettiest and most productive of the group. *Goenong-Api* is a lofty volcano. There are wild cows, hogs, and deer; sea-carp and mackerel, which last are dried, and form with sago the food of the slaves. The east monsoon begins in May, and the west in December, and are accompanied with rain and storms. The climate is not particularly healthy.

The *Uliassers*, which, with Amboyna, produce the cloves of commerce, are *Saparoua*, *Oma* or *Haroukou*, and *Nousa-Laut*. They lie to the east of Amboyna, in 3° 40' S. lat., and 128° 33' E. longitude, and have an area of 107½ square miles. *Saparoua* is the largest, and is formed of two mountainous peninsulas, joined in the middle by a narrow strip of undulating grassy land. In 1854, there were 91,124 trees, producing 181,137 lbs. of cloves. The population amounts to 11,665, of whom 7340 are Christians, and have 12 schools, with a very large attendance of scholars.—*Oma*, separated from *Saparoua* by a strait of a league in width, has eleven villages, of which *Harouka* and *Oma* are the chief. It is mountainous in the south, and has several rivers and sulphurous springs. The produce of cloves, in 1854, amounted to 38,863 lbs.; and the villagers possessed 45,745 cocoa palms, besides other fruit-trees. The woods abound with deer and wild hogs, the rivers with fish. Sago is grown, but not in

sufficient quantities to meet the wants of the people, who draw further supplies from Ceram. The beautiful village of Harouka, on the west coast, is the residence of the Dutch Postholder, who is president of the council of chiefs. Here is the head office of the clove-produce. There are two forts on Oma, several churches, and six schools, with 700 pupils. Pop. 7183, one-half Christians, the other Mohammedans.—Noussa-Laut lies to the south-east of Saparoua. It is planted with clove-trees, which, in 1853, produced 120,263 lbs. There are upwards of 30,000 cocoa-nut trees. The inhabitants, who formerly were pirates and cannibals, amount to 3479 souls, are all Christians, and have schools in every village—in 1859, they were attended by 870 pupils.

The clove-tree and the nutmeg are indigenous to all the Spice Islands, but the clove-cultivation is confined to Amboyna and the Uliassers, the nutmeg to the Banda Islands. Till 1824, the Dutch prohibited the planting of these trees in other parts, and caused those of native growth to be rooted out, in order to prevent smuggling, and to retain the supply of these spices to the European market. The Spice Islands are generally healthy both for Europeans and Asiatics; and though the plains are sometimes very hot, mountains are always near, where it is pleasantly cool in the mornings and evenings. Besides the spice-trees, the bread-fruit, sago, cocoa-nut, banana, orange, guava, papaw, also ebony, iron-wood, and other valuable timber-trees, are abundant. The natives of some of the islands are Alfoers; of others, Malays on the coasts, and Alfoers in the interior. In Ceram are also Papuan negroes, brought originally from Bali and Papua as slaves.

The governor of the M. has a salary of £1750 sterling, and with the secretary and other officials, resides in the city of Amboyna, the streets of which are broad, planted with rows of beautiful trees, and cut each other at right angles. There are two Protestant churches, a town-house, orphanage, hospital, and theatre, besides a useful institution for training native teachers, with which is connected a printing-press.

In 1854, the clove-produce amounted to 580,592 lbs., the number of trees planted being 405,639, of which one-third part were fruit-bearing; nutmegs, 537,861 lbs., and mace, 133,986 lbs.; the trees planted being 424,573, of which 297,272 were bearing. The total cost of the nutmegs and mace delivered in the Netherlands that year was £30,768 sterling, realising £94,466. In 1859, the M. sent to Java for the account of government, 2012 picols of mace (the picol = 133 lbs.), 81,101 of cloves, 6636 of nutmegs, and 23 of cocoa-nut soap; the value being £59,416. The produce of nutmegs, in 1851, was 463,309 lbs.; in 1859, it had risen to 832,634, and in 1860, to 1,044,657. The clove-crop varies much, as the following table will shew: 1856, 617,250 lbs.; 1857, 187,093½; 1858, 233,518; 1859, 390,888; 1860, 258,117. Amboyna and Banda have been free ports since 1854; but as government monopolises the labour, there is no fair competition, and the people are slaves of the soil, their chiefs being paid in proportion to the produce delivered.

In 1521, Antonio de Brito first appeared to take possession of the M. in the name of the king of Portugal; and after a long period of violence, intrigue, and perfidy, the Portuguese were driven out by the Dutch and natives, at the beginning of the 17th century. The change was of no advantage to the natives, for the Dutch, having obtained the exclusive right of buying all the cloves, at a nominal value, a series of wars ensued, which resulted in the subjugation of the Spice Islands. Recently, new

sultans of Ternate and Tidore have been appointed, with less power than their predecessors; and the wars with the Alfoers of Ceram, in 1859 and 1860, have brought them more fully under Dutch rule.

MOLYBDENUM (sym. Mo; equiv. 48; sp. grav. 8.62) is a rare metal, which, in a state of purity, is of a silvery white colour, has a strongly metallic lustre, is brittle, and very difficult of fusion. It never occurs native, and its principal ore is the bisulphide, which much resembles graphite. It is also occasionally found oxidised, in molybdate of lead. The metal may be obtained by roasting the bisulphide in a free current of air, when the sulphur goes off oxidised as sulphurous acid, and the M. is also oxidised into Molybdic Acid (MoO_3), and remains in the vessel. By the action of charcoal, the reduced metal is then obtained from the acid.

M. forms three compounds with oxygen—the protoxide (MoO), the binoxide (MoO_2), and molybdic acid (MoO_3). Of these three, the last alone has any practical value. Molybdic acid is a white, glistening, crystalline powder, which is almost insoluble in water, fuses at a red heat, and unites with bases to form well-marked salts, the molybdates, which are either colourless or yellow. A solution of molybdate of ammonia is one of the most delicate tests for phosphoric acid.

M. forms various compounds with sulphur, chlorine, &c., none of which are of any practical importance, except the native bisulphide.

MOMENT, of any physical agency, is its importance with reference to some special application. Thus, the moment of a force applied (perpendicularly) to a lever, is the importance of the force as regards turning the lever about its fulcrum. It is, as we know (see LEVER), proportional to the product of the force by the distance of its point of application from the fulcrum. The moment of a force about any axis (to which its direction is perpendicular) is the product of the force by its least distance from the axis; and a similar definition is laid down for moment of velocity and moment of momentum. It is easy to see (see MOMENTUM) that in any system of mutually acting bodies the moment of momentum about any axis remains constant, since the equal mutual forces measure the momentum transferred from one body to another, and the moments of these forces are in pairs equal and opposite. A particular case of this is Kepler's law, that each planet describes equal areas in equal times about the sun.

Moment of Inertia.—In the rotation of bodies round an axis, the moment of inertia is the sum of the products of each particle of the body into the square of its distance from the axis; or if M be the body, m_1, m_2, m_3 , &c., the particles composing it, and r_1, r_2, r_3 , &c., their corresponding distances from the axis, then the moment of inertia of M = $m_1r_1^2 + m_2r_2^2 + m_3r_3^2 + \dots$; and if a quantity, k , be found such that $Mk^2 = m_1r_1^2 + m_2r_2^2 + m_3r_3^2 + \dots$, then k is called the *radius of gyration*. See CENTRE OF GYRATION.

MOMENTUM, or QUANTITY OF MOTION, is defined by Newton as proportional to the mass moving, and its velocity, conjointly. If we assume unit of momentum to be that of unit of mass moving with unit of velocity, we shall evidently have, for the momentum of a mass M, moving with velocity V, the expression MV. And such is the unit generally adopted.

It is shewn by experiment that, when force produces motion in any body, the momentum produced in one second is proportional to the force—and, in fact, force is measured by the momentum it is capable of producing in unit of time. Thus, the same force,

if acting for one second on each of a number of bodies, produces in them velocities which are *inversely* as their masses. Also when, as in the case of falling bodies, the velocities produced in one second are the same in all, we conclude that the forces are *proportional* to the masses; and, in fact, this is the physical proof that the weight of a body is proportional to its mass. Again, if different forces act, each for a second, on the *same* mass, the velocities produced are proportional to the forces. All these are but different modes of statement of the experimental fact, that force is proportional to the momentum it produces in unit of time; which forms a part of Newton's second Law of Motion.

When two masses act on each other, Newton's third Law of Motion (see MOTION, LAWS OF) shews that the forces they mutually exert are equal and opposite. The momenta produced by these must therefore be equal and opposite. Thus, in attraction or impact of two masses, *no momentum is lost*; since what is lost by one is gained by the other.

The momentum of a system of bodies can be resolved (as velocity is resolved) into components in any assigned directions, and the mutual forces of the system may be thus likewise resolved. Applying the previous result, we see at once that in any system of mutually acting bodies (such, for instance, as the solar system), no momentum is, on the whole, either gained or lost in any particular direction, it is merely transferred from one part of the system to another.

This fact, called the Conservation of Momentum, has caused great confusion in the minds of pseudo-physicists, who constantly confound it with Conservation of Work or Energy, a totally different thing.

The momentum produced by a force in any period of time is measured by the product of the force and the *time during which it has acted*—the energy or work done by a force is measured by the product of the force and the *space through which it has acted*. Momentum is proportional to the simple velocity of a body, and can never, by any known process, be transformed into anything else. Energy, when depending on velocity (see FORCE, CONSERVATION OF), is proportional to the *square* of the velocity, and is in the natural world *constantly being transformed from its actual or kinetic form to its potential form, and back again, or to some other kinetic form such as heat, and finally must become heat*. Momentum, on the contrary, is never altered, either in kind or in amount.

In *knocking down* a wall, or in staving in the whole side of a ship, the battering-ram of the ancients (when constructed of sufficient mass, and worked by the proper number of men or animals) was probably nearly as effective as the best modern artillery. But in making a *breach* in a wall, or in punching a hole in the armour of an iron-clad, mere massive shot with low velocities (such as those of the Dahlgren guns) are comparatively ineffective, however great their momentum; while an Armstrong or Whitworth projectile, with a fraction of the momentum, but with greater velocity, and, for its size, much greater kinetic energy, effects the object with ease.

In many every-day phenomena, we see most distinctly the difference between these two affections of matter. Thus, a blow delivered from the shoulder by a *heavy* pugilist, even if it be sluggishly given, generally floors its man, without doing much other injury; but a sharp stroke administered by a light weight, while hardly disturbing the adversary's equilibrium, inflicts serious punishment.

MOMMSEN, THEODOR, a distinguished writer on the history and polity of ancient Rome, was born in 1817 at Garding, in Slesvig, where his father was

a pastor in the Lutheran Church. M. studied first at Altona, and subsequently at the university of Kiel, where he graduated in arts in 1843. Having obtained some assistance from the Academy of Berlin to defray the expenses of a prolonged course of travels, M. spent three years in investigating Roman inscriptions in France and Italy, and from time to time published the result of his investigations in the Annals of the Archæological Institute of Rome and the Herculanean Academy of Naples. The political disturbances of 1848 diverted M. from his favourite pursuits; and for a time he devoted himself to politics, taking upon himself the editorship of the leading Slesvig-Holstein paper, for which he wrote the leading articles in the summer of 1848. M. for a short time held a chair in the university of Leipzig; but his strong political tendencies having given umbrage to the authorities, his appointment was cancelled in 1850, soon after which he accepted a professorship at Zürich; and since that period, his attention has been unremittingly devoted to the investigation of those branches of archæology and ancient history with which his name is now so honourably associated. Among his most valuable contributions to these departments of knowledge, special mention must be made of the following: *Die Uerterlichen Dialekte* (Leip. 1850), *Corpus Inscriptionum Neapolitanarum* (Leip. 1851); his monographs on *The Chronography of the year 354*, and *Roman Coins* (Leip. 1850); the edict of Diocletian, *De Pretiis Rerum Venalium* A. 301 (Leip. 1851); *Inscriptiones Regni Neapolit. Latine*, 1852; *Die Rechtsfrage zwischen Cæsar und d. Senat*, 1857; and his great work on Roman History, *Röm Geschichte*, 3d edition, vols. i.—iii., 1858—1862, which has recently been ably translated into English by W. P. Dickson. M.'s most recent publication is *Römische Forschungen* (1st vol. Lond. and Edin. 1863), consisting of articles on special points of Roman antiquities, contributed to German periodicals in 1859—61.

MOMORDICA, a genus of plants of the natural order Cucurbitaceæ, having lateral tendrils, and the fruit splitting when ripe. *M. Balsamina*, a native of the south of Europe and of the East, produces a curious, oblong, much-warted fruit, called the BALSAM APPLE, which, when green, is infused in oil, to form a vulnerary much esteemed in Syria and some other countries. The ripe fruit is a dangerous poison. The plant is used to form arbours.—The large, red, thorny fruit of *M. mixta*, called *Gol-kakra* in India, is there used for food.—*M. echinata* is called the *Gooseberry Gourd*, because its fruit, which is covered with bristles, is about the size and shape of a large gooseberry. The unripe fruit is used for pickling, and is sometimes to be seen in Covent Garden market.

MOMPO'X, a town of the Granadian Confederation, on the Magdalena, 110 miles south-east of Cartagena. Here the Magdalena, during its periodical floods, rises 12 or 15 feet above its usual level; and the quay and custom-house of M. are built unusually high, in order to provide against this emergency. All the foreign goods destined for the consumption of the Valley of the Magdalena pass through this town. Pop. estimated at 10,000.

MO'NACHISM (Gr. *monachos*, a monk, from *monos*, alone) may in general be described as a state of religious retirement, more or less complete, accompanied by contemplation, and by various devotional, ascetical, and penitential practices. It is, in truth, ASCETICISM (q. v.), with the element of religious solitude superadded. The institution of monachism has, under different forms, entered into several religious systems, ancient and modern. That it was

known among the Jews before the coming of our Lord, appears from the example of the prophet Elias, and from that of the Essenians; and it is probable that religious seclusion formed part of the practice of the NAZARITES (q. v.), at least in the later periods of Jewish history. In the Brahmanical religion, it has had a prominent place; and even to the present day, the *lamaseries* of Tibet may be said to rival in number and extent the monasteries of Italy or Spain. The Christian advocates of monachism find in the gospel exhortations to voluntary poverty (Matt. xix. 21) and to celibacy (1 Cor. vii. 37), at once the justification and the origin of the primitive institution. Its first form appears in the practice of asceticism, of which we find frequent mention in the early part of the 2d century. The primitive ascetics, however, lived among the brethren, and it is only in the following century that the peculiar characteristic of monachism begins to appear. The earliest form of Christian monachism is also the most complete—that already described under the head ANCHORITES (q. v.); and is commonly believed to have in part originated in the persecutions, from which Christians were forced to retire into deserts and solitary places. The anchorites maintained from choice, after the cessation of the persecutions, the seclusion to which they had originally resorted as an expedient of security; and a later development of the same principle is found in the still more remarkable psychological phenomenon of the celebrated PILLAR-SAINTS (q. v.). After a time, however, the necessities of the religious life itself—as the attendance at public worship, the participation of the sacraments, the desire for mutual instruction and edification—led to modifications of the degree and of the nature of the solitude. First came the simplest form of common life, which sought to combine the personal seclusion of individuals with the common exercise of all the public duties; an aggregation of separate cells into the same district, called by the name *Laura*, with a common church, in which all assembled for prayer and public worship. From the union of the common life with personal solitude is derived the name *cenobite* (Gr. *koinos bios*, common life), by which this class of monks is distinguished from the strict solitaries, as the anchorites or eremites, and in which is involved, in addition to the obligations of poverty and chastity, which were vowed by the anchorites, a third obligation of obedience to a superior, which, in conjunction with the two former, has ever since been held to constitute the essence of the religious or monastic life. The first origin of the strictly cenobitical or monastic life has been detailed under the name of SAINT ANTONY (q. v.), who may be regarded as its founder in the East, either by himself or by his disciples. So rapid was its progress, that his first disciple, PACHOMIUS (q. v.), lived to find himself the superior of 7000. In the single district of Nitria, there were no fewer than 50 monasteries (Sozomen, *Eccles. History*, vi. 31), and before long, the civil authorities judged it expedient to place restrictions on their excessive multiplication. It seems to be admitted, that, in the East, where asceticism has always been held in high estimation, the example of Christian monasticism had a powerful influence in forwarding the progress of Christianity; although it is also certain that the admiration which it excited occasionally led to its natural consequence among the members, by eliciting a spirit of pride and ostentation, and by provoking, sometimes to fanatical excesses of austerity, sometimes to hypocritical simulations of rigour. The abuses which arose, even in the early stages of monachism, are deplored by the very Fathers who are most eloquent in their praises of the institution itself. These abuses prevailed chiefly in a class of monks called *Sarabaita*, who

lived in small communities of three or four, and sometimes led a wandering and irregular life. On the other hand, a most extraordinary picture is drawn by Theodoret, in his *Religious Histories*, of the rigour and mortification practised in some of the greater monasteries. The monks were commonly zealots in religion; and much of the bitterness of the religious controversies of the East was due to that unrestrained zeal; and it may be added that the opinions which led to these controversies originated for the most part among the theologians of the cloisters. Most famous among these were an order called *Acemetae* (Gr. sleepless), from their maintaining the public services of the church day and night without interruption. See MONOPHYSITE, MONOTHELITE, NESTORIAN, IMAGE-WORSHIP.

It was in the cenobitic rather than the eremitic form that monachism was first introduced into the West, at Rome and in Northern Italy by Athanasius, in Africa by St Augustine, and afterwards in Gaul by St Martin of Tours. Here also the institute spread rapidly under the same general forms in which it is found in the Eastern Church; but considerable relaxations were gradually introduced, and it was not until the thorough reformation, and, as it may be called, religious revival effected by the celebrated ST BENEDICT (q. v.), in the beginning of the 6th c., that western monachism assumed its peculiar and permanent form. In some of the more isolated churches, as, for instance, that of Britain, it would seem that the reformations of St Benedict were not introduced until a late period; and in that church, as well as in the church of Ireland, they were a subject of considerable controversy. One of the most important modifications of monachism in the West, regarded the nature of the occupation in which the monks were to be engaged during the times not directly devoted to prayer, meditation, or other spiritual exercises. In the East, manual labour formed the chief, if not the sole external occupation prescribed to the monks; it being held as a fundamental principle, that for each individual the main business of life was the sanctification of his own soul. In the West, besides the labour of the hands, mental occupation was also prescribed, not, it is true for all, but for those for whom it was especially calculated. From an early period, therefore, the monasteries of the West, and particularly those of Ireland, or of the colonies, founded by Irish monks, as Iona and Lindisfarne, became schools of learning, and training-houses for the clergy. At a later period, most monasteries possessed a *scriptorium*, or writing-room, in which the monks were employed in the transcription of MSS.; and although a great proportion of the work so done was, as might naturally be expected, in the department of sacred learning, yet it cannot be doubted that it is to the scholars of the cloister we owe the preservation of most of those among the master-pieces of classic literature which have reached our age.

In the remarkable religious movement which characterised the church of the 12th c. (see FRANCIS OF ASSISI, FRANCOISGANS), the principle of monachism underwent a further modification. The *spiritual egotism*, so to speak, of the early monachism, which in some sense limited the work of the cloister to the sanctification of the individual, gave place to the more comprehensive range of spiritual duty, which, in the institute of the various bodies of FRIARS (q. v.) which that age produced, made the spiritual and even the temporal necessities of one's neighbour equally with, if not more than, one's own, the object of the work of the cloister. The progress of these various bodies, both in the 12th c. and since that age, is detailed under their several titles. It only remains to detail the later history of monachism,

properly so called. The monastic institutes of the West are almost all offshoots or modifications of the BENEDICTINES (q. v.); of these, the most remarkable are the CARTHUSIANS, CISTERCIANS, GRAND-MONTINES, CLUGNIACS, PREMONSTRATIENSIANS, and above all MAURISTS, or Benedictines (q. v.) of St Maur. In more modern times, other institutes have been founded for the service of the sick, for the education of the poor, and other similar works of mercy, which are also classed under the denomination of monks. The most important of these are described under their several heads.

The enclosure within which a community of monks reside is called a MONASTERY (q. v.)—Gr. *monasterion*, Lat. *monasterium*. By the strict law of the church, called the law of cloister or enclosure, it is forbidden to all except members of the order to enter a monastery; and in almost all the orders, this prohibition is rigidly enforced as regards the admission of females to the monasteries of men. To such a length is this carried in the Greek Church, that in the celebrated enclosure of Mount Athos, not only women, but all animals of the female sex are rigorously excluded. The first condition of admission to a monastic order is the approval of the superior, after which the candidates remain for a short time as *postulants*. After this preliminary trial, they enter on what is called the *novitiate*, the length of which in different orders varies from one to three years; and at its close, they are admitted to the profession, at which the solemn vows are taken. The age for profession has varied at different times and in different orders; the Council of Trent, however, has fixed 16 as the minimum age. Originally, all monks were laymen; but after a time, the superiors, and by degrees other more meritorious members, were admitted to holy orders. The distinction of priest-monks and lay-brothers has been already explained under the head FRIAR; but in both alike, where the order is one of those solemnly approved by the church, the engagement taken at the final profession is life-long and irrevocable.

The monastic institute, from the very earliest time, embraced women as well as men. The former were called in Greek by the name *nonis* or *nonna*, and in Latin *nonna* (from which the English *nun*), as also *sanctimonialis*. The cloistered residence of nuns is called by various names, as NUNNERY, CONVENT, a name also applied to the houses of men. The general characteristics of the monastic institute for females are substantially identical with those of the male orders; and as the principal varieties of institute are detailed under their respective heads, it is needless to particularise them here.

It is hardly necessary to say that the reformed churches in the 16th c. discarded the practice of monachism, and suppressed the monastic houses. In some of the German states, the temporalities of the suppressed monasteries were retained, and were granted at pleasure by the sovereign, to be enjoyed together with the titular dignity. Some of the German churches, however, in later times, have revived the institute both for men and for women, as has also been done in the Anglican Church both in the time of Laud and in our own day. In all these Protestant revivals of monachism, however, the engagement is revocable at the will of the individual. At the French Revolution, the monastic establishments of France were utterly suppressed; and in most of the other Catholic countries of Europe, the example has been followed to a greater or less extent. In England and Ireland and America, on the contrary, the institute has made rapid progress within the last 20 years. Most of the orders, however, introduced into these countries are

of the active rather than of the contemplative class.

MONACO, a small principality of Italy, on the coast of the Mediterranean Sea, a few miles north-east of the city of Nice. The climate is fine, so that oranges, lemons, &c. are produced in abundance. Pop. at present under 2000. From the 10th to the 18th c., M. was held by the Genoese family of Grimaldi. In 1815, it was ceded to Sardinia, which, however, recognised its independence, but reserved to itself the right of garrisoning the town of Monaco. At this period, it consisted of three communes—Monaco, Mentone, and Rocca-bruna, with an area of 52 square miles, and a population of about 7000. In 1848, Mentone and Rocca-bruna were annexed to Sardinia, in spite of a protest by his 'Serene Highness,' Carlo Honorio, third prince of Monaco. The Italian war of 1859 placed the whole territory for a brief period under Victor Emmanuel; but Carlo Honorio having sold Mentone and Rocca-bruna (2d Feb. 1861) to the French emperor for 4,000,000 francs, Sardinia was obliged to renounce her hold upon them. Carlo Honorio now possesses nothing but the city and territory of M. itself. M. is a pretty little place on a rocky promontory, with about 1200 inhabitants.—Mentone (q. v.), now a town of France, is a favourite winter resort for invalids.

MONAD (Gr. *monas*, unity), a term borrowed from the Peripatetic philosophy, although employed by moderns in a sense different from that of the Peripatetics, who used it to designate the universe, understood in the pantheistic sense. By moderns, and especially by LEIBNITZ (q. v.), from whose system alone the name has derived importance, it is used to describe the primary elements of all matter. The monads are simple un-compounded substances, without figure, without extension, without divisibility, by the aggregation of which all bodies are formed, and into which all compounded things may ultimately be resolved. The monads are created things, but as being un-compounded, are indestructible; and although subject to change, the change is but external or relative. They are of two classes—the first are destitute of consciousness, although possessing an internal activity which is called by the name of perception; the second possess, in addition to perception, a certain consciousness, which is called by the name 'apperception' or conscious-perception. The monads of this class are souls, and according to the degree of their consciousness is the distinction between the souls of the higher and those of the lower intelligences. The Deity is the PRIME MONAD, or MONAD OF MONADS. The theory of monads enters largely into the philosophic system of Leibnitz, and indeed furnishes the key to much in that system which is otherwise obscure.

MONAD (*monas*), the generic name of many kinds of microscopic organisms, very minute, and supposed also to be of very simple organisation. They appear, even under a powerful microscope, as mere points, moving rapidly through the fluid in which they exist, and often becoming aggregated in clusters; or they are seen to be gelatinous and globular, or nearly so, with a tail or thong-like filament, by the vibrations of which they move. When the fluid is tinted by means of some harmless colouring matter, the existence of several cells or vesicles is discerned within the minute body. Ehrenberg therefore classed them among Poly-gastro Infusoria (see INFUSORIA), and no naturalist doubted their right to a place, although one of the lowest, in the animal kingdom. They are now universally regarded as vegetable, and are ranked among algae. The organisms formerly known as Globe Animalcules (*Volvox*) are clusters of monads

MONADNOCK—MONASTERY.

produced by gemmation from one, and invested with a common envelope. Monads are of various colours. Their gemmation takes place according to fixed laws, so that the groups assume particular forms, characteristic of the different kinds. Thus, in the 'Breast-plate Animalcule' (*Gonium pectorale*), so called from the form which the group frequently presents, a division takes place into four, and the number in a group is always either four or sixteen, a group of sixteen always dividing into four parts, each of which contains four monads.—The minute moving points often seen under the microscope are probably often not monads, but spores or germs.

MONADNOCK, GRAND, a mountain in the south-west corner of New Hampshire, United States of America, which from a base of 5 by 3 miles, rises to a height of 3450 feet. It is composed of talc, mica, and slate, can be seen from the State House at Boston, and is a landmark at sea. Thirty lakes, some containing numerous islands, can be seen from its summit.

MONAGHAN, an inland county of the province of Ulster, Ireland, situated between Tyrone on the N., Armagh and Louth on the E., Meath and Cavan on the S., and Fermanagh on the W. Its greatest length from north to south is 37 miles; its greatest breadth, east and west, is 23; the total area being 500 square miles, or 319,757 acres, of which 285,885 are arable. The population, which in 1851 was 141,523, had fallen in 1861 to 126,340; of whom 92,714 were Roman Catholics, 17,706 Protestants of the Established Church, 15,405 Presbyterians, and the rest Protestants of other denominations. The general surface is undulatory, the hills, except in the north-west and east, being of small elevation, although often abrupt; the highest point does not exceed 1254 feet above the sea. It is interspersed with lakes of small extent, and for the most part of little depth, and although the streams are numerous, there is no navigable river within its boundaries. In its geological structure, the level country belongs to the great central limestone district; the rest is of the same transition formation which is met with in the northern tract of Leinster. No minerals are found in a remunerative quantity; there is a small coal-field in the southern border, but it has not been found profitable to work. The soil is, as may be supposed, very varied in its character, and for the most part is wet and imperfectly drained, although commonly capable of much improvement; but in general it is found suitable for the production of cereal crops (with the exception of wheat, which is little cultivated), and of flax. The total area under crops in 1862 was 152,711 acres. The cattle in the same year numbered 68,865; sheep, 14,758; pigs, 21,696. The annual valuation of property was £260,137. M. is well supplied with good roads, and is connected by railway with Dublin, Belfast, and Galway, and directly with the coast at Dundalk. The principal towns are **MONAGHAN** (q. v.), Carrickmacross, Clones, and Castle-Blayney. It returns two members to parliament, the constituency being at the last enumeration 5121. M., at the Invasion, formed part of the grant of Henry II. to De Courcey, and was partially occupied by him; but it speedily fell back into the hands of the native chiefs of the sept MacMahon, by whom (with some alternations of re-conquest) it was held till the reign of Elizabeth, when it was erected into a shire. Even still, however, the authority of the English was in many places little more than nominal, especially in the north; and in the rising of 1641, the MacMahons again resumed the territorial sovereignty. The historical antiquities of the county are of little interest or

importance. It possesses two round towers, one very complete, at Clones, the other at Inniskeen; and there are many remains of the ancient earth-works commonly referred to the ante-English period. The number of children attending the national schools in M. during 1861 was 13,135, of whom 10,069 were Roman Catholics.

MONAGHAN, chief town of the county of the same name, is situated on the great north line from Dublin to Londonderry, distant from the former 78 miles north-north-west. Pop. in 1861, 3797, of whom 2668 were Roman Catholics, 773 Protestants of the Established Church, 306 Presbyterians, and the rest members of other denominations. M., before the Union, was a town of some importance, having a charter from James I., and returning two members to the Irish parliament. It is still the centre of an active inland trade, and can boast some public buildings of considerable pretensions, among which are the jail, market-house, and court-house. A Roman Catholic college and a cathedral (the latter only in progress) also deserve special notice.

MO'NARCHY (Gr. *monarchia*, from *monos*, alone, and *arché*, to govern; literally, the government of a single individual) is that form of government in a community by which one person exercises the sovereign authority. It is only when the king, or chief magistrate of the community, possesses the entire ruling power, that he is in the proper acceptation of the term a monarch. Most of the oriental governments past and present, Russia at present, and Spain and France as they were in the last century, are in this strict sense monarchies. The degenerate form of monarchy is tyranny, or government for the exclusive benefit of the ruler. When the head of the state, still possessing the status and dignity of royalty, shares the supreme power with a class of nobles, with a popular body, or with both, as in our own country, the government, though no longer in strictness monarchical, is called in popular language a mixed or limited monarchy, the term absolute monarchy being applied to a government properly monarchical. The highest ideal of government would perhaps be attained by an absolute monarchy, if there were any security for always possessing a thoroughly wise and good monarch; but this condition is obviously unattainable, and a bad despot has it in his power to inflict infinite evil. It therefore becomes desirable that a governing class, composed, if possible, of the wisest and most enlightened in the country, should share the supreme power with the sovereign. A limited monarchy has this advantage over an aristocratic republic, that in difficult crises of the nation's existence royalty becomes a neutral and guiding power, raised above the accidents and struggles of political life.

Monarchy, most usually hereditary, has sometimes been elective, a condition generally attended with feuds and distractions, as was the case in Poland. The elective system is still followed in the choice of the pope. Constitutional monarchy may be in its origin elective, or combine both systems, as when one family is disinherited, and the sceptre declared hereditary in the hands of another under certain conditions. See **KING, REPUBLIC**.

MO'NASTERY has been described under the head of **MONACHISM** (q. v.) as the generic name of the residence of any body of men, or even, though more rarely, of women, bound by monastic vows. It may be useful, however, to detail the various classes of monastic establishments of the Western Church, and to point out the leading characteristics of each. The name, in its most strict acceptation, is confined to the residences of monks, properly so called, or of

nuns of the cognate orders (as the Benedictine), and as such, it comprises two great classes, the *Abbey* and the *Priory*. The former name was given only to establishments of the highest rank, governed by an abbot, who was commonly assisted by a prior, sub-prior, and other minor functionaries. An abbey always included a church, and the English word *Minster*, although it has now lost its specific application, has its origin in the Saxon and German *Münster* (Lat. *monasterium*). A *Priory* supposed a less extensive and less numerous community. It was governed by a Prior, and was generally, although by no means uniformly, at least in later times, subject to the jurisdiction of an abbey. Many priories possessed extensive territorial domains, and of these, not a few became entirely independent. The distinction of abbey and priory is found equally among the Benedictine nuns. In the military orders, the name of *Commandery* and *Preceptory* corresponded with those of abbey and priory in the monastic orders. The establishments of the Mendicant, and, in general, of the modern orders, are sometimes, though less properly, called monasteries. Their more characteristic appellation is *Friary* or *Convent*, and they are commonly distinguished into *Professed Houses* (called also *Residences*), *Novitiates*, and *Colleges*, or *Scholastic Houses*. The names of the superiors of such houses differ in the different orders. The common name is *Rector*, but in some orders the superior is called *Guardian* (as in the Franciscan), or *Master*, *Major*, *Father Superior*, &c. The houses of females—except in the Benedictine or Cistercian orders—are called indifferently *Convent* and *Nunnery*, the head of which is styled *Mother Superior*, or *Reverend Mother*. The name *Cloister* properly means the enclosure; but it is popularly used to designate, sometimes the arcaded ambulatory which runs around the inner court of the building, sometimes, in the more general sense of the entire building, when it may be considered as synonymous with *Convent*.

MONASTIR (more correctly, **TOLI-MENASTER**, or **BITOLIA**), a town of European Turkey, eyalet of Rum-El, is situated in a broad valley of the Niji Mountains, 90 miles north-north-east of Janina, and about the same distance west-north-west of Saloniki. It is an important place, is the residence of the governor-general, and commands the routes between Macedonia and Northern Albania. The inhabitants are mostly Greeks and Bulgarians. M. has 11 mosques, and carries on a large trade with Constantinople, Saloniki, Vienna, and Trieste. From Constantinople alone it annually buys goods to the value of £1,500,000. Its bazaars, containing more than 2200 shops, are well stocked with the products of Western Europe and the colonies, as also with native manufactures. Yet it is one of the worst built and most tasteless towns in all Turkey. Pop. 40,000.

MONBODDO, JAMES BURNET, LORD, a Scottish lawyer and author, was born at Monboddo, in Kincardineshire, in 1714, educated at Marischal College, Aberdeen, where he displayed a great fondness for the Greek philosophers, and afterwards studied law for three years at Groningen, in Holland. In 1737, he became a member of the Scottish bar, and soon obtained considerable practice; but the first thing that brought him prominently into notice was his connection with the celebrated Douglas case, in which Mr Burnet acted as counsel for Mr Douglas. In 1767, he was raised to the bench by the title of Lord Monboddo. He died 26th May 1799. M.'s first work, on the *Origin and Progress of Language* (1771—1776), is a very learned, heretical, and eccentric production; yet in the midst of its grotesque

crotchets there occasionally flashes out a wonderfully acute observation, that makes one regret the distorted and misapplied talent of the author. The notion that men have sprung from monkeys, is perhaps that which is most commonly associated with the name of M., who gravely asserted that the orang-outangs are members of the human species, and that in the Bay of Bengal there exists a nation of human creatures with tails, and that we have only worn away ours by sitting on them, but that the stumps may still be felt. M. wrote another work, entitled *Ancient Metaphysics*, which was published only a few weeks before his death.

MONCADA, DON FRANCISCO DE, CONDE DE OSONA, an historian, and one of the Spanish classics, born 29th December 1586, at Valencia, where his grandfather was then viceroy. Descended from one of the greatest families of Catalonia, he rapidly rose to the highest offices in the state, was ambassador to Vienna, and latterly governor of the Netherlands, and commander-in-chief of the Spanish troops there. He distinguished himself both as a statesman and a soldier. He fell at the siege of Goch, a fortress in the duchy of Cleves, in 1635. His *Historia de la Expedicion de Catalones y Aragoneses contra Turcos y Griegos* (Barcelona, 1623, and frequently reprinted), is a master-piece in liveliness and elegance of style.

MONCALIERI, a town of Italy in the province of Turin, situated finely on the slope of a hill, on the right bank of the Po, five miles above Turin. Pop. 9129. M. is the first railway station between Turin and Genoa, and communicates daily with Turin by frequent omnibuses; it has fine buildings, including a palace lately embellished for the residence of King Victor Emmanuel. The annual cattle-fair held in October, at M., is the most important of the north of Italy.

MONDOVI, a town of Italy, chief town of the Sardinian province of same name, situated on the summit and shoulder of an Alpine hill, 50 miles south of Turin. It is divided into four sections: the Piazza—encircled by walls, and containing the chief buildings of the place, and the suburbs, Carassone, Breo, and Piano del Valle. In the neighbourhood, considerable activity exists in cloth, silk, and bonnet-straw manufactures; but in spite of vineyards and chestnut woods, the numerous remains of ruined buildings in its vicinity impart an air of desolation to the locality. The Piazza contains a fine cathedral, with rich paintings; an episcopal palace, with a noble gallery of portraits; and the various judicial and educational halls. Pop. (1851) 17,370. At the battle of M., on the 22d April 1796, the Sardinians were totally defeated by Bonaparte, and the entrance into Piedmont secured to the French army. The province of M. is intersected by spurs of the Alps, and contains rich marble quarries and valuable mineral products.

MONE'SIA BARK, the bark of a tree (*Chrysophyllum glycyphloeum*, or *C. Buranheim*), of the same genus with the Star Apple (q. v.), a native of the south of Brazil. The bark is lactescent; but when dried, it is thick, flat, compact, heavy, brown, and hard, with a taste at first sweet, afterwards astringent and bitter. A substance called *Monesia* is extracted from it, which is almost black, at first sweet, then astringent, and finally acrid. It is used as a stomachic and alterative in leucorrhœa, chronic diarrhœa, &c. It contains, in small quantity, a principle called *Monesin*.

MONEY, in Political Economy. This is a word in continual use all over the civilized world, and perhaps there is none the meaning of which in

connection with the business they have in hand is more distinctly understood by those who use it; and yet, on the other hand, there is none of which it is more difficult to give a comprehensive account or a strict definition. Presuming, then, that every one knows the practical use of the word in the affairs of common life, the best thing to be done here will be to point out a few distinctions which may tend to obviate confusion in the comprehensive use of the term as an element in economic science.

Money is often spoken of loosely as the same thing with capital; but they are different. Before anything is money, it must be such that you can go into the market and immediately use it in purchasing commodities or paying debts. The plant of a railway and the machinery of a mill, so long as they are in full use, are capital, and are capital which probably has once been money—but they are money no longer, because you cannot use them in making payments, though they have perhaps become more valuable than ever they were. The confusion of capital with money was the mistake made in issuing the French assignats on the security of the forfeited landed estates. Each assignat was a promise to pay; but when payment was demanded, it could not be made, because land was not a medium for making it. It is of the essence of money, then, that it is capable of making immediate payment either to satisfy a seller or a creditor. But an article may be money though it will not satisfy everybody; and articles available as money—even those most universally accepted as such—are available for other purposes. What we are familiar with as the most approved form of money—as the thing that will be most certainly received in payment all over the world—is coin of the precious metals. The reason why the claim of these is so universally accepted is, that they do not merely *represent* value, as we shall find other kinds of money do, but they *really* are value. If the dealer sells a hat for a sovereign, he knows that the sovereign does not depend, like a pound-note, on the solvency of the issuer, but that it has got value put into it by costing about as much labour and skill in bringing it into existence as the hat he gives for it. But even all coins perfectly available for money are not of the intrinsic value of their denomination. The silver for making 20 shillings is a good deal less valuable as a commodity than the gold in a sovereign; and in the same way, 240 pence, which are as money equal to a sovereign, only make a percentage of it in value as merchandise. The convenience of their use for small transactions makes up for depreciation in value of coins of the inferior metals, when gold is a standard; and to prevent incidental abuses, the law limits the extent to which they are a legal tender as good money.

Money transactions are distinguished from barter, in which one commodity is transferred for another, as where the shepherd, in primitive times, may be supposed to have given the agriculturist a sheep for a measure of corn. This distinction is extremely useful, since the invention of a circulating medium, which supersedes the narrow, cumbrous process of barter, by facilitating transactions of every variety of importance among all sorts of people, is a grand type of advance in civilisation. Like many other distinctions, however, it has not an absolute line of demarcation. The precious metals hold their value by their being commodities as well as being money, and coins are frequently used up for plate and jewellery. Where money is only available within one narrow region, its use verges on barter. In Central Africa, purchases are made and debts paid by strings of beads or coils of brass wire. An ivory merchant or a traveller will lay in a stock of these,

just as in Europe he would carry gold or circular notes. They are commodities, being used as ornaments by the inhabitants. But they are distributed to an extent far beyond the demand in this shape, and that they absolutely constitute money is shewn by this peculiarity in the case of beads, that a particular colour will pass current, and another will not; so that the merchant who chooses the wrong kind, though he have full value in merchandise, has not taken with him a supply of available cash.

Under the head of BULLION, it is shewn how the precious metals are an expensive form of money, which there is a temptation to supersede by paper-money. For the various opinions adopted by different classes of economists on paper-money, and the devices for getting over the great difficulty of rendering this kind of money secure, and equal in value to bullion, reference is made to the article CURRENCY. It may here be proper to state, that paper-money, or money founded on credit—one of the resources of advanced civilisation and complicated commerce—introduces a class of moneys so extensive and various, that it is impossible to mark the limits of its extent, or enumerate the shapes it may take. An attempt has been made to get rid of all difficulties by saying that a promise to pay is only the representative of money. But if it serve the purpose of buying or paying debt, it really is money. No one hesitates in counting a £5 Bank of England note as money. But a cheque by a person known to have a balance or credit at a solvent bank, is equally money; and though it is an order to pay, no actual bullion need ever be given for it, for the payment may be in notes, or the holder may hand it over to his own banker, in whose accounts it will be credited to the holder, and debited against the banker on whom it is drawn. The special difficulty as to paper-money is, that it may be mistaken for money when it is none, as in the case of a cheque not honoured by payment; or, that it may be of less intrinsic value than it professes to be, as when there is what is called an over-issue (see CURRENCY). There are thus great risks attached to the use of paper-money; but there are also risks specially applicable to bullion-money, as light weight, base coin, and the absence of those facilities for detection in theft or fraud, which are among the advantages of paper-money. The special risks attending the use of paper have been shewn in practice to be so capable of remedy by legislative precautions, that at present, in Scotland, one-pound notes are taken with less suspicion than sovereigns. On transactions in general, the chance of loss from forgery or insolvency is deemed less than the chances from light weight, even if the risk of base coinage should not come into consideration.

Making allowance for coins sent abroad or used as metal, the money of Britain is calculated at: gold, seventy millions; silver and copper, twelve millions; and notes, thirty-eight millions—in all, one hundred and twenty millions. But so large is the extent of paper-money, in the shape of drafts and bills, that of these payments, to the extent of more than two thousand millions in a year are settled at the London clearing-houses, or the establishments where the London banks, and those dealing with them, clear off their mutual obligations by paying over the balances.

MONGE, GASPARD, COMTE DE PÉLUSE, a French mathematician and physicist, was born of humble parentage at Beaune, in the department of Côte d'Or, 10th May 1746. When only fifteen, he went to study natural philosophy at the Oratorian College of Lyon, and afterwards obtained admission into the famous artillery school at Mézières, where

he invented the method known as 'Descriptive Geometry,' which was at first received with incredulity, but afterwards with avidity, and, for a time, jealously kept secret by the military authorities. In 1772, M. became tutor and professor at Mézières; in 1780, he was chosen a member of the French Academy; and in the same year, was called to Paris as Professor of Hydrodynamics at the Louvre. As a lecturer, he was precise, clear, and brief; his style was a model of scientific rigour, if not of literary elegance. During the heat of the Revolution, he became Minister of Marine, but after a few months resigned the office. He did not, however, retire into obscurity, but took charge of the great manufactories improvised for supplying the million of soldiers whom republican France had launched against her enemies, with arms and gunpowder. At this critical period, he shewed himself possessed of a genius equal to the occasion. He was everywhere, animating, ordering, counselling, and directing the patriotic artisans. Yet it is characteristic of the insane fanaticism that, for a time, got the upper hand in France, that M. himself only escaped the guillotine on account of his services being absolutely indispensable. After he had founded the *Ecole Polytechnique*, he was sent by the Directory to Italy, and intrusted with the transport of the artistic spoils of the republican armies. Here he formed a close friendship with Bonaparte, whom he followed to Egypt. He now undertook the management of the Egyptian Institute. During the expedition to Syria, he performed the greatest services to the government established at Alexandria. On his return to France, he resumed his functions as Professor in the *Ecole Polytechnique*, and, though his reverence for Napoleon continued unabated, he hotly opposed his aristocratic and dynastic views. The title of Comte de Péluze (Pelusium) was conferred on him by Napoleon, in memory of the Egyptian expedition. He died 28th July 1818. M.'s principal works are: *Traité Élémentaire de Statique* (7th edit. Paris, 1834); *Leçons de Géométrie Descriptive* (6th edit. Paris, 1837); and *Application de l'Analyse à la Géométrie des Surfaces du 1 et du 2 Degré* (4th edit. Paris, 1809). See Dupin's *Essai Historique sur les Services et les Travaux Scientifiques de Monge* (Paris, 1819).

MONGHYR, a city of India, capital of a district of the same name, is situated on the right bank of the Ganges, 30 miles west-north-west of Bhagulpur. It is a large and thriving town, and carries on extensive manufactures of hardware and firearms, which, however, are of very inferior quality. Owing to the salubrity of its climate, it is a favourite residence of invalid military men and their families. Pop. estimated at 30,000.—The district has an area of 2558 square miles, with a pop. estimated at 800,000.

MO'NGOLS, the name of a numerous and widely spread branch of the human family—the second in the classification of Blumenbach, and corresponding in almost every respect with the branch designated as Turanian by more recent ethnologists. See **TURIANS**. Under the designation of M. are included not only the Mongols Proper, but the Chinese and Indo-Chinese, Tibetans, Tartars of all kinds, Burmese, Siamese, Japanese, Esquimaux, Samoeds, Finns, Lapps, Turks, and even Magyars. Collectively, they are the great nomadic people of the earth, as distinguished from the Aryans, Semites, and Hamites; and are the same who, in remote antiquity, founded what is called the 'Median Empire' in Lower Chaldæa, an empire, according to Rawlinson, that flourished and fell between about 2458 and 2234 B.C.; that is, before Nineveh

became known as a great city. Thus early did some of these nomadic tribes, forsaking their original pastoral habits, assume the character of a nation. Another great offshoot from this stock founded an empire in China, the earliest date of which it is impossible to trace, but which certainly had reached a state of high civilisation at least 2000 years B.C. In early Greek history, they figure as Scythians, and in late Roman, as Huns, carrying terror and desolation over the civilised world. In the middle ages, they appear as Mongols, Tartars, and Turks. In the beginning of the 13th c., Genghis-Khan (q. v.), originally the chief of a small Mongol horde, conquered almost the whole of central and eastern Asia. His sons and grandsons were equally successful, and in 1240—1241, the Mongol empire extended from the sea-board of China to the frontiers of Germany and Poland, including Russia and Hungary, and the whole of Asia, with the exception of Asia Minor, Arabia, India and the Indo-Chinese states, and northern Siberia. This vast empire soon broke up into a number of independent kingdoms, from one of which, Turkestan, arose another tide of Mongol invasion under the guidance of Timûr or Tamerlane, who, in the latter part of the 14th c., reduced Turkestan, Persia, Hindustan, Asia Minor, and Georgia, under his sway, and broke, for a time, the Turkish power. On the death of his son Shah Rokh, the Mongol empire was subdivided, and finally absorbed by the Persians and Usbeks, but an offshoot of Timûr's family founded, in the 16th c., the great Mogul empire of Delhi. After the decline of Timûr's empire, the Turkish branch maintained the glory of the race, and spread terror to the very heart of Western Europe. In the 9th c., the Magyars, a tribe of Ugrians, also of Mongol extraction, under their leader Arpad, established themselves in Hungary, where, in process of time, they became converted to Christianity, and founded a kingdom famous in European history. See **TURKS** and **HUNGARY**.

The physical characteristics of the M. in their primitive state are thus described by Dr Latham in his *Descriptive Ethnology*: 'The face of the Mongolian is broad and flat. This is because the cheek-bones stand out laterally, and the nasal bones are depressed. The cheek-bones stand out laterally. They are not merely projecting, for this they might be without giving much breadth to the face, inasmuch as they might stand forward. . . . The distance between the eyes is great, the eyes themselves being oblique, and their caruncles being concealed. The eyebrows form a low and imperfect arch, black and scanty. The iris is dark, the cornea yellow. The complexion is tawny, the stature low. The ears are large, standing out from the head; the lips thick and fleshy rather than thin, the teeth somewhat oblique in their insertion, the forehead low and flat, and the hair lank and thin.' Of course, such a description as this cannot be understood as applying to the more civilised nations of Mongol origin, such as the Turks and Magyars, especially the latter, who, in physical appearance, differ but little, if at all, from other European nations.

In religion, the M. are, for the most part, Buddhists. There are among them, however, according to the different countries in which they reside, various other religions, as Confucianism, Taoism, fire-worship, paganism of different kinds, Mohammedanism, and Christianity. The Mongol languages, which are very numerous, are described by Dr Latham as being 'aptotic and agglutinate, rarely with true amalgamate inflection.' In 1859, according to an estimate formed by Professor Dieterici, the M. of all kinds amounted in number to as many as 528,000,000, or about half of the human race.

MONIMIA'CEÆ, a natural order of exogenous plants, consisting of trees and shrubs, with opposite leaves destitute of stipules; the bark and leaves having an aromatic fragrance. The flowers are unisexual. The perianth is somewhat globose, divided at the border sometimes into more rows than one. The stamens are numerous, and arise from and cover the whole interior of the tube of the perianth. There are several ovaries, each with one ovule. The fruit consists of several achænia, enclosed within the enlarged calyx. There are about 40 known species, natives chiefly of South America. A few are found in New Zealand and Australia. The fruit of the **BOLDU** (*Boldoa fragrans*), a shrub or small tree, a native of Chili, is eaten. It is a little drupe, about the size of a currant, extremely fragrant when dried.

MONITEUR, LE, a celebrated French journal, started by the publisher, Charles Joseph Panckoucke, 5th May 1789, under the title of the *Gazette Nationale, ou le Moniteur Universel*. After the crisis of the 10th August 1792, its importance as a daily register of the events which occurred during the dark days of the Revolution, immensely increased. Whoever wishes to obtain a complete view of the phenomena of the Reign of Terror, should consult Thuan-Grandville's *Gazette Nationale, ou le Moniteur Universel, commencé le 5th Mai 1789, précédé d'une Introduction historique contenant un Abrégé des anciens Etats-généraux, des Assemblées des Notables, et des principaux Evénements qui ont amené la Révolution* (1796). In 1800, it altered its form so far as to divide itself into two halves, of which the first contained the *Actes du Gouvernement*. This change imparted to the journal something of an official character. After January 1, 1811, it dropped the title of *Gazette Nationale*, retaining only that of *Moniteur Universel*. After the Restoration, it became the government organ, which it continued to be under Louis Philippe, and still is under Louis Napoléon.

MONITOR, a name given to many species of saurian reptiles, nearly allied to the true lizards, from which they differ in having no teeth on the

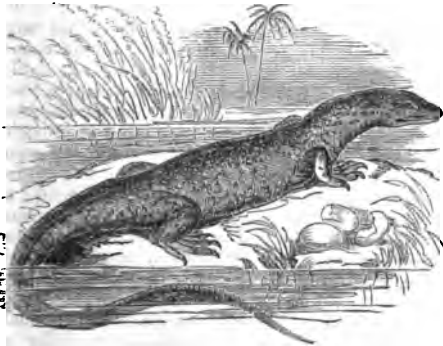

Monitor (*M. Niloticus*).

palate. Among them are some of large size, the largest of existing saurians except those of the crocodile tribe. The tail of the greater number is laterally compressed, the better to adapt them to aquatic habits. They receive the name M. from a notion that they give warning by a hissing sound of the approach of a crocodile or alligator. For the same reason, some of the American species receive the French name *Sauvegarde*. Those of the Old World form the family *Monitoriæ*, and those of America the family *Tetida* of some naturalists.

There are several genera of both.—The **M.** or **VARAN OF THE NILE** (*M. Niloticus*) is of a rather slender form, and has a long tail. It is olive gray, mottled with black. It attains a length of five or six feet. Crocodiles' eggs form part of its food. The **TEGUEXIN** (*Teguix Tegueixin*) of Brazil and Guiana is of similar size. It preys on aquatic animals. Other large species are plentiful in almost all tropical countries. They are powerful animals, have strong teeth, and defend themselves vigorously if attacked. Some comparatively small species, feeding chiefly on insects, are found in dry situations. Some of the large South American species are used for food, and their flesh is said to be excellent.

MONITORIAL SYSTEM, or **MUTUAL INSTRUCTION**. It first occurred to Dr Bell (q. v.), when superintendent of the Orphan Hospital, Madras, in 1795, to make use of the more advanced boys in the school to instruct the younger pupils. These youthful teachers were called **Monitors**. The method was eagerly adopted by Joseph Lancaster (q. v.) who, in the first years of this century, did so much for the extension of popular education; and from him and the originator, the system was called indifferently the Madras and the Lancastrian, as well as the Monitorial or Mutual System. The monitorial system is not, as is commonly supposed, a method of teaching; it is simply a method of organising schools, and of providing the necessary teaching power. At a time when the whole question of primary education was in its infancy, the state refusing to promote it on the ground that it was dangerous to society, and the public little disposed to contribute towards its extension, it was of great importance that a system should be adopted which should recommend itself as at once effectual and economical. It was manifest that even with the most skilful arrangement of classes, a single teacher could not undertake the tuition of more than 80 or 90 pupils; while, by the judicious employment of the cleverer boys under the general direction of the master, the school might be made almost self-working, and 300 or 400 children taught where there was only one adult superintendent. The novelty and economy of this plan, and we may add also, its temporary success, gained for it a large and enthusiastic support both in Britain and in Germany. But the importance of the system as an educational agency was universally over-rated, for although it is to be admitted that, under an able and enthusiastic master, boys may be inspired to teach well all technical and rote subjects (as, for example, in the Latin and Greek classes under Dr Pillans of the Edinburgh High School), yet it is manifest that children so instructed are not in any sense of the word educated. Their monitor necessarily lacks the maturity of mind which is indispensable to the instructor, whose business it is to arouse in the child those mental operations which have taken place within himself, and so lead him to an intelligent and rational grasp of intellectual and moral and physical truths. No amount of private instruction from the master, no enthusiasm could ever enable a boy to do this, and consequently the system broke down, after having done its work by being the engine whereby a large interest was stirred up in the education of the masses, and whereby the requisites of a primary teacher were brought into view. The reaction against the system, however, was not so violent in Great Britain or in Holland and France, as in Germany. In England, the monitorial system was modified in such a way as to secure for the master the aid of the more clever boys in teaching rote subjects, in revising lessons, keeping registers, and supervising the work of those classes not directly under

the master's tuition. In this way were afforded the means of training for the teaching profession boys who seemed fitted by natural endowment for the work. Hence the prevalent employment in this country of paid monitors and pupil-teachers (male and female), who are regularly apprenticed to school-managers and teachers, and go forward to be trained in the normal schools now so numerous.

MONK, GEORGE, Duke of Albemarle, was the son of Sir Thomas Monk of Potheridge, in Devonshire, and was born at his father's residence, 6th December 1608. He spent some of his earlier years in the service of Holland, returned to England when about the age of 30, and served in the king's army against the Scots in 1639, attaining the rank of lieutenant-colonel. On the breaking out of the Irish rebellion, in 1642, he was appointed colonel of Lord Leicester's troops, sent to crush it. When the civil war began, these troops were recalled, and M. was imprisoned on account of being supposed to favour the cause of the Parliament, but was soon after released. In 1644, he was defeated and taken prisoner by Fairfax, and imprisoned in the Tower, from which he was liberated, after two years, on his swearing the Covenant. Clarendon hints that he sold himself for money. He was now intrusted with the command in the north of Ireland. Cromwell had a high opinion of his military talents, and made him his lieutenant-general and commandant of artillery; and the service which he rendered at the battle of Dunbar was so great, that he was intrusted with the chief command in Scotland. In 1653, he was joined with Admiral Blake in an expedition against the Dutch, and with his division of the fleet, consisting of 100 ships, defeated Admiral Van Tromp off Nieuwpoort, and fought another battle with him off Katwijk, in which the victory was doubtful, but Van Tromp lost his life. In April 1654, Cromwell sent him to Scotland as governor, in which difficult office he conducted himself with vigour, moderation, and equity. Even the Highlands, those immemorial 'sanctuaries of plunder,' as Guizot calls them, were reduced to order. His principal residence was Dalkeith, where he spent his leisure hours in gardening, of which he was very fond. When, after Cromwell's death, he saw everything in confusion, and felt his own position perilous, he crossed the English border, 1st January 1660, with 6000 men, united his troops with those which Fairfax had collected for Charles II., and entered London unopposed, although as yet he kept his views profoundly secret. His powers of dissimulation and reticence were immense. Everybody felt that the decision lay with 'Old George,' as his soldiers used to call him; every party courted him; he was even offered the protectorate; but while he offended nobody, he declined to connect himself with any of the sectaries, and waited patiently the course of events. His own wish (though it did not proceed from any very high-minded motive) was to bring back the Stuarts; and before long, he saw that the nation in general was thoroughly with him. On the 21st of February he called together the remaining members of the parliament which had been violently driven out twelve years before, and Charles II. was presently recalled. M. was now made Duke of Albemarle, loaded with honours, and intrusted with the highest offices in the state. But he soon retired from political affairs. In 1665, when the plague ravaged London, and every one fled that could, 'Old George,' as governor of the City, bravely stuck to his post, and did what he could to allay the terror and confusion. Next year, he was employed as second in command of the fleet sent under the Duke of York

against the Dutch; and was defeated by Von Ruyter in a sea-fight off Dunkirk, but soon after gained a bloody victory over him off North Foreland. He died 3d January 1670. Guizot describes him as a 'man capable of great things, though he had no greatness of soul.' See Guizot's *Monk, Chute de la Republique*, Skinner's *Life of Monk*, Hallam's *Constitutional History*, and Macaulay's *History of England*.

MONKEY (*Simia*), a Linnæan genus of *Mammalia*, of the Linnæan order *Primates*, and of Cuvier's order *Quadrumana*, now constituting the family *Simiadae*. The word M. was formerly of almost, if not altogether, the same signification with *Ape*; but the name *ape* is now more generally applied to those *Simiadae* which have no tail, and no cheek-pouches; the name M. to those which have cheek-pouches and long tails, prehensile or not prehensile; whilst the name *Baboon* (q. v.) is applied to creatures considerably different from both. The smaller tailless *Simiadae* are, however, still not unfrequently spoken of as monkeys, and the term is also sometimes used to comprehend all the *Simiadae*.

Of all animals, the *Simiadae* exhibit the greatest resemblance to man, both in their general form and their anatomical structure. This is particularly the case with some of the larger apes. In none of them, however, is there a natural adaptation for the erect position so characteristic of man, which is assumed rarely, and in general only by captive individuals, as the result of training and constraint, all of the M. tribe preferring to walk on four feet rather than on two, but all of them being adapted for living chiefly among the branches of trees, or—according to the habits of a comparatively small number of species—among bushy cliffs, where they make use of the four extremities for prehension, as hands. Most of them leap from branch to branch with wonderful agility, and some also swing themselves from a branch by their long prehensile tail, till they can seize hold of another branch. The thumb, in all the four extremities, is opposable to the fingers, which are long and flexible; but there are some monkeys which want the thumb of the fore-limbs, or have it merely rudimentary, whilst the hind-limbs are always furnished with perfect hands. In attempting to walk erect, an ape necessarily treads, not on the soles, but on the sides of its feet, which are turned inwards, and the muscles of the legs do not enable it to maintain an erect position long or easily. This difficulty is increased by the way in which the head is affixed to the vertebral column, the *occipital foramen* being further back than in man, so that the weight of the head is thrown forward.—The face of a M. exhibits a grotesque resemblance to that of man; but the lower forehead, the less perfect nose, and the more projecting jaws, give it a brutal character. The dentition of monkeys is so similar to that of man, that the dental formula for very many is the same, although many others have an additional molar on each side of each jaw; but in many, the great size of the canine teeth is a marked brutal characteristic.—The digestive organs are generally very similar to those of man, but in some of the *Simiadae*, more exclusively confined to vegetable food, there is a remarkable difference in a peculiar and very complicated structure of the stomach.—The food of monkeys consists chiefly of fruits, corn, and other vegetable substances; but most of them also catch and eat insects, and even birds, of the eggs of which they are also very fond. In captivity, they learn to eat and drink almost everything that is used by man, and shew a great fondness for sweet things, and for alcoholic liquors.—The skin of monkeys is

MONKEY POTS—MONMOUTH.

generally covered in all parts with hair, but some have the face partially naked, and many have naked callosities on the buttocks.—Many have capacious cheek-pouches, in which they stow away food which they cannot consume with sufficient expedition. They are mostly gregarious, although to this there are some exceptions. Many of the species display strong attachment to their mates and to their offspring. One or two young are generally produced at a birth. They display a remarkable propensity and talent for imitation; and this, with their extreme agility, their curious prying disposition, and their love of trick or mischief, makes them very amusing, whether in a wild or a captive state. Many of the stories told of monkeys manifest also a high degree of intelligence, although it may be doubted if the intelligence of any of the species exceeds that of the dog or the elephant. Notwithstanding their resemblance to the human form, their imitative propensity, and their intelligence, none of the monkeys shew the smallest capacity for imitating the human voice; and their 'chattering' is very unlike articulate speech.

The species of this family are very numerous, but are all confined to the warm parts of the world; Australia, however, and the South Sea Islands being destitute of them. They are divided into a number of genera, some of which belong exclusively to particular portions of the world. But in this respect, the most remarkable circumstance is the difference between those of the Old World and those of America, the geographical distribution corresponding with the division of the family into two principal groups—the monkeys of the Old World (*Catarrhini* of some naturalists), to which alone the name *Simiadae* is sometimes restricted, having the nostrils separated only by a narrow septum, and the tail wanting, short, or long, but never prehensile; the monkeys of the New World (*Platyrrhini*), the family *Cebidae* of some naturalists, having the nostrils widely separated, the tail always long, and often prehensile, most of them having also the four additional molar teeth already noticed, which none of the monkeys of the Old World possess; but none of them having cheek-pouches, which many of the monkeys of the Old World have. The most interesting genera and species of M. are noticed in separate articles.

MONKEY POTS. See *LECYTHIDACEÆ*.

MONK'S-HOOD. See *ACONITE*.

MONK'S RHUBARB. See *DOCK*.

MONMOUTH, a parliamentary and municipal borough and market-town of England, capital of the county of the same name, stands amid beautiful scenery, at the confluence of the Monnow and the Wye, 21 miles west-south-west of Gloucester. Its church, dating from the 14th c., is surmounted by a beautiful spire. Of its castle, the favourite residence of John of Gaunt, and the birthplace of Henry V., the ruins only remain. Ironworks, employing a large number of workmen, are in operation. Pop. 5783. M. unites with Newport and Usk in sending a member to parliament.

MONMOUTH, a maritime county in the west of England, bounded on the S. by the estuary of the Severn and the Bristol Channel, and on the W. by the county of Glamorgan. Area, 368,399 acres. Pop. (1861) 174,633. The chief rivers are the Usk, the Wye on the eastern border, and the Rumney on the western border—all of which flow south into the estuary of the Severn and the Channel. The coast-line, 22 miles in length, is indented only at the mouth of the Usk, which is navigable for vessels of the largest size to Newport, the centre

of several converging lines of railway. The surface is elevated in the north and north-west (the Sugar Loaf is 1856 feet high), but the coast-districts, comprising the Wentloog and the Caldecot Levels, are low and flat, and are protected from the wash of the sea by sea-walls and earthworks. See **CHEESTOW**. In the fertile valleys of the Usk and Wye, wheat is the principal crop; but in the less favoured localities, barley and oats chiefly are grown. Coal, limestone, and ironstone abound in the mineral district of M., in the north-west of the county. This district, comprising 89,000 acres, abounds in collieries and ironworks.

The scenery of this county is unusually beautiful; and the remains of numerous feudal strongholds carry the mind back to the Norman period, and earlier. Indeed, in no part of England are to be found so many remains of feudal castles as in the eastern districts of this county. In one tract of 2200 acres, there were originally six castles, and there are still the remains of five. The most imposing of the secular ruins are Raglan, Caldecot, and White castles; and the chief ecclesiastical remains are the beautiful fragments of Llanthony and Tintern abbeys (q. v.).

MONMOUTH, JAMES, DUKE OF, natural son of Charles II., was born at Rotterdam in 1649. His mother, Lucy Walters, according to Evelyn, a 'browne, beautiful, bolde, but insipid creature,' came to England with her son in 1656, during the Commonwealth. She is said to have been treated as though she had been the king's wife, and was committed to the Tower; but was soon allowed to retire to France, where she died. Charles sought out the boy, and committed him to the care of Lord Crofts, who gave him his own name. On the Restoration, M., then 'Mr James Crofts,' came to England with the queen-dowager, and was handsomely lodged at Hampton Court and Whitehall. These honours were, in after-years, referred to by his followers as justifying their belief that he was indeed the king's legitimate son. A wealthy heiress, Anne, daughter of the Earl of Buccleuch, was selected for his wife; and before he had completed his 16th year, he was married to her, and was created Duke of Monmouth. About the year 1670, Shaftesbury put M. forward as the head of the popular party, and rival of the Duke of York (afterwards James II.). At the period of the Titus Oates' plot (1678), rumours that the 'Protestant Duke' was indeed the king's legitimate son spread far and wide. The Duke of York was compelled to quit the kingdom; and parliament brought forward a bill for excluding him from the succession, when Charles suddenly dissolved it. A document was at the same time issued by the king, solemnly declaring that he had never been married to Lucy Walters. M. was sent into Scotland, in 1679, to quell the rebellion. He defeated the Covenanters at Bothwell Bridge; but his humanity to the fleeing and wounded was so conspicuous, and his recommendations to pardon the prisoners were so urgent, as to bring upon him the violent censures of the king and Lauderdale. He thus became the idol of the English Nonconformists. The return of the Duke of York, and the exile of M., soon followed. In Holland, he allied himself to the leaders of the Nonconformist party, exiled like himself; and when he was allowed to return to London, he was received with such demonstrations of joy, that M. felt that he was the people's choice. In 1690, he made a semi-royal progress through the west of England, with the design, probably, of courting the Nonconformists, who were more numerous there than in any other part of the country, except London and Essex. In 1682, he traversed some of the northern counties.

The king and his brother were alarmed; and M. was arrested at Stafford, and bound over to keep the peace. He meekly confessed his participation in the Rye-House plot, accusing himself and others of a design to seize the king's person, and subvert his government. The king pardoned him, on his solemn promise to be a loyal subject to the Duke of York, in case the latter should survive the king. In 1684, M. fled to Antwerp, and remained abroad until the death of the king, when he resolved to embark for England. He landed (June 11, 1685) at Lyme-Regis, and issued a manifesto declaring James to be a murderer and usurper, charging him with introducing popery and arbitrary power, and asserting his own legitimacy and right by blood to be king of England. He was received with great acclamations at Taunton, where he was proclaimed as James II. At Frome, he heard the news of the defeat of Argyle, who, at the head of the Scottish exiles, had attempted to raise an insurrection in Scotland. Money and men were now abundant; but arms were wanting, and thousands went home for want of them. On the 5th July, he was persuaded, with only 2500 foot and 600 horse, to attack the king's forces, which, under the command of the Earl of Faversham, were encamped at Sedgemoor, near Bridgewater. M.'s troops were unable to cross a running stream or wide ditch which protected the camp, and were mowed down by the king's artillery. Their ammunition soon failed; and M. having set a cowardly example of flight, his troops were slaughtered like sheep. About 300 of M.'s followers fell in the battle; but 1000 were massacred in the pursuit. M. was found concealed in a ditch, and was brought to London. He made the most humiliating submissions, and obtained a personal interview with James. 'He clung,' says Macaulay, 'in agonies of supplications round the knees of the stern uncle he had wronged, and tasted a bitterness worse than that of death, the bitterness of knowing that he had humbled himself in vain.' Even his prayer for 'one day more,' that he might 'go out of the world as a Christian ought,' was brutally refused. On the 15th June, he was brought to the scaffold, and beheaded on Tower Hill; the executioner performing his office so unskillfully that five blows were struck before the head was severed. The 'Bloody Assize' afterwards commenced under Judge Jeffreys, when M.'s adherents paid a fearful penalty for their participation in his rash and ill-advised rebellion.

MONOCHORD, an apparatus constructed to exhibit the mathematical proportions of musical intervals. It consists of a flat board of four or eight feet long, better 16 feet, where space can be spared. The breadth of the board is according to the number of the strings, which are from two to six. The board is covered with fine white paper. A straight line is drawn from end to end below each string, and each line is accurately divided into the different proportions into which the full length of the string, as a fundamental sound, harmonically divides itself. See **HARMONICS**. The string is fixed at one end, and rests on a bridge; while at the other end, where it also rests on a bridge, it is stretched by a tuning-peg, or by a weight. The sounds from the strings are produced by a violin-bow. The monochord is chiefly used in illustrating acoustical experiments in the proportion of intervals and temperament.

MONOCOTYLEDONOUS PLANTS, plants in which the embryo has one and only one Cotyledon (q. v.). The cotyledon in these plants varies extremely in form, and is often comparatively of great size, but has always a slit, from which, as

germination takes place, the gemmule sprouts. The gemmule in elongating assumes an acuminated shape. Monocotyledonous plants are all Endogenous (q. v.); except the *Dictyogens* (q. v.), in which the endogenous structure is not perfectly exhibited. They are also *endorhizal* (Gr. *endon*, within, *rhiza*, a root); that is, the radicle is covered with a cellular sheath, and gives rise to fibrils similar to itself in structure. The leaves are generally sheathing at the base, and there embrace the stem; they also generally have simple parallel nerves connected by cross veins, the leaves of dictyogens alone being reticulated. The number of the parts of the flower is generally three, or a multiple of three. The floral envelope, often splendid, as in lilies, tulips, &c.—are generally united as a Perianth (q. v.), instead of forming a distinct calyx and corolla. The principal natural orders of monocotyledonous plants are Grasses, *Cyperaceæ*, Palms, Orchids, *Scitamineæ*, *Musaceæ*, *Liliaceæ*, and *Iridaceæ*. The general appearance of monocotyledonous plants distinguishes them almost as perfectly as any structural characters.

Of the fossil remains of the vegetable kingdom, the smallest portion consists of monocotyledonous plants, both acotyledonous and diocotyledonous plants being much more abundant.

MONODON. See NARWHAL.

MONŒCIOUS (Gr. *monos*, one, and *oikion*, a habitation), the term used in botany to describe those plants which have the male and female parts of fructification (*stamens* and *pistils*) in different flowers, but upon the same plant. The flowers of such plants are also said to be *monœcious*. Monœcious plants form one of the classes of the Linnæan artificial system, but many occasional instances of monœcious species are to be found in genera belonging to other classes. Monœcious plants often have the flowers in catkins, sometimes the male flowers only; and often in spikes, the male flowers sometimes occupying the upper, and sometimes the under part of the same spike with the female flowers, and sometimes distinct spikes upon the same plant. Common examples of monœcious plants are the hop, box, birch, beech, alder, oak, and hazel.

MONOGRAM (Gr. *monos*, alone, and *gramma*, letter), a character composed of two or more letters of the alphabet, often interlaced with other lines, and used as a cipher or abbreviation of a name. A perfect monogram is one in which all the letters of the word are to be traced. The use of monograms began at a very early date. They are found on Greek coins, medals, and seals, and are particularly numerous on the coins of Macedonia and Sicily. Both on coins and in MSS. it was the practice to represent the names of states and cities by monograms, of which above 500 are known, but some have not been deciphered. Monograms occur on the family coins of Rome, but not on the coins of the earlier Roman emperors. Constantine placed on his coins one of the earliest of Christian monograms, which is to be traced in the recesses of the catacombs, composed of the first and second letters of *XPISTVS* (Christus), a monogram which also appeared on the Labarum (q. v.), and was continued on the coins of the succeeding emperors of the East down to Alexander Comnenus and Theodorus Lascaris. We often find it combined with the first and last letters of the Greek alphabet (Rev. i. 8), as in Fig. 1. Another well-known monogram is that of the name of Jesus, IHS, from the first three letters of *IHSOUS*.

Popes, emperors, and kings of France during the middle ages were in the practice of using a monogram instead of signing their names. Almost all

the coins of the French kings of the Carolingian race bear their respective monograms, as also do those of Alfred and some of the other Saxon kings



Fig. 1.

of England. Fig. 2 represents that of Charlemagne, a perfect monogram, in which all the letters of *Karolus* can be traced.

Painters and engravers in Germany and Italy have used monograms to a large extent as a means of distinguishing their works.

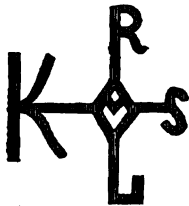

Fig. 2.

In these, the initial letters of their names were often interwoven with figures of a symbolical character, so as to form a rebus on the artist's name. Fig. 3 is the monogram of Albert Dürer; Fig. 4, of Ludger zum Ring. The first typographers distinguished their publications by wood-cut vignettes, whose invention is ascribed to the elder Aldus;

but besides these, each made use of a monogram or cipher, a series of which, well known to the bibliographer, fixes the identity of the ancient editions, German, Italian, and English, from the



Fig. 3.



Fig. 4.



Fig. 5.



Fig. 6.

invention of printing down to the middle or end of the 16th century. Fig. 5 is the monogram of Andrea Turreasano d'Asola, father-in-law of Aldus Manutius; Fig. 6, of Luca Antonio Giunta, a celebrated printer of Venice between 1489 and 1500;



Fig. 7.

Fig. 7, of William Caxton. For a detailed account of the monograms of early printers and others, see Brulliot, *Dictionnaire des Monogrammes* (Munich, 1832—1834); Horne's *Introduction to Bibliography*, vol. ii.; and Herbert's and Ames's *Typographical Antiquities*.

MONOGRAPH, a work in which a particular subject in any science is treated by itself, and forms the whole subject of the work. Monographs are entirely of recent date, and have contributed much to the progress of science. In botany especially, monographs of orders and genera are very numerous; and some of them are among the most splendid and sumptuous of scientific works.

MONOLITH, a monument, column, obelisk, statue, or other structure formed of a single stone. In India, there are examples of monolithic temples, the whole being cut out of the solid rock.

MONOMANIA has loosely been made to represent every form of partial insanity; but has been more rigidly defined as that mental condition in which a single faculty, or class of faculties or associations, become diseased, the mind generally remaining healthy. Slight and solitary aberrations, such as where a savage antipathy to cats coexists with a love for human kind; where there appears to be an uncontrollable tendency to steal, to squander, to drink, to destroy, are of common occurrence, and are supposed to be compatible with the exercise of intelligence, and with the discharge of many of the ordinary duties of life. By a more strict limitation, the term has been confined to such affections as involve the emotions and propensities alone. It is, however, held that, notwithstanding its apparent integrity, the whole mind is involved or influenced by the presence of such morbid conditions, at least while they are predominant. It is undoubtedly difficult to point out in what manner the belief, e. g., that a particular organ has been transmuted into glass, can interfere with or render the memory, or the power of instituting comparisons, defective and untrustworthy; yet it is legitimate to receive with caution every manifestation of powers so constituted that they fail to detect the incongruities and absurdities with which they are associated; or, having detected the real character of these errors, are unable or unwilling to cast them out, or to disregard them. There is much countenance given to this theory by facts which indicate that even trivial forms of mental obliquity are connected with an unsound organisation; and that particular and rarely recognised monomanias are invariably associated with the same structural alteration. The unhealthy elevation of the sentiment of cautiousness, for example, especially where it amounts to fear of death, panic, or panphobia, is a symptom of disease of the heart and large blood-vessels; while the monomania of ambition, or optimism, as it has been styled, is the concomitant of the general paralysis of the insane. It will be obvious, from the definitions previously introduced, that the species or varieties of monomania must correspond to the faculties or phases of the human mind, and to their combinations. Several great divisions, however, have been signalled, both on account of their frequency and of their influence upon the individual and upon society. 1. Monomania of Suspicion, comprehending doubts in the fidelity and honesty of friends and those around, belief in plots and conspiracies, the dread of poison; and where, as is often the case, it is conjoined with cunning, the propensity to conceal, mystify, and deceive. This malady has frequently been observed in intimate connection with cancer and malignant growths. 2. Monomania of Superstition and Unseen Agencies, where credulity, mingled with religious awe, peoples the external world with spectres, omens, mysteries, magnetism; and the imagination with horrors or ecstatic reveries. Insensibility to pain, or indifference to external injuries, has been observed as a characteristic of individuals affected with this disease. 3. Monomania of Vanity, or Euphoria, where display and ostentation are indulged, without reference to the position and means of the patient. 4. Monomania of Fear. 5. Monomania of Pride and Ambition. 6. Kleptomania (q. v.). 7. Dipsomania (q. v.). If it can be proved that such morbid tendencies, as have been here mentioned, and others still less prominent, are merely salient points of a great breadth and depth of mental disease, the plea of insanity may justifiably be employed more frequently in the consideration of criminal acts.—Esquirol, *La Monomanie*; Bayle, *Maladies du Cerveau*; Stephens's *Criminal Law of England*, p. 92.

MONONGAHE'LA, a river which rises in the Alleghany Mountains in Virginia, United States of America, and flowing north into Pennsylvania, unites with the Alleghany at Pittsburg to form the Ohio. Its whole length is 300 miles. It is navigable for steam-boats to Brownsville, 60 miles, with dams and locks for low water. Vast seams of coal open in its high banks, from which flat boats are loaded, and floated down with the current through the Ohio and Mississippi.

MONOPE'TRAL, a temple formed of an open circle of columns carrying a roof, and without a cell.

MONO'PHYSITES, the name given to a widely ramified sect of Christians who hold that Christ has only *one* nature (Gr. *monos*, one; *physis*, nature), a human nature become divine. Monophysite views were first decidedly put forward in the controversy against Nestorius. Cyril having expressed the opinion that the flesh of the Logos was essential to his personality, the archimandrite Eutyches (q. v.) went on to assert a deification or apotheosis of the flesh of Christ, and obtained the consent of a synod at Ephesus, in 449, commonly called the 'Synod of Robbers,' to this doctrine; but he and his adherents (at first called after him **EUTYCHIAN**s) were condemned as heretics by the Council of Chalcedon in 451. It was after this council that the name *Monophysites* began to be used. The decision of the council, however—viz. that in Christ *two* natures, neither interfused, changed, nor divided, were united in *one* person, and constituted *one* hypostasis—was not calculated to allay, but rather to increase discord. Accordingly, the strife grew hotter. The Asiatic and Egyptian clergy, strongly opposed to Nestorianism, were generally inclined to Monophysite views, and received countenance from the Emperor Basiliscus. After long, and often bloody contests between the supporters of the opposite opinions, the *M.* formally separated from the orthodox church. This separation took place in the first half of the 6th c., when the imperial protection hitherto bestowed upon them was lost by the alliance of the emperors Justin and Justinian with the Latin Church. Besides, they had not maintained unity among themselves. As early as 482, when the Emperor Zeno published his famous *Henoticon*, or formula of concord, it was accepted by several of the more moderate Monophysites. This roused the indignation of the extremer sectaries; they renounced fellowship with their laxer brethren, and formed a sect of their own. They were called *Akephalo*i, and formed the *ultras* among the Monophysites. Controversies arose also in 519 on the question, whether or not the body of Christ was corruptible. The Severians—adherents of Severus, a deposed bishop of Antioch—affirmed that it was; the Julianists, or Gajanites, followers of Bishop Julianus or Gajanus, denied it. The former were consequently called (Gr.) *Phthartolatri*st, (Lat.) *Corrupticol*e (Worshippers of the corrupt); the latter, *Aphthartodocet*e (Believers or Teachers of Incorruption), and sometimes—as an incorruptible body could only be apparent, and not real—*Phantasi*ast. The *Aphthartodocet*es split again on this other point—whether or not Christ's body was created; the *Aktisteto*i (Gr. *ktizo*, to create) asserting that it was not created, and the *Ktistolatri*st, that it *was*. The Severians, called also, after one of their bishops, *Theodosians*, finally got the upper hand, and excommunicated their opponents, including another sect, the *Agnosto*i, who denied that Christ as a man was omniscient. About 560, the Monophysite Askunages, and after him the Christian philosopher Philoponus, ventured to speak of the Three Persons in the Godhead as Three Gods. This,

however, was reckoned heretical even by the *M.* themselves, and was the occasion of a large recession to the bosom of the Catholic Church. Monophysite communities continued strongest in Egypt, Syria, and Mesopotamia, where they maintained a regular ecclesiastical order under their own patriarchs of Alexandria and Antioch; and after the Syrian, Jakob Baradaeus (Al-Barada'i, died about 578), had drawn up for them an ecclesiastical constitution, they formed the independent churches of the *Jacobites* (q. v.) and *Armenians*. See **ARMENIAN CHURCH**. The Coptic and Abyssinian churches are also Monophysite in doctrine.

MONO'POLI, a town of the Neapolitan province Terra di Bari, situated on the Adriatic shore, in a pleasant and healthy plain, 28 miles east-south-east of Bari. Pop. 16,000. It is supposed to be of Grecian origin, the name in Greek signifying *the solitary city*. It is surrounded by walls, and has a fortress constructed in 1552 by Charles V. The neighbouring territory yields an immense quantity of olive oil.

MONO'POLY, from the Greek, signifies sole selling or individual selling, and has always been used to express a limitation to one or more persons of the right or power to conduct business as a trader. It is generally used in a bad sense to express something injurious, but economic science has lately very much narrowed the field over which its injurious character is supposed to extend. In the first place, it must be created by force; if it come in the natural course of trade, it is generally beneficial. Thus, to a village where three or four traders have conducted a small lazy business, drawing large profits, there comes a capitalist, who sets up a large concern on the ready-money system, and, by selling good articles at a low rate, absorbs all the business. He is of course abused as a monopolist by the ineffective persons he has superseded; but his presence is a blessing to the community generally. If, however, he had gone to the village, not to compete with others, but with a royal patent in his pocket securing to him the exclusive trade of the village, as he could sell at his own price, and make a fortune without trouble, he would of course be, like the old royal monopolists, a calamity to the people.

A careful distinction must be preserved between monopoly and property—that is to say, an exclusive right to *trade* must be separated from an exclusive right to *possess*—for, while the law of property exists, possession will always be exclusive. If, then, a trade can only be conducted with large capital, it must fall to those who either singly, or by co-operation, can command that capital; and the answer to all complaints on the part of others is, that since capitalists can best serve the public, it is best for the public that capitalists should be allowed to do so. The old corn-laws and landed property conjoined to produce one of the best illustrations of the distinction. The power of producing grain within Britain has always been of necessity limited to those who have, either as owners or tenants, the command of the land. Forfeit all the land in the country to-morrow, and proclaim the production of grain to be free, the result would only be a change of ownership; for those who by their good-luck, or more probably by their power, got hold of rich old wheat-lands, would produce their grain much cheaper than those who got the poor lands, and, selling the produce at the same price, would pocket the difference, which would, in fact, just be rent gained by them as the new landlords. But when dealers offered the people grain from abroad, and the corn-laws rendered it impossible to sell that grain in this country, then there was a monopoly in favour of the home-producer, having the effect of

artificially raising prices, and otherwise disturbing trade.

A deal of legislation was wasted by our ancestors in enactments to prohibit people from creating monopolies by that fair competition which is now considered the true healthy development of trade. Some account of them and of their repeal will be found in the article ENCROSSING. When British trade was increasing in the 16th c., it found some old powers alleged to be inherent in the royal prerogative for conferring exclusive trading rights, which led to much oppression and loss. In Queen Elizabeth's parliament of 1597, a complaint was made that, for the benefit of favoured courtiers, oppressive monopolies had been granted, not only for the sale of foreign luxuries, but for salt, leather, coal, and other articles of ordinary consumption. Queen Elizabeth said she 'hoped her dutiful and loving subjects would not take away her prerogative, which is the choicest flower in her garden, and the principal and head pearl in her crown and diadem.' Parliament returned to the charge, however, in 1601, when, on the reading over of the list of monopolies, a theatrical scene occurred by a member calling out: 'Is not bread among the number?' and on this producing a sensation, continuing: 'Nay, if no remedy is found, bread will be there before the next parliament.' In 1621, parliament took proceedings against Sir Giles Mompesson, charged with an oppressive use of his patent's monopoly. Four years afterwards, an act was passed limiting this power in the crown. It leaves only the right to grant a limited monopoly in the manufacture of his invention to any inventor, and this is the origin of the present patent law. See PATENT.

MONOSTOMA, a genus of Trematoid worms, so called from having only a single sucker, which is situated anteriorly, and surrounds the mouth. It belongs to the *Trematoda Digenea* (of Van Beneden), all of which present the phenomena of alternation of generations, the earlier or larval forms occurring chiefly in molluscs, while the perfect worms are found, for the most part, in vertebrated animals. Among the species of this genus occur *M. flavum*, found in waterfowl (the larva being the *Cercaria ephemera*, which is common in *Planorbis*, &c.), *M. mutabile*, found in various birds, and *M. lentis*. The last-named species derives its specific name from its having been found by Von Nordmann in a lens extracted in a case of cataract. Cobbold and other distinguished helminthologists are inclined to believe that this is not an independent species, but that it is identical with the *Distoma ophthalmiobium* of Diesing.

MONOTHEISM, the term usually employed to denote a belief in the numerical unity (*unus numero*) of the Godhead, or belief in and worship of one God. It is thus the opposite of *Polytheism* (q. v.). See God. The 'doctrine of the Trinity' is thought by some to be incompatible with the monotheism taught by Jesus Christ, and is therefore rejected as no part of his teaching. See UNITARIANS. Mohammedans and Jews hold the doctrine of the 'unity of God,' even more rigorously in some respects than modern Christians, at least they reject with vehemence the least approach to a Trinitarian conception of the Deity. The rest of mankind are polytheists.

MONOTHELISM (Gr. *monos*, single, and *thelema*, will), a modification of Eutychnianism (q. v.), which was introduced after the condemnation of that doctrine by the Council of Chalcedon. It consisted in maintaining that, although Christ had two natures, yet, these natures possessed or acted by but a single will, the human will being merged in the

divine, or absorbed by it. The author, or at least the most active propagandist of this doctrine, was Sergius, Patriarch of Constantinople, who obtained for it the support of the Emperor Heraclius; and its progress was materially forwarded by the silence which, at the instance of Sergius, and under his representations, the pope, Honorius (q. v.), was induced to maintain regarding the question. The doctrine was formally condemned in the sixth general council held at Constantinople in the year 680, with which condemnation it is commonly said that the early controversies on the incarnation were brought to a close.

MONOTREMATA (Gr. *monos*, single, *trēma*, an opening), the lowest order of mammalia, in many of their characteristic points indicate an approximation to birds. The skull is smooth; the brain-case very small as compared to the face; the snout much prolonged, and the jaws unprovided with soft movable lips, and not furnished with teeth. (In the ornithorhynchus, there are two horny plates in each half-jaw, which act as teeth, while in the echidna even these substitutes for teeth are wanting.) The cranial bones coalesce, as a bird's, at a very early period, and leave no signs of sutures. The external ear is altogether absent; while the eyes, though small, are perfectly developed.

The bones of the shoulder, forming the scapular arch, are unlike those of any other mammals, and in some respects resemble those of birds, and in other respects those of reptiles. At the top of the sternum is a T-shaped bone, formed by the union of the two clavicles, corresponding to the *furculum* in the bird's skeleton. The coracoid bones, which in other mammals are mere processes of the scapula, are here extremely large, and assist, as in birds, in

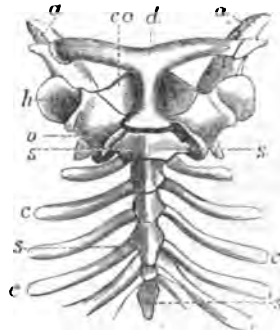

Monotremata:

The breast-bone and collar-bone of the Echidna.

(From Milne Edward's *Zoology*.)

a, acromi or process of scapula; *d*, bone corresponding to the usual collar-bones of mammals; *h*, cavity for the articulation of the head of the humerus; *o*, the prolongation of the scapula to the sternum; *co*, the coracoid bone; *s*, the sternum; *c*, ribs.

strengthening the scapular arch; while the scapulae themselves are produced beyond the socket of the humerus (the glenoid cavity), so as to articulate with the sternum.

The pelvis is provided with marsupial bones, although these animals do not possess a pouch.

The feet have five toes, armed with long nails; in addition to which, the hind-feet of the males are provided with a perforated spur-like weapon, which is connected with a gland. The Australian aborigines believe the wounds made by this spur to be poisonous; but there is no scientific evidence of the fact.

The ovaries are analogous to those of birds, the

MONOTROPACEÆ—MONROE.

right ovary being comparatively undeveloped, while the left forms a racemiform mass. The orifices of the urinary canals, the intestinal canal, and the generative canal, open, as in birds, into a common cloaca, from which circumstance the order *monotremata* derives its name. The mammary glands, of which there is only one on each side, are not provided with nipples, but open by simple slits on each side of the abdomen.

This order includes only two or three species, all natives of Australia or Van Diemen's Land, which, however, form two families—the *Ornithorhynchidae* (see DUCK-BILL), and the *Echidnidae* (see ECHIDNA).

No fossil remains of any animals of this order have as yet been discovered.

MONOTROPACEÆ, a small natural order of exogenous plants, allied to *Ericaceæ* and *Pyrolaceæ*; but remarkably differing from both in their habit. They are herbaceous plants with scales instead of leaves, and grow parasitically on the roots of pines and other trees, in the northern parts of the world. The only British species is *Monotropa hypopitys*, sometimes called *Yellow Bird's Nest*. The whole plant has a pleasant smell.

MONREALÉ, a city of the island of Sicily, province of Palermo, and 5 miles south-west of the city of that name, on the flank of a steep hill. Pop. 14,000. It has a cathedral, a palace, several conventual establishments, and possesses a healthy climate. Its chief source of wealth is its export trade in oil, corn, and fruit, almonds being one of its most important products.

MONRO, ALEXANDER, an eminent anatomist, and founder of the medical school of Edinburgh, styled *primus* to distinguish him from his son and successor, was born at London, September 8, 1697. His grandfather, Sir Alexander Monro of Bearcrofts, a colonel in the army of Charles II. at the battle of Worcester in 1651, was afterwards an advocate at the Scottish bar; and his father, John Monro, for some years a surgeon in the army of King William in Flanders, on leaving it, entered into practice in Edinburgh. Alexander studied at London under Cheselden, at Paris under Bouquet, and at Leyden under Boerhaave, and in 1719 passed as a surgeon at Edinburgh. In January 1720, he was elected by the town-council first Professor of Anatomy in the university. Of the establishment and building of the Royal Infirmary of Edinburgh, he was one of the two principal promoters, and after it was opened, he delivered clinical lectures there for the benefit of the students. In January 1756, he received the degree of M.D., and in March following was elected a Fellow of the Royal College of Physicians of Edinburgh. In 1759, he resigned the anatomical chair to his youngest son, the subject of the following notice, but continued his clinical lectures at the Infirmary. His principal works are—*Osteology, or Treatise on the Anatomy of the Bones* (Edin. 1726, 8vo); *Essay on Comparative Anatomy* (Lond. 1744, 8vo); *Observations, Anatomical and Physiological* (Edin. 1758, 8vo); and an *Account of the Success of Inoculation of Small-pox in Scotland* (Edin. 1765, 8vo). He was secretary of a Society at Edinburgh, which published six volumes of *Medical Essays and Observations*, many of them contributed by himself. Two more volumes of *Essays, Physical and Literary*, were subsequently issued by the same Society, under the name of the Philosophical Society. Dr M. died July 10, 1767. He was a Fellow of the Royal Society of London, and a member of the Royal Academy of Surgery of Paris.

MONRO, ALEXANDER, secundus, an eminent physician and medical professor, youngest son of

the preceding, was born at Edinburgh, March 24, 1733. He studied at the university of that city; and in October 1755, obtained the degree of M.D. In July following, he was appointed joint Professor of Anatomy and Surgery with his father in the university of Edinburgh. He attended for some time the anatomical lectures of Professor Meckell at the university of Berlin. He also visited Leyden. Admitted a licentiate of the Edinburgh Royal College of Physicians, 1758, he was elected a Fellow, 1759, and was afterwards president. On the resignation of his father in the latter year, he became full Professor of Anatomy, and also succeeded him as Secretary of the Philosophical Society, which in 1783 was incorporated by royal charter, and took the name of the Royal Society of Edinburgh. In 1757, he published at Berlin a short treatise, *De Venis Lymphaticis Valvulosis*, in support of the theory, that the valvular lymphatics over the whole of the animal body are one general system of absorbents; which led to a controversy with Dr William Hunter of London. Among his other works are—*On the Structure and Functions of the Nervous System*, a large illustrated folio volume (Edin. 1783); *On the Structure and Physiology of Fishes*, also an illustrated folio volume (Edin. 1785); *Description of all the Bursæ Mucosæ of the Human Body* (Edin. 1788); and *Three Treatises on the Brain, the Eye, and the Ear*, illustrated by plates (Edin. 1797, 4to). He was a member of the Royal Academies of Paris, Madrid, Berlin, Moscow, and other learned institutions, and one of the first Fellows of the Royal Society of Edinburgh, to whose *Transactions* he contributed various papers. In 1798, his son, Dr Alexander Monro, *tertius*, was conjoined with him in the professorship; and in 1808 he finally retired from the anatomical chair, and from his extensive practice. He died October 2, 1817, in his 87th year.

MONRO, ALEXANDER, tertius, anatomical professor, son of Dr Alexander Monro, *secundus*, born at Edinburgh, November 5, 1773, was educated at the High School and university of that city, and studied medicine, anatomy, and surgery in London. In 1798, he became joint Professor of Anatomy with his father, and the following year he took his degree of M.D. In 1803, he instituted the class of Practical Anatomy in the university of Edinburgh; and in 1808 he succeeded his father in the anatomical chair. In 1828, he was President of the Royal College of Physicians of Edinburgh; and he contributed many valuable papers to its *Transactions*. He was also a Fellow of the Royal Society of Edinburgh. He retired from his chair in 1847, with the title of Emeritus Professor of Anatomy; and thus ended the connection between the college of Edinburgh and the family of Monro, which lasted for more than a century and a quarter. He died at his seat of Craiglockart, near Edinburgh, March 10, 1859. He was the author of *Observations on Crural Hernia*, plates (Edin. 1803); *The Morbid Anatomy of the Gullet, Stomach, and Intestines*, plates (Edin. 1811); *Outlines of the Anatomy of the Human Body* (4 vols. 8vo, Edin. 1813); and other professional works.

MONROE, a city of Michigan, United States of America, is situated on the river Raisin, 2 miles from Lake Erie, and 40 miles south-west of Detroit. It is the eastern terminus of the Michigan Southern Railway. It has a large court-house, 10 churches, woollen manufactures, flour-mills, &c. Pop. about 5000.

MONROE, JAMES, fifth president of the United States of America, was born in Westmoreland County, Virginia, April 28, 1758. He was descended

from a Captain Monroe of the army of Charles L. who emigrated, with other Cavaliers, to Virginia. James M. entered the revolutionary army at the age of 18, as a cadet, and was present at several battles; but having lost his rank in the army by serving as aide-de-camp, he commenced to study law with Jefferson. In 1782, he was elected to the Assembly of Virginia, and at the age of 23, to the Executive Council. Next year he was elected to Congress, where he took an active part in the movements for framing a new constitution. He joined with Patrick Henry and other leading States' Rights men in opposing the ratification. He feared the power and encroachment of the Federal government. He was afterwards sent by Washington as minister to France, and was received with singular enthusiasm by the revolutionary government. He was, however, soon recalled, for having too decided French sympathies. In 1799, he was elected governor of Virginia; and in 1803 sent by Jefferson as minister to France, to purchase Louisiana, which vast territory he secured for 15,000,000 dollars. He was now employed for several years in diplomacy in England and Spain. On the election of Mr Madison to the presidency, he was made Secretary of State, and also performed the duties of Secretary of War. In 1816, his eminent services were rewarded by his being elected President of the United States by the Democratic Republican party, and he made himself very popular. The acquisition of Florida from Spain, and the settlement of the vexed question respecting the extension of slavery by the Missouri Compromise, by which, after the reception of Missouri as a slave state, the institution was prohibited above the line of latitude 36° 30', helped to secure his re-election in 1820. His most popular acts, perhaps, were the recognition of the independence of Mexico and the South American republics, and the promulgation of what has since been called the 'Monroe Doctrine,' in which he declared the American policy of 'neither entangling ourselves in the broils of Europe, nor suffering the powers of the Old World to interfere with the affairs of the New,' and that 'any attempt to extend their system to any portion of this hemisphere, would be dangerous to our peace and safety.' In 1825, he retired to his seat at Oak Hill, Loudoun County, Virginia; but he still continued in the public service. After being twice president, he acted as justice of the peace, a visitor of the university of Virginia, and member of a State Convention; but a profuse generosity and hospitality caused him to be overwhelmed with debt, and he found refuge with his relations in New York, where he died in 1831—like his predecessors, Adams and Jefferson, on the 4th of July. He was an honourable and able statesman, though not a speaker or a man of brilliant talents.

MONS (*Elem. Berghen*), an important fortified town of Belgium, capital of the province of Hainault, on the Trouille, 35 miles south-west of Brussels. Its fortifications have been renewed and strengthened since 1818. The immediate vicinity can be laid under water by altering the course of the Trouille. The *Canal de Condé* connects the town with the Scheldt, and there is communication by railway with Brussels, Valenciennes, Charleroi, Namur, and Tournay. Its principal architectural ornament is the cathedral of St Waudru, dating from the 15th and 16th centuries—a master-piece of Gothic. M. is surrounded by walls pierced by five gates. The chief manufactures are woollen and cotton goods, cutlery, small-wares, and sugar-refining. The vicinity forms an extensive coal-field, in which 400 pits, giving employment to upwards of 26,000 hands, are worked. A large trade is carried on in coals, flax, hemp, horses, and cattle. Pop. 26,660.

M., supposed to occupy the site of a Roman station, was made the capital of Hainault by Charlemagne in 804. During the 17th and 18th centuries, it was frequently the object of contest between France and Austria.

MONSOON'N (Malayan, *Musim*) is derived from the Arabic word *Mausim*, a set time or season of the year, and is applied to those winds prevailing in the Indian Ocean which blow from the south-west from April to October, and from the opposite direction, or north-east, from October to April. The existence of these winds was made known to the Greeks during the Indian expeditions of Alexander, and by this knowledge, Hippalus was emboldened to sail across the open sea to Muzeris, the emporium of Malabar. The monsoons depend, in common with all winds whether regular or irregular, on the inequality of heat at different places and the earth's rotation on its axis; but more particularly they are occasioned by the same circumstances which produce the trade-winds and the land and sea breezes, being, in fact, the combined effect of these two sets of causes.

If the equatorial regions of the earth were entirely covered with water, the trade-winds (see **TRADE-WINDS**) would blow constantly from the north-east in the north, and from the south-east in the south of the torrid zone, with a belt of variable winds and calms interposed; the whole system, following the sun's course, moving northward from December to June, and southward from June to December. But, especially in the eastern hemisphere, large tracts of land stretch into the tropics, and give rise to the extensive atmospheric disturbances for which those parts of the earth are so remarkable. During the summer half of the year, the north of Africa and the south of Asia are heated to a higher degree than the Indian Ocean, while Australia and South Africa are much colder. As the heated air of Southern Asia expands and rises, and the colder air from the south flows in to supply its place, a general movement of the atmosphere of the Indian Ocean sets in towards the north, thus giving a *southerly* direction to the wind; but as the air comes from those parts of the globe which revolve quicker to those which revolve more slowly, an easterly direction will be communicated to the wind; and the combination of these two directions results in the south-west monsoon, which prevails there in summer. Since, during winter, South Asia is colder than the Indian Ocean, which, again, in its turn, is colder than South Africa, a general motion of the atmosphere sets in towards the south and west. As this is in the same direction as the ordinary trade-wind, the effect in winter is not to change the direction, but only to increase the velocity of the trade-wind. Thus, while south of the equator, owing to the absence of sufficiently large tracts of land, the south-east trade-winds prevail throughout the year; on the north of the equator we find the south-west monsoon in summer, and the north-east in winter; it being only in summer and north of the equator that great changes are effected in the direction of the trade-wind.

Similar, though less strongly-marked monsoons prevail off the coasts of Upper Guinea in Africa, and Mexico in America. The east and west direction of the shores of these countries, or the large heated surfaces to the north of the seas which wash their coasts, produce, precisely as in the case of South Asia, a south-west monsoon in summer. As might have been expected, the monsoon off the coast of Mozambique is easterly, and that off the coast of West Australia north-westerly. The trade-winds also suffer considerable change in their

direction on the coasts of Brasil, Peru, Lower Guinea, &c. These, though sometimes considered monsoons, are not truly such, for they do not change their directions periodically, so as to be opposite to each other, like true monsoons, but only veer through a few points of the compass. For a fuller account of these partial deflections, see TRADE-WINDS.

In April, the north-east monsoon changes into the south-west; and in October, the south-west into the north-east. These times depending on the course of the sun, and consequently varying with the latitude, are called the breaking up of the monsoons, and are generally accompanied by variable winds, by intervals of calm, and by furious tempests and hurricanes.

Monsoons, when compared with the trade-winds, will be found to play a most beneficial and important part in the economy of the globe. Their greater velocity, and the periodical changes which take place in their direction, secure increased facility of commercial intercourse between different countries. But the full benefits following in their train are not seen unless they be considered in their relation to the rainfall of Southern Asia. Indeed, the fertility of the greater part of this fine region is entirely due to the monsoons; for if the north-east trade-wind had prevailed there throughout the year, Central and Western India, and many other places, would only have been scorched and barren saharas. The rainfall of India depends entirely on the monsoons. The coast of Malabar has its rainy season during the south-west monsoon, which brings thither the vapours of the ocean. On the Coromandel coast, on the other hand, it is the north-east monsoon which brings the rain from the Bay of Bengal. The two coasts of Hindustan have therefore their seasons reversed, the dry season of the one corresponding with the wet season of the other.

MONSTRANCE (Lat. *monstrare*, to shew), called also OSTENSORY, the sacred utensil employed in the Roman Catholic Church for the purpose of presenting the consecrated host for the adoration of the people, as well while it is carried in procession, as when it is exposed upon the altar on occasions of special solemnity and prayer. The use of the monstrance probably dates from the establishment of the festival of Corpus Christi in the 13th century. It consists of two parts, the foot or stand upon which it rests, and the repository or case in which the host is exhibited. The latter contains a small semi-circular holder called the *hucula*, or crescent, in which the host is fixed; and it appears

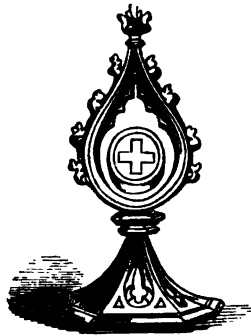

Monstrance.

anciently to have been of a cylindrical or tower-shaped form, in the central portion of which, consisting of a glass or crystal cylinder, the host was placed. At present, it is more commonly in the form of a star or sun with rays, the central portion of which is of glass or crystal, and serves to permit the host to be seen. This portion, or at least the crescent, is of gold or of silver gilt; the rest is generally either of the precious metals, or at least gilt or silvered, although the lower portion is occasionally of bronze artistically wrought. In many cases, it is of most costly materials and

workmanship. The monstrance, like the other vessels used in the Eucharistic service, is consecrated by a bishop, or a priest delegated by a bishop. By a peculiar usage of the city of Lucerne, in Switzerland, the Eucharist is always carried in the monstrance, when being borne to the sick.

MONSTROSITY, in Anatomy. When an infant, or the young of any animal, comes into the world impressed with morbid changes, which occur only in fetal life, and of which it has never been observed that they have originated in the same way after birth, such an infant or young animal is said to be a monster or monstrosity. Monsters were formerly regarded as prodigies of nature; and in the dark ages, their occurrence in the human species was usually ascribed to the intercourse of demons and witches. It is now perfectly understood that the formation of those apparently anomalous beings may be accounted for by the same laws as those which govern the formation of perfect individuals—the only difference being, that these laws in the case of monstrosity are more or less arrested or otherwise perverted.

Amongst the principal causes of monstrosity may be mentioned: 1. Something deficient or abnormal in the generative matter of one or both parents, because, as has been shewn in the article HEREDITARINESS, malformations are frequently transmitted from parents to the children. Here the morbid change is impressed upon the fetus at the moment of impregnation. 2. Some morbid condition of the maternal organs or constitution may exercise a disturbing influence upon development. 3. Diseases and abnormal states of the placenta, of the membranes of the ovum, and of the umbilical cord, may induce an arrest of development; for example, it may be easily understood how abnormal shortness of the cord may favour the origin of fissure of the abdomen; while a cord of disproportional length may coil round one of the extremities, and by constriction may dwarf it, or even amputate it. 4. Morbid influences acting directly on the fetus, as mechanical injuries and diseases affecting it, are the most frequent causes of malformations. From the experiments of several observers, it has been shewn, that by submitting hens' eggs to various mechanical influences during incubation, the development of the embryo may be interrupted, or modified in such a manner as to give rise to malformations; and many observations tend to prove, that mechanical influences affecting the womb (kicks, blows, or falls) in the early months of pregnancy, produce certain malformations, by causing an arrest of development. Moreover, the fact, that certain malformations usually occur only in twin or triplet pregnancies, favours the view, that certain monstrosities are due to pressure and confined space.

Of the various classifications of monstrosities, the following is perhaps the best: 1. Malformations in which certain parts of the normal body are entirely absent, or are too small. 2. Malformations produced by fusion or coalescence of organs. 3. Malformations in which parts naturally united, as in the mesial line of the body, are separated, and clefts or fissures occur. 4. Malformations in which natural openings are closed. 5. Malformations of excess, or in which certain parts have attained a disproportional size. 6. Malformations in which one or more parts have an abnormal position. 7. Malformations of the generative organs.

The first class includes (1) completely shapeless malformations, in which the monster presents the appearance of a lump or mass, with no indication of definite organs; (2) malformations which consist of only a more or less rudimentary trunk, with no head or extremities; (3) trunkless monsters, in

which the inferior parts of the body are wanting, and little more than a rudimentary head is present, which, instead of neck and trunk, is furnished with a pouch-like appendage, containing rudimentary viscera and pieces of bone; (4) malformations in which the head, and sometimes a part of the upper part of the body, are wanting, constituting acephalic monsters, which are by no means rare, the number of recorded cases in the human subject being over 100; (5) malformations in which the whole head is not absent, but some of its component parts are wanting—as, for example, the brain, some of the cranial bones, the nose, or the eyes; (6) cases in which the extremities are absent or imperfect to a greater or less degree—for example, they may be mere stumps, with the fingers and toes either absent or rudimentary, or the hands and feet may appear to exist independently of arms and legs, and to be inserted immediately into the trunk; (7) cases in which all the organs may be present, but some of them may be too small—thus, there may be general dwarfishness, or the head or limbs may be abnormally small. None of the monsters of this class, except those included in the last two groups, are viable.

In the *second class* are included such cases as (1) the various forms of *cyclopia*, or coalescence of the eyes; these malformations are not very rare in the human subject, and are of frequent occurrence in pigs and other animals; although usually born alive, these monsters are not viable; (2) coalescence of the lower extremities either into a common limb, which supports two feet, or into an undefined tail-like mass; (3) minor amalgamations, which do not affect vitality, as more or less perfect coalescence of the fingers and toes.

The *third class* embraces such cases as (1) fissures of the cranium, which are generally due to hydrocephalus in the fœtus; (2) harelip and cleft palate; (3) fissures on the neck, whose origin is due to the respiratory clefts—which, during the formation of the embryo, appear in the cervical region, not uniting at an early stage, as in the normal condition, but remaining more or less open; (4) fissures of the vertebral arches of the spinal column, occasioning the affection known as *spina bifida*; (5) fissures of the thorax, in which case the lungs or heart are more or less exposed; (6) fissures of the abdomen.

The malformations of the *fourth class* include congenital closure of the anus, the mouth, the nostrils, &c.

The malformations of the *fifth class* may be arranged in two divisions, according as certain parts are too large, or there are supernumerary organs.

The *sixth class* is very extensive, and embraces many varieties. One or more parts may be disproportionately large—as, for example, the head in cases of congenital hydrocephalus; or there may be one or several supernumerary organs—a sub-class which presents a very great range, from the simplest cases, in which a single joint of a finger is supernumerary, to those of a highly complicated nature, when two or even three bodies are united by some one point. There may be a single head and trunk and supernumerary parts—as, for example, supernumerary teeth, vertebrae (giving rise to the formation of a tail in the human subject), ribs, mammae, fingers, toes, &c.; or there may be malformations with more than one head and trunk—double, or even triplet monsters. This sub-class is divisible into two groups, according as the united individuals are equally developed, or as only one is developed; the second being more or less atrophied, and forming a parasitic appendage to the first. As examples of the first group, we mention (1) duplication of the head and upper part of the vertebral column; (2) dupli-

cation of the head, neck, and upper extremities, while the chest and abdomen are single, or fused into one another (in this group, we must place the twin-monster, Rita Christina, who was born in Sardinia in March 1829, and was brought alive to Paris, where she died in the November of that year); (3) almost complete duplication, with separation of the two bodies, except at a single spot, as in the case of the Siamese twins; (4) triplet monsters, such as the child with three heads born in 1832 in Catania (see Geoffroy St Hilaire, *Histoire des Anomalies de l'Organisation*, vol. iii. p. 327). To the second group belong such cases as the following: (1) a perfect individual may bear on its head another head, with traces of the rest of the body; (2) on a well-developed body, a second, smaller and defective one, may be situated, which, after birth, does not increase in size; (3) in a more or less perfectly developed individual, there may be concealed, commonly in the abdomen, parts of a second individual—a condition which has received the name of *fœtus in fœtu*, and which is most probably caused by the inclusion of one germ by another.

To the *sixth class* belong (1) those cases in which there is a reversing of the position of the internal organs—when the heart and spleen lie upon the right, and the liver and cæcum on the left side; (2) anomalies in the course and distribution of individual vessels.

The malformations constituting the *seventh class* have been sufficiently noticed in the article HERMAPHRODITISM.

The term *Teratology* (from the Greek words *teras*, a prodigy, and *logos*, a discourse) is now frequently applied to the history and science of monstrosities.—For further information on this subject, the reader is referred to Geoffroy St Hilaire, *Histoire des Anomalies de l'Organisation* (3 vols. 1832—1836); Otto, *Monstrorum Sexcentorum Descriptio Anatomica* (1841); and to the article 'Teratology,' by Vrolik, in *The Cyclopaedia of Anatomy and Physiology*.

MONSTROSITY, in Botany, is a malformation or abnormal development of any part of a plant. It may take place, however, at any period of the growth of a plant, as to any new organ that is developed, and sometimes merely affects a particular organ or some portion of a plant, as a particular leaf, flower, petal, sepal, &c., or the leaves or flowers of a particular branch, whilst in other cases all the organs of the same kind exhibit the same abnormal character. As in animals, it is now well known that monstrosities in plants are the result of special conditions affecting the operation of ordinary natural laws; and the study of monstrosities is very important in relation to that of the nature, development, and metamorphosis of organs. In the article *Metamorphosis of Organs*, some of the most frequent monstrosities are alluded to. Monstrosities in plants are not always, as in animals, reckoned deformities. *Double flowers* afford a familiar example of an opposite kind; although with regard to the plant itself they have the effect of unfitting it for one of the functions of a perfect plant, reproduction by seed.

MONTAGNANA, a town of Northern Italy, in the province of Padua, situated pleasantly on the banks of a canal, Il Fiumicello, 32 miles south-west of Padua. It is still protected by walls and towers, and has a fine cathedral and palace. Pop. 8200. Its chief trade is in spun-silk, wool, hemp, and coarse cotton textures.

MONTAGNARDS, or simply MONTAGNE, 'the Mountain,' the name given to the extreme democratic politicians in the first French Revolution, because they seated themselves on the higher benches of

the hall in which the *National Convention* met. Their principal members were Danton, Marat, Robespierre, St Just, and Collet d'Herbois, the men who introduced 'the Reign of Terror.' The opposite party of the 'Plain' (*Plaine*) were the Girondists (q. v.), who sat on the lowest benches on the floor of the house. After the overthrow of the Girondists, this part of the house was styled the 'marsh or swamp' (*marais*), and included all the subservient members whose votes were under the control of 'the Mountain.' A few leading men gave all its strength and formidable character to the party of the Mountain.—After 1848, the extreme party in the *National Assembly*, composed of revolutionary democrats and communists, sometimes flattered itself with the designation of 'the Mountain;' but events proved that it possessed nothing of the genius, though it shewed all the malignity of its terrible predecessor.

MONTAGU, FAMILY OF. This noble family are said, by Burke, to derive their name, which in Latin was and is always written *De Monte Acuto*, from a place in Normandy; and the first of the Montagus who settled in England was a warrior who came over in the train of Robert Earl of Moreton at the Conquest. Five centuries later, we find his descendant, Sir Edward Montagu, Lord Chief-justice, in succession, of the courts of King's Bench and Common Pleas under Henry VIII, who also appointed him one of the executors of his will and guardians of his son Edward. His grandson, who was a distinguished orator, represented the city of London in parliament; and having been Lord Chief-justice of the Court of King's Bench, and Lord Treasurer of the kingdom, was raised to the peerage as Earl of Manchester. The second earl gained distinction as a general in the Parliamentary army, and more particularly by his victory over Prince Rupert at Marston Moor; but he scrupled to take part in the condemnation and execution of Charles, and was one of the first members of the House of Peers who gave in his adhesion to Charles II. on his restoration. This nobleman's grandson enthusiastically espoused the cause of William III., under whom he fought at the battle of the Boyne, and took part in the siege of Limerick. He was subsequently sent as ambassador to Venice, and to the courts of France and Vienna, and eventually was raised to the dukedom of Manchester by George I. The title is still enjoyed by his descendant, the 7th duke. Other branches of the M. family were ennobled in the persons of the Earl of Sandwich, the Earl of Halifax, and the Duke of Montagu, but the last two titles both became extinct before the close of the 18th century.

MONTAGU, LADY MARY WORTLEY, was eldest daughter of Evelyn, Earl, and afterwards (1715) Duke of Kingston. She was born about 1690, and is said to have received a classical education. When only eight years of age, she was introduced by her father to the famous *Kit-Cat Club*, and formally admitted a member. Her fond and pleasure-loving father allowed her to educate herself. She is even said to have taught herself Latin. She became attached to Mr E. Wortley Montagu, a member of the House of Commons, whose cousin, Charles Montagu, was created Earl of Halifax, and appointed First Lord of the Treasury, by George I. As the match was disapproved of by the families, she was obliged to elope before she could marry him. On the accession of George I., she came to London with her husband, who was a Whig. Lady Mary's beauty and wit attracted universal admiration at court. She was in habits of familiar acquaintance with Addison and Pope, the latter becoming her

enthusiastic admirer, and writing 'flames and raptures' for her, until his passion 'came to a climax in an impertinence, and was extinguished by a box on the ear, or some such rebuff.' In 1716, Mr Wortley Montagu was appointed ambassador to Constantinople. He was accompanied by Lady Mary, who, on her journey, and during her residence in the Levant, wrote the well-known *Letters*, which form one of the most delightful books in our language. The weaknesses of a somewhat vain and capricious temper fade into forgetfulness, when we remember the strong sense, enlightened courage, and generous perseverance which introduced into Europe the practice of inoculation, which she witnessed in Turkey. She had so much faith in its safety, that she tried it first on her own son. See **INOCULATION**. After her return to England, she fixed her residence at Twickenham, and renewed her intimacy with Pope. But political soon led to personal differences, and these resulted in one of the most famous literary feuds of the 18th century. The immediate occasion of it was the publication by Lady Mary of her *Town Eclogues*. She was fiercely assailed by both Swift and Pope, and was not slow to retaliate. In 1737, she left her country and her husband (for reasons that are not known), and lived for many years in Italy, chiefly at Lovero, in the province of Venice. Her husband died in 1761. At the request of her daughter, now married to the Earl of Bute, she returned to England, where she died 21st August 1762. A collected edition of her works, with life, was published by her great-grandson, the late Lord Wharnclyffe, in 1836, of which a third edition appeared in 1861.

MONTAIGNE, MICHEL EYQUEM DE, a distinguished French moral philosopher, was born in 1533, at his paternal home of Montaigne, in Perigord. In accordance with his father's eccentric ideas on education, he was taught, and suffered only to speak Latin from his earliest infancy, in consequence of which he acquired such a perfect mastery over the language, that when, in his tenth year, he entered the college of Bordeaux, his masters, Grouchi, Buchanan, and Muret, were almost afraid to address him. On the expiration of his course of studies, which were directed to law, he received, in 1554, the appointment of councillor in the parliament of Bordeaux; but being possessed of ample means, and having no inclination for a public life, he devoted himself to the study of the various schools of Greek and Roman philosophy; and on the death of his father, in compliance with whose wish he had made a translation of the natural theology of Raymundus Sebondus (Paris, 1569), he retired to his ancestral estate, where he lived in retirement during the terrible season of religious oppression which desolated France for so many years. During this period, 1580, he composed the first two books of his celebrated *Essais*, the third portion of which appeared in 1588, after his return from an extensive course of travels, which he had undertaken partly to escape from the plague, and partly for the improvement of his own health, and during which he visited Rome, and was received with signal favour by the pope. M.'s *Essais*, although not conceived in the spirit of a believing Christian, or marked by the reticence and delicacy of expression which modern refinement demands, are very extraordinary productions, not only for the learning and sound reasoning which they manifest, but also for the frank and liberal tone in which social questions are discussed, notwithstanding that the author wrote at a period when religious differences and party feelings blinded the judgments of men. M.'s ethics were those of Seneca and the other philosophers of ancient times, whose works he had so

thoroughly mastered; and, judged from our point of view, his morality is that of a virtuous pagan merely; but when we bear in mind the turmoil of civil war, and the consequent disorganisation of society, together with the low ebb of literature in France at that period, we must do justice to the great merit of the writer, and the influences for good which his writings exerted. M. was a constant, and occasionally a successful mediator between the party of Henry of Navarre and that of the Guises, and stood in relations of friendship with men of all creeds. He died in 1592, as an avowed member of the Church of Rome, in whose doctrines he professed implicit faith, notwithstanding the sceptical bias which he had through life been at no pains to conceal. Numerous editions have appeared of his *Essais*, among which we may instance those of De Coste (5 vols. Hag. 1727), and Victor Leclerc (Paris, 1826). Nearly 200 years after his death, the discovery was made at Montaigne of the MS. of his travels, which was published at Paris in 1774, under the title of *Journal de Voyage de M. de M. en Italie par la Suisse et l'Allemagne*. Translations of the *Essais* exist in almost all the European languages; the best English translation is that by Cotton. The best biographies of M. are by Grün (Paris, 1855); Payen (Paris, 1856); and Bayle St John (Lond. 1857).

MONTALCINO, a town of Tuscany, in the province of Siena, and 22 miles south-south-east of the town of that name, stands on a hill in the midst of valleys, and enjoys a fine equable climate. Pop. 6573. The wine of M. is in high repute throughout Tuscany.

MONTALEMBERT, CHARLES FORBES, COMTE DE, was born in April 1810 of an ancient family of Poitou. His father was created a peer of France under the Restoration, and for a considerable time was minister of the French court in Sweden. His mother was of the Scottish family of Forbes, to which circumstance may be ascribed M.'s remarkable familiarity with the English language, and his intimate knowledge and strong admiration of the social and political institutions of England. Although his more advanced studies were carried on in the university of Paris, a considerable part of his youth was spent in Sweden; and the first work by which he was brought into notice, was a pamphlet on Sweden, which he published in his nineteenth year. On the death of his father, M. succeeded to his honours, and to his seat in the Chamber of Peers. But his earliest public appearance was in what may be truly considered as the great labour of his life, a joint effort in which he associated himself with the Abbé Lacordaire (q. v.) and other friends, for the purpose of taking advantage of the recent charter, by establishing a free school for Catholic education, independent, as well of the university, as of all other state influence. An attempt on the part of the police to interfere arbitrarily with this project, became the subject of a trial before the Chamber of Peers, which M. rendered memorable by his first speech, one of the most brilliant upon record, and a clear foreshadowing, not alone of the eloquence, but of the bold and uncompromising earnestness in the cause of his church and of the common interests of religious liberty, which have constantly characterised his later career. Of the struggle of the Catholic party in France against what they regarded as the arbitrary monopoly of education which was claimed for the university, M. was for many years the leader and the champion; and in the various works in the preparation of which he employed all his leisure from public duties, his *Life of St Elizabeth of Hungary*, his *Life and Times of St Anselm*, and,

above all, in an appeal *On the Duty of Catholics on the Question of Freedom of Education*, which he wrote during a visit to the island of Madeira for the recovery of his health in 1843, he never ceased to advocate the same principles. After the revolution of 1848, M., true to his former professions, was one of the first of his party to accept of the new state of things, and to use the actual means at his disposal for the furtherance of the views which he had consistently advocated. He was elected member of the National, and afterwards of the Legislative Assembly; and for a time contrived, while he continued the same line of policy as regards church interests, to give a general support to the government of Louis Napoleon as president of the republic. His first break with that government was on the question of the proposed confiscation of the Orleans property; and after the *coup d'état* of December, the breach became irreconcilable. From that time, M. has been the most unbending and implacable assailant of the arbitrary repression of public opinion which has characterised the later measures of the emperor; and the brilliant and enthusiastically admiring pictures, which in his *Political Future of England*, he has drawn of the social and political institutions of that country, derive much of their brilliancy and vigour from the covert but palpable contrast with the condition of the author's native land which points them all. His *Catholic Interests in the Nineteenth Century*, his *Pius IX. and Lord Palmerston*, and his numberless contributions to the *Correspondent*, a journal established by him in concert with a number of friends, have furnished him with that opportunity of discussion from which he has been otherwise debarred by his exclusion from public life. Many of his later essays have been devoted to advocacy of the cause of Poland.

MONTANUS, a celebrated heresiarch of the early Christian Church, was a Phrygian by birth, and made his first public appearance about 160 A.D., in the village of Ardabar, on the confines of Phrygia and Mysia. He was brought up in heathenism, but appears to have embraced Christianity with all the fanatical enthusiasm for which his countrymen were noted. Neander, in his *Kirchengeschichte*, endeavours to explain his character and tendencies on the supposition of his possessing an essentially Phrygian temperament, and the little we know concerning him renders this highly probable. The frenzy, the paroxysms, the fierce belief in the supernatural, that marked the old Phrygian priests of Cybele and Bacchus, are repeated under less savage, but not less abnormal conditions in the ecstasies, somnambulisms, and passion for self-immolation—for what else was their strong thirst for martyrdom?—of the Montanists. According to Apollinaris of Hierapolis (quoted by Eusebius in his *Ecclesiastical History*, chap. 16th), M.'s followers were exclusively Phrygians; but this is not correct, though it is easy to see, from what we have said, why his views should have laid strong hold on that race of excitable and superstitious Asiatics.

M.'s stand-point was, *in theory*, the exact opposite of that occupied by the Gnostic sects; yet, *in practice*, it led to a similar exclusiveness and sectarianism. He believed in the constancy of supernatural phenomena *within* the church. The miraculous element, particularly the prophetic ecstasy, was not removed; on the contrary, the necessity for it was greater than ever. He considered those only to be true or perfect Christians who possessed the inward prophetic illumination of the Holy Spirit—they were the true church; and the more highly gifted were to be looked upon as the genuine successors of the apostles, in preference

to the mere outwardly consecrated bishops. Thus, they formed a religious aristocracy, as arrogant as the Gnostics; the difference between the two simply being, that the Montanists prided themselves on a kind of inflamed inspiration, and the Gnostics on a calm and serene illumination of the reason. Neither party wished to recede from the Catholic Church, but rather to exist as an esoteric body within its pale. It was persecution, caused, no doubt, by their own insolent obstinacy, that forced them into a sectarian course. M. did not meddle directly with the creed of the church; in fact, he was not a thinker, nor a man of almost any importance intellectually. His efforts were confined to stirring up the Christians generally to fresh religious life—to a belief in a fresh outpouring of the Holy Ghost! At first, M. contented himself with predicting fresh persecutions, exhorting men to greater strictness and holiness of life, and announcing judgments to come upon the persecutors; but his idea of his own mission afterwards became more exalted, and he claimed to be in a very special sense a prophet of God—the organ chosen by the Holy Ghost to purify, enlighten, and advance the church. Among the things on which the Montanists laid stress, was an ascetic mode of life, scorn of persecution, and love of martyrdom; connected with these, and, indeed, flowing from them, was an aversion to second marriages, and to the restoration of the Lapsed (q. v.). Like other enthusiasts, they also were firm believers in the near approach of the Millennium (q. v.), and in the personal advent of Christ. Two 'prophetesses,' Priscilla and Maximilla, were associated with M. in his work. A decree for the expulsion of M. and his followers from the communion of the Catholic Church was issued by Eleutherus, Bishop of Rome. The Montanists at once proceeded to organise themselves as a distinct sect. They found a singularly able apologist in Tertullian (who became a Montanist about 200 A.D.), and continued to exist till the 6th century.

MONTARGIS, a town of France, department of Loiret, is situated at the junction of the canals of Orleans and Briare with that of Loing, 40 miles east-north-east of the city of Orleans. M. has some cloth and leather manufactures, and considerable trade in corn, cattle, &c. Pop. 7940.—In its vicinity is an extensive forest of the same name.

MONTAUBAN (Lat. *Mons Albanus*), a town of France, capital of the department of Tarn-et-Garonne, is situated in a rich and beautiful country on a plateau between the rivers Tarn and Tescou, 32 miles north of Toulouse. It is the seat of a bishop, has a fine cathedral in the Italian style, finished in 1739, built on the site of a still older monastery, the *Mons Aureolus* (Golden Hill), and is a well-built, handsome town. The houses are mostly of brick. Besides having considerable manufactures, it carries on a great trade in wine, grain, leather, &c. M. was founded in 1144 by Count Alphonse of Toulouse, became the seat of a bishop in 1317, embraced the Reformation in 1572, and suffered severely in the civil wars that ensued. It has acquired historical celebrity as the great stronghold of the Huguenots. Protestantism still exists here, and maintains both an academy and a theological college. Pop. 16,492.

MONTBELIARD (Ger. *Mömpelgard*), a town of France, in the department of Doubs, 36 miles north-east of Besançon. It lies in a valley between the Vosges and Jura Mountains, is surmounted by an old chateau, now used as a prison, and carries on manufactures of cotton goods, hosiery, and silks.

Clocks, watches, and agricultural implements are also made. Pop. 5852.

MONT BLANC, the highest mountain in Europe, and, according to the latest measurements, 15,781 feet above the level of the Mediterranean Sea, is one of the Graian Alps, and is situated in the department of Haute-Savoie, France, close to the Italian frontier, and 37 miles south of the east end of the Lake of Geneva. The vales of Chamouni and Mountjoie lie on the west, and those of Ferret and Allée Blanche on the east side of it. The waters which spring from its western slopes are drained off to the Arve, and thence to the Rhone, while those which rise on the east side are feeders of the Dora Baltea, a tributary of the Po. It has 3 snow-clad peaks, and 36 glaciers, of which 16 lie on the north, and 20 on the south side. The highest summit is a narrow ridge 50 yards by 16, called *La Bosse du Dromedaire*, covered with firm snow, and very steep towards the north. In 1760, Saussure offered a prize for the discovery of a practicable route to the summit of Mont B., which was gained, in June 1786, by Jacques Balmat, a guide. Saussure himself ascended the mountain the following year; and the same feat has since been performed by many, especially since Albert Smith published the well-known pictorial and dramatic description of his ascent in 1851.

MONT CENIS. See **CENIS**.

MONT DE PIÉTÉ, called in Italy **MONTE DI PIETÀ**, a charitable institution, the object of which is to lend money to the very poor at a moderate rate of interest. It had its origin at the close of the medieval period, when all such transactions were in the hands of usurers, to whom the necessities of the poor were but an inducement to the most oppressive extortion. The earliest of these charitable banks appears to have been that founded at Padua in 1491, which was so successful as to lead, according to contemporary writers, to the closing of the Jewish banks in that city. The first opened at Rome was under Leo X.; and the Roman *Monti di Pietà* are confessed to have been at all times the most successful and the best managed in Italy. The institution extended to Florence, Milan, Naples, and other cities. The principle of all was to advance small sums, not ordinarily exceeding 30 crowns, on the security of pledges, but at a rate of interest barely sufficient to cover the working expenses of the institution. Should any surplus remain, it was to be expended for charitable purposes. The *Mont de Piété* system was introduced also in Spain, and in the Spanish provinces of the Netherlands. It formed the model of the Loan Fund Board of Ireland, established by 6 and 7 Vict. c. 91.

MONTEBELLO CASTEGGIO, a village of Northern Italy, in the province of Voghera, 23 miles east-north-east of Alessandria. It stands in a plain on the banks of the torrent Schizzola. Here the Austrians were defeated by a French army under General Lannes, after a desperate conflict, 9th June 1800. The title of Duke of Montebello was conferred on the victorious French general five years later. In the last Italian war the Austrians were again defeated here by the united armies of the French and Piedmontese in May 1859.

MONTE-CASINO. See **CASINO**, **MONTE**.

MONTE-CATINI, a village of Tuscany, situated on a spur of the Apennines, 29 miles west of Florence, derives its name from the bowl-shaped hill on which it stands. It is of very ancient origin, and was formerly called *Castello*. In the close vicinity of the town are the famous mineral springs

of same name, in high repute for their curative properties, especially in diseases of the liver and digestion. Excellent accommodation can be had by visitors both in private establishments and those under government direction.

MONTÉ CHIARO, a town of Northern Italy, in the province of Brescia, situated on a height on the left bank of the Chiese, in the centre of an amphitheatre of hills. Pop. 8700. The chief manufacture is silk. In 1796, the Austrians were defeated here by a French army.

MONTÉ CRISTO, a small island, belonging to Tuscany, 26 miles south of Elba. It consists of a mountain of granite 1983 feet above the level of the sea, and is uninhabited except by wild goats and other animals. It is inaccessible except by one narrow landing-place. M. C. has given name to Dumas's well-known novel.

MONTECUCULI, RAIMONDO, COUNT, born near Modena, 1608, and entered the Austrian artillery as a volunteer under his uncle, Ernesto, Count Montecuculi, in 1627. During the Thirty Years' War he found many opportunities of distinguishing himself, received rapid promotion, and was employed in various services, military and diplomatic. In 1657, he was sent to support the king of Poland, John Casimir, against the Swedes and Rákóczy, which he did with great effect, compelling Rákóczy to make peace with Poland, and to break his alliance with the Swedes. In the following year, he was made a field-marshal, and was sent to aid the Danes against the Swedes, in which also he was eminently successful. In 1660, he commanded the army sent to oppose the Turks, who had broken into Transylvania, and skilfully kept them in check till the arrival of the French, with whose assistance he won the great battle of St Gotthard, on the banks of the Raab, 1st August 1664—the first decided triumph of European tactics and discipline over the mere numbers and daring of the Ottoman hosts. When the war broke out between France and Holland, in which the emperor took part with Holland, M. received the command of the imperial army in 1672. He took Bonn, and notwithstanding the endeavours of Turenne to prevent it, effected a junction with the Prince of Orange. In 1675, he was opposed to Turenne on the Rhine, and they spent four months in manoeuvres in which neither could gain any advantage. After this campaign, M. spent the remainder of his days at the imperial court and in the society of learned men. He was himself a man of learning and various accomplishments, and has left works on the art of war, on the Turkish war, and on the war of 1664, and also sonnets. The Emperor Leopold made him a prince of the empire, and the king of Naples bestowed on him the duchy of Melfi. He lost his life by the fall of a beam as he was entering Linz with the imperial court, 16th October 1681. His writings were published in the original Italian by Ugo Foscolo (2 vols. Milan, 1807); and by J. Grassi (2 vols. Turin, 1821). A semi-autobiographic memoir was translated into Latin, and published at Vienna, under the title of *Commentarii Bellici*, in 1718.

MONTÉGO BAY, a small but flourishing seaport on the north coast of the island of Jamaica, 17 miles west of Falmouth. It has a harbour protected by a breakwater, is defended by a battery, and carries on a general trade of some importance. In 1860, 82 vessels, of 12,751 tons, entered and cleared the port. Population variously stated at from 4000 to 5000.

MONTÉLIMAR, an ancient town of France, in the department of Drome, about two miles from the left bank of the Rhone, and 26 miles south of

Valence. It stands on the slope of a hill covered with vineyards. There are factories for silk and cotton goods; tanneries, &c. Pop. 8490.

MONTÈM CUSTOM was a triennial procession of the Eton boys, on Whit-Tuesday, to a certain mound (*ad Montem*) known as the Salt Hill, near the Bath Road, and which was doubtless so called because certain of the boys levied tribute (for *salt*, as the phrase went) from every person present, and even from any chance passer. These juvenile tax-gatherers were attired in fancy dresses of silk. The king and queen, besides many members of the nobility, frequently honoured the procession with their presence; and on such occasions, as much as £1000 has been collected, which was given to the senior scholar to support him at Cambridge. The origin of the custom is unknown. It was discontinued in 1847.

MONTENE'GRO ('Black Mountain'), called by the natives **TZERNAGORA**, and by the Turks **KARADAGH**, all three names expressive of the peculiar features of the country, is a small principality, situated between the Turkish eyalets of Bosnia and Albania, and separated from the Adriatic by the narrow strip of land known as the Circle of Cattaro, in Austrian Dalmatia. It contains about 1880 square miles, and is everywhere mountainous, the mountains being in most cases clothed with dark forests of fir, ash, beech, oak, ilex, willow, and poplar. Mount Dormitor, in the north, is 8500 feet, and Kutah Kom, in the east, 9300 feet above sea-level. Agriculture is prosecuted to the utmost extent the country will admit of, but in an extremely rude and primitive manner. The products are those of other European countries in the same latitude. The Sumach (*q. v.*), one of the most valuable of the natural trees, is not uncommon. Few oxen are reared, but sheep, goats, and swine abound.

There are no towns in M., and the largest village contains only 1200 inhabitants. Cettigne or Cettinji, the seat of government, contains between twenty and thirty well-built houses, besides a convent and the palace of the Prince of Montenegro. The villages are unwall'd; the houses, or rather huts, which compose them, are very rarely provided with chimneys, and in the elevated districts are more wretched in appearance than even the mud-hovels of Ireland.

The Montenegrins or Tzernagorzes are Slavs of the Servian race, and number about 130,000. They are knit together in clans and families, and have many feuds amongst themselves, which are perpetuated by the hereditary obligation of avenging blood. Their chief occupations at home are agriculture and fishing, but they are ever ready for war or pillage. Education among them is at a very low ebb; in fact, it is held in contempt, and many, even among the priests, are unable to read or write. In 1841, several schools were established, and the art of printing introduced; but the unsettled state of the country has hitherto prevented much improvement. Their language is a very pure dialect of the Slavic. They belong to the non-united Greek Church.

Political Divisions and Government.—M. is divided into the districts of M. Proper, and Brda or Zjeta, each of these being subdivided into four 'nahies' or departments, and these are further subdivided, each subdivision having its own hereditary chief. Some islands in the Lake of Scutari also belong to Montenegro. Until 1851, the head of the government was the *Vladika* ('metropolitan,' or 'spiritual chief'), who, besides his proper office of archbishop and ecclesiastical superior, was at the same time

chief ruler, lawgiver, judge, and military leader. This theocratic administration became (1697) hereditary in the Petrovitch family, but as the vladika cannot marry, the dignity was inherited through brothers and nephews. Since 1851, the two offices have been disjointed, and the vladika is restricted to his ecclesiastical office, while the cares of government devolve upon the 'Gospodar' ('hospodar') or lord, though the common people still apply to him the title 'sveti gospodar,' which properly belongs to the vladika alone. The vladika Pietro II. (1830—1851) established a senate of twelve members, elected from the chief families of the country, and in this body the executive power was vested. Next to the vladika in ecclesiastical affairs is the archimandrite of the convent of Ostrooc. The other public officers, as the Secretary of State, the Chancellor, and the local judges, are appointed by popular election. From time to time, an *Assembly* of all the adult males of the country takes place in a grassy hollow near Cettigne, the capital; but the powers of this assembly are very undefined. For defraying the expenses of government, taxes are levied on each household, the income thus raised amounting to 40,000 Austrian florins, or £4068. Besides this, the prince receives from Russia a subsidy of 8000 ducats (£3733), and from France one of 50,000 francs (£1950). As the Montenegrin, even when engaged in agricultural operations, is always armed with rifle, yataghan, and pistols, an army of 28,000 men can be summoned on the shortest notice, and in desperate cases, 14,000 more troops can be raised. Their intense love of independence, and heroism in the defence of their country, is worthy of the highest respect; but out of their own country, they are savage barbarians, who destroy with fire and sword everything they cannot carry off.

There is little trade in M., yet hides, wool, venison, dried and smoked fish, mutton and goat flesh, bacon, lard, &c., are exported in considerable quantities. These goods are carried to Cattaro by the women, aided occasionally by mules, for, owing to the absence of roads (a precaution against invasion), carts are unknown. Austrian and Turkish coins form the currency, as M. has no mint of its own.

History.—M. belonged in the middle ages to the great Servian kingdom, but after the dismemberment of the latter, and its conquest by the Turks at the battle of Kossovo (1389), the Montenegrins, under their prince, who was of the royal blood of Serbia, maintained their independence, though compelled to relinquish the level tracts about Scutari, with their chief fortress of Zabliak, and confine themselves to the mountains (1495). In 1516, their last secular prince resigned his office, and transferred the government to the vladika. The Porte continued to assert its claim to M., and included it in the pashalik of Scutari; but the country was not conquered till 1714, and on the withdrawal of the Turks soon afterwards, it resumed its independence. In 1710, they had sought and obtained the protection of Russia, the czar agreeing to grant an annual subsidy on condition of their harassing the Turks by inroads, and this compact has, down to the present time, been faithfully observed by both parties. Another part of the agreement was, that the archbishop or vladika was to be consecrated by the czar. In 1796, the Prince-bishop, Pietro I., defeated the Pasha of Scutari, who had invaded M., with the loss of 30,000 men; and for the next quarter-century we hear no more of Turkish invasions. The Montenegrins rendered important aid to Russia in 1803 against the French in Dalmatia, and took a prominent part in the attack on Ragusa, the capture

of Curzola, and other achievements. Pietro II., who ruled from 1830 to 1851, made great efforts to civilise his people, and improve their condition. He established the senate, introduced schools, and endeavoured, though unsuccessfully, to put an end to internal feuds, and predatory expeditions into the neighbouring provinces. Some Turkish districts having joined M., the Turks attacked the latter in 1832, but were repulsed. A dispute with Austria regarding the boundary resulted in a war, which was terminated by treaty in 1840. In 1851, the last prince-bishop died, and his successor, Danilo I., separated the religious from the secular supremacy, retaining the latter under the title of Gospodar. This step caused the Czar Nicholas to withdraw his subsidy (which was renewed, and the arrears paid, by the Czar Alexander II.), and the imposition of taxes thus rendered necessary, caused great confusion. This was taken advantage of by the Turks, who, under Omer Pasha, invaded the country; but the intervention of the Great Powers compelled a treaty, February 15, 1853. Danilo, however, in vain attempted to obtain the recognition of M. as an independent power, though he repaired to the Paris conference in 1857 for this purpose. He, however, greatly improved the laws and condition of the country. In 1860, the Montenegrins excited an insurrection against the Turkish rule in the Herzegovina, which was soon suppressed, and in return they themselves were so hard pressed by the Turks, that they were glad to agree to a treaty (8th September 1862) by which the sovereignty of the Sublime Porte over M. was recognised.

MONTEHOTÉ, a small village of northern Italy, 26 miles west of Genoa, where the Austrians were defeated by the French in a great engagement on the 12th April 1796.

MONTEPULCIA'NO, a city of Italy, in the Tuscan province of Arezzo, 56 miles south-south-east of Florence. Pop. about 3000. It stands on a high mountain, and is surrounded by mediæval walls. It has a fine church and several palaces. It is supposed to occupy the site of an Etruscan city of great antiquity; and numerous Etruscan remains have been excavated in the neighbourhood. The wines of M. are famous throughout Italy.

MONTREALE, a town of Italy, in the Neapolitan province Abruzzo Ulteriore, 14 miles north-west of Aquila. Pop. 5600. It stands on a hill in the midst of a vast plain, and has several elegant churches. In the neighbourhood, there are vast chestnut-groves, which furnish the poor inhabitants with the chief article of their subsistence.

MONTREAU, a town of France, in the department of Seine-et-Marne, at the confluence of the Seine and Yonne, 46 miles south-east of Paris, with which there is communication by steam-boat. The manufactures are earthenware and leather. Here, in 1419, Jean-sans-Peur, Duke of Burgundy, was assassinated, at the instigation and in the presence of the Dauphin, afterwards Charles VII.; and in the immediate vicinity, Napoleon, on February 18, 1814, gained his last victory over the allies. Pop. 5685.

MONTREY, the most thriving city of Northern Mexico, capital of the state of Nuevo Leon, on the San Juan, a tributary of the Rio Grande, 175 miles west of Matamoros. It is well paved and clean, stands on a broad plain, 1626 feet above sea-level, and is surrounded by beautiful gardens and orchards. Pop. in 1858, 17,400. From its situation, its facilities for commerce are great; and it is the entrepôt for the transport of American goods from the Rio Grande to the inland states of Durango and Zacatecas. In the war between the United States

and Mexico, M. capitulated, 24th September 1846, after a siege of four days, to the American forces under General Taylor.

MONTÉ ROSA, the *Mons Sylvius* of the ancients, is the highest mountain in Europe after Mont Blanc. It is situated in the angle where the west end of the Pennine meets the Lepontic Alps, and separates the canton of Valais from Italy. The northern portion of the mountain is highest, and forms nine peaks, the highest of which is forked and precipitous, and attains an altitude of 15,210 feet above sea-level. Many attempts were made to ascend this peak, but none were successful till 1849. The mountain appears to consist of mica-slate, in some places alternating with gneiss. It is rich in metallic ores, and several mines of gold, copper, and iron are worked. The highest mine is between 10,000 and 11,000 feet above sea-level, and in the region of perpetual snow. Rye ripens up to an elevation of 6000 feet; and the vine is found as far up as 3200 feet; but there is a difference of nearly 1000 feet in the altitude of the corresponding vegetation on the north and south sides.

MONTÉ SANT' ANGELO, a city of Italy, in the Neapolitan province of Capitanata, 28 miles north-east of Foggia. It stands on one of the Gargano group of hills, at a height of 2790 feet, and has numerous fine churches. It is famed for its exquisite honey, gathered from the odoriferous alpine plants of the mountain. Pop. 12,000.

MONTÉ SAN GIULIANO, a town of the island of Sicily, province of Trapani, situated on a high mountain 4 miles east-north-east of the town of Trapani. On the mountain (anciently *Eryx*) are the remains of a once famous temple of Venus. Pop. 7500.

MONTÉ SARCHIO, a town of Italy, in the Neapolitan province of Principato Ultra, 13 miles north-west of Avellino, on the torrent Correo. Pop. 7200.

MONTESQUIEU, CHARLES DE SECONDAT, BARON DE LA BRÈDE ET DE, one of the most celebrated authors and political philosophers of France, born 18th January 1689, at his father's château of Brède near Bordeaux, and descended from one of the most distinguished families of Guienne. In his youth he was a hard student of jurisprudence, literature, and philosophy. His love of the classical authors was so great, that at the age of twenty he composed a work intended to shew that they did not deserve eternal damnation for being pagans. In 1714, he was appointed a councillor of the parliament of Bordeaux, and two years after, president of the parliament. His first (published) work was his famous *Lettres Persanes* (Par. 1721), in which, in the character of a Persian, he ridicules, with exquisite humour, and clear, sharp criticism, the religious, political, social, and literary life of his countrymen. Although he did not spare the Academy in these *Lettres*, he was admitted a member of it in 1728, and would have been admitted sooner, if Cardinal Fleury had not objected on the ground of his jests against religion. In 1726, M. resigned his office in the parliament of Bordeaux, and spent some years in foreign countries. In England, he spent two years, during which he was much in the company of Lord Chesterfield, and was treated with the greatest respect by the most distinguished personages. After his return to Brède, he published his *Considérations sur les Causes de la Grandeur et de la Décadence des Romains* (Par. 1734), a masterly view of Roman history, expressed in a sententious, oracular, and vigorous style. It was followed, after a long interval, by his *Dialogues de Sylla et de Lysimaque* (Par. 1748), published

under an assumed name, in which the motives and feelings of a despot are skilfully analysed. In the same year appeared his great work, on which he had been engaged for twenty years, the *Esprit des Loix* (2 vols. Geneva, 1748), in which it was attempted to exhibit the relation between the laws of different countries and their local and social circumstances. It was immensely popular. No fewer than twenty-two editions were published in eighteen months, and it was translated into various European languages. The *Esprit des Loix* is a wonderfully good book, considering the age in which it appeared. Without adopting Voltaire's hyper-eulogistic criticism, that 'when the human race had lost their charters, Montesquieu rediscovered and restored them,' it may be said that it was the first work in which the questions of civil liberty were ever treated in an enlightened and systematic manner, and to M., more than to any other man, is it owing that the science of politics has become a favourite subject of study with the educated public. M. died at Paris, 10th February 1755. The collective editions of his works are numerous, amongst which may be mentioned the recent complete and careful ones by Auger (8 vols. Par. 1819), by Destutt de Tracy and Villemain (8 vols. Par. 1827), and by Lefebvre (2 vols. Par. 1839).

MONTÉ VIDEO, SAN FELIPE DE, the capital of the republic of Uruguay, in South America, is situated on the north shore of the estuary of the Rio de la Plata (which is here 60 miles wide), and 132 miles east-by-south from Buenos Ayres. It stands on a small peninsula, and is surrounded by a wall and fortifications. The houses are mostly of one story, with flat roofs. The only public buildings worthy of notice are the cathedral and the town-hall. The climate is healthy; but, as there are no rivers near the town, water is scarce, and it is only obtainable from wells, or by collecting rain-water in cisterns. The bay or harbour, which is about 3½ miles long by 2 broad, presents excellent facilities for building wharfs, docks, &c., is sheltered from all but the south-west gales, and averages 16 or 17 feet in depth. The trade of M. V. is extensive; the exports consisting of wool, hides, hair, tallow, salt and dried beef, bones, &c.; and the imports, of cotton and woollen fabrics, hardware, also flour, wine, spirits, and other provisions. The chief trade is with Great Britain. M. V. has steam-communication with the United States, Rio Janeiro, Britain, and Genoa, and besides these, carries on a considerable trade with France, Spain, La Plata, and Italy. The population in 1860 was 37,787 inhabitants, and in 1862 (inclusive of the small suburbs of Cordon and Aguada), 45,765. In 1861, 1584 vessels of 496,261 tons entered and cleared from the port. The imports for 1861 amounted to nearly £1,500,000, and the exports to about £922,000. For the history of M. V., see URUGUAY.

MONTEZUMA, the name of two of the emperors of Mexico.—M. I., the most able of the Mexican emperors, ascended the throne about 1437, and soon after, commenced a war with the neighbouring monarch of Chalco, which resulted in the annexation of that kingdom to Mexico. Tlatelolco, Cuixicas, and Tzompahuacan were next annexed. Some reverses which his arms now suffered, led to a confederacy of the Tlascalans and two other powerful tribes against him; but in the war which followed, M.'s arms were again signally triumphant, and the territories of the conquered tribes increased the domain of the now all-powerful Montezuma. After several other successful wars, he died in 1471.—M. II., the last of the Mexican emperors, before its subjugation by the Spaniards, succeeded to the

throne in 1502. He had distinguished himself as a warrior during the reign of his predecessor, and after his accession, carried the terror of his arms to the frontiers of Nicaragua and Honduras. He was at the same time a member of the priestly order, and did not demit his functions on his accession. He devoted his chief attention to the improvement of the laws, and of the internal administration, and displayed his taste for pomp and luxury by the magnificence of his household arrangements, and a profuse embellishment of his capital. This necessitated heavy taxation, which, combined with the strictness of his administration, led to continual revolts among his subjects, especially those who had lately come under his sway. When Cortes landed in Mexico with his small army in 1519, M., blinded by an old prophecy, and by the strange appearance of the invaders, acknowledged them as beings of a superior order, and as his masters (see CORTES). The inhabitants of Mexico having risen against Cortes, the latter caused M., who was then his prisoner, to appear in order to pacify them; but being wounded accidentally by a stone flung from amongst the crowd of his own subjects, he so keenly felt the indignities which he had suffered, that he repeatedly tore the dressing from his wound, and soon after died, June 30, 1520. Some of his children adopted the Christian religion, and his eldest son received from Charles V. the title of Count of Montezuma. One of his descendants was viceroy of Mexico from 1697 to 1701. His last descendant, Don Marsilio de Ternel, Count of Montezuma, was banished from Spain by Ferdinand VII., and afterwards from Mexico, on account of his liberal opinions, and died at New Orleans in 1836.

MONTFERRAT, formerly an independent duchy of Italy, between Piedmont, Milan, and Genoa, now forming part of the kingdom of Italy. It consisted of two separate portions, Casale and Aouqi, lying between the Maritime Alps and the Po, and having an area of over 1300 square miles. The capital was Casale. M., after the downfall of the Frankish empire, was ruled by its own margraves till the beginning of the 14th century. This illustrious house for a long time disputed the sovereignty of Piedmont with the House of Savoy, and sent to the crusades more heroes than any other sovereign house in Europe. Members of the family ruled simultaneously in M., Theessaly, and Jerusalem. On the death of the Marquis John I. in 1305, his sister, Iolande or Irene, who was Empress of Constantinople, succeeded to M.; and her second son became the founder of the family of Montferrat-Palaologus, which became extinct in 1533, and M. passed to the Gonzagas of Mantua. In 1631, the dukes of Savoy obtained possession of a portion of M., and in 1703, with the consent of the German Emperor, the remaining portion passed under their sway, and was incorporated with their own dominions.

MONTFORT, the name of a noble French house, descended, according to the most probable opinion, from Baldwin, Count of Flanders, and Judith, daughter of Charles the Bald. **AMAURI 2d**, Seigneur de Montfort [a little town between Paris and Chartres] is the first of the family mentioned in history. He lived in the first half of the 11th century. His son, **SIMON 1st**, had for his third wife Agnes, daughter of Richard Comte d'Evreux. He left four sons, of whom only **AMAURI 4th** had issue. The grandson of this Amauri, **SIMON 3d**, surnamed the *Bald*, Comte de Montfort and Evreux, married Amicie, daughter of Robert de Beaumont, Earl of Leicester. His second son was the famous

SIMON 4th, Comte de Montfort, and Earl of Leicester, subsequently Comte de Toulouse. This nobleman, so conspicuous in the terrible crusade against the Albigenses (q. v.), was born about the year 1150. In 1198, he went to Palestine at the head of a troop of French knights, but failed in doing anything against the Saracens, and was obliged to return. In 1202, he joined the 4th crusade, which, however, had no religious design at all (see CRUSADES), in consequence of which M. abandoned it. In 1209, he took part in the war of extermination against the Albigenses. He signalled himself by his relentless ferocity, and his brilliant successes, but was killed by a stone at the siege of Toulouse, 25th June 1218.

MONTFORT, SIMON DE, Earl of Leicester, the fourth son of the preceding, was born in France about 1206. The title of Earl of Leicester came to him by his grandmother, Amicie de Beaumont, sister and heiress of Robert Earl of Leicester, but he did not directly or immediately inherit it, for, during the reign of King John, it was borne by Ranulf, Earl of Chester. Some time after the death of Ranulf, M. came to England, and offered his services to Henry III. Already he enjoyed a great reputation as a warrior, and Henry was so highly pleased with the young French noble, that he conferred on him the title of Earl of Leicester. Little did Henry think that the stranger was to prove against himself a great founder and champion of English constitutional liberty. He married Elinor, sister to King Henry III., and the youthful widow of that Earl of Pembroke to whom, more than to any other, the people of England owe Magna Charta. After this marriage—which was viewed with disfavour by the king—De M. became a steadfast advocate of the English Charter, and of the liberties of the people. After visiting the East, he was sent by the king to undertake the command of Gascony. In 1257, the king's debts were so great, and the rapacity of his foreign relations so unbearable, that the people were in a state of insurrection. The barons assembled, and, under the direction of De M., held the celebrated parliament at Oxford. They passed statutes to enforce the provisions of Magna Charta. The king swore to observe them, but sent forthwith to the pope praying to be absolved from his oath. The bull of absolution arrived. Henry set his barons at defiance, shut himself up in the Tower, and appealed to Louis of France. England was now in arms. The whole middle class looked up to De M. as their champion and leader, and the war began with the battle of Northampton. The wars of the barons, under De M., have been superficially viewed but as the strife of turbulent nobles, who, in the absence of foreign warfare, employed themselves in getting up a contest at home. Later researches, however, have shewn that but for the struggles of De M. and the barons, the concessions at Runnymede would have been a mere worthless parchment. At Lewes, the royal forces were signally discomfited, and the king taken captive. A French chronicler, who praises De M. as 'noble, chivalrous, and the ablest man of the age,' expressly adds that he was 'backed by the general favour of the people,' who at this time were so 'unspeakably trampled under foot, and deprived of all their liberties.' The conditions exacted from the king were, that he should observe Magna Charta and the Charter of the Forests; be moderate in his expenses and grants; his old debts were paid off, and he was enabled to live on his own property, without oppression of merchants or the poor; and that Englishmen only should be chosen counsellors. No new pretensions were introduced, even at this

moment of triumph, and the constitutional maxim of respecting the person of the king was carefully upheld. The queen (Elinor of Provence), who was in France, now occupied herself in collecting a large army. To deliberate upon the measures to be adopted at this great crisis, writs were issued to the sheriffs, in 1265, by De M., directing them to return two knights for each county, and two citizens or burgesses for every city and borough; and from this time may be clearly dated the recognition of the Commons as an estate of the realm in parliament. Guardians had been appointed by the barons to watch over the execution of Magna Charta, but fifty years of encroachment on the part of the crown, convinced De M. that a stronger and more enduring security would be to commit the care of constitutional freedom thenceforth to the people themselves, whose interests the barons thus identified with their own. Mr Blauw, who, in his *Barons' War*, presents De M. almost for the first time in his true character, adds, that 'it should be an honest pride to us in after-times that English liberty thus owes its birth to the noblest parentage, confidence in the people.' A second war broke out, and this time the popular cause was weakened by defection and treachery. Prince Edward (afterwards Edward I.) encountered the barons at Evesham, with a greatly superior army. When defeat was inevitable, the great leader refused to flee. He 'fought stoutly like a giant for the liberties of England,' but fell, overwhelmed by numbers. 'Thus lamentably (says an old chronicler) fell the flower of all knighthood.' The death of De M. filled the whole land with mourning. Like Cromwell, whose career in many respects resembles his own, he was denied a grave by the royalists, his head being sent to Wigmore Castle, and his mutilated limbs to different towns; but the people bewailed their dead champion, and the clergy who adhered to the popular side, pointed to his glorified spirit in heaven. The influence of De M. was felt after his death. No baron was executed for bearing arms against his sovereign, and although the Oxford Statutes were formally rescinded, their spirit remained.

MONTGOLFIER, JACQUES ETIENNE and JOSEPH MICHAEL, two brothers, distinguished as the inventors of the first kind of Balloons (q. v.). They were the sons of a celebrated paper-manufacturer at Annanay, in the department of Ardèche, and early engaged themselves in the same branch of industry. Etienne, after a few successful experiments with the balloon, repaired to Paris; but though his discovery created a great sensation, and was followed out in practice by many eminent men, he obtained little pecuniary aid in carrying on his experiments, and at length retired to his native town, where he resumed the manufacture of paper, and died at Servieres, in 1799.—His elder brother, Joseph, the sharer of his labours and his glory, was a man of much genius and little education; but the two brothers were fitted to supplement each other's deficiencies, and together they made many discoveries, and were both received as members of the French Academy. Joseph invented the hydraulic screw, the calorimeter, &c., and in the latter part of his life, filled a post in the department of Arts and Manufactures. He died at Paris in 1810.

MONTGOMERY, GABRIEL, COMTE DE, a French knight of Scottish extraction, and an officer in the Scottish Lifeguard of the king of France, was born about 1530. At a tournament given, 30th June 1559, by Henry II. in honour of his daughter's marriage with Philip of Spain, the king insisted upon young M. entering the lists with him. M. reluctantly complied, and the shaft of his broken lance entering the

king's visor at the eye, Henry II. was borne insensible from the ground, and so continued for eleven days, when he died. M., although blameless, left France, and soon after embraced Protestantism in England. On the commencement of the religious wars in 1562, he returned to his native country to support the Protestant cause, and defended Rouen with great bravery. In the third religious war, he was one of the leaders of the Protestants, and gained many advantages over the royalists in Languedoc and Béarn. During the massacre of St Bartholomew, he happened to be at Paris, and owed his escape to the swiftness of his horse, and fled to England. In April 1573, he appeared off Rochelle with a small fleet, but failed in accomplishing anything, and was obliged to retire. Next year, at the head of a band of Huguenots, he landed in Normandy, and commenced war there; but being compelled at last to surrender the castle of Domfront, he was carried to Paris; and although the general to whom he surrendered had assured him of his life, he was beheaded, after long imprisonment, 27th May 1574. Brantome describes him as naturally the most nonchalant and pleasure-loving of men, but that, when once he had mounted his saddle, there was not a more daring or vigilant warrior in all Christendom.

MONTGOMERY, JAMES, a minor British poet, the son of a Moravian preacher, was born at Irvine, Ayrshire, November 4, 1771, and at the age of seven was sent to the Moravian settlement at Fulneck, near Leeds, in order to complete his education for the Moravian pastorate. At Fulneck, the course of study seems to have been too severe in its character for the young poet; the imaginative side of his mind was allowed no recognition, and it was only by stealth that he read Cowper's poems and *Robinson Crusoe*. Much of his leisure time at school was employed in the composition of verses and of music, in which he took much delight. In 1789, he ran away, and, after four years of various employment, became engaged as clerk to Mr Gales, editor of *The Sheffield Register*, for which he soon began to write political articles. In 1794, he commenced a newspaper of his own, *The Sheffield Iris*, which he continued to edit till 1825, when he retired. During the period of his editorship, M. was twice subjected to fine and imprisonment, by government. In 1795, he was fined £20, and sentenced to three months' imprisonment, for printing off some copies of a miserable ballad in which government suspected that sedition lurked, and in 1796, he was fined £30, and imprisoned for six months, for giving an account of a Sheffield riot. He received a government pension of £150 in 1835, and he died at his own house in Sheffield, April 30, 1854. His principal works are—*The Wanderer of Switzerland* (1806); *The West Indies* (1809); *The World before the Flood* (1812); and *The Pelican Island, and other Poems* (1827). A collected edition of his minor poems appeared in 1851; and in 1853, his *Original Hymns for Public, Private, and Social Devotion*, closed the series of his publications.

His poems are melodious, full of picturesque description, and the gentlest human feeling. The personages introduced in his poems are, however, only shadows, or touched with the faintest colour of character. But he claims a well-defined position among the favourite poets of his country by several of his hymns and minor poems, and by his exquisite verses on Home, which commence the third part of *The West Indies*.

MONTGOMERY, ROBERT, a preacher and verse-maker, who has gained notoriety, if not fame, was born at Bath in 1807. He graduated B.A. at Oxford in 1833, M.A. in 1838, and was ordained in

1835. In 1836, he became minister of Percy Street Episcopal Chapel, London: he afterwards removed to Glasgow, where he preached for four years, but returned to London, and resumed office at Percy Street Chapel in 1843. He died December 3, 1855. M.'s works comprise a large number of volumes in prose and verse, on themes more or less sacred. He is best known by his poems. *The Omnipresence of the Deity* (1828) has passed through 26 editions. But his celebrity may be said to have died with him, and his works have already become part of the lumber of libraries. This result has been brought about to some extent by the judgment which Macaulay passed upon *The Omnipresence* and other works by this author.

MONTGOMERY, a city and the capital of Alabama, United States, is on the left bank of the Alabama River, 415 miles above Mobile, at the head of steam-boat navigation. The city is very handsomely built, with elegant residences and gardens on a cluster of hills, on one of which is a handsome state-house. It has a law-school, several academies, 6 churches, 2 banks, 4 daily papers, marble-works, iron-foundries, and is one of the largest cotton-marts in the state. M. is connected by railways with Pensacola, Florida, and Atlanta, Georgia. It became, in 1860, the capital of the Confederate States, and continued to be the seat of government until, on the secession of Virginia, it was removed to Richmond. Pop. in 1860, 9889.

MONTGOMERYSHIRE, an inland county of North Wales, between Shropshire on the E., and the Welsh counties, Merioneth and Cardigan, on the W. Area, 483,323 statute acres, of which only about 80,000 are under tillage; pop. (1861) 66,919. The surface is almost wholly mountainous, a large portion consisting of bleak elevated moorlands; but toward the English border, there are several warm, fertile, and well-wooded valleys. The Severn, the Vyrnwy, and the Dovey are the principal rivers. The county belongs almost entirely to the basin of the Severn. The mineral wealth of M. is not great, but copper, lead, and zinc are procured, and millstones, slates, and limestone are quarried. On the uplands, the soil is poor, and suited principally for mountain pasture; but in the valleys, grain and flax are raised. Cattle and sheep, and the pure breed of Welsh ponies called 'Merlins,' are reared. The Welsh-flannel manufacture is extensively carried on in the county. The capital is Montgomery; pop. (1861) 1276, from which the county received its name, and which was so called from Roger de Montgomery, Earl of Arundel and Shrewsbury, who, in 1093, recaptured the town and castle which had been wrested during the previous year by the Welsh from the founder, Baldwin, lieutenant of the Marches to William the Conqueror and William Rufus. The county sends one member to the House of Commons. The county business is carried on at Welshpool and Newtown alternately. There is an excellent trade in cattle and horses. Offa's Dyke traverses the south-east corner.

MONTH, originally the period of the moon's revolution round the earth. If this is reckoned from the position of the moon among the stars to her return to the same position, the period is called a *sidereal* month, and consists of 27 days, 7 hours, 43 minutes, 11½ seconds; but if from new moon to new moon, it is longer, being 29 days, 12 hours, 44 minutes, 3 seconds; this is called a *synodic* month (see MOON). The latter period forms one of the three natural measures of the lapse of time, and, notwithstanding that its efficiency depends on the state of the atmosphere, it ranks next to the day in importance. There are several other periods used

by astronomers to which this name is applied, as the *tropical* or *periodic* month (27 days, 7 hours, 43 minutes, 47 seconds), reckoned from the moon's passing the equinox till her return to the same point; the *nodal* month (27 days, 5 hours, 5 minutes, 29 seconds), from ascending node to ascending node; the *anomalistic* month (27 days, 13 hours, 18 minutes, 37 seconds), from perigee to perigee; and the *solar* month, which is the twelfth part of a solar year, consisting of 30 days, 10 hours, 29 minutes, and 4 seconds. Distinct from all these is the *civil* or *calendar* month, fixed by law for ordinary purposes, and consisting of a fixed number of days—from 28 to 31—according to the particular month. The calendar months, with the number of days belonging to each, are as follow:

	Days.		Days.
1. January,	31	7. July,	31
2. February,	28	8. August,	31
" (leap years)	29	9. September,	30
3. March,	31	10. October,	31
4. April,	30	11. November,	30
5. May,	31	12. December,	31
6. June,	30		

See also the separate months under their own heads. The names by which the months are designated throughout Christendom were given them by the Romans; and though Charlemagne in the 9th c., and the French Directory in the end of last century, attempted to substitute descriptive epithets, the old-established names continue to be preferred.

MONTHOLON, CHARLES TRISTAN DE, *Comte*, afterwards *Marquis de*, descended from an ancient French family, was born at Paris, 1762. At the age of ten he entered the navy, but exchanged it for the army in 1798. His rise was rapid. He displayed great zeal on behalf of the First Consul in the revolution of 18th Brumaire, in the capacity of *chef d'escadron*. He served in a number of campaigns, and was severely wounded at Wagram. Napoleon made him his chamberlain in 1809. He was made a general of brigade in 1814, and appointed to the chief command in the department of Loire. On Napoleon's abdication, M. remained in France, but held aloof from the Bourbons. No sooner had the Emperor escaped from Elba and landed at Frejus, than M. hastened to join him. He was present at Waterloo, and accompanied Napoleon to St Helena, continuing his devoted attentions to him till he breathed his last, and being named in his will as one of his trustees, spared no exertion to carry its provisions into effect. Along with General Gourgaud, he published *Mémoires pour servir à l'Histoire de France sous Napoléon, écrits à Ste.-Hélène sous sa dictée* (8 vols. Par. 1823). He afterwards published a work entitled *Récit de la Captivité de Ste.-Hélène* (Lond. 1847). In the proclamations which Louis Napoleon issued on his landing at Boulogne in 1840, M. was named chief of his staff, and on this account he was condemned by the Chamber of Peers to 20 years' imprisonment; but he was afterwards pardoned. He died 21st August 1853.

MONTI, VINCENZO, the great regenerator of modern Italian poetry, was born 19th February 1753, in the Roman province of Ferrara, and studied in the university of Ferrara. On the termination of his studies, he repaired to Rome (1778), where the patronage of friends obtained for him the post of secretary to the pope's nephew. During his abode in Rome, he became involved in a bitter squabble with Alfieri, whose fame as the master-tragedian of Italy was then high in the ascendant—a fact which may have been unpalatable to M., in consequence of the failure of his own dramatic attempts. The assassination of Basville, the republican envoy of

France, afforded to M. a subject for his poem, *La Basvilliana*. His two succeeding poems, the *Musogonia* and the *Feroniade*, contained the bitterest invectives against France and Bonaparte; but on the appearance of a French army before Rome, M., with the inexcusable inconsistency which characterised his political conduct throughout, hastened to espouse the cause of France, and to invoke the protection of Bonaparte. M. was shortly after appointed secretary of the Cisalpine Directory; and in 1789 repaired to France, where he undertook the translation of Voltaire's poetical works. On returning to Italy, he was appointed professor in the university of Pavia; and in 1805, on Bonaparte being proclaimed king of Italy, M. was appointed state historiographer. On the fall of the Empire, M. became the eulogist of the Austrian possessors of his country. In the midst of all these political vicissitudes, he pursued with vigour his studies of the classics, and accomplished one of his greatest works, the translation of the *Iliad* into Italian verse. M. died at Milan, 13th October 1823, of an apoplectic stroke, and was sincerely lamented, notwithstanding the many opponents his hasty susceptibility had created in life. The best editions of his works are those of Milan (1825—1827, 8 vols.), and his *Opere Inedite e Rare* (Milan, 1832—1833, 5 vols.). M. had a warm admiration of Dante, and partook, in some degree, of the spirit of the great master. His chief works are distinguished by sustained grandeur of imagery and diction, by daring flights of imagination, and by the delicacy, elevation, and fire of the sentiments expressed. They are too numerous for separate notice, but the best of them rank among the noblest productions of Italian genius.

MONTILLA, a town of Spain, in the modern province of Cordova, and 20 miles south-south-east of the city of that name. It stands on a hillside rising from the south bank of a tributary of the Xenil. Manufactures of coarse linen and earthenware are carried on, and oil-mills are in operation. A famous wine is grown in the vicinity. M. is the birthplace of Gonzalo de Cordova, the 'Great Captain.' Pop. 12,100.

MONTJOIE ST DENIS, the war-cry of the old kings of France, said to be as ancient as the days of Clovis, and from which the king-of-arms, Montjoie, who had exclusive jurisdiction in France, derived his title.

MONTLUÇON, a town of France, department of Allier, is picturesquely situated on the slope of a hill on the right bank of the Cher, at the southern extremity of the Canal de Berri, 40 miles west-south-west of Moulins. It has some coarse cloth manufactures, and trade in corn, wine, and fruits. Pop. 13,293. At a distance of 10 miles are the wells of Néris-les-Bains, celebrated in the time of the Romans who have left many traces of their presence there, and still much frequented by invalids.

MONTMARTRE. See PARIS.

MONTMORENCY, ANNE, first DUC DE, Marshal and Constable of France, born March 1493, belonged to one of the oldest and greatest of the noble families of France. He received, it is said, the name of *Anne* from his godmother, Anne of Brittany. He distinguished himself by his gallantry and military skill in the wars between Francis I. and the Emperor Charles V., and was taken prisoner along with his sovereign in the battle of Pavia, which was fought against his advice. He afterwards became the leader of the French government, shewing great ability in matters of finance and diplomacy, and was made Constable in 1538; but his rough manners made him an object of dislike to

many; and the suspicions of the king having been aroused against him, he was suddenly banished from court in 1541, and passed ten years on his estates, till the accession of Henry II., when he came again to the head of affairs. In 1557, he commanded the French army which suffered the terrible defeat of St Quentin, in which he was taken prisoner. During the minority of Charles IX., M., with the Duke of Guise and the Marshal St André, composed the famous triumvirate which resisted Catharine de' Medici. In 1562 and 1567, he commanded the royal army against the Huguenots, and in both wars gained victories over them, but received a fatal wound at St Denis, and died at Paris on the following day, 12th November 1567.

MONTMORENCY, HENRI, second DUC DE, grandson of the famous Constable de Montmorency, born at Chantilly, 30th April 1595. His godfather was the great *Henri Quatre*, who always called him his 'son.' When he was 17 years of age, Louis XIII. made him Admiral, and he defeated the Huguenots in Languedoc, and took the Isle of Ré from those of Rochelle. He afterwards gained other victories over them, and in 1630 received the chief command of the French troops in Piedmont, where he defeated the Spaniards, for which he received a marshal's baton. Unhappily for himself he ventured to oppose Richelieu, who had always been his enemy, and espoused the cause of Gaston, Duke of Orleans; for this he was declared guilty of high treason, and Marshal Schomberg being sent against him, defeated him at Castelnaudary, and took him prisoner. M., although almost mortally wounded, was carried to Toulouse, sentenced to death by the parliament, and notwithstanding his expressions of penitence, and the most powerful intercession made for him—for example, by King Charles I. of England, the pope, the Venetian Republic, and the Duke of Savoy—was beheaded, 30th October 1632. M. was distinguished for his amiability and the courtesy of his manners, as well as for his valour.

MONTORO, a town in the Neapolitan province of Principato Ulteriore, built partly on the slope and partly around the base of a hill, 12 miles north of Salerno. Pop. 6200. It forms the central point of several villages, and has large markets and some linen and cloth manufactures.

MONTORO, a pleasant town of Spain, in the modern province of Cordova, built on a rocky ridge around which winds the Guadalquivir, 26 miles east-north-east of Cordova. It contains one of the best hospitals in Andalusia. Hardly any drinkable water can be obtained within the town. The heights in the vicinity are clothed with olive plantations, and oil is largely exported from this quarter. Woollens and earthenware are manufactured. Pop. 10,500.

MONTPELLIER, the capital of Vermont, United States of America, is on the Winooski River, 215 miles north-north-west of Boston. It is a picturesque village, with a handsome state-house, 5 churches, 3 banks, 5 newspapers, iron-foundry, flour-mills, and manufactures of carriages, hats, lumber, &c. Pop. about 3000.

MONTPELLIER (Lat. *Mons pessulanus* or *puellarum*), a city of France, in the department of Hérault, in 43° 36' N. lat., and 3° 50' E. long. Pop. (1862) of the town alone, 39,605. Seen from a distance, M. has an imposing appearance, from the number of its towers, steeples, and cupolas; but although its suburbs are clean and well built, the interior of the old town disappoints expectation, being chiefly remarkable for its crooked, dark, narrow, and dirty streets. The public walks, known as those of the Peyrou, and some of

the other more elevated points, afford glorious views, embracing the Mediterranean, the Alps, the Cevennes, and the Pyrenees. The most noteworthy buildings are the cathedral, the theatre, the exchange, the Hall of Justice, the prefecture, the observatory, and the university. The last, which was founded in 1196, is composed of three faculties—that of medicine, founded in the 12th c. by Arabian physicians, and still ranking among the best in Europe—that of the exact, and that of the physical sciences. M. has a botanical garden, the oldest in Europe; a public library of 35,000 volumes, and a pharmaceutical school; admirable museums, natural history and fine art collections, &c. The industrial products of M. are pigments and other chemical preparations, brandy, liqueurs, perfumes, soap, corks, sugar, cotton, woollen, and fine leather goods; and the trade, which is very important, includes, besides these articles, wine, seeds, olive-oil, and fruits. Railways to Marseille, Cette, and other ports, besides various canals, facilitate commercial and social intercourse, and few cities of the empire hold out greater attractions in regard to intellectual culture than Montpellier. Its geographical position has led to its being selected as a place of residence for consumptive patients; but the extreme clearness, and even sharpness of the air in the more elevated parts of the town, the occasional occurrence of the icy wind known as the *Mistral*, and the sudden accession of overpowering heats, would seem very materially to counteract some of its long reputed advantages.

MONTREAL, the largest city of Lower Canada and of British America, lies in lat. 45° 31' N., long. 73° 35' W., on the left bank of the St Lawrence, 180 miles above Quebec, and 200 below Lake Ontario, 400 from New York, and 2750 from Liverpool. Its eastern suburb, which is now an incorporated village, called Hochelaga, was originally the site of an Indian village of the same name, discovered in September 1535 by Jacques Cartier; and it is from his admiring exclamation at the view obtained from the neighbouring hill, that M. (corrupted from *Mont Royal*) derives its name. The westernmost permanent settlement which the French obtained in Canada, it was under them merely an outpost of Quebec, and continued to be such under British rule till 1832, when it became a separate port. Since then, the rapidity of its progress has been astonishing. By the deepening of the shallower parts of the river above Quebec, M. is now accessible to vessels of over 1800 tons burden, and drawing from 19 to 22 feet. Its harbour, lined with wharfs for a mile and a quarter, at which 125 ships could lie at one time, is, from its inland position (90 miles above the influence of the tides), perfectly safe. Situated at the head of the ocean-navigation of the St Lawrence, M. has naturally become the *dépôt* for the exports and imports of all the Canadas. At the same time, the obstruction to vessels sailing further up the river, caused by the rapids, has been surmounted by magnificent canals. The canals connecting M. with Lake Ontario have locks of 200 feet by 45, with 9 feet of water on the sills; the locks of the Welland Canal are rather smaller. As M. lies also near the confluence of the Ottawa and St Lawrence, it is in immediate connection with the vast lumber-country adjoining the former river and its tributaries; while a canal has been projected to connect the Ottawa, through Lake Nipissing, with the Georgian Bay in Lake Huron, which, if carried out, will probably bring the produce of the north-western states, as well as of Western Canada, through M., as it would give them an outlet to the ocean between 200 and 300 miles shorter than by the

Erie Canal. But even at present, while navigation is open, an extensive daily traffic is carried on, by steamers and sailing-vessels of every description, with Lake Ontario and the Ottawa district, as well as with the Lower St Lawrence; and the ships of the Montreal Ocean Steam-ship Company, by aid of a subsidy from the Canadian government, keep up a weekly communication with Liverpool, while at the same time the harbour is constantly crowded with vessels from other foreign ports. After the navigation of the St Lawrence is closed, the ocean-steamers find a harbour at Portland, Maine, which is connected with M. by a railway of 292 miles. This line belongs to the Grand Trunk Railway Company, and crosses the St Lawrence at M. by the celebrated tubular Victoria Bridge, the length of which, including its two abutments and 24 piers, is above a mile and three-quarters. By the lines of the same company, M. has railway communication with Upper Canada and the western states, and with Lower Canada as far eastwards as Rivière du Loup, in the Gulf of St Lawrence. Several other lines afford direct communication with all the important cities and towns in New York state and the states of New England. The position, therefore, of M. as a centre of commerce is perhaps unequalled, and its rapid advance in consequence has placed it, within the last few years, among the first commercial cities of the American continent—second perhaps only to New York. Its exports, imports, and duties collected during the four years previous to 1862, have been the following: 1858, exports, £684,588; imports, £2,450,815; duty collected, £384,768. 1859, exports, £608,952; imports, £3,110,714; duty collected, £467,248. 1860, exports, £1,204,143; imports, £3,066,802; duty collected, £490,770. 1861, exports, £2,083,147; imports, £3,239,515; duty collected, £478,695. According to the statements of a local paper, the arrivals of bread-stuffs in 1862 amounted to above 25 million bushels, being 2 million bushels more than in 1861, while 1861 shewed an increase over 1860 of 100 per cent. Of this about 17 million bushels were exported chiefly in sea-going vessels *via* the St Lawrence. The population has risen in like manner. In 1840, it was about 27,297; in 1852, it was 57,716; in 1854, about 65,000; in 1861, 90,323; and now (1863) it is estimated at 100,000. The number of sea-going vessels arriving in the port of M. in 1862 was 571, with a tonnage of 265,243. The harbour is open on an average about eight months, from the latter half of April to the beginning of December.

The most conspicuous building in M., which is perhaps also the finest church on the continent of America, is the Roman Catholic cathedral. Built in the Gothic style of the 13th century, it comprises seven chapels and nine aisles, and can accommodate between 6000 and 7000 people. It has six towers, of which the three on the main front are 220 feet in height; and its chief window is 64 feet high, and 32 broad. There are several other Roman Catholic churches belonging to the order of St Sulpice, to whose members chiefly M. owes its foundation, and who still hold the seigniorship of the island on which the city is built. Adjoining the cathedral, is the seminary of St Sulpice, to which a large addition has been built within the last few years at a cost of £3000. The city contains also some of the largest conventual establishments in the world. The general wealth, indeed, of the Roman Catholic Church in M. has grown enormous in consequence of the increased value of the property given to it during the early settlements of the French. The Church of England has recently erected, at an expense of above £20,000,

a new cathedral, which is very chaste in style, though somewhat small for a metropolitan see. St Andrew's Church, the most important belonging to the Church of Scotland, is also a very chaste specimen of Gothic architecture, and cost about £10,000. At about the same cost, the Methodists have built a handsome church in the florid Gothic style. Besides the Roman Catholic college in College Street, St Mary's College of the Jesuits, and a Baptist college, M. possesses an important university under the name of M'Gill College. Founded by a bequest of the Hon. James M'Gill in 1811, erected into a university by royal charter in 1821, and reorganised by an amended charter in 1852, it has now, besides its principal, the distinguished naturalist, Dr Dawson, a staff of 20 professors, and was attended in 1862—1863 by 296 students. M. is supplied with water by magnificent works, which cost about £120,000. The water is brought from the St Lawrence above the Lachine Rapids by an aqueduct five miles long to a pond, from which it is forced up by power derived from part of its surplus waters into reservoirs capable of containing 20 millions of gallons, and situated 200 feet above the level of the river. Along the side of the 'Mountain,' there is a line of mansions, which command the view that astonished J. Cartier, and which may compare with the suburban mansions of the wealthiest cities in Europe or America. M. returns three members to the provincial parliament.

MONTREAL, the large and fertile island on which the city of the same name is built, is 30 miles long, 10 miles at its greatest breadth, and contains 197 square miles. Formed by the separation of the two channels by which the Ottawa issues into the St Lawrence, its surface, except at Mount Royal, is only diversified by gentle undulations, which run from north-east to south-west, and are named *Coteaux*. The island forms a county, divided into two ridings, the East, or *Hochelaga*, and the West, or *Jacques Cartier*, each of which returns a member to the provincial parliament.

MONTROSE, a royal and parliamentary burgh and seaport of Scotland, in the county of Forfar, at the mouth of the South Esk, about 80 miles north-east of Edinburgh, and 40 miles south-west of Aberdeen. It stands on a level peninsula between the basin of the Esk—a kind of shallow lake 3 miles long by 2 miles broad, which is filled and emptied with every rise and fall of the tide—and the North Sea. A suspension-bridge, 432 feet long, connects the burgh with the suburb of the Inch, on the south side of the river. Between the town and the shore on the east are the 'Links,' or downs, of considerable extent, on which horse-races used to be held, and which affords one of the best fields for golfing in Scotland. The harbour at the mouth of the river, indicated by two light-houses, is lined with quays, wet docks, and docks for ship-building, and is one of the best on the east coast. It is accessible for vessels of large size, there being 18 feet on the bar at low-water of spring-tides. Besides the usual public buildings, there are two lunatic asylums, containing together 541 patients. Among its numerous educational institutions, the Academy is the chief. Flax-spinning is the chief manufacture, there being 4 mills, of 325 horse-power in the aggregate, employing upwards of 2000 hands, to whom above £50,000 are paid in wages, and consuming 100 tons of flax weekly. Bleaching is carried on to a considerable scale a few miles off. There are 2 saw-mills, one of them on a great scale, employing from 300 to 400 hands. Ship and boat building are also carried on to a considerable extent, and various other trades to which

a seaport naturally gives rise. In 1862, 1421 vessels, of 148,286 tons, entered and cleared. There are 111 vessels, of 14,655 tonnage, belonging to the port. The imports are chiefly coal, lime, slate, iron, flax, and manures; the exports, manufactured goods, salmon, herring, stone, sawn wood, and agricultural produce. Population in 1861, 14,563. M. unites with four other burghs in sending a member to parliament. Constituency, 470.

MONTROSE, JAMES GRAHAM, first MARQUIS OF, belonged to a family that can be traced back to the year 1128. Its first notable member was SIR JOHN GRÈME of Dundaff, who fell at the battle of Falkirk, 22d July 1298. Early in the 15th c., Sir William Graham married for his second wife a daughter of Robert III. ROBERT, the eldest son of this marriage, was ancestor of the *Grahams of Claverhouse*. The third Lord Graham, created Earl of Montrose by James IV., fell at Flodden; his eldest son at Pinkie. The next in succession became viceroy of Scotland after James VI. had ascended the throne of England. His eldest son, John, who succeeded to the earldom in 1616, married Lady Margaret Ruthven, eldest daughter of William, first Earl of Gowrie, and sister of the unfortunate nobleman who gives name to the *Gowrie Conspiracy*. The issue of this union was five daughters and one son, James, the 'great Marquis,' who was born in 1612, according to tradition, in the town of Montrose. His mother died in 1618, his father in 1626. In the following year, the boy was sent to the university of St Andrews by his guardian and brother-in-law, Archibald, Lord Napier, son of the famous inventor of logarithms. He was an apt, if not an ardent student, and during the two or three sessions of his attendance at college, acquired a very respectable amount of classical knowledge, besides exhibiting a genuine predilection for literature, which the stormy character of his after-life never quite destroyed. In his 17th year, he married Magdalene Carnegie, daughter of Lord Carnegie of Kinnaird, on which occasion he had his portrait painted by Jameson, the pupil of Van Dyck. For the next three years he lived quietly at Kinnaird Castle, pursuing his studies. On attaining his majority, he left Scotland, to travel on the continent, visited the academies of France and Italy, and perfected himself in all the accomplishments becoming a gentleman and a soldier. On his return, he was introduced to King Charles I., but owing, it is said, to the machinations of the Marquis of Hamilton, was coldly received by that monarch, and had no sooner reached Scotland, than he joined the ranks of the king's opponents, which at this period comprehended the majority of Scotchmen. M. came back in the very year (1637) when the tumults broke out in Edinburgh on the attempt to introduce the Prayer-Book. Whether his conduct at this moment was the result of chagrin, or whether he was carried away by the prevailing enthusiasm, or by the persuasions of craftier persons than himself, is difficult to say. Baillie speaks of his having been 'brought in' by 'the *canniness* of Rothes,' a phrase which appears to Mr Mark Napier to indicate that he was trepanned with difficulty into joining the League. At any rate, the youthful nobleman soon became to appearance one of the most zealous of the Covenanted lords. He was one of the four noblemen selected to compose the 'Table' of the nobility, which, along with the other Tables of the gentry, of the burghs, and of the ministers, drew up the famous National Covenant (see COVENANTS), sworn to by all ranks at Edinburgh in the spring of 1638. M. was appointed in the following summer to agitate for subscriptions

in Aberdeenshire, where the influence of the Marquis of Huntly was exercised on the side of the king. He did not, however, meet with great success. In 1639, he made three military expeditions to Aberdeenshire to overawe the royalists. The latter were in considerable force under the Marquis of Huntly, but owing to the timid, if not treacherous orders of the Marquis of Hamilton, then governor of Scotland, they were always forced to disband. M. twice took the city of Aberdeen. On the first occasion (29th March), he compelled the inhabitants to subscribe the Covenant, but did no injury to the city. His 'too great' humanity is even lamented by Baillie. On the second (25th May), he imposed on the city a fine of 10,000 merks; but though his soldiers pillaged the place, he honourably resisted the importunities of the zealots among the Presbyterian clergy, who wished to expose it to the horrors of conflagration. Baillie again complains of his 'too great lenity in sparing the enemy's houses.' The arrival at Aberdeen by sea of the Earl of Aboyne—Charles's lieutenant of the north—with some reinforcements, induced M. to retreat, who was followed by the earl and the Gordon Highlanders. At Meagra Hill, near Stonehaven, a battle was fought (15th June) between the two armies, in which M. obtained a complete victory; four days later, he was again master of Aberdeen, after a fierce struggle at the passage of the Dee. The citizens were stricken with alarm, expecting some bloody punishment for their well-known Episcopalian leanings, but M. agreeably disappointed their fears. At a subsequent period, he was upbraided by the Committee of Estates for not having burned the town on this occasion. News of 'the pacification of Berwick' now arrived in Aberdeen, and terminated the struggle in the north. Charles invited several of the Covenanting nobles to meet him at Berwick, where he was then holding his court, and to consult with him about Scottish affairs. Among those who went was M., and the Presbyterians dated what they regarded as his apostasy from that interview. Be that as it may, his political position was certainly different after his return. In the General Assembly which met, August 13, 1639, under the presidency of the Earl of Traquair, as royal commissioner, he shewed symptoms of disaffection towards the Covenant, and was the object of much popular obloquy. One night he is said to have found affixed upon his chamber-door a paper bearing these words, *Invictus armis, verbis vincitur*. The dissolution of the parliament, in June 1640, led to an open rupture between the king and the Covenanters, and both parties prepared to decide their quarrel by force of arms. The former assembled at York an army of 21,000 horse and foot; the latter another of 26,000, which, under the command of Leslie, crossed the Tweed, 21st August 1640. M. was the first man that forded the stream. The successes of the Scots, as is well known, soon forced Charles to summon a new parliament for the settlement of the national grievances. Meanwhile M., along with several other influential nobles, had entered into a secret engagement at Cumbernauld, for the purpose of frustrating what they regarded as the factious designs of the extreme Covenanting leaders. His conduct in England, too, had been suspicious. It was accidentally discovered that he had been secretly communicating with the king; and when the parliament assembled (November 1640), he was cited to appear before a committee. The affair of the *Cumbernauld Bond*, discovered by the ingenuity of Argyle, was brought up; but M. defended his conduct and that of his colleagues; and nothing came of it, though some

fiery spirits among the clergy, says Guthrie, 'pressed that their lives might go for it.' In the following June, M. and some others were accused of plotting against Argyle, and were confined in Edinburgh Castle, where they remained till the beginning of 1642, when they were set at liberty in return for the concessions which Charles had made his Scottish subjects. Although they had been frequently examined, nothing definite had been proved against them. The accusation that M. had offered to the king to assassinate Argyle, is not historically substantiated, and is intrinsically improbable. During the next two or three years, he kept aloof, outwardly, from public affairs, but he had finally broken with the Covenanters, and had privately ranged himself on the side of the king. The civil war in England had now broken out, and was being carried on with dubious success. Charles and his advisers resolved to crush the Presbyterian leaders in Scotland, who were abetting the efforts of the English Parliamentarians. In the spring of 1644, M., now raised to the rank of marquis, left Oxford, where he had been residing with his sovereign, and proceeded to Scotland to raise the royalists in the north. The battle of Marston Moor for a moment paralysed him, but his resolution speedily returned. He threw himself into the Highlands, and after skulking about the hills for some time in disguise, met at Blair-Athol some Irish auxiliaries and a body of Highlanders under Allaster Maccoll Keitache Macdonald, better known as *Colkitto*, who had forced their way thither from the Western Isles in hopes of joining him. M. instantly placed himself at their head, and the clans quickly rallied round his standard. Marching south, he fell suddenly (1st September) on the Covenanting army commanded by Lord Elcho, at Tippermuir, near Perth, and gained a complete victory. Not a single royalist was slain. The same night, M. entered Perth, where he remained for three days, levying a fine of 9000 merks on the inhabitants. He then set out for the north, defeated a force of Covenanters under Lord Bursleigh at Aberdeen (September 13), and took possession of the city, which was abandoned for four days to all the horrors of war. The approach of Argyle, at the head of 4000 men, compelled M., whose forces were far inferior in numbers and discipline, to retreat. He now plunged into the wilds of Badenoch, recrossed the Grampians, and suddenly appeared in Angus, where he wasted the estates of more than one Covenanting nobleman. Having obtained fresh supplies, he once more returned to Aberdeenshire, with the view of raising the Gordons, narrowly escaped defeat at Fyvie in the end of October, and again withdrew into the fastnesses of the mountains. Argyle, baffled in all his attempts to capture or crush M., returned to Edinburgh, and threw up his commission. His opponent, receiving large accessions from the Highland clans, planned a winter campaign, marched south-westward into the country of the Campbells, devastated it frightfully, drove Argyle himself from his castle at Inverary, and then wheeled north, intending to attack Inverness, where the Covenanters were posted in strong force under the Earl of Seaforth. The 'Estates' at Edinburgh were greatly alarmed, and raising a fresh army, placed it under the command of General Baillie, a natural son of Sir William Baillie of Lamington. After consulting with Argyle, it was arranged that he should proceed by way of Perth, and take M. in front, while Argyle should rally his vast array of vassals, and attack him in the rear. The royalist leader was in the great glen of Albin—the basin of the Caledonian Canal—on his way to Inverness, when he heard that Argyle was following him. He

instantly turned on his pursuer, fell upon him unexpectedly at Inverlochry, February 2, 1645, and utterly routed his forces. Fifteen hundred of the Campbells were slain, and only four of M.'s men. He then resumed his march northwards, but did not venture to assault Inverness—his wild mountaineers being admirably fitted for rapid irregular warfare, but not for the slow work of beleaguering. Directing his course to the east, he passed—with fire and sword—through Elgin and Banff into Aberdeenshire, which suffered a similar fate. Baillie, and his lieutenant, Hurry, were at Brechin, but M., by a dexterous movement, eluded them, captured and pillaged the city of Dundee (April 3), and escaped safely into the Grampians. On the 9th of May, he attacked and routed Hurry at Auldearn, near Nairn; and after enjoying a short respite with his fierce veterans in Badenoch, again issued from his wilds, and inflicted a still more disastrous defeat on Baillie himself at Alford, in Aberdeenshire (July 2). There was now nothing to prevent his march south, and about the end of the month, he set out with a force of from 5000 to 6000 men. He was followed by Baillie, who picked up reinforcements on his way, and on the 15th of August again risked a battle at Kilsyth, but was defeated with frightful loss—6000 of the Covenanters being slain. The cause of Charles was for the moment triumphant; M. was virtually master of the country. The king formally appointed him lieutenant-governor of Scotland, and commander-in-chief of the royal forces. All the principal cities in the west hastened to proclaim their fidelity, and laid the blame of the recent troubles on the unfortunate Presbyterian clergy. But affairs soon took a very different turn. Great numbers of the Highlanders returned home—we might even say, deserted—burdened with multifarious plunder; and the Earl of Aboyne withdrew with all his cavalry. M.'s position in a district teeming with enemies, was growing critical, and on the 4th of September he broke up his camp at Bothwell, and marched for the eastern counties, where Charles had informed him that the Earls of Traquair, Home, and Roxburgh were ready to join him. In this he was disappointed, and on the 13th of the same month he was surprised at Philiphaugh, near Selkirk, by David Leslie, who fell upon the relics of M.'s army and his raw levies with 6000 cavalry—the flower of the Scottish forces then serving in England—who had been hurriedly despatched home on the news of M.'s startling successes. Leslie completely annihilated his opponent. 'On Philiphaugh,' says Sir W. Scott, 'M. lost the fruit of six splendid victories.' Escaping from the field of battle, he made his way to Athol, and again endeavoured, but in vain, to rouse the Highlands; and at last Charles, now beginning to get the worst of it in the civil war, was induced to order him to withdraw from the kingdom. On the 3d of September 1646, he sailed for Norway, whence he proceeded to Paris. Here he endeavoured, but in vain, to induce Henrietta Maria to bestir herself on behalf of her husband. The queen coldly received all his suggestions, and at last M., in despair, betook himself to Germany, in hope of service under the emperor, but soon after returned to Holland, and entered into communications with the Prince of Wales, afterwards Charles II. It was here that news of Charles I.'s execution reached him. M. fainted on receipt of the dreadful intelligence, and gave way to the most passionate regrets. Charles II. now re-invested him with the dignity of lieutenant-governor of Scotland, and M. undertook a fresh invasion on behalf of the exiled monarch. In March 1650, he arrived at the Orkneys with

a small force, and after the lapse of three weeks, proceeded to Caithness; but neither the gentlemen nor the commons would rise at his call. He forced his way as far south as the borders of Ross-shire, where his dispirited troops were attacked and cut to pieces at a place called Corbiesdale, near the pass of Invercarron, by a powerful body of cavalry under Colonel Strachan. M. fled into the wilds of Assynt, where he was nearly starved to death, when he fell into the hands of M'Leod of Assynt, who delivered him up to General Leslie, by whom he was brought to Edinburgh. Condemned to death as a traitor to the Covenant, he was executed, 21st May 1650. His demeanour in his last moments was very noble and dignified.

MONTSERRAT, one of the Lesser Antilles, belonging to Britain, lies 43 miles north-west of Guadeloupe, and at a similar distance from Antigua and St Kitts. It is about 11 miles in length, 7 in breadth, and contains an area of 47 English square miles. The population in 1859 was 7053, the females exceeding the males by 735. About two-thirds of the surface is mountainous and barren, the rest is well cultivated. The chief products are sugar, rum, and molasses; but cotton, arrow-root, and tamarinds are also exported. The island forms a portion of the government of the Leeward Isles, and is directly ruled by a president, aided by a council and house of assembly. The chief town is Plymouth, on the south coast. The revenue of M. in 1860 amounted to £3333, and the expenditure to £3243. In the same year, 203 vessels of 7825 tons entered, and 194 vessels of 7450 tons cleared its port; and the total values of imports and exports were respectively £20,060 and £17,043.

MONTSERRAT (Lat. *Mons Serratus*, so named from having jagged ridges like the teeth of a saw), a mountain of Catalonia, in the north-east of Spain, about 30 miles from Barcelona. Its height is 3919 feet. 'Its outline,' says Ford (*Handbook for Spain*, vol. i. p. 419), 'is most fantastic, consisting of cones, pyramids, buttresses, nine-pins, sugar-loaves, which are here jumbled by nature in a sportive mood.' The pious Catalonians aver that it was thus riven and shattered at the Crucifixion. Every rift and gorge is filled with box-trees, ivy, and other evergreens. From the topmost height, the eye wanders over all Catalonia, and from the sea the ridge looks like an immense wall with seven pyramidal peaks. The mountain, however, owes its celebrity not to its extraordinary appearance, but to the Benedictine Abbey built upon it, at an elevation of 1200 feet, and to the 13 hermitages formerly perched like eagles' nests on almost inaccessible pinnacles. In 1811, the French, under Suchet, plundered the abbey, burned the library, shot the hermits, and hung the monks (who had given shelter to their emigrant brethren at the Revolution). The place suffered still more in 1827, when it became the stronghold of the Carlist insurrection.

MONUMENT (Lat. *monumentum*, from *mones*, to remind), anything durable made or erected to perpetuate the memory of persons or events. The chief kinds of monuments are described under their special names. See CAIRN; CROMLECH; SEPULCHRAL MOUNDS; PILLAR; OBELISK; PYRAMID; ARCH; TRIUMPHAL; BRASSES; TOMB; STUPA; MAUSOLEUM, &c.

MONZA (anc. *Medetia*), chief town of a district in the province of Milan, stands on the river Lambro, 10 miles north-north-east of Milan, with which it is connected by railway. Pop. above 20,000. It is essentially a town of Lombard growth, and under the Lombard sovereigns was capital of their kingdom.

It owes much of its early importance, and its chief public edifices, to Theodolinda, the great queen of the Lombard dynasty. In the middle ages, M. was conspicuous for the wealth of its numerous citizens and nobles, and the extent of its cloth-trade. It has undergone 32 sieges. The cathedral, founded in the 6th c. by Theodolinda, contains many interesting memorials of this great queen. The famous Iron Crown (q. v.) and regalia of Lombardy, employed at the coronation of the German emperors as kings of Italy, were removed from Lombardy by the Austrians in 1859, on the cession of that province to France. The town has a good gymnasium, a theatre, two hospitals, and a philharmonic institution. Its present manufactures of cottons, hats, and preserved meats are daily increasing. M. is surrounded by an exuberantly fertile district, which yields abundance of grain, fruits, wine, and silk, and possesses great beauty of scenery and climate.

MOON, THE, the satellite of the earth, revolving round the earth from west to east in a period of one *Month* (q. v.), and in consequence accompanying the earth in its motion round the sun. As the moon, to an observer on the earth, advances more than 13° to the east daily, whilst the corresponding advance of the sun is barely 1°, her progress among the stars is much more notable than that of the latter. This rapid angular motion, the continual and regular variation of her illuminated surface, and her large apparent size (being nearly equal to that of the sun), have rendered the moon an object of general interest; while her importance as the principal nocturnal substitute for the sun, and her special value to navigators and geographers, in the determination of longitudes (see **LATITUDE** and **LONGITUDE**), have rendered the *lunar theory* the object of the most thorough and careful investigation.

Phases of the Moon.—The first peculiarity about the moon that strikes a casual observer, is the constant and regular change of her illuminated surface from a thin crescent to a circle, and *vice versa*, and a corresponding change in the time of her appearance above the horizon. These changes depend upon the position of the moon relative to the earth and the sun (fig. 1), for it is only the half

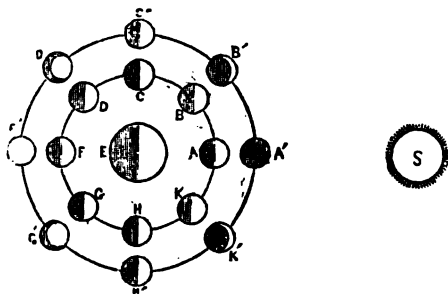

Fig. 1.—Phases of the Moon :

A, B, C, D, F, G, H, K, appearances presented by the moon to an observer situated at the pole of her orbit; A', B', C', D', F', G', H', K', 'phases' of the moon at the end of each eighth part of her course; S, position of sun; E, position of earth.

of the moon facing the sun that is illuminated by his rays, and the whole of this illuminated portion can only be seen from the earth when the sun, earth, and moon are in a straight line, S, A, E, F (the *line of syzygies*), and the earth is between the sun and moon. When the moon is in the line of syzygies, but between the earth and the sun, no part of her illuminated disc can be seen from the earth, A'. In

the former case, the moon is said to be *full*, and in the latter, *new*. A few hours after 'new moon,' the moon appears a little to the east of the sun as a thin crescent, with the horns pointing towards the east, and as she increases her angular distance from the sun at the rate of about 12° daily, the crescent of light becomes broader, till, after the lapse of a little more than seven days, at which time she is 90° in advance of the sun, she presents the appearance of a semi-circle of light, C'. The moon is then said to have completed her *first quarter*. Continuing her course, she becomes 'Gibbous' (q. v.); and at the 15th or 16th day from new moon, attains a position 180° in advance of the sun, and now presents the appearance known as *full moon*, E'. From this point she begins to approach the sun, again appearing gibbous, and after a third period of more than seven days, reaches a point 90° west of him, and enters her *last quarter*, H'. Here, again, she appears as a semicircle of light, the illuminated portion being that which was not illuminated at the end of the first quarter. The moon now rapidly approaching the sun, resumes the crescent form, but this time with the horns pointing *westward*, the crescent becoming thinner and thinner,



Fig. 2.—Crescent Moon.

till the moon reaches the position of new moon, and disappears. From 'full moon' to 'new moon,' the moon is said to be *waning*; and from 'new moon' to 'full moon,' *waxing*. The earth as seen from the moon presents similar phases, and has, consequently, at the time of new moon, the appearance of a round illuminated disc, and at full moon, is invisible. This explains the peculiar phenomenon occasionally observed when the moon is near the sun (either before or after new moon), of the part of the moon's face which is unilluminated by the sun appearing faintly visible, owing to the reflection upon it of strong earth-light. This phenomenon is designated by the Scottish peasantry as 'the new mune wi' the auld mune in her airms.' At new moon, the moon of course comes above the horizon about the same time as the sun, and sets with him, but rises each day about 50 minutes later than on the day previous, and at the end of the first quarter, rises at mid-day, and sets at midnight, continuing to lag behind the sun. When at the full, she rises about sunset, and sets about sunrise, and at the commencement of her last quarter, she rises at midnight, and sets at mid-day.

Distance and Magnitude.—From repeated observations of the moon's horizontal *Parallax* (q. v.), and of the occultations by her of the fixed stars, her

mean distance* from the earth has been estimated at 237,600 miles, and as her angular diameter averages $31' 26''$, her actual diameter is 2153 miles, or a little less than $\frac{1}{4}$ ths of the earth's diameter. Her volume is therefore about $\frac{1}{4}$ th of that of the earth, and her density being only $\frac{1}{577}$ (that of the earth being taken as unity), her mass is only $\frac{1}{81}$ th of the earth's mass; consequently, the force of gravity at her surface is so much less than it is at the surface of the earth, that a body which weighs 1000 pounds here, would at the moon weigh only 163 pounds.

Orbit.—The moon revolves round the earth in an elliptic orbit, with the earth in the focus; the eccentricity of the ellipse being equal to $\cdot 05491$ of half its major axis, or more than $3\frac{1}{2}$ times that of the earth's orbit. The plane of her orbit does not coincide with the ecliptic, but is inclined to it at an angle of $5^{\circ} 8' 47\cdot 9''$, and intersects it in two opposite points, which are called the *Nodes* (q. v.). The point at which the moon is nearest to the earth is called her *perigee*, and that at which she is furthest from it her *apogee*, and the line joining these two points is called the *line of apsides*. Were the moon's orbit a true ellipse, which, owing to various irregularities known as *perturbations*, it is not, the *lunar theory* would be exceedingly simple; but these perturbations, which, in the case of the planets, produce a sensible variation in their orbit only after many revolutions, cause, in the case of the moon, a distinct and well-marked deviation from her previous course in a single revolution. The retrogradation of her nodes along the ecliptic causes a continual change in the plane of her orbit, so that if, during one revolution round the earth, she occults certain stars, at the next revolution she will pass to one side of them, and will remove further and further from them in each successive revolution. A little consideration will shew that by this continual change of her orbit, the moon will, in course of time, pass over or occult every star situated within $5^{\circ} 24' 30''$ of the ecliptic. The motion of the nodes is so rapid that they perform a complete circuit of the orbit in 6793·39 mean solar days, or 18·6 years. Another important change in the moon's orbit is the revolution of the line of apsides, by which the perigee and apogee are continually changing their position relative to the earth and sun. This revolution is more than twice as rapid as that of the nodes, being performed in 3232·57 mean solar days, or 8·85 solar years. As this motion is common to all the heavenly bodies, its nature and origin will be treated of under the head of *Perturbations* (q. v.). Its effect upon the moon is to produce a variation in her distance from the earth, independent of that produced by her elliptic motion.

Eclipses.—As the moon in her course passes the sun at the commencement of every (synodic) month, and by the middle of the month has placed the earth between herself and the sun, it is evident that if she moved in the plane of the ecliptic, there would be either a *total* or an *annular eclipse of the sun* at the commencement, and a *total eclipse of the moon* in the middle of every month. The inclination of her orbit allowing her to pass the sun $5^{\circ} 9'$ to the north or south of his track, prevents such a frequent occurrence of eclipses. If the moon, when in conjunction, is at either of her nodal points, and at the same time near her perigee, a total eclipse of the sun

* When the moon is at the *perigee*, she is within 225,000 miles, and when at the *apogee*, more than 251,000 miles from the earth; her angular diameter as measured from the earth consequently varies from $28' 45''$ to $33' 30''$, and for a particular day is greatest when she is on the meridian, as in this case she is nearer to the spectator by about 4000 miles, than when she is on the horizon.

takes place; but if near her apogee, the eclipse is only *annular*, for at that time her apparent diameter is less than the sun's. If, also, at her conjunction, her latitude north or south is less than the sum of her semidiameter and of that of the sun, a *partial* eclipse takes place, and is greater the nearer the moon is to her node. These partial eclipses are seldom seen from all parts of the earth's illuminated surface, but are confined to a portion of it, which is greater or less according to the extent of the eclipse. Lunar eclipses, which occur when the moon is in opposition (i. e., at full moon), are seen equally from all parts of the earth's surface which are turned towards her. The conical shadow of the earth which is projected into space on the side opposite to the sun, is in length equal to about $3\frac{1}{2}$ times the moon's mean distance, and a section of it at the moon's distance is $1^{\circ} 23'$ in diameter. If, then, the moon, which is never more than $33\frac{1}{2}'$ in diameter, happens to be at or near her node, a *total* eclipse will take place, and in no case can it be *annular*, as is sometimes the case with those of the sun. Even during total eclipses, the moon is seldom quite invisible, but generally shines with a faint copper-coloured light. See ECLIPSES.

Rotation.—The moon, like all other satellites, as far as at present known, revolves round her own axis in precisely the same time that she revolves round the earth; she thus presents always the same face to us, and consequently, though her comparative proximity has enabled us to become better acquainted with her surface than with that of any other heavenly body, our knowledge is confined to one-half of her surface, with the slight exception of the knowledge obtained from her *Libration* (q. v.). To the inhabitants of the side of the moon next the earth—if the moon had inhabitants, which is very improbable—the latter would appear as a luminary about 2° in diameter, immovably fixed in their sky, or at least changing its position only to the extent due to the moon's libration. The earth would thus seem to them to have a disc about 15 times larger than that of the sun.

Physical Features.—The surface of the moon, as seen from the earth, presents a most irregular grouping of light and shade (fig. 3). The dark

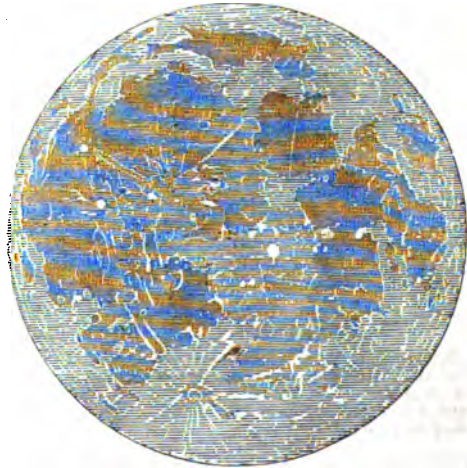

Fig. 3.—Telescopic appearance of the Moon.

portions were named by the earlier astronomers as seas, lakes, &c., and still retain these names, although there is strong evidence against the supposition that the moon, or at least that portion of it

presented to us, contains any water. The brighter parts of the moon are mountainous, as is proved by the fact of their casting shadows when the sun's rays fall upon them obliquely, and also by the ragged appearance presented by the interior illuminated border of the moon, as shewn in fig. 2, an appearance which can only be satisfactorily accounted for on the supposition that the surface of the moon is not level, in which case the higher portions will be illuminated some time before the light reaches the level parts; and it is observed that as the illumination proceeds, bright spots start up in advance of it, and when the moon is on the wane, these same spots continue to shine for some time after the surrounding surface is immersed in gloom. The mountains occur either singly, when they are generally of a circular form, and are called *craters*, or in groups, which are mostly annular, and form a sort of wall enclosing a deep depression or plain, in which are situated one or more conical mountains. The craters are not unfrequently 8 or 10 miles in diameter, and some of the walled plains measure more than 100 miles across. The principal mountain range is the Apennines, which crosses the surface from north-east to south-west, and attains, according to some authorities, an altitude of about 20,000 feet, though Sir John Herschel gives about 2 miles as the probable limit of elevation above the moon's surface. The heights are estimated from a micrometric measurement of the length of their shadows, a method not, in this case, susceptible of much accuracy. The moon everywhere presents traces of volcanic agency, but no active volcanoes have yet been discovered, nor is there any sign of recent volcanic action. Seen through the telescope, she presents a bleak, desolate appearance, without indications of animal or vegetable existence. She appears to be devoid of an atmosphere, or if one exists, it must be of exceeding rarity.

The influence of the moon in causing *Tides* (q. v.) has long been well known, and there is some reason for supposing that she produces a similar effect on the atmosphere, combining with other causes in the generation of winds. Those winds which prevail about the time of new and full moon, and at the vernal and autumnal equinoxes, are particularly ascribed to her influence. On the supposition that the moon might also affect organic nature, experiments were instituted by Mead, Hoffmann, and others; but no certain results were attained. The periodicity which has often been noticed in certain diseases, especially in insanity (hence called *lunacy*), was long supposed to have some connection with lunar influence, and this opinion is held to some extent at the present day. The chemical effects of the moon's rays are, so far as is at present known, feeble, though in particular instances they exhibit an *activism* as powerful as that of the sun. Decomposition of animal matter takes place more rapidly in moonshine than in darkness, and the moon's rays, when concentrated, have a sensible effect on the thermometer.

The best map of the moon is the large and accurate one of MM. Beer and Mädler, which presents a most minutely detailed picture of her visible surface; the map is 3 feet in diameter. See, for further information, the articles PERTURBATIONS; LIBRATION; NODES; EJECTION; METONIC CYCLE; TABLES, LUNAR, &c.

Superstitions regarding the Moon.—The moon was anciently an object of worship, and even in the 17th c. she was supposed, by the common people of England, to exercise great influence over human affairs. The times for killing animals for food, gathering herbs, cutting down wood for fuel, sowing seeds of

various kinds, were all regulated by the 'age' of the moon, and these set periods were considered to be a necessary part of practical knowledge, and ignorance or neglect of them to be infallibly productive of loss. There were similarly defined periods for taking particular medicines, and attempting the cure of particular diseases. Many such superstitions prevailed till a recent period in the Highlands of Scotland, favourable or unfavourable consequences from any occurrence being predicted according to the age of the moon at the time it happened. Throughout Scotland, the waning moon was considered to have an evil influence, and full or new moon to be the most suspicious season for commencing any enterprise. The same opinion was held in Scandinavia and Germany, and the history of all nations teems with similar superstitions. See the article ECLIPSES.

In the Edda, we read that 'Mundilföri had two children—a son, Máni (moon), and a daughter, Sól (sun);' and in German, the moon is masculine and the sun feminine to this day. It was the same in Ang-Sax; although modern English has in this matter followed the classic mythology, in which Phœbus and Sol are gods; and Selene, Luna, and Diana, are goddesses; Grimm (*Deutsche Mythologie*, p. 666) quotes an old invocation to the 'New Moon, gracious lord' (Neuer Mon, holder herr), for increase of wealth; and down to recent times the German people were fond of speaking of 'frau sonne,' and 'herr mond' ('lady sun,' and 'lord moon'). The same inversion (as it appears to us) of gender is found among the Lithuanians and Arabians, and even the ancient Mexican *Meztle* (moon) was masculine. Among the Slaves, according to Grimm, the moon is *mas*, a star *fem*, and the sun *neut*. In Hindu Mythology, also, the moon—Chandra or Soma—is a male deity, represented by one myth as the son of the patriarch Atri, who procreated him from his eyes, but by another, as arising from the milk-sea when it was churned by the gods for the attainment of the beverage of immortality. His wives are the 27 daughters of the patriarch Daksha, known as the nymphs of the lunar constellations. By one of them, Rohin'ī, he had a son Budha (not to be confounded with Buddha), the regent of the planet Mercury, who begot on Ilā, a son, Purūrasva, who became the ancestor of a royal family, hence called the lunar dynasty.—The moon is generally represented as wearing white garments, with a mace in one hand, and riding in a chariot drawn by ten horses or antelopes. The animal sacred to him is the hare (the Hindus believing that an outline like that of a hare is visible on the moon); and the plants under his special patronage are a certain variety of the lotus, which flowers when the moon rises, and the Soma plant, or *Aclepias acida*. As the receptacle of the beverage of immortality, he is thus described in the Vishn'u-Purān'a: 'The radiant sun supplies the moon, when reduced by the draughts of the gods to a single digit, with a single ray; and in the same proportion as the ruler of the night is exhausted by the celestials, it is replenished by the sun . . . ; for the gods drink the nectar accumulated in the moon during half the month; and from this being their food, they are immortal: 33,000, 3300, and 33 divinities drink the lunar nectar. When two digits remain, the moon enters the orbit of the sun, and abides in the ray called Amā In that orbit, the moon is immersed for a day and night in the water, thence it enters the branches and shoots of the trees, and thence goes to the sun. . . . When the remaining portion of the moon consists of but a 15th part, the manes approach it in the afternoon, and drink the last

portion, that sacred digit which is composed of nectar. . . . In this manner the moon, with its cooling rays, nourishes the gods in the light fortnight (or the 15 days of the moon's increase), the manes in the dark fortnight (when in the wane); vegetables, with the cool nectary aqueous atoms it sheds upon them; and through their development it sustains men, animals, and insects, at the same time gratifying them by its radiance.

MOON, MOUNTAINS OF THE. The 'Mountains of the Moon' have ever played an important part in the history of African geography, and have given rise to many curious hypotheses. Ptolemy, and until lately, many of the ablest geographers, supposed that a very high chain of mountains crossed the continent of Africa from east to west; and they have continued to shift these mountains from one latitude to another, ranging from 10° north to 10° south, but still keeping them within nearly the same meridional bounds. Dr Beke, from his own researches and a minute study of the geography of Eastern Africa, propounded the theory, that the so-called Mountains of the M. run from north to south parallel to the coast of Zanzibar, instead of from east to west; forming, in fact, a continuation of the great Abyssinian table-land, and embracing the snow-capped mountains of Kenia and Kilimandjaro, which have a supposed altitude of from 12,000 to 20,000 feet.

The mass of mountains discovered by Captain Speke in 1858, round the head of Lake Tanganyika, is considered by him, both from its crescent form and its position, to be part of the Mountains of the M. of Ptolemy; but mountains of this height (6000 to 10,000 feet) could never be snow-clad so near the parallel of the equator.

MOONJAH, MUNJAH, or MOONYAH (*Saccharum Munja*), a grass of the same genus with the sugar-cane, a native of India, the leaves of which afford a useful fibre, of which ropes are made. The M. grows in vast abundance in the neighbourhood of the Ganges, Indus, and other rivers. The fibre of the M. is very tough and strong. No proper trial seems yet to have been made of the qualities of the M. fibre, more carefully prepared; but considering the facility with which it could be obtained in any desirable quantity, it seems to deserve attention.—Very similar to the M. is the SARA or SHUR of Bengal (*Saccharum Sara*), another species of the same genus, the leaves of which are employed in the same way.

MOONSTONE. See FELSPAR.

MOORE, JOHN, M. D., a Scottish physician and miscellaneous writer, son of the Rev. Charles Moore, an Episcopalian clergyman, was born at Stirling, in 1730. Educated at the university of Glasgow, he began the study of medicine and surgery under Dr Gordon, surgeon, of that city, which study he followed up in Holland, London, and Paris, and then, as the partner of his old master, Dr Gordon, began to practise in Glasgow. As medical attendant to the Duke of Hamilton, he spent five years in travelling on the continent, and on his return in 1778, settled in London. In 1779, he published *A View of Society and Manners in France, Switzerland, and Germany* (Lond. 2 vols. 8vo). In 1781, appeared *A View of Society and Manners in Italy* (2 vols. 8vo); in 1786, his *Medical Sketches*, in two parts; and in 1789, *Zeluco*, a novel (2 vols. 8vo)—the principal, or, at anyrate, the most popular of his works. His other works are—*A Journal during a Residence in France, 1792* (2 vols. Lond.), descriptive of scenes witnessed while at Paris in the autumn of that year as medical attendant of the Earl of Lauderdale; *A View of the Causes and*

Progress of the French Revolution (2 vols. Lond. 1795); *Edward*, a novel (Lond. 1796); and *Mordaunt*, a novel (Lond. 1800, 3 vols. 8vo). He also edited a collected edition of Smollett's works, with a life of the author. He died at Richmond in Surrey, Feb. 20, 1802.

MOORE, SIR JOHN, English general, born at Glasgow, 1761, was eldest son of the preceding. He entered the army as ensign when only 15, and served with distinction in Corsica, as colonel; in the West Indies, as brigadier-general; in Ireland during the rebellion of 1798, and in the expedition to Holland, as a general of staff. He was in Egypt with the army under Abercromby, and obtained the order of the Bath for his services in command of the reserve. When war again broke out in 1802, M. served in Sicily and Sweden. In 1808, he was sent with a corps of 10,000 men to strengthen the English army in the Peninsula. He arrived in Mondego Bay, August 19, and assumed the chief command on the return to England of Sir H. Burrard. In October he received instructions to co-operate with the forces of Spain in the expulsion of the French from the Peninsula. He moved his army from Lisbon, with the intention of advancing by Valladolid, to unite himself with the Spanish general Romana, and threaten the communications between Madrid and France. But the apathy of the Spaniards, and the successes of the French in various parts of the Peninsula, soon placed him in a critical position. Yet he had determined to make a bold advance from Salamanca to attack Soult, when the news reached him that Madrid had fallen, and that Napoleon was marching to crush him at the head of 70,000 men. M.'s forces amounted to only 25,000 men, and he was consequently forced to retreat. In December, he began a disastrous march from Astorga to Coruña, a route of near 250 miles, through a desolate and mountainous country, made almost impassable by snow and rain, and harassed by the enemy. The soldiers suffered intolerable hardships, and arrived at Coruña in a very distressed state. It was impossible to embark without fighting, and Soult was in readiness to attack as soon as the troops should begin to embark. The battle was mainly one of infantry, for the cavalry, after destroying their horses, had gone on board, and the bulk of the artillery, for which the ground was not adapted, had also been withdrawn. On the 16th January 1809, the French came on in four strong columns. A desperate battle ensued. While animating the 42d Regiment in a brilliant charge in an early stage of the action, M. was struck by a cannon-ball on the left shoulder, and died in the moment of victory. The French were defeated with the loss of 2000 men; and the funeral obsequies of the deceased soldier were performed with melancholy solemnity just before the embarkation of his troops. The British army in this expedition lost their magazines and 6000 soldiers. A monument was erected to M.'s memory in St Paul's Cathedral.

MOORE, THOMAS, the son of a small tradesman, who, through the influence of Lord Moira, afterwards became a barrack-master in the army, was born in Dublin on the 28th May 1779. At an early age, he was placed at a school in which Sheridan had formerly been a pupil. In 1793, he was sent to the Dublin University, where he ultimately took the degree of B.A. Before entering the university, he had written verses for a Dublin magazine; and while there, he translated the *Odes* of Anacreon, in the hope of obtaining a classical premium, in which, however, he was disappointed. In Dublin, he acquired Italian and French, and being fond of music, he learned to play on the piano—

accomplishment which was of service to him in his futuro career.

In 1798, with his translation of Anacreon in his pocket, he came to London to study law, and entered himself in the Middle Temple. In 1800, he published his translations, dedicated to George IV., then Prince of Wales. In 1802, he produced his *Poetical Works of the Late Thomas Little*—a volume of sweet but licentious verse, which was a good deal blamed, and very widely read. In 1803, through the influence of Lord Moira, he was appointed to a government post at Bermuda. He arrived there in January 1804; but finding his situation disagreeable, he committed his duties into the hands of a deputy, and travelled in America previous to his return to England. His transatlantic experience seems to have cured him of the democratic ideas which he had imbibed in Dublin. On his return to England, he published *Odes and Epistles*, for which he was sharply taken to task in the *Edinburgh Review*. A duel between himself and Jeffrey was the consequence—over which Byron made so much mirth—and which resulted in the combatants becoming the most excellent friends. In 1807, he engaged with Mr Power to produce the *Irish Melodies*, and on this work he was engaged at intervals up till 1834. In 1811, he married, and shortly after, he went to reside in Derbyshire, where in 1813 he produced *The Twopenny Post-bag*, full of brilliant fancy—in which the tropes not only glittered but stung.

As up to this time he had produced nothing but fugitive pieces, he became anxious to emulate his brethren, who wrote long poems, and published in quartos. He fixed on an oriental subject, and the Messrs Longman agreed to purchase the poem for 3000 guineas. In 1817, the long-expected *Lalla Rookh* appeared—brilliant as a firefly, and the whole English world applauded. After the publication, he went to Paris, where he wrote *The Fudge Family*, which appeared in 1818. At this time, he learned that his deputy in Bermuda had misconducted himself, and that he had become liable for a large sum, which was afterwards, however, considerably reduced. Lord Lansdowne paid the claim, and M. repaid his lordship afterwards.

In 1819, M. went to Paris with Lord John Russell, and extended his tour to Italy, and saw Lord Byron at Venice. He returned to Paris, where he brought his family, and fixed his residence till 1822. Here he wrote *The Loves of the Angels*, which appeared in 1823, and *The Epicurean*, a prose romance, which was not published till 1827. On his return to England, he fixed his abode at Sloperston Cottage, near Bowood, and issued the *Memoirs of Captain Rock* in 1824, and the *Life of Sheridan* in 1825.

Byron had handed over to M., for his own especial benefit, a manuscript autobiography, on the condition that it should not see the light till after its author's death. Byron died in 1824, and as, at the request of his lordship's relatives, the manuscript was destroyed, M. then entered into arrangements with Murray to produce a life of the deceased poet. The *Life of Lord Byron* was published in 1830 in two volumes. Next year, he published the *Life of Lord Edward Fitzgerald*. His last important work was a *History of Ireland*, published in *Lardner's Cyclopædia*. A pension of £300 per annum was conferred on him in 1835. In 1841, he brought out an edition of his entire poetical works. For the three years preceding his death, he was afflicted with softening of the brain. He died on the 25th February 1852. His friend, Lord John Russell, has since published his *Memoirs, Journal, and Correspondence*, in eight volumes.

Despite his popularity during his lifetime, M. can hardly be placed in the rank of great poets. His muse is a spangled dancing-girl—light, airy, graceful, but nothing more. His most ambitious work, *The Loves of the Angels*, is far beneath the Miltonic, or even the Byronic standard. *Lalla Rookh* is brilliant, but fatiguing. He is most successful in polished satire and the lighter sentiments; and his reputation will ultimately rest on *The Twopenny Post-bag* and the *Irish Melodies*.

MOORFOWL, RED GROUSE, or, in books of natural history, RED PTARMIGAN or BROWN PTARMIGAN (*Lagopus Scoticus*), a bird peculiar to the British Islands, and affording more amusement to sportsmen than any other kind of feathered game in Britain. It is the bird generally known in Britain by the name *Grouse*, although not a true species of Grouse, but rather of Ptarmigan (q. v.). The toes are completely feathered, as well as the legs; the bill is very short, and its base much concealed by feathers. The length of the M. is about sixteen inches, of which about four inches belong to the tail. The tail is nearly square. The wings are short. The plumage is of a deep chestnut-brown colour, marked on the back and wing-coverts with black spots, and on the under-parts with undulating black lines; the four middle tail-feathers are also marked with transverse black lines. Above the eyes is a naked

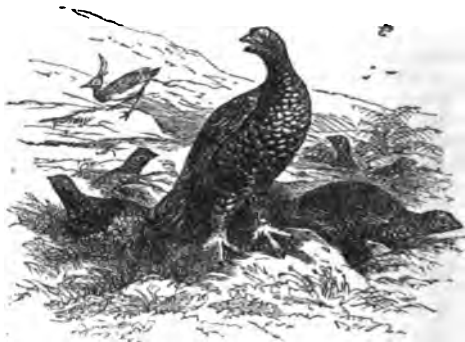

Moorfowl, or Red Grouse (*Lagopus Scoticus*).

space (the cere), of a bright scarlet colour. The M. is plentiful in the moors of Scotland and the Hebrides, Wales, the north of England, and Ireland. It feeds on the tender tops of heath, crowberries, bilberries, &c.; and not unfrequently visits the fields of oats and other grain in the vicinity of the moors, particularly when the *stooks* remain long in the field in late and rainy harvests. The M. is not polygamous, and pairs in spring, when the plumage—particularly of the male—assumes a lighter and redder tint. The female lays from eight to fifteen eggs. The nest is on the ground, often under shelter of a tuft of heath. The young run about very soon after they are hatched. 'Grouse' remain in *coveys* (broods) from the time they are hatched till late in the autumn, after which they 'pack' or assemble in large bodies.—A cream-coloured variety of M. is sometimes found in the north of England.—The M. is easily domesticated, and breeds readily in an aviary, if supplied with heath for food.

MOORHEN. See GALLINULE.

MOORING (allied probably to Dutch *marren*, to delay, fasten; Eng. *marline*, for fastening the sail to the bolt-rope; Lat. *mora*, delay), a fastening to retain a ship in a given position. This may be either by her own anchors, or (which is the more

common meaning of the term) by fixed and permanent buoy, which, on its part, is anchored to the bottom. A chain-mooring is where a strong chain is stretched for some distance on the bottom, being securely anchored or otherwise made fast at each end, and perhaps in intermediate places. Numerous buoys are then floated from it, and it becomes the mooring-ground for many vessels. Chain-moorings are frequent in all large harbours where comparatively small vessels require to ride.

MOORISH ARCHITECTURE. See **ARABIAN ARCHITECTURE.**

MOORS (Lat. *Mauri*, meaning dark; Spanish, *Moros*) are a people who form the great majority of the population of Barbary. Their appearance indicates their origin, which is a mixture of the Mauri (from whom they derive their name), Numidians, Phœnicians, Romans, and Arabs, who have successively held possession of the country. In consequence, they are found to vary considerably in appearance and character in different parts of Barbary, but all show more or less strongly the symptoms of a considerable infusion of Arabian blood. They are a well-formed race, with fine oriental features, and a mild and melancholy expression of countenance. They are more friendly and sociable than the Bedouins and Berbers, who inhabit the deserts and mountains; but are inferior to them in mental ability, besides being voluptuous and cruel. They constitute, generally speaking, the tradesmen, artisans, merchants, and agriculturists of Barbary; but a considerable number lead a pastoral life. The dress of the M. consists of a piece of woollen cloth, five ells in length by one and a half in breadth, called a 'haïque,' which is thrown over the shoulders, and fastened round the body; it also serves as a covering by night. This, when supplemented by a pair of slippers, a red cap, and a hood, constitutes the sole habiliment of the people generally. In the towns, the 'caftan' is generally worn over the haïque. The M. employ the Arabic language, but with many corruptions and deviations from the original, and these appear to increase towards the west.

As the Arab conquerors of Spain invaded that country from Africa, where they had largely recruited their forces, they were naturally enough called Moors, and in Spanish history the terms Moors, Saracens, and Arabs are synonymous. From this mixed Moorish-Arab race sprung the *Moriscaes*, who were permitted by Ferdinand the Catholic to remain in Spain after the expulsion of their countrymen, on condition of their embracing Christianity. A cruel persecution, which was originated by Philip II., drove them to rebellion (1567—70), and in 1571, many emigrated to Africa; those who remained being, to the number of 500,000, expelled in 1610 by Philip III.

The M. first appear in modern history as the allies of the Vandals in their invasion of Africa, and were continually rebelling against the Byzantine emperor. They were next, after a severe struggle, conquered and converted by the Arabs in 707. In 1091, they were summoned by the latter into Spain, to aid in stemming the tide of Christian conquest; and after faithfully supporting the Arab calif of Cordova, &c., till his dominions fell into the hands of the king of Leon and Castile, they retired, in 1238, to Granada, where they founded their kingdom. The kings of Granada carried on a vigorous, and, at the same time, chivalrous warfare with the kings of Castile; but at length, weakened by internal discord, were compelled to succumb to Ferdinand the Catholic in 1492. The M., or at least that portion of them who refused to adopt

Christianity, were then expelled from Spain, and, in revenge, founded in 1518 the piratical states of Algiers and Tunis. Their subsequent history cannot be separated from that of Algiers, Tunis, and Morocco.

MOORUK (*Casuarus Bennetti*), a recently discovered bird of the same genus with the Cassowary (q. v.), of which it was at first regarded as a mere variety, a native of the island of New Britain. It is about five feet in full height, three feet to the top of the back, is of a reddish colour, mixed with



Mooruk (*Casuarus Bennetti*).

black, and has a horny plate instead of a helmet-like protuberance on the top of the head. The claw of the inner toe of each foot is very long. It becomes extremely tame and familiar in captivity; may be fed on potatoes, maize, or any similar food; and is apt to prove troublesome by swallowing anything, however indigestible, that may come in its way.

MOOSE. See **ELK.**

MORA (Lat.) is a word often used in Scotch law to denote delay caused by negligence. In England and Ireland, the corresponding word is *Laches* (q. v.).

MORA, a genus of trees of the natural order *Leguminosæ*, sub-order *Cæsalpinieæ*, containing only one known species, *M. excelsa*, discovered by Sir R. Schomburgk, and described by him as the most majestic tree of Guiana. The timber is said to be equal to oak of the finest quality. It is already a considerable article of commerce, under the name of *Mora wood*. It is darker than mahogany. It is valued for ship-building.

MORA'CEÆ, a natural order of exogenous plants, or, according to many botanists, a sub-order of *Urticæ* (q. v.). The M. are trees or shrubs with rough leaves and sometimes with climbing stems; they have a milky juice; the flowers are very small; the fruits of many flowers are often enclosed in a succulent receptacle, or the calyx becoming fleshy, all the fruits of a head or spike become combined into one. There are about 200 known species, natives of temperate and tropical climates. Some are valuable for their fruit, some for the caoutchouc obtained from their milky juice, and different parts of others are applied to various uses. Among the species are figs, mulberries, Osage orange, fustic, and contrayerva.

MORAINE. The masses of rock which, by atmospheric action, are separated from the mountains bounding the valleys along which glaciers flow, find a temporary resting-place on the surface of the ice,

MORALITIES—MORAVIA.

at the margin of the glacier, and are carried along with it, but so slowly, that they form a continuous line along each margin. These lines of débris are called *lateral moraines*. When two glaciers unite, the two inner moraines unite also, and form one large trail in the middle of the trunk glacier, and this is called a *medial moraine*. A large portion of these rocky fragments at length reaches the end of the glacier, and here the melting ice leaves it as a huge mound, which is known as a *terminal moraine*. See GLACIER.

MORALITIES. See MYSTERIES.

MORALS. See ETHICS.

MORANO, a city of Naples, province of Calabria Citeriore, built on a hill in a wild and rugged neighbourhood, 35 miles north-north-west of Corenza. Pop. 8350. It has good manufactures of silk, cotton, and woollen fabrics.

MORAT (Lat. *Moratum*, Ger. *Marten*), a town of about 1800 inhabitants, in the canton of Freiburg, Switzerland, on the Lake of Morat, about twelve miles from Bern, famous for the victory of the Swiss and their allies over Charles the Bold, Duke of Burgundy, June 22, 1476. The duke, exasperated by his defeat at Grandson, in March, appeared before the gates of M. with 40,000 men. The Swiss were aided by Strasburg, Basel, Colmar, and other Rhenish cities, and by Duke René of Lorraine, whom the Duke of Burgundy had driven from his possessions; but the superiority of numbers was greatly on the side of the Duke of Burgundy. The assault of the Swiss, however, was very impetuous, and their victory complete; the duke's camp fell into their hands, and he himself only escaped by the swiftness of his horse.

MORATIN, LEANDRO FERNANDEZ DE, the most eminent comic poet that Spain has produced in recent times, was born at Madrid, March 10, 1760. His father, Nicolas Fernandez de Moratin, was also a poet of some eminence, but having found that literary labours afforded a precarious support, he wished his son to learn the trade of a jeweller, by which, after his father's death, he, in fact, for some time supported himself and his mother. In 1790, appeared his first and best comedy, *El Viejo y la Niña*; it was followed by *La Comedia nueva El Baron*, *La Mogigata*, and *El si de las Niñas*. He found a powerful patron in Prince Godoy, who conferred several ecclesiastical benefices upon him, so that he was placed in circumstances of comparative affluence; but the Inquisition set its evil eye upon the poet, and M. had to 'walk softly.' Joseph Bonaparte made him chief royal librarian; but after the return of Ferdinand, in 1814, he was deprived of all his offices, and found it expedient to take refuge at Paris. The latter years of his life were devoted to a work of great learning, entitled *Origenes del Teatro Español* (History of the Rise of the Spanish Drama). He died in Paris, June 21, 1828. His works were published in a collective edition (6 vols., Madr. 1830—1831).

MORAVA, or, more properly, **MARCH** (called by the ancients *Marius*), a river of Austria, has its origin on the southern slope of the Schneeberg, on the borders of Prussian Silesia, 3682 feet above sea-level. It is the chief river of Moravia, to which it gives its name, and flows south through that crown-land, receiving on the right the Thaya, and falling into the Danube, eight miles above Presburg. In its lower course, it forms the boundary between Lower Austria and Hungary. Its course is 184 miles in length, and it is navigable from Göding, upwards of 60 miles from its mouth.

MORAVIA (Ger. *Mähren*), a crown-land of the Austrian empire, situated in 48° 40'—50° N. lat., and 15° 5'—18° 45' E. long. It is bounded N. by Prussian and Austrian Silesia, E. by Hungary and Galicia, S. by the duchy of Austria, and W. by Bohemia. Superficial area, about 8480 square miles. Pop. (according to the last census of 1857) 1,867,094.

M. is enclosed and traversed on all sides by mountains, being separated from Silesia by the range of the Sudetes; from Bohemia, by the Moravian chain; and from Hungary, by the Carpathian Mountains; while branches of these various chains intersect the whole country except in the south, where the land consists of extensive plains, lying about 800 feet above the level of the sea. The numerous small rivers of the interior follow a south-east direction, and fall into the March or Morava, from which the country derives its name, and then flow together with the latter into the Danube. The Oder, and its affluents the Elbe and Oppa, rise among the mountains on the north-east, from whence their course is soon turned directly away from the Moravian territory. There are few extensive lakes, but numerous ponds and small streams, which abound in fish. The more elevated parts of the country are not fertile, and the climate is severe; but in the mountain valleys and on the southern plains, the soil is remarkably rich, and the temperature more genial than in other European countries lying in the same parallel. M., which ranks as one of the richest of the Austrian dominions, has half of its area in arable land. It yields fine crops of grain, and among the other natural products grown for exportation, we may instance hops, mustard, potatoes, clover-seed, beet-root; and in the south, maize, grapes, chestnuts, and many other of the less hardy fruits and vegetables. The breeding of cattle and sheep, and the making of cheese from sheep's milk, constitute an important branch of industry; in the southern districts of the Hanna (a plain famous for its fertility), horses are bred for exportation. Geese and fowls are reared in large numbers for the sake of their feathers, and the keeping of bees is conducted with great success. The mineral products include iron, alum, saltpetre, coal, graphite, whetstones, sulphur, vitriol, pipe-clay, marble, and topazes, garnets, and other precious stones.

Industry, &c.—The principal branches of industry are the manufacture of linen and thread, which now enjoy a European reputation, and those for cotton goods at Sternberg. M. has long been noted for the excellence of its cloths, flannels, and other woollen fabrics, and for its leather goods. Brünn (q. v.), the capital, is the chief emporium for the manufacturing trade, and Olmütz (q. v.) the principal cattle-mart. M. is divided into the two circles of Brünn and Olmütz, the former of which consists of 12, and the latter of 13 governmental districts.

The educational wants of the provinces are well provided for by a university at Olmütz, 1 Protestant, and 12 Catholic gymnasias, besides numerous parish and other schools in the rural districts. The majority of the people belong to the Church of Rome. There are about 60,000 Protestants, and 40,000 Jews.

In regard to nationality, the population may be divided as follows: About 500,000 Germans, upwards of a million and a quarter of Slavonians, and 50,000 belonging to other nations. The Slavonians of M. are composed of Czechs and Poles, the former of whom are inferior to their brethren in Bohemia, being an incorrigibly lazy, dirty people. The Moravian Poles, although inferior to the Germans in industry and cultivation, are

a physically well developed, courageous, and enterprising people.

History.—M. was anciently occupied by the Quadi, who, on their migration in the 6th c. to Gaul and Hispania, were replaced first by the Rugii, next by the Heruli and Longobardi, and finally by a colony of Slavonians, who, on their settlement in the country, took the name of Moravians, from the river Morava. Charlemagne, who brought the people under nominal subjection after they had spread themselves over a territory greater than the present M., constrained their king, Samoslav, to receive baptism; but Christianity was first formally established in the middle of the 9th c. by Cyril, who must be regarded as the true apostle of the land. M. was made tributary to the German empire before the close of the century; but in 1029, it was incorporated with Bohemia, after having for a time been a prey to the incursive attacks of its Slavonic and Teutonic neighbours. At the close of the 12th c., M. was erected into a margraviate, and declared a fief of Bohemia, to be held from the crown by the younger branches of the royal House. On the death of Lewis II. at the battle of Mohacz in 1526, M., with all the other Bohemian lands, fell to Austria, in accordance with a pre-existing compact of succession between the royal Houses. Since then, it has shared the fortunes of the empire, and in 1849 it was formally separated from Bohemia, and declared a distinct province and crownland.

MORAVIANS (called also *United Brethren*, *Moravian Brethren*, or *Bohemian Brethren*), a religious community, tracing its origin to the followers of John Huss, who were expelled by persecution from Bohemia and Moravia in the beginning of the 18th c., and of whom a small company, consisting at first of only ten persons, received permission from Count Zinzendorf (q. v.), in 1722, to settle on his estate of Berthelsdorf, in Saxony. To this settlement they gave the name of Herrnhut, whence they are commonly known in Germany as Herrnhuters. It rapidly increased, not only by the accession of additional Bohemian and Moravian refugees, but also of other Christians, who were attracted by the faith and piety which remarkably prevailed in it. Zinzendorf joined the little brotherhood, devoted his whole estate to the propagation of Christianity, and undertook the work of the ministry. The doctrines which they received being those of the Augsburg Confession, it was proposed that they should unite themselves with the Lutheran Church; but a difference of opinion existing on this point, it was decided, as difficult questions still sometimes are among the M., by an appeal to the lot; and the result was, that the *United Brethren*, or *Unitas Fratrum*, as they termed themselves, remained a distinct community, and adopted an organisation of their own. Till Zinzendorf's death in 1760, he was really their leader, and was recognised by them as *Ordinariua*. After his death, their organisation was completed by synods held in 1764 and 1769.

The M. are recognised by the state in Germany, as Protestants attached to the Augsburg Confession. They have no symbolical books of their own, although they drew up a simple and brief confession of their faith in 1727, and a brief statement of principles was emitted by a synod held in 1775.

The M. profess to be connected with the Bohemian or Moravian Brethren of former times by a regular succession of bishops. The bishops, however, exercise no episcopal authority, and their chief peculiar function is that of ordination, of which they alone have the power. Every congregation

is governed by a *Conference of Elders*. The elders are bound to visit each family once in three months, and to report concerning the maintenance of family worship, and the conduct of the brethren. It is also their duty to visit the sick, and to aid the poor with money contributed by the other brethren. The whole church is governed by synods, which meet—always in Germany—at intervals of ten or twelve years, and are composed not only of bishops, but also of other members of the brotherhood. Between one synod and another, all affairs are managed by a *Conference of Elders* appointed by the synod.

M. are to some extent scattered amongst the general population of the countries in which they dwell, as Britain and America; but they prefer, where it is possible, to live in colonies, or separate societies, and in these they carry out some very peculiar parts of their organisation, particularly a division into *choirs* of children, youths, maidens, unmarried brethren, unmarried sisters, widowers, and widows, each having a separate leader or pastor. Unmarried brethren, unmarried sisters, widowers, and widows, reside in separate houses; married couples in houses of their own. Colonies of M. exist in England, America, Holland, and other countries, but are most numerous in Germany. The most important colonies, however, are perhaps those in the mission-fields. The Brethren early entered on missionary work, and all the prosperity of their church has been evidently connected with their earnest prosecution of it. Their first mission was planted, in 1732, in the island of St Thomas, in the West Indies; the missionaries who went thither expressing their resolution to become slaves, if necessary, in order to carry out their purpose. A mission to Greenland, which has been eminently successful, and may be said to have made Greenland a Christian country, was commenced in 1733. They have also interesting missions in Labrador and at the Cape of Good Hope, and in other heathen countries. The M. have at their mission-stations about 70,000 converts from heathenism. One of the most interesting of their stations is at Sarepta, in the government of Saratov, in Russia, by which they are connected with the Tartars and Kalmucks. In all their settlements, the education of the young receives the utmost attention.

The religious services of the M. are conducted with great simplicity. They meet for worship daily, in the evening, the service being much like that of a *prayer-meeting* amongst other Christians. They use a litany on the Lord's Day, but extemporary prayer is frequent. They admit the use of instrumental music. They maintain the practice of washing the feet, both in choirs and in congregations, before the communion. They meet on the last day of the year, to bring in the New Year with prayer and other exercises of religion. On Easter morning, they assemble in the burying-ground to celebrate the resurrection of Christ, and to express their confidence concerning the brethren who have died during the preceding year. The death of a member of the brotherhood is made known in the chief settlements by sound of trumpets, as if for victory; the melody indicating the particular choir to which the deceased belonged. In some of the settlements, peculiar dresses are worn by the members of particular choirs.

The importance of the M. is not to be estimated by their numbers. The impulse which they gave to the cause of religion was felt in the origination and growth of *Methodism* in England; and their influence has been felt throughout all the Protestant churches, and particularly in what relates to missionary enterprise.

MORAY FIRTH, an indentation of the German Ocean, on the north-east coast of Scotland. Its north-west shore is formed by the counties of Ross and Cromarty, and extends from Keasock Ferry, opposite Inverness, to Tarbet Ness. Its south-east shore extends from Inverness to Burghhead, in Elginshire. The entrance of the firth between Burghhead and Tarbet Ness is 16 miles in width; and from its entrance to Inverness it is 31 miles in extent. The firth is continued westward from Inverness by a branch called Beaulieu Basin.

MORAYSHIRE. See **ELGINSHIRE**.

MORBID APPETITES may consist of a desire which is, in character, natural and necessary to the animal economy, but becomes unhealthy when excessive and irresistible. Of this, the hunger which attends marasmus, and the thirst which attends diabetes, may be cited as illustrations. They may consist further, in a craving for articles or objects not in reality deleterious or detrimental, but which do not constitute the ordinary gratification of the appetite, such as the desire for chalk and lime experienced by chlorotic and hysterical women. They may, thirdly, consist in the longings, often complicated with delusions, felt by pregnant women and others, which are injurious, repugnant to nature, and revolting. Georget gives an instance where a wife coveted the shoulder of her husband, killed him in order to obtain the morsel, and salted the body in order to prolong the hideous cannibalism. In such a case, the gross longing may be said to constitute the disease; but there are others in which it is one of many symptoms demonstrating the degradation of the mind under general disease, as when the insane devour garbage, excrement, or swallow grass, hair, stones.—Georget, *Dict. de Médecine*; Feuchtersleben, p. 276.

MORBIHAN, a maritime department in the north-west of France, formed out of ancient Bretagne. Area, 1,689,836 acres; pop. 486,504. The coast is much indented, and has a multitude of bays, roadsteads, harbours, and islands. The largest island is Belle Isle (q. v.). The department has a somewhat hilly appearance, but towards the sea, the land stretches out in rich plains, interrupted, however, by great tracts of heath and marsh. The climate is mild, but moist. The soil is not well cultivated, but yields sufficient grain for home consumption. The heaths afford fine pasturage, and support great herds of horned cattle, sheep, and horses. The rearing of bees is a source of very considerable revenue; as also are the river and coast fisheries. The trade in sardines is particularly extensive. The want of wood is so great, that the peasants are obliged to burn dung extensively. The chief mineral is iron, but there are almost no manufactures. M. is divided into the four arrondissements of Vannes, L'Orient, Ploermel, and Pontivy. The chief town is Vannes (q. v.), but the most populous is L'Orient (q. v.).

MOR'DANTS. See **DYING**.

MORDAUNT, CHARLES, Earl of Peterborough, military and naval commander, and one of the most brilliant Englishmen of his time, was the son of John Lord Mordaunt, and was born in 1658, some say 1662. He served as a boy in the navy, and then entered the army. He took part against James II., and was made Earl of Monmouth by William III., succeeding afterwards to the earldom of Peterborough, as heir to his uncle. During the war of the Spanish Succession, the English government determined to send an expedition to Spain. It was placed under the command of M.; and in June 1706, he arrived in Lisbon with 5000 Dutch and English soldiers.

After taking on board the Archduke Charles of Austria, who claimed the Spanish crown, the armament proceeded to Valencia. Here M., with characteristic daring, conceived the idea of making a dash at Madrid, and finishing the war at one blow. He was overruled by the archduke and the Prince of Hesse, and compelled to besiege Barcelona, which was defended on one side by the sea, and on the other by the strong fortifications of Monjuich. By a *coup de main*, he made himself master of Monjuich. Barcelona fell, and M., with a handful of men, entered one of the strongest cities of Europe. He pushed his successes into the interior. Several towns submitted. He marched to Valencia in the depth of winter, and at the head of 1200 men defeated a Spanish force of 4000. The Spaniards sent a large army into Catalonia, and a French fleet appeared off Barcelona. M. harassed the enemy's army, and putting himself on board the English squadron, directed a movement which, had it been executed a few hours earlier, would have resulted in the capture of the whole French fleet. The Frenchmen put to sea, and Barcelona was saved. M. again wished to march towards Madrid, but his plan for gaining possession of the capital was once more rejected by Charles. He accordingly left the army in a fit of pique, and went to Italy. In 1707, he returned to Valencia as a volunteer, and gave excellent advice, which was not followed. He was recalled to England, and from that moment the tide of fortune ran strong against the Austrian cause. Few generals have done so much with means so small, or displayed equal originality or boldness. His fertility and activity of mind were admirably seconded by a most intrepid spirit. His splendid talents, on the other hand, were disfigured by vainglory, and a morbid craving for novelty and excitement. He loved to fly round Europe, and was said to have seen more kings and postillions than any other man of his day. On his return, he made common cause with the Tories, to spite the Duke of Marlborough, and received the Garter and other dignities for his services. On the accession of George I., he was appointed commander-in-chief of the naval forces of Great Britain; but was never again employed in active service. He died at Lisbon 25th October 1735. His witty, yet affectionate letters to Pope, Swift, Prior, &c., give a fine insight into his private character. See Elliot Warburton's *Memoir of Charles Mordaunt, Earl of Peterborough and Monmouth, with Selections from his Correspondence*, 2 vols. (1853). His character has been sketched by Horace Walpole, in his *Catalogue of Royal and Noble Authors*; and with still greater force and picturesqueness by Macaulay.

MORE, SIR THOMAS, Lord Chancellor, and one of England's worthiest sons, was born in Milk Street, London, in 1480, son of Sir John More, Justice of the Queen's Bench. He was educated at St Anthony's School, Threadneedle Street; and in his fifteenth year was placed in the house of Cardinal Morton, Archbishop of Canterbury, who used to say of him: 'This child here waiting at the table, whosoever shall live to see it, will prove a marvellous man.' Dean Colet, too, was wont to say: 'There was but one wit in England, and that was young Thomas More.' In 1497, M. went to Oxford, where he made the friendship of Erasmus. He then applied himself to the law, and studied first at New Inn, and afterwards at Lincoln's Inn. He was appointed reader at Furnival's Inn, where he lectured for three years. At the accession of Henry VIII., his professional practice was considerable, and he also held the office of judge of the Sheriff's Court in the city—his income from these sources being equivalent to £4000 or £5000 of our present money.

He went on several missions abroad for the king, and in 1516 was made a privy-councillor. His public life now began. He became so great a favourite with Henry VIII., that, in the words of Erasmus, 'the king would scarcely ever suffer the philosopher to quit him.' Henry visited him uninvited at Chelsea, and walked with him by the hour in his garden, 'holding his arm about his neck.' Yet M. had a true insight into Henry's character, for being congratulated on the king's favour by his son-in-law, Roper, he replied: 'If my head would win him a castle in France, when there was war between us, it should not fail to go.' M. is the first person in British history distinguished by the faculty of public speaking, and remarkable for the successful employment of it in parliament against a lavish grant of money to the crown. Being elected Speaker of the House of Commons in 1523, he vindicated the ancient liberties and privileges of the house against Cardinal Wolsey, who rather feared than liked him. In 1529, when the prosecution was opened against Wolsey, the king delivered the Great Seal to M. at Greenwich, constituting him Lord Chancellor, a dignity that had generally been held by ecclesiastics, and had never yet been filled by a common lawyer. When he was seated in his Court of Chancery, his father, Sir John More, who was nearly ninety, was the oldest judge of the King's Bench. It was a beautiful spectacle to 'see the son ask the blessing of the father every day upon his knees, before he sat upon his own seat.' Unlike the haughty Wolsey, whom no suitor could approach without offerings, M. sat daily in an open hall, that he might receive in person the petitions of the poor. He despatched the causes so speedily and diligently, that on asking for the next, he was told that none remained. Henry in vain endeavoured to obtain M.'s authority for his divorce with Catharine of Aragon, and his marriage with Anne Boleyn, upon which he had set his heart. As soon as the progress of the marriage was so far advanced that the active co-operation of a chancellor was required, M. obtained leave to resign the great seal. When the king 'by no gentleness could win him,' his favour turned to fury. M. refused to take an oath which pledged him to the lawfulness of the king's marriage with Anne Boleyn. He was committed to the Tower, where he remained thirteen months. On the 6th of May 1535, he was brought to trial at Westminster. It has been truly said that 'no such culprit had stood at any European bar for a thousand years.' He was convicted by the most flagrant perjury and injustice, and sentenced to the savage punishment for high treason. He suffered death in the Tower, July 6, 1535. In the words of Addison: 'The innocent mirth which had been so conspicuous in his life did not forsake him to the last. When he laid his head on the block, he desired the executioner to wait until he had removed his beard, "for that had never offended his Highness."' His head was placed on London Bridge, but was taken down and preserved by his favourite daughter, the admirable Margaret Roper, the story of whose tenderness and devotion will live as long as the English language endures. His *Utopia* is the conception of an imaginary commonwealth, in which opinions are expressed of great boldness and originality, and especially favourable to freedom of inquiry, even in religion. He, however, wrote against the Lutherans, and corrected the MS. of Henry's answer to Luther. The terseness and liveliness of his sayings, his sweet temper and affectionate disposition, his blameless life, his learning and probity, combine to make a union of perfect simplicity with moral and intellectual greatness, which will for ever endear his memory to his countrymen of every sect and party.

MORE, HANNAH, the daughter of a village schoolmaster, near Bristol, was born in 1745. She wrote verse at an early age; and in 1773, she published a pastoral drama entitled *The Search after Happiness*; and the year after, her tragedy of *Regulus*. Under the idea that she was possessed of dramatic talent, she was introduced to Garrick, and through him became acquainted with Dr Johnson, Burke, and Sir Joshua Reynolds. Deeply impressed with the importance of religion, she gradually resigned her ambition to shine as a writer for the stage, and after the publication of her *Sacred Dramas*, she retired to the country, and busied herself with the composition of works of a more serious and practical cast, the best remembered of which are, *Caleb in Search of a Wife*, and *The Shepherd of Salisbury Plain*. She died at Clifton, on September 7, 1833. Her *Memoirs and Correspondence* were published in the following year, in four volumes.

MOREA, the name borne by the ancient Peloponnesus (q. v.) since the middle ages, if not from as early a period as the 4th century. It is usually said to be derived from *morus*, a mulberry—the outline of the peninsula bearing a resemblance to the leaf of that tree; others, however, such as Fallmerayer, trace it back to the Slavic word *more*, the sea, which nearly encircles the Morea. The M. forms the most southern part of the kingdom of Greece, and is divided into the nomarchies of Argolis, Corinth, Laconia, Messenia, Arcadia, Achaia, and Elis.

Overrun by the Goths and Vandals, it became a prey, in the second half of the 6th c., to bands of Slavic invaders, who found it wasted by war and pestilence. Gradually, however, these barbarians were subdued and Grecianised by the Byzantine emperors. Nevertheless, the numerous names of places, rivers, &c., in the M. of Slavic origin, prove how firmly they had rooted themselves, and that the Moreotes are anything but pure Greeks. In 1207, the peninsula was conquered by French knights, and Achaia was formed into a principality with all the feudal institutions of the west. After 1261, the Byzantine emperor, Michael VIII. Paleologus, reconquered part of the country; but the principality of Achaia remained in the family of Villehardouin till 1346, when the male line became extinct. Various claimants now arose, and much strife and confusion ensued. At length, in 1460, the greater portion of the M. fell into the hands of the Turks, who retained possession of it down to the period of the Greek revolution, except from 1687 to 1715, when it was held by the Venetians. The long struggle between the Turks and Venetians diminished the population so much that in 1719 it had only 200,000 inhabitants, and the plagues of 1756 and 1762 even reduced it to half this number. After the French Revolution, however, it began to increase; at the outbreak of the War of Independence, in 1827, it had reached 300,000, of whom only one-sixth were Turks; and in 1856, it was 562,341.

MOREAU, JEAN VICTOR, the greatest general of the French Republic, except Bonaparte, was born, 11th August 1763, at Morlaix, in Bretagne; was the son of an advocate, and was sent to study law at Rennes. He took the side of the Revolution, was chosen to command the battalion of volunteers from Rennes, served under Dumouriez in 1793, and displayed such military talent, that in 1794 he was made a general of division. His father was put to death by the guillotine under the Reign of Terror, and M. hesitated for a moment, but resolved that he could not withdraw from the service of his country. When Pichegru fell under suspicion, the Directory appointed M., in the spring of 1796, to

the chief command on the Rhine and Moselle. He crossed the Rhine at Kehl, defeated Latour at Rastadt, and the Archduke Charles at Ettlingen, and drove the Austrians back to the Danube. But, owing to errors in the plan of the campaign, against which he had in vain remonstrated with the Directory, M. found himself in danger of being cut off from the Rhine, and was obliged to make a desperate effort to regain that river, which he accomplished, notwithstanding great difficulties, by a march of forty days. This retreat established his reputation for generalship more than all his previous victories.

A suspicion of participation in the plots of Pichegru led to his being deprived of his command, after the *coup d'état* of 18th Fructidor. In the following year, he succeeded Schérer in the command of the army in Italy, when it was hard pressed by the Russians and Austrians, 25,000 men being opposed to 80,000. By a retreat conducted with consummate skill, and in course of which he even gained victories, he saved the French army from destruction. The Directory, nevertheless, deprived him of the chief command, and gave it to Joubert. But M. remained with the army, and aided that young general to the utmost; and after his death at Novi, again assumed the command, and conducted the defeated troops to France. The noble disinterestedness of M.'s character, his military talent, and his political moderation, induced the party which overthrew the Directory, to offer him the dictatorship of France, which he declined, and lent his assistance to Bonaparte on 18th Brumaire. Receiving the command of the army of the Rhine, M. gained victory after victory over the Austrians in the campaign of 1800, and at last won the great and decisive battle of Hohenlinden (q. v.). A strong feeling of mutual distrust now arose between M. and Bonaparte, who sought in vain to win him to himself; and M.'s country-seat, to which he retired, became the gathering-place of the discontented. Bonaparte surrounded him with spies, and ere long he was accused of participation in the plot of Cadoudal (q. v.) and Pichegru against the life of the First Consul. He was arrested, brought to trial, and found guilty on 10th June 1804, although the evidence against him was utterly insufficient. But Bonaparte could not venture upon a sentence of death, and a sentence of two years' imprisonment was therefore pronounced, which was commuted into banishment, and M. went to America, where he settled in New Jersey. Regarding with great dissatisfaction the whole of Bonaparte's further career, he thought it his duty to France to give his aid to the allies in the campaign of 1813, and leaving the United States in the company of a Russian agent, he landed at Gothenburg, had an interview with the Crown Prince of Sweden, the former General Bernadotte, and accompanied the emperor of Russia and the king of Prussia in the march against Dresden, where, as he stood with the Emperor Alexander on a height at Raeknitz, on 27th August, a French cannon-ball broke both his legs. Amputation was performed, but he died at Laun in Bohemia, 2d September 1813.

MORECAMBE BAY, an inlet of the Irish Sea, on the north-west coast of England, separates the main portion of Lancashire from the detached portion of Furness. It is about 10 miles in average breadth, and is 16 miles in length. It receives the Kent, the Keer, and the Luna. The depth of water in the bay is never great except in the channels of the rivers; and when the tide is out, the water entirely withdraws for the time, and there is a road, although a dangerous one, across the sands from the vicinity of Lancaster into Furness.

MOREE'N. See MOIRE.

MORE'L (*Morchella*), a genus of fungi, of the division *Hymenomyces*, having a fistular stalk, and a roundish or conical pileus, the upper surface of which is divided into an irregular net-work of cells or pits, and bears the *hymenium*. They grow on the ground, and have a more or less agreeable smell and taste. Some of them are reckoned among esculent fungi, of which the best known is the COMMON M. (*M. esculenta*), a fungus rare in Britain, but common



Common Morel (*Morchella esculenta*).

in many parts of the middle and south of Europe. Its stalk is only about an inch high, and it has a roundish, oval, oblong, or conical, yellowish or brown pileus. It is nutritious, and not difficult of digestion; but is chiefly used in sauces and gravies, on account of its pleasant flavour. It is used either fresh or dried, and is often brought to market in a dried state. It grows in lawns, and among fallen leaves in the thinner parts of woods where the soil is light, and makes its appearance in spring. It makes excellent ketchup. In Germany, the M. is highly prized, and as it very often springs up when part of a forest has been burned, the forests of Germany were often destroyed for its sake, till this practice was restrained by severe penalties. Its cultivation has not been attempted, although probably it would not be difficult.—A very similar species is *M. patula*, which is used in the same way; as is also the BOHEMIAN M. (*M. Bohemica*), which has a stem 4—8 inches high, and a thimble-shaped, obtuse, white-margined pileus, with longish narrow pits of many various forms; abundant in Bohemia, and when dried in a baker's oven, a considerable article of export. The name M. (*Morchel*) is extended in Germany to some of the edible species of *Helvella* (q. v.).

MORE'SQUE. See ARABESQUE, GROTESQUE.

MORETON BAY, on the east coast of Queensland, Australia, is formed inside the islands of Moreton and Stradbroke, the former 23 miles, and the latter 35 miles in length, and both about 5 miles in greatest breadth. It is 65 miles in length (lat. 27°—27° 55' S.) by 23 miles in greatest breadth. Its shores are rich in soil, and admirably adapted for agriculture. Its appearance is rendered picturesque and beautiful by the numerous islets, some of them capable of profitable cultivation, with which it is dotted over. Into this bay five navigable rivers, the Arrowmith, Logan, Brisbane, Pine, and Caboolture pour their waters. The entrance at the north end is practicable at all times for vessels of the largest size; the entrance between Moreton and Stradbroke is narrow, and less safe.

MORETON-BAY CHESTNUT (*Castanospermum Australe*), a tree of the natural order *Leguminosæ*, sub-order *Papilionaceæ*, a native of Queensland,

Australia. It attains a height of 70—100 feet, has wide-spreading branches, pinnate leaves, and large racemes of beautiful red and yellow flowers. The pods are six or seven inches in length, and the seeds are in size and quality somewhat like chestnuts.

MORGAN, LADY (SYDNEY), was the daughter of a theatrical manager, named Owenson, who settled in Dublin. It is usually stated that she was born in 1786, but as she refuses to tell the date of her birth, 'because dates are so cold, false, and erroneous,' the reader of her autobiography will do well to add about ten years to her age. Her father fell into pecuniary difficulties, and the clever, bold, and lively young woman resolved to support the fortunes of the family, first as governess, and then as author. She wrote *The Wild Irish Girl* in 1806. A lady-novelist was then rare, and Irish subjects were less hackneyed than they have since become. Sydney Owenson obtained a footing in the household of the Marquis of Abercorn, in whose establishment her future husband, Dr Morgan, held the post of private physician. The Lord Lieutenant was persuaded to make a knight of Dr Morgan, and the newly wedded pair set up for themselves in Dublin. Here she wrote the *O'Donnel*. The opening of the continent in 1814 attracted the Morgans to Paris. Lady M. obtained admission into the highest society, corresponded with several celebrities, and wrote a work on *France*, which was eagerly received, and vehemently praised and censured by critics of different political opinions. In 1818, the Morgans went to Italy—the wife to sketch manners, scenery, and society, while Sir Charles was to contribute chapters on politics, science, and education. Lady M. was received with great hospitality by the Italian nobility, and the foreign visitors at Rome. Her *Italy* appeared in 1821, and proved one of the most successful and remunerative of her works. In 1824, the Morgans came to London, and in 1825, Lady M. began to keep a diary, which contains some amusing bits of literary, fashionable, and political gossip. Her reputation as an authoress became obscured, but she continued to the end of her career to assume the twofold character of the lady of fashion and the woman of genius. She succeeded in obtaining from the Whig government a pension of £300 a year, in acknowledgment of her literary merits, and partly, also, in recognition of the unjust and virulent attacks to which she had been subjected for having, in her earlier works, exposed the wrongs of her native country. She died in 1859, having continued busy with her pen and her tongue to the last; and leaving behind a great mass of correspondence of little intrinsic value and interest, which, with a memoir, her autobiography, and diary, was published in 1862, in 2 vols. Her descriptions of high life have much raciness and vigour, and her Irish sketches—the famous 'Jug-day,' in *The O'Briens and the O'Flahertys*, deserving special mention—are perhaps the best account of that racketsy, humorous, sentimental existence which was at once the charm and bane of Ireland, and which has but lately passed away.

MORGANATIC MARRIAGE (Goth. *morgjan*, to curtail, limit), sometimes called *Left-handed marriage*, a lower sort of matrimonial union, which, as a civil engagement, is completely binding, but fails to confer on the wife the title or fortune of her husband, and on the children the full status of legitimacy or right of succession. The members of the German princely houses have for centuries been in the practice of entering into marriages of this kind with their inferiors in rank. Out of this usage has gradually sprung a code of matrimonial law, by which the union of princes with persons of lower

rank, in other than morganatic form, involves serious consequences, especially towards the lady. The penalty of death was actually enforced in the case of the beautiful and unfortunate Agnes Bernauer (q. v.). In the 16th and 17th centuries, a fashion began among German princes of taking a morganatic wife in addition to one who enjoyed the complete matrimonial status—Landgrave Philip of Hesse setting the example, with a very qualified disapprobation on the part of the leading Reformers. An energetic attempt was made in the first half of the last century by Anton Ulrich, Duke of Saxe-Meiningen, to upset the established practice, and obtain for his morganatic wife the rank of duchess, and for her children the right of succession. In deference to the united opposition of the whole principedom of Germany, the emperor refused the duke's suit, declaring that there could be no marriage in princely families without 'Ebenbürtigkeit,' or equality of birth. In the present century, morganatic marriages are by no means on the decline among the German reigning houses—one of the best known and most remarkable instances being the union of the late Archduke John, the 'Reichsverweser' of 1848, with the daughter of the postmaster of Ansee, in Styria, afterwards created Countess of Meran. Morganatic marriages are recognised not only among the princely families, but among the higher aristocracy of the empire; and in Prussia, even the 'Niedere Adel,' or inferior gentry, may contract unions of this kind. A sort of left-handed or 'hand-fasted' marriage was recognised in early times in the Highlands of Scotland, and Ireland: the hand-fasted bride could be put away, and a fresh union formed, with the full status of matrimony. Unlike the case of German morganatic marriages, the issue were often accounted legitimate, even to the prejudice of the children of the more regular union that followed. The Royal Marriage Act, 12 Geo. III. c. 11, reduces to a position somewhat like that of morganatic unions every marriage in the royal family of Great Britain not previously approved by the sovereign under the Great Seal, provided the prince entering into it is under 25, and every such marriage of a prince above 25 which is disapproved by parliament.

MORGARTEN, a mountain slope on the east margin of Lake Egeri, in the canton of Zug, Switzerland, has acquired a world-wide celebrity as the scene of a great victory won by the Swiss Forest Cantons over the Austrians, 8th December 1315. The Swiss, who had command both of the narrow pass which wound between Morgarten Hill and the lake, and of the adjoining heights, numbered only 1400 men, while the Austrians amounted to 15,000, and were led by Duke Leopold, brother of the German Emperor. When the Austrian troops had fairly entered the pass, those of the Swiss posted on the rocks above hurled down great masses of stone, which threw the enemy's cavalry into confusion, besides killing immense numbers of them. Their comrades who held the pass, taking advantage of the disorder, now charged the Austrians repeatedly, and utterly routed them. Only a few escaped, among whom was Duke Leopold himself.

MORGHEN, RAPHAEL SANZIO CAVALIERE, a famous engraver, was born at Florence, June 19, 1768. His first instructor in the art of engraving was his father, who, according to some, was a German, or the son of a German. The indications of talent that he gave were such as to induce his father to place him under Volpato at Rome. His progress then became very marked. Raphael's celebrated figures in the Vatican of

'Poetry' and 'Theology,' were engraved by him in 1781; and he afterwards produced a succession of engravings of a very high class from many of the master-pieces of art: amongst these may be enumerated his prints from Raphael's 'Madonna della Seggiola;' the 'Madonna del Sacco,' by Andrea del Sarto; the 'Transfiguration,' by Raphael; the 'Duke of Moncade,' by Van Dyck; and by his burin, Da Vinci's 'Last Supper,' notwithstanding its decay, has been rendered with such consummate skill, as to lessen the regret felt for the evanescent condition of the original work. He accepted an invitation from the Grand Duke to reside at Florence, with a pension of 400 scudi, and a free residence, under condition of keeping a public school; and received marked attentions from the Emperor Napoleon, to whom he dedicated his engraving from the 'Transfiguration.' M. died at Florence on 8th April 1833. He had married a daughter of Volpato's in 1781. His Life, with a portrait, and a catalogue of his works, was published by his pupil, Niccolo Palmario. From this work, it appears that he has engraved 73 portraits, 47 religious, and 44 historical and mythological pieces, 24 views and landscapes, and 13 vignettes, crests, &c.—201 in all. The works of M. will always hold a very prominent place in the history of engraving. About the middle of last century, Strange had added a new feature to the art, by introducing, in a remarkable way, what is technically called by engravers 'colour,' or the art of producing by management and variety of line, a texture or quality that compensates to some extent for the want of the actual colours in a picture. This influenced the style of Volpato, Cunego, and other Italian engravers of the period, who imitated, though with no very great success, the brilliancy produced by Strange. M., however, went far beyond these Italian engravers, for in his works he united much that was good in the engravings of Strange with a more correct and a purer style of drawing, and thus brought out in a very high degree all the important qualities for which those master-pieces he so skillfully rendered, are distinguished.

MORGUE, a French word, denoting the inner wicket of a prison, at which persons accused or condemned are kept for some time, in order that the jailers and turnkeys may examine them at their leisure, so as to be able to recognise them when occasion requires. Hence the application of the word to a certain building (*La Morgue*) in the 'City' (*La Cité*) of Paris, situated on the *Quai du Marché neuf*, where the dead bodies of persons unknown, found either in the river (Seine) or in the streets, are exposed to public view for three days. The corpses are put under a glass case, on a sloping slab of black marble. They are wholly naked, except across the middle, which is covered with a piece of leather. The clothes are hung on the wall above. When a corpse is recognised, it is handed over to the relatives or friends of the deceased, on payment of costs and dues—otherwise, it is interred at the expense of the city. The number of bodies yearly exposed in the *Morgue* is about 300, of which five-sixths are those of males.

MORINGA. See BEN, OIL OF, and HORSE-RADISH TREE.



Morion.

MORION, an iron or steel head-piece worn by a man-at-arms in the days when armour was used. It was distinguished from the helmets of the knights and esquires in having neither visor nor beaver. Under the Norman laws, every yeoman between certain

ages was bound to keep his morion ready for service.

MORISON, ROBERT, M.D., one of the most eminent botanists of the 17th c., was a native of Aberdeen, and having borne arms as a royalist in the civil wars, retired to France about 1650, and became superintendent of the garden formed at Blois by Gaston, Duke of Orleans. After the Restoration, he was appointed by Charles II. one of his physicians, and 'botanist royal,' and became Professor of Botany at Oxford. He died in 1683. He did much for the advancement of the science of botany by his study of the natural affinities of plants, and the publication of a system which afterwards became the basis of that of Ray. His great work is *Plantarum Historia Universalis Ozoniensis* (2 vols., 1676—1699). He also wrote on umbelliferous plants.

MORISONIANISM, a term which has been much used in Scotland, since about the year 1841, and to some extent in the north of England, to designate a system of religious doctrine, strongly opposed to the Calvinism of the Scottish Presbyterian churches, and exhibiting in the highest degree the distinctive features both of Arminianism and Pelagianism. It derives its name from a minister named James Morison, suspended from his office by one of the Scottish Presbyterian churches in 1841, and now a Professor of Theology in the *Evangelical Union* (q. v.). The doctrinal views stated by him prior to 1841 were far from having that complete development which they soon after received from himself and his followers. The point to which prominence was first given was the universal extent of the atonement—that Christ died for the sins of all men equally; with which was naturally connected the opinion, that saving faith consists simply in a man's belief that Christ died for him, inasmuch as he died for the sins of the whole world; this further leading to the opinion, that a believer must know the reality of his own faith in Christ; and to the opinion, that every man possesses a sufficient ability to believe the gospel, without any aid of grace but what is vouchsafed to all who hear it, and in the very fact of its being preached or presented to them; and so to the tenets which have long received the designation *Pelagian*. The opposition to the standards of the Scottish Presbyterian churches is very complete regarding the fall of man, the work of the Holy Spirit, election, and kindred subjects; whilst on the subject of justification, the doctrine of imputation stated in these standards is repudiated, and the atonement is represented as a satisfaction of 'public justice,' not securing the salvation of any man, but rendering the salvation of all men possible.

MORLAIX, an old Breton town and seaport of France, in the department of Finistère, at the confluence of the Jarlean and the Kerlent, which below the town enter a creek of the English Channel, 45 miles north-north-east of Quimper. It is beautifully situated, and in spite of modern improvements, still contains many picturesque old houses, with projecting upper stories, carved corner-posts, and sculptured cornices. Vessels of 400 tons can reach the quays of the town. There is a considerable trade in grain, oil-seeds, hides, pigs, cattle, sheep, &c. Pop. 12,287.

MORMONS,* or, as they call themselves, THE CHURCH OF JESUS CHRIST OF LATTER-DAY SAINTS, are a religious sect founded by a native of the United States, named Joseph Smith. Smith was the son of a farmer, and was born in the town of

* The origin of this name will appear in the sequel.

Sharon, Windsor County, Vermont, 23d December 1805. When he had reached the age of ten, his parents removed to Palmyra, in the state of New York, and four years later, to the town of Manchester, about six miles off. The reputation of the family is said to have been of the worst kind; we are told that they avoided honest labour, were intemperate, untruthful, and suspected of sheep-stealing and other offences. These accusations are generally denied by M., but Smith himself partly admitted them, affirming that he 'had never done anything so bad as was reported of King David, the man according to God's own heart.' Nevertheless, a rude sensual religiosity appears to have been mixed up with his more carnal conduct. There is the most satisfactory evidence—that of his enemies—to shew that from an early period he was regarded as a visionary and a fanatic. This fact is of the utmost importance as affording a clue to his *real* character, and an explanation of that otherwise unaccountable tenacity of purpose and moral heroism displayed in the midst of fierce persecution. A mere impostor—i. e., a person who did not, in some sense or other, partly believe in his own mission, but who, on the contrary, felt that he was simply the liar and cheat that people called him—would have broken down under such a tempest of opposition and hate as Smith's preaching excited.

'When about fourteen years of age,' Smith says, 'I began to reflect upon the importance of being prepared for a future state.' He then describes how he went from one religious denomination to another, but could find nothing satisfactory—nothing but 'a great clash in religious sentiment.' Then he began to withdraw into secret places, to spend hours in prayer and meditation, and to receive angelic visits. The second of these happened on the evening of the 21st September 1823, when it seemed as though the house was filled with 'consuming fire.' In a moment, a 'personage' stood before him, 'with a countenance like lightning,' and 'visible to the extremities of the body,' who 'proclaimed himself to be an angel of God.' He informed Smith of various important particulars, as, 'that his sins were forgiven, and his prayers heard; that the covenant which God made with ancient Israel was at hand to be fulfilled; that the preparatory work for the Second Coming of the Messiah was speedily to commence; that the time was at hand for the Gospel to be preached in its power and fulness to all the nations; and that Smith was chosen to be an instrument in the hands of God, to bring about some of his purposes in this glorious dispensation.' Besides all this, the angel gave him, by way of appendix, 'a brief sketch of the origin, progress, civilisation, laws, and governments' of the aboriginal inhabitants of America—'of their righteousness and iniquity; and the blessings of God being finally withdrawn from them.' He was also informed where some plates were deposited, containing an abridgment of the records of the ancient prophets that had existed on the American continent. The angel appeared to Smith thrice that night, and afterwards paid him many visits. He told him where the records were deposited, 'on the west side of a hill, not far from the top, about four miles from Palmyra, in the county of Ontario, and near the mail-road, which leads thence to the little town of Manchester.' He advised him to go and view them, which Smith did; but the prophet was not yet holy enough to obtain possession of them.

At length, after due disciplinary probation, the angel of the Lord, on the 22d of September 1827, placed in Smith's hands the wonderful records. They were engraven on plates nearly eight inches long by seven wide, a little thinner than ordinary tin, and bound together by three rings running

through the whole. The volume was altogether about six inches in thickness, a part of which was sealed. The characters, letters, or hieroglyphics upon the unsealed part were small, and beautifully engraved. They represented an unknown language called the 'Reformed Egyptian.' Along with the records was found a curious instrument, called by Smith 'Urim and Thummin,' consisting of two transparent stones, set in the rim on a bow fastened to a breastplate. By means of these stone-spectacles, God enabled him to understand and translate the ancient records into such humble English as the 'prophet' (who had received almost no school-education, and could read with difficulty) was master of. The records contain the primitive history of America, from its first settlement by a colony that came from the Tower of Babel, at the confusion of languages, to the beginning of the 5th c. of the Christian era. These primitive colonists were called Jaredites; they were a wicked and bloody race, and finally, like the Kilkenny cats, mutually destroyed each other, millions being slaughtered in the final conflicts. Silence again settled down upon America. But a new race came directly from Jerusalem about 600 B. C. These consisted of Lehi and his wife; his four sons, Laman, Lemuel, Sam, and Nephi, together with their four wives; two 'sons of Ishmael,' and their two wives; Zoram, a servant, and his wife; in all, sixteen men and women. They are supposed to have landed on the coast of Chili. After the death of Lehi, quarrels broke out among the brothers. The Lord had appointed Nephi to be the ruler of the new race of colonists, but his elder brothers would not hear of it; as a punishment for which, they and all their posterity were condemned to have dark skins, and 'to become an idle people, full of mischief and subtlety, which did seek in the wilderness for beasts of prey.' They are the ancestors of the American Indians, who are thus, according to Smith's records, simply *bad* Hebrews. The descendants both of Nephi and of his rebellious brothers, increased and multiplied, but were almost continually at war with each other. In the time of Nephi the second, an awful earthquake announced the Crucifixion. Three days afterward, Christ himself appeared out of heaven; shewed the Nephites his wounded side and the print of the nails; instructed them for forty days in the truths of Christianity; healed the sick, blessed children, administered the sacrament, and planted churches, with apostles, prophets, pastors, teachers, and evangelists—the same order, the same priesthood, the same ordinances, gifts, powers, and blessing as was enjoyed on the eastern continent. Hostilities, however, between the Nephites and their dark-skinned brethren continued to rage as fiercely as ever; gradually the purity of their faith declined; and finally, in 384 A. D., a decisive conflict took place at the hill Cumorah, in Western New York, where the Christian Nephites were nearly annihilated; miracles now ceased, and unbelief gradually became supreme. Shortly before this, however, a prophet called MORMON had been commissioned by God to write an abridgment of all their prophecies, histories, &c., and to hide it in the earth, till God should see fit to bring it forth, and 'unite it with the Bible for the accomplishment of his purposes in the last days.' This is the famous BOOK OF MORMON, believed by the followers of Smith (hence called MORMONS and MORMONITES) to be of equal authority with the Jewish and Christian Scriptures, and to form an indispensable supplement to them, containing God's revelations to the New, as the others to the Old World. In 420 A. D., they were finally sealed up where Smith found them, by Moroni, one of the few survivors of the battle of Cumorah.

The way in which Smith translated was as follows: he sat behind a blanket hung across the room to keep the sacred records from profane eyes, and read off by the help of his 'Urim and Thummin,' to one Oliver Cowdery, who wrote down what the invisible 'prophet' gave as a translation—Smith himself being, as he confesses, but a 'poor writer.' A farmer, of the name of Martin Harris, supplied Smith with the necessary funds to get the work printed. The *Book of Mormon* finally appeared before the world in 1830, with the names of Oliver Cowdery, Martin Harris, and David Whitmer appended to a statement, that an angel of God had come down from heaven and shewn them the original plates. This was immediately followed up by the testimony of eight other witnesses, among whom were Smith's own father and two brothers (suspected, however, it must not be forgotten, of being addicted to sheep-stealing and other nefarious practices), who affirmed that 'Joseph Smith, junior,' had shewn them the mysterious plates. These, however, are the only persons who have been so privileged. No other human being has ever seen them. Like Macpherson's Ossianic MSS., they have never been forthcoming, however loudly demanded, and of late years, all knowledge of them has become traditional.

Attention was soon drawn to the newly-published work, and a controversy sprung up regarding its real authorship. Evidence was brought forward by the opponents of Smith to shew that with the exception of certain illiterate and ungrammatical interpolations, bearing on religious matters, the so-called *Book of Mormon* was really borrowed or stolen nearly *verbatim* from a MS. romance written by a quondam clergyman, named Solomon Spalding, who died in 1816. It is unnecessary to go over the arguments *pro* and *con*. Suffice it to say, that *anti-Mormons* generally think them conclusive; while the 'Saints' consider the whole story of Spalding's MS. romance a scandalous fabrication. About 1829, Smith became acquainted with one Sidney Rigdon, originally a compositor and preacher, but who by this time had begun to promulgate a species of incipient Mormonism, and had managed to found a little sect of his own. It is conjectured by the opponents of Mormonism that Rigdon (into whose hands Spalding's romance is supposed to have fallen for some time) gave it to his new associate to further his purposes, and that the latter—in whose soul there may have been (according to our theory of his character) some rude and gross religious notions and feelings—devised the ungrammatical interpolations. This theory acquires some probability from the fact, that these religious passages do not refer to old-world faiths and the practices of an ancient ritual, but to quite modern questions, such, we are told, as were rife in the villages of Western New York about 1830. Calvinism, Universalism, Methodism, Millenarianism, Roman Catholicism, are discussed, if not in name, yet in reality. Infant baptism is condemned; so, strange to say, are polygamy and free-masonry.

Undeterred, nevertheless, by exposure, ridicule, and hostility, Smith and his associates persevered in preaching their 'doctrine,' which was a new Americanised phase of millenarianism. They declared that the millennium was close at hand, that the Indians were soon to be converted, and that the New Jerusalem—the final gathering-place of the Saints—was to be somewhere in the heart of the American continent. The 'prophet's' house 'was frequently beset by mobs, and evil-designing persons; several times he was shot at, and very narrowly escaped;' but his fearless courage continued to bring him disciples; and on April 6, 1830, the *Church of*

Jesus Christ of Latter-day Saints was first organised in the town of Manchester, state of New York. Smith was fiercely attacked by the leaders and preachers of the other religious denominations, but he kept his ground stubbornly, argued pretty well, and when argument failed, had recourse to a style of zealous prophetic asseveration, which is generally irresistible with weak and ignorant people. If the orthodox preachers, however, could not baffle him in speech, they knew how to inflame their hearers with the most ferocious animosity against the new sect; and in January 1831, Smith and his followers considered it prudent to remove to a distant part of the country. They established themselves at Kirtland, in Ohio, which was to be the seat of the New Jerusalem. They now made immense progress. Their missionaries were full of zeal (none more so, however, than Smith himself), converts were made in great numbers, and churches were established in the states of Ohio, Pennsylvania, New York, Indiana, Illinois, &c. Still the eyes of the new sect turned westward—to the region of the great prairies, where they might be allowed to work out their system in peace and freedom. In the autumn of 1831, a colony was established in Jackson County, Missouri, which a 'revelation' given to Smith assured the Saints was 'the land of promise and the place for the city of Zion.' Land was largely bought; preaching was vigorously carried on, a printing-press was established, a monthly periodical, *The Morning and Evening Star*, and a weekly newspaper, *The Upper Missouri Advertiser*, were started to propagate the doctrines of the new sect; everywhere was visible a spirit of industry, sobriety, order, and cleanliness. It is only fair to the M. to state these things. Account for it how we may, they were, in many important respects, morally, socially, and industrially, far in advance of their neighbours. When Smith returned to Kirtland, he set up a mill, a store, and a bank, and continued his propagandist labours with great success, but not without savage persecution; thus, for example, on the night of March 22, 1832, a mob of Methodists, Baptists, Campbellites, and other miscellaneous zealots, broke into the prophet's house, tore him from his wife's arms, hurried him into an adjoining meadow, and tarred and feathered him! Sidney Rigdon was similarly handled, and rendered temporarily insane. Smith, however, undaunted by this brutal treatment, preached next day with his 'flesh all scarified and defaced,' and proved the folly of persecution by baptising three new converts in the afternoon. Meanwhile, the brethren in Missouri continued to prosper, but this very circumstance deepened the animosity towards them of all who were not Mormons. Whispers also began to be spread about their indulging in a community of wives. The rumour was not true, but it probably originated in some manifestations of a tendency towards polygamy—a doctrine not yet revealed, however (in fact, *contrary* to the 'revealed' doctrine on the subject), and it materially helped to inflame the hostility of the impulsive and unscrupulous backwoodsmen. Smith himself affirms that the neighbours of the Saints were, 'many of them, the basest of men, who had fled from the face of civilised society to the frontier country, to escape the hand of justice.' Be that as it may, secret societies were formed to expel the M. from Missouri; their periodicals were stopped, their printing-press confiscated, their bishops tarred and feathered, and numberless other outrages were committed. Finally, the hapless 'Saints' were compelled to flee across the Missouri River, and men, women, and children had to encamp in the open wilderness on a winter-night in 1833. They subsequently settled in Clay

County, in the same state, where they remained upwards of three years. In July 1834, they were visited by the 'prophet' himself, accompanied by 100 persons, mostly young men, and nearly all priests, deacons, teachers, and officers of the church. During a brief residence of one week among them, he accomplished much in the way of vigorous organisation; next year, 1835, a further step was taken in the development of a hierarchy by the institution of a body of apostles—twelve in number—who were sent out to preach the new doctrines among the Gentiles. One of these twelve was the famous Brigham Young, who had become a convert about the close of 1832, and had soon shewn himself to be a man of wonderful sagacity and force of character. He was ordered down east among the Yankees, and made numerous converts even among this acute people. In 1837, Orson Hyde and Heber C. Kimball were despatched as missionaries to England, where they received large accessions to their numbers, especially from the masses in the great manufacturing and commercial towns, Manchester, Liverpool, Leeds, Birmingham, Glasgow, and, above all, from the mining districts of South Wales, where Mormonism, in some places, almost competed for popularity with Methodism itself. Since then, they have extended their strange evangelisation to the East Indies, Australia, the islands of the Pacific, Egypt, Palestine, Turkey, and almost every country on the continent of Europe.

About the close of 1837, or the beginning of 1838, the bank at Kirtland stopped payment, and proceedings were taken against the prophet and others for swindling. Luckily, just at this moment, he received a 'revelation' to depart into Missouri, which he instantly obeyed, with all the more alacrity that internal disorders had painfully manifested themselves in the new colony. These were at last healed; but the conflict between the Saints and the other Missourians became fiercer, more envenomed, more sanguinary than ever, assuming, in fact, almost the proportions of a civil war. The prophet and Rigdon were thrown into prison, and finally, towards the close of 1838, the whole body of Saints, about 15,000, quitted Missouri, and took refuge in Illinois. Here they obtained a grant of land in the vicinity of the little town of Commerce, a name which the M., in obedience to a 'revelation' given to Smith, changed to Nauvoo, or The City of Beauty. The country was a mere wilderness when the M. settled in it: it soon began to rejoice and blossom as the rose. Lieutenant Gunnison (a most intelligent and impartial writer) is forced by facts to be eloquent in praise of Mormon industry, and gives us a perfectly enchanting picture of the new colony. The legislature of Illinois granted a charter to Nauvoo; a body of Mormon militia was formed, under the name of the Nauvoo Legion, of which the prophet was appointed commander; he was also appointed mayor of the city, and was thus supreme in all matters civil and military, as well as religious. As early as 1838, the prophet, it is affirmed, had commenced to practically carry out his doctrine of the 'Celestial Marriage,' or of a 'Plurality of Wives;' but it was not till July 1843 that he formally received a revelation on the subject authorising polygamy. When the 'revelation' became public, considerable indignation was felt even in Nauvoo, and serious disturbances took place, the ultimate result of which was that the prophet and his brother Hiram were thrown into prison at Carthage. After a short time, it began to be rumoured that the governor of the state was desirous of letting the two Smiths escape, whereupon a band of 'roughs,' about 200 in number, broke into the jail, 27th June 1844, and shot them. Disasters

as this termination of his career was to Smith himself, there cannot be the shadow of a doubt that it was a most fortunate thing for the system which he founded. 'The blood of the martyrs is the seed of the church.' A halo of solemn and tender glory now encircles the memory of one, who, whatever were his virtues, stood greatly in need of this spiritual transfiguration. Already, as Lieutenant Burton remarks, the Saints begin to speak of 'him' 'with a respectful reverential *sotto voce*, as Christians name the Founder of their faith.'

Smith's death created great agitation and confusion among his followers. Sidney Rigdon and others aspired to succeed him, but the Council of the Twelve Apostles unanimously elected Brigham Young, and events have shewn the wisdom of their choice. The legislature of Illinois having revoked, in 1845, the charter given to the city of Nauvoo, and the hostility of their neighbours not having in the least abated, the Saints resolved to emigrate far beyond the boundaries of civilisation, and to seek a new home amid the solitudes of the Rocky Mountains, where they might pass their lives in unmolested peace. Explorers were sent out to examine the country, and brought back a favourable report of the Great Salt Lake Valley. See GREAT SALT LAKE, SALT LAKE CITY, and UTAH. In February 1846, the first emigrants crossed the ice-bound Mississippi, settled for a year in Iowa, and then marched under the strictest discipline across the great wildernesses. Agricultural operations were commenced almost the instant they arrived at the shores of the Salt Lake. The cheerfulness, intelligence, and zeal exhibited on all sides, were truly admirable. The world has never seen swifter, more active, more glad-hearted colonists than these singular 'Saints.' It would be unfair to shut our eyes to such facts. In judging Mormonism, we must keep them constantly in view, to prevent us from forming mere abstract and theoretical decisions, which will not in the least affect the future of Mormonism. Brigham Young arrived in the Valley, July 24, 1847, and the main body of the M. in the autumn of 1848. The Salt Lake City was soon founded, an emigration fund established, and settlers poured in from all parts of Europe and America; and perhaps a greater amount of physical comfort was enjoyed here than in any other part of the world. In 1850, the government of the United States admitted the region occupied by the M. into the Union, as a territory, under the name of UTAH, and Brigham Young was appointed governor by President Fillmore. District judges were also appointed by the federal government, but these were looked upon with great suspicion and mistrust by the Saints, who finally drove them out of the country in 1851. Brigham Young was now suspended from his office of governor, and Colonel Steptoe of the United States army was appointed his successor. He arrived in Utah in 1854, but found it prudent after some time to withdraw from the country. During the next two years, the collisions between the United States officers and the Saints became more and more frequent, and in the spring of 1856, the whole of the former were forced to flee from the territory. A new governor, Alfred Cumming, was appointed by the authorities at Washington in 1857, and also a new superintendent of Indian Affairs; besides, a force of 2500 men was sent to enforce obedience to the laws of the United States. The Saints attacked their supply-trains, and compelled the enemy to winter at some distance from the Salt Lake. In the early part of next year, negotiations were entered into between the contending parties; the M. submitted to the federal authority, and the federal troops were allowed to encamp on the western side of Lake Utah, about

forty miles from Salt Lake City, where they remained till 1860, when they withdrew.

The exact number of the Saints cannot be ascertained, but it is believed to amount to at least 200,000, of whom perhaps one half are scattered over the Old World; the rest are chiefly in Utah.

Hierarchical Organisation.—Mormonism is a pure theocracy; its priesthood, who rule in matters temporal and ecclesiastical, are divided into various orders. The highest is the *First Presidency*, composed at present of Brigham Young, Heber C. Kimball, and Daniel C. Wells—the successors of Peter, James, and John in the Gospel Church. Of these, Brigham Young is *primus inter pares*. The first presidency is elected by the whole body of the church, and possesses supreme authority. The second office in point of dignity is that of *Patriarch*, held at present by the nephew of Joseph Smith, whose chief duty is to administer blessings. Then follows the council of 'The Twelve,' whose functions are of great practical importance. They ordain all other officers, elders, priests, teachers, and deacons; they baptise, administer the sacraments, and take the lead in all meetings. Next come the *Seventies* (of whom there are many). They are under the direction of the 'Twelve Apostles'—and are the great propagandists, missionaries, and preachers of the body. The fifth order is that of *High-priests*, composed usually of men advanced in years. Their duty is to officiate in all the offices of the church when there are no higher authorities present. After these come the *Bishops*, who are 'overseers' of the church chiefly in secular matters, attending to the registration of births, marriages, and deaths, the support of 'literary concerns' (such as newspapers and magazines), house-visiting, and the settlement of private grievances. The duties of the *Elders* are not very precise; they are charged with the conduct of meetings, and exercise a general surveillance over the *Priests*, who correspond to the 'fixed ministry' of other sects, i. e., they preach, exhort, and expound the Scriptures. The lowest orders are the *Teachers* and *Deacons*; the former are simply assistants to the priests, elders, and bishops, and act as catechists; the latter are church-collectors, treasurers, &c.—The whole priesthood is divided into two classes, the Melchisedek and the Aaronic. To the first belong the offices of apostle, seventy, patriarch, high-priest and elder; to the second, those of bishop, priest, teacher, and deacon. The latter can be held only by 'literal descendants of Aaron,' who are pointed out by special revelation.

Doctrine.—The Saints are almost incredibly materialistic in their doctrines. Their Godhead is formed on Buddhistic principles. While professing to believe in the Trinity, they explain that God was once a man, who has, however, so advanced in intelligence and power that he may now be called (comparatively speaking) perfect, infinite, &c., but that he has still the form and figure of a man; he has even 'legs,' as is evident (according to Mr Pratt, an eminent Mormon) from his appearance to Abraham; though he has this advantage over his creature, that 'he can move up or down through the air without using them.' Christ is the offspring of the 'material' union, on the plains of Palestine, of God and the Virgin Mary—the latter being duly married after betrothal by the angel Gabriel. Yet he is believed to have had a previous existence, to have even made the universe out of 'unformed chaotic matter as old as God,' and his worship is enjoined as Lord of all. The Paraclete is vaguely described, but is also material. It would appear, however, that there is an older Trinity, that of 'Elohim, Jehovah, and Michael, which is Adam.' Adam, again, is declared to be the 'god' of Jesus

Christ; Jesus Christ, the god of Joseph Smith; and Joseph Smith is now the god of this generation; but the whole affair is a mass of unintelligible rubbish. The human intellect probably never sank into more abysmal nonsense; all that can be definitely set before the mind is, that M. believe that by faith, obedience, holiness, any man may rise into a deity, and acquire the power of making, peopling, and ruling a 'world' for ever! The *second* article of the Mormon creed affirms that 'men will be punished for their own sins, and not for Adam's transgressions'—an opinion which, if not very orthodox, is considerably more rational than those embodied in the first article; the *third* article states that 'through the atonement of Christ, all mankind may be saved by obedience to the laws and ordinances of the Gospel.' The *fourth* article affirms these 'ordinances' to be: 1. Faith in the Lord Jesus (which is very curiously expounded). 2. Repentance. 3. Baptism (which takes place at eight years of age—that being, according to the Saints, the period at which moral responsibility begins). They also baptise for the dead, in accordance with St Paul's saying (1 Cor. xv. 29), and assert that at the resurrection all the persons for whom a man has been baptized will be added to his family. 4. Imposition of hands by the gift of the Holy Spirit. 5. The Lord's Supper, administered kneeling. The Saints, who are much averse to strong drinks, use water instead of wine in the sacrament, which is taken every week. The *fifth* article declares that 'men must be called to the work of God by inspiration;' the *sixth*, that the same organisation must now exist that existed in the primitive church; the *seventh*, that miraculous gifts—'discerning of spirits, prophecy, revelations, visions, healing, tongues,' &c.—have not ceased. The 'discerning of spirits' led Smith into a variety of curious speculations. He believes that the soul of man was not created, but 'coexisted equal with God. "God," he says, "never did have power to create the spirit of man at all—the very idea lessens man in my estimation—I know better!"' He also believes in the transmigration of souls. Rebellious spirits descend into brute tabernacles, till they yield to 'the law of the everlasting gospel.' The *eighth* article is decidedly liberal; it expresses a belief that the word of God is recorded not only in the Bible and the Book of Mormon, but in 'all other good books.' As for the contradictions that exist in the first, Smith admits them, but alleges that they are 'corruptions,' and that they can be removed by his or any other prophet's inspired explanations. It is said that he has left an 'inspired translation' of the whole Bible in MS. The *ninth* article expresses a belief in all that God has revealed, is revealing, or will yet reveal. The *tenth* affirms the literal gathering of Israel, the restoration of the Ten Tribes (the 'American Indians,' who are, in consequence, treated with considerable humanity by the Saints), the establishment of the New Zion on the western continent—the millennial reign of Christ on earth, and the transformation of earth into a Paradise. The *eleventh* article maintains 'the literal resurrection of the body'—to 'flesh and bones,' but not blood—blood being, according to Smith, 'the principle of mortality.' The *twelfth* article asserts the absolute liberty of private judgment in matters of religion; the *thirteenth*, declares it the duty of the Saints and all others to be 'subject to the powers that be,' whether monarchical or republican. The *fourteenth* and last is worthy of being universally accepted: 'We believe in being honest, true, chaste, temperate, benevolent, virtuous, and upright; and in doing good to all men;' also that 'an idle or lazy person cannot be a Christian, neither have salvation.'

The religious views of the M. are, it will thus be seen, an extraordinary jumble. They have something in common with nearly every sect that has ever been known. Hebraism, Persian Dualism, Brahmanism, Buddhist apothecosis of saints; Christianity, both in its orthodoxy and heterodoxy; Mohammedanism, Drusism, Free-masonry, and latterly, Methodism, Swedenborgianism, Mesmerism, and Spirit-rapping, have all contributed something. The Saints do not deny this. Smith, in fact, declares that as every religion in the world 'has a little truth mixed with error,' it is the duty of his followers to pick it out, that 'all the good and true principles may be gathered together;' 'otherwise,' he adds, 'we shall never become pure Mormons.'

The great social peculiarity of the sect is their practice of polygamy. It was not so, however, at first. From 1830 to 1843, they were monogamists, but in the latter of these years, as we have seen, Smith obtained a revelation permitting, and even recommending, a plurality of wives. Still, it does not appear to have become the practice, among the M., till their journey across the prairies to the Valley of the Salt Lake. Since then, it has been boldly avowed, and defended against other Christians by an appeal to Scripture. M. are permitted to be monogamists, but encouraged to be polygamists by the 'revelation' given to the prophet, that the rank and dignity of Saints in the other world is proportioned to the number of their wives and children. A defence of the practice is also set up on moral grounds. M. assert that their community is free of the horrible sin and viciousness that prevail elsewhere; fornication and adultery, with their guilty passions and abandoned conduct, are declared to be unknown; they boast that they have no wretched prostitutes, no illegitimate children, no vile seducers; their wives are asserted (Burton and others are very strong on this point) to be happy, virtuous, and healthy, and they challenge comparison in regard to their domestic and social purity and felicity with any monogamic community in the world.

See *Book of Mormon* (1830); *Book of Doctrine and Covenants*, consisting of select 'revelations' given to Smith (1832); *The Pearl of Great Price*, also by Smith (first published; Liverp. 1851); *Journal of Discourses*, by Brigham Young and others (1854 et seq.); *The Exploration and Survey of the Great Salt Lake*, by Captain Stansbury (1849); *The Mormons, or Latter-day Saints*, by Lieutenant Gunnison of the United States Topographical Engineers (1852); *The Mormons*, by Col. T. L. Kane (1850); *History of the Mormons*, in Chambers's *Repository of Tracts*, vol. vii.; *The Mormons, or Latter-day Saints, with Memoirs of the Life of Joseph Smith* (Office of the National Illustrated Library, London); *Voyage au Pays des Mormons*, par Jules Remy (1860); and *The City of the Saints*, by R. H. Burton (1861).

MORMYRIDÆ, a family of malacopteron fishes, allied to the *Esocidæ*, or Pike family; having longish compressed bodies, and a slender tail, swelling out at the origin of the caudal fin. The skin of the head is naked, enveloping the gill-covers and gill-rays, leaving only a slit for gill-opening. The mouth is small. All the known species inhabit the rivers of Africa. The SHARP-NOSED MORMYRUS (*Mormyrus oxyrhynchus*) is regarded as one of the best fishes of the Nile. It is caught by lines baited with worms. The M. are nocturnal fishes. They are sometimes represented on Egyptian monuments, and seem to have been held sacred by the ancient Egyptians. The modern Egyptian name is *Mideh*. Some of the species have electric organs.

MORNY, CHARLES AUGUSTE LOUIS JOSEPH, COMTE DE, a French statesman, of the second

Empire, regarding whose parentage the biographical dictionaries published under imperial censorship are strangely silent. It is, however, universally believed that he is the son of Queen Hortense and of the Comte de Flahault, and consequently half-brother of Louis Napoleon. He was born in Paris, October 20, 1811. The Comte de Morny, a French nobleman resident in Mauritius, received 800,000 francs to adopt him as his son; but he was educated by his 'grandmother,' Madame de Flahault; and Queen Hortense left him at her death, in 1837, an annuity of 40,000 francs. M. entered the army in 1832 as a sub-lieutenant, and is said to have shewn at this early period a predilection for metaphysics and theology, which is indeed sufficiently surprising, if true, considering his subsequent thirst for material gratifications. He served with some distinction in Algeria; but he soon abandoned a military life, and in 1838, made his début in the world of industry as a manufacturer of beet-root sugar, and published a pamphlet on the subject. Ever since then, he has been mixed up in all sorts of commercial and financial speculations—railway companies, canal companies, French and foreign mining companies, credit societies, industrial enterprises, &c. Chosen a deputy in 1842, he quickly attained a prominent position on account of his aptitude for dealing with financial questions; but events shewed that he was not free from the reckless spirit of an adventurer, and his daring at times excited a suspicion of enormous swindling somewhere. After the revolution of 1848, he became attached to the cause of his half-brother, and was the leader of the subtle and treasonable policy of the Elysée. He took a prominent part in the *coup d'état*. His rôle was to exhibit *sang-froid*, and to throw the republican leaders off their guard. Nor did he fail of success. He passed the evening of December 1 at the *Opéra Comique*, and yet, by six o'clock next morning the deed was done, and M. was Minister of the Interior. In 1854, he became president of the *Corps Législatif*, and was ambassador to Russia during 1856—1857, where he married the rich and handsome Princess Trubetskoi. The result of his Russian mission was the establishment of intimate political relations between the two governments, and a commercial treaty advantageous to both countries. He died May 1866.

MOROCCO, or MAROCCO, called by the natives *Maghrib-el-Aksa*, 'the extreme west,' or briefly *Maghrib*, an empire or sultanate in the north-west of Africa, is bounded on the E. by Algeria, on the N. and W. by the Mediterranean Sea and Atlantic Ocean, and on the south by a line which runs from Cape Nun (lat. 28° 45' 43" N.), in an easterly direction through the Sahara to the Algerian frontier in long. 2° E. At the present day, M. includes the three former kingdoms of Maghrib, Fez, and Tafiilet, and contains about 230,000 English square miles, with a population of about 3,500,000, though some estimates make it only 6,000,000. The country is generally mountainous, the Atlas (q. v.) range traversing it in several parallel chains from south-west to north-east, and sending out numerous spurs to both the coast-country and the desert. There are, however, many level tracts throughout M., especially at its western and eastern extremities, and on the borders of the desert. The central range of the Atlas forms the watershed separating the streams which flow into the Atlantic and Mediterranean from those which run southward to the desert. The former rivers have the shorter course and less volume, but they are perennial; while the latter become dry in summer, and even when running are lost in the sands of the Sahara. The chief rivers are the

MOROCCO.

Muluya, with its tributary the Sharef, which drains the north-east of the country, and falls into the Mediterranean after a course of 400 miles; the Kos, Oom-a-beg, Bu-Regreb, Tensift, Suse, and Assaker, the last forming for part of its course the southern boundary of M., drain the central and western districts, and fall into the Atlantic; the Draha, Fileli, Ziz, and Gir, irrigate the dry plains of Tafiilet, and the first-mentioned then empties itself into the Atlantic Ocean. The subsequent courses of the other three rivers are not yet well ascertained.

The *climate* between the central range of Atlas and the sea is temperate, the thermometer seldom falling lower than 40° F., or rising above 90° F., owing partly to the regulating influence of the sea-breeze, and the shelter afforded by the mountains from the scorching winds of the desert; but in the south-east districts, extremes of heat and cold are said to prevail, and rain is there unknown.

Among the chief *products* of the country are wheat, barley, rice, maize, durra, and sugar-cane; and among fruits, the fig, pomegranate, lemon, orange, and date are common; while cotton, tobacco, hemp, &c., are largely produced both for home use and export. M. is supposed to be rich in mineral treasures; plentiful supplies of copper are obtained at Teseleight, near the source of the Assaker, and gold and silver occur in several places. Iron, antimony, lead, tin, and rock-salt, the last three in considerable quantity, are also found. Owing to the character of the country and its thin population (35 to the English square mile), M. is much infested with wild animals. Lions, panthers, hyenas, wild-boars, and various kinds of deer, gazelles, &c., abound in suitable localities, and occasional devastations are committed by locusts. Ostriches are found in Tafiilet. The Moorish horses, formerly so famous, are now much degenerated. The breeding of sheep, oxen, goats, camels, mules, and asses, forms an important item of national industry. Oxen and bulls are chiefly employed in field-labour.

The *inhabitants*, like those of Barbary in general, consist of Moors, Berbers, Arabs, Negroes, and Jews, with various intermixtures between these races. The Moors are the most numerous, and are the dominant race in M., numbering about 4,250,000; next to them are the Berbers, or Amaziyehs, who amount to about 3,750,000, and include the Berbers of the Riff coast, and the Shelluhs of the Great Atlas. Very few Europeans reside in Morocco. The state of civilisation is very low, and many of the Amaziyehs are complete savages. Excepting the Jews and the few Europeans, the whole population is Mohammedan. The negroes are generally brought into the country as slaves from Sudan.

M. is divided into four territories—Fez, Morocco, Suse, and Tafiilet. For convenience of administration, the empire is subdivided into 33 governments or districts ('ammala'), each under the superintendence of a 'caid,' whose chief duty it is to collect the imposts; but the semi-independent tribes are ruled by their own chiefs, and scarcely acknowledge the authority of the sultan. The government is purely despotic, and in the absence of written laws, the will of the sultan and his subordinates decides everything. The public officials eke out their allowances by practising extortion on those under their charge, and are in turn plundered by their superiors. The sovereign of M., called by Europeans the Emperor of M., is known among his subjects as sultan, and assumes the titles of *Emir-ul-mumenin*, or 'Prince of the Believers,' and *Khalifeh-allah-fi-chaliki*, or 'Vicegerent of God upon Earth.' The title is hereditary in the male line, but does not necessarily descend to the eldest son.

Education consists in learning to read, write, and

recite portions of the Koran, and this quantum of education is pretty generally diffused among the people, but the art of printing is unknown, and the arts and sciences are at a very low ebb.

The only industrial arts prosecuted to any considerable extent are the manufactures of caps, fine silks, and leather. In the production of this last, the Moors far surpass Europeans, and are able to render any kind of leather extremely soft and white, by the use, it is said, of two species of plants found in the country, and unknown to Europeans. They also excel in the production of brilliant colours in leather. The yellow leather is made in M. Proper, the green in Tafiilet, and the red in Fez. There is an important caravan-trade between M. and Sudan, and also with Mecca and the Levant. The principal exports are wool, hides, grain, cattle and sheep, leather, salt, &c.; and the imports, cotton, linen, and muslin goods, sugar, tea, coffee, hardware, gold-dust, indigo, ivory, &c. Mules, horses, and camels, form the internal means of transport. Much of the Arabian trade is carried on by coasting-vessels between Tangier and Egypt, as the carriage across the desert is very costly. At the present time, two-thirds of the entire trade of M. is in the hands of British merchants.

The army consists of between 15,000 and 20,000 men, of whom one-half are negroes; there is also a sort of militia, amounting to 80,000 or 100,000 men, which is occasionally called out. The navy is now insignificant; but in former times, especially in the 16th and 17th centuries, it was very formidable to the maritime powers of Europe, and was chiefly occupied in piratical expeditions. See *Riff*.

The history of M. is, generally speaking, similar to that of the rest of Barbary (q. v.) down to the end of the 15th century. About that time, it was formed into a monarchy, and notwithstanding internal divisions, enjoyed considerable prosperity, and the confines of the empire were extended as far south as Timbuktu. This empire fell to pieces, and was succeeded in 1647 by that of the Sherifs of Tafiilet, who conquered both M. Proper and Fez, and united the whole country under one government. This is the present ruling dynasty. In the middle of the 17th c., the empire of M. embraced part of the present province of Algeria, and extended south as far as Guinea, where it came into collision with the Portuguese settlements. Since the commencement of the 19th c., the rebellions of the wild mountain tribes, the disturbances in Algeria, and difficulties with foreign states, caused by the aggressions of the Riff pirates, have greatly retarded the well-conceived measures of the various rulers for the development of the resources, and increase in civilisation of Morocco. In 1814, the slavery of Christians was abolished; and in 1817, piracy was prohibited throughout Morocco. In 1844, M. took part in the war of Abd-el-Kader against the French, in the course of which Tangier was bombarded and Mogadore occupied; but peace was concluded in the same year. In 1851 and 1856, complications took place with France concerning some French vessels which had been plundered by the Riff pirates, but in each case compensation was given by the sultan. In 1859, the Spanish government, smarting under a series of similar outrages, demanded compensation, and also an apology for an insult to the Spanish flag at Cents; and on the sultan's disclaiming all responsibility for these acts, war was declared by Spain, October 22, 1859, and a large force under Marshal O'Donnell invaded Morocco. Two battles were fought, several ports were bombarded, and Tetuan taken, and on March 25, 1860, the sultan yielded. A treaty was accordingly signed, April 27, 1860, by which the sultan ceded some portions

of his territory, paid 20,000,000 piastres towards the expense of the war, and granted several commercial privileges to Spanish merchants.

MOBOCCO (Arab. *Marakash*), the capital of the empire of the same name, is situated in the south-west of the country, 4 miles south of the river Tensift, and at the north end of an extensive and fertile plain. It is surrounded by a strong lime-and-earth wall 30 feet high. The town is ill built, the streets narrow, irregular, and unpaved; the houses, generally built of the same materials as the wall, are one story high, with flat roofs, and narrow openings instead of windows. A large portion of the space within the walls is occupied with gardens, open areas, and market-places. In the bazaar and market-place, a large miscellaneous trade is carried on. M. possesses 19 mosques, of which 6 are remarkable for their size and elegance. There are several tanning and leather-dyeing establishments, some of them of great extent. The population is estimated at about 50,000.

On the south of the city, outside the walls, stands a palace of the sultan of M., occupying a space of about 180 acres.

M. was founded in 1072, and reached the summit of its prosperity in the 13th c., when it contained more than 700,000 inhabitants, since which time it has been rapidly decaying. It is now half in ruins.

MORON, a town of Spain, in the province of Seville, and 37 miles south-east of the city of that name, on the Guadeira. It is built on irregular acclivities, and contains the remains of a once almost impregnable castle, erected by the Moors on Roman foundations. The inhabitants are engaged in the culture and preparation of olive-oil. Pop. 10,500.

MORPETH, a market-town and parliamentary and municipal borough of England, in Northumberland, is situated on the Wansbeck, 15 miles north of Newcastle. Of the principal buildings, the pariah church dates from the 14th c.; the Free Grammar-school of Edward VI., founded in 1552, has an income from endowment of £650 a year; the town-hall was erected by Sir John Vanbrugh. Flannel is manufactured; brewing, malting, and tanning are carried on, and iron foundries and corn-mills are in operation. M. returns a member to the House of Commons. Pop. of municipal borough (1861), 4296; of parliamentary borough, 13,794.

MORPHEUS (literally, the 'shaper' or 'fashioner'), in the Classic Mythology, the son of Somnus (Sleep), and the god of dreams. He is so named, because he shapes or moulds the dreams that visit the sleeper. He is first mentioned by Ovid, and is represented as an old man with wings, pouring somniferous vapour out of a horn.

MORPHIA ($C_8H_9NO_3 + 2 Aq$) derives its name from Morpheus, in allusion to its narcotic properties. It is the most important of the alkaloids existing in opium, of which it constitutes from $\frac{1}{4}$ th to $\frac{1}{5}$ th by weight. It occurs in combination with meconic, and sometimes with sulphuric acid. It is obtained in short rectangular prisms, containing two equivalents of water of crystallisation, which are expelled at a gentle heat, when the morphia melts into a resinoid substance. Morphia is soluble in about 1000 parts of cold and in 400 of boiling water; boiling alcohol dissolves it freely, but it is insoluble in ether and chloroform. Its solutions have a bitter taste, and change the yellow colour of turmeric paper to brown. Morphia is not so easily detected in cases of poisoning by opium as Meconic Acid (q. v.). The following are the ordinary tests for it: concentrated nitric acid, when applied to a crystal either of morphia or of one of its salts, produces an

orange colour. A mixture of nitric and sulphuric acids colours it green. When it is mixed with iodic acid, iodine is liberated, which may be recognised by its brown colour and by the well-known starch-test. A neutral solution of perchloride of iron produces a beautiful blue colour.

Morphia is the only opium-alkaloid which is soluble in lime-water, and this property affords one of the best means of extracting it. A watery infusion of opium is boiled with milk of lime, filtered, mixed with powdered sal-ammoniac, and again boiled. By this means, the lime is converted into the hydrochlorate (or, more correctly, into chloride of calcium), the ammonia is volatilised by the heat, while the morphia is precipitated in a crude form, which admits of easy purification.

Morphia combines with acids to form crystallisable salts, which are readily soluble in water and in alcohol. Of these, the *Hydrochlorate* (*Muriate*) and the *Acetate*, especially the former, are much used in medicine.

The therapeutic uses of morphia and its salts are very similar to those of Opium (q. v.); but the preparations of morphia are preferable to opium and laudanum in being less liable to occasion nausea and headache. The ordinary dose of morphia, or its hydrochlorate or acetate, when given to an adult to allay pain or induce sleep, ranges from a quarter of a grain to half a grain. The British Pharmacopœia which is now published (January 1864), and which supersedes the London, Edinburgh, and Dublin Pharmacopœias, contains a solution of the hydrochlorate of morphia, in which there is half a grain of the salt in one drachm of the solution; hence the ordinary doses of this solution range from 30 minims to a drachm. The pharmacopœia also contains morphia lozenges and morphia and ipecacuan lozenges, in each of which there is one-thirty-sixth of a grain of hydrochlorate of morphia.

MORPHOLOGY. See **METAMORPHOSIS OF ORGANS.**

MORRIS-DANCE, a peculiar and fantastic species of dance, commonly practised in the middle ages, and existing at the present day among the country people in several parts of England. Its origin is ascribed to the Moors, though the genuine Moorish dance (the *fandango* of the present day) bears little resemblance to it. The chief performer was the *hobby-horse*, so called from the light frame of wickerwork which was fastened round his body, and supplied with a pasteboard head and neck, so as to give him the appearance of a man on horseback. Bells were also attached to his ankles, and the great art consisted in so moving the feet as to produce a rude kind of concord. The other principal actors, after a rude fashion, personified the characters of Maid Marian, the Queen of the May, Robin Hood, Friar Tuck, the Fool, &c.; and the performance was accompanied by rude music, and the clashing of swords and staves, and was the chief amusement at parochial festivals.

MORRISANIA, a village of New York, United States, in Westchester County, on the New York and New Haven Railway, and about ten miles north of New York. It has been mostly built within the last five or six years, and is chiefly occupied by persons doing business in New York. Pop. (1860) 9245.

MORRISON, ROBERT, D.D., the founder of Protestant missions in China, was born of Scottish parentage at Morpeth, in Northumberland, 5th January 1782. He studied at one of the Independent colleges, and in 1805, he was sent to Macao and Canton by the London Missionary Society, to learn the Chinese language, and to

translate the Bible into it. He reached Canton in September 1807, and in the course of a year was appointed translator to the East India Company's factory at Canton. By the year 1814 he had completed the translation and printing of the whole of the New Testament. Four years later, by the help of Mr (afterwards Dr) Milne, he had done the same with the Old Testament; and in 1822, he completed and printed his great *Chinese Dictionary* at an expense to the East India Company of £15,000. In 1816, he acted as interpreter to Lord Amherst. In 1818, he established an Anglo-Chinese College at Malacca for English and Chinese Literature, and for the propagation of Christianity. After a residence of 17 years in China, he returned to England in 1824, and brought with him a collection of 10,000 books in the Chinese tongue. In 1826, he returned to China. In 1834, he accompanied Lord Napier to Canton as interpreter, and died there 1st August. Besides the works already mentioned, he is the author of *Hours Sincere* (Lond. 1812), being translations from the popular literature of the Chinese; a *Chinese Grammar* (Serampore, 1815), and *Chinese Miscellany* (1825). In 1839, his widow published *Memoirs of the Life and Labours of Robert Morrison*.

MORRISTOWN, a village of New Jersey, United States of America, on the Whippany River, and the Morris and Essex Railway, 23 miles west of New York, on an elevated plain, commanding a fine prospect. It has a court-house, 2 banks, 7 churches, and several literary institutions. Pop. (1860) 6024.

MORSE, WALRUS, or SEA-HORSE (*Trichecus*), a genus of amphibious mammalia of the family *Phocidae*, agreeing with the rest of that family—the seals—in the general form of the body and limbs, but widely differing from them all in the head, which is remarkable for the enormous development of the canine teeth of the upper jaw, and the tumid appearance of the muzzle caused by the magnitude of their sockets, and by the thickness of the upper lip. These great canine teeth form two tusks directed downwards, and the lower jaw becomes narrow in front, so as to pass between them. There are no canine teeth in the lower jaw. The incisive



Morse (*Trichecus rosmarus*).

teeth are small, six in the upper jaw, and four in the lower, mostly disappearing from adult animals. The molars—at first, five on each side in each jaw, but fewer in the adult—are simple, and not large; they have the crowns obliquely worn. The nostrils, as if displaced by the sockets of the tusks, open almost upwards, at some distance from the muzzle. The eyes are small; and the ears have no auricle, or, in popular language, there is no ear.—There is only one known species (*T. rosmarus*), sometimes called the **ARCTIC WALRUS**, an inhabitant of the

Arctic seas and of the colder parts of the north temperate zone. It sometimes attains a size greater than that of the largest ox, and the tusks are sometimes two feet, or even thirty inches long; but the ordinary length of the tusks is only about one foot. The *M.* is a gregarious animal, and is often seen in great herds, which sometimes leave the water to rest for a while either on the ice or on the land, where, however, their movements are very awkward and clumsy, and the hunter assails them with much greater prospect of success than in the water. Hundreds have thus been killed at one time, although the adventure is not without danger, as they must be assailed with spears, their hide being thick enough to resist even a rifle bullet. The *M.* uses its tusks for protecting itself or young from attack, for combating with its enemy the polar-bear, for aiding it in climbing upon ice; but principally, it is supposed, for tearing sea-weed from submarine rocks; that being, there is every reason to think, the principal food of the animal, although it is supposed also to prey on molluscs, crustaceans, and other marine animals. The female *M.* shews great affection for her young, and will defend it to the last extremity; the young also remains beside the mother even after she is killed. When one of these animals is attacked, the rest of the herd—at least if in the water—hasten to its assistance. The *M.* is very capable of being tamed.—It is much sought after by the inhabitants of the most northern parts of the world for its skin, thongs of which seem to have been generally used in former times for ropes and cables—esteemed so valuable, that the Finlanders paid tribute in this article; whilst its oil—not very abundant—is employed like seal oil; and the tusks are very much valued as ivory, being superior in compactness to those of the elephant. The flesh is coarse, but is eaten by the Esquimaux. The young *M.* has not large tusks like the adult.

The *M.* has occasionally been seen on the British coasts, probably transported on icebergs from the north.

The name *M.* is from the Russian *Mors* or Lapp *Morsk*. The name *Walrus* is Norwegian (*Hval-ros*, Whale-horse). Another Norwegian name is *Rosmar*, supposed to be from the Teutonic *ros*, horse, and *mar*, the sea.

MORSE, SAMUEL FINLEY BREESE, LL.D., &c., American artist and inventor, is the eldest son of Rev. Jedediah Morse, D.D., geographer, and was born at Charlestown, Massachusetts, April 27, 1791. He graduated at Yale College in 1810, and visited England with the American painter Washington Allston, to study painting with him and Benjamin West. In 1813, he received the gold medal of the Adelphi Society of Arts for his first effort in sculpture, the 'Dying Hercules.' Returning to New York in 1815, he became the first president of the National Academy of Design, and was appointed Professor of the Arts of Design in the university of the city of New York. He did not give his entire attention to art, but was interested in chemistry, and especially in electrical and galvanic experiments; and on a voyage from Havre to New York, in 1832, he conceived the idea of a magnetic telegraph, which he exhibited to congress in 1837, and vainly attempted to patent in England. His claims to priority of invention over Professor Wheatstone in England have been the subject of considerable controversy. See TELEGRAPH. He struggled on with scanty means until 1843, when, as he had almost yielded to despair, congress, at midnight, and the last moments of the session, appropriated 30,000 dollars for an experimental line between Washington and Baltimore. For his telegraphic inventions, *M.* has been rewarded by testimonials,

honours, orders of nobility, and wealth. Several European states joined in presenting him a purse of 400,000 francs, and banquets were given him in London and Paris. The recording instrument in use in America is his invention.

MORSHANSK, a district town in the centre of the government of Tambof in European Russia, 56 miles north of Tambof, is situated on the left bank of the Tzna, a feeder of the Oka. Its population in 1859 was 13,812. M. is the port for shipment of the corn of the provinces of Simbirsk and Saratof, the shipments annually amounting in value to 5,000,000 rubles. There is also a large market for the cattle and sheep of the south-east provinces, the average annual supply being 20,000 cattle and 100,000 sheep; also for melted grease, of which 1,500,000 rubles worth is sent yearly to St Petersburg and Moscow. The trade of the town itself is of little importance, the chief establishments being soap-boileries, flour-mills, and sailcloth manufactories.

MORTALITY, LAW OF. While there are few future events the date of whose arrival is more uncertain than that of death to any one man, on the other hand, the average duration of a multitude of human lives is found to be in accordance with a law which operates as surely as that of gravitation. If it be asked how many lives must we have, before we can depend on obtaining from them a duration equal to the general average, the only answer that can be given is, that the more we have the more nearly must we approach to this result; the fluctuation ultimately becoming so small as to be practically of no effect. So long ago as early in the 17th c., a certain John Graunt of London published what he called *Natural and Political Observations on the Bills of Mortality*. This work has been called 'the earliest movement in economical arithmetic, and the closest approximation to the data on which life-assurance is founded.' About the same time, Sir William Petty gave to the world many curious calculations and speculations on the same subject. In 1693, Dr Halley published the Breslau tables of mortality, and this was the first work which really raised the subject to the rank of a science. Halley's speculations had, however, been preceded by those of Pascal in France, and of De Wit in Holland; and the latter famous man is probably entitled to be considered as the first who has applied the doctrine of probabilities to the valuation of life in the question of annuities. His treatise will be found in the second volume of the *Assurance Magazine*. Halley's tables are printed in the *Philosophical Transactions* for 1693, No. 196. In 1713, J. Bernouilli's important work was published; and in 1742, Dr Price, availing himself of the principles laid down by Halley, and of data previously published by 'John Smart of Guildhall, London, Gent,' gave tables of mortality for London. In 1746, M. Deparcieux published at Paris his *Essai sur les Probabilités de la Vie Humaine*, in which he gave six valuable tables. In one of these, computed from the registers of different religious houses, it was shewn, for the first time, that female life is superior to male. In 1770, appeared the first edition of Price's *Observations on Reversionary Payments*. The speculations of Buffon, Simpson, and De Moivre about the same time were of much importance. Mortality tables are tables shewing the operation of the law of mortality. The correct method of framing them is by analysing and collating accurate and sufficiently extensive statistics of life and death. They enable us to form a fair estimate of the number of human beings who will die at the end of a given period out of a given number alive at the beginning of it; and hence, the chance of life and

death to the individual, and the mean duration of life at any age. Tables shewing the mean duration of life have been constructed in two ways: 1st, From statistics of deaths alone; and 2d, From statistics of life and death. By the first plan, they would be deduced as follows: Suppose, on searching a parish register, that we found recorded 100 deaths of children in their first year, we should assume that, on an average, $\frac{1}{4}$ a year of life would have fallen to each. This gives 50 years of life among 100. If we found that 60 had died in their second year, assigning one year and a half to each, we should have $60 \times 1.5 = 90$ years among the 60; and so on for every age up to the oldest on the register. The sum of all the years enjoyed, divided by the numbers who have enjoyed them, will give the mean duration of life from birth; and the sum of all the years enjoyed after a given age, divided by the numbers who have enjoyed them, will give the mean duration at the given age; in both cases as nearly as the data enable us to give it; but the data are insufficient. Suppose we found by a register for 1863 that 100 children had died in their first year and one man in his 96th, it is plain that, to make this ratio a fair one, there ought to have been as many births in 1768 as in 1863. If there have been only half as many born at the former date as at the latter, then we must put two lives into the calculation to make it correct; and we must proportion our results similarly at all intermediate ages. Again, suppose four deaths at age 23 to be registered, we cannot tell how many of those born in 1840 may have emigrated from one parish, nor do we know how many born elsewhere in that year may have come into it. For the rule and formula for obtaining the mean duration of life under the second method, which is an absolutely certain one, see LIFE, MEAN DURATION OF. The following are the tables now most generally used by assurance and annuity offices in this country: I. The Northampton (Dr Price's). This table was framed by Dr Price from the register of burials in the parish of All Saints, Northampton, 1735—1780. Being constructed on deaths alone, it has, as was to have been expected, proved faulty. It gives the probabilities of life too low at the younger and middle ages; and those offices which still use it—and there are a good many—have some difficulty in keeping themselves right. II. The New Northampton (Nos. 1 and 2). These tables were constructed by Dr Farr. See Eighth Report of the Registrar-general for England, pp. 277—348. No. 2 is based on the deaths alone in Northampton during the seven years 1838—1844. In its results it agrees almost exactly with that of Dr Price. No. 1 was deduced from a comparison of the deaths during 1838—1844 with the census returns of 1841. It differs widely from No. 2 and from Dr Price. By the two latter, the mean duration of life is respectively found as 24.88 years and 25.18 years. By No. 1, it is 37.5 years. III. The Carlisle. This table was constructed from observations made by Dr Heysham at Carlisle, 1780—1787. It is now generally understood that the mortality in towns is understated at ages 15—35, owing to the immigration of healthy men and women from the country. Again, the female population of Carlisle was excessive during the period in question, and the extent of the observations was limited. Owing to these facts, this table gives rather too low a rate of mortality, and is a little irregular in its graduation. In a table prepared by W. T. Thomson, Esq., in a Report on the Ministers' Widows' Fund of the Church of Scotland, 1861, he shews that the lives of the Scotch clergy are about half a year better up to 44 than the Carlisle; at 45, they are equal; and at 45 to 80, they are half a year

MORTALITY.

worse. Thereafter they vary. The widows are half a year better up to 61, equal at 62, and nearly so to the end. Probably the Carlisle gives a fair mortality rate for a healthily circumstanced population. IV. The Government. These were computed by Mr Finlaison on the lives of 22,000 nominees for government annuities. They are chiefly important as giving a view of the value of female life, but this view is one which differs widely from those given either by the 'Experience' or by the 'English' table. At age 20, for instance, the mean duration of female life is, by the Government table, 5½ years more than the male; by the Experience, it is 4 years less. In some measure this wide divergence may perhaps be accounted for by the fact that the Government results are deduced from annuitants, the Experience from assured lives. V. The English (Nos. 1 and 2). No. 1 is deduced from the living by the census of 1841, and from the deaths at corresponding ages in the same year. See 5th and 6th Reports of the Registrar-general for England, where the tables will be found, and their construction explained. No. 2 is deduced from the living in 1841, and from the deaths in the seven years 1838—1844. The results for male lives only have as yet been made public. See 9th and 12th Reports of Registrar-general. Nos. 1 and 2, so far as can be seen, agree very closely, and probably give the results of the average mortality of England more correctly than any others which we have. They are the result of enormous labour on the part of Dr Farr. Both are based on the recorded ages of 15,914,148 living persons, and No. 2 on 2,436,648 deaths. The observations were taken on the plan recommended by Professor de Morgan and Mr Griffith Davies. VI. The Experience. These were prepared by a committee of eminent actuaries on the data afforded by the combined experience of 17 life-assurance offices. The tables are given in a work by Jenkin Jones, Esq., London, 1843. The objections to which they are liable are, that certain lives having been more than once assured have appeared twice or oftener as elements in the calculations; that the average term over which the observation of the offices extends is only eight and a half years; and it is probable that the mortality which will prevail in assurance societies when they have reached maturity is somewhat understated. See letter by Dr Farr in Appendix to 10th Report of Registrar-general, p. 11. Further, the data for old ages were deficient, and this of course affects the whole. Many curious results are brought out by

this table. It shows that 'town' assured life is superior to 'country'; that female assured life is on the whole inferior to male; and that Irish life is worst of all. At age 20, 'town' mean duration is 41 years, 2 months; country, 40 years, 4 months; Irish, 34 years, 11 months. The observations of the Standard Association Company do not, however, bear out these results; and they are doubtless so largely affected by the elements of *Care in Selection* as to render it impossible to found on them any conclusion of practical value. A new set of 'Experience' tables is in course of preparation. From the eminence of the actuaries who have undertaken the work, and from the great care which is being bestowed in collecting material, they will doubtless, when completed, be a very valuable set of tables. They will give the results of English and Scotch experience united, and of Scotch separately.

In all tables deduced from the experience of assurance and annuity societies, the fact of *selection* must not be lost sight of, either in using them for the sake of comparison, or as the basis of other tables. Actuaries, however, seem to be generally of opinion that the selection exercised by assurance societies does not really lower their rates of mortality below the general average; without selection, their rate would be above the general mean; for, it will be observed, that the public are continually selecting against the offices by offering inferior lives, and good lives often surrender their policies, while lives which have become bad hardly ever do so. Again, the value of medical examination gradually disappears, and in ten years at most it is held to be quite lost. See Minutes of the House of Commons' Committee on Assurance Associations, 1853; Life-contingency Tables by E. J. Farren, pp. iii.—xiii., and De Morgan's View of the Equitable Society, 1829, p. 46. Though female life is, as a whole, undoubtedly superior to male, yet as there are more critical periods in it, it is probable that the public may more frequently select it than male life against the societies. A valuable report on the Madras Military Fund has just been published, London, 1863, in which tables are given constructed on the mortality rates prevailing among the officers, wives, and widows interested in the fund. As they have been prepared by eminent men on very ample data, they will probably be very valuable to societies transacting business in India. The following is a view of the mean duration of life, at the beginning and at each decennial period according to some of the tables mentioned above:

TABLE SHEWING THE 'MEAN DURATION' OF HUMAN LIFE, ACCORDING TO VARIOUS AUTHORITIES.

Age.	NORTHAMPTON.		CARLISLE.		GOVERNMENT.		ENGLISH LIFE TABLE.—DR FARR.			Experience of Seventeen Offices to 1847. Male and Female combined.	Age.		
	Male and Female combined. Dr Fries.		Male and Female combined. Dr Heysham.		Female. Finlaison, 1829.		Male. Female. Male and Female combined.						
	Years.	Months.	Years.	Months.	Years.	Months.	Years.	Months.	Years.			Months.	
0	25	9	38	9	55	6	40	2	41	2	—	0	
10	39	9	48	10	51	1	47	1	47	10	48	4	10
20	33	5	41	6	44	0	39	11	40	10	40	4	20
30	33	3	34	4	37	7	33	2	34	3	33	8	30
40	33	1	27	7	31	1	26	6	27	9	27	2	40
50	18	0	21	1	24	4	20	0	21	1	20	7	50
60	13	3	14	4	17	4	13	7	14	5	14	0	60
70	8	7	9	3	11	0	8	6	9	0	8	9	70
80	4	5	5	6	6	6	4	11	5	2	5	1	80
90	2	5	3	3	2	10	2	9	2	10	2	9	90
100	0	0	2	3	0	6	1	6	1	6	0	6	100
	Both Sexes.		Both Sexes.		Female Life.		Male Life.	Female Life.	Both Sexes.		Both Sexes.		

In the present article, we have considered the law of mortality, chiefly as it bears on insurance and

other monetary transactions. The wider view of the subject, as varying with occupation and in

different ages and countries, will be illustrated under the head of VITAL STATISTICS.

MORTAR. See CEMENTS.

MORTAR, a piece of artillery which differs from a cannon in the large diameter of its bore in proportion to its length, and in the circumstance that it is usually fired at a considerable angle, so that the projectile may strike the object aimed at in a



13-Inch Mortar, with Loading Apparatus.

direction more or less vertical. The object for which mortars are intended is the discharge of Live SHELLS (q. v.) or carcasses. As the projectile has a large diameter, and, except in rare instances, a very great range is unnecessary, a comparatively small charge of powder is requisite. To give this its utmost power and concentration, it is confined in a hemispherical chamber at the lower end of the bore, but of less diameter. The shell completely closes this chamber; and when the explosion ensues, receives its

full force on its centre. In the British service, the ordinary mortars range in diameter of bore from 5 to 13 inches. The 13-inch mortar is shewn in the annexed figure.

Larger mortars have, however, been tried at times, as at the siege of Antwerp Citadel in 1832, when the French brought one of 24-inches bore to the attack. This monster, owing to its unwieldiness and other causes, was a failure. Larger still than this, though perhaps more manageable, is Mr Mallet's great 36-inch mortar, constructed of iron parts welded together, for the British government, and now at Woolwich. As loaded shells are of immense weight, so heavy, indeed, as in larger calibres to involve the apparatus depicted in the fig. to deposit them in their places, and the mortar is fired at high elevations, the recoil is so great and so nearly vertical that no carriage could withstand the shock; it is necessary, therefore, that the mortar should be mounted on a solid iron or timber bed, by the trunnions, which are placed behind the breech, and supported in front by massive blocks of wood. This arrangement renders the apparatus so heavy that mortars of large size are rarely used in field operations, their ordinary positions being in defensive or siege works, and in mortar-vessels.

More wieldy, however, are the Coehorn mortars, invented by the Dutch engineer of that name, for clearing the covert-way or ditch of a fortress. This mortar is sufficiently small to be managed by one man, and is accounted useful in siege or defence operations. The French use a similar Lilliputian ordnance under the denomination of pierriers or stone-throwers. Small mortars are likewise constructed for mountain warfare: a mule carries the mortar, another the bed, and a third is laden with the projectiles. The use of mortars is diminishing at the present time, elongated shells of great weight being now thrown from rifled cannon.

MORTARA, EDGAR, a Jewish boy, whose case recently attracted great and painful interest throughout Europe. The facts are as follows: On the 23d of June 1858, Signor Momolo Mortara, a manufacturer and wholesale merchant of cloth in Bologna, and by religious profession a Jew, returning home about ten o'clock at night, found his house in the possession of the police, who informed him that they

had orders from Padre Felletti, inquisitor-in-chief at Bologna, to carry off his son, Edgar, who had been surreptitiously baptized into Christianity by a Roman Catholic maid-servant. The inquisitor was waited upon by some friends of the family a little after midnight, who implored delay. He informed them that he was acting under the orders of the Archbishop of Bologna, but consented to sist procedure till 'next evening.' The archbishop, however, was 'absent' from the city, and next evening the papal carbiniers entered the house and 'tore the child out of his father's arms.' They carried him to Rome, where he was immured in a convent. The bereaved father immediately followed, obtained several interviews with Cardinal Antonelli, and offered to prove that the servant who said she had baptized Edgar had turned out to be a worthless prostitute, living in sin with Austrian officers. The cardinal declined to interfere, on the ground that the case did not come under his jurisdiction, and recommended Signor Mortara to apply to 'the proper tribunals.' After some weeks had passed, the child was removed to Alatri, whither his father and mother also went, and saw Edgar in a church among a number of priests, but had no opportunity of speaking to him. They returned to Rome, once more sought the presence of Cardinal Antonelli, and prevailed upon him so far that he ordered the child to be brought back to the city, and allowed his parents several times to converse with him. These interviews are described as agonising, and Edgar earnestly entreated his father and mother to take him home, but this of course was a hopeless request. He had been baptized, and baptism, no matter by whom administered, was an inviolable rite, which laid the Catholic Church under the solemn obligation of protecting its son from the snares of parental infidelity. It dared not give him up. Signor Mortara and his wife had to go away without their child. The case soon became known throughout Europe, and excited great indignation, more particularly in England. The Evangelical Alliance drew up a protest, which was signed by the Archbishop of Canterbury and above twenty other bishops, by a large number of peers, members of parliament, heads of colleges, and ministers of the gospel, by upwards of a hundred mayors and provosts, and by many other influential laymen. It was presented to Lord John Russell. The British Jews presented another. Nothing, however, has as yet been effected by their efforts. Edgar Mortara is still in the hands of the church-authorities. When Bologna, along with the greater part of Italy, passed under the sway of Victor Emmanuel in 1860, the inquisitor, Felletti, was arrested and thrown into prison. His trial, however, so far as we know, has not yet come off.

The above narrative, it is to be observed, can only be received as an *ex parte* statement; no authorised exposition of the facts, on the part of the Roman authorities, having as yet, we believe, been made public in these countries.

MORTAR-VESSEL, a class of gun-boat for mounting sea-service mortars, and in some cases provided with steam-power. The mortars are usually of the largest calibre, 13-inch. To enable the mortar to be properly manœuvred, and to resist the recoil from the nearly perpendicular explosion of so great a piece of ordnance, the vessel has considerable breadth in proportion to her length. The mortar is slung amidships in a massive bed. The ancient form of mortar-vessel was the 'bomb-ketch,' convenient because of the length of deck without a mast. The present vessels originated during the Russian war, and were found serviceable at the bombardment of Sveaborg.

MORTGAGE, in English Law, is the temporary pledging of land in security of a debt; and as the land cannot be delivered into the creditor's hand, he acquires a hold over it by a deed called an indenture, or deed of mortgage. The ordinary form of a mortgage-deed resembles an absolute conveyance, but it contains a proviso that if the money borrowed is repaid within a certain time, then the mortgagees shall reconvey the land to the mortgagor or borrower. There is a mode of executing a mortgage without any deed, which is common with bankers and others who lend money. This consists in the borrower taking the title-deeds of his land to the banker, who keeps the deeds and lends money on the faith of them. This is called an equitable mortgage by deposit of title-deeds, but in point of fact is as good as any other mortgage. Mortgage deeds do not require in England to be registered, except in Middlesex and Yorkshire; and hence a person not unfrequently mortgages his property two or three times over, though the security is insufficient for all the debts. But in general this can only happen by the carelessness of one or other of the mortgagees, for the first mortgagee ought to have the title-deeds in his possession, and ought not to part with them, as they are his chief protection. A mortgagee can assign his mortgage security to another person, who thereupon stands in his shoes. If the money is not paid at the time originally appointed in the deed, then interest becomes due, and the deed is held as a security for both principal and interest. The remedy which the mortgagee has if the money is not paid at all, or not paid after due notice, is threefold. The mortgagee may exercise the power which the deed always contains to sell the estate and pay himself out of the proceeds. Or the mortgagee may enter into possession, and draw the rents and pay himself by instalments. Or he may foreclose the mortgage—i. e., he commences a suit in the Court of Chancery, the effect of which is to allow a short time to the mortgagor to pay the debt, failing which the court will order it to be sold to satisfy the debt. Another remedy is for the mortgagee to sue the mortgagor for the money in an ordinary action. All these remedies may be pursued at one and the same time. Sometimes when a second and third mortgage are given over the same estate, which is often done when the estate is large, compared with the money borrowed, it happens that the third mortgagee gets a prior title to the second mortgagee by buying up the first mortgage. On doing this, he can tack the third mortgage on to the first by the doctrine known as the tacking of mortgages. As a general rule, if nothing is said, the mortgagor or borrower pays all the costs of the mortgage transaction. Until the estate is sold, or the security foreclosed, the mortgagor has what is called the equity of redemption, i. e. he can at any time, on payment of the debt, compel the mortgagee to reconvey the property to him. Mortgages in England are not a first-class security, and hence trustees who are not specially authorised by their deed or will to invest in mortgage security do it at their risk, it being assumed that the only investment which is absolutely safe is government stock. In Scotland, mortgages are generally called bonds and dispositions in security, and form a higher and better security than in England, owing to there being a regular system of registration of deeds affecting land; and hence trustees are entitled to invest their funds there in mortgage security, which is considered as safe as government stock, and less liable to fluctuations of interest. In Scotland, there is no such practice as mortgaging lands with banks by merely depositing the title-deeds. See **BOND, DISPOSITION IN SECURITY.**

MORTIFICATION, in Scotch Law, is a term used to denote lands given for charitable or public uses. When lands are so given, they are in general formally conveyed to the trustees of the charity, to be held blench, or in feu. When mortifications are given in general to the poor, without naming particular trustees, they fall under the administration of the Court of Session. By the statute 1633, c. 6, it was declared unlawful to alter any mortifications, and the managers were rendered liable to be called to account for malversation. Any person entitled to the benefit of the fund can pursue actions of this kind.

MORTIFICATION, in Medicine. See **INFLAMMATION.**

MORTIS CAUSA DEED, in Scotch Law, is a deed which is made with a view to come into effect on the death of the maker. Since in Scotland land cannot be conveyed by will, as in England, it is necessary to execute an ordinary deed of conveyance, and to reserve the maker's liferent, and to keep it in his own possession until his death—i. e., to suspend its effect during the life of the grantor.

MORTISE AND TENON (Fr. *mortaise*, probably from Lat. *mordere*, to bite; *tenon*, from *tenir*, to hold), a form of joint in Carpentry. The tenon is a projection, generally rectangular in form, on

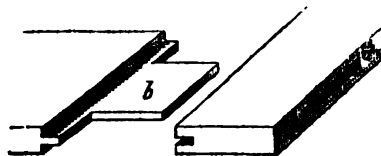

Mortise and Tenon :
a, mortise; b, tenon.

the end of a piece of wood, cut so as to fit exactly into a deep groove (called the mortise) cut in another piece, so that the two are united at a required angle. The framing of doors, shutters, and such pieces of joinery, is usually fitted together with mortise and tenon joints.

MORTMAIN, THE STATUTES OF (Fr. *mort*, dead, and *main*, hand). The object of the statutes of mortmain is to prevent priests and others from importuning a dying man to convey his land for charitable purposes. Hence, though a person can, up to the last hour of his life, if possessing sufficient knowledge of what he does, devise by will all his land to individuals absolutely, it is otherwise if he intend to give the land to trustees for a charitable purpose, as to build a church, or school, or hospital. The statute of mortmain, 9 Geo. II. c. 36 (1736), reciting that public mischief had greatly increased by many large and improvident dispositions made by languishing and dying persons to charitable uses, to take place after their deaths to the disinherison of their lawful heirs, enacted, that in future no lands or sums of money to be laid out in land should be given to any person or body, unless such gift or conveyance should be made or executed in presence of two witnesses twelve months before the death of the donor or grantor, and be enrolled in the Court of Chancery within six months after the execution. Therefore, a person on death-bed cannot in England give land, or money to buy land, for a charitable purpose. It can only be done in the life of the donor, at least twelve months before his death; and the property must be completely alienated, so that he has no further control over it. The deed must have a present operation, and must not reserve any

life-interest to the donor; it must be done at once and for ever. The policy of this statute has sometimes been questioned, and several well-known modes of evading the statute have been adopted from time to time. The act has been held to apply only to land locally situated in England; and hence, if the land is situated in Scotland, or the colonies, or abroad, a will conveying it for charitable purposes will receive effect. In Scotland, the mortmain act has no application; but the reason of this is, that the common law of Scotland contains a similar check on the alienation of land on death-bed, and which, in some respects, has a universal application. See DEATH-BED, INTESTACY.

MORTON, SAMUEL GEORGE, M.D., American physician and ethnologist, son of an Irish emigrant, was born in Philadelphia, January 26, 1799. He studied medicine in Philadelphia, Edinburgh, and Paris, and in 1824 settled in Philadelphia, where he contributed papers on physiology and craniology to scientific journals. In 1834, he visited the West Indies, and made observations on the development of races. In 1839, he was appointed Professor of Anatomy in the Pennsylvania Medical College, and published his great work, *Crania Americana*, based on his collection of 867 classified skulls. In 1844, he published *Crania Aegyptiaca*, based on the collection of George R. Gliddon, Esq.; and in 1849, his last work, *An Illustrated System of Human Anatomy, Special, General, and Microscopic*. He died at Philadelphia, May 15, 1861. M. may be regarded as the first American who endeavoured to place the doctrine of the original diversity of mankind on a scientific basis. See the Memoir of M. prefixed to Nott and Gliddon's *Types of Mankind* (Philadelphia, 1854), a work largely illustrated by selections from his unedited papers.

MORTON, FOURTH EARL OF (JAMES DOUGLAS), regent of Scotland, was the second son of Sir George Douglas of Pittendreich, and in 1553 succeeded, in right of his wife, Elizabeth, daughter of the third earl, to the title and estates of the earldom. He early favoured the cause of the Reformation, and in 1557 was one of the original Lords of the Congregation. Sworn a privy councillor in 1561, he was appointed Lord High Chancellor of Scotland, January 7, 1563. Having been one of the chief conspirators against Rizzio, the Italian secretary of Queen Mary, on his assassination, 9th March 1566, he fled with his associates to England, but, through the interest of the Earl of Bothwell, soon obtained his pardon from the queen. Though privy to the design for the murder of Darnley, on the marriage of the queen to Bothwell, he joined the confederacy of the nobles against her. He was present at Carberry Hill, when Bothwell parted from the queen, and after Mary's imprisonment in the Castle of Lochleven, he was restored to the office of High Chancellor, of which he had been deprived, and constituted Lord High Admiral of Scotland. On the death of the Earl of Mar, in October 1572, he was elected regent of the kingdom. His rapacity and avarice made him obnoxious to many of the nobles, and as the young king, James VI., desired to assume the reins of government, Morton resigned the regency in March 1578. Subsequently obtaining possession of the castle of Stirling, with the person of the king, he recovered his authority, but was accused of participating in the murder of Darnley, and being tried and condemned, was beheaded at Edinburgh, June 2, 1581.

MOSAIC, the art of producing artistic designs by setting small square pieces of stone or glass of

different colours, so as to give the effect of painting. Both the origin of the art, and also of its name, are buried in obscurity; it was, however, much practised by the ancient Romans, especially for ornamental pavements, specimens of which are almost always found whenever the remains of an old Roman villa are discovered. Under the Byzantine empire; it was also much used for the ornamentation of churches, in which it formed a large portion of the wall-decoration. It was re-introduced into Italy for the latter purpose about the middle of the 13th c. by Andrea Tati, who learned it of some Greek artists employed at Venice in decorating St Mark's. Since then it has been especially an Italian art, and to such wonderful perfection has it been brought, that most minute pictures are produced by it. Within the last few years, mosaics of surpassing beauty, both in design and material, have been produced by Russian artists in the Imperial Glass Manufactory of Russia; those shewn in the Russian department of the International Exhibition (1862) have probably never been surpassed. The pieces of glass of every shade of colour are technically called *smalts*; they are generally opaque, and are set in cement in the same manner as tiles or pavement. Some fine pieces of mosaic pavement have lately been produced in this country by Messrs Minton & Co. of Stoke-upon-Trent, and by Messrs Maw of Broseley, proving that the art only wants sufficient encouragement to obtain a high position. In Italy there are two very distinct varieties of mosaic work—i. e., the Florentine and the Roman; the former is entirely formed of pieces of stone or shell of the natural colours, and is limited in its application chiefly to floral and Arabesque designs. The latter is made of the glass *smalts* mentioned above, and has so wide an application, that most of the finest paintings of the best old masters have been copied in mosaic, and the pictures so taken form the almost imperishable decorations of the finest churches of Italy. The manufacture of the opaque glass or *smalts* for making the little square pieces called *tesserae*, of which the pictures are composed, is a very important one, and belongs to the papal government, it is carried on in the Vatican, where, of the various kinds of coloured glass, no less than 25,000 shades are produced. Great patience and skill are required in mosaic works.

MOSAIC GOLD. See TIN.

MO'SCOW, an important government of Central Russia, lies immediately south of the governments of Tver and Vladimir. Area, 12,552 square miles; pop. 1,590,808. The surface is level, with the exception of a tract in the south-west, which is elevated. It is watered by the Moskva and the Kliasma, while the Oka forms a portion of its southern boundary. The soil, principally clayey, with some sandy and stony tracts, is, on the whole, unfertile, and barely supplies local consumption. Few of the governments of Russia, however, equal that of M. in manufactures and general industry. It contains numerous cloth, silk, brocade, chintz, paper, and other factories. China-ware is manufactured from the clay dug up in the district of Gjelak. Many of its villages carry on special branches of manufacture, of which pins, glass beads, and small looking-glasses for Asia is one. White limestone is quarried, and is much used for building in the capital; yellow marble quarries occur on the banks of the Oka. Peat is extensively used as fuel in the factories. Among the places historically celebrated are the monastery of St Sergius, founded by one of the first Muscovite princes, and famous for its silver shrine, said to be the richest in the world; and the village of Borodino (q. v.).

MOSCOW—MOSELLE.

MOSCOW (Russ. *Moskva*), the ancient capital of Russia, and formerly the residence of the Czars, is situated in a highly-cultivated and fertile district on the Moskva, 400 miles south-east of St Petersburg, with which it is in direct communication by railway. Lat. 55° 40' N., long. 37° 33' E. Previously to its being burned in 1812, M. was perhaps the most irregularly built city in Europe, and that distinction to a great extent it still retains; for, as the main object in 1813 was to build speedily, the streets rose again on the old model, undulating and crooked, and consisting of alternating houses, the most varied in character and pretensions. The general view of the town, especially that obtained from an eminence on its southern side called the Sparrow Hills, is eminently original and picturesque. Its hundreds of churches and convents, surmounted by gilt or variously-coloured domes; its gardens and boulevards; and, above all, the high walls and crowded yet stately towers of the Kremlin or citadel, produce a most striking effect. The Kremlin, situated on the northern bank of the river, forms the centre of the town, and around it, with a radius of about a mile, is a line of boulevards, extending, however, only on the north side of the river. Outside of this line, and concentric with it, is another line of boulevards, with a radius of a mile and a half; while beyond all, and forming the girdle of the city, is the outer rampart, with a circumference of 26 English miles. The Kremlin comprises the principal buildings, as the Cathedral of the Assumption of the Virgin, founded in 1326, a small but gorgeously-decorated edifice; the Cathedral of the Archangel Michael, containing the tombs of all the Czars down to the time of Peter the Great, who changed the royal burial-place to St Petersburg; the Church of the Annunciation, the floor of which is paved with jaspers, agates, and carnelians of various shapes; the tower of Ivan Veliki, 200 feet in height, and surmounted by a magnificent gilded dome, from which, as from all the domes of M., rises the 'honourable cross'; the Czar Kolokol (king of bells), the greatest bell in the world; several palaces, and collections of ancient arms and other antiquities; the arsenal, surrounded by the splendid trophy of 850 cannons, taken from the French; and the senate. The walls of the Kremlin are surmounted by 18 towers, and pierced with 5 gates. In the town, the chief buildings are the cathedral of St Vassili, remarkable for its peculiar architecture; the Gostinnoi Dvor, or Bazaar; and the Exchanges. The university of M., the first in Russia, founded in 1753, is attended by 1800 students, contains a library of 89,000 volumes, museums of natural history, and a botanical garden. As intermediate educational establishments between the parish schools and the university, there are provided 4 high schools or gymnasia; special establishments are the technological, the agricultural, the oriental, 2 commercial, and 3 military schools. There are several learned societies in M., which is also the seat of a metropolitan, one of the three highest dignitaries of the Russian Church.

M. communicates by railway with St Petersburg and Nijni-Novgorod, and the construction of a third line to Sebastopol has been recently ceded to an English company. It is the seat of an extensive manufacturing and commercial industry; it imports largely, and carries on a considerable export trade, especially with Asia. Its trade is chiefly in hides, leather, oils, wool, grease, isinglass, wax, honey, feathers and down, potass, soap, iron, and copper; cotton from Asia, silks from Georgia, Persia, and Bokhara; Caucasian madder, home and Turkish tobacco, furs, tea, chemicals, and all the products of Russian manufacture, of which M. is the actual

centre. The annual imports amount to the value of 6,000,000 rubles (£937,000). The chief manufactures are woollen and worsted goods, which give employment to 181 factories, worked by 30,897 hands, and produce 17,286,000 rubles a year; cotton goods employ 387 establishments, 27,448 hands, and produce 12,330,000 rubles; silks and brocades employ 151 establishments, 12,821 hands, and produce 7,151,300 rubles; dyeing and printing employ 146 establishments, 21,685 hands, and produce 12,163,900 rubles. The other principal branches of manufacture are tanning and skin-dressing, iron, copper, and silver works, and chandleries. The total number of manufacturing and industrial establishments amounted, in 1861, to 1344, employing 106,000 workmen, and producing 66,000,000 rubles in manufactured goods. Pop. (1859) 386,370.

M. is of ancient origin for a Russian town. Its site was bought by Yuri Dolgoruki, in the 12th c., and a fortress built. In the 14th c., not only had it become the capital of the Russian religious world, owing to the residence there of the metropolitan, but it had also become the actual capital of Muscovy. In 1368, 1370, and 1372, it suffered from the inroads of the Lithuanians; in 1381, it was sacked by the Tartars. From 1415 to 1501, it was, on four separate occasions, partially destroyed by fires; and it was burned to the ground by Devlet-Girey, Khan of the Crimean Tartars, in 1571. It was taken by the Poles in 1610, and remained in their possession till their expulsion by the Russians under Minin and Pojarsky in 1612. In 1682, 1689, and 1698, it was the theatre of the revolts of the Strelitz. In 1812, from the 14th September till the 24th October, it was in the hands of the French, and it was on this occasion that, in setting fire to this their 'Holy City,' the inhabitants made such a noble sacrifice to national feeling.

MOSELLE, a frontier department in the north-east of France, formed out of ancient Lorraine, touches upon Bavaria, Rhenish Prussia, and the Netherlands. Area, 2329 square miles; pop. (1862), 446,457. It is watered by the Moselle and its tributaries; is richly wooded, and yields abundance of grain, fruits, and wine, though the last is of an inferior quality. Agriculture is in an advanced condition; roads are numerous, and the river-navigation important. Coal, iron, and building-stone are the most valuable minerals. There are also linen, woollen, leather, glass, papier-mâché, and other manufactures. M. is divided into the arrondissements of Metz, Briey, Thionville, and Sarreguemines. Chief town, Metz.

MOSELLE (Lat. *Mosella*), an affluent of the Rhine, rises in the Vosges Mountains, France, at an elevation of about 2260 feet above the level of the sea, not far from the sources of the Saône. Its course is north-westerly as far as Pont-à-Mousson, in the department of Meurthe, where it becomes navigable; then north to Thionville, near the French frontier; after which it proceeds, in a north-easterly direction (latterly, with many zigzag picturesque windings), through Luxemburg and Rhenish Prussia, joining the Rhine at Coblenz. On its way, it passes the towns of Remiremont, Epinal, Toul, Pont-à-Mousson, Metz, Thionville, and Treves. From Metz to Treves it flows through a broad valley, enclosed by rounded vine-bearing hills. Its entire length is upwards of 330 miles. Its principal tributaries are the Meurthe, the Seille, and the Sarre on the right; and the Orne, the Sure, and the Kyll on the left. The wines grown in the basin of the Moselle are noted for their lightness and their delicate aromatic flavour. The inferior kinds are liable to acidity.

MOSES (Heb. *Môshêh*; LXX. and Vulg. *Moysees*; ? Egypt. *Mes* or *Messou*; Copt. *Mo-ushe*, i.e., drawn out of the water), prophet and legislator of the Israelites, born about 1600 B.C. in Egypt (? Heliopolis), during the period of their hard bondage. His father was Amram, his mother Jochebed, both of the tribe of Levi. The tale of his birth and early education has, by tradition (Manetho, Philo, Josephus, Midrash, &c.), received a much more extraordinary legendary character than is found in Exodus; while the main features are, on the whole, the same in them all. And there is no reason to doubt the truthfulness of an account which shews us M., like many other supreme benefactors and 'suns' of mankind, struggling against an apparently adverse fate, nay for very life, from the instant of his birth. The well-known narrative, to which late traditions (contained in Philo, Josephus, the Fathers, &c.) have supplied questionable names and dates, is that M.'s mother, unable to hide the child—which was to have been drowned at its birth—longer than for the space of three months, put it into a basket of papyrus, and hid it among the Nile rushes, Miriam, his sister, watching it from afar. The king's daughter (Thermuthis, or Merris?), coming down to the river, observed the weeping child, and was so struck with its beauty, that she allowed Miriam to fetch a Hebrew nurse, Jochebed. Grown up, he was sent to the king's palace (Heliopolis) as the adopted son of the princess, and here seems to have enjoyed not only princely rank, but also a princely education. He is also said to have become a priest, under the name of Osarsiph or Tisithen, and to have been a mighty adept in all the sciences of 'Egypt, Assyria, and Chaldea;' to have led Egyptian armies against the Ethiopians, defeated them, and pursued them to their stronghold, Saba (Meroe); this place being delivered into his hands by Tharbis, the king's daughter, whom he subsequently married. The Bible contains nothing whatever about the time of his youth. He first reappears there as the avenger of a Hebrew slave, ill-treated by an Egyptian overseer. Threatened by the discovery of this bloody act, he escapes into Midian, where he is hospitably received by Jethro, the priest, and married his daughter, Zipporah. He stayed for many years in Midian, tending the flocks of his father-in-law. This most sudden transition from the brilliant and refined life of an Egyptian court, of which he had been brought up a prince, to the state of a poor, proscribed, exiled shepherd, together with the influences of the vast desert around him, must, in M.'s mind, have produced a singular revolution. The two names which he gave to his sons, strikingly express part of what filled his soul—a feeling of gratitude for his salvation from the avenging hand of justice, and the deep woe of his exile. The fate of his brethren went now to his heart with greater force than when he was a prince and near them. There rushed upon his memory the ancient traditions of his family, the promises of Jehovah to the mighty sheikhs, his forefathers; that they should become a great and a free nation, and possess the ancient heritage of Canaan; why should not he be the instrument to carry out this promise? The *Ehye asher Ehye* (I am that I am) appeared to him while his mind was occupied with such thoughts, and himself put the office upon his shoulders. A new king had succeeded in Egypt, his old enemies were either dead or had forgotten him, and M. returned to Egypt. Together with Aaron, his brother, the man of small energy but of fine tongue, he consulted about the first steps to be taken with the king as well as with their own people:—both of whom treated them at first with suspicion, nay, with contempt.

After ten distinct plagues (more or less akin to natural phenomena peculiar to Egypt), the last being the death of all the firstborn, Pharaoh consented to let his slaves go free, 'that they might serve their God.' M. very soon had occasion to prove that he was not only the God-inspired Liberator of his people, who, in the enthusiasm of the moment had braved the great king and his disciplined armies, but that he possessed all those rarer qualities which alone could enable a man to mould half-brutalised hordes of slaves into a great nation. Calmness, disinterestedness, patience, perseverance, meekness, coupled with keen energy, rapidity of action, unflinching courage—'wisdom in council and boldness in war'—constituted the immense power which he held over the hundreds of thousands who knew no law in their newly-acquired liberty, and who were apt to murmur and to rebel on any or no provocation. Nor were the hostile Bedouin tribes, whose territories the new emigrants approached, easily overcome with untrained warriors, such as formed the ranks of M.'s army. The jealousy of certain elders fostering seditions within, added to his unceasing vexations; and to fill the measure to overflowing indeed, his own brother Aaron, whom he had made his representative during his temporary absence on the Mount of Sinai, himself assisted in the fabrication of an idol. His sacred office as legislator he in reality first assumed in the third month after the Exodus, when, after many hard and trying marches and countermarches—from Goshen to Succoth (? Latopolis, the present Old Cairo); thence, by a *detour*, to Etham (? Ramlich), Pi-hachiroth (? Bedes), through the Red Sea, to the Desert of Shur (? Al-Djofar), Marah, Elim (Wadi Gharandel), Desert of Sin (Wadi Mocatteb, or Wadi Al-Sheikh), Dophka, Alus, Raphidim (near the Makkad Sidna Mouss)—made more trying by want of food and of water, by encounters with Pharaoh and the Amalekites, having arrived near the Mount of Sinai, he made the people encamp all round, and ascended the summit of the mountain by himself. On the incidents connected with the 'Revelation' made to the whole people, we need not dwell any more than on any other part of this well-known narrative. Suffice it to point out briefly, that the tendency of the whole Law was to make the Hebrews a people 'consecrated to the Lord,' 'a holy people, and a kingdom of priests,' i.e., a people of equals both before God and the Law. Three distinct parts compose this Mosaic Constitution. The doctrine with respect to God and His attributes; the 'Symbolical' Law, as the outward token of His Doctrine; and the Moral and Social Law. The Decalogue forms a kind of summary of all the three: the existence of Jehovah as the Absolute Being, the liberation of the people and the prohibition of Polytheism, and the Representation of the Divinity by visible images (i.—iii.). While the institution of the Sabbath, the symbol of creation and the Creator, forms the basis of all religious observances (iv.), the remaining part of the laws relate to the intercourse among the members of the human commonwealth; the gratitude of children is inculcated; murder, adultery, theft, false witness, coveting of others' goods are prohibited. The groundwork of these regulations had indeed been a special inheritance in the family of the Abrahamites from the earliest times; but the vicissitudes of fortune, the various migrations, and the enormous increase of this family, and its being mixed up for long years with the surrounding idolaters, had obliterated nearly all traces of the primeval purity of creed in the populace. The wisdom displayed even in the minor regulations of the Mosaic dispensation, with respect to their adaptation

to the peculiarity of the race, the climate, the political state of the country which they were to inhabit; in the hygienic regulations, and the rules which treat of the social and domestic relations; and, above all, the constantly-reiterated caution from mixing again with other nations, such as they found them in Canaan—and the neglect of which subsequently proved their ruin—is traced to a direct influence of Jehovah, generally indicated by the words, 'And God spake to Moses, speak unto the children of Israel.' An ample Ritual, in connection with the Tabernacle, or constantly-visible symbol of a Divine Dwelling; the allegory of an ever-new covenant represented by Sacrifices, Prayers, Purifications, kept the supreme task of being priests and a holy people unceasingly before the eyes of the nation. The tribe of Levi (q. v.), to a certain degree acted in this respect as permanent representatives; and not to Moses's sons, but to his brother Aaron and his descendants, was intrusted the office of High-priest.

When on the eve of entering into the promised land, the people broke out in open rebellion, and threatened, by a spontaneous return to the land of slavery, to undo the entire work of M.'s life. Convinced that they were not as yet fit to form a commonwealth of their own, the Liberator and Lawgiver had to postpone, for the long space of 40 years, the crowning act of his work; and, in fact, did not himself live to see them taking possession of the hallowed territory. How these years of nomadic journeying through the Desert (El-Tyh or Al-Tyh Beni-Israel) were spent, save in rearing up a new generation of a more manly and brave, as well as more 'civilised' stamp, we can only conjecture. All those who had left Egypt as men were doomed to die in the desert, either by a natural death, or by being suddenly 'cut off,' in consequence of their openly defying M., and through M., Jehovah. The apparent lack of incidents during this period has indeed furnished grounds for various speculations on this subject, and critics have tried to reduce it to a much shorter space, without, however, being able to prove their point. Even Goethe, with more ingenuity than knowledge of the subject, has endeavoured to prove the 'forty' to be a mythical round number, the real time being two years. The testimonies of the Hebrew prophets and historians, however, are perfectly unanimous on the subject (cf. Jos. v. 6; xiv. 10; Amos, ii. 10; v. 26; Ps. xcv. 10, &c.), and modern criticism has mostly endorsed the number as in keeping with the circumstances. On the first month of the fortieth year after the Exodus, we find M. at the head of an entirely new generation of Hebrews at Kadesh, in the Desert of Phoran or Zin. Here his sister Miriam died. Here also, for the first time, M., seeing the new generation as stubborn and 'hard-necked' as their fathers, is recorded to have despaired of the Divine Providence; and his disobedience to the letter of the command given to him, 'to speak to the rock,' is alleged as the reason 'that his bones too had to fall in the desert.' His brother Aaron died at Hor (near Petra, according to Josephus and St Jerome), whither the Israelites had gone next. Not long afterwards, M. once more had occasion to punish with relentless severity the idolatrous tendencies of the people (Baal Peor), thus shewing that age had had no power of making him relax his strong rule over the still half-savage and sensuous multitude. Having finally fixed the limits of the land to be conquered, and given the most explicit orders to Joshua, to Eliezer, and the chiefs of the ten tribes, respecting its division, he prepared the people for his own impending death. He recalled to their minds in the most impressive language, their mira-

culous liberation, and no less miraculous preservation in the desert. Their happiness—their life—was bound up, he told them, in the Divine Law, communicated through him by Jehovah. A recapitulation of its principal ordinances, with their several modifications and additions, and reiterated exhortations to piety and virtue, form the contents of his last speeches, which close with one of the grandest poetical hymns. The law was then handed over to the priests that they might instruct the people in it henceforth; Joshua was installed as successor (while his own sons sunk into the obscurity of ordinary Levites), and he blessed the whole people. He then ascended the Mount of Nebo, from whence he cast a first and last look upon the land towards which he had pined all his life, and on which his feet were never to tread. He died upon this mountain, 120 years old, in the full vigour of manhood, according to the Scriptures, 'and no man knew his burial-place up to this day'—so that neither his remains nor his tomb were desecrated by 'Divine honours' being superstitiously paid to them.

This is a summary of M.'s life as derived from biblical as well as non-biblical sources. The latter—except, perhaps the very doubtful traditions of Manetho—belong, whatever may be the date of the respective documents of the Pentateuch, to a much later age, and bear the air of tradition and legend, grown out of those very documents, so plainly on their face, that they are of about the same importance for historical purposes as the cycle of Midrash-sagas that have gathered around M., and which are reproduced variously in Moslem Legendaries. On his office as a 'prophet:'—what was the special nature of his revelations, how far the doctrines promulgated by him were traditional among the Abrahamites, and how much of his laws is due to Egyptian influences; whether part of them was first inaugurated by later generations and ascribed to him, or whether others were never carried out at all: on these and similar questions which have been abundantly raised, more especially in recent times, we must refer for fuller information to the special works on the subject. Some notices of the more important points will be found under GENESIS, JEWS, PENTATEUCH, DECALOGUE, &c. There seems, however, but one conclusion. The brief span of human history of which we have any knowledge, shews few, if any, men of M.'s towering grandeur—even with all the deductions that the most daring criticism has yet proposed.

MOSHEIM, JOHANN LORENZ VON, a distinguished church historian of Germany, was born at Lübeck on 9th October 1694, and studied at Kiel. In 1723, he became ordinary professor of theology at Helmstedt, from which he was removed in 1747 to a similar office in Göttingen. He died Chancellor of the University of Göttingen, 9th September 1755. His theological works are numerous, amongst which are a work on Bible morality, *Sittenlehre der Heiligen Schrift* (new ed., continued by J. P. Miller, 9 vols. Helmst. 1770—1778); and Discourses, *Heiligen Reden* (3 vols. Hamb. 1732, et seq.). But his most important contributions to theological literature are in the department of ecclesiastical history, in which his *Institutiones Historiæ Ecclesiasticæ* (Helmst. 1755) is familiar to every student as a work of great learning, fulness, and accuracy. It has been translated from the original very elegant Latin into English and other languages. The best English translation is that by Dr James Murdock (3 vols. New York, 1832), of which there are many reprints. Besides this, M. is the author of *Institutiones Historiæ Christianæ Majores* (Helmst. 1763); *De Rebus Christianorum ante Constantinum*

MOSOSAURUS—MOSQUE.

Commentarii (Helmst. 1753); *Dissertationes ad Hist. Ecclesiasticam pertinentes* (2 vols. new ed. Altona, 1767); and *Versuch einer unparteiischen Ketzergeschichte* (2 vols. Helmst. 1746—1748). His stand-point is that of liberal orthodoxy; yet he is essentially dogmatic, and pays more regard to the mere 'opinions' of men than to the character and genius shining through them; hence, his *Church History* is far inferior in point of richness, depth, and suggestiveness to that of Neander.

MOSOSAURUS (MEUSE LIZARD), a genus of huge marine lizards, whose remains occur in rocks of cretaceous age. Three species are known, one from the upper chalk of Sussex, a second from the cretaceous beds of North America, and the third from the Maestricht beds. This last (*M. Hofmanii*) was first known from a nearly perfect head dug out

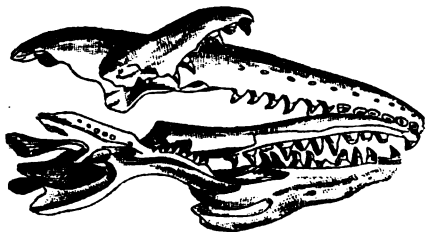

Head of Mososaurus.

of St Peter's Mount in 1780, and popularly called the great animal of Maestricht. Originally the property of Hofman, it was taken from him, in virtue of some clause in their charter, by the ecclesiastical authorities of Maestricht, who, in their turn, were compelled to give it up to the victorious French army, and by them it was removed to Paris. It is said that the French cannoniers, when preparing for

the siege, had instructions not to point the artillery towards that part of the town in which the precious specimen was deposited. This head is four feet in length, and the animal to which it belonged is estimated to have been 25 feet long. The total number of the vertebrae was 133; they were concave in front and convex behind, and were fitted to each other by a ball-and-socket joint, admitting of easy and universal flexion; the sacrum seems to have been wanting. The limbs were developed into four large paddles, and these with the comparatively short and strong tail, the bones of which were constructed to give great muscular power, enabled the animal to move quickly through the water in pursuit of its prey. The jaws were furnished with a single row of strong conical teeth. Cuvier first shewed the affinities of the animal. It is most nearly related to the modern monitor, but differs from all modern lizards in its peculiar adaptations for an ocean life, and in its great size. The largest living lacertian is only 5 feet in length, and of this a large proportion is made up by the tail; the *M.*, with its short tail, is estimated to have been at least 25 feet long.

MOSQUE, a Mohammedan house of prayer. The word is derived, through the Italian *moschea*, from the Arabic *mesjid*, a place of prayer. The form of the oldest mosques (at Jerusalem and Cairo) is evidently derived from that of the Christian Basilica, the narthex being the origin of the court, with its arcade, and the eastern apses representing the principal buildings of the mosque facing Mecca. The original forms became, however, entirely obliterated in the progress of Mohammedan architecture, and the mosques, with their arcaded courts, gateways, domes, and minarets, became the most characteristic edifices of Saracenic art. Wherever the Mohammedan faith prevailed, from Spain to India, beautiful examples of these buildings exist. They vary considerably in style in

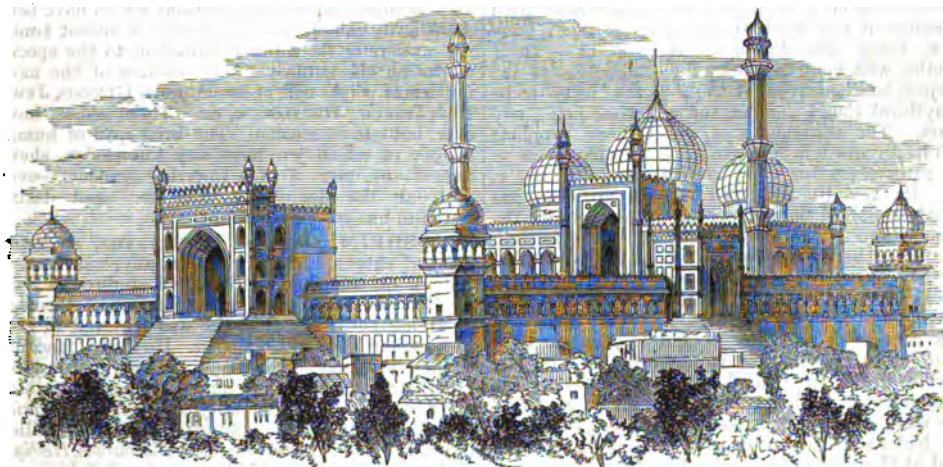

Great Mosque at Delhi, from the North-east.—From Fergusson's *Hand-Book of Architecture*.

different countries, the Saracens generally borrowing much from the architecture of the various nations who adopted their faith. In India, the mosques have many features in common with the temples of the Jains, while in Turkey they resemble the Byzantine architecture of Constantinople. Everywhere the dome is one of the leading and most beautiful features of the mosques, which commonly consist of porticoes surrounding an open square, in the centre of which is a tank or fountain for ablution. Ara-

besques and sentences of the Koran inscribed upon the walls, which are generally white-washed, and never bear any device representing a living thing, are the only ornaments of the interior. The floor is generally covered with mats or carpets; there are no seats. In the south-east is a kind of pulpit (Mimbar) for the Imám; and in the direction in which Mecca lies (the Kibleh), there is a niche (Mehrab) towards which the faithful are required to look when they pray. Opposite the pulpit, there

is generally a platform (Dikkeh), surrounded by a parapet, with a desk bearing the Koran, from which portions are read to the congregation. The five daily prayers (see MOHAMMEDANISM), which are generally said at home—especially by the better classes—on week-days, are said in the mosque by the whole congregation on Fridays, the days of Al-Gumah, or the Assembly, the Moslem Sundays, together with some additional prayers, and at times a sermon is super-added to the service. It is not customary for women to visit the mosques, and if they do, they are separated from the male worshippers. The utmost solemnity and decorum are preserved during the service, although in the hours of the afternoon (when there is no worship) people are seen lounging, chatting, even engaged in their trade, in the interior of the sacred building. On entering the mosque, the Moslem takes off his shoes, carries them in his left hand, sole to sole, and putting his right foot first over the threshold, he then performs the necessary ablutions, and finishes by putting his shoes and any arms he may have with him upon the matting before him. The congregation generally arrange themselves in rows parallel to that side of the mosque in which is the niche, and facing that side. The chief officer of a mosque is the Nazir, under whom are two Imáms, a kind of religious official, in no way to be compared with what we understand by a clergyman of a creed, but who performs a certain number of religious rites, as long as the Nazir allows him to do so, and who, being very badly remunerated, generally has to find some other occupation besides. There are further many persons attached to a mosque in a lower capacity, as Mueddins (q. v.), Bowwabs (door-keepers), &c., all of whom are paid, not by contributions levied upon the people, but from the funds of the mosque itself. The revenues of mosques are derived from lands. With many of the larger mosques, there are schools, academies (Medressehs), and hospitals connected, and public kitchens, in which food is prepared for the poor.

MOSQUITO (Span. *gnat*), a name very generally given to the most troublesome species of *Culex*, and allied genera. See GNAT. The name M. is given, according to Humboldt, in some parts of tropical South America to species of *Simulia*, which are active during the day, whilst species of *Culex*, active chiefly during the night, are called *Zancudoos*; but these latter are the mosquitoes of other countries generally. The name was probably first used in the West Indies, where it particularly designates a species (*C. Mosquito*) very similar to the common gnat, but not quite so large, with black proboscis, and marked with silvery white on the head, thorax, and abdomen. It abounds in the warm parts of America, especially in marshy districts and in the vicinity of stagnant waters. It and similar species extend even to very northern regions, appearing during the heat of summer in prodigious swarms. Similar species are found also in similar situations in almost all parts of the world, and are almost as great a pest in Lapland as within the tropics. The bite which they inflict is painful, and their incessant sharp buzzing prevents sleep. In India and other countries, beds are provided with *mosquito curtains* of gauze, which are closely drawn, to protect the occupant, while the natives who cannot avail themselves of such protection, smear their bodies with oil. So numerous are mosquitoes in some localities in South America, that the wretched inhabitants sleep with their bodies covered over with sand three or four inches deep, the head only being left out, which they cover with a handkerchief; and travellers have been obliged to have recourse to the same expedient. Even thick clothes afford at best a very partial protection from mosquitoes being readily penetrated by the

proboscis. Mosquitoes are readily attracted to a lamp, and perish in its flame; but where they are numerous, a lamp only causes additional swarms to congregate to its neighbourhood until it is extinguished, as is often very soon the case, by their dead bodies.

MOSQUITO COAST, MOSQUITO TERRITORY, or MOSQUITIA, formerly a native kingdom, under the protectorate of Britain, lies on the east coast of Central America, having Honduras on the north, Nicaragua on the west, and Costa Rica on the south. The area is estimated at 15,000 English square miles, but as 20,000 miles of contested territory lie between it, and Honduras and Nicaragua, its extent would be more correctly given at 25,000 square miles. The coast is low, with many bays and lagunes, and possesses a number of good harbours. The two principal rivers are the Rio de Segovia (which rises within 35 miles of the Pacific Ocean), and the Rio Escondido, both of which flow into the Caribbean Sea. The climate is rainy, and the temperature, considering the latitude, is cool and equal, the thermometer seldom rising above 82° or falling below 71°. On the whole, this territory is one of the most healthy parts of Central America. Ague is not unusually common, epidemics are exceedingly rare, and white people who do not recklessly expose themselves enjoy the best health. The swampy grounds are generally covered with dense forests, in which dye-woods and timber-trees of great value abound. Rice, maize, manioc, and other tropical plants, are cultivated. The country abounds in deer of various kinds, half-wild horses and oxen roam in the savannahs, which are covered with tall grass, and alligators and serpents are common. The chief exports are mahogany, cocoa, ginger, sarsaparilla, and tortoise-shell, but the whole trade is inconsiderable. The inhabitants are of various races, the greater portion being aboriginal, but many are a cross between the native Indians and runaway negroes; they do not number more than from 10,000 to 15,000 in all. Their chief occupations are hunting and fishing, but a little agriculture and cattle breeding are also practised.

The M. C. was discovered in 1502 by Columbus, and though never conquered, was claimed by Spain till about 1660, when the king, with consent of his people, placed himself under the protection of Britain. British colonists at different times attempted to found settlements in various parts of the country, but from various causes were soon after compelled to withdraw. Of late years they have met with more success. The foothold Britain thus obtained in Central America was viewed with great jealousy by the United States, who left no means untried to effect her expulsion. During the British protectorate a sort of constitutional government was established, consisting of a legislative body, and regular jury courts. In July 1850, the United States and Great Britain bound themselves by the Clayton-Bulwer treaty 'not to occupy, fortify, colonise, or exercise dominion over the M. C., or any part of Central America;' and in November 1859, Britain ceded the protectorate of M. C. along with the Bay Islands to Honduras, a proceeding which gave rise to much discontent among the natives of the coast, and a complete rebellion of the islanders. However, by a subsequent treaty, concluded 26th January 1860, the whole territory was finally handed over to Nicaragua.

MOSESSES (*Musc*), an order of scotyledonous plants, consisting of mere cellular tissue without vessels, and distinguished from *Hepatica* (q. v.), the order with which they are most nearly allied, by having always a leafy stem, and an operculated

capsule or urn (*sporangium* or *theca*), which opens at the top, and is filled with spores arranged around a central column (*columella*). The capsule is covered by a hood (*calyptra*); and when it is ripe, and has thrown off the calyptra and operculum, exhibits around its mouth a single or double row of rigid processes, few or numerous, but always either four or a multiple of four, collectively called the *peristome*. These reproductive organs are viewed by many botanists as female flowers or *pistillidia*; whilst reproductive organs of another kind, sometimes found on the same plant, but more generally on distinct plants, are regarded as male flowers or *antheridia*. These are minute cylindrical sacs, occurring in the axils of the leaves, or collected into a head enclosed by variously modified leaves at the summit of the stem, and finally bursting and discharging a great number of spherical or oval vesicles, through the transparent walls of which, when moistened with water, filaments (*spermatozoids*) coiled up within them may be seen wheeling rapidly round and round. As the sacs merely discharge these vesicles and perish, it is

protecting the roots of many plants from cold and from drought, and afford harbour to multitudes of insects. Some of them supply food for cattle, particularly for the reindeer, when nothing better is to be obtained, and a wretched kind of bread is even made by some of the dwellers in the Arctic regions, of species of *Sphagnum*. Some are astringent and diuretic, but their medicinal virtues are unimportant. Among the other principal uses to which they are applied by man are the packing of things liable to be broken, the littering of cattle, the covering of garden plants in winter, and the stuffing of the open space in roofs to moderate the heat of attic rooms in summer and their cold in winter—perhaps the most important use to which they are ever put, at least in Britain, and to which, as the benefit is great and easily attained, it is wonderful that they are not much more frequently applied. The abundance of *M.* in meadows and pastures is disagreeable to farmers. The best remedies are proper drainage, the application of lime, and the liberal use of other manures, by which the soil may be enriched, so that better plants may grow with sufficient luxuriance, upon which the *M.* are choked and disappear.

Several thousand species of *M.* are known. Many of the *M.* are very beautiful, and their capsules and other organs are interesting objects of study, even with an ordinary magnifying-glass.

MOSTAR, a town of European Turkey, capital of Herzegovina (q. v.), on the Nerenta, 45 miles south-west of Bosna-Seral. It is surrounded by embattled walls, contains ten mosques, a Greek church, and a famous Roman bridge of one arch, 95 feet in span. Silk, grapes, and wine are produced, and knife-blades and weapons are manufactured. *M.* is also a place of considerable trade. Pop. 10,000.

MÓ'SUL, a town of Asiatic Turkey, in the province of Al-Jezirah (ancient Mesopotamia), is situated on the right bank of the Tigris, opposite the ruins of ancient Nineveh (q. v.), and 180 miles up the river from Bagdad. It is surrounded by walls, and is still in a more flourishing condition than most Turkish towns, on account of its caravan-trade with Diarbekir, Bagdad, and Aleppo, though its prosperity is nothing to what it formerly was. During the Middle Ages it supplied all Europe with its rich manufactures—*muslins*, according to Marco Polo, got their name from this town; now, on the contrary, the bazaars of *M.* are filled with the manufactures of the West. The principal causes of its diminished importance are the rise of Abushehr (q. v.) as an emporium of trade, and the opening up of the new sea-route to India by the Isthmus of Suez. *M.* is the seat of a Jacobite patriarch, and was formerly the great metropolis of all the Mesopotamian Christians (the Nestorians, the United Chaldeans, the Jacobites, &c.), but war, pestilence, famine, Mohammedan proselytism, oppression, and incessant anarchy, have greatly reduced their numbers. The population is variously estimated at from 18,000 to 40,000, of whom perhaps about a fourth are Christians. There are also about 1500 Jews; the rest are Mohammedans (Arabs, Kurds, and Turks).

MOTACILLIDÆ. See WAGTAIL.

MOTETT, a name applied to two different forms of musical composition—1. A sacred cantata, consisting of several unconnected movements, as a solo, trio, chorus, fugue, &c.; 2. A choral composition, generally also of a sacred character, beginning with an introduction in the form of a song, perhaps with figurative accompaniment; after which follow several fugue subjects, with their expositions, the whole ending either with the exposition of the last subject, a repetition of the introduction, or a special final subject. A motett differs in this respect from



Moss.

(From Stark's Mosses.)

1, perfect plant; a, branches clothed with leaves; b, seta, or footstalk; c, capsule; d, operculum, or lid. 2, branch producing stellate heads, having masses of 'male' flowers, and filaments in centre. 3, spore of moss, germinating. 4, spore of moss in a more advanced state.

supposed that the spermatozoids contained in them may effect the fertilisation of the spore-producing capsules; but this wants confirmation, and their particular office as reproductive organs is not yet fully ascertained.—None of the *M.* are large plants, many are very small. Many have elongated stems, often branching; others have the stem scarcely developed, so that they seem to consist of a mere tuft of leaves. They are generally social in their manner of growth. They are among the first plants which begin to clothe the surface of rocks, sands, trunks of trees, &c., adapting inorganic matter for the support of higher kinds of vegetation. They love moisture, and are generally more abundant in cold and temperate than in hot climates. They struggle for existence on the utmost limits of vegetation in the polar regions and on mountain-tops. They dry up and appear as dead in a very dry state of the atmosphere, but revive when moisture returns. Some of them grow in bogs, which they gradually fill up and consolidate. They are of great use in

a double or triple fugue, that the subjects never appear simultaneously, but are introduced one after the other. In one form of the motett, the successive phrases of an entire chorale are treated as so many fugal subjects.

MOTH, the popular name of all the insects included in the section *Nocturna* of the order *Lepidoptera* (q. v.). They formed the genus *Phalena* of Linnæus, but are now distributed into many genera and families, the species being extremely numerous. Among them are the very largest *Lepidoptera*, and also the smallest. They are distinguished from Hawk-moths, and from most of the butterflies, by their bristle-shaped antennæ, tapering from base to apex. The antennæ are frequently feathered or pectinated, especially in the males. The proboscis is generally similar to that of butterflies; but there are some groups of moths in which it is merely rudimentary, and these are supposed to take no food after they pass from the larva state. The thorax is generally shorter and more robust than in butterflies; the tibiae of the legs often bear a kind of spur; the wings are held either in a horizontal or in an inclined position when at rest; or, as in many of the smaller moths, are wrapped round the body. The two wings of the same side are generally hooked together in repose by means of bristles on the margin. The females of a few species are wingless.—Moths are generally nocturnal, although to this rule there are a few exceptions. They often exhibit great richness and beauty of colours, although in brightness of colour they are not generally equal to butterflies. Their food is similar to that of butterflies.—They lay great numbers of eggs, which exhibit varieties of form and colour as great as those of the insects themselves. Their caterpillars are more widely various in form and characters than those of butterflies; differing from each other in the number of their legs, and in horns, protuberances, caudal appendages, hairy covering, &c. Some are social both in the larva and chrysalis state; forming, on



Loakey Moth :

A, the belt of eggs; B, the caterpillar; C, the pupa in its cocoon; D, the moth.

their entering the latter state, very curious nests. The chrysalis of a moth is never angular nor furnished with protuberances, and is generally enveloped in a silken cocoon, pretty close and compact; although some moth chrysalids are found in a mere space filled with threads which cross each other in various directions. Silk-worm (q. v.) moths are among the insects most useful to man; but moths in general are regarded by him as injurious, the larvæ of many feeding on leaves of various kinds, and often destroying valuable crops; and

the larvæ of some small species proving very destructive to clothes, books, &c. The largest and most splendid moths inhabit tropical countries. Some of the most interesting and important kinds of moth are noticed in separate articles. A complete account of the *British Moths* (2 vols.), accompanied by accurately coloured plates, is published by W. and R. Chambers.

MOTHER CAREY'S CHICKEN, a name familiarly given by sailors to the Storm Petrel and other small oceanic species of Petrel (q. v.).—The



Mother Carey's Chicken, or Storm Petrel (*Procellaria pelagica*).

name MOTHER CAREY'S GOOSE is, in like manner, given to the Great Black Petrel or Gigantic Fulmar (*Procellaria gigantea*) of the Pacific Ocean; a bird of about three feet in entire length, with very long wings, and blackish gray plumage, a ravenous feeder on dead whales and all other animal garbage, and which also kills and preys upon other sea-birds.

MOTHER OF PEARL, the shells of the large bivalve mollusc *Meleagrina margaritifera*, which also produces the precious pearls. See PEARL. These shells are collected in vast numbers in the tropical seas, chiefly on the coasts of Ceylon, Manila, Cuba, Panama, and the South Sea Islands. Those from Panama are small and thick, and are known in commerce as 'bullock' shells; those from Manila are finest in quality, often as much as a foot in diameter, round, and flat. There are two varieties—the white or silver-lipped, and the black-lipped. So enormous is the trade in these shells, that the imports of this country alone amount to 3000 tons per annum, the value of which is nearly £100,000. Although large quantities of these shells are consumed in inlaying fancy wood-work, papier mâché, and in making knife-handles and other small ornamental objects, by far the greater portion is required for the manufacture of buttons, which are chiefly made in Birmingham.

MOTHER WATER, MOTHER LYE. See LYE.

MOTHERWELL, WILLIAM, a Scottish poet and antiquary, was born in Glasgow, 13th October 1797, and educated chiefly at the grammar-school of Paisley, where, in his fifteenth year, he entered the office of the sheriff-clerk. At the age of twenty-one, he was appointed sheriff-clerk depute of the county of Renfrew. In the following year he published his first work, the *Harp of Renfrewshire*, containing biographical notices of the poets of that district, from the 16th to the 19th century. This work was but the prelude to one of far greater importance—his *Minstrelsy, Ancient and Modern*,

which appeared at Glasgow in 1827. In 1828, he commenced the *Paisley Magazine*, in which some of his finest original pieces first saw the light, and in the same year accepted the editorship of the *Paisley Advertiser*, a Conservative journal. In 1830, he became editor of the *Glasgow Courier*. He died in that city, November 1, 1835, at the early age of 38. M. displays in his best moods (but *only* then, for his inspiration was not constant, and at times he pours forth a stream of very mediocre sentimentalities) a rich, beautiful, and strong imagination, great warmth and tenderness of feeling, and a thorough knowledge of the language of a poet. His *Jeanie Morison* is unsurpassed for the mingled pathos and picturesque beauty of its reminiscences of boyish love; *The Sword-Chant of Thorstein Raudis* is perhaps the most heroic rune in the English tongue; and the little piece beginning, 'My heid is like to rend, Willie,' has seldom been read without tears. An enlarged edition of his poetical remains, accompanied by a memoir of his life, was published in London in 1849.

MOTHERWORT (*Leonurus Cardiaca*), a plant of the natural order *Labiatae*, found about hedges and in waste places in Europe, and now abundantly naturalised in some parts of North America. It is not very common in Britain, and probably has been introduced. It is perennial, has a branched stem



Motherwort (*Leonurus Cardiaca*).

about three feet high, stalked leaves, the lower ones 3-lobed, and crowded whorls of reddish-white flowers. The calyx has five pungent spreading teeth. The upper lip of the corolla is shaggy on the upper side, the lower lip trifid. The anthers are sprinkled with shining dots. The plant was formerly in much use as a domestic pectoral medicine, but is now comparatively little employed. It has a strong, but not agreeable smell.—Other species of the same genus are found in Europe and the north of Asia.

MOTION, LAWS OF, are the fundamental principles connecting force and motion in the physical universe; and are obviously to be derived from *experiment* alone, since intuitive reasoning cannot possibly give us any information as to what may or may not be a law of nature. Though these laws are derived from experiment, it cannot be said that we have any very *direct* experimental proofs of their

truth—our most satisfactory verifications of them are derived from the exact accordance of the results of calculation with those of observation in the case of such gigantic combinations of mutually influencing bodies as that of the solar system; and it is by such proofs that they must be considered to have been finally established.

They seem first to have been given systematically and completely by Newton, at the opening of the *Principia*; but the first two were known to Galileo, and some of the many forms of a *part* of the third were known to Hooke, Huyghens, Wren, and others. We shall give them here in order, with a few brief comments, shewing their *necessity* and their *use*.

First, then, we naturally inquire, what matter would do if left to itself; and, by considering cases in which less and less external force is applied to a body, we are led to the statement called the *first law of motion*:

1. *Every body continues in its state of rest or of uniform motion in a straight line, except in so far as it may be compelled by impressed forces to change that state.*

This expresses simply the *inertia* of matter—i. e., a body cannot alter its *state* of rest or motion; for any such alteration external *force* is required. Hence the definition of Force (q. v.), as that which changes or tends to change a body's state of rest or motion.

Now, how does the change of state depend on the force which produces it? This is obviously a new question, to be resolved by experiment; and the answer is the *second law of motion*:

2. *Change of motion is proportional to the impressed force, and takes place in the direction of the straight line in which the force acts.*

Newton's silence is as expressive as his speech. Nothing is here said about the previous motion of the body, or about the number of forces which may be at work simultaneously. Hence, a force produces its full effect in the form of change of motion, whether it act singly, or be associated with others; and whatever, moreover, be the original motion of the body to which it is applied. Hence, there is no such thing as equilibrium of *forces*; every force produces motion—and what we call equilibrium is *not* the balancing of forces, but the balancing of their *effects*. Hence, the absurdity of attempting to found the science of Statics on any other basis than is to be derived from the second law of motion; which, in fact, leads us at once (by the *Parallelogram of Velocities*, which is a purely geometrical conception) to the *Parallelogram of Forces*, and thence, with the help of the third law, to the whole subject of Statics. The second law also supplies the means of measuring *force* and *mass*; and of solving any problem whatever concerning the motion of one particle.

But more is required before we can study the motion of a *system* of particles—as a rigid body, or a liquid, for instance; or a system of connected bodies. Here there are mutual actions and reactions of the nature of pressure or of transference of *energy* (see FORCE) between the parts—and these are regulated by the *third law of motion*:

3. *To every action there is always an equal and contrary reaction: or, the mutual actions of any two bodies are always equal and oppositely directed in the same straight line.*

Thus, the mutual pressure between two bodies has equal, but *opposite*, values for the two. The tension of a rope is the same throughout, and tends as much to pull *back* the horse at one end as to pull *forward* the canal-boat at the other. The earth exerts as much attractive force on the sun as the sun exerts

on the earth—and the same law applies to the other attractive and repulsive forces, as those of electricity and magnetism.

But Newton goes much further than this; he shews, in fact, that action and reaction (subject to the third law) may consist in *work done by a force*, instead of the mere force or pressure itself. From this form of the third law we derive at once the principle of Virtual Velocities (q. v.), which in its application to machines is familiar as '*What is gained in power is lost in speed.*' But we also derive the grand principle of the indestructibility of work or energy: at all events in the case of the ordinary mechanical forces—and this must be regarded as one of the grandest discoveries which science owes to Newton. It is true that he merely *mentions* it, and then abruptly passes to another subject; yet we can hardly exaggerate the value of this single remark. Experimenters, mainly Davy and Joule, have since shewn that all the physical energies, as heat, light, electricity, &c., are subject in their transformations to the third law of motion, and thus the system constructed by Newton for ordinary dynamical purposes, is now found to rule the most mysterious of the affections of matter. For a development of this, see our article on FORCE.

MOTION, ANIMAL. Motion or progression is that function by which an animal is able to transport itself from place to place. It is enjoyed exclusively by animals, there being nothing strictly analogous to it in the vegetable kingdom. The organs employed in locomotion are of two kinds, the *passive* and the *active*; the former including all those textures which form the skeleton, and by which its segments are united, as fibrous and areolar tissue, synovial membrane, cartilage, fibro-cartilage, and bone, while the latter includes the muscles with the nerves, which convey to them the mandates of the will.

Before proceeding to notice the different modes of progression of men and animals, it may be expedient to say a few words on *standing*, or the natural attitude of an animal. This attitude depends upon the form and functions of the limbs. Most of the terrestrial mammals and the reptiles (excepting the serpents), both of which use four feet in walking, have the backbone (the vertebral column) nearly horizontal (being only slightly concave downwards), and resting, at the same time, both on the fore and hind legs. Birds, whose anterior extremities are intended for flight, stand upon the posterior limbs only, although in their case, too, the backbone is generally nearly horizontal when the animal is at rest. Man alone stands erect with his head supported on the summit of the nearly vertical vertebral column. Some other animals (monkeys, hares, kangaroos, &c.) can rise more or less erect, but in their case the attitude is obviously not the natural one.

In standing, it is requisite that the limbs should be so arranged that the centre of gravity may fall within the space included by the feet. If the centre of gravity does not fall within this space, the animal cannot stand, but must fall to that side to which the centre of gravity inclines. On this account certain aquatic birds (the albatross, for example), which have their feet placed very far back, cannot use them for walking. If an animal has four legs, it is not necessary that they should have the broad base, which is essential in bipeds. We see that most quadrupeds have comparatively small feet, while birds are furnished with long toes, which, when spread out, form large bases of support. Moreover, the flexor muscles of the toes are so arranged that the weight of the body causes them

to contract firmly, and hence birds are enabled to sleep standing without any effort.

Walking is the most common form of progression. When it is accomplished by two legs only, as in man, the body is inclined forwards, carrying the centre of gravity in that direction; and while one leg supports the body, the other is thrown forward to prevent it from falling, and to sustain it in turn. Hence, walking has been defined to be a continual falling forwards, interrupted by the projection of the leg. Those writers who have especially studied the theory of walking (Borelli, the brothers Weber, and Bishop) have divided the time of a step into two portions—i. e., that in which one leg only rests on the ground, and that in which both legs rest on the ground. The period in which both feet are on the ground is shorter than that in which the body is supported by one leg only. During the time the body is supported by one leg, the other leg swings from behind forwards, without the active intervention of its muscles, but by the mere force of gravity—in short, like the pendulum of a clock. When this leg is again placed on the ground, the first interval ends, and the other—i. e., that in which the body is supported by both legs—begins, and of course terminates with the raising of the other leg. The time that the body is supported by both legs diminishes as the velocity increases, and vanishes as the walk merges into a run; while, on the other hand, it attains its maximum in extremely slow walking, when it is found by experiment to amount to half the time in which only one leg supports the body. The greatest velocity of walking is attained when the time of a step is equal to half the duration of the motion of the swinging leg, and the velocity in walking of any given person depends on the time taken in making each step, and on the length of the steps; and both of these are, again, dependent on the height at which the centre of gravity of the body or the heads of the thigh-bones are carried above the ground; for as the height of the latter diminishes, the length of the step is increased, while its time is diminished, and *vice versa*. The best walkers are incapable of acquiring a speed of more than seven miles an hour; and even this speed cannot be kept up for any length of time. The walking of quadrupeds is a similar process to that of bipeds, except that the body always rests on at least two legs. The limbs are raised in a determinate order, and usually in such a manner that the hind-leg of one side succeeds the fore-leg of the opposite side.

Running consists of the same succession of motions as walking; but these motions are so accelerated, that there is a period between two steps when the body is not supported on either leg; and this constitutes the essential difference between the two paces. It requires a far greater expenditure of muscular force than walking, and cannot be long maintained without considerable exhaustion. First-rate runners can accomplish a mile in a few seconds under four minutes and a half, and ten miles in an hour. (Levett in a match with Frost, which came off on the 22d of March 1852, at Copenhagen Fields, ran 10 miles 250 yards, in 52' 53", and Deerfoot ran 11 miles 740 yards, at Brompton, in an hour.) In quadrupeds there are various paces besides walking, which are known as trotting, cantering, and galloping; and as every one is familiar with the ordinary paces of the horse, we shall take that animal as our illustration. In *trotting*, the horse moves its legs in pairs diagonally. Thus, if the left fore and right hind leg be raised, and advanced first, the right fore and left hind leg will be raised the instant the others reach the ground. In fact, in trotting, the first pair are actually raised before the

other legs reach the ground, so that there is a minute interval when all four legs are raised above the ground at the same time. The velocity acquired by moving the legs in pairs (as in running), instead of consecutively (as in walking), depends upon the circumstance, that in trotting each leg rests on the ground during a short time and swings during a long time, while in walking the swing occupies a short period, and the rest a comparatively long one. In *cantering*, the animal, after advancing the two fore-legs one after the other, brings forward the two hind-legs simultaneously; and when this movement is greatly urged, the fore-legs are raised together, as well as the hind-legs, and the pace then becomes the *gallop*.

In *leaping*, the horse raises the fore-legs from the ground, and propels the body upwards and forwards by the hind-legs alone. This act in the horse is, however, mainly the result of education, and those animals that leap or spring upon their prey (as the members of the cat tribe) crouch before leaping, in order to throw the body forward with the greatest possible force, by first bending all the limbs, and then suddenly extending them. As the hind-legs are, however, the essential agents in leaping, we observe that in those animals whose natural mode of progression is leaping—as frogs, hares, kangaroos, &c.—the hind-legs are much longer, and more muscular than the fore-legs. Leaping is a common mode of progression in many short-legged birds (blackbirds, thrushes, finches, sparrows, &c.), in which the step would be extremely short if performed by moving the legs alternately. There is also a large number of insects, such as grasshoppers, fleas, &c., whose ordinary mode of progression is by leaps; and it is in this class of animals that the leaping power is developed to its greatest extent. The common flea, for example, can leap 200 times its own length. While fleas, locusts, and grasshoppers leap by means of their long and strong hind-legs; other insects, as the *Poduridae*, or spring-tails, possess a forked tail, which they bend beneath the body, and which, when suddenly extended, propels them to a considerable distance.

Climbing, is merely walking on an inclined or vertical surface. It is usually accomplished by means of sharp nails or claws, as in the cat-tribe, the lizards, &c. In many birds, as the woodpeckers, parrots, &c., the toes are arranged in two divisions, so as to grasp branches in the manner of a hand. Bears and sloths use their arms for climbing, while monkeys use their hands, and in some cases their tails. It is only in a very few cases, as in the sloth, that this is the ordinary method of progression.

The act of *flying* in the bird is accomplished by the simultaneous action of the two anterior limbs, the wings, much as leaping is by that of the two posterior limbs. See *FLYING*; *BIRDS*. Many attempts have been made to estimate the velocity at which different birds can fly. Whether, as has been stated, the eider-duck can fly 90, and the hawk 150 miles in an hour, is very questionable; but it has been ascertained that carrier-pigeons can accomplish from 33 to 42 miles in that time.

The bats are the only mammals which possess a true power of flight. For a description of their organs and mode of flight, we must refer to the article *BAT*, where will also be found a notice of the false claims of some other mammals, as the so-called flying-squirrel, to the possession of true flight. Similarly, the actions of the flying lizard and of the flying-fish are not true flight. In no class of animals is the mechanism of flight so perfect as in insects. The dragon-fly, for example, can outstrip the swallow; and can do more in the air than any bird, as it can fly backwards and sidelong,

to right or left, as well as forwards without turning. The wings of insects, of which there may be either one or two pair, are analogous (as instruments of motion) to the feathered wings of birds, but are regarded as homologous to (or in their essential nature) branchiæ or respiratory organs. For details regarding the mechanism employed in their aerial progression by insects, see *INSECTS*.

Swimming is the mode of progression employed by most aquatic animals. It mainly differs from flying in this respect, that water being much more dense than air, and the body of the animal being nearly of the same weight as the water it displaces, very little effort is required to keep the animal from sinking, and hence almost the whole of the muscular force can be employed in progression. In fishes, the locomotive organs consist of the fins and tail, the latter being the great propelling organ. The swimming of a fish has been correctly compared to the motion of a boat propelled by a single oar or scull at the stern. In the same manner as a succession of strokes alternately right and left propels the boat straight forwards, so the fish advances by striking alternately right and left with its tail. The caudal fin, in which the tail ends, is vertical in fishes, and is usually considerably forked, when there is great speed. The ventral fins are for the purpose of keeping the fish in its proper position, with the back upwards, as is shewn by a well-known experiment of Borelli, who, after cutting off these fins, restored the living fish to the water, when it rolled from side to side like a drunken man. The air-bladder with which many fishes are provided, and which they can distend and contract at pleasure, facilitates their swimming by enabling them to modify their specific gravity. Most terrestrial mammals, excepting man, swim at once the first time they find themselves in deep water. The reason of this is, that their limbs move in water precisely as they do on land, and no new action either as regards direction or order is required, as is the case with man, to enable them to swim. Those which frequent the water, as seals, otters, and beavers, have webbed feet like ducks and other palmiped birds, the toes being united by membranes, which, when expanded, act as paddles. A large number of invertebrate animals move chiefly by swimming. Thus lobsters move by means of a vertical motion of the tail, and many of the crabs by means of their posterior legs, which are fashioned like oars. Many insects swim with their legs, which are fringed with hairs to give additional surface. The cuttle-fish uses its long arms as oars, and darts through the water with extreme rapidity; while other molluscs erect sail-like organs, by which they are propelled along the surface of the water. *SWIMMING*, as a gymnastic exercise, is described in a separate article.

Notices of the more special modes of progression will be found under a variety of heads. See *CRUSTACEA*, *SERPENTS*, *WORMS*.

MOTION, in Plants. See *IRRITABILITY* and *SPORE*.

MOTIVE, or *MOTIVO*, in a musical composition, means the principal subject on which the movement is constructed, and which, during the movement, is constantly appearing in one or other of the parts, either complete or modified. In elaborate and long compositions there are also secondary motives.

MOTLEY, JOHN LOTHROP, LL.D., D.C.L., &c., American historian, was born at Dorchester, Massachusetts, April 15, 1814. After graduating at Harvard University, he spent a year at Göttingen, another at Berlin, and travelled in Italy and other

parts of Southern Europe. Returning to America, he studied law, and was admitted to the bar in 1837; but preferring literature, he wrote a historical romance, entitled *Morton's Hope* (1839), which had little success. In 1840, he received the appointment of secretary of legation to the American Embassy to Russia, but soon resigned, and in 1849, published another unsuccessful novel, entitled *Merry Mount, a Romance of the Massachusetts Colony*. He attracted attention, however, by some valuable historical essays for American reviews, among which may be mentioned one on De Tocqueville's *Democracy in America*, and another on 'Peter the Great;' and having planned a history of Holland, he proceeded to Europe for materials, and after five years' labour, published in 1856 *The Rise of the Dutch Republic*, which had an immediate and marked success, was translated into French, Dutch, and German, and caused him to be elected to the French Institute and many learned societies in Europe, and to receive the degrees of Doctor of Laws from Harvard, and Doctor of Civil Law from Oxford University. He has since been engaged on a *History of the United Netherlands*, of which two volumes were published in 1860.

MOTRIL, a town of Spain, in the province of Granada, and 35 miles south of the city of that name, in a richly productive district about 3 miles from the sea. The hills in the vicinity are covered with vines, and the town is tropical in its aspect. Agriculture and fishing are the principal employments of the inhabitants. Pop. 12,850.

MOTTO, in Heraldry, a word or short sentence which forms an accompaniment to a coat-of-arms, crest, or household badge. Mottoes were originally attached to the badge when the family had one, or to the crest where there was no badge. In later heraldry, the practice is to place the motto in an escroll either over the crest or below the shield. A motto is sometimes a religious or moral sentiment, as 'Gardez la foi,' 'Humanitate;' it is not unfrequently a heroic exclamation or war-cry, 'Courage sans peur,' 'Forward.' In a great many cases it bears reference to the crest, badge, or some bearing of the escutcheon; thus, Stuart, Earl of Moray, has for crest a pelican wounding herself, and for motto, 'Salus per Christum Redemptorem;' and not a few mottoes are punning allusions to the family name—as Scudamore, 'Scuto amoris Divini;' Vernon, 'Ver non semper viret;' 'Fare, fac,' for Fairfax; and 'Time Deum, cole regem,' for Coleridge. Two mottoes are sometimes used by the same family—one above the crest, the other below the shield. The motto, 'Dieu et mon Droit,' which accompanies the royal arms of Great Britain, is supposed to have been a war-cry, and was used in England at least as early as the time of Henry VI. Its origin has been assigned to a saying of Richard I., 'Not we, but God and our right have vanquished France.'

MOUFFLON, or **MUSMON** (*Ovis* or *Caprovius Musimon*), the wild-sheep of Corsica, Sardinia, Cyprus, Greece, &c. It is about the size of a small fallow-deer, covered with hair and not with wool, except that hair of a somewhat woolly character appears in winter. The upper parts are brownish, the under parts whitish; the hair of the neck is long; the tail is very short. The horns of the male are very large, approaching to those of the Argali. The *M.* lives chiefly in the higher parts of mountainous regions, and is not easily approached by the hunter.

MOULD, or **MOULDINESS**, the common name of many minute fungi which make their appearance, often in crowded multitudes, on animal and vegetable substances, either in a decaying or in a living but

morbid state. To the naked eye, they often seem like patches or masses of fine cobweb, and are discovered by the microscope to consist of threads more or less distinctly jointed, sometimes branched. Some species of *M.* occur on many different substances; others seem to be peculiar to substances of particular kinds, as decaying pears, decaying gourds, &c. Some of the moulds belong to the suborder of fungi called *Phycomycetes*. See FUNGI. One of these is the COMMON *M.* (*Mucor mucedo*), so plentifully found on fruit, paste, preserves, &c., in a state of incipient decay, the progress of which it hastens. It consists

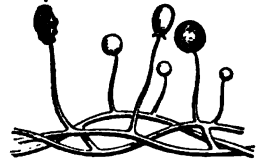

Common Mould (*Mucor mucedo*), highly magnified.

of cobweb-like masses of threads, from which rise many short stems, each bearing at the top a roundish membranous blackish spore-case.—A nearly allied, and also very common species, is *Ascopora mucedo*, which forms a bluish *M.* on bread. From a spreading cobweb-like bed rise long slender branches, terminated by spore-cases, of which the vesicle collapses into the form of a little *pileus*.—An interesting species of *M.*, remarkable for its luxuriance and beauty of colours—at first white, then yellow, with orange spore-cases, then shining green or olive, and with threads often several inches long—grows on fatty substances.—Other species of *M.* are ranked among *Hyphomycetes*, a suborder of Fungi, having a floccose thallus and naked spores. One of these is the BLUE *M.* (*Aspergillus glaucus*), which imparts to cheese a flavour so agreeable to epicures, and perhaps marks it as in a condition most suitable for promoting the digestion of other aliments, of which epicures eat too much. Advantage is often taken of the fact, that a small portion of cheese affected with *M.* will speedily infect sound cheese into which it may be introduced. It is one of the few cases in which the propagation of these fungi is ever desired and sought after by man.—SNOW *M.* (*Lanosa nivale*) is found on grasses, and especially on barley and rye beneath snow, often destroying whole crops. It appears in white patches of a foot or more in diameter, which finally become red as if dusted with red powder.

Even living animals are liable to be injured by fungi of this kind. Silk-worms are killed in great numbers by one called **MUSCARDINE** (q. v.), or **SILK-WORM ROT**. Such fungi are sometimes developed on the mucous membrane and in internal cavities of vertebrated animals; and on the bodies of invertebrated animals, as the common house-fly, which, in the end of autumn, when it becomes languid, often dies from this cause. Even strongly-scented substances, if moist, are liable to be attacked by *M.* of one kind or other; nor are strong poisons, either animal or vegetable, a sufficient safeguard. *Ascopora mucedo* springs up readily in paste full of corrosive sublimate; and the mycelium of moulds is found in strong arsenical solutions. The only sure preventive of *M.* is dryness. Many of the moulds vegetate in liquids, but do not attain their perfect development, only appearing as filamentous and flocculent mycelia. The *Vinegar Plant* (q. v.) is an instance of this kind.

Mildews and Moulds are very nearly allied.

The rapidity with which these fungi are produced is marvellous. In favourable circumstances, a plant will pass through every stage of growth to perfect maturation of its seeds in less than two days, the threads which sustain the ripe sporangia

being so long, and yet so delicate, as to make it a marvel that they can remain erect.—(Berkeley).

MOULD, the model or pattern from which workmen execute mouldings, ornaments, &c. Also, the shape or bed in which metal and other castings are made.

MOULDINGS, the curved and plane surfaces used as ornaments in cornices, panels, arches, &c., and in all enriched apertures in buildings. In classic architecture the mouldings are few in number, and

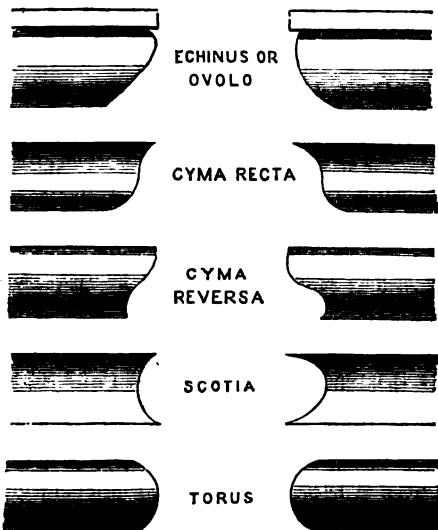

Classic Mouldings.

definitely fixed in their forms. There are eight kinds of these regular mouldings, viz. the Cyma, the Ovolo (or Echinus), the Talon, the Cavetto, the Torus, the Astragal, the Scotia, and the Fillet (q. v.); and each of these mouldings has its proper place assigned to it in each order. See COLUMN. In Gothic architecture, and all other styles, the mouldings are not reduced to a system as in the Greek and Roman styles, but may be used in every variety of form at the pleasure of the artist. Certain forms generally prevail at one period in any style. Thus, in Gothic architecture, the date of a building may in many instances be determined by the form of the mouldings.



Various Mouldings.

The Norman mouldings were very simple in outline, and frequently enriched with the zigzag and billet ornaments. Fig. 1 is a common Norman form.

In the early English style, the mouldings are also simple in outline, and are usually arranged in rectangular divisions, as in fig. 3, and consist of alternate rounds and hollows. In late examples of this style, the fillet was introduced (fig. 2), and

led to the more elaborate form of mouldings during the Decorated period (fig. 4).

The mouldings of the perpendicular style are generally flatter and thinner than the preceding, and have large hollows separated by narrow fillets, which produce a meagre effect.

Each of these styles has its peculiar ornaments and style of foliage; and when these are used along with the mouldings, there is no difficulty in determining the approximate date of a building.

MOULINS, a town of France, capital of the department of Allier, on the right bank of the river Allier, here crossed by a handsome stone bridge of 13 arches, lies 213 miles, by railway, south-east of Paris, and 95 miles north-west of Lyon. M. was formerly the capital of Bourbonnais. It is a clean, well-built town, with pretty promenades. The principal buildings are the cathedral of Notre Dame (for the enlargement of which the sum of one and a half million francs was granted in 1852), the museum, the theatre, the public library containing 20,000 vols., the new town-house, the Palace of Justice, and the college. Of the old castle, built by the Duc de Bourbon in 1530, only a square tower remains, which is used as a prison. M. carries on trade in coal, wood, iron, grain, wine, oil, and cattle. Pop. 15,471.

MOULMEIN, the seat of government of the Tenasserim Provinces (q. v.), situated on the north-east corner of the Bay of Bengal, at the junction of the rivers Salween, Gyne, and Attaran, in 16° 29' N. lat., and 97° 38' E. long. M., one of the healthiest stations in India, is a pretty specimen of an eastern town. It is divided into five districts, each of which is under a gong or native head of police. The streets are, for the most part, shaded with trees, principally of the acacia tribe, and the glossy jack is often seen half covering a native house, its great fruit, as large as a child's head, ripening in the sun. The principal street, about 3 miles in length, runs due north and south, and parallel with the river Salween. The native houses are constructed in the usual Burman style of bamboo, and a thatch made of the leaf of the water-palm. All are raised on piles, according to the universal custom of the country. Men walk about with the green paper chhattah, or Chinese umbrella, used throughout the provinces; the *gharie*, or India cab, dashes along, the attendant imp revelling in heat and dust.

M. is backed by a fine range of hills, on whose heights flash the gilded spires of innumerable pagodas; and here, too, are built many pretty residences, commanding a fine view of the town, river, and adjacent country, which for picturesque beauty and varied scenery has few equals. M. boasts various churches, chapels, and missionary establishments, several charitable and educational institutions, substantial barracks, a general hospital, public library, &c. Vessels drawing 10 feet of water can come up to M., under charge of pilots from Amherst, and at spring-tide ships of any tonnage may reach the town. The rise and fall of the water is at that time from 20 to 23 feet. The population of M. is on the increase. In the census of 1855—1856 it is given as follows:

Number of Men,	18,021
" Women,	11,810
" Children,	14,052
	43,683

Besides the Burmans proper, the inhabitants of M. include Eurasians or half-casts, Taliens, Chinese, Shans, Karens, Armenians, Jews, Malays, and natives of Hindustan.

M. possesses great facilities for ship-building and

many fine vessels have lately been constructed in the building-yards of Tavoyzoo and Mopoon. The principal exports from M. are teak-timber and rice; the imports consist of general merchandise, chiefly piece-goods, hardware, provisions, and sundries.

The Tenasserim and Martaban Directory; Winter's *Six Months in British Burmah* (Lond. 1858); Marshall's *Four Years in Burmah* (Lond. 1860); personal observation.

MOULTING is the term applied by naturalists to the periodical exuviation, or throwing off of certain structures, which are for the most part of an epithelial or epidermic character. Thus, in a considerable number of the *Articulata*, the external covering is thrown off, and replaced many times during life. In some of the minute Entomostracous Crustacea of our pools, a process of moulting, similar to that which occurs in crabs and lobsters, occurs every two or three days, even when the animals seem to have attained their full growth. In the crabs, in which the process has been carefully observed, the *exuvium*, or cast-off shell, consists not only of the entire external covering, including even the faceted membrane which forms the anterior coat of the compound eyes, but also carries with it the lining membrane of the stomach, and the plates to which the muscles are attached. During growth, this moulting takes place as often as the body becomes too large for the shell; and after the animal has attained its full size, it is found to occur at least once a year, at the reproductive season. During the early growth of insects, spiders, centipedes, &c., a similar moult is frequently repeated at short intervals, but after they have attained their full size, no further moulting takes place. In the *Vertebrata* we have examples of as complete a moulting, and replacement of new skin, among frogs and serpents as occurs in the *Articulata*, the whole epidermis being thrown off at least once, and, in some instances, several times yearly. In birds, the feathers are periodically cast off and renewed; in mammals generally, the hair is regularly shed at certain periods of the year; and in the deer tribe the casting off and renewal of the antlers must be regarded as a special example of moulting. In man, the continual exuviation of the outer layers of the epidermis is a process analogous to that which takes place on a more general scale in the lower animals.

MOULTRIE, FORT, a fortress on Sullivan's Island, at the mouth of Charleston Harbour, South Carolina, celebrated for the repulse of a British squadron commanded by Sir Peter Parker, January 28, 1776. The fort, at that time, was hastily built of Palmetto logs and sand, with 31 guns and 435 men. The spongy wood of the palmetto was found to resist the cannon balls perfectly. The fort was afterwards rebuilt, and in April 1861, took part in the reduction of Fort Sumter, and the commencement of active hostilities in the civil war of secession.

MOUND (Lat. *mundus*), in Heraldry, a representation of a globe, surmounted with a cross (generally) pattée. As a device, it is said to have been used by the Emperor Justinian, and to have been intended to represent the ascendancy of Christianity over the world. The royal crown of England is surmounted by a mound, which first appears on the seal of William the Conqueror, though the globe

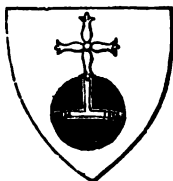

Mound.

without the cross was used earlier.

MOUNT, in Heraldry. When the lower part of the shield is occupied with a representation of ground slightly raised, and covered with grass, this is called a mount in base; e.g., Argent, on a mount in base, a grove of trees ppr.—Walkinshaw of that Ilk, Scotland.



Mount.

MOUNT VERNON, the seat and tomb of George Washington, first President of the United States of America, on the right bank of the river Potomac, in Virginia, 15 miles below Washington. The residence of Washington, finely situated on the rising bank of the river, and his tomb, with an estate of 200 acres, have been purchased by a patriotic society of ladies, to be kept as a place of public resort, and a memorial of the 'Father of his country.'

MOUNTAIN ASH. See ROWAN.

MOUNTAIN LIMESTONE, the basement rock of the carboniferous series in the south of England and in Wales. It consists of a calcareous rock loaded with marine remains, the greater part of the rock being made up bodily of corals, crinoids, and shells. It has a variable thickness, sometimes reaching as much as 900 feet. In the north of England and in Scotland, the marine limestones are not separated from, but alternate with the coal-bearing strata. See CARBONIFEROUS SYSTEM.

MOUNTAINS. The number and altitude of the mountains of the globe are so great that they form almost everywhere prominent objects, and operate to a large extent in modifying the climatic conditions of every country in the world. Yet the amount of solid material so raised above the ordinary level of the land is not so much as might be expected. Remembering that elevated plateaus of great extent occur in several regions, and that the general surface of the earth is considerably higher than the sea-level, it has been estimated that were the whole dry land reduced to a uniform level, it would form a plain having an elevation of 1800 feet above the sea. And were these solid materials scattered over the whole surface of the globe, so as to fill up the bed of the ocean, the resulting level would be considerably below the present surface of the sea, inasmuch as the mean height of the dry land most probably does not exceed one-fifteenth of the mean depth of the bed of the ocean.

Mountains, and especially mountain-chains, subserve important uses in the economy of nature, especially in connection with the water system of the world. They are at once the great collectors and distributors of water. In the passage of moisture-charged winds across them, the moisture is precipitated as rain or snow. When mountain-ranges intersect the course of constant winds by thus abstracting the moisture, they produce a moist country on the windward-side, and a comparatively dry and arid one on the leeward. This is exemplified in the Andes, the precipitous western surface of which has a different aspect from the sloping eastern plains; and so also the greater supply of moisture on the southern sides of the Himalayas brings the snow-line 5000 feet lower than on the northern side. Above a certain height the moisture falls as snow, and a range of snow-clad summits would form a more effectual separation between the plains on either side than would the widest ocean, were it not that transverse valleys are of frequent occurrence, which open up a pass, or way of transit, at a level below the snow-line. But even these would not prevent the range being an impassable

MOUNTAINS.

barrier, if the temperate regions contained as lofty mountains as the tropics. Mountain-ranges, however, decrease in height from the equator to the poles in relation to the snow-line.

The numerous attempts that have been made to generalise on the distribution of mountains on the globe have hitherto been almost unsuccessful. In America, the mountains take a general direction more or less parallel to the meridian, and for a distance of 8280 miles, from Patagonia to the Arctic Ocean, form a vast and precipitous range of lofty mountains, which follow the coast-line in South America, and spread somewhat out in North America, presenting everywhere throughout their course a tendency to separate into two or more parallel ridges, and giving to the whole continent the character of a precipitous and lofty western border, gradually lowering into an immense expanse of eastern lowlands. In the Old World, on the other hand, there is no single well-defined continuous chain connected with the coast-line. The principal ranges are grouped together in a Y-shaped form, the general direction of which is at right angles to the New World chain. The centre of the system in the Himalayas is the highest land in the hemisphere. From this, one arm radiates in a north-east direction, and terminates in the high land at Behring Straits: the other two take a westerly course; the one a little to the north, through the Caucasus, Carpathians, and Alps, to the Pyrenees; the other more to the south, through the immense chain of Central African mountains, and terminating

at Sierra Leone. Most of the principal secondary ranges have generally a direction more or less at right angles to this great mountain tract.

The inquiry into the origin of mountains is one that has received not a little attention. Geologists have shewn that the principal agents in altering the surface of the globe are denudation, which is always abrading and carrying to a lower level the exposed surfaces, and an internal force which is raising or depressing the existing strata, or bringing unstratified rocks to the surface. Whether the changes are the small and almost imperceptible alterations now taking place, or those recorded in the mighty mountains and deep valleys everywhere existing, denudation and internal force are the great producing causes. These give us two great classes of mountains.

1. *Mountains produced by denudation.*—The extent to which denudation has altered the surface of the globe can scarcely be imagined. All the stratified rocks are produced by its action; but these do not measure its full amount, for many of these beds have been deposited and denuded, not once or twice, but repeatedly, before they reached their present state. Masses of rock more indurated, or better defended from the wasting currents than those around, serve as indices of the extent of denudation. The most remarkable case of this kind, with which we are acquainted, is that of the three insulated mountains in Ross-shire—Suil Veinn, Coul Beg, and Coul More (fig. 1)—which are about 3000 feet high. The strata of the mountains

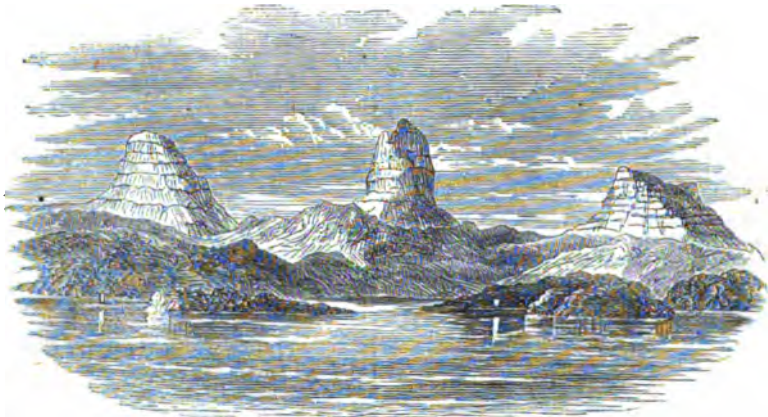

Fig. 1.—Suil Veinn, Coul Beg, and Coul More.—From Murchison's *Siluria*: London, J. Murray.

are horizontal, like the courses of masonry in a pyramid, and their deep red colour is in striking contrast with the cold bluish hue of the gneiss which forms the plain, and on whose upturned edges the mountain-beds rest. It seems very probable, as Hugh Miller suggests, that when the formation of which these are relics (at one time considered as Old Red Sandstone, but now determined by Sir Roderick Murchison as being older than Silurian), was first raised above the waves, it covered, with an amazing thickness, the whole surface of the Highlands of Scotland, from Ben Lomond to the Maiden Paps of Caithness, but that subsequent denudation swept it all away, except in circumscribed districts, and in detached localities like these pyramidal hills.

2. *Mountains produced by internal force.*—These are of several kinds. (a.) Mountains of ejection, in which the internal force is confined to a point, so to speak, having the means of exhausting itself

through an opening in the surface. The lava, scoriae, and stones ejected at this opening form a conical projection which, at least on the surface, is composed of strata sloping away from the crater. Volcanoes are mostly isolated conical hills, yet they chiefly occur in a somewhat tortuous linear series, on the mainland and islands which enclose the great Pacific Ocean. Vesuvius and the other European volcanoes are unconnected with this immense volcanic tract. (b.) But the internal force may be diffused under a large tract or zone, which, if it obtain no relief from an opening, will be elevated in the mass. When the upheaval occurs to any extent, the strata are subjected to great tension. If they can bear it, a soft rounded mountain-chain is the result; but generally one or more series of cracks are formed, and into them igneous rocks are pushed, which, rising up into mountain-chains, elevate the stratified rocks on their flanks, and perhaps as parallel ridges. Thus, the Andes

MOURNE MOUNTAINS—MOUSE.

consist of the stratified rocks of various ages, lying in order on the granite and porphyry of which the mass of the range is composed. The position of the strata on such mountains supplies the means of determining, within definite limits, the period of upheaval. The newest strata that have been elevated on the sides of the mountain when it was formed, give a date antecedent to that at which the elevation took place, while the horizontal strata at the base of the mountain supply one subsequent to that event. Thus, the principal chain of the Alps was raised

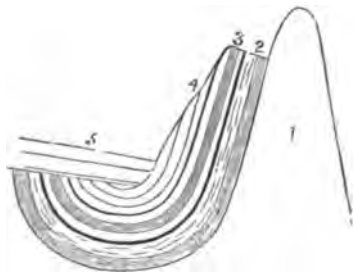

Fig. 2.—Principal System of the Alps :

1, Granitic rocks; 2, Palaeozoic; 3, Secondary; 4, Tertiary; 5, Recent.

during the period between the deposition of the Tertiary and that of the older recent deposits. (c.) But there is yet another way in which the upheaving internal force operates, viz., where it does not act at right angles to the surface, but rather obliquely, and, as it were, pushes the solid strata forwards, causing them to rise in huge folds, which, becoming permanent, form parallel ranges of mountains. The crust of the earth, in its present solid and brittle condition, is thus curved, in a greater or less degree, by the shock of every earthquake; it is well known that the trembling of the earth is produced by the progress of a wave of the solid crust; that the destruction of buildings is caused by the undulation; and that the wave has been so evident, that it has been described as producing a sickening feeling on the observer, as if the land were but thin ice heaving over water. This mode of mountain formation has been explained, when treating of the Appalachians (q. v.), which



Fig. 3.—The System of the Netherlands :

1, Silurian; 2, Coal Measures; 3, New Red Sandstone; 4, Oolite; 5, Chalk.

were thus formed. Many other ranges have had a similar origin, as some in Belgium and in the Southern Highlands of Scotland, as has been suggested by Mr Carruthers.

It is evident that in the last two classes the parallel ridges were produced at the same time. Elie de Beaumont has generalised this, maintaining that all parallel ridges or fissures are synchronous; and on this he based a system of mountain-structure, which is too universal and too geometrical to be true. The synchronism of parallel fissures had been noticed by Werner, and it is now received as a first principle in mining. The converse is also held to be generally true, that fissures differing in direction differ also in age; yet divergence from a centre, and consequent want of parallelism, as in the case

of volcanoes, may be an essential characteristic of contemporaneity. Nevertheless, Elie de Beaumont has classified the mountains of the world according to this parallelism, holding that the various groups are synchronous. The parallelism does not consist in having the same relations to the points of the compass—for these, as regards north and south, would be far from parallel—but is estimated in its relation to some imaginary great circle, which being drawn round the globe would divide it into equal hemispheres. Such circles he calls Great Circles of Reference. But beyond this, he goes a step further, and proposes a more refined classification, depending on a principle of geometrical symmetry, which he believes he has discovered among his great circles of reference. It is to be feared, however, that his geometrical speculations have little foundation in nature.

MOURNE MOUNTAINS. See DOWN, COUNTRY OF.

MOURNING, a particular habit worn to express grief, especially for the decease of friends. The usages regarding mourning have varied much at different times and in different countries. Among the Jews, the duration of mourning for the dead was generally 7, but sometimes protracted to 30 days; and the external indications of sorrow consisted in weeping, tearing the clothes, smiting the breast, cutting off the hair and beard, lying on the ground, walking barefoot, and abstaining from washing and anointing themselves. Among the Greeks, the period was 30 days, except in Sparta, where it was limited to 10. The relatives of the deceased secluded themselves from the public eye, wore a coarse black dress, and in ancient times cut off their hair as a sign of grief. Among the Romans, the colour of mourning for both sexes was black or dark-blue under the republic. Under the empire, the women wore white, black continuing to be the colour for men, who did not cut off the hair or beard as in Greece. Men wore their mourning only a few days; women a year, when for a husband or parent. The time of mourning was often shortened by a victory or other happy public event, the birth of a child, or the occurrence of a family festival. A public calamity, such as a defeat, or the death of an emperor or person of note, occasioned a public mourning, which involved a total cessation of business, called *Justitium*. In modern Europe, the ordinary colour for mourning is black; in Turkey, violet; in China, white; in Egypt, yellow; in Ethiopia, brown. It was white in Spain until 1498. Mourning is worn of different depth, and for different periods of time, according to the nearness of relationship of the deceased. On the death of a sovereign or member of the reigning house, a court mourning is ordered; and in this country, it is usual at the same time to recommend the adoption of a general mourning.

In Scotch Law, if a husband die, whether solvent or insolvent, the widow will be entitled to a preferable payment out of the assets for mournings suitable to his rank. And the same privilege applies to mournings for such of the children as are to assist at the funeral. In England, there is no such privilege or distinction.

MOUSE (*Mus*), a genus of rodent mammalia of the family *Muridae* (q. v.), having three simple molar teeth in each jaw, with tuberculated summits, the upper incisors wedge-shaped, the lower compressed and pointed, the fore-feet with four toes and a rudimentary thumb, the hind-feet five-toed; the tail long, nearly destitute of hair, and scaly. This genus includes Rats (q. v.) and mice; the smaller species bearing the latter name.—The

MOUSE-EAR CHICKWEED—MOUTH.

COMMON *M. (M. musculus)* is perhaps not originally British, although now so abundant everywhere. It accompanies man wherever he goes, and readily colonises every region, arctic, temperate, or tropical; its great fecundity, common also to most of its congeners, causing means to be employed everywhere for the prevention of its excessive multiplication. Aristotle made the experiment of placing a pregnant female *M.* in a closed vessel filled with grain, and found in a short time no fewer than 120 mice in the vessel. Of cats and mouse-traps it seems unnecessary here to speak, and equally unnecessary to give a description of the common mouse. There are several varieties of this species. That generally found in houses is smaller, and not so dark in colour, as that common in barns and farm-yards. A white variety sometimes occurs, and has been perpetuated in a half-domesticated state. The common brown kind is, however, at least as easily tamed, and readily becomes familiar enough. A pied variety is not uncommon in India.—Much has been written about the singing powers of the *M.*; it being asserted, on the one hand, that mice not unfrequently shew a strong love for music, and a power of imitating the song of birds; whilst, on the other hand, it is alleged that the singing of mice is merely the consequence of throat disease.—The *M.* makes a nest like that of a bird in the wainscot of a wall, among the chaff or feathers of a bed, or in any similar situation. The litter is generally from six to ten in number.—The WOOD *M.*, or LONG-TAILED FIELD *M. (M. sylvaticus)*, is a little larger than the Common Mouse. Its tail is



Long-tailed Field Mouse (*Mus sylvaticus*) and Harvest Mouse (*Mus messorius*).

longer; its ears are also longer; its muzzle rather longer; its under-parts lighter in colour, than in the common mouse. It is abundant throughout Britain and the temperate parts of Europe, and is a grievous pest in gardens and fields. It lays up stores of grain and other food, either in thick tufts of grass, or just under the surface of the earth. The quantity of food laid up in such stores is often wonderfully large. The Field *M.* is timid, gentle, and easily tamed.—The smallest British *M.*, and the smallest British quadruped, is the HARVEST *M. (M. messorius)*, of which the head and body are only 2½ inches in length, the tail being almost equally long, and to some degree prehensile; the general form elongated and slender, the head narrow,

the ears not large. This species is not uncommon in some parts of the south of England; it is also found in the south of Scotland, although less frequently. It makes its nest among the stalks of wheat, reeds, or other grasses, weaving together the leaves and panicles of grasses, the leaves being for this purpose cut into shreds by its teeth. The nest is a very curious structure formed by mere intertwining, without cement of any kind. It is generally suspended among the stalks. It is globular, or nearly so, and entrance to it is through an opening, which almost completely closes up again.—A still smaller species of *M.* (*M. pumilus*) is found in the south of Europe.—An American species, the WHITE-FOOTED *M. (M. leucopus)*, common in most parts of North America, and intermediate in its habits between the Common *M.* and the Field *M.*, is said to depart from houses whenever either the cat or the brown rat appears in them.—The Barbary *M. (M. Barbarus)* approaches in size to the rats, and is distinguished by its longitudinally striped fur.

The name *M.* is often popularly given to animals considerably different from the true mice, as the *Voles* (q. v.).

MOUSE-EAR CHICKWEED (*Cerastium*), a genus of plants of the natural order *Caryophyllaceæ*, having five sepals, five bifid petals, ten stamens, five styles, and a capsule bursting at the top with ten teeth. The species are numerous, natives of temperate and cold countries in all parts of the world. Some of them are among the most common weeds in Britain; others, having larger flowers, are occasionally planted in flower-borders and on rock-works. The form and hairiness of the leaves of some of the British species have given rise to the popular name.

MOUTH, DISEASES OF THE, occur in different forms, but usually begin with inflammation of the mucous membrane. The inflammation may be equally diffused, or may be chiefly or entirely confined to the mucous follicles. When diffused, it may either present no peculiar secreted product, or the surface may be covered with a curd-like secretion, or with patches of false membrane. It may further be attended with eruption, ulceration, or gangrene, any one of which may impress a special character on the disease, or it may present peculiarities from the nature of its exciting cause, as when it accompanies scurvy, or is the result of mercurial action.

The following are the principal forms of inflammation of the mouth, or *stomatitis* (Gr. *stoma*, the mouth), as it is termed by nosologists. 1. *Common Diffused Inflammation*, which appears in reddened, somewhat elevated patches, and sometimes occupies large portions of the surface of the mouth. It is more commonly a complication of other diseases than an original affection. When of the latter character, it is generally caused by the direct action of irritants, as by scalding drinks, corrosive substances introduced into the mouth, accumulated tartar on the necks of the teeth, &c. In ordinary cases, cooling and demulcent liquids (such as cream or almond oil) applied locally, an occasional saline cathartic, with a soft and chiefly farinaceous diet, constitute the whole of the necessary treatment.

2. *Diffused Inflammation, with curd-like exudation*, is almost entirely confined to infants, and is described under its popular name of *THRUSH*.

3. *Inflammation of the Follicles, and Eruption or Vesicular Inflammation*, are described in the article *APTÆ* (q. v.).

4. In *Ulcerative Inflammation, Cancrum Oris*, or *Canker*, an ulceration often of considerable size,

with a grayish surface and an inflamed edge, appears on the gums, or inside of the cheeks or lips. The swelling of the adjacent parts is often so considerable, as to be apparent externally. There is a copious flow of saliva, and the breath is very offensive. The disease generally occurs in children from two to six years of age. The ulcer may continue for weeks, or even months, but always yields to treatment. The febrile symptoms and the constipation which are usually present, must be combated in the ordinary way. Perhaps the best general method of treating the disease is by the administration of chlorate of potash (four or five grains in sweetened water every four hours), and by frequently washing the mouth with a weak tepid solution of chlorinated soda.

5. The preceding affection is sometimes the first stage of a much more serious affection—viz, *Gangrene of the Mouth*, which usually occurs in children between the first and second dentition. A sloughing ulcer forms upon the gums, or some other part of the mouth. This slough spreads, the breath becomes extremely fetid, the disease extends to the alveolar processes, and the teeth are loosened and fall out. Inability to take food is followed by exhausting diarrhoea, and death is the usual termination. Unless taken in the early stage, when tonics and the local application of caustics may be serviceable, the disease is generally fatal.

Other affections of the mouth are noticed in the articles SALIVATION and SCURVY.

MOVABLES, in Scotch law, is the technical term to denote personal as contradistinguished from heritable property, one of the main distinctions of property being between these two classes. Heritage goes to the heir-at-law in case of intestacy, or what is equivalent to it, and movables go to the next of kin. See KIN. The term movables is thus not confined to corporeal things, as furniture, cattle, goods, &c., but includes debts, bills of exchange, rights of action, &c.

MOVING PLANT (*Desmodium gyrans*), a plant of the natural order *Leguminosae*, suborder *Papilionaceae*, a native of India, remarkable, as are also some other species of the same genus, for the spontaneous motion of the leaves. The leaves are ternate, the lateral leaflets much smaller than the terminal one. These lateral leaflets are in constant motion, being elevated by a succession of little jerks till they meet above the terminal leaflet, and then moving downwards by similar rapid jerks to the leaf-stalk. Sometimes one leaflet is in motion and the other at rest. Sometimes a few may be seen moving, whilst there is a partial cessation in the other leaves of the plant. A high wind causes this cessation more than anything else; the movements are more languid in a very hot dry day, and are to be seen in their perfection in warm moist weather. The terminal leaflet does not remain absolutely at rest, although its movements are not like those of the lateral ones, but oscillates slowly from one side to the other. Concerning these remarkable movements, nothing more than the fact that they take place can yet be said to be known.

MOXA is a peculiar form of counter-irritation which was early practised in the East, particularly by the Chinese and Japanese, from whom it was learned by the Portuguese. One or more small cones, formed of the downy covering of the leaves of *Artemisia Moxa* (as used by the Chinese), or of the pith of various plants (as of the common sunflower), or of linen steeped in nitre, are placed on the skin over the affected part, and the ends remote from the skin are ignited. The combustion gradually proceeds through the cone and forms a superficial

eschar on the skin. The surrounding parts must be protected by a pad of wet rag, with a hole in it for the moxa.

It may be employed with advantage in certain forms of neuralgia (especially obstinate sciatica) and paralysis, and in chronic diseases of the joints. It is not much used in consequence of its apparent severity, but the pain is not so great as might be expected, and, according to some of its advocates, is less than often attends blisters.

MOZAMBIQUE, a territory on the east coast of South Africa, nominally belonging to Portugal, and placed under a governor-general, although the actual possessions of Portugal consist only of a few stations, and her authority in the country is inconsiderable. It extends from Cape Delgado, in lat. 10° 41' S., to Delagoa Bay, 26° S. The chief river, the Zambezi, divides it into two portions—M. proper on the north, and Sofala on the south. Area estimated at 283,500 square miles; pop. 300,000. These figures, however, are only to be considered approximate, as the country has no definite boundary to the west. The coasts, which comprise large tracts of cultivated soil, yielding rich harvests in rice, are fringed with reefs, islands, and shoals, and between Delagoa Bay and Cape Corrientes, and from M., the principal station, to Cape Delgado, the shores are high and steep. The forests yield valuable ornamental woods; ivory is obtained from the hippopotami that haunt the marshes; and gold and copper are found and worked. The elephant, deer, and lion inhabit the jungle; crocodiles are found in the rivers, and numerous flamingoes on the coasts. The rainy season lasts from November to March. The summer heat is very great, and the climate, which is fine in the elevated tracts, is unhealthy on the low shores and the swampy districts. Besides numerous fruits and vegetables, the grains are rice, millet, maize, and wheat. The government is in a most inefficient state, being, in most places, more in the hands of native chiefs than of the Portuguese. In former times the slave-trade was carried on here extensively; and from 1846 to 1857, four governors-general were removed by their government for countenancing, if not actively engaging in it. The colony is divided into six districts, and is ruled by the governor-general and his secretary, assisted by a *junta*. Religion and education are supervised by about twelve Roman Catholic priests, but seem to be at the lowest ebb. Fish and turtle are caught in great quantities on the islands and reefs; pearl-fishing is a source of considerable profit; cattle, sheep, and goats are numerous, and the principal exports are grain, gold-dust, honey, tortoise-shell, cowries, gums, and amber. The Portuguese arrived here in 1497, attracted by rumours of the wealth of the country and the excellence of its ports. The principal settlements are Mozambique, Quilimane, Sena, and Tete.

MOZAMBIQUE, the capital of the Portuguese territory of the same name, is situated on a small coral island, on the eastern coast of Africa, close to the shore, in lat. 15° 2' S. It is defended by three forts, is well built, and contains a large square in which the palace of the governor and the custom-house are the chief buildings. Pop. 8522, of whom 7000 are slaves, 270 Christians, 102 Banyians from Hindustan, and 1150 Arabs. In former times all the markets of the world were supplied with slaves from Mozambique. Its commerce, now inconsiderable, is chiefly with India, and is carried on by Arabs.

MOZAMBIQUE CHANNEL, between the island of Madagascar and the south-eastern

coast of Africa, is about 1000 miles in length, and about 450 in average breadth. At its northern extremity are the Comoro Islands. Over the northern portion the monsoons blow. Black whales, yielding spermaceti, abound.

MOZARABIAN LITURGY, a liturgy—traced back by some to the apostles, but by the majority of writers to St Isidore of Sevilla, who redacted it, in co-operation with the Fathers of the 4th Council of Toledo, 633—originally in use among those Christian inhabitants of Spain (Muzarabians, Mostarabians, Mustarabians) who remained faithful to their religion after the Arabic conquest. It is also called the Gothic Liturgy, and differs in some respects from the Roman. Gregory VII first compelled most of the Spanish churches and convents to adopt the common uniform liturgy of the Romish Church. Six Mozarabic congregations alone, chiefly in Leon and Toledo, were allowed to retain their ancient ritual, but it soon fell into disuse even among these. Archbishop Ximenes of Toledo expressly founded a chapel at Toledo, in 1500, in which mass was to be said according to the Mozarabic manner, lest it might entirely fall into oblivion. He further caused a number of learned priests, Alfonso Ortiz among them, to collate all the different Mozarabic liturgical MSS. to be found in the different churches, chapels, and convents, and finally, there was edited, under his auspices, the *Missale Mistum secundum Regulam Beati Isidori Dictum Mozarabicum* (1500—1502), which has, however, by some unfortunate accident, remained incomplete. A whole third of the church-year is left out entirely. The peculiar affinity of this liturgy with the Gallican on the one, and the Greek on the other hand, makes its study extremely important for the history of the ancient Church.

MOZART, JOHANN CHRYSOSTOM WOLFGANG GOTTLIEB, one of the greatest of musical composers, was born, 27th January 1756, at Salzburg, where his father was sub-director of the archiepiscopal chapel. His extraordinary musical talents were cultivated to the utmost by his father. At the age of four he played the clavichord, and composed a number of minuets and other pieces still extant. When only six years of age, his performances were so remarkable, that his father took him and his sister, who possessed similar gifts, to Munich and Vienna, where they obtained every kind of encouragement from the Elector of Bavaria and the Emperor Francis I. In 1763 and 1764, the Mozart family visited Paris and London. At the age of seven, young Mozart surprised a party of musicians, including his father, by taking part, at sight, in a trio for stringed instruments. Symphonies of his own composition were produced in a public concert in London; and whilst there, he composed and published six sonatas, and made acquaintance with the works of Handel, recently deceased. Two years later, when but twelve years of age, he composed the music for the religious service, and for a trumpet concert at the dedication of the Orphan House Church in Vienna, and conducted it in presence of the imperial court. In 1769, at the age of thirteen, he was appointed director of the Prince Archbishop of Salzburg's concerts; and in the same year travelled with his father to Italy, where he created an unheard-of enthusiasm by his performances and compositions. He composed the opera of *Mithridates* at Milan, in October 1770, and it was publicly performed there in December of that year. At the age of sixteen, he was the first clavecinist in the world; he had produced two requiems and a *stabat mater*, numerous offertories, hymns, and motetts, 4 operas, 2 cantatas, 13 symphonies, 24

pianoforte sonatas, not to speak of a vast number of concertos for different instruments, trios, quartets, marches, and other minor pieces. In 1779, he was appointed composer to the imperial court at Vienna, where he then fixed his residence, and there the musical works were composed upon which his great fame chiefly depends. His office in Vienna, however, was rather honorary than lucrative, and he lived by concerts, musical tours, teaching of music, and the small profits derived from the sale of his published works, till an offer of a large salary made to him by the king of Prussia led the emperor to give him 800 florins a year. His great opera of *Idomeneo* was composed in 1780, with a view to induce the family of Mademoiselle Constance Weber, afterwards his wife, to consent to the marriage, which they had declined on the ground of his reputation not being sufficiently established. This opera forms an epoch not in the composer's life only, but in the history of music. In construction, detail, instrumentation, and every imaginable respect, it was an enormous advance on all previous works of the kind, and established his repute as the greatest musician whom the world had seen. *Die Entführung aus dem Serail* followed. His six quartets, dedicated to Haydn, appeared in 1785, and in 1786 *Le nozze di Figaro*. In 1787, he produced his *chef-d'œuvre*, *Don Giovanni*, which, though received with enthusiasm at Prague, was at first beyond the comprehension of the Viennese. *Così fan tutti* appeared in 1790. To 1791, the last year of his short life, we owe *Zauberflöte*, *La Clemenza di Tito*, and the sublime requiem composed in anticipation of death, and finished only a few days before his decease. He died on 5th December 1791, aged 35.

In the intervals of his greater works, M. composed the majority of the orchestral symphonies, quartets and quintets, which are an almost indispensable part of the programme of every concert in the present day, besides masses as familiar in England as in Catholic Europe, innumerable pianoforte concertos and sonatas, and detached vocal compositions, all of the most perfectly finished description. To Haydn M. always acknowledged his obligations; but Haydn's obligations to M. are at least as great. Haydn, though born twenty-four years earlier, survived M. eighteen years, and all his greatest works, written after M.'s death, bear manifold traces of M.'s influence. M. is the first composer in whose works all traces of the old tonality disappear; he is the father of the modern school. 'No composer has ever combined genius and learning in such perfect proportions; none has ever been able to dignify the lightest and tritest forms by such profound scholarship, or at the moment when he was drawing most largely on the resources of musical science, to appear so natural, so spontaneous, and so thoroughly at his ease.'—*Hullah*. See *Holmes' Life of Mozart* (Lond. 1845); *Otto Jahn's Life of Mozart* (Leip. 1856).

MOZY'R, a town in the south-east of the government of Minsk, in European Russia, 150 miles south-south-east of Minsk, is situated on the left bank of the Pripet, a tributary of the Dnieper. It is a town of considerable antiquity, and played a rather important part in the wars between the various Russian princes, previous to the Tartar invasion. It was unsuccessfully besieged by the Tartars in 1240. Under the Polish rule it was the chief town of a district, and remained so after its annexation to Russia in 1795. 150 barges and 200 rafts are annually freighted here with goods to the amount of 500,000 rubles. Pop. (1859) 5238.

MSKET, also written **MTSCHETHA** and otherwise, one of the most ancient Georgian towns, in

the present government of Tiflis, and about 10 miles north-north-west of the town of that name. It is said to have been the seat of the Georgian kings down to the 5th c., and contained the first Christian church of Georgia, built during the first half of the 4th century. In this church the Georgian kings were crowned and buried. The site of M. is now marked by a few huts.

MTZENSK, a town of Russia, in the government of Orel, 646 miles south-south-east of St Petersburg. It is situated on the Zusha, which communicates through the Oka with the Volga. The old cathedral, built on a steep rock, gives picturesqueness to the town. M. receives historical mention as far back as 1147. Its trade, chiefly with St Petersburg and Moscow, amounts in value to upwards of 1,000,000 rubles. Pop. 13,400.

MUCILAGE, or **BASSORIN** ($C_{11}H_{10}O_{10}$), is a modification of gum which is insoluble in water, but when moistened with it, swells up into a gelatinous mass. It is contained abundantly in gum tragacanth; and many seeds, such as linseed, quince seed, &c., and certain roots, such as those of the marsh mallow, furnish it in large quantity. Alkalies render it soluble in water, and convert it into true gum; and prolonged boiling in water produces the same effect. Nitric acid converts it into mucic and oxalic acids.

MUCOUS MEMBRANES AND MUCUS. Under the term **MUCOUS SYSTEM**, anatomists include the skin, mucous membranes, and true glands, all of which are continuous with one another, and are essentially composed of similar parts. As the skin and the glands are described in special articles, it only remains to speak of the great internal mucous tracts. These are the alimentary mucous membrane, the respiratory mucous membrane, and the genito-urinary mucous membrane.

The *alimentary mucous membrane* commences at the lips, and not only forms the inner coat of the intestinal canal from the mouth to the anus, but gives off prolongations which after lining the ducts of the various glands (the salivary glands, the liver, and the pancreas) whose products are discharged into this canal, penetrate into the innermost recesses of these glands, and constitute their true secreting element. Besides these larger offshoots, we find in the stomach and small intestine an infinite series of minute tubular prolongations, the anatomical arrangement and function of which are described in the article **DIGESTION**.

The *respiratory mucous membrane* begins at the nostrils, and under the name of *schneiderian* or *pituitary membrane*, lines the nasal cavities, from whence it sends on either side an upward prolongation through the lachrymal duct to form the *conjunctiva* of the eye; backwards, through the posterior nares (the communication between the nose and the throat), it sends a prolongation through the Eustachian tube to the middle ear (the cavity of the tympanum), and is continuous with the pharyngeal mucous membrane (which is a portion of the alimentary tract); it then, instead of passing down the œsophagus, enters and forms a lining to the larynx, trachea, and bronchial tubes to their terminations. From the continuity of these two tracts, some writers describe them as a single one, under the name of the *gastro-pulmonary tract*.

The *genito-urinary mucous membrane* commences at the genito-urinary orifices, lines the excretory passages from the generative and urinary organs, and is the essential constituent of the glands of both. See **KIDNEY**, for example.

We thus see that mucous membranes line all those passages by which internal parts communicate

with the surface, and by which matters are either admitted into or eliminated from the body. As a general rule, they are soft and velvety, and of a more or less red colour, from their great vascularity, but they present certain structural peculiarities according to the functions which they are required to discharge. In all the principal parts of the mucous tracts we find the mucous membrane to present an external layer of Epithelium (q. v.) resting on a thin, transparent, homogeneous membrane, which from its position is termed the *basement membrane*, and beneath this a stratum of vascular tissue of variable thickness, which usually presents either outgrowths in the form of papillæ and villi, or depressions or inversions in the form of follicles or glands, or both. The follicles are almost invariably present, but the papillæ and villi are limited to the alimentary or gastro-intestinal mucous membrane. 'The mucous membranes,' says Dr Carpenter, 'constitute the medium through which

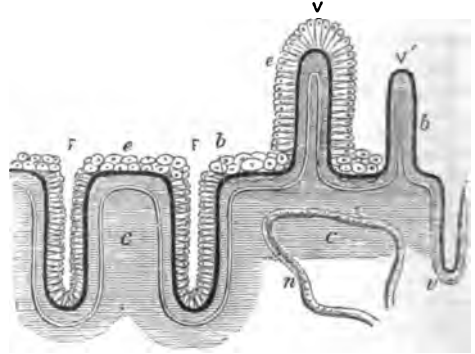

Diagram of the Structure of an Involved Mucous Membrane :

Shewing the continuation of its elements in the follicles and villi :

F, F, two follicles; b, basement membrane; c, submucous tissue; e, e, epithelium; v, vascular layer; n, nerve; V, villus covered with epithelium; V', villus, whose epithelium has been shed.

nearly all the material changes are effected that take place between the living organism and the external world. Thus, in the gastro-intestinal mucous membrane we find a provision for reducing the food by means of a solvent fluid poured out from its follicles; whilst the villi, or root-like filaments, which are closely set upon its surface towards its upper part, are specially adapted to absorb the nutrient materials thus reduced to the liquid state. This same membrane, at its lower part, constitutes an outlet through which are cast out not merely the indigestible residuum of the food, but also the excretions from numerous minute glandulæ in the intestinal wall, which result from the decomposition of the tissues, and which must be separated from them to prevent further decay. Again, the bronchio-pulmonary, or respiratory mucous membrane, serves for the introduction of oxygen from the air, and for the exhalation of water and carbonic acid. And, lastly, the mucous membranes are continuous with the cell-lined vesicles or tubes of the various glands, which are the instruments whereby their respective products are eliminated from the blood.' Although the various kinds of epithelial cells discharge a special office in relation to the peculiar function of the mucous membrane upon which each kind occurs, yet they all serve one general purpose—namely, that of protecting the surfaces on which they are placed. This protecting power is increased by the presence of the

secretion known as *mucus*, which ordinarily forms an extremely thin layer on these membranes, but when they are irritated or inflamed, is secreted in very considerable quantity. The exact mode of its formation is still a disputed question, but it is generally believed to be the product of the gradual solution of the uppermost epithelial cells. Besides acting both mechanically and chemically as a shield to highly sensitive membranes, it has other uses, amongst which two may be especially mentioned—1. It communicates to the salivary, and probably to other glands, properties which are not possessed either by itself or by the pure glandular secretions; and 2. It serves to eliminate a considerable quantity of nitrogen from the system. This nitrogen is contained in the *mucin*, which forms from 2·4 to 9 per cent. of nasal and bronchial mucus. This mucin contains 12·64 per cent. of nitrogen, and is the substance which gives to mucus its viscid and tenacious character. Normal mucus is devoid of smell and taste, and almost, if not quite, neutral; and hence its constant presence in the mouth gives rise to no disagreeable sensation.

MUDAR (*Calotropis*), a genus of shrubs of the natural order *Asclepiadaceæ*, distinguished by a coronet of fine blunt processes adhering to the base of the filaments. They are natives of the East Indies, and the bark of the root, and the inspissated milky juice of some of them, are much used there as an alterative, purgative, emetic, and sudorific medicine. The medicinal properties of *M.* have been well known in India for many centuries, and have begun to attract the attention of European physicians. It is found of great value in elephantiasis, and in leprosy and other obstinate cutaneous diseases, as well as in some spasmodic affections, and in syphilis.—The species most common in the south of India is *C. gigantea*; in the north, *C. Hamiltonii*; whilst *C. procera*, said to have an extremely acrid juice, extends into Persia, and even into Syria. *M.* is very common in India, springing up in uncultivated ground, and often troublesome in that which is cultivated. It is a large shrub, with stems often thicker than a man's leg; and broad fleshy leaves. It grows where almost nothing else will, on very dry sands, and rapidly attains a large size. The silky down of the pods is used for making a soft, cotton-like thread; but is short, and not easily spun. The inner bark also yields a strong and useful fibre, which makes excellent cordage and fishing-lines; but the mode of preparation hitherto used makes it costly.—The inspissated milky juice of *M.*, collected by making incisions in the bark, is used as a substitute for caoutchouc and gutta-percha. It becomes flexible when heated.—The *M.* of medicine contains a principle called *Mudarine*, on which its medicinal virtues are supposed to depend, and which possesses the rare property of gelatinising when heated, and becoming fluid when again cooled.

MU'DKI, usually spelled **MOODKEE**, a small town of north-west Hindustan, 28 miles south-east of the Sutlej, and 70 miles south-east of the city of Lahore, on the Ravi. It has a pop. of about 6000. Here the first battle in the Sikh war of 1845—1846 was fought (18th December 1845), when the British under Sir Hugh Gough repulsed the Sikhs; but at the same time lost heavily, especially in officers.

MUE'DDIN (*Muezzin*), the Arabic name of the Mohammedan official attached to a mosque, whose duty it is to announce the different times of prayer. His chant (*Adan*) consists of these words, repeated at intervals: 'Allah is most great. I testify that there is no God but Allah. I testify that Mohammed is the Apostle of Allah. Come to prayer.

Come to security.' ['Prayer is better than sleep' is added in the morning, at the Subh or Fegr. See **MOHAMMEDANISM**.] 'Allah is most great. There is no deity but Allah!' Besides these regular calls, two more are chanted during the night for those pious persons who wish to perform special nightly devotions. The first (*Ula*) continues, after the usual *Adan*, in this manner: 'There is no deity but Allah! He hath no companion—to Him belongeth the dominion—to Him belongeth praise. He giveth life, and causeth death. And He is living, and shall never die. In His hand is blessing, and He is almighty,' &c. The second of these night-calls (*Ebed*) takes place an hour before daybreak, and begins as follows: 'I extol the perfection of Allah, the Existing for ever and ever: the perfection of Allah, the Desired, the Existing, the Single, the Supreme,' &c. The office of a *M.* is generally intrusted to blind men only, lest they might, from their elevation, have too free a view over the surrounding terraces and harems. The harmonious and sonorous voices of the singers, together with the simplicity and solemnity of the melody, make a strikingly poetical impression upon the mind of the hearer in daytime; much more, however, is this the case whenever the sacred chant resounds from the height of the mosque through the moonlit stillness of an eastern night.

MU'FTI (Arabic, *Expounder of the Law*). The Turkish grand Mufti is the supreme head of the Ulemas (servants of religion and laws), and has, together with the Grand Vizir (Vizir Azim), the supreme guidance of the state, nominally ruled by the sultan. His is the chief spiritual authority, and in this capacity he is also denominated Sheikh-al-Islam (Lord of the Faith). The Imams (priests), however, chosen from the body of the Ulemas, are, from the moment of their official appointment, under the authority of the Kizlar-Aga, or Chief of the Black Eunuchs. The better class of the Ulemas are the teachers and expounders of the law, from among whom the Mollahs and Cadis are elected. The Turkish laws have their basis in the Koran; the Mufti thus, as head of the judges, acquires a spiritual authority. His also is generally the office of girding the sultan with the sword at his ascension to the throne, a ceremony which takes place at the Mosque of Eyub, and which is equal to our ceremony of coronation. The Mufti is elected and may be deposed by the sultan, and his position has in modern days lost much of its former dignity and importance. His Fetwa, or decision, although attached to the imperial decrees, imparts to it but little additional weight. Nor is his own dictum in things spiritual always considered as finally binding. The only prerogative of Muftis and Ulemas which has hitherto remained untouched, is their being exempt from bodily or otherwise degrading punishments; nor can their property ever be confiscated, but descends to their successors.

MUGGLETONIANS, a sect that arose in England about the year 1651, and of which the founders were John Reeve, and Ludovic Muggleton (born 1607, died 1697), obscure men, but who claimed to have the spirit of prophecy. Muggleton was a journeyman tailor. He professed to be the 'mouth' of Reeve, as Aaron was of Moses. They affirmed themselves to be the *two witnesses* of Rev. xi. They asserted a right to curse all who opposed them, and did not hesitate to declare eternal damnation against their adversaries. They favoured the world with a number of publications, one of which—particularly directed to the Parliament and Commonwealth of England, and to His Excellency the Lord General Cromwell—was entitled a *Remonstrance from the Eternal*

God. The prophets were at that time imprisoned as nuisances 'in Old Bridewell.' Another publication was a *General Epistle from the Holy Spirit*, dated from 'Great Trinity Lane, at a Chandler's Shop, overagainst one Mr Millia, a Brown Baker, near Bow Lane End, London.' [The first complete edition of M.'s works was published in 1756; another edition appeared in 1832.] The M. denied the doctrine of the Trinity; they held anthropomorphist opinions; and to all this they added many strange doctrines of their own, as that the devil became incarnate in Eve, &c. The M. existed in England as a sect till more than one-fourth of the 19th c. had passed away; but the census of 1851 shewed no trace of them, and they are supposed to be now completely extinct.

MUHALITCH, or **MUALICH**, a town of Asia Minor, in Anatolia, 13 miles south of the Sea of Marmora, and 37 miles west of Brusa, picturesquely situated on low hills. It is large and straggling, contains about 1500 houses and three or four khans, and is the seat of a considerable trade, chiefly in exporting silks, wool, and fruits to Constantinople. Pop. 11,000.

MUHLBERG, a town of Prussian Saxony, situated on the Elbe, 36 miles south-east of Wittenberg. Pop. 3320. Here, on 24th April 1547, a battle was fought between Johann-Friedrich, Elector of Saxony, and the Emperor Charles V.—a battle fraught with the most important results to the cause of Protestantism in Germany. The battle was soon decided in favour of the emperor, Johann-Friedrich was taken prisoner, and his territories were handed over to Maurice, the representative of the ducal family of Saxony. From this time till 1552, the Catholics were triumphant in Germany.

MÜHLHAUSEN, an ancient city of Prussia, in the principality of Eichsfeld, on the Unstrut, 30 miles north-west of Erfurt. It ranked in the middle ages as an important imperial free city, and is still an active centre of commerce. It has manufactories for linen and woollen goods, starch, anise, and saffron works, and carpet and leather factories. Pop. 15,150. M. was deprived of its municipal independence in 1803, and made over to Prussia, with which it has since remained incorporated, excepting for a short period during the predominance of French influence in Germany, when, at the suggestion of Napoleon, it was included in the kingdom of Westphalia, but it was restored to Prussia in 1813.

MÜHLHEIM, the name of two manufacturing towns of Rhenish Prussia, distinguished from each other as *M. an der Rhur*, and *M. am Rhein*. The former, situated on the river Rhur, 16 miles north of Düsseldorf, is a flourishing town, chiefly important on account of its trade in Rhur coal. In 1856, 22 river-steamers were built here. Sandstone is extensively quarried, and ironworks and machine-factories are in operation. Cotton-spinning, weaving, printing, tanning, and paper-making are carried on. Pop. 11,801. *M. am Rhein*, nearly opposite Cologne, carries on extensive manufactures of silk goods (employing 500 looms); there are dye-works and paper and oil mills in operation, and considerable trade and commerce. Pop. 6790.

MUIRBURN, in Scotch Law, is the crime of setting fire to heather. Neither owners nor tenants, except in high and wet lands, are entitled to set fire to heather between 11th April and 1st November, though at other times they may. And persons who wilfully fire heather are liable to be fined and imprisoned. In England, maliciously setting fire

to heaths is one of the heads of the generic offence of Arson (q. v.).

MUKDEN, or **MOUKDEN**, in lat. 41° 50' 30" N., long. 123° 37' E., the capital of Shingking, the chief province of Manchuria. Its Chinese name is Fungtien-foo, signifying *affluent capital*, a translation of the Manchu Moukden, meaning *flourishing*. It lies on a branch of the river Lian, about 500 miles north-east of Peking. The town is surrounded by a wall about 10 miles in circumference, including an inner wall 3 miles in circuit, enclosing the emperor's summer residence. The palace, and the buildings connected with it, the government offices and courts, and the grounds attached, are all arranged on a plan similar to those at Peking. Great pains have been taken by the emperors to enlarge and beautify this the metropolis of the Manchu race, but with only partial success. The family residence and place of sepulture of the founders of the reigning dynasty is Hingking, about 60 miles east of Mukden. It is pleasantly situated in a mountain valley near the palisade which separates the province from Kirin. A large garrison is maintained there, which, with the salubrity of the air, has attracted a considerable population. The emperor Kienlung rendered himself celebrated among his subjects, and the city of M. better known abroad, by a poetical eulogy upon the city and province, which was printed in 64 different forms of Chinese writing. Nineteen leagues from M. is its port, Niuchwang, which has been opened recently to foreign commerce. It is shallow, difficult of access, and during many months of the year closed by ice. Pulse, cattle, and drugs are its chief exports. The houses are built of stone, and warmed by large forms of masonry, under which the fire is kindled, and in which the cooking is done; the inmates sleep upon it by night, and lounge on it by day.—*Chinese Repository*. In 1631, M. became the seat of government of the Manchu emperors, and is now the seat of several superior tribunals of a Chinese viceroy of the first rank.

MULATTO. See **MIXED RACES**.

MULBERRY (*Morus*), a genus of trees of the natural order *Moraceæ*, natives of temperate and warm climates, with deciduous leaves, unisexual flowers in short, thick spikes, a 4-parted perianth, containing either four stamens or one pistil with two styles, the perianth of the female flowers becoming succulent and closing over the small pericarp, the whole spike coalescing into an aggregate fruit.—The **COMMON M.**, or **BLACK M.** (*M. nigra*), is a native of the middle parts of Asia, but was introduced into the south of Europe more than a thousand years ago, and is now almost naturalised there. It is a low tree, much branched, with thick rough bark, and broad heart-shaped leaves, which are unequally serrated, and very rough. It is cultivated in the middle parts of Europe, and succeeds well in the south of England, but in the northern parts of Britain it requires a wall. The perianth and stigmas are roughly ciliated, and the fruit is of a purplish-black colour, with dark red juice, fine aromatic flavour, and subacid sweet taste. The fruit is much esteemed for dessert; an excellent preserve and a pleasant light wine are made of it. The tree often produces its fruit in prodigious quantity. The wood is employed in cabinet-work, but is not of much value. The leaves are sometimes used for feeding silk-worms. The **Black M.** lives long; trees still existing in England are known to be more than 300 years old. It is propagated by seed, by suckers, by layers, or by cuttings. It succeeds best in a rich light soil.—The **WHITE M.** (*M. alba*) is a native of China, and has been there

planted from time immemorial for the sake of its leaves, which are the best food for silk-worms; on which account also it has been cultivated in the south of Europe since about 1540. In North America it does not succeed further north than lat. 43', being somewhat more impatient of frost than the Black Mulberry. The perianth and stigmas are smooth; the fruit is almost white, and is much less palatable than that of the Black M., although in this respect there is great difference among the



Common Mulberry (*Morus nigra*); fruit, leaf, and female flower.

many varieties. A rob made of it is useful in sore throat. The best variety for feeding silk-worms, on account of its rapid growth and abundant leaves, is that called the PHILIPPINE MULBERRY. In India, the White M. is treated as a bush, and cut down twice a year; the shoots, stripped of their leaves, being thrown away, although the bark has long been used in China and Japan for making paper. It grows readily from cuttings. The root has a considerable reputation as a vermifuge.—The RED M. (*M. rubra*), a native of North America, abounding particularly on the lower parts of the Missouri, endures severe frosts much better than either of the preceding, and is therefore preferred for cultivation in some parts of Europe. Its fruit is deep red, and almost as pleasant as the Black Mulberry. The wood is much more valuable; being fine-grained, strong, and adapted even for ship-building. The tree attains a height of 60 feet or more.—The INDIAN M. (*M. Indica*) has black fruit of a delicate flavour, and the leaves are extensively used for feeding silk-worms in China, Cochin-China, and Bengal.—*M. atro-purpurea* has been introduced into India from China for feeding silk-worms. *M. Mauritiana*, a native of Madagascar and Mauritius; *M. celtidifolia* and *M. corylifolia*, Peruvian species; *M. Tatarica*, a native of Central Asia; *M. laevigata*, the species most common in the north of India; and *M. Cashmeriana*, a native of Cashmere, produce pleasant fruit. *M. dulcis*, a native of the north of India, is said to be superior in flavour to all others.

The PAPER M. (*Broussonetia papyrifera*) differs from the true mulberries in having the female flowers collected in a globular mass. The tree is of moderate size, or, in cultivation, a bush of 6–12 feet high; with leaves either simple or lobed, a native of India, Japan, and the islands of the Pacific Ocean, but now not uncommon in pleasure-grounds in Europe and North America. The islanders of the Pacific cultivate the Paper M. with great

care. They make a kind of clothing from the bark, using for this purpose the bark of small branches about an inch in diameter, which they macerate in water, and then scraping off the epidermis, press and beat the moist slips together. The paper also, which is used in Japan and many parts of the East, is in great part made from the bark of the young shoots of this plant, which for this purpose is boiled to a pulp, and treated somewhat in the same way as the pulp of rags in Europe. When the shoots are cut, new ones spring up very rapidly.—Silk-worms eat the leaves of the paper mulberry.—The fruit is oblong, of a dark-scarlet colour, sweetish, but insipid.

MULDER, GERARD JOHANNES, a distinguished living chemist, was born in 1802 at Utrecht, where his father was practising as a physician. After obtaining the degree of Doctor of Medicine at the university of his native town in 1825, he commenced the practice of his profession at Amsterdam, where he was appointed to teach botany, and subsequently chemistry, in the newly-established medical school of that city. In 1841, he was elected professor of chemistry at the university of Utrecht, in consequence of the ability he had displayed in various memoirs published in the Dutch scientific journals. He is best known to the general reader as the discoverer of Proteine (q. v.), which he maintains to be the main ingredient of albumen, fibrin, casein, &c.; but the existence of which as an independent chemical compound is at the present day not generally admitted. He is the author of numerous excellent works on physiological and agricultural chemistry, on the chemistry of wine and beer, on diet and nutrition, &c., which, in consequence of their being written in Dutch, are far less known in this country than they deserve. His *Chemistry of Vegetable and Animal Physiology* has been translated into English by Dr Fromberg, and his *Chemistry of Wine* by Dr Bence Jones.

MULE (Lat. *mulus*, supposed to be connected with Gr. *molos*, labour, and with Eng. *moi*), a hybrid animal, the offspring of the male ass and the mare, much used and valued in many parts of the world as a beast of burden. The ears are long; the head, croup, and tail resemble those of the ass rather than those of the horse; but in bulk and stature the M. approaches more nearly to the horse. The M. seems to excel both the ass and the horse in intelligence; it is remarkable for its powers of muscular endurance; and its sure-footedness particularly adapts it to mountainous countries. It has been common from very ancient times in many parts of the east; and is much used also in most of the countries around the Mediterranean Sea, and in the mountainous parts of South America. Great care is bestowed on the breeding of mules in Spain and Italy, and those of particular districts are highly esteemed. In ancient times the sons of kings rode on mules, and they were yoked in chariots. They are still used to draw the carriages of Italian cardinals and other ecclesiastical dignitaries. Both in Spain and in South America, mules employed to carry burdens are driven in troops, each preceded by an animal—in South America, usually an old mare—called the *madrina*, or god-mother, of the neck of which a little bell is attached, and the mules follow with the greatest docility. When troops mingle in their halting-places or elsewhere, they are readily separated, as they recognise at once the sound of their own bell. Mules are comparatively little used in Britain, although it is alleged that work is done at less expense by the employment of mules than by the employment of horses.

MULE-MÜLLER.

As in other hybrid animals generally, males are more numerous among mules than females; in the proportion, it is said, of two or three to one. There is no instance on record of offspring produced by two mules; but instances occur, although rarely, of their producing offspring with the horse and with the ass. The M. is very superior in size, strength, and beauty, to the hinny, the offspring of the male horse and the female ass.

MULE. See SPINNING.

MULHOUSE (Ger. *Mülhausen*), a town of France in the department of Haut-Rhin, 27 miles south of Colmar. Pop. 43,244. M. is built on a small island between the Ill and the Rhone and Rhine Canal, and is an important station on the Strasburg and Basel line of railway. It lies in a fertile, well-watered district, and ranks as one of the most active centres of French trade; while it is at the same time the seat of a tribunal of commerce, and of various mercantile and trade unions, which have exercised a beneficial influence on the industrial activity of the province. Its numerous manufactories produce superior woollen and fine cambric goods, excellent leather, morocco, and carpets; in addition to which, its printing and dye works for cotton, muslin, wool, and silk fabrics are almost unrivalled in regard to the delicacy of the colours, and elegance of the patterns employed. M. has extensive bleaching-works, and is noted for its cotton and woollen stocking manufactories, its breweries and distilleries, starch and straw works, and for its ironworks, in which locomotives and various forms of steam-engines are extensively manufactured. These products of manufacturing industry, together with corn, wine, and brandy, form the staple articles of its very extensive trade.

M. early acquired commercial importance, having been erected into a free imperial city by Rudolph of Hapsburg in 1273. By siding with some of the Swiss cantons in the 14th c., it was enabled to maintain a certain degree of neutrality in the feuds between the empire and France. In 1523, M. adopted the Reformed faith. It remained a part of the circle of the Upper Rhine till 1798, when it was incorporated with France.

MULL, after the Isle of Skye, the largest of the Inner Hebrides, belongs to the county of Argyll, and is washed on the W. and S. by the Atlantic, and bounded on the N.E. by the Sound of Mull. It is triangular in shape, hollowed on the west side by an inlet of the Atlantic, and is deeply indented by sea-lochs, of which the principal are Loch-na-Keal and Loch Screidan. Area about 237,000 statute acres, of which 12,470 are arable; pop. (1861), exclusive of the neighbouring islets, 6834. Its surface is for the most part occupied by mountains, generally rounded in outline, and rising in Ben More 3185 feet high. Of its fresh-water lakes, Loch Erisa and Loch Ba are the chief. Wood abounds in the north; but owing to the generally tame character of the mountains, the great stretches of moorland, and the absence of well-defined valleys, the scenery, with the exception of that on the coast, is uninteresting. The land under cultivation occurs chiefly on the shores and at the heads of the several lochs. The soil is unusually fertile; but the great humidity of the climate, and the frequency and violence of the gales, render it almost wholly unfit for agriculture. The land is principally laid out in stock-farms, and great numbers of cattle, sheep, and horses are reared and exported. Chief town, Tobermory (pop. 1564), in the north. The harbour of Tobermory is one of the best and safest in the Hebrides. A low-water pier is now (March 1864) almost completed here.

It will enable steamers to land in any state of the tide. The Sound of Mull, 20 miles long, by 2 miles in average breadth, separates the island from the mainland of Argyleshire on the north-east.

MÜLLER, JOHANN, historian of Switzerland, was born 3d January 1752, at Schaffhausen, where his father was clergyman and rector of the gymnasium. He studied at Göttingen under Heyne, Schlözer, Walch, and others. In 1772, he was appointed professor of Greek at Schaffhausen, and in the same year published his first work, *Bellum Cimbricum* (Zür. 1772). Already he had commenced to devote his leisure hours to the investigation of Swiss chronicles and documents. By the advice of his friend Bonstetten, he went to Geneva in 1774, where he became a private tutor; and also (1778) delivered a series of lectures on 'Universal History,' afterwards published in 24 volumes. In 1781, he was called to the Collegium Carolinum at Cassel, as professor of statistics, and a little earlier published the first volume of his great work, *Geschichte der Schweizer*. In 1786, he was appointed librarian and councillor of state to the Elector of Mainz; here he finished the 2d volume of his Swiss History; his *Darstellung des Fürstenbundes* (Leip. 1787); and *Briefe zweier Domherren* (Frankfurt, 1787). In 1792, he went to Vienna, where the Emperor Leopold gave him a situation in the privy council, and, in 1800, appointed him first imperial librarian. In 1804, he left Vienna for Berlin, where he wrote *Ueber die Geschichte Friedrich's I., Ueber den Untergang der Freiheit der Allen Völker, Versuch über die Zeitrechnungen der Vorwelt*, and an additional volume of his Swiss History. Introduced to Napoleon after the battle of Jena, he was appointed by him (1807), having been previously dismissed from the Prussian service, secretary of state in the new kingdom of Westphalia; but died at Cassel, 29th May 1809. M.'s *Sämmtliche Werke* were published, 27 vols. Stuttgart, 1810—1819; new edit. 40 vols. 1831—1835.

MÜLLER, KARL OTFRIED, one of the most genial, richly erudite, and industrious classical archaeologists of modern times, was born 28th August 1797, at Brieg, in Silesia. He was the son of a clergyman, and received a careful education. He studied at Breslau and Berlin. His taste for philological and archaeological studies was early developed. The first fruit of his learning was the publication of the *Aegineticorum Liber* (Berl. 1817), after which he soon received an appointment to the *Magdalenum* in Breslau, where his leisure hours were devoted to a grand attempt to analyse the whole circle of Greek myths. In 1819, he obtained an archaeological chair in Göttingen; and to thoroughly prepare himself for it, visited the collections in Germany, France, and England. His great design was to embrace the whole life of ancient Greece, its art, politics, industry, religion, in one warm and vivid conception—in a word, to cover the skeletons of antiquity with flesh, and to make the dry bones live. With this view, he lectured and wrote with a fine earnest animation, until the political troubles in Hanover made his position uncomfortable. He obtained permission to travel, and made tours in Greece and Italy, but unfortunately died of an intermittent fever at Athens, on 1st August 1840. M.'s literary and scholarly activity stretched over the whole field of Greek antiquity. We are indebted to him for many new and striking elucidations of the geography and topography, literature, grammar, mythology, manners and customs of the ancients. His work on the Dorians (*Die Dorier*, translated into English by Sir George Cornwall Lewis and Henry Tuffnell) forms the 2d and 3d

vols. of his *Geschichte Hellen. Stämme und Staaten* (new and improved ed. 3 vols. Bresl. 1844); his treatise *Ueber die Wohnsitze, Abstammung und ältere Geschichte des Macedon. Volks* (Berl. 1825); his *Etrusker* (2 vols. Bresl. 1828); and his maps of Greece, are works of the highest importance in the departments of ancient history and ethnology. His *Handbuch der Archäologie der Kunst* (Bresl. 1830, 3d ed. 1846; English by Leitch, London, 1850) is full of learning and of acute original observations. His *Prolegomenen zu einer wissenschaftlichen Mythologie* (Gött. 1825) led the way to a strictly historical explanation of the ancient myths. The work by which he is probably best known in England is his *History of the Literature of Ancient Greece* (Lond. 1840), undertaken at the request of the British 'Society for the Diffusion of Useful Knowledge.' M. died before finishing it; what he had finished was translated into English by Sir George Cornwall Lewis and Dr Donaldson, the latter of whom continued the work from where it left off—at the age of Alexander—down to the taking of Constantinople. The German original was published by M.'s brother (Bresl. 1841). He shewed himself also an acute and judicious critic in his editions of Varro, *De Lingua Latina*, Festus, *De Significatione Verborum*, &c. His contributions to periodicals, encyclopædias, &c., were likewise numerous and valuable.—MÜLLER, JULIUS, brother of the preceding, was born at Brieg, 10th April 1801, educated at Breslau, Göttingen, and Berlin, and after holding several offices, finally became a professor of theology at Halle. His best known work, *Die Christliche Lehre von der Sünde* (The Christian Doctrine of Sin; English, Edin. 1856), is considered by theological critics the most acute and profound treatise written in modern times on this mysterious subject.

MÜLLER, JOHANN, one of the most eminent physiologists of the present day, was born at Coblenz on 14th July 1801. He began to study with a view to orders in the Roman Catholic Church; but in 1819 he abandoned his theological studies, and devoted himself to medicine, taking, in 1822, the degree of Doctor of Medicine at Bonn. Whilst yet a student, he wrote for a prize the treatise *De Respiratione Fœtus* (Leip. 1823). He became, in 1824, a tutor; in 1826, an extraordinary, and in 1830, an ordinary professor of physiology and anatomy at Bonn; and in 1833, succeeded Rudolphi as professor of anatomy at Berlin. His physiological researches were most industriously prosecuted, and were rewarded by many discoveries, which obtained for him a high reputation in the scientific world. His works are numerous, and many of them occupied with particular topics in zoology and comparative anatomy. He died of apoplexy at Berlin, April 28, 1858. Among the most important are—*Zur vergleichenden Physiologie des Gesichtsinnens des Menschen und der Thiere* (Leip. 1826); *Grundriss der Vorlesungen über die Physiologie* (Bonn, 1827); *Grundriss der Vorlesungen über allgemeine Pathologie* (Bonn, 1829); *De Glandularum Secernentium Structura Penitiori earumque prima Formatione in Homine atque Animalibus* (Leip. 1830); *Ueber die organischen Nerven der erectilen männlichen Geschlechtsorgane, &c.* (Berlin, 1835); and *Handbuch der Physiologie des Menschen* (2 vols. 4th ed. Coblenz, 1851), 'Manual of the Physiology of Man,' which has been translated into French and English. He was also the author of a large number of dissertations on a variety of subjects connected with physiology, the most important of which have been separately published. His latest investigations, on infusoria, were published in 1860. The most eminent living physiologists of Germany received their training in his school.

MÜLLER, FRIEDRICH MAX (MAXIMILIAN), one of the most eminent living orientalists, was born at Dessau, in the duchy of Anhalt-Dessau, 6th December 1823. His father, Wilhelm Müller, distinguished not only for his worth as a man, and his extensive and thorough scholarship, but as one of the first German lyric poets, was librarian of the ducal library, but died prematurely, October 1827. M. received the elements of his education at Dessau, and then went to Leipzig, where, under Professor Hermann Brockhaus, he began the study of Sanscrit. This he soon chose as his special pursuit; and the first fruits of his labours appeared in a translation of the *Hitopadesa* (Leip. 1844). In 1844, he went to Berlin to study under Bopp and Schelling, and consult the Sanscrit MSS. to be found there. In Paris, whither he repaired in 1845, he began, at the instigation of Burnouf, to prepare for an edition of the Rig-Veda, with the commentary of Śāyanācārya. With this view, he came to England, June 1846, to examine the MSS. in the East India House, London, and the Bodleian Library at Oxford; and, on the recommendation of the late Professor H. H. Wilson, the East India Company commissioned him (1847) to edit the Rig-Veda at their expense. The first volume of this great undertaking, printed at the Oxford University press, appeared in 1849; and has been followed by a second in 1853, a third in 1856, and a fourth in 1863. In 1850, M. was appointed Deputy Taylorian Professor of Modern Languages at Oxford; in 1854, succeeded to the professorship; and in 1858, was elected a Fellow of All Souls. While pursuing his labours connected with the Rig-Veda, M. has published treatises on a variety of philological topics, which have done more to awaken in England a taste for the science of language in its modern sense (see GRAMMAR) than the labours of any other single scholar. As an expositor of the results, whether of his own or of other men's investigations, he stands almost unrivalled; and although upwards of twenty years old when he came to England, he writes English in a way that most natives have cause to envy. Inheriting the poetic imagination and fire of his father, he has at command such a felicity and splendour of illustration, that subjects dry and repulsive under ordinary treatment, become in his hands positively attractive. Among the works referred to, we may name a translation into German of Kālidāsa's *Megha-dūta* (König. 1847); *The Languages of the Seat of War in the East* (2d ed. Lond. 1855); *Comparative Mythology* (in the Oxford Essays for 1856); *History of Ancient Sanscrit Literature* (2d ed. Lond. 1860); *Lectures on The Science of Language*, delivered at the Royal Institution, London, in 1861; a second series, delivered in 1863, is announced.

MULLET (*Mugil*), a genus of acanthopterous fishes, the type of the family *Mugilidae*. In this family, the body is nearly cylindrical, the scales are large; there are two widely separated dorsal fins, the first of which has only four stiff sharp spines; the teeth are extremely fine; the gullet is closed by an extraordinary development of the pharyngeal bones, so that only soft and thin food can pass down it; a branch of the stomach forms a kind of gizzard. The best known of this family belong to the genus *Mugil*, of which there are many species. They have a small mouth, with a fold or crest in the under lip, which fits into a corresponding notch in the upper one. The COMMON M., or GRAY M. (*M. capito*), is found in the Mediterranean, and along the western shores of Europe, as far as the southern and south-eastern shores of England, but becomes rare further north. The Common M. is usually about fifteen inches in length, but

MULLET—MULREADY.

sometimes two feet. The colour is steel-gray on the back, with bluish and yellowish reflections; the belly silvery white; the flanks with six or eight longitudinal lines of rosy brown. It often ascends rivers, generally selecting soft or fat substances for food, and often seeking food by thrusting its mouth into the soft mud. It is most readily taken by a bait of the boiled entrails of fish, or cabbage boiled in broth. It is easily reared in ponds, and readily answers the call which usually summons it to be fed. It is highly esteemed for the table.—A very nearly allied species, also called GRAY M. (*M. cephalus*), a native of the Mediterranean, is distinguished by having the eyes half covered with an

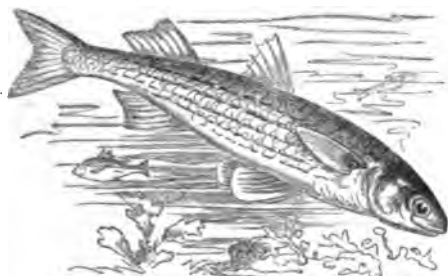

Common, or Gray Mullet (*Mugil capito*).

adipose membrane, and by a large triangular scale pointing backwards, just over the origin of each pectoral fin. It attains a larger size than the former species, sometimes ten or twelve pounds weight. It enters the mouths of rivers at certain seasons, and ascends into the fresh water. It is the most esteemed of all the mullets, and was in great request among the ancients. Enormous prices were given by the Romans for unusually large mullets, the price increasing, like that of diamonds, far more rapidly than the size. Mulletts are used fresh, salted, and smoke-dried. A preparation of their roe, called *Botarcha*, is in great esteem as a condiment in Italy and the south of France. Mulletts are often caught in the Mediterranean by angling from a rock, with a bait of paste, when they have been previously attracted to the spot by macaroni thrown into the water.—A third species of GRAY M. (*M. chelo*) is not unfrequent on the coasts of England, and even of Scotland. It is remarkable for its large fleshy lips. It swims in great shoals. In the Mediterranean, it sometimes attains the weight of eight pounds.—The AMERICAN M. (*M. albula*) is very like the Common M., but more slender, the tail large and forked. It abounds about the Bahama Islands, and extends far northwards. It is highly esteemed for the table.

The name M. is also given to the genus *Mullus* of the family *Percida*. See SURMULLET.

MULLET, or MOLLET, in Heraldry, is a charge in the form of a star, generally with five points,

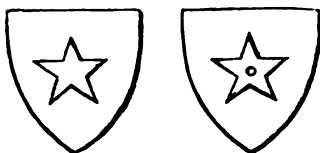

Mulletts.

intended to represent a spur-rowel, and of frequent occurrence from the earliest beginnings of coat-armour. Gwillim, Sir George Mackenzie, and

Nisbet lay it down that mulletts should always be pierced to represent the round hole in which the spur-rowel turns, but this has been by no means uniformly attended to in practice. Much confusion exists in blazonry between mulletts and stars; in England, the rule most generally adopted is, that the mullet has five points, whereas the star has six, unless any other number be specified. Nisbet lays down a canon nearly the converse of this, which has never been adhered to; and in Scottish heraldry the same figure seems to be often blazoned as a mullet or a star, according as it accompanies military or celestial figures. The mullet is the mark of cadency assigned to the third son, 'to incite him to chivalry.' The word mullet is occasionally used in heraldry for the fish so called.

MULLINGAR, chief town of the county of Westmeath, in Ireland, is situated on the great western road from Dublin to Galway, distant from the former, with which it is connected by the Royal Canal and the Midland Western Railway, 50 miles north-north-west. Its population, in 1861, was 5359, of whom 4336 were Roman Catholics, 392 Protestants of the established church, the rest members of other denominations. It is the centre of a poor-law union of 43 divisions, comprising an area of 208,401 acres. M. is a place of little historical interest, although its immunities date from the reign of Elizabeth. Its public buildings are in no way remarkable, but it possesses several schools; among the number, one recently endowed for general educational purposes. It is without manufactures, but has considerable celebrity as the site of several of the most important horse and cattle fairs in Ireland.

MULLION, the upright division between the lights of windows, screens, &c., in Gothic architecture. Mullions are rarely met with in Norman

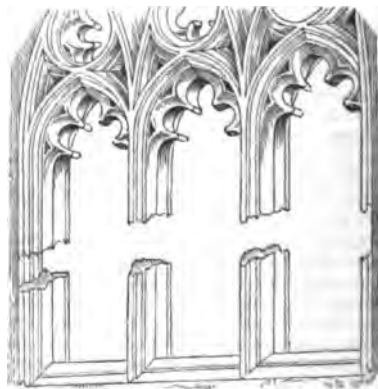

a a

Mullion :

Window from Carlisle Cathedral.

architecture, but they become more frequent in the Early English style, and in the Decorated and Perpendicular are very common. They have sometimes small shafts attached to them, which carry the tracery of the upper part of the window. In late domestic architecture, they are usually plain. The fig. shews mullions (a, a) supporting tracery.

MULREADY, WILLIAM, R.A. was born at Ennis, in Ireland, about the year 1786. When a boy, he went to London with his parents; at the age of fifteen, entered as a student in the Royal Academy, and made good progress, aiming at first at the classic style, or what, according to the

notions of the day, was called high art. Following the bent of his genius, however, he soon relinquished this course, and devoted himself to the study of nature and the works of those artists who attained high reputation in a less pretentious walk of art. His first pictures were landscapes of limited dimension and subject, views in Kensington gravel-pits, old houses at Lambeth, and interiors of cottages. He next essayed figure-subjects of incidents in every-day life, such as 'A Roadside Inn,' 'Horses Baiting,' the 'Barber's Shop,' and 'Punch' (painted in 1812), 'Boys Fishing' (1813), 'Idle Boys' (1815). M. was elected an Associate of the Royal Academy in November 1815, and an Academician in February 1816; a strong proof of the high estimation in which his talents were held by his brethren, for the higher dignity is rarely conferred till after a probation of several years as Associate. Even in his earliest time, his works were characterised by much elaboration; but those he executed about the middle period of his career exhibit an extraordinary amount of finish and greater brilliancy of colouring, qualities that he carried further and further as he advanced in years; and though he lived to a great age (he died on July 7, 1863), he continued to work with undiminished powers till within a day of his death. A great number of M.'s best works now belong to the public, as portions of the Vernon and Sheepshanks' collections. In the first-named, there are four pictures, one of these, 'The Last in, or Truant Boy,' exhibited in 1835, being one of the most elaborate works of his middle period; while in the Sheepshanks' collection there are no fewer than 28 of his works, among which, 'First Love,' exhibited in 1840, is a remarkable example of refinement in drawing, and delicacy of feeling and expression. 'The Sonnet,' exhibited in 1839, is perhaps his highest effort in point of style; and by 'The Butt—Shooting a Cherry,' exhibited in 1848, is best exemplified the remarkable minuteness of his finish and richness of his colouring. He occasionally executed designs for publishers. An edition of the *Vicar of Wakefield*, published in 1840, by Van Voorst, embellished with 20 wood-cuts from M.'s drawings, is generally acknowledged to be one of the finest works of the kind produced in this country. M. was buried in the cemetery, Kensal Green, privately; but a movement is at present on foot to do honour to his memory by a public testimonial.

MULTAN (or *Mooltan*), an ancient and important city of India, in the Punjab, on a mound consisting of the ruins of ancient cities that occupied the same site, three miles from the left bank of the Chenab—the inundations of which sometimes reach M.—and 200 miles south-west of Lahore. In 1859, a railway to Lahore and Amritsir, 230 miles in length, was commenced. The city is surrounded by a dilapidated wall, from 40 to 50 feet in height. The vicinity abounds in mosques, tombs, shrines, &c., attesting alike the antiquity and magnificence of the former cities; and the country around is remarkable for its fertility. M. is a military station, with a small redoubt in the rear of the cantonment. Its bazaars are numerous, extensive, and well stocked; and its shops, 6000 in number, are well supplied with European and Asiatic commodities. Manufactures of silks, cottons, shawls, scarfs, brocades, tissues, &c., are carried on, and there is an extensive banking trade. The merchants of M. are proverbially esteemed extremely rich. Steamers ply between this city and Hyderabad, a distance of 570 miles; and the new railway opens up a commercial outlet from Central Asia, the Punjab and the North-west Provinces, to the

Arabian Sea by Hyderabad and Karachi. In 1849, M. was taken by the British troops under General Whish, and annexed with its territory to the British possessions. Pop. 80,966, of whom 20,000 are Mohammedans.

MULTIPLE-POINDING is a well-known form of action in Scotland, by which competing claims to one and the same fund are set at rest. It means double poinding or double distress, suggesting that a person who has funds in his possession is liable to be harassed by double distress; and hence he commences a suit called the action of multiple-poinding, by which he alleges that he ought not to be made to pay the sum more than once; and as he does not know who is really entitled to payment, he cites all the parties claiming it, so that they may fight out their claims among themselves. The suit corresponds to what is known in England as a bill or order of interpleader.

MULTIPLICATION, the third and most important of the four principal processes of arithmetic, is a compendious mode of addition, when a number is to be added to itself a given number of times. The three terms of a multiplication are the *multiplicand*, or number to be multiplied; the *multiplier*, or number by which it is to be multiplied; and the *product*, giving the amount which would be obtained if the multiplicand were added to itself the number of times denoted by the multiplier. The symbol of multiplication is \times ; and in arithmetic, the numbers are placed above each other as in addition, with a line drawn under them; in algebra, the quantities are merely placed side by side, with or without a dot between them—e. g. the multiplication of 2 by 4 may be written 2×4 , and of a by b , $a \times b$, $a.b$, or ab . For multiplication of fractions, see FRACTIONS.

The operation of multiplication has been much abbreviated by the use of Logarithms (q. v.), and has been rendered a mere mechanical process, by the invention of Napier's Bones, the Sliding Rule, Gunter's Scale, &c.

MULTIVALVE SHELLS, or MULTIVALVES, are those shelly coverings of molluscs which are formed of more than two distinct pieces. In systems of Conchology (q. v.), the term is one of primary importance; but since the study of the living animals has led to arrangements very different from those founded on their mere shells, a very subordinate place has been assigned to it, as indicating a distinction much less important than was at first supposed. Thus, Chitons (q. v.), which have multivalve shells, are now placed in the same order of gasteropods with Limpets (q. v.), of which the shells are univalve; and *Pholus* (q. v.) and *Teredo* (q. v.), which have two principal valves and some small accessory valves, the latter also a long shelly tube, are placed among lamellibranchiate molluscs, along with most of the bivalves of conchologists. In conchological systems, barnacles and scorn-shells were also generally included, and ranked among multivalves; but these are now no longer referred even to the same division of the animal kingdom. See CIRRHOPODA.

MULTURES, in Scotch Law, mean a quantity of grain either manufactured or in kind deliverable to the proprietor or tacksman of a mill for grinding the corn sent there. Some persons living in the neighbourhood are bound to send their corn to be ground at a particular mill, in which case the lands are said to be astricted to the mill, and form the thirl or sucken, and the tenants or proprietors of the lands are called insucken multurers. Those who are not bound to go to the mill are called out-sucken multurers. Thirlage is thus classed among

servitudes, being a kind of burden on the lands. Such a right is unknown in England, except sometimes in old manors.

MUM, a peculiar kind of beer, formerly used in this country, and still used in Germany, especially in Brunswick, where it may be almost regarded as the national drink. Instead of only malt being used, it is made of malt and wheat, to which some brewers add oats and bean-meal. It is neither so wholesome nor so agreeable as the common ale or beer.

MUMMY. See **EMBALMING**.

MUMMY-WHEAT is said to be a variety of wheat produced from grains found in an Egyptian mummy. But no good evidence of this origin has been adduced—in fact, it is as good as proved to be impossible; and the same variety has long been in general cultivation in Egypt and neighbouring countries. The spike is compound—a distinguishing character, by which it is readily known, but which is not altogether permanent. It is occasionally cultivated in Britain, but seems more suitable to warmer regions.

MUMPS, THE, is a popular name of a specific inflammation of the salivary glands described by nosologists as *Cynanche Parotidea*, or *Parotitis*. In Scotland, it is frequently termed *The Branks*.

The disorder usually begins with a feeling of stiffness about the jaws, which is followed by pains, heat, and swelling beneath the ear. The swelling begins in the parotid, but the other salivary glands (q. v.) usually soon become implicated, so that the swelling extends along the neck towards the chin, thus giving the patient a deformed and somewhat grotesque appearance. One or both sides may be affected, and, in general, the disease appears first on one side and then on the other. There is seldom much fever. The inflammation is usually at its highest point in three or four days, after which it begins to decline, suppuration of the glands scarcely ever occurring. In most cases no treatment further than antiphlogistic regimen, due attention to the bowels, and protection of the parts from cold, by the application of flannel or cotton-wool, is required, and the patient completely recovers in eight or ten days.

The disease often originates from epidemic or endemic influences, but there can be no doubt that it spreads by contagion; and, like most contagious diseases, it seldom affects the same person twice. It chiefly attacks children and young persons.

A singular circumstance connected with the disease is, that in many cases the subsidence of the swelling is immediately followed by swelling and pain in the *testes* in the male sex, and in the *mamma* in the female. The inflammation in these glands is seldom very painful or long continued, but occasionally the inflammation is transferred from these organs to the brain, when a comparatively trifling disorder is converted into a most perilous disease.

MÜNCHHAUSEN, HIERONYMUS KARL FRIEDRICH, BARON VON, a member of an ancient and noble German family, who attained a remarkable celebrity by false and ridiculously exaggerated tales of his exploits and adventures, so that his name has become proverbial. He was born in 1720, at the family estate of Bodenwerder, in Hanover, served as a cavalry officer in the Russian campaigns against the Turks in 1737—1739, and died in 1797. A collection of his marvellous stories was first published in England under the title of *Baron Münchhausen's Narrative of his Marvellous Travels and Campaigns in Russia* (Lond. 1785). The compiler was one Rudolf Erich Raspe, an expatriated countryman of the baron's. A second edition appeared at

Oxford (1786) under the title of *The Singular Travels, Campaigns, Voyages, and Sporting Adventures of Baron Münchhausen, commonly pronounced Munchausen; as he relates them over a bottle when surrounded by his friends*. Several other editions rapidly followed. In the same year (1786) appeared the first German edition, edited by the poet Bürger; the latest—entitled *Des Freiherrn von Münchhausen, wunderbare Reisen und Abenteuer* (Gött. and Berl. 1849)—is enriched by an admirable introduction by Adolf Ellisen, on the origin and sources of the famous book, and on the kind of literary fiction to which it belongs. Ellisen's father knew the splendid old braggart in his latter days, and used to visit him. Nevertheless, although Raspe may have derived many of his narratives from M. himself, he appears to have drawn pretty largely from other sources. Several of the adventures ascribed to the baron are to be found in older books, particularly in Bebel's *Facetis* (Strasb. 1508); others in Castiglione's *Corregiano*, and Bildermann's *Utopia*, which are included in Lange's *Delicias Academicas* (Heilbronn, 1765). M.'s stories still retain their popularity, especially with the young.

MUNDANE EGG. In many heathen cosmogonies, the world (Lat. *mundus*) is represented as evolved from an egg. The production of a young animal from what neither resembles it in form nor in properties, seems to have been regarded as affording a good figure of the production of a well-ordered world out of chaos. Thus, in the Egyptian, Hindu, and Japanese systems, the Creator is represented as producing an egg, from which the world was produced. The same notion is found, in variously modified forms, in the religions of many of the ruder heathen nations. Sometimes a bird is represented as depositing the egg on the primordial waters. There are other modifications of this notion or belief in the classical and other mythologies, according to which the inhabitants of the world, or some of the gods, or the powers of good and evil, are represented as produced from eggs. The egg appears also in some mythological systems as the symbol of reproduction or renovation, as well as of creation. The Mundane Egg belonged to the ancient Phœnician system, and an egg is said to have been an object of worship.

MUNGO, ST, the popular name of St Kentigern, one of the three great missionaries of the Christian faith in Scotland. St Ninian (q. v.) converted the tribes of the south; St Columba (q. v.) was the apostle of the west and the north; St Kentigern restored or established the religion of the Welsh or British people, who held the country between the Clyde on the north, and the furthest boundaries of Cumberland on the south (see **BRETTS AND SCOTS**). He is said to have been the son of a British prince, Owen ab Urien Rheged, and of a British princess, Dwywnwen or Thenaw, the daughter of Llewddyn Lueddog of Dinas Eiddyn, or Edinburgh. He was born about the year 514, it is believed at Culross, on the Forth, the site of a monastery then ruled by St Serf, of whom St Kentigern became the favourite disciple. It is said, indeed, that he was so generally beloved by the monastic brethren, that his baptismal name of Kentigern or Cyndeyrn, signifying 'chief lord,' was exchanged in common speech for Mungo, signifying 'lovable' or 'dear friend.' Leaving Culross, he planted a monastery at a place then called Cathures, now known as Glasgow, and became the bishop of the kingdom of Cumbria (q. v.). The nation would seem to have been only partially converted, and the accession of a new king drove St Kentigern from the realm. He found refuge among the kindred

people of Wales, and there, upon the banks of another Clyde, he founded another monastery and a bishopric, which still bears the name of his disciple, St Asaph. Recalled to Glasgow by a new king, Rydderech or Roderick the Bountiful, Kentigern renewed his missionary labours, in which he was cheered by a visit from St Columba, and dying about the year 601, was buried where the cathedral of Glasgow now stands. His life has been often written. A fragment of a memoir, composed at the desire of Herbert, Bishop of Glasgow, between 1147 and 1164, has been printed by Mr Cosmo Innes in the *Registrum Episcopatus Glasguensis*. The longer life by Joceline of Furness, written about 1180, was published by Pinkerton in his *Vita Antiqua Sanctorum Scotiae*. It appeals to two still older lives. The fame of St Kentigern is attested by the many churches which still bear his name, as well in Scotland as in the north of England. The church of Crosthwaite, where Southey is buried, is dedicated to him. The miracles which he was believed to have wrought were so deeply rooted in the popular mind, that some of them sprung up again in the 18th c. to grace the legends of the Cameronian martyrs. Others are still commemorated by the armorial ensigns of the city of Glasgow—a hazel-tree whose frozen branches he kindled into a flame, a tame robin which he restored to life, a hand-bell which he brought from Rome, a salmon which rescued from the depths of the Clyde the lost ring of the frail queen of Cadyow. Nor is it St M. only whose memory survives at Glasgow; the parish church of 'St Enoch' commemorates his mother, St Thenaw; and it is not many years since a neighbouring spring, which still bears her name, ceased to be an object of occasional pilgrimage.

MUNI, a Sanscrit title, denoting a holy sage, and applied to a great number of distinguished personages, supposed to have acquired, by dint of austerities, more or less divine faculties.

MUNICH (Ger. *München*), the capital of Bavaria, is situated in 48° 8' N. lat., and 11° 35' E. long., in the midst of a barren and flat elevated plain, at a height of about 1700 feet above the level of the sea. Its population, including the military, was, in 1862, 148,201. M., which is also the principal city of the province of Upper Bavaria, lies on the left bank of the Isar, and consists, in addition to the old town, of five suburbs, and of the three contiguous districts of Au, Haidhausen, and Obergiesing. By the efforts of the late King Ludwig, who spent nearly 7,000,000 thalers on the improvements of the city, M. has been decorated with buildings of almost every style of architecture, and enriched with a larger and more valuable collection of art-treasures than any other city of Germany. It possesses 28 churches, of which all but two or three are Catholic, and of these, the most worthy of note are: the cathedral, which is the see for the archbishopric of Munich-Freising, built between 1468—1494, and remarkable for its two square towers, with their octagonal upper stories, capped by cupolas, and its 30 lofty and highly-decorated windows; the church of the Jesuits, or St Michael's, which contains a monument by Thorwaldsen to Eugene Beauharnais; the Theatiner Kirche, completed in 1767, and containing the burying-vaults of the royal family; the beautiful modern church of St Mariahilf, with its gorgeous painted glass and exquisite wood-carvings; the round church, or Basilica of St Boniface, with its dome resting on 64 monoliths of gray Tyrolean marble, and resplendent with gold, frescoes, and noble works of art; the cruciform-shaped Ludwig Kirche, embellished with Cornelius's fresco of the Last Judgment; and lastly, the Court Chapel of All

Saints, a perfect casket of art-treasures. Among the other numerous public buildings, a description of which would fill a volume, we can only briefly refer to a few of the more notable; as the theatre, the largest in Germany, and capable of accommodating 2400 spectators, erected in 1823; the post-office; the new palace, including the older royal residence, the treasury and chapel, antiquarian collections, &c.; and the Königsbau, designed by Klenze in imitation of the Pitti Palace, and built at a cost of 1,250,000 thalers, containing J. Schnorr's frescoes of the Nibelungen; the Banqueting Hall, rich in sculpture by Schwanthaler, and in grand fresco and other paintings. In the still incomplete suburb of Maximilian are situated the old Pinakothek, or picture-gallery, erected in 1836 by Klenze, containing 300,000 engravings, 9000 drawings, a collection of Etruscan remains, &c.; and immediately opposite to it, the new Pinakothek, completed in 1853, and devoted to the works of recent artists; the Glyptothek, with its twelve galleries of ancient sculpture, and its noble collection of the works of the great modern sculptors, as Canova, Thorwaldsen, Schadow, &c. Among the gates of M., the most beautiful are the Siegesthor ('The Gate of Victory'), designed after Constantine's triumphal arch in the Forum, and the Isarthor with its elaborate frescoes. In addition to these and many other buildings intended either solely for the adornment of the city, or to serve as depositories for works of art, M. possesses numerous scientific, literary, and benevolent institutions, alike remarkable for the architectural and artistic beauty of their external appearance, and the liberal spirit which characterises their internal organisation. The library, which is enriched by the biblical treasures of numerous suppressed monasteries, contains about 600,000 volumes, of which 13,000 are incunabula, with nearly 22,000 MSS. The university, with which that of Landshut was incorporated in 1826, and now known as the Ludwig-Maximilian University, comprises 5 faculties, with a staff of 60 ordinary, and 12 extraordinary professors, among whom are included such men as Liebig, Bischoff, Schelling, Jacobi, &c. In association with it are numerous medical and other schools, a library of 160,000 vols., and various museums and cabinets. M. has an ably-conducted observatory, supplied with first-rate instruments by Fraunhofer and Reichenbach; 3 gymnasia, 4 Latin, 1 normal, various military, professional, polytechnic, and parish schools, of which the majority are Catholic; institutions for the blind, deaf and dumb, and crippled, and for female orphans, besides numerous hospitals, asylums, infant schools, &c.; an academy of sciences; royal academies of painting, sculpture, music, &c.; a botanic garden, parks, public walks, and gardens, adorned with historic, patriotic, and other monuments, and designed for the celebration of annual and other national fairs and festivals; spacious cemeteries, &c. M. is mainly indebted to the ex-king, Ludwig I., for its celebrity as a seat of the fine arts, as the greater number of the buildings, for which it is now famed, were erected between 1820 and 1850, although, since the accession of the present king, Maximilian, in 1848, the progress of the embellishments of the city has been continued on an equally liberal scale. M. is somewhat behind many lesser towns of Germany in regard to literary advancement and freedom of speculation, while its industrial activity is also inferior to its state of high artistic development. It has, however, some eminently good iron, bronze, and bell foundries, and is famed for its lithographers and engravers, and its optical, mathematical, and mechanical instrument-makers, amongst whom Utzschneider, Fraunhofer,

MUNICH—MUNICIPAL ARCHITECTURE.

and Ertl have acquired a world-wide renown. *M.* is noted for its enormous breweries of *Bavarian beer*; and has some good manufactories for cotton, wool, and damask goods, wax-cloth, leather, paper-hangings, carriages, pianos, gold, silver, and steel wares, &c.

The present name of this city cannot be traced further than the 12th c., when Henry the Lion raised the *Villa Munichen* from its previous obscurity, by establishing a mint within its precincts, and making it the chief emporium for the salt which was obtained from Halle and the neighbouring districts. In the 13th c., the dukes of the Wittelsbach dynasty selected *M.* for their residence, built the Ludwigsburg, some parts of whose original structure still exist, and surrounded the town with walls and other fortified defences. In 1327, the old town was nearly destroyed by fire, and rebuilt by the Emperor Ludwig of Bavaria very much on the plan which it still exhibits; but it was not till the

close of last century, when the fortifications were razed to the ground, that the limits of the town were enlarged to any extent. The last fifty years indeed comprise the true history of *M.*, since within that period all its finest buildings have been erected, its character as a focus of artistic activity has been developed, its population has been more than doubled, and its material prosperity augmented in a proportionate degree.

MUNICIPAL ARCHITECTURE, the style of the buildings used for municipal purposes, such as town-halls, guild-halls, &c. These were first used when the towns of the middle ages rose in importance, and asserted their freedom. Those of North Italy and Belgium were the first to move, and consequently we find in these countries the earliest and most important specimens of municipal architecture during the middle ages. It is only in the 'free cities' of that epoch that town-halls are found. We therefore look for them in vain in France or

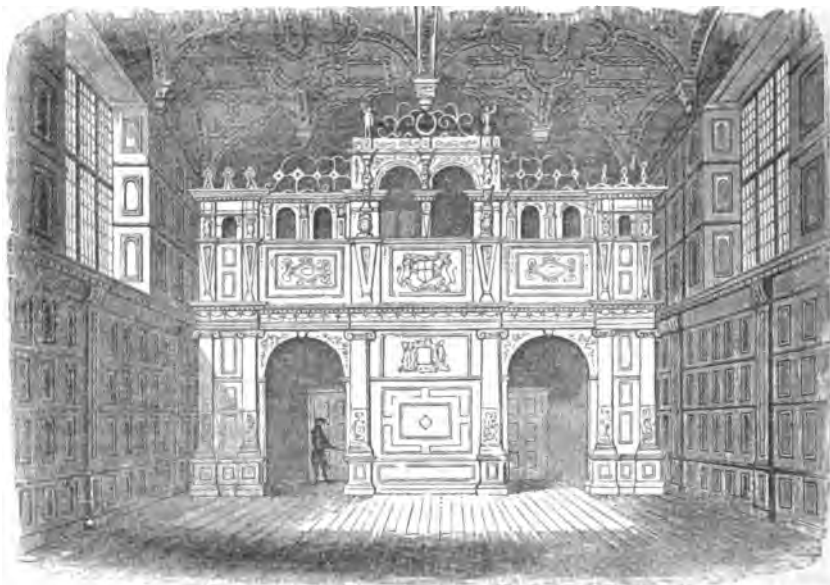

Leather-Sellers' Hall, London.

England till the development of industry and knowledge had made the citizens of the large towns so wealthy and important as to enable them to raise the municipal power into an institution. When this became the case in the 15th and 16th centuries, we find in these countries abundant instances of buildings erected for the use of the guilds and corporations and the municipal courts. Many of these still exist along with the corporate bodies they belong to, especially in London, where the halls are frequently of great magnificence. Many of these corporation halls have recently been rebuilt by the wealthy bodies they belong to, such as the Fish-mongers, Merchant Taylors, Goldsmiths, and other companies. Municipal buildings on a large scale for the use of the town councils and magistrates have also been recently erected in many of our large towns, which had quite outgrown their original modest buildings; and now no town of importance is complete without a great town-hall for the use of the inhabitants.

Municipal buildings always partake of the character of the architecture of the period when they

are erected; thus, we find in Italy that they are of the Italian-Gothic style in Como, Padua, Vicenza, Venice, Florence, &c., during the 13th, 14th, and 15th centuries. In Belgium, during the same period, they are of the northern Gothic style, and are almost the only really fine specimens of the civil architecture of the middle ages we possess. The Cloth-hall at Ypres, and the town-halls of Brussels, Louvain, Bruges, Oudenarde, &c., the Exchange at Antwerp, and many other markets, lodges, halls, &c., testify to the early importance of the municipal institutions in Belgium.

It is a curious fact, that in France, where the towns became of considerable importance during the middle ages, so few municipal buildings remain. This arises from the circumstance, that the resources of the early municipalities of France were devoted to aid the bishops in the erection of the great French cathedrals, and the townspeople used these cathedrals as their halls of assembly, and even for such purposes as masques and amusements.

Of the English corporation halls, those which remain are nearly all subsequent to the 14th c.,

MUNICIPALITY, MUNICIPAL CORPORATION.

from which time to the present there are very many examples. The Guild-hall of London is one of the earliest. The present building was begun in 1411, and was built chiefly by contributions from the trades 'companies' of London. Of the town-halls recently erected, those of Manchester, Liverpool, and Leeds are amongst the most important.

MUNICIPALITY, MUNICIPAL CORPORATION (from Lat. *municipes*, from *munus* and *capio*, one who enjoys the rights of a free citizen), a town or city possessed of certain privileges of local self-government; the governing body in such a town. Municipal institutions originated in the times of the Roman empire. The provincial towns of Italy, which were from the first Roman colonies, as also those which, after having an independent existence, became members of the Roman state, though subjected to the rule of an imperial governor, were allowed to enjoy a right of regulating their internal affairs. A class of the inhabitants called the *curia*, or *decuriones*, elected two officers, called *duumviri*, whose functions were supposed to be analogous to those of the consuls of the imperial city, and who exercised a limited jurisdiction, civil and criminal. There was an important functionary in every municipality called the *defensor civitatis*, or advocate for the city, the protector of the citizens against arbitrary acts on the part of the imperial governor. In the later ages of the empire, the Decurions were subject to heavy burdens, not compensated by the honour of the position, which led many to endeavour to shun the office. The municipal system declined with the decline of the empire, yet it retained vitality enough to be afterwards resuscitated in union with feudalism, and with the Saxon institutions of Britain. Some cities of Italy, France, and Germany have indeed derived their present magistracy by direct succession from the days of imperial Rome. This is notably the case with Cologne, where, up to the time of the first French Revolution, the two chief magistrates retained the title of *consuls*, wore the consular *toga*, and had their *lictors* in attendance, while the higher citizens were styled patricians, and the town banners bore the inscription S.P.Q.C. The Frankish conquerors seem frequently to have left the cities in possession of their municipal rights. The bishop being a shield between the conquerors and the conquered, in many cases discharged the duties or obtained the functions of the *defensor civitatis*. To the north of the Alps, under the feudal system, he became officially the civil governor of the city, as the count was of the rural district. In Southern Europe, where feudalism was less vigorous, the municipalities retained a large share of freedom and self-government.

Of the cities of the middle ages, some were entirely free; they had, like the provincial towns of Italy before the extension of the Roman conquests, a constitution independent of any other powers. Venice, Genoa, Florence, Hamburg, and Lübeck, all stood in this position. Next in dignity were the free imperial cities in Germany, which, not being comprehended in the dominions of any of the princes, were in immediate dependence on the empire. Most of these cities rose into importance in the 13th c.; and their liberties and privileges were fostered by the Franconian emperors, to afford some counterpoise to the growing power of the immediate nobility. Nürnberg was especially celebrated for its stout resistance to the House of Brandenburg, and the successful war which it waged with the Franconian nobility. In England, the more important cities were immediate vassals of the crown; the smaller municipalities sometimes owned a subject superior, sometimes a greater municipality for their overlord.

Under the Anglo-Saxons, the English burghs were subject to the rule of an elective officer, called the 'Portreve,' who exercised in burgh functions similar to those of the shire-reeve in the shire. The Norman conquerors recognised the already existing privileges of the towns by granting them charters. Instead of a shire-reeve, a viscount was placed by the king over each shire, and a bailiff instead of the former elective officer over each burgh. In the larger towns, the bailiff was allowed to assume the Norman appellation of Mayor. The municipal franchise seems to have been vested in all the resident and trading inhabitants, who shared in the payment of the local taxes, and performance of local duties. Titles to freedom were also recognised on the grounds of birth, apprenticeship, marriage, and sometimes free gift.

In all the larger towns, the trading population came to be divided into guilds or trading companies, through membership of which companies admission was obtained to the franchise. Eventually the whole community was enrolled in one or other of the guilds, each of which had its property, its by-laws, and its common hall, and the community elected the chief officers. It was on the wealthier and more influential inhabitants that municipal offices were generally conferred; and the practice gradually gained ground of these functionaries perpetuating their authority without appealing to the popular suffrage. Contentions and disputes arose regarding the right of election, and eventually the crown threw the weight of its influence into the scale of self-elective ruling bodies. As the greater municipalities grew in strength, we find their right recognised to appear in parliament by means of representatives. The sheriffs were considered to have a discretionary power to determine which towns should, and which should not have this privilege of representation. The sovereigns of the House of Tudor and Stuart acquired the habit of extending the right of parliamentary representation to burghs not in the enjoyment of it, while at the same time, by granting or renewing to them municipal charters, they modelled the constitution of these burghs to a self-elective type, and restricted the right of voting in the choice of a representative to the governing body. During the reign of William III., Anne, and the earlier Georges, the influence of the crown was largely employed in calling new municipal corporations into existence, with the view of creating additional parliamentary support for the ministry in power. The burghs of Scotland had a history much like that of the burghs of England; their earlier charters were mere recognitions of already existing rights, and were granted to the inhabitants at large. In the course of the 14th and 15th centuries, the municipal suffrage fell gradually more and more into the hands of restricted bodies of men, until act 1469, c. 5, gave to the councils the right of appointing their successors, the old and new council together electing the office-bearers of the corporation. This state of things continued till 1833, not without many and grievous complaints of corruption, mismanagement, extravagance, and peculation against the governing bodies. In the Scottish burghs, the several trades possessed a much more exclusive monopoly than in England. Along with the outcry for parliamentary reform arose an outcry for municipal reform; and a separate municipal reform act putting an end to the close system was passed for each part of the empire. The English act (5 and 6 Will. IV. c. 76), entitled 'An act to provide for the regulation of Municipal Corporations in England,' conferred the franchise on the owners and occupiers of property within burgh, with

certain qualifications as to property, residence, &c. This constituency elected the councillors, and from the body of the councillors the mayor and aldermen were chosen. The corresponding act for Scotland, passed two years earlier, was 3 and 4 Will. IV. c. 76: it changed the mode of election in burghs which already had a council, and conferred councils on burghs which had none. By the Scottish act, every one has a vote who has resided for six months in the burgh, or within seven miles of it, and who possesses the requisite qualification to vote in the election of a member of parliament. In such burghs as do not send a member to parliament, the same property qualification is required as confers the parliamentary franchise. The councillors are chosen from the electors residing or carrying on business within the burgh. Nine of the smallest burghs are excluded from the operation of the act. The English act abolished the exclusive privileges of the guilds, but these monopolies continued in Scotland till 1839, when they were swept away by another enactment (9 and 10 Vict. c. 17). The Irish municipal system, which had been imported ready-made from England, was assimilated to the altered English system by 3 and 4 Vict. c. 108. It has been doubted whether the change of system has practically tended to elevate the character of the municipal government of the towns in any of the three kingdoms to the extent which its promoters anticipated.

MUNIMENT-HOUSE, a strong fire-proof apartment or building suited to contain archives, papers, and other valuables.

MUNJEET (*Rubia cordifolia* or *munjista*), a species of Madder (q. v.), of which the root yields an excellent red dye. The plant differs from the common madder in its more distinctly quadrangular stem, its cordate-oblong leaves commonly in fours, and its red berries. It is a native of India, China, Japan, Central Asia, and Siberia. The root has long been used in India as affording a red dye; and is now an article of export to Europe, as a substitute for madder.

MUNSTER, the largest of the four provinces of Ireland, occupies the south-west, and is bounded on the N. by Connaught, on the E. by Leinster, and on the W. and S. by the Atlantic. It contains the six counties of Clare, Cork, Kerry, Limerick, Tipperary, and Waterford, and the country is described under these heads. Area, 6,064,579 statute acres. The population of the province, which in 1841 was higher than that of any of the other provinces, was shewn to be, in 1861, 1,503,200, or 407,208 less than that of Ulster, now the most populous of the provinces.

MUNSTER, chief town of the district of the same name, as well as capital of all Westphalia, is situated in 51° 55' N. lat., and 7° 40' E. long., at the confluence of the Aa with the Münster Canal, 65 miles north-east of Düsseldorf. Pop., including the military, at the close of 1861, 27,332. M., which is a bishopric, and the seat of a military council, a high court of appeal, and other governmental tribunals, is one of the handsomest towns of Westphalia, retaining numerous remains of mediæval architecture, whose quaint picturesqueness is enhanced by the numerous trees and shady allées, by which the squares and streets are ornamented. Among its 14 churches, of which the majority are Catholic, the most noteworthy are the cathedral, built between the 13th and 15th centuries, and despoiled of all its internal decorations by the Anabaptists; Our Lady's Church, with its noble tower; the splendid Gothic church of St Lambert, in the market-place, finished in the 13th c., on the tower

of which may still be seen the three iron cages in which the bodies of the Anabaptist leaders, John of Leyden, Knipperdolling, and Krechting, were suspended, after they had suffered the most horrible martyrdom; and the church dedicated to St Ludgerus, the first bishop of M., with its singular round tower, surmounted by an octagonal lantern. The Gothic town-hall possesses historical interest in being the spot at which, in 1648, the Peace of Westphalia was signed in a large hall, which has lately been restored, and which contains portraits of all the ambassadors who were parties to the treaty. The palace, built in 1767, is surrounded by fine pleasure-grounds, including horticultural and botanical gardens, connected with the academy; and these, with the ramparts, which, since the Seven Years' War, have been converted into public walks, form a great attraction to the city. M. is well provided with institutions of charity and benevolence. The old Catholic university of M. was dismembered in 1818, and its funds apportioned to other educational establishments; and the present academy, which comprises a Catholic theological and a philosophical faculty, is now the principal school. It has a library of 50,000 volumes, a natural history museum, and various collections of art and antiquity connected with it. M. has one gymnasium, a normal school for female teachers, and a number of town schools. The industrial products of M. include leather, woollen fabrics, thread, starch, and sugar, besides which there are good carriage manufactories, breweries, and distilleries. The trade is limited to the produce of the country, the principal of which are the noted Westphalian ham and sausages.

M. was known under the name of Mimigardevorde in the time of Charlemagne, who, in 791, appointed it as the see of the new bishop of the Saxons, St Ludgerus. Towards the middle of the 11th c., a monastery was founded on the spot, which in course of time derived its present name from its vicinity to the minster, or monastery. In the 12th c., the bishopric was elevated into a principality of the empire. In the 13th c., the city was incorporated in the Hanseatic League; and in 1532, it declared its adhesion to the Reformed faith, notwithstanding the violent opposition of the chapter. During the years 1535 and 1536, M. was the scene of the violent politico-religious movement of the Anabaptists, when the excesses of these pretended reformers worked a violent reaction in the minds of the people, which had the effect of restoring the prestige of the episcopal power; and although the citizens occasionally made good their attempted acts of opposition to their spiritual rulers, they were finally reduced to submission under Bishop Christopher Bernhard of St Gall, who having, in 1662, built a strong citadel within the city, transferred the episcopal place of residence thither from Koesfeld, where it had been established by earlier bishops. In the Seven Years' War, M. was repeatedly besieged and taken by both the belligerent parties. The bishopric of M., which since 1719 had been merged in the archbishopric of Cologne, although it retained a special form of government, was secularised in 1803, and divided among various royal houses; but subsequently shared in the common fate of other German provinces, and was for a time incorporated with France. The Congress of Vienna gave the greater part of the principality to Prussia, a small portion being apportioned to the House of Oldenburg, while Hanover acquired possession of the Münster territories of the mediatised Dukes of Aremberg.

MUNTJAK (*Cervus muntjac*, *Cervulus vaginalis*, or *Styllocerus muntjac*), a species of deer, abundant in Java, Sumatra, and other islands of the same region. It is about one-fifth larger than the

roebeek, which it considerably resembles in form. The horns are remarkable, as there springs from the common base of each an additional horn, which is about an inch and a half in length; the principal horn, which is simple, curved, and pointed, being about five inches in length. The female has no horns. The male has large canine teeth or tusks,



Muntjak (*Cervus muntjak*).

which also are wanting in the female.—Allied species are found in India and China.

MÜNZER, THOMAS, one of the leaders of the Anabaptists (q. v.), was born at Stolberg, in the Harz, took his degree at Wittenberg as Master of Arts, and for some time preached the doctrines of the Reformation in Zwickau and other places. Ere long, however, he adopted mystic views, and declaimed against what he called the 'servile, literal, and half' measures of the Reformers, requiring a radical reformation both in church and state according to his 'inward light.' He proclaimed an entire community of goods, and incited the populace to plunder the houses of the wealthy. Mühlhausen fell for a time under his sway, and that of another fanatic named Pfeifer, who joined him. He took an active part in the Peasant War, and inflamed the spirits of the insurgents by the wildest speeches and songs; but they were utterly defeated on 15th May 1525, after a severe conflict, at Frankenhausen, by the Elector John and Duke George of Saxony, the Landgrave of Hesse, and the Duke of Brunswick. M. fled, but was taken and carried to Mühlhausen, where he was beheaded along with Pfeifer and a number of others. He shewed no dignity or courage in the closing scenes of his life. See Strobel's *Leben Schriften und Lehren Thom. Münzer's* (Nürnb. 1795); Seidemann's *Thom. Münzer* (Dresd. and Leips. 1842); and Heinrich Leo in the *Evangelische Kirchenzeitung* (Berl. 1856).

MURÆNA, a genus of malacopterus fishes, of those to which the name Eel is commonly given, the whole of the eels being sometimes included in the family *Muraenida*. See EEL. The true *Muraena* have no fins, except the dorsal and anal, which are low and fleshy. They have one row of sharp teeth in each jaw. The head is very large, and the jaws are moved with great power. The M. of the Romans, or MURRY (*M. helena*), abounds in the Mediterranean, and is sometimes of large size, four feet or more in length, golden yellow in front, and purple towards the tail, beautifully banded and mottled. It is much thicker in proportion to its

length than any of the fresh-water eels. Its flesh is white and highly esteemed. It prefers salt-water,

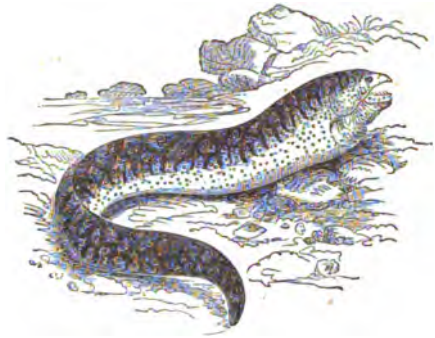

Muræna (*M. helena*).

but can accommodate itself to a fresh-water pond. The ancient Romans kept and fed it in vivaria. The story of Vedius Pollio feeding his murænas with offending slaves is well known. This M. has been caught on the British shores, but very rarely.

Allied to the genus M. is the genus *Sidera*, found in the Pacific.

MURAL CROWN, in Heraldry, a crown in the form of the top of a circular tower, masoned and embattled. It is meant to represent the crown which was given by the Romans as a mark of distinction to the soldier who first mounted the walls of a besieged town, and fixed there the standard of the army. A mural crown supporting the crest, in place of a wreath, occurs in the achievements of several of the English nobility, and in various grants of arms made in the early part of the present century to officers who had distinguished themselves in the war. Viscount Beresford, in consequence of his gallantry at the battle of Albuera, obtained as crest, issuing out of a mural crown, a dragon's head with its neck pierced through by a broken spear, the head of the spear point downwards being held in the mouth of the dragon.



Mural Crown.

MURAT, JOACHIM, king of Naples, was the son of an innkeeper at La Bastide-Fortunière, near Cahors, in France, and was born there 25th March 1767 or 1768. He was at first intended for the priesthood, and actually commenced the study of theology and canon law at Toulouse, but entered the army, and being threatened with punishment for insubordination, deserted, and after spending some time at home, proceeded to Paris, where, it is said, he was for some time a waiter at a café, but soon obtained admission into the Constitutional Guard of Louis XVI. On the outbreak of the Revolution, he was made a sub-lieutenant in a cavalry regiment. His gallantry and extreme republicanism soon won him the rank of colonel. He attached himself closely to Bonaparte, under whom he served in Italy and in Egypt, signalling himself in many battles; rose to the rank of a general of division (1799); returned with Bonaparte to France; and rendered him most important assistance on the 18th Brumaire, by dispersing the Council of Five Hundred at St Cloud. Bonaparte now intrusted him with the command of the Consular Guard, and gave him his youngest sister, Caroline, in marriage. M. commanded the cavalry at Marengo, where he greatly distinguished

himself. On the establishment of the French Empire, he was loaded with honours. He continued to command the cavalry in the armies led by the Emperor, and contributed not a little to the victory at Austerlitz, and to many other victories. In 1806, the newly-erected grand duchy of Berg (q. v.) was bestowed upon him. On 1st August 1808, he was proclaimed king of the Two Sicilies by the style of Joachim I. Napoleon. He took possession of Naples, but the Bourbons, through the support of Britain, retained Sicily.

M. possessed the qualities requisite for a general of cavalry rather than those of a king. He was very deficient in political skill and energy; but by the moderation of his government, he won the hearts of his subjects. Even his love of pomp and show, and the theatrical splendour of his equipment, which were a subject of mirth in France and Germany, rather gratified the Neapolitans. He endured with difficulty the yoke of Napoleon, which left him little but the outward show of royalty. In the expedition against Russia, he commanded the whole cavalry, but on its failure, he returned to Naples, anxious and disaffected. He joined the French army again in 1813, but after the battle of Leipzig, withdrew to his own dominions, determined on breaking the French fetters with which he was bound. He concluded a treaty with Austria, and a truce with the British admiral, and promised the allies an auxiliary corps. He hesitated, however, even after his new course seemed to have been decisively adopted; and finding his position insecure after Napoleon's overthrow, he entered into private communications with him at Elba. On the Emperor's return to France, M. placed himself at the head of an army of 40,000 men, and commenced a hasty war against Austria. He was defeated at Ferrara, 12th April 1815, and again at Tolentino, 2d May. With a few horsemen he fled to Naples, where all was insurrection and commotion; thence to the island of Ischia, and found his way to France, whilst his wife and children took refuge in the British fleet. After Napoleon's final overthrow, he found refuge in Corsica, from which he proceeded in a foolhardy manner with a few followers to the coast of Naples, and proclaimed himself king and liberator, but was presently taken prisoner, and after trial by a court-martial, was shot in a hall of the castle of Pizzo, on 13th October 1815. See Léonard Gallais, *Histoire de Joachim Murat* (Paris, 1828), and Coletta, *Histoire des Six derniers mois de la Vie de Joachim Murat* (Paris, 1821). His widow assumed the title of Countess of Lipona, and resided in the neighbourhood of Trieste, where she died in 1839. His two sons went to the United States, where the elder, NAPOLÉON ACHILLE MURAT, settled in Florida, and published a number of works on the constitution and politics of his adopted country. He died 15th April 1847. The younger, NAPOLÉON LUCIEN CHARLES, married an American lady in 1827, but suffered several reverses in fortune, and Madame Murat was obliged to open a boarding-school for the support of herself and her husband. Twice he attempted to return to France secretly (in 1837 and 1844), but failed on both occasions. The Revolution of 1848, however, opened the country to him. He attached himself closely to Prince Louis Napoleon; and was in 1849 French Ambassador Extraordinary to the court of Turin. In 1852 he was made a senator; and in 1853 he received the title of prince. The Italian revolution appeared to present some chances for him, but nothing came of these.

MURATORI, LUDOVICO ANTONIO, a celebrated antiquary and historian, was born at Vignola, in

the duchy of Modena, October 21, 1672. From a very early period, his predilection for historical and literary pursuits began to manifest itself; and, having entered into holy orders, without, however, accepting any ecclesiastical office, his life was devoted partly to the literature of his profession, but mainly to researches in history, both sacred and profane, especially the history of his native country. In his 22d year, he was appointed one of the librarians of the Ambrosian Library at Milan, a post which has since received equal celebrity from a successor not unworthy of the fame of M., the illustrious Angelo Mai (q. v.). Here he gave to the world his first publication, a collection of inedited Greek and Latin fragments, under the titles of *Anecdota Græca* and *Anecdota Latina*. But his most important labours were reserved for the capital of his native duchy, whither, in 1700, he was recalled by the Duke of Modena, to take charge of the celebrated D'Este Library, and of the ducal archives; his only ecclesiastical preferment being that of provost of the church of St Mary, at Pomposa. From the date of his return to Modena, M. began to devote himself more exclusively to Italian history, especially to the history of mediæval Italy; and his labours in this department extended over the greater part of his life. It was not until the year 1723 that the first volume of his great collection, *Rerum Italicarum Scriptores*, appeared, and the work proceeded at regular intervals for nearly thirty years, the last of the twenty-eight folio volumes which compose it bearing the date of 1751. This immense publication, which was produced by the joint contributions of the princes and higher nobility of Italy, embraces a range from the 5th to the 16th c., and contains all the chronicles of Italy during that vast period, illustrated with commentaries and critical notices. It was accompanied by a collection of dissertations illustrative of the religious, literary, social, political, military, and commercial relations of the several states of Italy during the period, in 6 vols. folio, 1738—1742, a work which, although far from being exempt from errors, is still regarded as a treasure-house of mediæval antiquities. While engaged in these prodigious labours, M. carried on an active literary correspondence with the scholars of the various countries of Europe, and contributed essays not unfrequently to the principal historical and literary academies, of most of which he was a member. He was the first, moreover, to undertake a general History of Italy from the commencement of the vulgar era down to his own time. It is in 12 vols. 4to, and still retains its value as a book of reference, having been continued by Coppi down to the year 1819. In his capacity of archivist of the Duke of Modena, he compiled, in two vols. folio, the *Antiquities of the d'Este Family* (1710—1740), as well as a series of historical and polemical treatises on certain territorial questions in dispute between the House of Modena and the court of Rome. To the department of classical scholarship, M.'s collection of *Inscriptions* (6 vols. folio, 1739—1743), which, in this point of view, was a necessary supplement to the collection of Gruter and the other antiquaries who had preceded him, is still acknowledged as a most important contribution; and he has also left works of standard merit in the departments of jurisprudence, of literary criticism, of poetry, of biography, and even of the history of medical science. In the studies of his own profession, as well liturgical and historical, as dogmatical and even acetical, M., although he did not follow the method of the schools, was hardly less distinguished than if he had made these the pursuit of his life. Some of his opinions were regarded with disfavour, if not directly condemned; but his

vindication of himself, addressed to the learned Pope Benedict XIV., drew forth a warm and honourable testimony to the uprightness of his motives, which, without approving of the opinions to which exception had been taken, declared them free from the imputation of being contrary either to the doctrine or to the discipline of the church. Although M.'s life was essentially that of a scholar, yet his exactness in discharging the duties of a parish priest was beyond all praise, and several of the existing charitable institutions of Pomposa were founded by him. He died at Modena, January 28, 1750, in his 78th year. His works, which it would be tedious to enumerate in full detail, fill 46 volumes in folio, 34 in 4to, 13 in 8vo, and many more in 12mo. Some of these are posthumous, and were published by his nephew, G. F. Muratori, from whom we also have a life of his distinguished uncle, in 4to, printed at Omer, 1758.

MURCHISON, SIR RODERICK IMPEY, geologist and geographer, was born at Tarradale, Ross-shire, in 1792. He was educated at the Grammar-school, Durham, and having a bias for military life, next studied at the Military College, Marlow. He entered the army at an early age, and served as an officer in the 36th Regiment in Spain and Portugal. He was placed on the staff of his uncle, General Sir Alexander Mackenzie, and then obtained a captaincy in the 6th Dragoons. Quitting the army in 1816, he devoted himself to science—more especially to geology. After five years' investigation, he established what he called the Silurian system (q. v.). He found the same sedimentary strata lying in the earth's crust beneath the old red sandstone in the mountainous regions of Norway and Sweden, in the vast and distant provinces of the Russian empire, and also in North and South America. He explored also several parts of Germany, Poland, and the Carpathians; and in 1846 he commenced a geological survey of the Russian empire, under the countenance of the imperial government. M. de Verneuil was associated with him in this great work. Upon the presentation of his first report, the Emperor Nicholas gave him a decoration and a colossal vase of Siberian aventurine, mounted on a column of porphyry, with a suitable inscription. After three years' additional labour, he completed his survey of Russia, which obtained for him the grand cross of the order of St Stanislaus, and the honour of British knighthood. He has frequently held the office of President of the Geological Society, and in his anniversary address in 1844, first predicted the discovery of gold in Australia. In 1846, six years before that metal was practically worked, he addressed a letter to the President of the Royal Geological Society of Cornwall, inciting the unemployed Cornish tin-miners to emigrate and dig for gold in Australia. In 1846, he was elected President of the British Association for the Advancement of Science, and in this year received the Copley medal of the Royal Society of London. He was elected President of the Royal Geographical Society in 1844 and 1845, was re-elected in 1857, and still holds this distinguished post. His anniversary addresses to the geographers are of great interest and value. Perhaps no man living has done more to promote geographical science at home, and kindle the spirit of adventure among the explorers of distant lands. In 1855, he succeeded Sir H. De la Beche in the office of Director of the Museum of Practical Geology. In 1857, he presided over the banquet to Dr Livingstone. He presents an annual report to parliament as Director-general of the Geological Survey and Government School of Mines. So laborious has been his

life, and so various have been his labours, that a mere list of his essays on geology, &c., would fill three or four pages. M. has also prepared and published sixteen geological maps. The greater portion of his contributions to science have been published in the *Transactions of the Geological Society*, *Edinburgh Philosophical Journal*, *London and Edinburgh Philosophical Magazine*, &c. He has also published volumes on the *Tertiary Deposits of Lower Styria, Austria, and Bavaria* (1830), the *Geology of Cheltenham* (1834), &c.

MURCHISON'IA, a genus of fossil gasteropodous mollusca belonging to the family *Habotida*, and so named in honour of Sir R. I. Murchison. The genus consists of at least 50 species, all which are characteristic of the Paleozoic rocks, occurring in the series from the Lower Silurian up to the Permian. The shell differs from the large genus *Pleurotomaria* only in being very much elongated. Like it, the whorls are sculptured and zoned, the aperture is channelled in front, and the outer lip is deeply notched.

MURCIA, a former province of Spain, now subdivided into the smaller provinces of Albacete and Murcia, is situated in the south-east of the peninsula. It is bounded on the N. by New Castile, on the E. by Valencia, on the S. by the Mediterranean, and on the W. by Granada, Andalusia, and New Castile. Area, 10,311 square miles. Pop. 552,037. In the north-east, the province is partly level; but in the south-west, it is composed of great valleys, high plateaus, and mountain ranges. The coast comprises stretches of desert. The principal river is the Segura, which flows through the middle of the province from west to east. On the whole, M. is not very productive, and never will be, on account of the failure of water, partly caused by the destruction of the forests. The only fertile districts are the valleys of the Segura, and the side-valleys of Lorca, Albacete, Chinchilla, and Almansa. The Esparto wastes have remained uncultivated since the banishment of the Moriscos in 1610; and the canal of M., which is intended to irrigate the arid Campo de Cartagena, is not yet finished. M. is one of the most thinly peopled districts of Spain. The north yields wheat and barley; the south, maize, fruits, wine, oil, silk, and hemp. Goats, sheep, and swine are reared in great numbers. In metals, salt, and mineral springs, M. is abundant; it has also many smelting-works for iron, lead, and copper ores, brimstone and alum. The roads, however, are in the most wretched condition, and industry in general is still in a backward state. The province was frightfully devastated by a great earthquake, 18—21 March 1829. M. was conquered by the Arabs in 711; after the fall of the califate of Cordova, it became an independent Arab kingdom, but, six years afterwards, was subjugated by King Ferdinand III. of Castile in 1241.

MURCIA (the Roman *Murgi*), a large, important, and ancient town of Spain, capital of the province of the same name, on the left bank of the Segura, and near the junction of that river with the Sangonera, 50 miles south-west of Alicante. It stands in the midst of a beautiful and luxuriantly productive *huerta* or garden, 16 miles in length, and from 7 to 8 miles wide. This *huerta* forms a portion of what is called the vale of M.; is well watered, has a bright green appearance even in winter; produces wheat, flax, pulse, and vegetables, and grows innumerable mulberry, orange, fig, and palm trees. The streets of M. are narrow but clean, and the houses are gaudily painted in pink and yellow. Its squares are filled with cypress, orange, lemon, and other southern trees. It is the see of a bishop

suffragan to Toledo; the cathedral is surmounted by a tower begun in 1522, completed in 1766, and crowned by a dome from which a magnificent view is obtained. The city contains few objects of fine art, a circumstance which is accounted for by the fact that, on the occasion of its siege by Sebastiani, that general, after promising that persons and property should be respected, entered the town 23d April 1810, and rifled it of its wealth and art-treasures. Silks, linens, baskets, mats, and cordage are manufactured, and oil-mills, tanneries, and other works are in operation. Pop. 109,446.

MURDER is the crime of killing a human being of malice aforethought, and is punishable with death. It is immaterial what means are employed to effect the object. Blackstone says that the name of murder, as a crime, was anciently applied only to the secret killing of another, which the word *moerda* signifies in the Teutonic language. And among the ancient Goths in Sweden and Denmark, the whole vill or neighbourhood was punished for the crime, if the murderer was not discovered. Murder is defined by Coke thus: 'When a person of sound memory and discretion unlawfully killeth any reasonable creature in being, and under the king's peace, with malice aforethought, either express or implied.' Almost every word in this definition has been the subject of discussion in the numerous cases that have occurred in the law-courts. The murderer must be of sound memory or discretion; i. e., he must be at least 14 years of age, and not a lunatic or idiot. The act must be done unlawfully, i. e., it must not be in self-defence, or from other justifiable cause. The person killed must be a reasonable creature, and hence killing a child in the womb is not murder, but is punishable in another way (see **INFANTICIDE**). The essential thing in murder is that it be done maliciously and deliberately; and hence, in cases of hot blood and scuffling, the offence is generally manslaughter only. Killing by duelling is thus murder, for it is deliberate. It is not necessary, in order to constitute murder, that the murderer kill the man he intended, provided he had a deliberate design to murder some one. Thus, if one shoots at A, and misses him, but kills B, this is murder, because of the previous felonious intent, which the law transfers from one to the other. So if one lays poison for A, and B, against whom the poisoner had no felonious intent, takes it, and is killed, this is murder. Formerly, in England, the Benefit of Clergy (q. v.) was allowed in cases of murder, till it was abolished by 7 and 8 Geo. IV. c. 28. The only sentence on murderers is now death, which is carried out by hanging. Formerly, the murderer was directed after death to be hung on a gibbet in chains near the place of the crime. Formerly, also, dissection was added as part of the sentence, and the execution was to take place on the day next but one after sentence. But now an interval of a fortnight usually takes place, and the body is buried in the precincts of the prison. Attempts to murder were until recently punishable in England like capital felony; but now attempts to murder are punishable only with penal servitude for life, or for not less than three years.

MUREX, a Linnæan genus of gasteropodous molluscs, of which has now been formed the family *Muricidæ*, belonging to the order *Pectinibranchiata* of Cuvier. The sexes are distinct; the animal has a broad foot, often much expanded; the eyes are not on stalks; the shell has a straight canal in front, often prolonged through part of a very long beak; no canal behind. The *Muricidæ* all prey on other molluscs, boring through the shells with their hard-toothed proboscis. The name **ROCK-SHELL** is often given

to many species of *M.*; and some, from the length of the beak, are called **WOODCOCK-SHELL**. Some have the shell beset with long and regularly arranged spines. The whorls of the shell are marked with ridges, or *varices*. Some species of *M.* are found on the British coasts. Species are found in all parts of



Woodcock-Shell (*Murex tenuispina*).

the world; the largest are tropical. The ancients obtained their purple dye (see **TYRIAN PURPLE**) from species of *M.*, particularly *M. trunculus* and *M. brandaris*. The **VENUS COMB** of the Indian seas is *M. tribulus*, a very delicate and beautiful shell, with many long thin spines. Fossil *Muricidæ* are numerous, but are scarcely found in any formation older than the eocene tertiary.

MUREXIDE, Purpurate of Ammonia, or Roman Purple, a curious colouring matter obtained from guano. It is similar to the purple dye or Tyrian purple of the ancients, which was made from a species of *Murex*—hence its name. Murexide is a product of uric acid, and as this exists in abundance, and in a very free state, in guano, that material has been found one of the best sources from which to obtain it. One process used by Mr Rumney of Manchester, the chief manufacturer of this material, to produce murexide, is to dissolve uric acid in dilute nitric acid, and after evaporating for some time at a temperature a little short of boiling, whilst still hot, to add a slight excess of ammonia. Two compounds are formed by this process, Alloxau and Alloxantin, and their mutual reaction on each other results in the formation of the beautiful minute green metallic-lustred crystals of murexide, which, in combination with some of the compounds of lead and mercury, yield most brilliant red and purple dyes. The use of murexide was becoming extensive until the discovery of the aniline colours, the greater brilliancy of which has checked its employment. Murexide is used in printing both cotton and silk goods, which, under the name of the 'Roman-purple style,' has been brought to great perfection by several large firms.

MURIA'TIC ACID. See **HYDROCHLORIC ACID**.

MURIDÆ, a family of rodent quadrupeds, containing many genera and a very large number of species, distributed over all parts of the world, and of which rats and mice may be regarded as typical examples. To this family belong also voles, lemmings, dormice, jerboas, marmots, &c. The *M.* are of the section of rodents having distinct clavicles. They have three or four molars on each side in each jaw, the molars at first furnished with rounded tubercles, which wear down till they exhibit mere roughened crowns. The typical *M.*, and those most nearly allied to them, have scaly tails. Marmots, dormice, jerboas, &c., have hairy tails. There are great diversities of structure and habits among the *Muridæ*. All of them feed on vegetable food, but many of them are ready also to eat animal substances.—The limits of the family *M.* are very differently stated by different naturalists.

MURILLO, BARTHOLOMÉ ESTÉBAN, was born at Seville, and baptized Jan. 1, 1618; and after receiving some education, was placed with his relative, Juan del Castillo, to study painting. Having saved a little money, which he made by painting religious pictures for exportation to South America, he went to Madrid in 1641, being then in his 24th year, was favourably noticed by his celebrated townsman, Velasquez, and through his influence, was enabled to study the *chef-d'œuvre* of Italian and Flemish art in the royal collections. In 1645, he determined to return to Seville, though advised to proceed to Rome by Velasquez, who offered him letters from the king. After settling in Seville, he received numerous important commissions, and was soon acknowledged as the head of the school there. In 1648, M. married a lady of fortune; he now maintained a handsome establishment, and his house was the resort of people of taste and fashion. The Academy of Seville was founded by him in 1660, but he filled the office of president only during the first year. He fell from a scaffold when painting in Cadiz on an altar-piece for the Church of the Capuchins, returned to Seville, and soon after died from the injury he received, April 3, 1682. In early life, he painted many pictures illustrative of humble life; in these, the manner was darker and less refined than that exhibited in his later pictures, which are mostly scriptural or religious pieces. In the Louvre, and in England, there are about forty of his works. Sir David Wilkie, who greatly admired and carefully studied the Spanish school, has remarked, in reference to it: 'Velasquez and Murillo are preferred, and preferred with reason, to all the others, as the most original and characteristic of their school. These two great painters are remarkable for having lived in the same time, in the same school, painted for the same people, and of the same age, and yet to have formed two styles so different and opposite, that the most unlearned can scarcely mistake them; Murillo being all softness, while Velasquez is all sparkle and vivacity.'

MURO'M, or MOOROM, a town in the south-east of the government of Vladimir, in European Russia, 70 miles east-south-east of Vladimir, and situated on the right bank of the Oka, a tributary of the Volga. Pop. (1859) 10,328. The chief industrial establishments are tanneries and sail-cloth and linen factories. The fisheries on the Oka supply the surrounding country. M. is also noted for its orchards and kitchen-gardens, the latter of which supply a great portion of Russia with cucumber-seed of the first quality. Gypsum quarries in the neighbourhood are extensively worked during winter, and their produce is transmitted by water to Moscow and St Petersburg. M. has a very picturesque appearance, and was formerly surrounded by impenetrable forests. It is frequently mentioned in the old national ballads, and is one of the most ancient towns of Russia.

MURRAIN is the generic term loosely used to designate a variety of diseases of domestic animals, but more correctly restricted to the vesicular epizootic, popularly known as the mouth and foot disease. It is a contagious eruptive fever, affecting cattle, sheep, pigs, and poultry; but rarely communicable to horses or men. It is characterised by the appearance of little bladders or vesicles in the mouth, on the lips, gums, and tongue; on the udder, and in the interdigital space; causing inability to eat, and drivelling of saliva, heat and swelling of the udder, and lameness. The disorder runs a fixed and definite course usually in eight or ten days. Good nursing, comfortable lodgings, and

a liberal supply of soft, easily digestible food, are the chief requisites for speedy recovery. A laxative may be given if needed. The mouth may be washed out twice daily with a mild astringent solution, which may be made with half an ounce of alum, oxide of zinc, or sugar of lead, to the quart of water. The udder in milch cows, in which the complaint is usually most serious, should be bathed with tepid water before and after milking, which must be attended to very regularly; and the feet kept clean, and washed occasionally with the lotion used for the mouth.

MURRAY, or MORAY, JAMES STEWART, EARL OF, sometimes called the 'Good Regent,' was the natural son of James V. of Scotland, by Margaret, daughter of John, fourth Lord Erskine, afterwards wife of Sir Robert Douglas of Lochleven. He was born about 1531, made Commendator of the priory of St Andrews in 1538, and subsequently of the priory of Mâcon (in France). He joined the Reformers in 1556, and almost immediately became the chief of the Protestant party in Scotland. In 1561, he was sent to France, to invite Queen Mary to return to her kingdom; and on her arrival, he became her prime minister and adviser. In February 1562, he was created Earl of Mar; but that earldom having been claimed by Lord Erskine, the title of Earl of Moray was conferred upon him instead a few months afterwards. Strongly opposed to the marriage of Mary with Lord Darnley, 29th July 1565, he endeavoured to oppose it by an appeal to arms; but he was easily put to flight by the queen, and obliged to take refuge in England. He did not return to Edinburgh till the 10th March 1566, the day after the assassination of Rizzio, in which he was an accomplice. In April 1567, he went to France, but was recalled in August of the same year by the lords in arms against the queen, when he found Mary a prisoner in Lochleven, and himself appointed regent of the kingdom. After the escape of the queen, he defeated her forces, May 13, 1568, at Langside, near Glasgow, and was afterwards one of the commissioners sent to England to conduct the negotiations against her. By his prompt and vigorous measures, zeal, and prudence, he succeeded in securing the peace of the kingdom, and settling the affairs of the church, but was assassinated at Linlithgow by Hamilton of Bothwellhaugh, January 21, 1570.

MURRAY, JOHN, the name of three generations of English publishers, will for ever remain associated with the palmiest days of English literature in the 18th and 19th centuries. The founder of the house, John M'Murray, was born in Edinburgh about 1745. He obtained a commission in the Royal Marines in 1762, and in 1768 was still second-lieutenant, when, disgusted with the slowness of promotion, and panting for a more active career, he purchased the bookselling business of Mr Sandby, opposite St Dunstan's Church, London; and, dropping the Scottish prefix, became a bookseller and publisher at '32 Fleet Street.' He brought out the *English Review*, and published the elder Disraeli's *Curiosities of Literature*, &c. He could himself wield the pen, as some pamphlets remain to testify. He died November 16, 1793, and was succeeded in due time by his son JOHN, who was left a minor of fifteen at his father's death. One of the earliest hits of John the second was Mrs Rundell's Cookery-book, which proved to be a mine of wealth—more productive, perhaps, than *Childe Harold* itself. He became connected with Thomas Campbell and Sir Walter Scott, and in 1808—1809, projected the *Quarterly Review*, a Tory organ, in opposition to the Whig *Edinburgh Review*, then in

the height of its influence. The first number was published February 1, 1809, under the editorship of William Gifford. The new periodical was completely successful, and brought M. into communication not only with the chief literati, but also with the Conservative statesmen of the time. A still more fortunate acquaintance was that with Lord Byron, whose *Child Harold* was published by M. in 1812. M. now removed from Fleet Street to Albemarle Street, where the business is still carried on. Here Byron and Scott first met, and here Southey made the acquaintance of Crabbe. Almost all the literary magnates of the day were 'four o'clock visitors' in Albemarle Street. Byron's pleasant verse has described the scene:

'The room's so full of wits and brads,
Crabbe, Campbells, Crokers, Freres, and Wards.'

M.'s dinner-parties included politicians and statesmen, as well as authors, artists, and dilettanti. M. paid Byron nearly £20,000 for his works, and his dealings with Crabbe, Moore, Campbell, and Irving were princely. The second John M. died in his 65th year, in 1843, and was succeeded by his son, JOHN M. the third. Born in 1808, he was educated first at the Charter House, and afterwards at Edinburgh University. The age of Byron had gone by, when, in 1843, he succeeded to the business of his father and grandfather. A more practical and realistic age had succeeded, and the 'Home and Colonial Library,' issued to beat off foreign and American piracies, was the precursor of the cheap railway and other literature of the present day. A lively and vigorous competition, arising out of the wants of a new era, has somewhat altered the relation of the great publishing houses. That of Albemarle Street no longer ranks first in the extent and variety of its transactions, but many of the greatest works in history, biography, travel, art, and science have issued from the Albemarle Street press under the regime of the third Murray. Among his later successes may be mentioned Dr Livingstone's *Travels*, Smiles's *Life of George Stephenson*, and Charles Darwin's *Origin of Species by Natural Selection*. His handbooks of continental travel have lately been supplemented by handbooks of English counties, and these, it is understood, owe much to the personal assistance and superintendence of the present head of the famous house of Murray.

MURRAY, LINDLEY, an English grammarian, was born at Swatara, Lancaster County, Pennsylvania, U.S., in 1745. He was educated at an academy of the Society of Friends, and, on his father's removal to New York, was placed in a counting-house, from which he escaped to a school in New Jersey. He then studied law, and was admitted to the bar at the age of 21, and commenced a good practice. During the revolutionary war, he engaged in mercantile pursuits with such success as to accumulate a handsome fortune. His health failing, he came to England and purchased the estate of Holdgate, near York, where he devoted himself to literary pursuits. In 1787, he published his *Power of Religion on the Mind*, which passed through seventeen editions. His *Grammar of the English Language* was issued in 1795, and was followed by *English Exercises*, the *Key*, the *English Reader*, *Introduction and Sequel*, and a *Spelling Book*. There can be no stronger indication how entirely the systematic study of the English language was—until recent years—neglected by scholars, than the fact that M.'s Grammar was for half a century the standard text-book throughout Britain and America. M. wrote an autobiography to the year 1809, which was published after his death, February 16, 1826.

MURRAY RIVER, the principal river of South Australia. See AUSTRALIA.

MURSHEDABAD, a town of India, capital of a British district of the same name, is situated on the left bank of the Bhagrati, a branch of the Ganges, about 124 miles north of Calcutta. On the opposite side of the river stands Mahinagar, usually reckoned a part of Murshedabad. The town occupies a great space, being several miles both in length and breadth, but the buildings are for the most part of mud. It contains two palaces: the one, old and gloomy; the other, constructed after the European style, and of great beauty, was completed in 1840. Situated on the most frequented route by water from Calcutta to the North-West Provinces, the trade of M. is important. Formerly, it was the capital of Bengal, and so wealthy, that Clive compared it with London. Pop. about 150,000, of whom upwards of 90,000 are Hindus, and nearly 60,000 Mohammedans.

MURVIEDRO, a small town of Spain, in the province of Valencia, and 18 miles north-north-east of the city of that name, on the left bank of the Palancia, and two miles from its mouth. Pop. about 5000. It stands on the site of the ancient Saguntum (q. v.).

MURZUK. See FEZZAN.

MUSA'CEÆ, a natural order of endogenous plants, the largest of herbaceous plants, generally destitute or almost destitute of true stems, yet resembling trees in appearance, and sometimes rivalling palms in stateliness; the long sheathing bases of the leaf-stalks combining to form a false stem. The blade of the leaf has many fine parallel veins proceeding from the midrib in the margin. The flowers are congregated on spadices, which are protected by spathe. The fruit is either a 3-valved capsule or fleshy.—The species are not numerous; they are natives of warm climates, in which they are widely distributed, and are of great value to the inhabitants of tropical countries; the fruit of some, particularly of the genus *Musa*, being much used for food, whilst the fibres of the leaves are employed for cordage and for textile purposes. See PLANTAIN, BANANA, and ABACA. A very interesting plant of the order M. is the TRAVELLER'S TREE (q. v.) of Madagascar.

MUSAUS, JOHANN KARL AUGUST, a German writer, born in 1737 at Jena, where he studied theology, was nominated to a country church, but prevented from entering upon the cure committed to him in consequence of the opposition of the peasantry of the parish, who refused to receive him on the ground that he had been once seen to dance. In 1763, he received the appointment of tutor to the pages at the ducal court, and in 1770 he became professor at the Weimar gymnasium. His first literary production, which appeared in 1760, was a parody of Richardson's *Sir Charles Grandison*, which was at that time extravagantly admired in Germany. The success of this satirical squib was complete; but as literary fame did not bring with it a corresponding amount of pecuniary reward, M. was compelled to gain his living by other means than writing; and an interval of more than eighteen years elapsed before he found leisure to reappear as an author. In 1778, he published his *Physiognomischen Reisen*, in which he endeavoured, by a good-natured yet striking satire, to counteract the absurd uses to which the Germans of his day had turned Lavater's system. This, like his previous work, was pre-eminently successful, and encouraged by the marks of popular favour with which it was received, he laid aside his incognito, and continued to devote himself to authorship. In 1782, appeared

his charming version of German folk-lore, under the title of *Volkmärchen der Deutschen*, which professed to be merely a collection of popular tales noted down from the lips of illiterate old country people; but these tales were tintured with such a blending of genial humour, quaint fancy, and strong sense, that they have become a classical work of their kind, popular among persons of every age and class. His satirical sketches, entitled *Freund Heins Erscheinungen in Holbein's Manier* (Winterthur, 1785), maintained his reputation as one of the sprightliest and most genial satirists of his country. Under the name of Schellenberg, he began a course of tales, *Straussfedern* (Berl. 1787), which, however, he did not live to complete. He died in 1787. His *Moralische Kinderklapper* appeared the year after his death, while his other posthumous writings were edited in 1791, with an interesting notice of the author, by his relative and pupil, A. V. Kotzebue. M.'s style was at once correct and elegant, adapting itself with singular flexibility to the various subjects which he handled; while the unaffected geniality and frank loving nature which are reflected in all he wrote, have deservedly made him one of the most popular writers of his day in Germany.

MUSÆUS, one of the ancient Greek poets of the mythic period, is said to have been the son of Eumolpus and Selene; according to others, the son and pupil of Orpheus. To him was ascribed the introduction of the Eleusinian and other mysteries into Greece, and the ordering of many religious rites. He was among the ancients also the reputed author of a number of poems, oracles, purificatory verses, a war of the Titans, a theogony, hymns, &c.; but of the few verses which remain the authenticity is very doubtful.—A later **MUSÆUS**, who probably flourished about the end of the sixth c. of the Christian era, was the author of a very pleasing amatory poem, in Greek, entitled *Hero and Leander*, discovered in the 13th c., of which the first edition was published by Aldus Manutius about 1494, and of which there have been many subsequent editions.

MUSCÆ VOLITANTES is the term applied to ocular spectra, which appear like flies on the wing, or floating black spots before the eyes. There are two kinds of muscæ volitantes—the one a perfectly harmless kind, while the other is symptomatic of one of the most serious diseases of the eyes, viz., amaurosis.

Whoever will look through a minute pin-hole in a card at the clear sky may see floating before his sight a number of translucent tubes or fibres, and many little beads, of which some are separate, some attached to the tubes, and some apparently within them. Some of the tubes or fibres are straight, others looped or twisted, and others again forked. All these objects are bright in the middle, and bounded by fine black lines, beyond and parallel to which may be seen an appearance of coloured lines or fringes. The doublings and crossings of the loops or knots in the twisted fibres appear as black points. Though the eye be fixed, these bodies change their position with greater or less rapidity. Now, in ordinary light and vision all these objects are imperceptible, unless the knots or fibres happen to be larger than usual, when they constitute the harmless kind of muscæ volitantes. The black lines and fringes are phenomena of the inflexion or diffraction (q. v.) of light, which are never seen except in divergent rays, and all muscæ volitantes having such fringes must be situated at a greater or less distance from the retina; and there are conclusive reasons for believing that they occupy the vitreous humour, and cannot therefore portend amaurosis; whereas

those black spots which have no fringes, and which do not move, or which move only with the motions of the eye, are points in the retina which are insensible to light, and are therefore to be dreaded as symptomatic of danger to vision. To decide, then, whether the muscæ volitantes are or are not indicative of danger, the patient should fix his eye on a white surface (as a sheet of letter-paper) after a sudden shake of the head; if they sink gently downwards, they are innocent. It should perhaps be added, that though they seem to descend, they must in reality be ascending; floating up in the vitreous humour as far as the cellular partitions formed by the hyaloid membrane will permit. See **EYE**. For further information on the differences between the innocent and the dangerous forms of muscæ volitantes, the reader is referred to an article by Sir David Brewster in the *North British Review* for November 1856.

MUSCARDINE, or **SILK-WORM ROT** (*Botrytis Bassiana*), a fungus (see **BOTRYTIS**) which grows on silk-worms, and often kills them in great numbers. It consists of erect branching threads, with clusters of spores at the end of short lateral branches. The spores of this fungus germinate even on healthy silk-worms, and in circumstances otherwise most



Muscardinæ (*Botrytis Bassiana*).

favourable to their healthfulness. They germinate also on the caterpillars of other lepidopterous insects. When this pest appears among silk-worms, its progress cannot be checked by any means known. For prevention, it is most important that the silk-worms be not overcrowded.

MUSCAT, or **MASKÂT**, the most powerful of the Arab states, consists of a tract of country in the eastern part of Omân, in Arabia, a narrow tract along the coast of the Persian provinces of Laristan and Moghistan, the islands of Ormus and Kishm at the entrance of the Persian Gulf, and an extensive territory on the east coast of Africa from the equator southwards to Cape Delgado, in which are included the provinces and islands of Zanzibar, Quiloa, Melinda, Patta, Pemba, Juba, Monfia, and Lamo. The whole territory of the state extends to about 176,000 square miles, and contains 2,500,000 inhabitants, of whom about 500,000 reside in Muscat Proper, in Arabia. The standing army amounts to 20,000 or 30,000 men, the navy to 87 vessels with 730 guns, the merchant-vessels to at least 2000 vessels of 37,000 tons. The value of the annual imports is reckoned at about £1,000,000 sterling, and the revenue of the state is about

£900,000. The capital is Muscat, on the Persian Gulf, a fortified town, surrounded with gardens and date-palms. It has a very good harbour, which, in the winter months, is reckoned the best harbour of refuge in the Indian Ocean, and is a most important centre of trade, where the productions of Europe, of Africa, and of the East are exchanged. The principal exports are Arabian coffee and pearls obtained from the Persian Gulf; but wheat, dates, raisins, salt, sulphur, drugs, and horses are also exported, whilst the African territories export gums and drugs, ivory, tortoise-shell, rhinoceros horns, skins and hides, wax, cocoa-nut oil, rice, &c. The ruler, the hereditary title of whom is the Imaum, resides sometimes at M., sometimes at Zanzibar. The town of M. now contains about 60,000 inhabitants, an extraordinary mixture of Arabs, Persians, Afghans, Beloochees, Indians, Negroes, Jews, &c. The Banian merchants of India have frequented the coast of Arabia for a thousand years, and a dialect of Hindustani, much mingled with other languages, has become a sort of common medium of intercourse. M. was taken by Albuquerque in 1507, and remained in the hands of the Portuguese till 1648, when the Arabs recovered possession of it. M. owes its position and prosperity to the mild and wise measures of Said Seid, sultan of Omán and Imaum of M., who, at the age of 16, ascended the throne in 1803, and reigned till his death in 1856. His dominions after his death were divided among two of his sons, one of whom is established at Zanzibar, and administers the African territories, the other resides at M., and owns the sovereignty of the Asiatic provinces.

MUSCATEL (Ital. *moscado*, musk), the name given to many kinds of sweet and strong French and Italian wines, whether white or red. Amongst the finest are the white Rivesalt and red Bagnol wines from Roussillon, and the Lunel from the Pyrenees, the *Lacrymæ Christi* and Carigliano of Naples, &c.

MUSCATINE, a city of Iowa, U.S., is on the west bank of the Mississippi, 100 miles above Keokuk, and 32 south-east of Iowa city. It has a large trade by the river, and several railroads, three steam flour-mills, two steam saw-mills, planing-machines, &c. The export of timber amounts to 10,000,000 feet per annum. There are 16 churches, schools, newspapers, &c. Pop. (in 1860) 5324.

MUSCHELKALK (Ger. shell-lime), the middle member of the Triassic, or New Red Sandstone period, the beds of which are entirely absent from the British strata. Being typically developed in Germany, the foreign name has been universally adopted to designate them. They consist of (1st) a series of compact, grayish, regularly-bedded limestone, more than 300 feet thick; and (2d) alternations of limestone, dolomite, marl, gypsum, and rock-salt, nearly 300 feet thick. The limestone abounds in the remains of Mollusca. The palæozoic Goniatites are replaced by the Ceratites, a remarkable link between them and the Secondary Ammonites. Ceratites are distinguished by the few small denticulations of the inner lobes of the suture. The heads and stems of Lily encrinites (*Encrinus*) are also abundant in these strata, and the remains of ganoid fish have also been met with.

MUSCI. See MOSSES.

MUSCICAPIDÆ, a family of birds of the order *Insectores* and tribe *Dentirostres*, of which the greater number receive the popular name Fly-catcher (q. v.). The limits of the family are, however, very variously defined by different ornithologists. The M. are mostly inhabitants of the

warmer parts of the world, in which they are very widely diffused. The species are very numerous.

MUSCIDÆ, a family of dipterous insects, having a short, thick, membranous proboscis, geniculated at the base, entirely retractile so as to be concealed within the mouth, and terminated by two large lobes (see HOUSE-FLY); the antennæ three-jointed; the thorax with a transverse suture. The species are very numerous, and universally distributed. More than 800 are found in Britain, among which are the well-known House-fly, Blow-fly, &c. The larvæ are Maggots (q. v.). Although some of the M. are troublesome, none of them are so much so as species of some other allied families.

MUSCLE AND MUSCULAR TISSUE. Muscular tissue is specially distinguished by its contractile power, and is the instrument by which all the sensible movements of the animal body are performed. When examined under a high magnifying power, the fibres of which it is composed are found to exist under two forms, which can be distinguished from one another by the presence or absence of very close and minute transverse bars or stripes. The fibres of the *voluntary* muscles—or those whose movements can be influenced by the will—as well as the fibres of the heart, are *striped*; while those of the *involuntary* muscles—the muscular structures over which we have no control—as, for example, the muscular fibres of the intestinal canal, the uterus, and the bladder, are *unstriped*.

On examining an ordinary voluntary muscle with the naked eye (a muscle from one of the extremities of any animal, for example), we observe that it presents a fibrous appearance, and that the fibres are arranged with great regularity in the direction in which the muscle is to act or contract (for it is by their inherent power of contracting that muscles act). On closer examination, it is found that these fibres are arranged in *fasciculi*, or bundles of various sizes, enclosed in sheaths of areolar tissue, by which they are at the same time connected with and isolated from those adjoining them; and when the smallest *fasciculus*, visible to the naked eye, is examined with the microscope, it is seen to consist of a number of cylindrical fibres lying in a parallel direction, and closely bound together. These *primitive* (or, as some writers term them, the *ultimate*) fibres present two sets of markings or *striae*—viz., a longitudinal and a transverse set. The fibres, when separated from each other, frequently split longitudinally into *fibrille*, as is seen at one of the ends of fig. 1. Sometimes, however, when a fibre is extended,

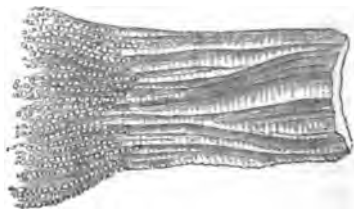

Fig. 1.—A Fasciculus of Striped Muscular Fibres, showing longitudinal cleavage: Magnified 300 diameters.

it separates in the direction of the transverse stria into a series of discs, as is shewn in fig. 2. Either cleavage is equally natural, but the latter is the least common. Hence, observes Mr Bowman, who has specially investigated the minute structure of voluntary muscle, 'it is as proper to say that the fibre is a pile of discs as that it is a bundle of fibrille; but, in fact, it is neither the one nor the other, but a mass in whose structure there is an

MUSCLE AND MUSCULAR TISSUE

intimation of the existence of both, and a tendency to cleave in the two directions. If there were a general disintegration along all the lines in both

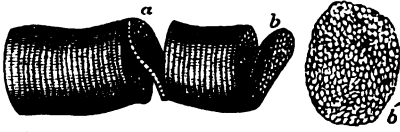

Fig. 2.—A Fasciculus, similarly magnified, shewing transverse cleavage:

The longitudinal lines are scarcely visible: a and b, discs nearly detached; b', a detached disc, more highly magnified, shewing the sarcous elements.

directions, there would result a series of particles, which may be termed *primitive particles* or *sarcous elements*, the union of which constitutes the mass of the fibre. These elementary particles are arranged and united together in the two directions, and the resulting discs, as well as fibrillae, are equal to one another in size, and contain an equal number of particles. The same particles compose both. To detach an entire fibrilla is to abstract a particle of every disc, and *vice versa*.' The fibres are supplied

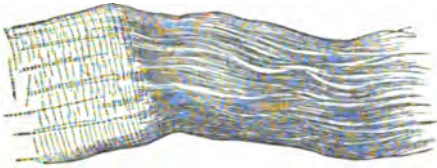

Fig. 2 (bis).—Attachment of Tendon to Muscular Fibre in the Skate.

with vessels and nerves which lie in the intervals between them, and are attached by their extremities through the medium of tendon or aponeurosis to the parts which they are intended to move. Aggregated in parallel series, of greater or lesser size, and

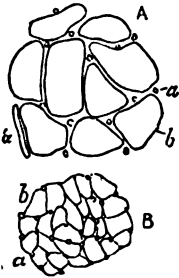

Fig. 3.—Transverse Sections of Striped Muscle that had been injected and dried:

Magnified 70 diameters.

A, from the frog; B, from the dog; a, a, sections of the injected capillaries, shewing the position they occupy among the fibres; a', a capillary seen longitudinally; b, b, section of elementary fibres, shewing their angular form and various size. These figures shew that the vascularity is greatest when the elementary fibres are smallest.

birds where it is most evanescent. Their average width in man is about $\frac{1}{100}$ th of an inch, being about $\frac{1}{100}$ th of an inch in the male and $\frac{1}{100}$ th

of an inch in the female. The average distance between the striae, or the size of the sarcous elements, in the human subject is $\frac{1}{100}$ th of an inch, the extremes being $\frac{1}{100}$ th and $\frac{1}{100}$ th of an inch, according to the contraction or relaxation of the fibre. The form of the fibres is polygonal, their sides being flattened against those of the adjoining fibres. Each fibre is enclosed in a transparent, very delicate, but tough and elastic tubular sheath, which cannot always be readily seen, but is distinctly shewn stretching between the separated fragments of a fibre which has been broken within it, for its



Fig. 4.—Muscular Fibre broken across: Shewing the un torn sarcolemma uniting the fragments.

toughness will often resist a force before which its brittle contents give way. This tubular sheath is known as the *sarcolemma* or *myolemma*—the former term being derived from the Greek words *sarz*, flesh, and *lemma*, a skin or husk; and the latter, from the Greek words *múe*, a muscle, and *lemma*.

It was for a long time believed that the contraction of a muscle was associated with a change in the direction of each fibre from a straight line to a sinuous or zigzag course. The investigations of Mr Bowman have, however, shewn that this view is erroneous. He has proved that in a state of contraction there is an approximation of the transverse striae, and a general shortening with a simultaneous thickening of the fibre, but that it is never

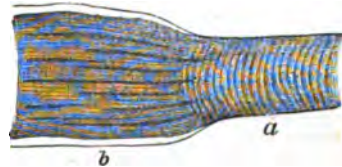

Fig. 5.—Fragment of an Elementary Fibre (from the Eel) partially contracted in water:

Magnified 300 diameters.

a, uncontracted part; b, contracted part, along the border of which the sarcolemma is raised from the surface by the water that has been absorbed, that has thereby caused the contraction, and by it has been expelled from the contractile mass.

thrown out of the straight line, except when it has ceased to contract, and its extremities are acted on by the contraction of adjacent fibres.

Muscles grow by an increase, not of the number, but of the bulk of their elementary fibres; and Mr Bowman believes 'that the number of fibres remains through life as it was in the fetus, and that the spare or muscular build of the individual is determined by the mould in which his body was originally cast.'

The structure of the *involuntary* or *unstriped* muscles must now be considered. This form of muscular tissue most commonly occurs in the shape of flattened bands of considerable length, but of a width not exceeding $\frac{1}{100}$ th or $\frac{1}{100}$ th of an inch. These bands are translucent, and sometimes slightly granular, and are usually marked at intervals by elongated nuclei, which become much more apparent on the addition of acetic acid. Kölliker has shewn that every one of these bands or fibres is either a single elongated cell (a fibre-cell) or is a fasciculus of such cells. (They are represented in fig. 2, d, in the

article CELLS, under the title of *Contractile fibre cells*.) These fibres have not usually fixed points of attachment like the striated fibres, but form continuous



Fig. 6.—Fibres of Unstriated Muscle :
 a, in their natural state; b, when treated with acetic acid, which reveals the existence of corpuscles; c, corpuscles or nuclei detached. This and the preceding diagrams are copied from Bowman.

investments around cavities within the body—such as the intestinal canal, the bladder, the uterus, the blood-vessels, &c.—or are dispersed through the substance of tissues, such as the skin, to which they impart a contractile property.

The chemical composition of ordinary (or voluntary) muscle is described in the article FLESH. It is only necessary to add that the fibrillæ, or the sarcois elements of which they are composed, consist of a substance termed SYNTONINE (q. v.), which closely resembles the fibrine or coagulating constituent of the blood; and that the same syntonine is also the main constituent of the unstriated muscles, or at all events of their fibre-cells. Like the blood-fibrine, it exists in a fluid form in the living tissue, and only coagulates or solidifies after death.

Our limited space prevents even an allusion to the arrangement and distribution of blood-vessels, nerves, and areolar-tissue in muscular structures; and we therefore pass on to the consideration of the muscles and their functions.

Muscles vary extremely in their form. In the limbs they are usually of considerable length, surrounding the bones and forming an important protection to the joints; while in the trunk, they are flattened and broad, and contribute very essentially to form the walls of the cavities which they enclose. There is unfortunately no definite rule regarding the nomenclature of muscles. Muscles derive their names (1) from their situation—as the temporal, pectorals, glutæals, &c.; or (2) from their direction—as the rectus, obliquus, &c., of which there may be several pairs—as, for example, rectus femoris, rectus abdominalis, rectus capitis, &c.; or (3) from their uses—as the masseter, the various flexors, extensors; or (4) from their shape—as the deltoid, trapezius, rhomboid, &c.; or (5) from the number of their divisions—as the biceps and triceps; or (6) from their points of attachment—as the sterno-cleido-mastoid, the genio-hyo-glossus, the sterno-thyroid, &c. In the description of a muscle, we express its points of attachment by the words *origin* and *insertion*; the former being applied to the more fixed point or that towards which the motion is directed, while the latter is applied to the more movable point. The

application of these terms is, however, in many cases arbitrary, as many muscles pull equally towards both attachments. Muscles opposed in action are termed *antagonists*, this antagonism being in most cases required by the necessity that exists for an active moving power in opposite directions. Thus, by one set of muscles, the *flexors*, the limbs are bent; while by a contrary set, the *extensors*, they are straightened. One set, termed the muscles of mastication, closes the jaws, while another set opens them; and probably every muscle in the body has its antagonists in one or more other muscles.

The skeleton, which may be termed the locomotive framework, may be regarded as a series of levers, of which the fulcrum is, for the most part, in a joint—viz., at one extremity of a bone—the resistance (or weight) at the further end, and the force (or muscle) in the intermediate portion. In most cases, in order to preserve the necessary form of the body, muscles are applied at a great mechanical disadvantage as regards the exercise of their power; that is to say, a much larger force is employed than would suffice, if differently applied, to overcome the resistance. The two main sources of this disadvantage lie in the obliquity of the insertion, and consequently of the action of most muscles, and in the muscles being usually inserted very near the fulcrum. The first of these disadvantages is in many cases diminished

by the enlargements of the bones at the joints. (See fig. 7, A.) The tendons (*t*) of the muscles (*m*) situated above the joint are usually inserted immediately below the bony enlargement, and thus reach the bone that is to be moved (*o*) in a direction somewhat approaching the perpendicular. If this enlargement did not exist (as in fig. 7, B), the contraction of the muscle, instead of causing the lower bone to turn upon the upper one with comparatively little loss of power, would do little more than cause the two ends of the bones to press upon each other. The second mechanical disadvantage is compensated for by gain in the extent and velocity of movement, and by the avoidance of the great inconvenience of having the muscles extended in straight lines between the ends of jointed continuous levers. Thus the bones of the forearm (*b, c*) are bent upon the bone of the arm (*a*) by the biceps muscle (*d*),

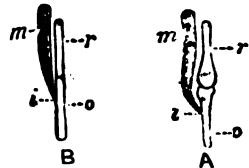

Fig. 7.



Fig. 8.

which arises close to the head of the latter, and is inserted at *e*, at a short distance from the elbow-joint, which acts as the fulcrum of the lever *c*. By this arrangement, a contraction of a single inch in the muscle moves the hand (*f*), in the same time, through the extent of about 12 inches, but then the hand moves through every inch with only about

the twelfth part of the power exerted by the muscle. By the junction of two or more levers in one direction, as in the different segments of the extremities, the extent and velocity of their united actions are communicated to the extreme one. Thus a blow of the fist may be made to include the force of all the muscles engaged in extending the shoulder, elbow, and wrist.

The great and characteristic property of muscular tissue—that of shortening itself in a particular direction when stimulated—is called *contractility*. The stimulus may be direct irritation by mechanical means, or by galvanism, or by some chemical substance, but in the living body the muscular fibres are, in most cases, made to contract by the immediate influence of the nerves distributed among them, which are consequently termed *motor* nerves (see NERVOUS SYSTEM), and are under the influence of the will. By an exertion of volition, we can contract more or fewer muscles at once, and to any degree, within certain limits; and as a matter of fact, there is hardly any ordinary movement performed in which several muscles are not called in play. But every voluntary muscle is also subject to other influences more powerful in their operation than the will. The movement of the features under the impulses of passion and emotion are more or less involuntary, as is shewn by the very partial power the will has of restraining them, and the extreme difficulty of imitating them.

Many movements ensue involuntarily when certain impressions, which need not necessarily be attended with consciousness, are made on the surface of the body, or on any part of its interior, either by external or internal causes. Such movements are termed *reflex*, and are noticed in the article NERVOUS SYSTEM.

Our limited space precludes us from noticing the individual groups of muscles occurring in the human body. Several important groups are, however, noticed in the articles ARM, EYE, FOOT, HAND, LEG, &c.

MUSES, in the Classic Mythology, divinities originally included amongst the Nymphs, but afterwards regarded as quite distinct from them. To them was ascribed the power of inspiring song, and poets and musicians were therefore regarded as their pupils and favourites. They were first honoured amongst the Thracians, and as Pieria around Olympus was the original seat of that people, it came to be considered as the native country of the Muses, who were therefore called *Pierides*. In the earliest period their number was three, though Homer sometimes speaks of a single muse, and once, at least, alludes to nine. This last is the number given by Hesiod in his *Theogony*, who also mentions their names—Clio (q. v.), Euterpe (q. v.), Thaleia (q. v.), Melpomene (q. v.), Terpsichore (q. v.), Erato, Polyhymnia (q. v.), Urania (q. v.), and Calliope (q. v.). Their origin is differently given, but the most widely-spread account represented them as the daughters of Zeus and Mnemosyne. Homer speaks of them as the goddesses of song, and as dwelling on the summit of Olympus. They are also often represented as the companions of Apollo, and as singing while he played upon the lyre at the banquets of the Immortals. Various legends ascribed to them victories in musical competitions, particularly over the Sirens (q. v.). In the later classic times, particular provinces were assigned to them in connection with different departments of literature, science, and the fine arts; but the invocations addressed to them appear to have been, as in the case of modern writers, merely formal imitations of the early poets. Their worship amongst the Romans was a mere imitation of the Greeks, and never became a truly national or popular. Among the places sacred to

them were the wells of Aganippe and Hippocrene on Mount Helicon, and the Castalian spring on Mount Parnassus.

MUSE'UM (Gr. *mouseion*), originally the name given by the ancients to a temple of the Muses, and afterwards to a building devoted to science, learning, and the fine arts. The first museum of this kind was the celebrated Alexandrian Museum (see ACADEMY). After the revival of learning in Europe, the term museum was sometimes applied to the apartment in which any kind of philosophical apparatus was kept and used; but it has long been almost exclusively appropriated to collections of the monuments of antiquity and of other things interesting to the scholar and man of science. In this sense it began to be first used in Italy, and probably in the case of the famous Florentine Museum, founded by Cosmo de Medici, which soon became a great and most valuable collection of antiquities. Nothing analogous to the museums of modern times existed amongst the ancients, the greatest collections of statues and paintings which were made in the houses of wealthy Romans having been intended for splendour rather than for the promotion of art. The name soon ceased to be limited to collections of antiquities, and sculptures, and paintings; collections illustrative of natural history and other sciences now form a chief part of the treasures of many of the greatest museums, and there are museums devoted to particular branches of science. Of the museums of Britain, the British Museum (q. v.) is the greatest; that of Oxford, founded in 1679, is the oldest.—The museum of the Vatican, in Rome, contains immense treasures in sculptures and paintings, and also in books and manuscripts.—The museum of the Louvre in Paris, that of St Petersburg, and those of Dresden, Vienna, Munich, and Berlin, are amongst the greatest in the world. The usefulness of a museum depends not merely upon the amount of its treasures, but, perhaps, even in a greater degree upon their proper arrangement; and whilst great collections in the chief capitals of the world are of incalculable importance to science, its interests are also likely to be much promoted by those local museums, still unhappily not numerous, which are devoted to the illustration of all that belongs to particular and limited districts. Museums appropriated to the illustration of the industrial arts—their raw material, their machines, and their products—and of everything economically valuable, are of recent origin, but their importance is unquestionably very great. Pre-eminent among institutions of this kind in Britain are the South Kensington Museum and the Industrial Museum in Edinburgh.

MUSHROOM, or AGARIC (*Agaricus*), a genus of fungi, of the suborder *Hymenomycetes*, having a *hymenium* of unequal plates or gills on the lower side of the *pileus*. The species are very numerous. Many of them are poisonous, many are edible, and some are among the most esteemed fungi. The species most esteemed in Britain is the COMMON M. (*A. campestris*), a native also of most of the temperate regions both of the northern and of the southern hemisphere, and of which a very large and fine variety occurs in Eastern Australia. It is found during summer and autumn (but chiefly in autumn) in pastures, orchards, vineyards, &c. Its *pileus* is regularly convex, becoming almost flat when old; fleshy, dry, white with a tinge of yellow or brown; of a silky smoothness on the upper surface, or somewhat scaly, but never warty; thickly set on the under side with very unequal gills, which in a young state are pink, and afterwards become dark brown. The *pileus* is attached by its centre

MUSHROOM.

to the top of the stem. The stem is of a firm fleshy texture, and *towards the top* is surrounded by a more or less distinct white membranous ring, the remains of the curtain or veil (*indusium*), which in a young state extends to the pileus, and covers the gills. This *M.* is gathered for the table when young, being preferred when the veil is still unbroken, and the unexpanded pileus has the form of a ball or button; but both in this state, and afterwards, whilst it shews no symptoms of decay, it is used for making Ketchup (q. v.). It has a very pleasant smell and taste, and the flesh, when bruised, assumes a reddish-brown colour.—Very similar to it, and often sold instead of it in London and elsewhere, but rejected by all skilful housekeepers as unfit even for making ketchup, is the **ST GEORGE'S AGARIC** (*A. Georgii*), sometimes called *whitecaps*, frequent in moist pastures and near buildings in all parts of Britain. This species is easily distinguished by its larger size—the pileus being sometimes 18 inches broad—its coarser appearance, its rather disagreeable smell, the yellow colour which its flesh assumes when bruised, and the lighter colour of its gills.—Care must be taken not to confound the Common *M.* with the white variety of *Agaricus phalloides*, a species not uncommon in Britain, chiefly in woods and on the borders of woods, which is very poisonous. Perhaps it is the possibility of this mistake which has led to the prohibition of the Common *M.* in Rome, where many kinds of esculent fungi are brought in great abundance to the market, and



Fig. 1.

(From Sowerby's *English Fungi*.)

1. Parasol Agaric (*A. procereus*); a, young. 2. Orange-milked Agaric (*A. deliciosus*); b, young. 3. White Field Agaric (*A. virgineus*); c, young.

where a special officer superintends the sale of them. *A. phalloides* is, however, easily distinguished by the ring at the *bottom* of the stem, the white colour of the gills, the warts on the upper surface of the pileus, and the powerful smell, which becomes extremely disagreeable as the *M.* grows old.—Another species of *M.* much in use for the table is the **FAIRY-RING M.** (*A. oreades*), sometimes called *Scotch Bonnets*—the *Champignon* of the French. It is common in pastures in Britain and most parts of Europe, often forming Fairy Rings (q. v.). It is much smaller than the Common *M.*, the pileus being seldom more than an inch broad, the stem taller in proportion. The stem is solid, fibrous, and tough, with no ring; the pileus smooth, fleshy, tough, convex, with a more or less distinct boss (*umbo*) in the centre, of a watery-brown colour; the flesh white. The odour is strong, but agreeable.

This *M.* is used for ketchup, and is also dried and powdered for use at table as a savoury addition to sauces and stews. It is constantly brought to market in England. It is liable, however, to be



Fig. 2.

(From Sowerby's *English Fungi*.)

4. St George's Agaric (*A. georgii*); d, young. 5. Common Mushroom (*A. campestris*); e, young. 6. Fairy-ring Mushroom (*A. oreades*); f, young. 7. *Clavaria phalloides*; g, young.

confounded with several poisonous species; but only one of them, *A. dealbatus*, forms fairy rings, and this may be readily distinguished by its disagreeable odour, by its becoming grayish-brown in zones when soaked in water, by the margin of the pileus being at first rolled inwards, and by its very fine dingy whitish gills.—The other edible species of *M.* or agaric are numerous, but they are chiefly used on the continent of Europe, and scarcely at all in Britain, although some of them are common British plants.—The **ORANGE-MILKED AGARIC** (*A. deliciosus*), which grows chiefly in fir-woods and among junipers, has a viscid pileus, four inches or more broad, at first orange, afterwards pale, the gills and juice orange, the gills running down the stem, the smell and taste agreeable.—The **MOUSSERON** (*A. prunulus*) is common in woods and pastures, particularly on sandy soils. It has a pileus about 2–4 inches broad, convex, yellowish-white when young, the gills at first white, and afterwards flesh-coloured. The odour is agreeable. It is much esteemed on the continent as an article of food.—The **PARASOL AGARIC** (*A. procereus*) is found in pastures, especially under trees. It loves sandy soils. It is remarkable for its long stem, 8–12 inches high, with a thick spongy ring. The pileus is 3–7 inches broad, at first obtusely conic, then bell-shaped, covered with brown scales. The taste and smell are pleasant.—The **WHITE FIELD AGARIC** (*A. virgineus*) is one of the most common of British species, growing in pastures, with viscid or satiny white or whitish convex pileus, fully an inch broad, stem nearly two inches long, and light chocolate-coloured distant gills, which run down the stem. It grows either singly or in groups.—The **ANISE M.**, or **SWEET-SCENTED AGARIC** (*A. odoros*), grows in shady woods and dells among moss and decaying leaves. It has a slightly convex pileus, about three inches broad, with pale gills. The odour is like that of anise.—The **IVORY M.** (*A. eburneus*) is found in woods, with pileus 2–3 inches broad, of a grayish-yellow colour, broad gills, and a rather long and somewhat scaly

stem.—The **SMOKY M.** (*A. fumosus*), with pileus smoke-gray above, the gills and stalk yellowish, is common in fir-woods.—All these are edible, and more or less pleasant and nutritious. Finer than most of them is the **IMPERIAL M.** (*A. cesarius*), the *Kaiserling* of the Germans, a species found in loamy soils in some parts of Europe, with orange pileus and lighter yellow stem and gills; but, unhappily, it is apt to be confounded with the very poisonous *Amanita* (q. v.) *muscaria*.

The **COMMON M.** is frequently cultivated both in the open garden and in houses or sheds. To grow it in the open garden, beds are prepared, generally of earth mixed with horse-dung, partly fresh and partly from old hotbeds, and are raised into ridges almost as high as broad. To grow it in houses, boxes are filled with alternate layers of half-rotten horse-dung and of straw, with a surface layer of fine mould. But of each of these methods there are many different modifications, none of which can here be detailed. In both, the production of mushrooms is sometimes left to the chance—often almost a certainty—of spawn (*mycelium*) or spores existing in the dung or earth; sometimes, to increase the probability of a speedy and abundant crop, earth is introduced into the bed or box from a pasture known to be rich in mushrooms, and *M.* spawn is also frequently planted, which is either collected where mushrooms grow, or produced by artificial means, often appearing and being propagated extensively without the development of the *M.* itself. The almost certain production of *M.* spawn in heaps of slightly-fermenting horse-dung, straw, and earth, has been often urged as an argument in favour of the equivocal generation of fungi, but the minuteness and multitude of the spores may more reasonably be urged on the opposite side.

MUSIC (Gr. *mousike*, from *mousa*, muse; Lat. *musica*), a combination or succession of sounds having the property of *pitch*, so arranged as to please the ear. The pleasure derived from music arises from its exciting agreeable sensations, and raising pleasing mental images and emotions. Apart from words, it expresses passion and sentiment, and linked to words, it loses its vagueness, and becomes a beautiful illustration of language.

The doctrine of musical sounds is based on the principles of Acoustics (q. v.). Sound is conveyed through elastic media by waves, not of alternate elevation and depression, but of alternate condensation and rarefaction, in which it is the form, the condition of the groups of particles that progresses, not each individual particle. When a series of vibrations recur on the ear at precisely equal intervals of time, following each other so closely that each cannot be separately distinguished, the result is a musical sound or note. The sound ceases to have a musical character when each pulsation is individually audible, as is the case when there are fewer than about sixteen beats in a second. The gravity or sharpness of the sound is called its *pitch*, and depends on the number of vibrations in a given time. A succession or progression of musical sounds following each other constitutes melody; the difference in pitch between any two of them is called an *interval*. Where two or more musical sounds, whose relative pitch is properly proportioned, are heard simultaneously, the result is a chord, and a succession of chords constitutes harmony.

When a vibration is communicated to a string stretched between two points, the result is a musical note, whose pitch is dependent on the length of the string and the degree of tension applied to it: the shorter the string, and the greater the tension, the higher is the pitch. If the string be divided in

the middle, the tension remaining the same, the note produced is twice as high in pitch, and is called the octave to the note produced by the whole string. Every vibration of the one corresponds to two of the other, and there is between a note and its octave a far closer relation than between any two other notes; they go together almost as one sound, and are considered to a great extent as one musical sound. In the diatonic scale, familiar to every correct ear, there are six notes, bearing certain harmonic relations to the fundamental note, interposed between it and its octave; and as we ascend, the notes arrange themselves in similar successions of sevens, each set an octave higher, or double the pitch of that which preceded it. The seven notes are designated by the names of the first seven letters of the alphabet, the same letter being used for any note and its octave. For another notation also in use, see **SOLMIZATION**. Taking C for the fundamental note, we have for our scale

Ô D E F G A B Ċ D E F G A B Ċ, &c.

The scale may be extended up or down indefinitely, so long as the sounds obtained continue to be musical. The satisfaction and sense of completeness which the diatonic scale gives the ear, arise from its being founded on correct harmonic principles. The quality called harmony is produced by a coincidence of vibrations: notes are more harmonious the oftener their waves coincide. Besides the octave, two of whose waves coincide with one of the fundamental, there are other intervals harmonious, though in a less degree. Dividing our string into three parts instead of two, we have a note higher than the octave, which may be lowered by an octave by making the string two-thirds of the original length, and produces a wave of which three coincide with two of the fundamental. Next to the octave, this note stands in the most intimate relation to the fundamental; it is called the dominant. Dividing the string by five, and lowering the note two octaves, another harmonic is got, called the mediant. In contradistinction from both these, the fundamental note (or any of its octaves) is called the tonic or key-note. C being taken as the key-note, E is the mediant, and G the dominant. These three notes, when struck simultaneously, form the harmonic triad, and stand to each other in the relation of 1, $\frac{2}{3}$, $\frac{4}{3}$ (numbers indicating the number of vibrations, which are inversely as the length of the string), or, reducing fractions to integers, in the relation of 4, 5, 6. When a musical string is vibrating, these sounds are heard on close observation more or less distinctly vibrating along with it, the cause being a spontaneous division of the string into aliquot parts, producing subordinate vibrations simultaneously with the principal vibrations. But the dominant may in its turn be the tonic from which another triad of tonic, mediant, and dominant is taken, forming a scale of triads extending indefinitely up and down, and it is from three such adjacent triads that the diatonic scale originates. Its elements are the triad of the tonic united with the triads which stand in the most intimate relation to it—viz., those immediately above and below it—

F A C, C E G, G B D.

F is the note whose dominant is C (the tonic), and therefore, in respect of C, it is called the subdominant. A is the mediant of the subdominant F, and therefore called the submediant. D is the dominant of the dominant, and is called the super-tonic. B, the mediant of the dominant, is called the leading note. We have seen that the notes of each triad stand to each other in the relation of 4, 5, 6.

MUSIC.

Preserving this proportion, and multiplying to avoid fractions, we have

F A C E G B D
as 16, 20, 24, 30, 36, 45, 54

We must multiply F and A by 2, and divide D by 2, to bring them within the compass of an octave, and then we have

C D E F G A B C
as 24, 27, 30, 32, 36, 40, 45, 48

These are the degrees of the Diatonic Scale, which are indicated by the white keys of the pianoforte, as in the figure in the following column.

The interval CD is commonly called a second; CE, a third; CF, a fourth; CG, a fifth; CA, a sixth; and CB, a seventh; OC being, as already seen, an eighth or octave—names corresponding to the position of the notes on the key-board or in the diatonic scale, but having no relation to the proper proportional numbers already given. The intervals of the third, fifth, and sixth (counting from the key-note), owing to the more intimate harmonic relation of the notes between which they lie, afford more satisfaction to the ear than the others, or are, as it is called, the most perfectly consonant intervals. Intervals may be counted from any note as well as the tonic. DF is called a third as well as CE, although these intervals are unequal. We may have intervals beyond the octave; they are, however, substantially but repetitions of those below, CD, a ninth, being also a second, and so on.

It is often desirable in the course of a musical composition to change the key-note, which involves the formation of a diatonic scale on some other note than C, in which case we are said to modulate from one key into another. As the intervals CD, DE, EF, &c., are by no means all equal, the notes which we have already got will not do for a scale founded on any other tonic than C. The ratios of the intervals in the diatonic scale, expressed in numbers by logarithms, are:

C	D	E	F	G	A	B	C
51	46	28	51	46	51	28	

At first sight it would appear that in keyed instruments there must be a separate row of keys for each tonic, but practically this is found not to be necessary. If D instead of C be taken as key-note, E, G, and A are some approach to the correct second, fourth, and fifth, but F and C are greatly too low in pitch for a proper third and seventh. With some notes taken as key-note, the correspondence is greater, with others it is less. The difficulty is overcome by a system of compromises called

Temperament (q. v.). Roughly speaking, we have in the diatonic scale an alternation of two long intervals, a short interval, three long intervals and a short interval. The long intervals 51 and 46 are styled tones, and the short interval 28 a semitone. Were the tones all equal, and the semitone exactly half a tone, a note interposed in the middle of each tone, dividing the seven intervals into twelve, would make it immaterial where the scale began. A system founded on this supposition is the remedy actually adopted in most keyed instruments, and the inaccuracy produced by this compromise is not sufficiently great to offend

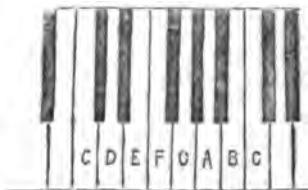

the ear. The interposed notes, indicated by the black keys of the pianoforte (see fig.), complete what is called the chromatic scale, consisting of twelve intervals approximately equal.

The notes of music are represented in ordinary notation on a series of five parallel lines, called the staff. On these lines, and in the four spaces between them, marks are placed indicating the notes, which are counted upwards, beginning with the lowest line. Every line or space is called a degree, the staff consisting of nine degrees.

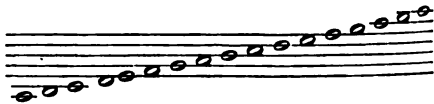

When more than nine notes are required, the spaces below and above the staff are used, and the scale is extended by means of short added lines, called ledger lines. The pitch of the notes on the scale is determined by a figure called a clef (*clavis*, a key), placed at the beginning of the staff on a particular note, from which all the others are counted. The clefs most in use are the bass, tenor, and treble clefs, represented on the notes F, C, and G respectively (see CLEF). The treble and bass clefs only are used in music for keyed instruments, and when a staff is required for each hand, they are joined together by a brace, the upper staff for the right hand, the lower for the left. The ascending scale in these clefs is as follows:

C D E F G A B C D E F G A B C



These notes correspond with the white keys of the pianoforte or the diatonic scale when C is key-note, no allowance being made for the black keys, which, as we have seen, divide the tones into semitones. Those semitones which do not occur with C as key-note are represented by the signs ♯ (sharp) and ♭ (flat). The sign ♯ prefixed to a note,

elevates it a semitone in the scale, raising, for example, F to F sharp. ♭ lowers the note by a semitone, depressing B to B flat. When a note which has been elevated by a sharp, or depressed by a flat, is to be restored to its original place, the character ♮ (natural) is prefixed to it.

The names of the intervals correspond to the

MUSIC.

degrees of the staff, but it has been seen that intervals of the same name are not necessarily equal. If the sign of a flat or a sharp be prefixed to either note of an interval, it still preserves its name of a third, a fifth, &c.; but to distinguish intervals of the same degree, the qualifying epithets of major and minor, augmented and diminished, are used.

The different keys in music are best understood by reverting to the scale of triads, on which the diatonic scale is founded. Taking a series of triads, of which the dominant of each is the key-note of the next, we obtain the following scale, extended both upwards and downwards from C:

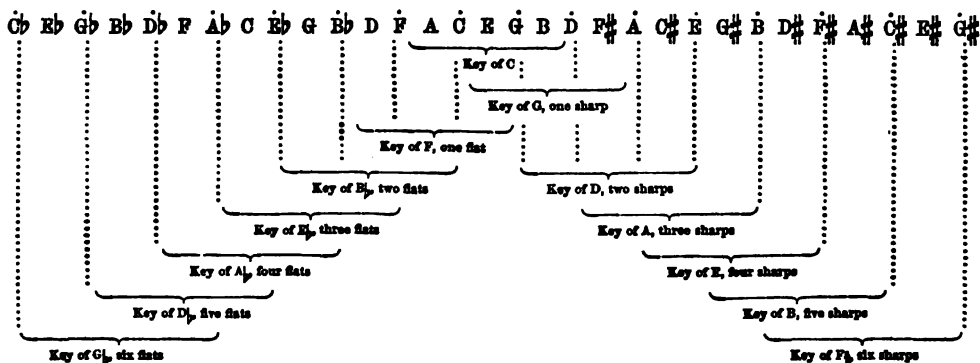

Each triad is composed of the key-note, its mediant, and dominant, and the scale of each key is composed of the triad of the key-note, with the triad immediately preceding and that immediately following it. Each key is succeeded by the key of its dominant, and if we begin with the key of C (in the middle of the scale), each key acquires an additional sharp till we reach the key of F[#] with six sharps. These are the sharp keys. If, beginning again with the key of C, we go back instead of forward in the scale of triads, we obtain the flat keys; each key has an additional flat to that above it, till we come down to the key of G^b with six flats. This key in instruments with temperament is exactly the same with

that of F[#], and on this account it is not generally found convenient to extend the keys beyond six, or at most seven, sharps or flats. G[#] with seven sharps is the same as D^b with five flats, and C^b with seven flats is the same as B with five sharps. In music written in these keys, double sharps and double flats occur, which are indicated by the characters x and bb respectively. In writing music in any key with sharps or flats, it is usual, instead of prefixing the sharp or flat to each note when required, to place the sharps and flats belonging to the key together after the clef, on the degree to which they belong, and such collections of sharps or flats are called the signature.

SIGNATURES OF THE SHARP KEYS.



SIGNATURES OF THE FLAT KEYS.

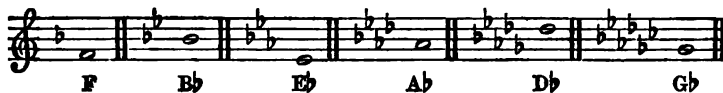

A sharp or flat introduced in a composition which does not appear in the signature, is prefixed to the note, and called an accidental.

The diatonic scale and keys above described belong to what is called the major mode; there is also another mode in use called the minor mode. In the minor, as in the major mode, the diatonic scale and the keys are based on the scale of triads. Each of the triads already considered consists of two unequal intervals, called a major third and minor third. Supposing we begin with the minor instead of the major third, we have a succession of chords taking their minor third from one triad and their major third from another. These compound chords are called minor triads. Their proportion is as 10, 12, 15, and out of three such consecutive minor triads the scale of the minor mode is constructed.

D F A C E G B
80, 96, 120, 144, 180, 216, 270

Multiplying D and F by 2, and dividing B by 2, to bring the whole within the compass of an octave, we have:

A B C D E F G A
120, 135, 144, 160, 180, 192, 216, 240.

The scale here represented is what is known as the descending scale of the minor mode. When the seventh of the scale ascends to the eighth, it becomes sharp, as the proper leading note or sharp seventh to the tonic. This sharp is, however, always omitted from the signature, and placed accidentally before the seventh which it is to elevate. In order to avoid the harsh interval of the augmented second (from F to G[#]), it is usual in

MUSIC.

the ascending scale to make the sixth sharp also, in order to accommodate the seventh; thus the

ascending or accidental scale of the minor mode has two notes altered from the signature.

ASCENDING SCALE.

DESCENDING SCALE.



Each minor scale is called the relative minor to the major scale on its right hand in the scale of triads, with which it has the same signature: thus the relative minor scale to C major is that of A minor.

C major F A C E G B D
A minor D F A C E G B

Each minor scale is also called the tonic minor to the major scale on the same key-note, from which it differs in flattening the third of its tonic, and in the descending scale also the third of its subdominant and dominant. The tonic minor scale to C major is C minor.

C MAJOR.

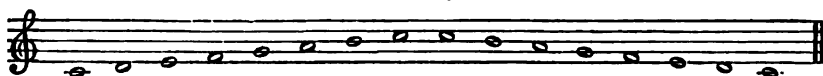

C MINOR.

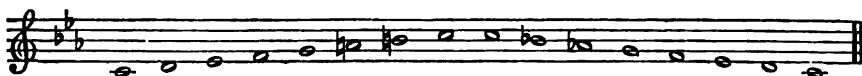

As the descending scale regulates the signature, each tonic minor has three flats more, or three

sharps less in its signature than its tonic major.

F MAJOR.

F MINOR.



A MAJOR.

A MINOR.

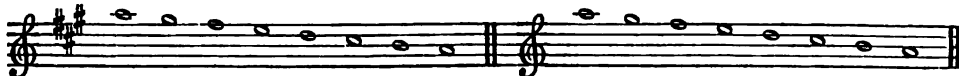

G MAJOR.

G MINOR.



In this last example, F#, Bb, and Eb are all considered sharps in contrast with Fb, Bb, and Eb of the minor scale.

Rhythm.—In musical notation, the relative duration of notes is indicated by their form. Notes may be open or close; they may consist of a head only, or of a head and stem. Where there is a stem, it may be turned up or down, according to convenience. The semibreve, the longest note in ordinary music, is open, and consists of a head only (C). The minim is an open note with a stem, half the length of a semibreve; the crotchet is a close note with a stem, half the length of a minim; the quaver is a close note with a stem and hook, half the length of a crotchet; a quaver is further divided into two semiquavers with two hooks; four demi-semiquavers with three hooks; and eight semi-demi-semiquavers with four hooks. In

equivalent in time to two minims, four crotchets, eight quavers, sixteen semiquavers, thirty-two demi-semiquavers, and sixty-four semi-demi-semiquavers. The notes formed with hooks may be grouped

together . In vocal

music this is not done except when a group is to be sung to one syllable. When a dot is placed after a note it is lengthened by one-half; when two dots, it is lengthened by three-fourths.

Every piece of music is divided into portions equal in time, called measures, which are separated from each other by vertical lines called bars. The term bar is often loosely used to denote the measure as well as the line. The exact length of the measure is indicated by a sign at the beginning of the movement. In common

time, indicated by the sign  each measure includes a semibreve, or its equivalent made up in

MUSIC.

notes of lower value: 

All other measures of time have for their signatures two figures placed as a fraction, one over the other. The figures of the denominator are either 2, 4, 8, or 16, which stand for minims, crotchets, quavers, and semiquavers respectively (i. e., halves, fourths, &c. of a semibreve); the numerator indicates the number of these fractional parts of a semibreve contained in each measure. There is another form of common time besides that already noticed, which is called half-time, has a minim or two crotchets in

the measure, and is known by the signature 
i. e., two crotchets—

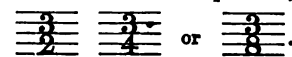

When there are three minims, crotchets, or quavers in a measure, the piece is said to be in triple time, its signature being .

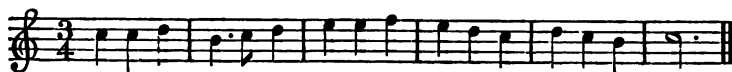

When two or four measures of triple time are united in one measure, the movement is said to be in compound common time. Its usual forms are

indicated by the signatures .

In the first, there are three submeasures of three crotchets; in the second, two submeasures of three

quavers 

Compound triple time occurs where there are nine notes in a measure, either crotchets, quavers, or semiquavers, grouped in threes. Its signatures are

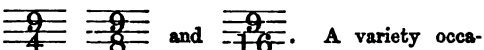
. A variety occa-

sionally occurs in simple or triple time by the measure note being divided into three, or even five or seven, instead of two parts, which are grouped together, sometimes with the figure 3, 5, or 7, placed

above them 

The object of the division of musical passages into measures is to indicate their rhythm, a quality forming an essential element in the pleasure derived from music. Notes of music, like words or syllables, are accented or unaccented. The principal accent is given to the first note of a measure. Of the four measure notes in common time, the third has also a subordinate accent, as has the third measure note in triple time. There are occasions when a strong accent, or emphasis as it is called, is laid on the part of the measure which is usually unaccented; this the composer indicates by the Italian terms *rinforzando*, *sforzato*, abbreviated *rinf.*, *sf.*

When in the course of a movement silence is required for a time, this is indicated by a rest or rests corresponding to that time; the breve, semibreve, minim, &c., have each their respective rests, which are represented as follows:—

Breve. Semibreve. Minim. Crotchet.

Quaver. Semiquaver. Demi-semiquaver. Semi-semiquaver.



A rest may, like a note, be dotted to indicate the addition of half to its length.

The double bar  consists of two strong vertical

lines, placed at the end of a musical composition, and also at other parts (not necessarily coincident with the end of a measure) where a strain or rhetorical division of a movement terminates. When dotted on one side, all the measures on the side with the dots are to be repeated from the beginning, or from the antecedent double bar.

A tie is an arch placed between two notes on the same degree, to indicate that instead of the two notes written, one note is to be played of the length of both. When the last note of one measure is thus connected with the first of the next measure, the former, though naturally the unaccented note, acquires the emphasis—



When the same arch is drawn over two or more notes not in the same degree, it is called a slur, and

merely indicates that they are to be played smoothly

or fluently (*legato*)



When notes are to be played short, distinct, and detached (*staccato*), a dot is placed over them. A dash implies a greater, and the union of dot and slur a less degree of *staccato*—



The pause  placed over a note indicates a delay in the time of the movement, and a continuance of the sound made on that part of the measure.

The various degrees of softness and loudness which occur in a piece of music are indicated by the letter *f* for *forte*, loud; *p* for *piano*, soft, also *pp* for *pianissimo*, very soft; *mf* for *mezzo forte*, rather loud, and *ff* for *fortissimo*, very loud. A gradual increase of loudness is denoted by the word *crescendo*, or the sign $<$; and a diminution from loud to soft by the word *diminuendo*, or the contrary sign $>$. Many other expressions are used in the body of written music, indicating

slowness, quickness, and the character of execution. The most important of them are explained under separate articles—as are the various musical graces or embellishments known under the names of the Appoggiatura, Beat, Shake, and Turn. Among abbreviations in frequent use are a line drawn over or under a semibreve, or through the stem of a minim or crotchet, to divide it into quavers; or a double line, to divide it into semiquavers. Two minims may be connected to indicate their repetition as quavers. Thus—



Harmony.—We have mentioned that when a string is struck, its harmonics are more or less distinctly heard along with it. This arises from the string spontaneously dividing itself into aliquot parts—as one-half, one-third, one-fourth, one-fifth, one-sixth, one-seventh, &c., of the string. The numbers 2, 3, 4, 5, 6, 7, expressing the relative number of vibrations in a given time, are a measure of the pitch of the note, and placed proportionally to one another, or in the form of a fraction, they are a measure of the interval. The prime numbers 2, 3, 5, and 7, and their compounds, constitute the harmonics of a musical sound; no division by a higher prime number is tolerable to the ear along with the fundamental note, and no sound corresponding to such division is audible in the vibrations of a string—



The degrees of the harmonic scale consist of intervals decreasing in a geometrical ratio from the octave to the minor tone, viz.—

- | | |
|--------------------|---------------------|
| 1 : 2 Octave. | 6 : 7 Gravè third. |
| 2 : 3 Fifth. | 7 : 8 Tone maximus. |
| 3 : 4 Fourth. | 8 : 9 Tone major. |
| 4 : 5 Major third. | 9 : 10 Tone minor. |
| 5 : 6 Minor third. | |



Other intervals more or less consonant are to be found in the harmonic scale, of which the most important is 4 : 7, the grave seventh. From this scale is derived the triad, which we have seen to be the foundation of the diatonic scale, and also the whole theory of chords.

The first five notes of the harmonic scale are the component parts of the major common chord, by far the most consonant chord that can be produced by five notes. Neglecting octaves, its essential notes are the major triad, C E G, or 4, 5, 6, which, as already seen, consists of a fifth divided harmonically into major third and minor third. The root on which a chord is formed, or the note by whose division into aliquot parts the notes of the chord are produced, is called its fundamental bass, and the fundamental bass of the triad C E G is C. The common chord is the triad with the addition of the octave of the root; its proportions are 4, 5, 6, 8.

Every key contains within itself two other triads besides that of the key-note—viz., those of the subdominant and dominant, which have the subdominant and dominant of the key-note respectively for their fundamental basses; and the feeling of satisfaction produced by the diatonic scale arises out of the fact, that its notes belong to a progression of chords formed on a fundamental bass suggested by the ear. This fundamental bass is here indicated on the lower staff—

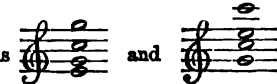

The relative position of the notes of a chord, and consequently its intervals, may be altered by raising one or more of them an octave; and, on the whole, the nearer the intervals approach to their position in the harmonic scale, the purer is the harmony. Close, in contradistinction to dispersed harmony, is when the notes of a chord are so near that no component note could be placed between them. When the fundamental bass of a chord ceases to be its lowest note, the chord is said

to be inverted. Thus  and 

are inversions of the common chord, but not

 where the fundamental bass is still the lowest note.

The minor triad is, as we have seen, a compound chord, whose ratio is 20, 24, 30, taking its minor third from the triad below, and its major third from the triad above. Its fundamental bass is the key-note. The minor mode has, like the major, three triads in each key—those of the tonic, subdominant, and dominant; and the minor common chord admits of the same inversions as the major, by making the third or fifth the lowest note.

The first seven notes of the harmonic scale contain the chord next in consonance to the common chord, the chord of the seventh or dominant harmony. Rejecting octaves, it is the harmonic triad with the addition of the grave seventh, 4, 5, 6, 7, C E G Bb, or G B D F, and admits of three inversions, according as the third, fifth, or seventh is taken instead of the root as the lowest note. This chord belongs to the key of which its fundamental note is the dominant; and in order to satisfy the ear, it requires to be followed by a resolution into the common chord of the key, or one of its inversions, the major third rising a semitone to the key-note, and the seventh descending one degree—

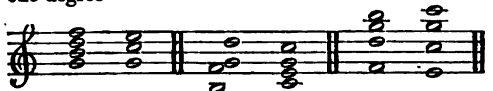

The dominant seventh note is flatter by an interval of 63, 64 than the subdominant of the key, though the two are not distinguishable on keyed instruments. The chord of the dominant seventh is the same in the tonic minor as in the major mode, but differs in its resolution, in respect that it descends a tone instead of a semitone

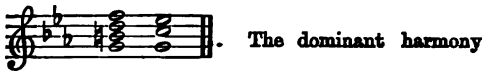

The dominant harmony

affords numerous means of modulating from one key to another. For example, the addition of a dominant seventh to the common chord of a key, effects a modulation into the key of the sub-

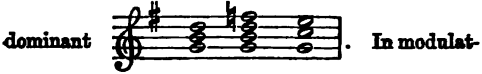

1, the chord of the added ninth, consisting of the dominant harmony (its root generally omitted) with the fifth of the adjacent triad above. 2, 3, and 4, the different forms of the added sixth, or chord of the subdominant. 2 is the triad of the subdominant, with the third of the adjacent triad below, or rather its octave; 3 is the triad of the subdominant, minor mode, with the third of the adjacent triad below; and 4, the same triad with the third of the tonic major to the adjacent triad below. 5, the diminished seventh, a compound of the characteristic notes (B F) of the dominant harmony of the major mode with those (G# D) of the relative minor. 6, 7, and 8, the augmented sixths, all dominant harmonies, resolving into the major tonic. 6, called the Italian sixth (F A D#), is a compound of the characteristic notes (A D#) of the dominant harmony of the minor mode (B D# F A) inverted, with the dominant seventh note (F) of the major triad (C E G) below for a bass; 7, the French sixth (F A B D#), the same as the last, with the addition of the octave to the fundamental bass; 8, the German sixth (F A C D#), compounded of the characteristic notes of the dominant harmony of the minor mode inverted, with the dominant sevenths of the major triads below and above.

All classical harmonies can be reduced to the chords enumerated, varied by inversions, omissions, suspensions, and pedal basses. A pedal bass or organ-point is a bass note sustained through a progression of chords, to only the first and last of which it is the proper bass. The pedal bass of the tonic is often used with the chord of the dominant seventh, the added ninth, and the diminished seventh, and occasionally with other chords: sometimes the pedal harmonies are taken on the dominant instead of the tonic, and the holding note sometimes occupies an upper part instead of the bass—

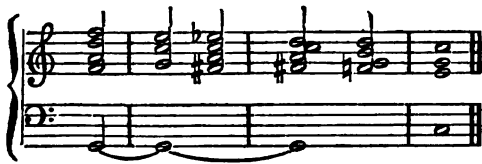

ing into the key of the dominant, the supertonic bears the dominant harmony, and becomes domi-



nant of the new key. For other modulations, we must refer to works on the theory of music.

The following more complex harmonies are also in general use—

A musical composition consists of a succession of notes or of chords subject to certain laws. Like discourse, music has its phrases, periods, and punctuation. When a piece of music continues in the same key, it is said to move by progression, a term used in contradistinction to modulation, where the key is changed. Progression in music of two parts is of three kinds—oblique, when one part repeats or holds on the same note, while the other moves up and down; direct, where both parts move in the same way; and contrary, where one moves up, and the other down. Consecutive chords should in general be connected, either as having some note in common, or as being the chords of closely connected keys. There are certain chords which require a special resolution—i. e., they must be followed by certain other chords; and there are certain progressions which, from harshness, are in ordinary cases to be avoided, more particularly consecutive fifths, and consecutive octaves, the latter, however, being admissible when used merely to strengthen a part. Modulation is generally effected by introducing the chords common to both keys, and the secret of good modulation consists in the skilful choice of intermediate chords. Every regular piece of music is composed in a particular key, in which it begins and ends, and which predominates over all the other keys into which it has modulated. The keys into which a key most readily modulates, are those most nearly related to it—viz., the dominant, the subdominant, and the relative and tonic major or minor. We have seen how modulation may take place by introducing the dominant harmony of the new key or one of its inversions, and in this way the entire harmonic circle of the keys can be made, either by ascending or descending fifths; but in order to effect this change, it will be necessary, on reaching the key of C# with seven sharps, to substitute, by what is called an Enharmonic (q. v.) change, D# with five flats, or vice versa, which on instruments with temperament produces no real change on the pitch, but merely on the names of the notes.

The arrangement of chords which the ear naturally expects at the close of a strain is called a cadence; it corresponds in music to the period which closes a sentence in discourse. It is perfect when the harmony of the dominant precedes the harmony of the key-note, and imperfect when the harmony of the key-note precedes that of the dominant without its seventh.

The imperfect cadence is the most usual termination of a musical phrase, or short succession of measures containing no perfect musical idea. A portion of melody formed of two regular phrases, and containing a perfect musical idea, is called a section, and its regular termination is the perfect cadence.



Music is produced by the human voice, and by a variety of artificial instruments. For the application of the voice to musical purposes, see SINGING. Musical instruments are classified as stringed instruments, wind instruments, and instruments of percussion. In some stringed instruments, as the pianoforte, the sounds are produced by striking the strings by keys; in others, as the harp and guitar, by drawing them from the position of rest. In a third class, including the violin, viola, violoncello, and double bass, the strings are put into vibration with a bow. In wind instruments, the sound is produced by the agitation of an enclosed column of air; some, as the flute, clarinet, oboe, bassoon, flageolet—instruments of wood, and the trumpet, horn, cornet-a-piston, &c., of metal, are played by the breath; in others, as the organ, harmonium, and concertina, the wind is produced by other means. In the two last-named instruments, the sound is produced by the action of wind on free vibrating springs or reeds. Instruments of percussion are such as the drum, kettle-drum, cymbals, &c. The chief peculiarities of the more important musical instruments are noticed in special articles.

Musical compositions are either for the voice, with or without instrumental accompaniment, or for instruments only. Of vocal music, the principal forms may be classed as church music, chamber music, dramatic music, and popular or national music. The first includes plain song, faux-bourdon, the chorale, the anthem, the sacred cantata, the mass and requiem of the Roman Catholic Church, and the oratorio. Vocal chamber music includes cantatas, madrigals, and their modern successors, glees, as also recitatives, arias, duets, trios, quartets, choruses, and generally all forms, accompanied or unaccompanied, which are chiefly intended for small circles. Dramatic music comprehends music united with scenic representation in a variety of ways, in the ballet, the melodrama, the vaudeville, and the opera, in which last, music supplies the place of spoken dialogue. Instrumental music may be composed for one or for more instruments. The rondo, the concerto, the sonata, and the fantasia generally belong to the former class; to the latter, symphonies and overtures for an orchestra, and instrumental chamber music, including duets, trios, quartets, and other compositions for several instruments, where each takes the lead in turn, the other parts being accompaniments. These and other forms of composition will be found noticed separately.

History of Music.—A certain sort of music seems to have existed in all countries and at all times. Even instrumental music is of a very early date: representations of musical instruments occur on the Egyptian obelisks and tombs. The music of the Hebrews is supposed to have had a defined rhythm and melody. The Greeks numbered music among the sciences, and studied the mathematical proportions of sounds. Their music, however, was but poetry sung, a sort of musical recitation or intoning, in which the melodic part was a mere accessory. The Romans borrowed their music from the Etruscans and Greeks, and had both stringed instruments and wind instruments.

The music of modern Europe is a new art, with

which nothing analogous seems to have existed among the nations of antiquity. The early music of the Christian Church was probably in part of Greek, and in part of Hebrew origin. The chorale was at first sung in octaves and unisons. St Ambrose and Gregory the Great directed their attention to its improvement, and under them some sort of harmony or counterpoint seems to have found its way into the service of the church. Further advances were made by Guido of Arezzo, to whom notation by lines and spaces is due, but the ecclesiastical music had still an uncertain tonality and an uncertain rhythm. Franco of Cologne, in the 13th c., first indicated the duration of notes by diversity of form. The invention of the organ, and its use in accompanying the chorale, had a large share in the development of harmony. Along with the music of the church, and independently of it, a secular music was making gradual advances, guided more by the ear than by science; it seems to have had a more decided rhythm, though not indicated as yet by bars. The airs which have become national in different countries were developments of it, but it had its chief seat in Belgic Gaul; and the reconciliation of musical science with musical art begun in Flanders by Josquin Depres in the 15th c., was completed in the 17th c. by Palestrina and his school at Rome, and reacted eventually on the ecclesiastical style. The opera, which appeared nearly contemporaneously with the Reformation and revival of letters, greatly enlarged the domain of music. Italy advanced in melody, and Germany in harmony. Instrumental music occupied a more and more prominent place. Corelli's compositions exalted the violin. Lulli and Rameau, with their ballet-like music, seized the characteristics of French taste, till the German Gluck drove them out of the field. The scientific and majestic fugue reached its highest perfection under J. S. Bach. The changes introduced in ecclesiastical music in England at the Restoration gave birth to the school of Purcell; and a little later, England adopted the German Handel, who was the precursor of Haydn, Mozart, Beethoven, Spohr, and Mendelssohn. A school has recently sprung up in Germany, of which Wagner is the chief exponent, whose aim is to create a new style of music; but a number of the works of this school of 'music of the future' are only remarkable for purposeless modulation, and want of coherence.

For further information, reference is made to Pepusch's *Treatise on Harmony*, Dr Calcott's *Musical Grammar*, Sir John Hawkins's and Dr Burney's *History of Music*, Dr Marx's *Allgemeine Schule der Musik*, and Brown's *Elements of Musical Science*.

MUSK, or MUSK DEER (*Moschus moschatus*), a ruminant quadruped, the type of the family *Moschida*. This family differs from *Cervida* (Deer) in the want of horns, and in the long canines of the males, projecting beyond the lips. The M. is an inhabitant of the elevated mountainous regions and table-lands of Central Asia. The habits of the M. are very similar to those of the Chamois. Its favourite haunts are the tops of pine-covered mountains, but its summer range extends far above the region of pines. Its habits are nocturnal and solitary, and it is extremely timid. It is much pursued

MUSK DUCK—MUSK OX.

by hunters on account of its odoriferous secretion, which has been known in Europe since the 8th c., and is much valued as a perfume. This secretion, *musk*, is produced in a glandular pouch situated in the hinder part of the abdomen of the males; and its natural use seems to be that of increasing sexual attractiveness. The musk-bag is formed by an infolding of a portion of the skin of the belly, within which a number of membranes are contained, and between these membranes are glands by which the musk is secreted. When newly taken from the animal, musk is soft and almost resembles an ointment; it is reddish-brown, and has an excessively powerful odour. Very little of it reaches Europe unadulterated.—Musk is usually imported either in the form of *grain-musk*, that is, the musk which has been collected chiefly from stones upon which it has been deposited by the animal, in which state it is a coarse powder of a dark-brown colour; or in the *pod*, that is, in the musk-sac, which is cut altogether from the animal, and dried with the musk inside. Of both kinds the annual importations are about 15,000 ounces per annum, chiefly from China and India. Small quantities are used in medicine, but the greater portion is employed by the perfumers. It is imported in small boxes or cattles, often covered with bright-coloured silk, and each containing 25 pods. The kinds generally known in trade are the Tonquin or Chinese, which is worth two guineas an ounce in the pod, or £3, 10s. per ounce in grain; and the Cabardine, Kabardine, or Siberian, which is always imported in pod, and is very inferior, being only worth about 15s. an ounce.

The flesh of the M. is sometimes eaten, but has a very strong flavour. The season of migration from the highest and coldest to more temperate regions, is that at which the M. is chiefly pursued.—No other animal of the family *Moschidae* yields the perfume called musk, or has more than a rudimentary musk-bag. The other species of *Moschidae* belong to the genus *Tragulus*, and receive the popular name *Chevrotaïn*. They have a very elongated muzzle; and the accessory hoofs assume the form of appressed conical claws. They inhabit the thick woody copses or jungles of the Indian islands, and are the smallest of ruminant quadrupeds. Some of them are not larger than a hare. Their tusks are not so long as those of the Musk. One of them, the *Napu* of Java and Sumatra, has the smallest blood corpuscles of any known animal.

MUSK DUCK (*Cairina moschata*), a species of



Musk Duck (*Cairina moschata*), Male and Female.

duck, of the non-oceanic section of *Anatide* (see DUCK); of a genus characterised by an elevated

tubercle at the base of the bill, the edges of the mandibles sinuated, the face and lores covered with a bare tuberculated skin, the wings furnished with a knob or spur at the bend. The M. D., or Muscovy Duck—so called, however, through mistake, and receiving its name M. D. more appropriately from its musky smell—is a native of the warm parts of America. It is very plentiful in Guiana, in that part of the year when winter reigns in the north. It is a larger bird than the common duck, in its wild state almost black, with glosses of blue and green, and white wing-coverts, but varies considerably in domestication. It is often to be seen in poultry-yards in Britain, but is rather curious than profitable. It hybridises readily with the common duck, but the hybrid is sterile.—The M. D. of Australia is a very different species, belonging to the genus *Biziura*.

MUSK OX (*Bos moschatus*, or *Ovibos moschatus*), an animal of the family *Bovidae*, regarded as a connecting-link between oxen and sheep. It inhabits the most northern parts of America, enduring the winter even of Melville Island and Banks' Land; but, like many other animals, it is partially migratory, some individuals or herds seeking more southern regions and better pastures on the approach of winter, whilst some remain in the furthest north.



Musk Ox (*Bos moschatus*).

It is not found in Greenland, Spitzbergen, or Siberia. The M. O. is scarcely equal in size to the smallest of Highland cattle, but appears larger from the profusion of long matted woollen hair with which it is covered, and which hangs almost to the ground. The head is covered with long hair as well as the body, the face alone having short hair. Beneath the long hair there is a thick coat of exquisitely fine wool. The head is large and broad; the forehead convex; the extremity of the muzzle hairy. The horns are very broad at the base, and in the male meet on the forehead; they do not rise but bend down on each side of the head, and curve outwards and upwards towards the tip, which tapers to a sharp point. They are about two feet long measured along the curvature; and about two feet in girth at the base; a pair of them sometimes weighing sixty pounds. The limbs are short, the legs have short hair. The tail is very short, and is covered with long hair, so that it is undistinguishable to the sight. The general colour is brown. The female is smaller than the male, has shorter hair on the chest and throat, and smaller horns. The frog of the hoof is short, and partially covered with hair; the foot-marks are very similar to those of the reindeer.

The M. O. feeds on grass, twigs, lichens, &c. It is fleet and active, very sure-footed on rocky ground, and ascends or descends very steep hills with great ease. It is gregarious; the herds generally number

MUSK PLANT—MUSKETRY.

thirty or forty. The powerful horns are excellent weapons of defence against wolves and bears, which are often not only repelled but killed. When musk oxen are assailed by firearms, however, they generally huddle more and more closely together, and do not even seek safety by flight, so long as the assailants are unseen. The flesh is much prized by the Esquimaux, but retains much of the strong musky odour which characterises the living animal. The horns are used for various purposes; particularly the wide base for vessels. The fine wool has been spun and woven into a fabric softer than silk. No attempt has yet been made to domesticate the M. O.; which, however, seems worthy of it, and suitable for all cold regions.

MUSK PLANT, MUSK ROOT, MUSK TREE, MUSK WOOD. Different parts of a number of plants smell more or less strongly of musk. Among these are the common little Musk Plant (see *MIMULUS*), the Musk-tree of Van Diemen's Land (see *ASTER*), and the Musk Ochro (see *HIBISCUS*).—The musk-tree of Jamaica (*Moechocyllum Swartzii*) belongs to the natural order *Meliaceae*. It emits from all parts a smell of musk.—All parts of *Guarea grandifolia*, another tree of the same order, a native of the West Indies, sometimes called musk wood, also smells strongly of musk, but particularly the bark, which is used in perfumery.—The drug called MUSK ROOT or SAMBUL is brought from the East, and is the root of a plant supposed to be of the natural order *Umbelliferae*; but the plant is unknown, nor is it certain whether its native country is Persia, or some more remote region of Central Asia. It has a pure musky odour, and is used as a substitute for musk.

MUSK RAT, or DESMAN (*Mygale* or *Galemys*), a genus of insectivorous quadrupeds of the Shrew (q. v.) family (*Sorexidae*), differing from the true Shrews (*Sorex*) in having two very small teeth between the two large incisors of the lower jaw, and the upper incisors flattened and triangular. Behind these incisors are six or seven small teeth (lateral incisors or false canine teeth) and four jagged molars. The muzzle is elongated into a small flexible proboscis, which is constantly in motion. The eyes are very small; there are no external ears; the fur is long, straight, and divergent; the tail long, scaly, and flattened at the sides. All the feet have five toes, fully webbed; and the animals are entirely aquatic, inhabiting lakes and rivers, and making holes in the banks with the entrance from beneath the surface of the water. Only two species are known, one (*M.* or *G. Pyrenaica*) about

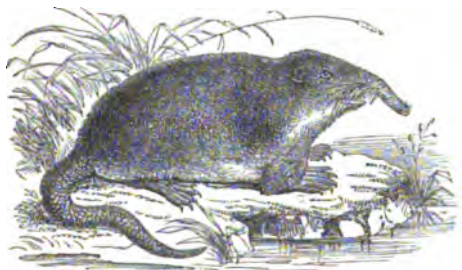

Musk Rat, or Desman (*Mygale Pyrenaica*).

eight inches long, with tail as long as the body, a native of the streams of the Pyrenees; another larger species (*M.* or *G. moschata*), very plentiful in the Volga and other rivers and lakes of the south of Russia, nearly equal in size to the common hedgehog, with tail about three-fourths of the length of

the body. The Russian desman is blackish above whitish beneath; it has long silky hair, with a softer felt beneath, and its fur is held in some esteem. Desman skins, however, are chiefly valued on account of the musky odour which they long exhale, and which is derived from a fatty secretion produced by small follicles under the tail of the animal. The desman feeds on leeches, aquatic larvæ, &c., searching for them in the mud by means of its flexible proboscis. It seldom, if ever, voluntarily leaves the water, except in the interior of its burrows, which are sometimes twenty feet long.

MUSK RAT (*Sorex murinus*), an Indian species of Shrew (q. v.), in size about equal to the common brown rat, in form and colour much resembling the common shrew of Britain, but remarkable for the powerful musky odour of a secretion which proceeds from glands on its belly and flanks. This odour adheres most pertinaciously to any object with which the animal may come in contact, and provisions are often utterly spoiled by it. Even wine and beer are said to be spoiled by it, in spite of the glass and cork of the bottle; although the probability is much greater that it adheres to the outside of the bottle, and that the liquid is spoiled as it is poured out. One of the Indian names of this animal is *Sondeli*.

MUSK RAT. See MUSQUASH.

MUSKET, or MUSQUET (Fr. *mousquet* ; from *mouchet*, a sparrow-hawk ; in the same way that other shooting-implements were named *falcon*, *falconet*, &c.), the firearm for infantry soldiers, which succeeded the clumsy harquebuss, and has recently itself given way before the Rifle (q. v.). The first muskets were matchlocks; after which came wheellocks, snaphans or snaphance muskets; and lastly, percussion muskets, which were a vast improvement, both for accuracy and lightness, on all which had gone before. Compared, however, to the present rifle, the musket—familiarily known as Brown Bess (possibly a corruption of Ger. *büchse*, a hollow tube or gun)—was a heavy, ugly, and ineffective weapon. The following is a table of the ranges attained, on an average, by the musket, the Enfield, and the Whitworth rifles :

	Musket.	Enfield Rifle.	Whitworth Rifle.
Accurate fire,	Yards. 100	Yards. 600	Yards. 900
Effective against workmen,	150	800	1300
Effective against troops in column,	200	1000	1500

MUSKETOO'N, an obsolete weapon, was a short musket of very wide bore, carrying a ball of five ounces, and sometimes bell-mouthed like a blunderbuss.

MUSKETRY, SCHOOLS OF. When the introduction of the Minié rifle in the French service, and the subsequent arming of the British troops with the still more delicate Enfield rifle in 1851, brought the accuracy of a soldier's fire to be an important consideration in estimating his value (which with the old musket was not the case, as it was proverbial that the bullet never hit the point aimed at however carefully), the English government at once saw the necessity of providing instruction in the manipulation of the rifle. Accordingly, instructors of musketry were attached to the troops, one to each regiment; and to give further encouragement, a school was established at Hythe in 1854, under Colonel (now General) Hay, where lessons on the theory of the arm, and practice in its actual employment, were the sole occupation of the day. Officers and promising men were sent there as fast as the

accommodation permitted; and after a course of a few weeks were able to return to their corps, and become instructors to their comrades, so that in a comparatively short time the shooting of the whole army rose in a surprising degree. Whereas, before the establishment of this school, the English stood low in the scale of shooting, the competitions held during recent years at Wimbledon have demonstrated that no nation can now excel them as marksmen. The formation of the volunteer corps, in 1859, led to a greatly increased demand for musketry instruction, which the government met by forming a second school of musketry—on the same footing as that of Hythe—at Fleetwood, where, on the vast sands of Morecambe Bay, the troops and volunteers of Scotland, Ireland, and the northern English counties find the necessary teaching. The two schools are superintended by an inspector-general of musketry instruction, with subordinate instructors. The inspector-general is responsible also for the instruction throughout the regiments all over the world. Under him are the district inspectors, regimental instructors, and sergeant instructors.

The total cost of musketry instruction for 1864 amounts to £37,095.

MU'SLIN, a cotton fabric of Oriental origin, is said to have derived its name from the town of Mosul, in Mesopotamia, where this material was at one time very largely manufactured. At present no such trade exists there; and for muslins, of the common kinds at least, the Indian market depends upon the manufactures of England and France. But no European manufacturer has ever been able to rival the wonderfully fine muslins of Dacca. This does not arise so much from the fineness of the yarn, although that too is very great, but from the marvellous fineness conjoined with a most delicate softness to the touch. The fineness of the yarn is so great, that until lately no machinery could produce anything like it; a piece of Dacca muslin, shewn in the International Exhibition (1862), was 31 feet in length by 3 feet in width, and contained in a square inch 104 warp threads and 100 weft threads, yet the entire piece weighed only 3½ ounces. A French manufacturer, M. Thival Michon of Tavare, has made a muslin of English yarn spun by the Messrs Houldsworth of Manchester, which surpassed the finest Dacca in the excessive thinness of the yarn, but it wanted its delicate softness. Muslin is much less compact in its texture than calico, indeed it more nearly resembles gauze in appearance; but it is woven plain, without any twisting of the weft threads with those of the warp. The manufacture of muslins in Great Britain and France is very extensive, especially printed muslins, in which the patterns are produced by the same processes as in calico-printing. See WEAIVING.

MU'SNUD, a Persian throne of state.

MUSOPHA'GIDÆ. See PLANTAIN-EATER.

MUSQUASH, MUSK-RAT, or ONDATRA (*Fiber zibethicus*), a rodent quadruped, a native of North America. It is the only known species of the genus to which it belongs, which is characterised by dentition similar to that of the voles; in some other characters more nearly agreeing with the beaver. The M. is in shape nearly similar to the brown rat; the head and body are about 15 inches in length, the tail ten inches. The whole body is covered with a short downy dark-brown fur, intermixed with longer and coarser hairs. It is common in almost all parts of North America, from lat. 30° to lat. 69°, except in the southern alluvial districts. It is a very aquatic animal, seldom wandering from the rivers, lakes, or marshes

in which it makes its abode. The fur is in demand, and forms an article of commerce—skins in large number being still exported from America to Britain and other European countries. The M. burrows in the banks of streams and ponds; the entrances



Musquash (*Fiber zibethicus*).

of its burrows being always under water, so that it must dive to reach them. In marshes, the M. builds a kind of hut, collecting coarse grasses and mud, and raising the fabric from two to four feet above the water. The flesh of the M., at those seasons when it is fat, is in some request among the American Indians, and is said to be not unpalatable.

MUSSEL (*Mytilus*), a genus of lamellibranchiate molluscs, the type of the family *Mytilidæ*, which, however, is much more restricted than the Linnæan genus *Mytilus*. The *Mytilidæ* belong to the division of *Lamellibranchiata*, called by Lamarck *Dimyaria*, having two *adductor* muscles—muscles employed in closing the valves of the shell. The mantle has a distinct anal orifice; the foot is small; and there is a large *Byssus* (q. v.), which is divided into fibres to its base. The valves of the shell are equal; the hinge is destitute of teeth. Some, but few, of the species are found in fresh-water. See DREISSENA. Some (*Lithodomus*) burrow in stone. How they do it is utterly unknown, but they do burrow even in the hardest stone; and some small tropical species excavate for themselves holes in the shells of great limpets. The *Lithodomi* are sometimes called *Date-shells*. Some of them are very beautiful, which is the case also with the true mussels, after the epidermis is removed. Even the COMMON M. (*M. edulis*) then exhibits beautiful veins of blue. This species is very abundant on the British coasts, and is much used as bait by fishermen. It is gregarious, and is found in vast beds, closely crowded, adhering by the byssus to rocks, &c. These beds are usually uncovered at low-water. The shell is oblong; at its greatest size about three inches long, and an inch and a half broad. Mussels, when young, move about by means of the foot, with which they lay hold of objects and drag themselves along, until they find some suitable spot to anchor themselves by a byssus. If detached, they soon find another anchorage. In an aquarium they readily attach their byssus-threads even to the smooth glass, and the threads may be broken more easily than separated from the glass. An ingenious and important application of the strength of these threads has been made by the French, to render Cherbourg breakwater more secure by binding the

MUSSEL—MUSTARD.

loose stones together, for which purpose it was planted with tons of mussels. The Common M. is much used as an article of food, and is generally found quite wholesome; yet it sometimes proves poisonous, particularly in spring and summer, either causing blotches, swellings, and an eruption, accompanied with asthma, or a kind of paralysis, and even sometimes producing delirium and death. Emetics and other are the chief remedies in cases of this kind. Some places are famous for the excellent quality of their mussels, and particularly places in tidal estuaries. Mussels are sometimes brought from other parts of the coast to the mouths of rivers to fatten and improve in flavour before being sent to market.—Several other species of *M. (Mytilus* and closely allied genera) are found on the British shores.—The family abounds in most parts of the world.—A very large species of *M. (Mytilus choros)*, and of very fine quality, is found at Chiloe.—Some of the *Lithodomi* are highly esteemed as food; and means are taken in some places on the shores of the Mediterranean to promote the increase of their numbers.

MUSSEL, FRESH-WATER. See FRESH-WATER MUSSEL.

MUSSELBURGH, a small seaport and royal and parliamentary burgh of Scotland, in the county of Edinburgh, is situated at the mouth of the Esk, 6 miles east of Edinburgh. East of the burgh is the scene of the battle of Pinkie, in which the Scots were defeated by the English in 1547. On the west side of the Esk is the village of Fisharrow, a suburb of the burgh, where many of the inhabitants are engaged in fishing. Tanning, leather-dressing, and the manufacture of sailcloth, nets, and salt are carried on. The harbour at Fisharrow is frequented by coasting craft, and by small vessels from Holland and the Baltic. Timber, oil-cake, bark, seeds, and hides are imported; coal is the chief export. On the 'links,' a famous golfing-ground, the Edinburgh races take place annually. M. unites with Leith and Portobello in sending a member to parliament. Pop. (1861) 7423.

MU'STANG. See HORSE.

MUSTARD (*Sinapis*), a genus of plants of the natural order *Crucifera*, having yellow flowers, and linear or oblong pods, which terminate in a sword-shaped and compressed or 4-cornered beak, and contain one row of seeds. The seeds are globular, and their Cotyledons (q. v.) conduplicate.—The most important species is BLACK M. (*S. nigra*), an annual, which grows wild in fields and by waysides in the middle and south of Europe, and is not uncommon in the southern parts of Britain. Its pods are bluntly 4-angled, smooth, erect, and lie close to the stem, their valves 1-nerved; the leaves are smooth, the lower leaves lyrate, the upper leaves linear-lanceolate. The seeds are brownish black.—WHITE M. (*S. alba*), also a native of most parts of Europe, and of the southern parts of Britain, is an annual, having divergent pods covered with stiff hairs, the valves 5-nerved, the seeds yellowish, the leaves pinnatifid.—Both these species are cultivated in England and elsewhere, for their seeds, which are ground into powder and mixed with water, to make the well-known condiment called *Mustard*. The powder of the seeds is also much used in medicine as a rubefacient. The use of M. as a condiment is often found favourable to digestion. M. seeds depend for their pungency on a principle which, when water is added to Black M., forms *Volatile Oil of Mustard*. (See next article.) There is also in the seeds a bland fixed oil, *Oil of M.*, which is obtained from them by expression, and constitutes about 28 per cent. of their weight. The cake which remains

after the oil is expressed, is too acrid to be freely used for feeding cattle. It is Black M. which is chiefly cultivated, its seed being more pungent and powerful than that of White M.; but there is more difficulty in removing the skin of its seed than that of White M., which is therefore often preferred, but more in England than on the continent of Europe. M. requires a very rich soil. It is cultivated on the alluvial lands of the level eastern counties of England. Wisbeach, in Cambridgeshire, is the great M. market of England.—White M. is often sown in gardens and forced in hothouses, to be used in the seed-leaf as a small salad, having a pleasant pungency. It is also sometimes sown for feeding sheep, when turnip or rape has failed, being of very rapid growth, although inferior in quantity of crop.—WILD M., or CHARLOCK (*S. arvensis*), which is distinguished by turgid and knotty pods with many angles and longer than the two-edged beak, is a most troublesome annual weed in cornfields in Britain, often making them yellow with its flowers in the beginning of summer. Its seeds are said to have yielded the original *Durham M.*, and are still gathered for mixing with those of the cultivated species. The bland oil of the seeds is used for lamps.—PEKIN M. (*S. Pekinensis*) is an annual, very extensively cultivated in China, its leaves being used as greens. It is quite hardy in the climate of Britain.—INDIAN M. (*S. ramosa*) is extensively cultivated in India for its seeds, which are used as a condiment; as are those of *S. dichotoma* and *S. glauca*, also cultivated in India. The oil of the seeds is much used throughout India for lamps.—HILL M. is a different genus, *Bunias* (q. v.).—The M. TREE of Scripture is supposed to be *Salvadora Persica*, a small tree of the natural order *Salvadoraceae*, a small order allied to *Myrsinaceae*. It abounds in many parts of the East. The seed has an aromatic pungency, and is used like mustard. The fruit is a berry with a pungent taste.

Manufacture.—The manufacture of M. as it was originally used in this country, and as it still is on the continent, consisted in simply grinding the seed into a very fine meal. A false taste, however, arose for having an improved colour, and the flour of mustard was introduced, in which only the interior portion of the seed is used, the husk being separated, as the bran is from wheat flour. This causes a great loss of flavour, as the pungent oil, on which the flavour chiefly depends, exists in greatest abundance in the husk.—Hence other materials, such as capsicum powder, and other very pungent matters, are added to bring up the flavour, and wheat flour and other substances are added to increase the bulk and the lightness of colour. Indeed, so many sophistications have been added, that the M. of the English tables can no longer be regarded in any other light than an elaborately compounded condiment, for which each manufacturer has his own particular recipe.

MUSTARD, OIL OF. The seeds both of the black and the white mustard yield by expression a large quantity of a bland fixed oil, but they do not contain any essential or volatile oil ready formed. It is only the black mustard which by distillation yields the compound usually known as the oil or essence of mustard, and which is in reality sulphocyanide of allyl (see GARLIC, OIL OF) contaminated with a little brown resinous matter, from which it may be freed by simple re-distillation.

When first obtained, it is a colourless fluid, which gradually becomes yellowish. It has a painfully pungent odour and acrid taste; and when applied to the skin, it speedily raises a blister. It is soluble in all proportions in alcohol, but dissolves very sparingly in water. In the article already

referred to, it has been shewn that this oil and oil of garlic are naturally convertible into one another; in combination with ammonia it forms a compound which is termed *thioinnamine*, and which combines directly with acids like a true organic base. Its mode of formation is explained by the equation—



By digesting oil of mustard with alkalis, or with hydrated oxide of lead, we also obtain a feeble base termed *sinapoline*, whose formula is $\text{C}_{14}\text{H}_{12}\text{N}_2\text{O}_2$.

The oil is formed in much the same way as the Volatile Oil of Almonds (q. v.). The black mustard contains the potash salt of a compound termed *myronic acid*, and a peculiar coagulable nitrogenous ferment, which, when the crushed seed is moistened with water, act upon each other, and develop the oil. It is the gradual formation of this oil, when powdered mustard and warm water are mixed, that occasions the special action of the common mustard poultice. The pungency of mustard as a condiment, of horse-radish, &c., is mainly due to the presence of this oil.

MUSTELIDÆ, a family of digitigrade Carnivora (q. v.), mostly forming the genus *Mustela* of Linnæus; now divided into a number of genera,

in which are ranked the weasel, ermine or stoat, sable, marten, ferret, polecat, mink, skunk, &c. The *M.* are distinguished by the elongated form of the body, and the shortness of the limbs; also by having generally four or five molars on each side in the upper jaw, and five or six in the lower. On each side of both jaws there is a single tubercu-

late tooth. All the feet have five toes. The skull is much elongated behind the eyes. The *M.* display great litheness and suppleness of movement. They are very carnivorous. Otters are ranked among the mustelids.

MUSTER (It. *mostrare* from Lat. *monstrare*, to shew) is a calling over of the names of all the men composing a regiment or a ship's company. Each man present answers to his name, those not answering being returned as absent. The muster-roll from which the names are called is the paymaster's voucher for the pay he issues, and must be signed by the commanding officer, the adjutant, and himself. The crime of signing a false muster-roll, or of personating another individual at a muster, is held most severely punishable—by imprisonment and flogging for a common soldier, by immediate cashiering in the case of an officer. In regiments of the line, a muster is taken on the 24th of each month; in ships of war, weekly. The muster after a battle is a melancholy proceeding, intended to shew the casualties death has wrought. In early times, before the army was a standing force, and when each captain was a sort of contractor to the crown for so many men, the muster was most important, as the only security the sovereign had that he really obtained the services of the number of men for whom he paid. Accordingly, any fraud, as making a false return, or as mustering with his troop men not actually

serving in it, was by the Articles of War of Henry V. made punishable with death for the second offence, and by Charles I. with death 'without mercy' for even the first such crime; while any person abetting in any way in the fraud shared the penalty.

MU'SULMÁN, *Mosleman*, a Mohammedan (from Arab. *Salama*), equivalent to Moslem, of which word it is, properly speaking, the plural; used in Persian fashion for the singular. We need hardly add that this Arabic plural termination of 'án,' has nothing whatever to do with our word *man*, and that a further English plural in *men*, is both barbarous and absurd.

MUTE, a small instrument used to modify the sound of the violin or violoncello. It is made of hard wood, ivory, or brass, and is attached to the bridge by means of a slit, a leg of it being interjected between every two strings. The use of the mute both softens the tone, and imparts to it a peculiar muffled and tremulous quality, which is sometimes very effective. Its application is indicated by the letters *c. s.*, or *con sordino*, and its discontinuance by *a. s.*, or *senza sordino*. The mute is sometimes used for the cornet, being inserted into the bell of the instrument, thereby subduing the sound, and producing the effect of great distance.

MUTINY, if—as commonly supposed—derived from the Latin *mutio*, a muttering, would seem to have applied originally rather to seditious complaining and conspiring than to actual deeds of violence. However that may be, the term has long included behaviour either by word or deed subversive of discipline, or tending to undermine superior authority. Till lately, mutiny comprised speaking disrespectfully of the sovereign, royal family, or general commanding, quarrelling, and resisting arrest while quarrelling; but these offences have now been reduced to the lesser crime of 'mutinous conduct.' The acts now constituting mutiny proper are, exciting, causing, or joining in any mutiny or sedition; when present thereat, failing to use the utmost effort to suppress it; when, knowing of a mutiny or intended mutiny, failing to give notice of it to the commanding officer; striking a superior officer, or using or offering any violence against him, while in the execution of his duty; disobeying the lawful command of a superior officer. The punishment awarded by the Mutiny Act to these crimes is, if the culprit be an officer, death or such other punishment as a general court-martial shall award; if a soldier, death, penal servitude for not less than four years, or such other punishment as a general court-martial shall award. As the crime of mutiny has a tendency to immediately destroy all authority and all cohesion in the naval or military body, commanding officers have strong powers to stop it summarily. A drum-head court-martial may sentence an offender, and if the case be urgent, and the spread of the mutiny apprehended, the immediate execution of the mutineer may follow within a few minutes of the detection of his crime. It, however, behoves commanding officers to exercise this extraordinary power with great caution, as the use of so absolute an authority is narrowly and jealously watched. To prevent mutiny among men, the officers should be strict without harshness, kind without familiarity, attentive to all the just rights of their subordinates, and, above all things, most particular in the carrying out to the very letter of any promise they may have made.

MUTINY ACT is an Act of the British parliament, passed from year to year, investing the crown with large powers to regulate the good government of

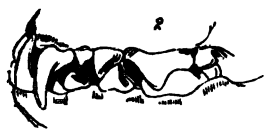

Dentition of Mustelidæ.

the army and navy, and to frame the articles of war. By the Bill of Rights, the maintenance of a standing army in time of peace, unless by consent of parliament, was declared illegal, and from that time the number of troops to be maintained, and the cost of the different branches of the service, have been regulated by an annual vote of the House of Commons. But parliament possesses a further and very important source of control over the army. Soldiers, in time of war or rebellion, being subject to martial law, may be punished for mutiny or desertion; but the occurrence of a mutiny in certain Scotch regiments soon after the Revolution, raised the question, whether military discipline could be maintained in time of peace; and it was decided by the courts of law, that, in the absence of any statute to enforce discipline and punish military offences, a soldier was only amenable to the common law of the country: if he deserted, he was only liable for breach of contract, or if he struck his officer, to an indictment for assault. The authority of the legislature thus became indispensable to the maintenance of military discipline, and parliament has, since 1689, at the beginning of every session, conferred this and other powers in an act called the Mutiny Act, limited in its duration to a year. Although it is greatly changed from the form in which it first passed, 175 years ago, the annual alterations in this act are now very slight, and substantially it has a fixed form. The preamble starts with the above quoted declaration from the Bill of Rights, and adds, that it is judged necessary by the sovereign and parliament that a force of such a number should be continued, 'for the safety of the United Kingdom, the defence of the possessions of the crown, and the preservation of the balance of power in Europe;' while it gives authority to the sovereign to enact Articles of War for the control and government of the force granted. The act comprises 98 clauses, of which the first five specify the persons liable to its provisions—viz., all enlisted soldiers or commissioned officers on full pay, whether of the regular army, militia, or yeomanry. Clauses 6—14, treat of court-martial, their procedure and powers. Clauses 15—28, relate to crimes and their punishment, the leading offences being mutiny, desertion, cowardice, treason, insubordination, for each of which death may be the penalty; frauds, embezzlement, &c., for which penal servitude is awarded. Clauses 29—33, provide for the government of military prisons, and for the reception of soldiers in civil jails, under the sentences of courts-martial. Clauses 34—37, enact rules to guide civil magistrates in apprehending deserters or persons suspected of desertion. Clause 38 refers to furlough; 39—41, on the privileges of soldiers, enact that officers may not be sheriffs or mayors; that no person acquitted or convicted by a civil magistrate or jury be tried by court-martial for the same offence; and that soldiers can only be taken out of the service for debts above £30, and for felony or misdemeanour. Clauses 42—59, have reference to Enlistment (q. v.); 60—73, to billets, carriages, and ferries, providing for the compulsory conveyance and entertainment of troops by innkeepers under certain eventualities at fixed charges. Clauses 74 and 75 relate to the discharge of soldiers; and the remaining 23 clauses advert to miscellaneous matters, and the penalties under the act on civil functionaries who neglect to comply with its requirements. The Mutiny Act has, with one exception, been annually renewed; it has, however, several times been allowed to expire for a few days before its successor has received the royal assent.

MUTUAL INSTRUCTION. See **MONITORIAL SYSTEM.**

MU'TUKE, a plain block under the corona of the cornice of the Doric style, similar in position to the modallio of the Corinthian order, and having a number of guttas or drops worked on the under side. See **ENTABLATURE.**

MUTUUM is a term used in Scotch Law, borrowed from the Roman law, to denote a contract of loan of a certain kind of things, as corn, wine, money, which are consumed in the use, and as to which the borrower is bound to restore as much of the same kind at some future time.

MUZA IBN NOSEYR, the Arab conqueror of Spain, was born 640 A.D. He displayed great bravery and high military talents in the contests of that turbulent period, so much so that he was appointed by the calif general of the army which was raised for the conquest of Africa in 698—699. After an insignificant expedition into the interior of Africa, he set out in 707 for Mauritania, conquering the kindred tribes of Eastern Barbary, and enrolling their warriors under his standard; and by 709, the whole of Northern Africa, including the Gothic strongholds on the coast, acknowledged the authority of the calif. At this period the Gothic monarchy in Spain was in a state of complete disorganisation, and M., seizing the favourable opportunity thus presented, sent his lieutenant, Tarik Ibn Zeiad, in April 711 to make an incursion into Spain. Tarik landed at Gibraltar, marched inland to the banks of the Guadaleta, where he was met by Roderic the Gothic king. In the battle which ensued, the Goths were decisively vanquished, their king perished in the waters of the Guadaleta, and the whole of Southern Spain lay at the mercy of the victor. M., on hearing of these successes, sent orders to Tarik to halt for further instructions; but the lieutenant, flushed with success, pressed on to the very centre of Spain, and seized Toledo, the capital of the Gothic kingdom. M. immediately set out for Spain at the head of 18,000 men (June 712), took Seville, Carmona, Merida, and other towns, and then marched upon Toledo, where he joined Tarik, whom he caused to be bastinadoed and incarcerated, but afterwards reinstated in obedience to an order from the calif. M. then marched first north-west and then east, subduing the country as he went; he then crossed the Pyrenees into France, but soon after returned to Spain, where he and Tarik received messages from the calif, commanding their immediate presence at Damascus; Tarik immediately obeyed, but M. delayed till a second message was sent to him. On reaching Damascus, he was treated with neglect, and, on the accession of the Calif Suleiman, was cast into prison, and mulcted in 200,000 pieces of gold; his two sons were deprived of their governments of Kairwan and Tangier; and the third son, who governed Spain in his father's absence, was beheaded, and his head sent to Muza. M. died soon after in the greatest poverty, at Hedjaz, 717 A.D.

MYCELIUM, in Botany, a development of vegetable life peculiar to *Fungi*, but apparently common to all the species of that order. The *spawn* of mushrooms is the Mycelium. The M. appears to be a provision for the propagation of the plant where its spores may not reach, its extension in the soil or matrix in which it exists, and its preservation when circumstances are unfavourable to its further development. It consists of elongated filaments, simple or jointed, situated either within the matrix or upon its surface. It is often membranous or pulpy. The development of the fungus in its proper form seems to be ready to take place, in proper circumstances, from any part of the Mycelium. *Fungi* often remain long in the state of M., and many kinds

of *M.* have been described as distinct species and formed into genera. Fries has rendered great service to botany in investigating these spurious species and genera, and determining their true nature.—Liquors, in which the flocculent *M.* of a fungus is spreading, are said to be *mothy*.

MYCENÆ, a very ancient city in the north-eastern part of Argolis, in the Peloponneseus, built upon a craggy height, is said to have been founded by Perseus. It was the capital of Agamemnon's kingdom, and was at that time the principal city in Greece. About 468 B.C. it was destroyed by the inhabitants of Argos, and never rose again from its ruins to anything like its former prosperity. In Strabo's time its ruins only remained; these are still to be seen in the neighbourhood of Kharvati, and are specimens of Cyclopean architecture. The most celebrated is the 'Gate of Lions,' the chief entrance to the ancient Acropolis, and receiving its name from two immense lions sculptured upon a block of bluish limestone above the gate. See Colonel Mure's *Tour in Greece* (vol. ii. p. 324).

MYELITIS (*myelos*, marrow) is the term employed to signify inflammation of the substance of the spinal cord. It may be either acute or chronic, but the latter is by far the most common affection. The chronic form begins with a little uneasiness in the spine, somewhat disordered sensations in the extremities, and unusual fatigue after any slight exertion. After a short time paralytic symptoms appear, and slowly increase. The gait becomes uncertain and tottering, and at length the limbs fail to support the body. The paralysis finally attacks the bladder and rectum, and the evacuations are discharged involuntarily; and death takes place as the result of exhaustion, or occasionally of asphyxia if the paralysis involves the chest. In the acute form there is much pain (especially in the spinal region), which usually ceases when paralysis supervenes. The other symptoms are the same as those of the chronic form, but they occur more rapidly and with greater severity, and death sometimes takes place in a few days.

The most common causes of this disease are falls, blows, and strains from over-exertion; but sexual abuses and intemperate habits occasionally induce it. It may also result from other diseases of the spine (as caries), or may be propagated from inflammation of the corresponding tissue of the brain.

The treatment, which is much the same as that of inflammation elsewhere, must be confided entirely to the medical practitioner; and it is therefore unnecessary to enter into any details regarding it. When confirmed paralysis has set in, there is little to hope for, but in the early stage the disease is often checked by judicious remedies.

MYGALÉ, a genus of spiders, the type of a

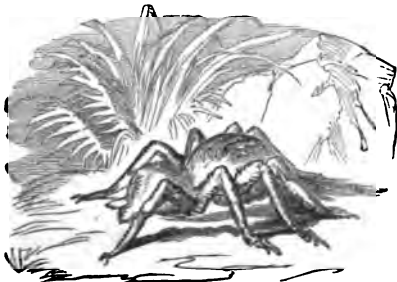

Mygalé.

family called *Mygalida*. They have four pulmonary sacs and spiracles, four spinnerets, eight eyes, and

hairy legs. They make silken nests in clefts of trees, rocks, &c., or in the ground, sometimes burrowing to a great depth, and very tortuously. To this genus belongs the bird-catching Spider (q. v.) of Surinam; but it seems now to be ascertained that several of the larger species frequently prey on small vertebrate animals. They do not take their prey by means of webs, but hunt for it and pounce upon it by surprise. They construct a silken dwelling for themselves in some sheltered retreat. Some of them make a curious lid to their nest or burrow. They envelop their eggs, which are numerous, in a kind of cocoon.

MYLA'BRIS, a genus of coleopterous insects, nearly allied to *Cantharis* (q. v.), and deserving of notice because of the use made of some of the species as blistering flies. *M. cichoris* is thus used in China and India; and *M. Fuesselini*, a native of the south of Europe, is supposed to have been the blistering fly of the ancients.

MYLI'TTA (? corresponding to Heb. *Meyaledeth*, Genitrix, who causes to bear), a female deity, apparently first worshipped among the Babylonians, who gradually spread her worship through Assyria and Persia. She is originally, like almost every other mythological deity, a cosmic symbol, and represents the female portion of the twofold principle through which all creation burst into existence, and which alone, by its united active and passive powers, upholds it. *M.* is to a certain degree the representative of Earth, the Mother, who conceives from the Sun, Bel or Baal. *M.* and Baal together are considered the type of the 'Good.' Procreation thus being the basis of *M.*'s office in nature, the act itself became a kind of worship to *M.*, and was hallowed through and for her. Thus it came to pass, that every Babylonian woman had once in her life to give herself up to a stranger, and thereby considered her person consecrated to the great goddess. The sacrifice itself seems, especially in the early stage of its introduction among the divine rites of the primitive Babylonians, to have had much less of the repulsiveness, which, in the eyes of highly-cultivated nations, must be attached to it; and it was only in later days that it gave rise to the proverbial Babylonian lewdness. Herodotus's account of this subject must, like almost all his other stories, be received with great caution.

MYLODON (Gr. grinder-teeth), a genus of huge fossil sloths, whose remains are found in the Pleistocene deposits of South America, associated with the *Megatherium* and other allied genera. A complete skeleton, dug up at Buenos Ayres, measured 11 feet from the fore part of the skull to the end of the tail. Although like the modern sloth in general structure and dentition, its immense size forbids us to suppose that it could have had the same arboreal habits, and the modifications of its structure seem to have fitted it for the uprooting and prostrating of the trees, the foliage of which supplied it with food.

MYNIAS, more accurately **MINYAS**, was, in Greek mythology, the son of Chryses. He was king of Jolcos, and gave his name to the people called *Minya*. He built the city of Orchomenus, where rites (named after him) were celebrated in his honour. His three daughters Clymene, Iris, and Alcithoë, according to Ovid, but Leuconö, Leucippe, and Alcithoë according to other authors, were changed into bats for having contemned the mysteries of Bacchus.

MYOSOTIS. See FORGET-ME-NOT.

MYRCIA, a genus of trees of the natural order *Myrtaceæ*, to which belongs the WILD CLOVE or

WILD CINNAMON of the West Indies (*M. acris*), a handsome tree of 20 or 30 feet high. Its timber is very hard, red, and heavy. Its leaves have an aromatic cinnamon-like smell, and an agreeable astringency, and are used in sauces. Its berries are round, and as large as peas, have an aromatic smell and taste, and are used for culinary purposes.—The leaves, berries, and flower-buds of *M. pimentoides* have a hot taste and fragrant smell, and are also used for culinary purposes.

MYRIAPODA (Gr. myriad-footed), a class of *Articulata*, resembling *Annelida* in their lengthened form, and in the great number of equal, or nearly equal, segments of which the body is composed; but in most of their other characters more nearly agreeing with Insects, among which they were ranked by the earlier naturalists, and still are by some. They have a distinct head, but there is no distinction of the other segments, as in insects, into thorax and abdomen. They have simple or compound eyes; a few are destitute of eyes. They have antennae like those of insects. The mouth is furnished with a complex masticating apparatus, in some resembling that of some insects in a larval state, in others, similar to that of crustaceans. Respiration is carried on through minute pores or spiracles, placed on each side along the entire length of the body, the air being distributed by innumerable ramifying air-tubes to all parts. In most parts of their internal organisation the *M.* resemble insects; although a decided inferiority is exhibited, particularly in the less perfect concentration of the nervous system. The resemblance is greater to insects in their larval than in their perfect state. The body of the *M.* is protected by a hard chitinous covering. The number of segments is various, seldom fewer than 24; although in some of the higher genera they are consolidated together in pairs, so that each pair, unless closely examined, might be considered as one segment bearing two pairs of feet. The legs of some of the lower kinds, as *Julus* (q. v.), are very numerous, and may be regarded as intermediate between the bristle-like appendages which serve many annelids as organs of locomotion, and the distinctly articulated legs of insects. In the higher *M.*, as *Scolopendra*, the legs are much fewer, and articulated like those of insects. None of the *M.* have wings. Some of them feed on decaying organic matter, chiefly vegetable; those of higher organisation are carnivorous. The *M.* do not undergo changes so great as those of insects, but emerge from the egg more similar to what they are ultimately to become; although some of them are at first quite destitute of feet; and, contrary to what takes place in insects, the body becomes more elongated as maturity is approached, the number of segments and of feet increasing.

The *M.* are divided into two orders: the lower, *Chilognatha* (*Julus*, &c.), having the body sub-cylindrical, the feet very numerous, the head rounded, the mandibles thick and strong; the higher, *Chilopoda* (*Scolopendra*, &c.), having the body flattened, the feet comparatively few, the head broad, the mandibles sharp and curved.

The *M.* are found in all parts of the world, in the ground, among moss, under stones, in the decaying bark of trees, in decaying roots, and in many similar situations. The largest species are tropical. They are all generally regarded with aversion. It is doubtful how far any of them are injurious to crops, although it is not improbable that they accelerate rotteness already begun; but some (Centipedes) have a venomous and painful bite.

MYRICA. See CANDLEBERRY.

MYRISTICAÆ. See NUTMEG.

MYRISTIC ACID ($C_{22}H_{42}O_4$, HO) is a crystalline fatty acid, found in the seeds of the common nutmeg, *Myristica moschata*. It occurs in the form of a glyceride in the fat of the nutmeg, or nutmeg butter. It has recently been found in small quantity amongst the products of the saponification of spermaceti, and of the fatty matter of milk; and hence this organic acid must be ranked amongst those which are common both to the animal and vegetable kingdoms.

MYRMECOPHAGA. See ANT-EATER.

MYROBALANS, the astringent fruit of certain species of *Terminalia*, trees of the natural order *Combretaceæ*, natives of the mountains of India. The genus *Terminalia* has a deciduous bell-shaped calyx and no corolla; the fruit is a juiceless drupe. *T. Belerica*, a species with alternate elliptical entire leaves, on long stalks, produces great part of the *M.* of commerce; but the fruits of other species often appear under the same name. Tonic properties are ascribed to *M.*; but although once in great repute, they are now scarcely used in medicine. They are used, however, by tanners and by dyers, and have therefore become a very considerable article of importation from India. They give a durable yellow colour with alum, and, with the addition of iron, an excellent black.—*Embic M.* are the fruit of *Emblica officinalis*, of the natural order *Euphorbiaceæ*, a native of India. They are used in India as a tonic and astringent; also in tanning and in the making of ink.—There is a kind of plum called the *Myrobalan Plum*. See PLUM.

MYRRH (Heb. *mur*), a gum resin produced by *Balsamodendron* (q. v.) *myrrha*, a tree of the natural order *Amyridaceæ*, growing in Arabia, and probably also in Abyssinia. The *M.* tree is small and scrubby, spiny, with whitish-gray bark, thinly-scattered small leaves, each consisting of three



Myrrh (*Balsamodendron myrrha*).

obovate obtusely toothletted leaflets, and the fruit a smooth brown ovate drupe, somewhat larger than a pea. *M.* exudes from the bark in oily yellowish drops, which gradually thicken and finally become hard, the colour at the same time becoming darker. *M.* has been known and valued from the most ancient times; it is mentioned as an article of commerce in Gen. xxxvii. 25, and was amongst the presents which Jacob sent to the Egyptian ruler, and amongst those which the wise men from

the East brought to the infant Jesus. It was an ingredient in the 'holy anointing oil' of the Jews. *M.* appears in commerce either in tears and grains, or in pieces of irregular form and various sizes, yellow, red, or reddish brown. It is brittle, and has a waxy fracture, often exhibiting whitish veins. Its smell is balsamic, its taste aromatic and bitter. It is used in medicine as a tonic and stimulant, in disorders of the digestive organs, excessive secretions from the mucous membranes, &c., also to cleanse foul ulcers and promote their healing, and as a dentifrice, particularly in a spongy or ulcerated condition of the gums. It was much used by the ancient Egyptians in embalming. The best *M.* is known in commerce as *Turkey M.*, being brought from Turkish ports; as the name *East Indian M.* is also given to *M.* brought to Europe from the East Indies, although it is not produced there, but comes from Abyssinia. It is not yet certainly known whether the *M.* tree of Abyssinia is the same as that of Arabia, or an allied species.

MYRSINACEÆ, a natural order of exogenous plants, consisting of trees and shrubs, natives of warm climates, and having simple leathery leaves, destitute of stipules; hermaphrodite or unisexual flowers, generally small, but often in umbels, corymbs, or panicles; very similar in structure to the flowers of the *Primulaceæ*; the fruit generally fleshy, with 1-4 seeds. The flowers are very often marked with sunken dots or glandular lines.—There are more than 300 known species. Many of them are beautiful evergreen shrubs, particularly the genus *Ardisia*. Some have peppery fruit, as *Embelia ribes*.

MYRTACEÆ, a natural order of exogenous plants, consisting of trees and shrubs, natives chiefly of warm, but partly also of temperate countries. The order, as defined by the greater number of botanists, includes several suborders, which are regarded by some as distinct orders, particularly **CHAMÆLAUCIACEÆ** (in which are contained about 50 known species, mostly beautiful little bushes, often with fragrant leaves, natives of New Holland), **BARRINGTONIACEÆ** (q. v.), and **LECYTHIDACEÆ** (q. v.). Even as restricted, by the separation of these, the order contains about 1300 known species. The leaves are entire, usually with pellucid dots, and a vein running parallel to and near their margin.—Some of the species are gigantic trees, as the *Eucalypti* or *Gum Trees* of New Holland, and different species of *Metrosideros*, of which one is found as far south as Lord Auckland's Islands, in lat. 50½°. The timber is generally compact.—Astringency seems to be rather a prevalent property in the order, and the leaves or other parts of some species are used in medicine as astringents and tonics. A fragrant or pungent volatile oil is often present in considerable quantity, of which *Oil of Cajeput* and *Oil of Cloves* are examples. *Cloves* and *Pimento* are amongst the best known products of the order. The berries of several species are occasionally used as spices in the same way as the true Pimento. A considerable number yield pleasant edible fruits, among which are the **POMEGRANATE**, the **GUAVA**, species of the genus *Eugenia*, and some species of myrtle.

MYRTLE (*Myrtus*), a genus of *Myrtaceæ*, having the limb of the calyx 4-5-parted, 4-5 petals, numerous free stamens, an almost globose germen, and a 2-3-celled berry, crowned with the limb of the calyx, and containing kidney-shaped seeds. The leaves are opposite and marked with pellucid dots; the flower-stalks are axillary, and generally one-flowered. The **COMMON M.** (*M. communis*) is well known as a beautiful evergreen shrub, or a tree of

moderate size, with white flowers. It is a native of all the countries around the Mediterranean Sea, and of the temperate parts of Asia, often forming thickets, which sometimes occur even within the reach of the sea-spray. The leaves are ovate or lanceolate, varying much in breadth. They are astringent and aromatic, containing a volatile oil, and were used in medicine by the ancients as a stimulant. The berries are also aromatic, and are used in medicine in



Myrtle (*Myrtus communis*):

1, flower of Myrtle, cut vertically; 2, Myrtle in flower.

Greece and India. A *M.* wine, called *Myrtidanum*, is made in Tuscany. *M.* bark is used for tanning in many parts of the south of Europe. Among the ancient Greeks, the *M.* was sacred to Venus, as the symbol of youth and beauty, was much used in festivals, and was, as it still is, often mentioned in poetry. The *M.* endures the winters of Britain only in the mildest situations in the south.—The **SMALL-LEAVED M.** of Peru (*M. microphylla*) has red berries of the size of a pea, of a pleasant flavour and sugary sweetness. Those of the **LUMA** (*M. luma*) are also palatable, and are eaten in Chili; as are those of the **DOWNY M.** (*M. tomentosa*), on the Neigherry Hills; and those of the **WHITE-BERRIED M.** (*M. leucocarpa*), by some regarded as a variety of the Common *M.*, in Greece and Syria. The berries of this species or variety are larger than those of the Common *M.*, and have a very pleasant taste and smell.—A very humble species of *M.* (*M. nummularia*) spreads over the ground in the Falkland Islands, as thyme does in Britain.

MYRTLE-WAX. See **WAX.**

MY'SIS, a genus of podophthalmous (stalk-eyed) crustaceans, of the order *Stomapoda*, much resembling the common shrimps in form, although differing from them in the external position of the gills. They are often called *Opossum Shrimps*, because the last two feet are furnished with an appendage, which in the female forms a large pouch, and in this the eggs are received after they leave the ovary, and are retained till the young acquire a form very similar to that of the parent, when the whole brood are at once set free into the ocean. Species of *M.* are found on the British shores, but they are far more abundant in the Arctic seas, where they form no small part of the food of whales, and of many fishes, particularly of different species of salmon.

MYSO'RE, or **MAISUR**, a raj or principality of Southern India, under the protection of the British

government, in lat. 11° 35'—15° N., and in long. 74° 45'—78° 45' E. It is bounded on the N. by the British collectorate of Dharwar, and otherwise surrounded by districts belonging to the Madras presidency. The area is 27,000 square miles; the pop. in 1859—1860 was 3,222,053, and its gross revenue during the same year amounted to £958,460. M. is an extensive table-land, with an average elevation of about 2000 feet, and with a slope principally toward the north and north-east. The chief rivers are the Cauvery, flowing south-east, and the Tungabhadra, the Hugri, and the Pennar flowing north and north-east. The climate of the higher districts is during a great portion of the year healthy and pleasant. Besides the common grains, the province produces cinnamon, pepper, cardamoms, coffee, raw silk, cotton, the betel-nut, and sago-palm. Since 1882, the control of the country has been entirely in the hands of the English, and the government is administered by a British commissioner. Chief town, Mysore. For the history of M., see articles MYDER ALI, TIPPOO SAHIB, and INDIA.

MYSORE, or MAISUR, a city of India, the seat of a British residency, capital of the territory, and of the subdivision of the same name, is situated amid picturesque scenery on a declivity formed by two parallel ranges of elevated ground running north and south, 245 miles west-south-west of Madras, lat. 12° 19' N., long. 76° 42' E. The houses are generally built of teak, and among the chief edifices are the British residency and church. The fort is quadrangular in form, three of its sides being 450 yards in length, and the remaining side longer. The rajah's palace, occupying three sides of the interior fort, contains a magnificent chair or throne of gold. The climate is mild, but not healthy; fevers are of frequent occurrence. Carpets are manufactured. Pop. 65,000.

MYSTAGOGUE (Gr. *mustes*, an initiated person, and *ago*, I lead), the name in the Greek religious system of the priest whose duty it was to direct the preparations of the candidates for initiation in the several mysteries, as well as to conduct the ceremonial of initiation. It was sometimes applied by a sort of analogy to the class of professional *ciceroni*, who in ancient, as still in modern times, undertook to shew to strangers newly arrived in a city the noteworthy objects which it contained; but the former meaning is its primitive one, and formed the ground of the application of the same name in the Christian church, to the catechists or other clergy who prepared candidates for the Christian *mysteries*, or sacraments, of baptism, confirmation, and the eucharist, especially the last. In this sense, the word is constantly used by the fathers of the 4th and 5th centuries; and in the well-known lectures of St Cyril of Jerusalem, although all were addressed to candidates for the mysteries, some for baptism, and some for the eucharist, it is only to the lectures addressed to the latter that the name *mystagogic* is applied. This distinction was connected with the well-known Discipline of the Secret; and it appears to have ceased with the abolition or gradual disuse of that discipline.

MYSTERIES (Gr. from *muo*, to close the lips or eyes), also called *Teletai*, *Orgia*, or, in Latin, *Initia*, designate certain rites and ceremonies in ancient, chiefly Greek and Roman religions, only known to, and practised by, congregations of certain initiated men and women, at appointed seasons, and in strict seclusion. The origin, as well as the real purport of these mysteries, which take no unimportant place among the religious festivals of the classical period,

and which, in their ever-changing nature, designate various phases of religious development in the antique world, is all but unknown. It does seem, indeed, as if the vague speculations of modern times on the subject were an echo of the manifold interpretations of the various acts of the mysteries given by the priests to the inquiring disciple—according to the lights of the former or the latter. Some investigators, themselves not entirely free from certain mystic influences (like Creuzer and others), have held them to have been a kind of misty orb around a kernel of pure light, the bright rays of which were too strong for the eyes of the multitude; that, in fact, they hid under an outward garb of mummery a certain portion of the real and eternal truth of religion, the knowledge of which had been derived from some primeval, or, perhaps, the Mosaic revelation; if it could not be traced to certain (or uncertain) Egyptian, Indian, or generally Eastern sources. To this kind of hazy talk, however (which we only mention because it is still repeated every now and then), the real and thorough investigations begun by Lobeck, and still pursued by many competent scholars in our own day, have, or ought to have, put an end. There cannot be anything more alien to the whole spirit of Greek and Roman antiquity than a hiding of abstract truths and occult wisdom under rites and formulas, songs and dances; and, in fact, the mysteries were anything but exclusive, either with respect to sex, age, or rank, in point of initiation. It was only the speculative tendency of later times, when Polytheism was on the wane, that tried to symbolise and allegorise these obscure, and partly imported ceremonies, the bulk of which had undoubtedly sprung from the midst of the Pelasgian tribes themselves in prehistoric times, and which were intended to represent and to celebrate certain natural phenomena in the visible creation. There is certainly no reason to deny that some more refined minds may at a very early period have endeavoured to impart a higher sense to these wondrous performances; but these can only be considered as solitary instances. The very fact of their having to be put down in later days as public nuisances in Rome herself, speaks volumes against the occult wisdom inculcated in secret assemblies of men and women.

The mysteries, as such, consisted of purifications, sacrificial offerings, processions, songs, dances, dramatic performances, and the like. The mystic formulas (*Deinumena*, *Dromena*, *Legomena*, the latter including the Liturgies, &c.) were held deep secrets, and could only be communicated to those who had passed the last stage of preparation in the mystagogue's hand. The hold which the nightly secrecy of these meetings, together with their extraordinary worship, must naturally have taken upon minds more fresh and childlike than our advanced ages can boast of, was increased by all the mechanical contrivances of the effects of light and sound which the priests could command. Mysterious voices were heard singing, whispering, and sighing all around, lights gleamed in manifold colours from above and below, figures appeared and disappeared; the mimic, the tonic, the plastic—all the arts, in fact, were taxed to their very utmost to make these performances (the nearest approach to which, in this country, is furnished by transformation-scenes, or sensation-dramas in general) as attractive and profitable (to the priests) as could be. As far as we have any knowledge of the plots of these Mysteries as scenic representations, they generally brought the stories of the special gods or goddesses before the spectator—their births, sufferings, deaths, and resurrections. Many were the outward symbols used, of which such as the Phallus,

the Thyrsus, Flower Baskets, Mystic Boxes, in connection with special deities, told more or less their own tale, although the meanings supplied by later ages, from the Neo-platonists to our own day, are various, and often very amazing. The most important Mysteries were, in historical times, those of Eleusis and the Theosophorian, both representing—each from a different point of view—the rape of Proserpina, and Ceres's search for her: the Theosophorian mysteries being also in a manner connected with the Dionysian worship. There were further those of Zeus of Crete—derived from a very remote period—of Bacchus himself, of Cybele, and Aphrodite—the two latter with reference to the Mystery of Propagation, but celebrated in diametrically opposed ways, the former culminating in the self-mutilation of the worshipper, the latter in prostitution. Further, the Mysteries of Orpheus, who in a certain degree was considered the founder of all mysteries. Nor were the other gods and goddesses forgotten: Hera, Minerva, Diana, Hecate, nay, foreign gods like Mithras (q. v.), and the like, had their due secret solemnities all over the classical soil, and whithersoever Greek (and partly Roman) colonists took their Lares and Penates all over the antique world. The beginning of the reaction in the minds of thinking men, against this mostly gross and degenerated kind of veneration of natural powers and instincts, is marked by the period of the Hesiodic poems; and when towards the end of the classical periods, the mysteries were no longer secret, but public orgies of the most shameless kind, their days were numbered. The most subtle metaphysicians, allegorise and symbolise as they might, failed in reviving them, and in restoring them to whatever primeval dignity there might have once been inherent in them.

MYSTERIES AND MIRACLE-PLAYS were dramas founded on the historical parts of the Old and New Testaments, and the lives of the saints, performed during the middle ages, first in churches, and afterwards in the streets on fixed or movable stages. Mysteries were properly taken from biblical and miracle-plays from legendary subjects, but this distinction in nomenclature was not always strictly adhered to. We have an extant specimen of the religious play of a date prior to the beginning of the middle ages in the *Christos Paschin*, assigned, somewhat questionably, to Gregory Nazianzen, and written in 4th c. Greek. Next come six Latin plays on subjects connected with the lives of the saints, by Roswitha, a nun of Gandersheim, in Saxony, which, though not very artistically constructed, possess considerable dramatic power and interest; they have been lately published at Paris, with a French translation. The performers were at first the clergy and choristers, afterwards any layman might participate. The earliest recorded performance of a miracle-play took place in England. Matthew Paris relates that Geoffroy, afterwards Abbot of St Albans, while a secular, exhibited at Dunstable the miracle-play of *St Catherine*, and borrowed copes from St Albans to dress his characters. This must have been at the end of the 11th or beginning of the 12th century. Fitzstephen, in his *Life of Thomas à Becket*, 1183 A. D., describes with approval the representation in London of the sufferings of the saints and miracles of the confessors. On the establishment of the Corpus Christi festival by Pope Urban IV. in 1264, miracle-plays became one of its adjuncts, and every considerable town had a fraternity for their performance. Throughout the 15th and following centuries, they continued in full force in England, and are mentioned, sometimes approvingly, sometimes disapprovingly, by contemporary writers. Designed at first as a means

of religious instruction for the people, they had long before the Reformation so far departed from their original character, as to be mixed up in many instances with buffoonery and irreverence, intentional or unintentional, and to be the means of inducing contempt rather than respect for the church and religion. Remarkable collections exist of English mysteries and miracles of the 15th c., known as the Chester, the Coventry, and the Townley plays. The first two have been published by the Shakspeare Society, and the other by the Surtees Society. The Townley mysteries are full of the burlesque element, and contain many curious illustrations of contemporary manners.

Out of the mysteries and miracle-plays sprang a third class of religious plays called *Moralities*, in which allegorical personifications of the Virtues and Vices were introduced as *dramatis persona*. These personages at first only took part in the play along with the scriptural or legendary characters, but afterwards entirely superseded them. The oldest known English compositions of this kind are of the time of Henry VI.; they are more elaborate and less interesting than the miracle-plays. Moralities continued in fashion till the time of Elizabeth, and were the immediate precursors of the regular drama.

Miracles and mysteries were as popular in France, Germany, Spain, and Italy as in England. A piece of the kind yet extant, composed in France in the 11th c., is entitled the *Mystery of the Wise and Foolish Virgins*, and written partly in the Provençal dialect and partly in Latin. A celebrated fraternity, called the *Confrérie de la Passion*, founded in Paris in 1350, had a monopoly for the performance of mysteries and miracle-plays, which were of such a length, that the exhibition of each occupied several days. A large number of the French mysteries of the 14th c. are extant. In the alpine districts of Germany, miracle-plays were composed and acted by the peasants: these peasant-plays had less regularity in their dramatic form, were often interspersed with songs and processions; and in their union of simplicity with high-wrought feeling were most characteristic of a people in whom the religious and dramatic element are both so largely developed. In the early part of last century, they began to partake to a limited extent of the burlesque, which had brought miracle-plays into disrepute elsewhere.

It is a mistake to suppose that the hostility of the reformers was what suppressed these exhibitions. The fathers of the Reformation shewed no unfriendly feeling towards them. Luther is reported to have said that they often did more good and produced more impression than sermons. The most direct encouragement was given to them by the founders of the Swedish Protestant Church, and by the earlier Lutheran bishops, Swedish and Danish. The authorship of one drama of the kind is assigned to Grotius. In England, the greatest check they received was from the rise of the secular drama; yet they continued to be occasionally performed in the times of James I. and Charles I., and it is well known that the first sketch of Milton's *Paradise Lost* was a sacred drama, where the opening speech was Satan's Address to the Sun. A degenerate relic of the miracle-play may yet be traced in some remote districts of England, where the story of St George, the dragon, and Beelzebub, is rudely represented by the peasantry. Strange to say, it was in the Catholic south of Germany, where these miracle-plays and mysteries had preserved most of their old religious character, that the severest blow was levelled against them. Even there, they had begun to be tainted to a limited

extent with the burlesque element, which had brought them into disrepute elsewhere. In 1779, a manifesto was issued by the Prince-archbishop of Salzburg, condemning them, and prohibiting their performance, on the ground of their ludicrous mixture of the sacred and the profane, the frequent bad acting in the serious parts, the distraction of the lower orders from more edifying modes of instruction, and the scandal arising from the exposure of sacred subjects to the ridicule of freethinkers. This ecclesiastical denunciation was followed by vigorous measures on the part of the civil authorities in Austria and Bavaria. One exception was made to the general suppression. In 1633, the villagers of Oberammergau, in the Bavarian highlands, on the cessation of a plague which desolated the surrounding country, had vowed to perform every tenth year the Passion of Our Saviour, out of gratitude, and as a means of religious instruction; a vow which had ever since been regularly observed. The pleading of a deputation of Ammergau peasants with Max. Joseph of Bavaria saved their mystery from the general condemnation, on condition of everything that could offend good taste being expunged. It was then and afterwards somewhat remodelled, and is perhaps the only mystery or miracle-play which has survived to the present day. The last performance took place in 1860. The inhabitants of this secluded village, long noted for their skill in carving in wood and ivory, have a rare union of artistic cultivation with perfect simplicity. Their familiarity with sacred subjects is even beyond what is usual in the alpine part of Germany, and the spectacle seems still to be looked on with feelings much like those with which it was originally conceived. What would elsewhere appear impious, is to the alpine peasants devout and edifying. The personator of Christ considers his part an act of religious worship; he and the other principal performers are said to be selected for their holy life, and consecrated to their work with prayer. The players, about 500 in number, are exclusively the villagers, who, though they have no artistic instruction except from the parish priest, act their parts with no little dramatic power, and a delicate appreciation of character. The New Testament narrative is strictly adhered to, the only legendary addition to it being the St Veronica handkerchief. The acts alternate with *tableaux* from the Old Testament and choral odes. Many thousands of the peasantry are attracted by the spectacle from all parts of the Tyrol and Bavaria, among whom the same earnest and devout demeanour prevails as among the performers. Plays of a humbler description, from subjects in legendary or sacred history, are not unfrequently got up by the villagers around Innsbruck, which shew a certain rude dramatic talent, though not comparable to what is exhibited at Ammergau. Girls very generally represent both the male and female characters.

MYSTICISM (Gr. *mystikos*, mystical), a term used with considerable vagueness, but implying that general tendency in religion to higher and more intimate communication with the Divine, to which, in most religions, ancient and modern, certain individuals or classes have laid claim. In the Platonic philosophy, and in the Eastern systems, from which that philosophy is derived, the human soul being regarded as a portion of the divine nature, it is held to be the great end of life to free the soul from the embarrassment and mental darkness in which it is held by the material trammels of the body in which it is imprisoned. In the pursuit of this end, two very opposite courses were adopted: the first, that of spiritual purification, partly by repressing the natural appetites and weakening the sensual

impulses by corporeal austerities, partly by elevating the soul through intense contemplation and withdrawal from the outward objects of sense; the other, that of regarding the soul as superior to the body, independent of its animal impulses, incapable, from its higher origin, of being affected by its outward actions, or sullied by contact with the corruption in which its lower nature might love to wallow. A similar element of M., which, in truth, must form in some sense a constituent of every religious system, is traceable in the early doctrinal history of Christianity, and the career of Christian M. also divides itself into the same twofold course. Among the early sects external to the church, we trace the first in the system of Tatian and of the Eucratites, while the second finds its parallel in the Syrian Gnostics, in Carpocrates, Bardisanes, and in one form at least of the Nicolaitic heresy. Within the Christian church there never has been wanting a continuous manifestation of the mystical element. The language of St Paul in Gal. ii. 20, and in 2d Cor. xii. 2, and many expressions in the Apocalypse, may be taken as the exponents of Christian M., the highest aspiration of which has ever been towards that state in which the Christian 'no longer liveth, but Christ liveth in him.' And although no regular scheme of M. can be found in the early Fathers, yet the writings of Hermas the Shepherd, the Epistles of St Ignatius, the works of St Clement of Alexandria, the Expositions of Origen, and above all, the Confessions of St Augustine, abound with outpourings of the true spirit of Christian mysticism. It is curious that the first systematic exposition of its principles is said to be in the works of the pseudo-Dionysius the Areopagite; but it was not till the days of the Scholastics that it received its full development, when the mystic life was resolved into its three stages, viz., of Purification, of Illumination, and of Ecstatic Union with God and Absorption in Divine Contemplation. It was upon the explanation of this third stage that the great division of the medieval mystic schools mainly turned; some of them explaining the union with God in a pantheistic or semipantheistic sense, and thereby annihilating the individual will, and almost the personal action of man in the state of ecstasy; others, with St Bernard, fully preserving both the individuality and the freedom of man, even in the highest spiritual communication with his Creator. Of the former, many, as the Hesychasts (q. v.) in the Greek Church, and the Brethren of the Free Spirit (q. v.) and the Beghards in the Latin, drew from these mystical doctrines the most revolting moral consequences; in others, as Tauler, Ruysbroek, Ekkart, the error does not seem to have gone beyond the sphere of speculation. The writings of Thomas à Kempis (q. v.), of St Catherine of Siena, of St John of the Cross, and of St Teresa, may perhaps be taken as the most characteristic representations of the more modern form of the traditionary M. which has come down from the mystics of the middle ages.

The later history of M. in the Roman Catholic Church will be found under the heads of FENELON, MADAME GUYON, MOLINOS, and QUIETISM. The most remarkable followers of the same or kindred doctrines in the Protestant communions are Jacob Böhmer of Görlitz, Emmanuel Swedenborg (q. v.), and the celebrated William Law (q. v.).

MYTH AND MYTHOLOGY. The word *myth* (Gr. *mythos*), originally signified *speech* or *discourse*, and was identical with the word *logos*. After the age of Pindar and Herodotus, however, it came to be synonymous with the Latin word *fabula*, *fable* or *legend*. According to the present use of our language, a myth is an idea or fancy presented in the historical form; and though, of course, any fiction at any time

in this shape might be called a myth, yet by usage the word is confined to those fictions made in the early periods of a people's existence, for the purpose of presenting their religious belief, and generally their oldest traditions, in an attractive form. The tendency to create myths in this way seems inherent in every people; certainly there is no people so sunk into the brute as to be without them. A myth is not to be confounded with an allegory; the one being an unconscious act of the popular mind at an early stage of society, the other a conscious act of the individual mind at any stage of social progress. The parables of the New Testament are allegorical; so are *Æsop's Fables*; no one mistakes them for realities; they are known to have been invented for a special didactic purpose, and so received. But the peculiarity of myths is, that they are not only conceived in the narrative form, but generally taken for real narrations by the people to whom they belong, so long at least as they do not pass a certain stage of intellectual culture. Even myths of which the allegorical significance is pretty plain, such as the well-known Greek myth of Prometheus and Epimetheus, were received as facts of early tradition by the Greeks. Myths may be divided into several classes, of which the first and most important is the theological and moral. The oldest theology of all nations is in the form of myths; hence the great importance of mythological study, now universally recognised; for it is not occupied merely or mainly with strange fancies and marvellous fictions, invented for the sake of amusement, but contains the fundamental ideas belonging to the moral and religious nature of man as they have been embodied by the imaginative faculty of the most favoured races. It is this dominance of the imagination, so characteristic of the early stages of society, which gives to myth its peculiar dramatic expression, and stamps the popular creed of all nations with the character of a poetry of nature, of man, and of God. From the very nature of the case, the myth-producing faculty exercises itself with exuberance only under the polytheistic form of religion; for there only does a sufficient number of celestial personages exist, whose attributes and actions may be exhibited in a narrative form; there is nothing, however, to prevent even a monotheistic people from exhibiting certain great ideas of their faith in a narrative form, so as by prosaic minds to be taken for literal historical facts. But besides strictly theological myths, there are physical myths, that is, fictions representing the most striking appearances and changes of external nature in the form of poetical history; in which view, the connection of legends about giants, chimeras, &c., with regions marked by peculiar volcanic phenomena, has been often remarked. It is difficult indeed, in polytheistic religions, to draw any strict line between physical and theological myths; as the divinity of all the operations of nature is the first postulate of polytheism, and every physical phenomenon becomes the manifestation of a god. Again, though it may appear a contradiction, there are historical myths; that is, marvellous legends about persons, who may with probability be supposed to have actually existed. So intermingled, indeed, is fact with fable in early times, that there must always be a kind of debatable land between plain theological myth and recognised historical fact. This land is occupied by what are called the heroic myths; that is, legends about heroes, concerning whom it may often be doubtful whether they are merely a sort of inferior, and more human-like gods, or only men of more than ordinary powers whom the popular imagination has elevated into demi-gods.

The scientific study of mythology commenced with

the ancient nations who produced it, specially with the acute and speculative Greeks. The great mass of the Greek people, indeed—of whom we have a characteristic type in the traveller Pausanias—accepted their oldest legends, in the mass, as divine and human facts; but so early as the time of Euripides, or even before his day in the case of the Sicilians, Epicharmus and Empedocles, we find that philosophers and poets had begun to identify Jove with the upper sky, Apollo with the sun, Juno with the nether atmosphere, and so forth; that is, they interpreted their mythology as a theology and poetry of nature. This, indeed, may be regarded as the prevalent view among all the more reflective and philosophical heathens (who were not, like Xenophon, orthodox believers) up from the age of Pericles, 450 B. C., to the establishment of Christianity. But there was an altogether opposite view, which arose at a later period, under less genial circumstances, and exercised no small influence both on Greek and Roman writers. This view was first prominently put forth by Euhemerus, a Messenian, in the time of the first Ptolemies, and consisted in the flat prosaic assertion, that the gods, equally with the heroes, were originally men, and all the tales about them only human facts sublimed and elevated by the imagination of pious devotees. This view seemed to derive strong support from the known stories about the birth and death of the gods, specially of Jove in Crete; and the growing sceptical tendencies of the scientific school at Alexandria, were of course favourable to the promulgation of such views. The work of Euhemerus accordingly obtained a wide circulation; and having been translated into Latin, went to nourish that crass form of religious scepticism which was one of the most notable symptoms of the decline of Roman genius at the time of the emperors. Historians, like Diodorus, gladly adopted an interpretation of the popular mythology which promised to swell their stores of reliable material; the myths accordingly were coolly emptied of the poetic soul which inspired them, and the early traditions of the heroic ages were set forth as plain history, with a grave sobriety equally opposed to sound criticism, natural piety, and good taste.

In modern times, the Greek mythology has again formed the basis of much speculation on the character of myths and the general laws of mythical interpretation. The first tendency of modern Christian scholars, following the track long before taken by the fathers, was to refer all Greek mythology to a corruption of Old Testament doctrine and history. Of this system of interpreting myths, we have examples in Vossius, in the learned and fanciful works of Bryant and Faber, and very recently, though with more pious and poetic feeling, in Gladstone. But the Germans, who have taken the lead here, as in other regions of combined research and speculation, have long ago given up this ground as untenable, and have introduced the rational method of interpreting every system of myths, in the first place, according to the peculiar laws traceable in its own genius and growth. Ground was broken in this department by Heyne, whose views have been tested, corrected, and enlarged by a great number of learned, ingenious, and philosophical writers among his own countrymen, specially by Buttmann, Voss, Creuzer, Müller, Welcker, Gerhard, and Preller. The general tendency of the Germans is to start—as Wordsworth does in his *Excursion*, book iv.—from the position of a devout imaginative contemplation of nature, in which the myths originated, and to trace the working out of those ideas, in different places and at different times, with the most critical research, and the most vivid reconstruction. If in

this work they have given birth to a large mass of ingenious nonsense and brilliant guess-work, there has not been wanting among them abundance of sober judgment and sound sense to counteract such extravagances. It may be noticed however, as characteristic of their over-speculative intellect, that they have a tendency to bring the sway of theological and physical symbols down into a region of what appears to be plain historical fact; so that Achilles becomes a water-god, Peleus a mud-god, and the whole of the *Iliad*, according to Forchhammer, a poetical geology of Thessaly and the Troad! Going to the opposite extreme from Euhemerus, they have denied the existence even of deified heroes; all the heroes of Greek tradition, according to Uschold, are only degraded gods; and generally in German writers, a preference of transcendental to simple and obvious explanations of myths is noticeable. Creuzer, some of whose views had been anticipated by Blackwell, in Scotland, is especially remarkable for the high ground of religious and philosophical conception on which he has placed the interpretation of myths; and he was also the first who directed attention to the oriental element in Greek mythology—not, indeed, with sufficient discrimination in many cases, but to the great enrichment of mythological material, and the enlargement of philosophical survey. In the most

recent times, by uniting the excursive method of Creuzer with the correction supplied by the more critical method of O. Müller and his successors, the science of comparative mythology has been launched into existence; and specially the comparison of the earliest Greek mythology with the sacred legends of the Hindus, has been ably advocated by Max Müller in the *Oxford Essays* (1856). In France, the views of Euhemerus were propounded by Banier (1739); and generally the French scholars, such as Raoul Rochette and Petit Radet shew a distinct national tendency to recognize as much of the historical element as possible in mythology. By the British scholars, mythology is a field that has been very scantily cultivated. Besides those already named, Payne Knight, Mackay, Grote in the first volumes of his history, and Keightley are the only names of any note, and their works can in nowise compete in originality, extent of research, in discriminating criticism, or in largeness of view, with the productions of the German school. The best for common purposes is Keightley; the most original, Payne Knight. On the special mythologies of India, Rome, Greece, &c., information will be found under the heads of the respective countries to which they belong. The more important mythological personages are noticed under their own names; see BACCHUS, JUPITER, HERCULES, &c.

N



THE fourteenth letter of the English alphabet, is one of the nasal liquids of the lingual class. See **LETTERS**. Its Hebrew (and Phœnician) name, *Nun*, signified a *fish*, which its original form was probably meant to represent. N is interchangeable with L (q. v.) and M, as in *collect, commingle, confer*; and in Ger. *boden*, compared with Eng. *bottom*.

In Latin, this letter had a faint, uncertain sound at the end of words and in some other positions, especially before *s*. This accounts for words in *on* having lost the *n* in the nominative case, though retaining it in the oblique cases, as *homo, hominis*; and for Greek names like *Platon* being written without the final *n* in Latin. The dull, muffled pronunciation of *n*, which is indicated by such words as *consul, censor, testamento*, being frequently spelled *cosul, cesor, testameto*, was the first stage of the modern French nasal *n*. Before a guttural letter, *n* naturally assumes the sound of *ng*, as *bank*.

NAAS, a market and assize town of Kildare County, Ireland, 20½ miles south-west of Dublin. The population in 1861 was 2959, of whom 2655 were Catholics, 276 Protestants of the Established Church, and the rest Protestants of other denominations. The number of inhabited houses was 529. Having been anciently the seat of the kings of Leinster, N. was early occupied by the English. A parliament was held in it in 1419, and it obtained charters successively from Henry V., Elizabeth, and James I. At present, N. is a place of little trade, and is almost entirely without manufactures. It returned two members to the Irish parliament, but was disfranchised at the Union. It is the seat of a diocesan school, and of three national schools (one of which is attached to the Roman Catholic convent), containing (1861) 732 pupils, of whom 359 are boys, and 373 girls.

NA'BOB, or **NABAB**, a corruption of the word *Nawab* (deputy), was the title belonging to the administrators, under the Mogul empire, of the separate provinces into which the district of a *Subahdar* (q. v.) was divided. The title was continued under the British rule, but it gradually came to be applied generally to natives who were men of wealth and consideration. In Europe, and especially in Britain, it is applied derisively to those who, having made great fortunes in the Indies, return to their native country, where they live in oriental splendour.

NABONA'SSAR, ERA OF, was the starting-point of Babylonian chronology, and was adopted by the Greeks of Alexandria, Berosus and others. It began with the accession of Nabonassar to the throne—an event calculated (from certain astronomical phenomena recorded by Ptolemy) to have taken place 26th February 747 a. c.

NÁBULU'S, or **NÁBLU'S** (a corruption of the Gr. *Neapolis*, New City, the name given to it in the reign

of Vespasian), anciently called **SHESHKEM** or **SICHEM**, in the New Testament (John iv. 5), **SYCHAR**; is a town of Palestine, possessing, it is said, 'the only beautiful site from Dan to Bearsheba.' It lies between Mount Ebal and Mount Gerizim, on the south side of the valley of Erd-Múkkina, and has a population variously estimated at from 8900 to 14,000, of whom about 500 are Christians, 150 Samaritans, and 50 Jews; the rest are Mohammedans, fierce, turbulent, and fanatical. The houses are pretty good, but the streets (as usual in the East) are narrow, gloomy, and filthy. The chief productions are soap, cotton, and oil—the soap-manufactories are large, and the oil is considered the best in Syria.—See Porter's *Handbook for Syria and Palestine*, and Stanley's *Palestine*.

NAORE. See **MOTHER OF PEARL**.

NADIR, an Arabic word signifying that point in the heavens which is diametrically opposite to the zenith, so that the zenith, nadir, and centre of the earth are in one straight line. The zenith and nadir form the poles of the Horizon (q. v.). See **ZENITH**.

NADIR SHAH, of Persia, belonged to the *Afshars*, a Turkish tribe, and was born near Kelat, in the centre of Khorassan, Persia, in 1688. When 17 years old, he was taken prisoner by the *Uzbeks*, but escaped after four years of captivity; entered the service of the governor of Khorassan, and soon obtained high promotion. Having, however, been degraded and punished for some real or supposed offence, he betook himself to a lawless life, and for several years was the daring leader of a band of 3000 robbers, who levied contributions from almost the whole of Khorassan. An opportunity having occurred, N. seized the town of Kelat, and gradually extended his territorial authority. Persia was at this time ruled by Melek Ashraf, an Afghan of the tribe of Ghilji, whose grinding tyranny and cruelty produced in the mind of every Persian a deadly hatred of the very name Afghan, which exists to the present day. N. having avowed his intention of expelling the hated race from the country, and restoring the *Suffavean* dynasty, numbers flocked to his standard, and Meshed, Herat, and all Khorassan were speedily reduced. Ashraf, signally defeated in several engagements, fled before the avenger, who, with a celerity only equalled by its thoroughness, purged the provinces of Irak, Fars, and Kerman of even the semblance of Afghan domination. The assassination of Ashraf, during his retreat, terminated the war. The rightful heir, *Tamasp*, then ascended the throne, and N. received for his services the government of the provinces of Khorassan, Mazanderan, Seistan, and Kerman, assuming at the same time the title of *Tamasp-káli* (the Slave of *Tamasp*), the title of *khan* being subsequently added. He was sent against the *Turks* in 1731, and defeated them at *Hamadan*, regaining the Armenian provinces which had been seized by the *Turks* in the preceding reign; but

his sovereign having in his absence engaged unsuccessfully the same enemy, N. caused him to be put in prison, and elevated his infant son, Abbas III., to the throne in 1732. The death of this puppet, in 1736, opened the way for the elevation of N. himself, who was crowned as *Nadir Shah*, February 26, 1736. He resumed the war with the Turks; and though totally defeated in the first two battles by the Grand Vizier Asman, turned the tide of fortune in the subsequent campaign, and granted peace to the Turks on condition of receiving Georgia. He also conquered Afghanistan, and drove back the invading Usbeks. His ambassador to the Great Mogul having been murdered along with all his suite at Jelalabad, and satisfaction having been refused, N. in revenge ravaged the North-west Provinces, and took Delhi, which he was, by the insane behaviour of the inhabitants, reduced to the necessity of pillaging. With booty to the amount of £20,000,000, including the Koh-i-nūr (q. v.) diamond, he returned to the west bank of the Indus. He next reduced Bokhara and Khaurezm, restoring to Persia her limits under the golden reign of the Sassanides. From this period, his character underwent a sudden change: he was formerly open-hearted, liberal, and tolerant; he now became suspicious, avaricious, and tyrannical. The empire groaned under his extortions, and he was finally assassinated on the 20th June 1747. His only surviving son was carried to Constantinople, and thence to Vienna, where he was brought up as a Catholic, under the surveillance of the Empress Maria Theresa, and died a major in the Austrian service, under the title of Baron Semlin. N.'s tyranny has now been forgotten; and at the present day, he is regarded with pride and gratitude as the 'Wallace' of Persia.

NÆVIUS, CN., one of the earliest Latin poets, was born, probably in Campania, in the first half of the 3d c. B. C. In his youth, he served in the first Punic war; but about the year 235 B. C., he made his appearance at Rome as a dramatic writer. Of his life, we know little; but of his character, rather more. He was very decidedly attached to the plebeian party; and in his plays, satirised and lampooned the Roman nobles with all the virulence and indiscretion of a hot-blooded impetuous Campanian—that Gascon of ancient Italy! His rashness ultimately caused his banishment to Utica in Africa, where he died, 204 or 202 B. C. Besides his dramatic writings, comprising both tragedies and comedies, he wrote an epic poem, *De Bello Punico*, in the old Saturnian metre. Of these, only a few very unimportant fragments are extant, which may be found in Bothe's *Poetarum Latinorum Scenicorum Fragmenta* (Halberstadt, 1824); or Klunmann's collection of the same (Jena, 1843), enriched by a life of N., and an essay on his poetry. See also Sellars's *Poets of the Roman Republic* (Edin. 1863).

NÆVUS (known popularly as *mother-spot* or mole) is a congenital mark or growth on a part of the skin. Sometimes it is merely a dark discoloration of the surface as described in the article MACULÆ, in which case it is termed a mole and is perfectly harmless; but often it consists of a dense network of dilated blood-vessels, forming a reddish or livid tumour, more or less elevated above the surface of the surrounding skin. The most frequent situations of these vascular nævi are the skin and subcutaneous cellular tissue of the head; but they may occur elsewhere. The popular belief is, that they are caused by the longing of the mother during her pregnancy for a lobster, or strawberry or raspberry, or some other red-coloured article of food, and that the influence of her mind has impressed upon the

fœtus a more or less vivid image of the thing she longed for; and hence the name of *mother-spot*. Sometimes these tumours waste away spontaneously, and give no trouble; but frequently they increase rapidly, invade the adjacent tissues, and ulcerate or slough, and thus become dangerous to life by hæmorrhage. When these tumours do not shew a tendency to increase, no treatment is necessary. When they are obviously increasing in size, the continual application of cold (by means of freezing mixtures), with moderately firm pressure, is sometimes of service; but a more certain method is to employ means to produce such an amount of inflammation as to obliterate the vessels; for this purpose, the seton, the application of nitric acid, and vaccination of the tumour, have been successfully applied. The injection of strong astringents, with the view of coagulating the blood, has sometimes effected a cure. If all these means fail, extirpation, either with the ligature or knife, must be resorted to; the ligature being regarded as the safest and best method. For the various methods of applying the ligature, the reader is referred to any standard work on operative surgery. If the tumour is in an inaccessible spot, as in the orbit of the eye, and is increasing rapidly, the only course is to tie the large vascular trunk supplying it. The common carotid artery has in several instances been tied with success for vascular nævus in the orbit.

NÄFELS, a village of Switzerland, in the canton of Glarus, and five miles north of the town of that name, in a deep valley, is one of the most famous battle-fields in the country. Pop. 2000. Here, in 1388, 1500 men of Glarus, under Matthias am Buhl, overthrew an Austrian force of from 6000 to 8000 men. The event is still celebrated yearly.

NĀGA is, in Hindu Mythology, the name of deified serpents, which are represented as the sons of the Muni Kas'yapa and his wife Kadṛū, whence they are also called Kādraveyas. Their king is Śeṣha, the sacred serpent of Vish'n'u.

NĀGAPATNA'M, a seaport of British India, on the Coromandel coast, in the province of Tanjur, 15 miles south of Karikal. It was taken by the Dutch in 1660, but fell into the hands of the English in 1781. Its site is an open sandy plain, elevated only three or four feet above sea-level. The port is visited by small vessels, and carries on some trade with Ceylon. Pop. 10,000, many of whom are of Dutch descent.

NĀGARJUNA, or NĀGASENA, is the name of one of the most celebrated Buddhist teachers or patriarchs—the thirteenth—who, according to some, lived about 400 years, according to others, about 500 years, after the death of the Buddha Ś'ākya-muni (i. e., 143 or 43 B. C.). He was the founder of the Mādhyamika school, and his principal disciples were Aryadeva and Budhapālita. According to the tradition of the Buddhās, he was born in the south of India, in a Brahmanical family. Even as a child, he studied all the four Vedas; later, he travelled through various countries, and became proficient in astronomy, geography, and magical arts. By means of the last, he had several amorous adventures, which ended in the death of three companions of his, but in his own repentance, and, with the assistance of a Buddhist mendicant, in his conversion to Buddhism. Many miracles are, of course, attributed to his career as propagator of this doctrine, especially in the south of India, and his life is said to have lasted 300 years.—See E. Burnouf, *Introduction à l'Histoire du Bouddhisme Indien* (Paris, 1844); Spence Hardy, *A Manual of Buddhism* (Lond. 1853); W. Wassiljew, *Der*

Buddhismus, seine Dogmen, Geschichte und Literatur (St Petersburg, 1860).

NAGASAKI, or **NANGASIKI**, a city and port of Japan, opened to foreign commerce by the treaty of 1858, on the 1st July 1859, is situated in 32° 44' N. lat., and 129° 51' E. long., at the western extremity of the peninsula of Fizen, which forms the north-west portion of the island of Kiusiu. Previously to 1859, it was the only port in Japan open to foreigners. The harbour, which is one of the most beautiful in the world, is about six miles in width, and three or four in length. To a person inside, it appears completely land-locked, and it is surrounded by hills of about 1500 feet in height. These are broken into long ridges and deep valleys; while the more fertile spots are terraced and under cultivation. The town of N., which is about a mile in length, and three-quarters of a mile in width; lies on the north side of the bay; its population is estimated at 70,000. On the opposite side of the bay, the Japanese have a steam-factory, under the direction of Dutch officers. The climate of N. is genial. Towards the end of June, the thermometer ranges from 62° to 78°. Observations extending over the three hottest months of the year, from June 13 to September 13, 1859, shew that the thermometer ranged from 70° to 96° in the shade. During these three months, there were twenty-four days of constant rain, which was most excessive from the 24th of June to the end of July. The water at N. is bad, and there is more disease than at Hakodadi, where water is both good and plentiful. Cholera and typhus fever are sometimes virulent. At the end of the third year from the opening of the port, the foreign community consisted of thirty-nine persons. The trade of N. is inferior to that of Kanagawa. Sea-weed, salt-fish, and other articles are exported to China. The exports to Europe are mainly tea, vegetable wax, and copper. The total value of imports in the year 1861 amounted to 669,261 dollars, and the exports to 1,000,317 dollars, or about £140,000 and £203,000.—See Alcock's *Three Years' Residence in Japan*, vol. ii. p. 387 (Lond. 1862); *Yedo and Peking*, by Robert Fortune (Lond. 1863); Hodgson's *Residence at Nagasaki, &c.*, in 1859—1860 (Lond. 1861).

NAGELFLUE, the provincial name for a bed of conglomerate belonging to the Mollasse (q. v.), which forms a considerable portion of the strata in the central region of Switzerland, between the Alps and the Jura. It is said to attain the enormous thickness of 6000 and 8000 feet in the Rhigi near Lucerne, and in the Speer near Wesen.

NAGESUR, the name under which the blossoms of the *Mesua ferrea* are sold in the bazaars of India. See **GUTTIFERÆ**.

NAGPUR, a city of British India, capital of the province of the same name, and situated near its north-west extremity, in an unhealthy swampy hollow, 430 miles in a direct line east-north-east of Bombay. Inclusive of its extensive suburbs, it is seven miles in circumference. It contains no important edifices. The great body of the inhabitants live in thatched mud-tents, interspersed with trees, which prevent the circulation of air, and secrete moisture, thus rendering the town unnecessarily unhealthy. The mean temperature of N. is estimated at about 80° F. Cotton cloths, coarse and fine chintzes, turbans, silks, brocades, blankets, woollens, tent-cloths, and articles in copper and brass, are manufactured. Here, on the 26th and 27th November 1817, a small British force of 1350 men, commanded by Colonel Scott, defeated a native army of 18,000 men. Pop. 115,000.

NÁGPUR, an extensive inland province of British India, belonging in its civil administration to the Bengal, and in its military to the Madras Presidency, extends immediately north-east of the Nizam's Dominions, in lat. 17° 15'—23° 5' N.; long. 78° 3'—83° 10'. Area, 76,432 square miles; pop. 4,650,000. The north part of the province is mountainous in character, being traversed by spurs of the great Vindhya range; the general slope of the surface is from north-west to south-east, and the Bay of Bengal receives the drainage of the country chiefly through the rivers Mshannadi and Wain Gangá—the latter a tributary of the Godávari. The climate is not healthy, and is especially insalubrious in the extensive tracts of low marshy land which abound in the province. The Gonds (see **INDIA**), supposed to be the aborigines, are the most remarkable class of the inhabitants. They rear fowls, swine, and buffaloes; but their country, forming the south-eastern tracts—about one-third of the whole—is covered with a dense jungle, swarming with tigers. In the more favoured districts, where the inhabitants are more industrious, rice, maize, oil, and other seeds, and vegetables are extensively cultivated. The rajahs of N., sometimes called the rajahs of Berar, ruled over a state formed out of a part of the great Mahratta kingdom. The dynasty, however, died out in 1853, and the territory came into the possession of the British. The province has five divisions—capital, Nágpur.

NAG'S HEAD CONSECRATION. This story, which was first circulated by the Roman Catholics forty years after the event, with respect to Archbishop Parker's consecration, was to the following effect. On the passing of the first Act of Uniformity in the first year of Queen Elizabeth, fourteen bishops vacated their sees, and all the other sees excepting that of Llandaff being vacant, there was a difficulty in maintaining the hitherto unbroken succession of bishops from apostolical times. Kitchin of Llandaff refused to officiate at Parker's consecration, and consequently the Protestant divines procured the help of Scory, a deprived bishop of the reign of Edward VI., and all having met at the Nag's Head Tavern in Cheapside, they knelt before Scory, who laid a Bible on their heads or shoulders, saying: 'Take thou authority to preach the word of God sincerely;' and they rose up bishops of the New Church of England! The story is discredited by the Roman Catholic historian Lingard, and is carefully refuted by Strype in his life of Parker. The facts of the case are, that the election took place in the chapter-house at Canterbury, the confirmation at St Mary le Bow's Church in Cheapside, and the consecration in the chapel of Lambeth Palace. Scory, then elected to the see of Hereford; Barlow, formerly Bishop of Wells, then elected to Chichester; Coverdale, formerly of Exeter, and never reappointed to any see; and Hodgkin, suffragan of Hereford, officiated at the consecration. The Nag's Head story probably arose from the company having possibly gone from Bow Church, after the confirmation, to take a dinner together at the tavern hard by, according to the prevailing custom. The due succession of bishops in the English Church has never been broken.

NAGY, a Hungarian word, meaning 'great.' It is prefixed to the names of many towns in Hungary and Transylvania. In the present work, many of the towns that take this prefix are given under the name that comes after it.

NAGY BANYA. See **BANYA**.

NAGY ENYED, a small town of Transylvania, on the Maros, 17 miles north-north-east of Karlsburg.

It contains a famous Calvinistic college. Pop. under 6000.

NAHUM, one of the twelve minor prophets, was a native either of Elkosh, in Galilee, or the son of a man named Elkosh. The identification of his birthplace with Capernaum (Nahum's Village) or a place called Elkosh, on the east side of the Tigris, not far from Nineveh, is the result of vague speculation. He was probably a contemporary of Isaiah, and flourished about 713—711 B.C. The burden of his 'vision' (in 3d chap.) is the destruction of Nineveh and the downfall of the Assyrian kingdom. His style is full of animation, fancy, and originality, and at the same time clear and rounded. His language throughout is classical, and in the purest Hebrew, belonging to the second half of Hezekiah's reign, or to the time immediately following the defeat of Sennacherib before Jerusalem (2 Kings xix. 35, &c.). A commentary on N., with special reference to the Assyrian monuments lately discovered, has been written by O. Strauss (Berlin, 1853).

NATA. See **ASP** and **COBRA**.

NAIADÆS, NAIADA'CRÆ, or POTAMEÆ, a natural order of endogenous plants, divided by some botanists into several orders (*Juncagineæ, Zosteraceæ, &c.*), containing in all [not quite 100 known species, all aquatic plants, some of them inhabiting the ocean, some found in lakes and ponds, some in streams. They are all of very cellular structure; the leaves have parallel veins, and the flowers are inconspicuous. To this order belongs the Pondweed (*Potamogeton*), of which a number of species abound in the still waters of Britain, and of which some are found as far north as Iceland. To this order also belongs the **GRASSWEACK** (q. v.) of our shores, used for stuffing mattresses. The Lattice-leaf (q. v.) of Madagascar is one of the most interesting species, and one of the few which attract notice as in any way beautiful.

NAIADS, in Grecian Mythology, the nymphs of fresh-water lakes, rivers, and fountains. They were believed to possess the power of inspiration; hence, soothsayers and others are sometimes called *nympholeptoi* (seized by the nymph). They were represented as half-clothed maidens, and not unfrequently as companions of Pan, of Hercules, the patron of warm springs, or of the Sileni and the Satyrs, in whose jovial dances they join.

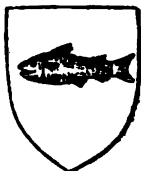

Naiant.

NAIANT, or NATANT (Lat. *natare*, to swim), a heraldic term applied to a fish when borne horizontally across the shield in a swimming position.

NAIGUE, or NAIK, a native subaltern officer among Indian and Anglo-Asiatic troops, whose functions are somewhat analogous to those performed among European troops by the drill-sergeant.

NAILS are flattened, elastic, horny plates, which are placed as protective coverings on the dorsal surface of the terminal phalanges of the fingers and toes. Each nail consists of a *root*, or part concealed within a fold of the skin; a *body*, or exposed part attached to the surface of the skin; and a free anterior extremity called the *edge*. The skin below the root and body of the nail is termed the *matrix*, from its being the part from which the nail is produced. This is thick, and covered with highly vascular papillæ, and its colour is seen through the transparent horny tissue. Near the root, the papillæ are smaller and less vascular; hence

the portion of nail corresponding to this part is of a whiter colour; from its form, this portion is termed the *lunula*. It is by the successive growth of new cells at the root and under the body of the nail that it advances forwards, and maintains a due thickness, whilst at the same time its growth in a proper direction is insured. The chemical composition of the nails is given in the article **HORNY TISSUES**, to which class of structures they belong. According to the observation of Beau, the finger-nails grow at the rate of about two-fifths of a line in a week, while the toe-nails only grow with about one-fourth of that rapidity. When a nail has been removed by violence, or has been thrown off in consequence of the formation of matter (*pus*) beneath it, a new nail is speedily formed, provided the matrix has not been seriously injured.

There is a very common and troublesome affection popularly known as *ingrowing nail*. Its most usual seat is by the side of the great toe. It does not in reality arise from any alteration of the nail, but from the adjacent soft parts being constantly pressed by the use of tight shoes against its edge. These parts become swollen and inflamed; suppuration ensues, and an intensely sensitive ulcer is formed, in which the nail is embedded. Surgical advice should at once be resorted to in these cases, as there is no probability that the ulcer will heal spontaneously, especially if the patient continue to move about, and thus keep up irritation. In obstinate cases, it is not unfrequently necessary to remove a portion of the nail, an operation attended with much pain, although quickly performed.

NAILS, pointed pieces of metal, usually with flattened or rounded heads, used for driving into wood-work, for the purpose of holding the pieces together. A variety, in which the head is very large, and the spike portion small, used by shoemakers for protecting the soles of boots and shoes from wear, is called the *hob-nail*; another, which is made by cutting thin plate-iron into thin pointed pieces of various lengths, is called *brads*; these sometimes are without heads, but are usually made with a slight projection by way of a head. When made small, with flat heads, for attaching cloth or hangings in upholstery-work, they are called *tacks*; and when very large for heavy carpentry, *spikes*.

Nail-making.—Formerly, all nails were hand-made, by forging on an anvil; and in Britain and the north of Europe, vast quantities are still made in this manner, being preferable, for many kinds of carpenters' work, to those made by machinery. In France, the greater part of the nails used for light carpentry-work are made of soft iron wire, pointed with the hammer; and in order to head them, they are pinched in a toothed vice, which leaves the portion for the head projecting, and makes below it three or four grooves in the nail, which increase its hold on the wood when driven home. The head is beaten into a counter-sinking on the vice, which regulates the size.

The iron used for hand nail-making in Britain is sold in bundles, and is called *soft-rod*; it is either prepared by rolling the malleable iron into rods or small bars of the required thickness—which process is only employed for very fine qualities—or by cutting plate-iron into strips by means of rolling-shears: these shears consist of two powerful revolving shafts (*a, a*, fig.), upon which are fixed discs of hard steel with squared edges (*b, b*, fig.). The discs of one shaft alternate with those of the other; they are of the thickness of the plate to be cut, and the shafts are so placed, that a small portion of one set of the discs are inserted between those of the other set. When the shafts are revolving, a plate of iron is

pressed between the discs in the plane of the dotted line *c, c*, fig.; and it is forcibly drawn through, the steel discs cutting the plates into strips with

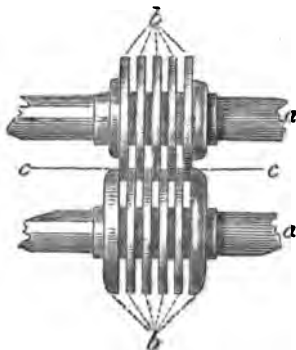

great rapidity. The quantity produced in this way is enormous, some mills turning out at the rate of ten miles per hour of nail-rods.

Several inventions, in which America took the lead, have been introduced, and are successfully worked, for making nails direct from plate-iron, either by cutting them out cold or hot; and a very large proportion of the nails in use are made in this way. Nail-making by machinery was originated in Massachusetts in 1810.

NAIN DE TILLEMONT. See TILLEMONT.

NAIRN, in the county of the same name, is a royal, parliamentary, and municipal burgh, and is 15 miles north-east by rail from Inverness. It is situated at the mouth of the river Nairn, on the west side, and for that reason was anciently called *Inver-nairn*. Lying on the southern shore of the Moray Firth, which is here about eight miles across, it commands a grand and extensive view of the coast of Ross-shire, including Cromarty Bay, nearly opposite. N. was regularised by William the Lion. It has little historical interest, and few objects worthy of antiquarian attention. It is principally remarkable for the excellence of its sea-bathing and artificial baths, in which respect it is equal, if not superior, to any town in the north of Scotland, and on account of which it is a fashionable place of resort in the summer season. The temperature is mild and equable. The inhabitants enjoy a remarkable immunity from epidemic diseases. There is a commodious harbour. The town has a literary society, a museum, a newspaper, and three branch banks. Pop. in 1861, 3829; constituency in 1863, 131. N. unites with Inverness, Forres, and Fortrose in sending a member to parliament.

NAIRNSHIRE is bounded on the N. by the Moray Firth, and on its other sides by the counties of Inverness and Moray, of the latter of which it anciently formed a part. It extends north and south 22 miles, and 15 miles from east to west. Its area is 215 square miles, or 137,500 acres. Pop. in 1861, 10,066, including the burgh of Nairn; constituency in 1863, 293. The rental, according to the valuation roll of 1863—1864, is £26,743, 16s. 5d., exclusive of the railway valuation. Nairn is the only royal burgh in the county, but there are the villages of Cawdor and Auldearn. The soil is for the most part light and sandy. There is, however, considerable agricultural activity, though the county is perhaps better known for its cattle-breeding. An important cattle 'tryst' is held at Cawdor once a month during the greater part of the year. The

climate of this county is distinguished for its salubrity, and the temperature is remarkably equable. The thermometer in the shade has not risen above 78° 3', or fallen below 11° 2', during the last twenty years. According to the latest observations, the yearly rainfall did not amount to more than 26 inches, the greatest fall being in October, and the least in April. At Brackla Distillery, which belongs to Robert Fraser, Esq., from 40,000 to 50,000 gallons of spirits are manufactured annually. The river Nairn runs through the county in a beautiful valley, which presents particularly attractive and romantic scenery in the neighbourhood of Cawdor Castle, one of the residences of the Earl of Cawdor. This castle is of uncertain antiquity, and is in an excellent state of preservation. It was the residence of the ancient Thanes of Cawdor, one of whom is mentioned in *Macbeth*. About the year 1510, the estates belonging to the earldom passed by marriage from the old family of Calder into the hands of a son of the Duke of Argyle, and are still in the possession of his descendants. Not a few other objects of antiquarian interest are to be found in the county of Nairn.



Nairncoat.

NAISSANT, a term applied in heraldic blazon to an animal depicted as coming forth out of the middle—not like *Issuant* (q. v.), out of the boundary line—of an ordinary.

NAKHICHEVAN, ON THE DON, a thriving town of South Russia, in the government of Ekaterinoslav, on the right bank of the Don, and near the mouth of that river, two miles east of Rostov. It was founded in 1779 by Armenian settlers from the Crimea, and has 13,200 inhabitants, mostly Armenians, belonging to the Greek-Armenian Church. There are several factories, chiefly for the manufacture of woollen goods, and an extensive trade is carried on.

NAKSHATRA (a Sanscrit word of doubtful etymology, but probably a compound of an obsolete base *naksha*, night, and *tra*, protecting, i. e., literally night-protecting) means properly star, and is used in this sense in the Vedas. At a later period, it was applied to the asterisms lying in the moon's path, or to the mansions in which the moon is supposed to rest in her, or rather, according to Hindu notions, *his* path. The number of these asterisms was reckoned originally at 27, later at 28; and mythology transformed them into as many daughters of the patriarch Dakaha, who became the wives of the moon. See MOON. Biot, the distinguished French astronomer, endeavoured to shew that the Hindu system of the Nakshatras was derived from the Chinese *sies*; but his theory, though supported by very learned arguments, has been refuted by Professor Whitney, in his notes to Burgess's translation of the *Sārya-Siddhānta* (New Haven, United States, 1860), and by Professor Müller in his preface to the 4th volume of the *Rig-Veda* (Lond. 1862); for their arguments leave little doubt that the system of the Nakshatras originated from the Hindu mind.

NALA is a legendary king of ancient India—a king of Nishadha—whose love for Damayanti, the daughter of Bhīma, king of Vidarbha, and the adventures arising from, or connected with, it—the loss of his kingdom, the abandonment of his wife and children, and their ultimate restoration—have supplied several Hindu poets with the subject of their muse. The oldest poem relating to Nala and Damayanti is a celebrated episode of the *Mahābhārata* (q. v.), edited both in India and Europe, and translated

in Latin by Bopp; in German by Kosegarten, Bopp, Rückert, and Meier; and in English by Dean Milman. The two other renowned poems treating of the same legend, but with far less completeness, are the *Nalodaya* (q. v.) and the *Naiśhadracharita* of Śrī-Harsha.

NALODAYA is the name of a Sanscrit poem which is highly prized by the modern Hindus. Its subject is the story of Nala (q. v.), but more concisely narrated than in the episode of the *Mahābhārata*, whence its contents are borrowed; and its reputed author is Kālidāsa (q. v.). Great doubts, however, must attach to the attribution of this authorship, if by Kālidāsa the author of *Śakuntala* is meant, and not some other poet bearing the same name; for the merits of this poem consist neither in elevation of thought nor in richness of fiction: they are sought for by the Hindus in its elaborate and artificial diction, and in its alliteration of every variety, which, to a European mind of culture and taste, would be no more than an intolerable jingle of sounds, devoid of all poetical worth. The text of the poem, with a modern commentary, has been edited (Berlin, 1830) by F. Benary, and (Calcutta, 1844) by W. Yates, who added to his edition a free metrical translation of the text, and an essay on Sanscrit Alliteration.

NAMA'QUALAND, GREAT. The extensive region in South Africa north of the Cape Colony, extending from the Orange River, lat. 29° 30', to Walfish Bay, lat. 23°, and stretching inland from the west coast to the Kalihari Desert, comprehending an area of about 100,000 square miles, is known under the name of Great N., being principally inhabited by wandering tribes of Namaquas (q. v.). This region is drained principally by a large periodical water-course, called the Oup, Borradaile, or Great Fish River, which, running from north to south a distance of about 450 miles, joins the Orange River nearly at right angles, about 90 miles from its mouth. It is generally, except in its northern parts, where the country rises into extensive and lofty plateaus, a most sterile and barren region, and along a coast-line of upwards of 400 miles does not present a single running stream, much less a navigable river, although a few little bays along the coast, such as Angra Pequena, Sandwich Harbour, and Walfish Bay, afford safe anchorages. The valley of the Oup is bounded on each side by ranges of flat-topped barren mountains, which to the eastward die away into the waterless though wooded flats of the Kalihari Desert, and coastwards stretch into vast sandy downs, against which the Southern Atlantic beats an unceasing surf, rendering landing very dangerous, and enveloping the coast in a perpetual mist. The chief productions of the region are cattle, for the rearing of which the country seems favourable. On the edge of the Kalihari, ivory and ostrich feathers are collected, and copper ore seems abundant in several localities. Guano is found at Ichaboe and many little islands on the coast, and considerable fisheries are carried on by Cape houses in many of the bays.

The lion, giraffe, rhinoceros, hippopotamus, and large game generally, are still found in N., although fast diminishing before the firearms of the Namaquas. The snakes are considered especially venomous. The gemsbok, eland, and other large antelopes, now almost unknown in the Cape Colony, are still numerous in the little-frequented wastes of this region. The climate is extreme, and though, on the whole, not unhealthy, is very trying to European constitutions. The water is generally brackish. The first English traveller in N. was Sir J. Alexander, who, in 1837, traversed it from north to

south. Charles John Andersson has also explored every part of it. Information on the region may be also found in the travels of Moffat, Campbell, and Le Vaillant. The native tribes, who may perhaps number about 50,000 souls, speak the Namaqua language, the purest type of the Hottentot.

NAMAQUALAND, LITTLE, is a division of Cape Colony south of the Orange River, formerly part of the district of Clanwilliam, and included with the country north of it under the general name of Namaqualand. It is a very barren region, covered with rugged volcanic-looking hills, through which the Gariep or Great Orange River appears, through some convulsion of nature, to have forced its way to the sea. Little N. has of late years afforded a very large supply of copper ore of excellent quality, but the mines, although not worked to any extent until within the last seven or eight years, were well known to the Dutch 200 years ago. The principal river is the Orange of the colonists, which divides the Cape Colony from Great Namaqualand; all the other streams are merely periodical torrents, often dry for years. The seat of magistracy is at Springbok Fontein, about 80 miles from the principal harbour, Hondeklip Bay, and where are situated the very rich mines of the Cape Copper Company. Many scattered tribes of Namaquas and Bastard Hottentots roam along the bank of the Orange River, and in the neighbourhood of the mines are numerous Dutch farmers and English settlers. All the larger mammals, except a few gemsbok, are extirpated; but troops of ostriches are still numerous on the grassy flats of the Bushman country. The geological features of this region are peculiarly interesting, and have been thoroughly explored by A. Wylie, on behalf of the Cape government. The rocks are generally of granite or gneiss, intersected with numerous veins of cupreous indications, and near the Orange River, present many very curious features. The coast-line extends for 100 miles, with a few little bays, such as Port Naloth and Hondeklip, where there is tolerably safe anchorage, and generally presents a shore covered with low granite rocks. At Hondeklip Bay, a large boulder painted red forms a distinguishing landmark.

NAMA'QUAS, the principal existing tribe of the race generally known under the name of Hottentot. They inhabit the region called Great Namaqualand, north of the Gariep or Orange River, and the country a few miles south of it, as far as the Kamiesbergen. They are a pastoral people of rather predatory habits, and live under the rule of their chiefs, whose powers, however, are of a very limited nature. Differing from the Bosjesmen Hottentots, the N. are a tall, well-made, active people, although presenting the usual peculiarities of the race, such as the light olive complexion, the oblique eye, and short tufted hair. They speak a dialect of the Hottentot language, which, however, differs considerably from that used by other tribes of that people. Mission stations of the Rhenish and Wesleyan societies have been for many years established amongst them, and in a few localities, near the Cape Colony, with considerable success; and the New Testament and some elementary works have been translated into the Namaqua dialect. On the northern borders of the regions they inhabit, the N., under the chief Africaner, the descendant of a fugitive slave from Cape Colony, have for many years kept up a predatory and bloody war with the tribes of Ovampos and Damaros, who live north of Walfish Bay. The total number of N. cannot exceed between 50,000 and 60,000 souls, scattered over a region of at least 150,000 square miles; and there is every prospect of the pure

NAME

Hottentot tribes soon becoming extinct, or at least absorbed, being gradually supplanted by the more energetic and civilised Bastard races, who, in point of civilisation and appearance, are very little inferior to the ordinary Dutch Boer of Cape Colony. Many of the southern N. possess wagons and oxen, and are employed in the transport of copper ore from the mines of Little Namaqualand to the shipping port at Hondeklip Bay.

A few of the peculiar customs of the Hottentot tribes, described by Kolben nearly 200 years ago, may be still traced amongst the more remote tribes of the N.; but contact with the Cape Colonists, and the efforts of the missionaries, have partially civilised this race, so that an ordinary Hottentot is quite as respectable a savage, or perhaps more so than his Betjouana or Amakosa brethren.

NAME (Sax. *nama*, Ger. *name*, Lat. *nomen*, Gr. *onoma*), the word by which a particular person or thing is signified in distinction from other persons or things. A name attached to a person is called a proper name. Names distinguishing one individual from another have been in use from the earliest ages of human society. Among the Jews, the name given to a child either originated in some circumstance of birth, or was an expression of religious sentiment. Old Testament names are almost all original—i. e., given in the first instance to the person bearing them; but the Jews, like other nations, after accumulating a considerable stock of names, began to repeat them, and we find few names in the New Testament which had not been used before. In Old Testament times, it was an occasional practice to adopt a change of name on the occasion of an important event in one's life.

The Greeks bore only one name, given on the tenth day after birth, which it was the right of the father to choose, and alter if he pleased. The earliest Greek names are generally expressive of some quality in high estimation, as valour, skill, wisdom, or gracefulness (Callimachus, excellent fighter; Pherocrates, strength bringer; Sophron, wise; Melanthus, black flower). In later times, when the faith in the gods was on the wane, names derived from Apollo and Athene, or indicative of the favour of Olympus (Apollodorus, gift of Apollo), came more into fashion. The eldest son generally bore the name of his paternal grandfather, and the confusion arising from the repetition of the same name was attempted to be obviated by appending the father's name (either simply, or turned into a patronymic), the occupation, the place of birth, or a nickname.

The Romans at a very early period bore two names, and afterwards every Roman citizen had three. The *prænomen*, like our Christian name, was personal to the individual—Caius, Marcus, Cneius; in writing, generally abbreviated to an initial or two letters, C., M., or Cn. It was given in early times on the attainment of puberty, and afterwards on the ninth day after birth. There were about thirty recognised *prænomena*. Women had no *prænomen* till marriage, when they took the feminine form of that borne by their husband. Every Roman citizen belonged both to a *gens* and to a *familia* included in that *gens*. The second name was the *nomen gentilicium*, generally ending in *-ius*, *-etius*, or *-aius*. The third name was the hereditary *cognomen* belonging to the *familia*. *Cognomena* were often derived from some bodily peculiarity, or event in the life of the founder of the family. A second *cognomen*, or *agnomen*, as it was called, was sometimes added by way of honorary distinction. In common intercourse, the *prænomen* and *cognomen* were used without the *nomen gentilicium*, as C. Cæsar for C. Julius Cæsar,

M. Cicero for M. Tullius Cicero. The Roman names were in their origin less dignified and aspiring than the Greek; some were derived from ordinary employments, as Porcius (swineherd), Cicero (vetch grower); some from personal peculiarities, Crassus (fat), Naso (long-nosed); a few from numerals, Sextus, Septimus.

The Celtic and Teutonic names, like the Jewish and Greek, had been originally very significant; but at an early period their exuberance became checked; people contented themselves with repeating the old stock. While the speech of Europe was undergoing a transformation, the names in use remained the same; belonging to an obsolete tongue, their signification by and by became unintelligible to the people using them. Many are derived from 'God,' as Gottfried, Godwin; some from an inferior class of gods known by the title *as* or *ans*, whence Anselm, Oscar, Esmond; others from elves or geni, Alfred, Alboin, Elfric (Elf King). Bertha is the name of a favourite feminine goddess and source of light, from the same root as the word 'bright'; the same word occurs as a compound in Albrecht, Bertram. To a large class of names indicating such qualities as personal prowess, wisdom, and nobility of birth, belong Hildebrand (war brand), Konrad (bold in counsel), Hlodwig (glorious warrior), called by us Clovis, and the original of Ludwig and Louis. The wolf, the bear, the eagle, the boar, and the lion entered into the composition of many proper names of men, as Adolf (noble wolf), Arnold (valiant eagle), Osborn (God bear). Respect for feminine prowess also appeared in such names as Mathilde (mighty amazon), Wolfhilde (wolf heroine). The spread of Christianity threw a number of the old names into comparative oblivion, and introduced new ones. The name selected at baptism was more frequently taken from the history of the Bible or the church than from the old traditional repertory, which, however, was never altogether disused. Many names, supposed to be local and very ancient, particularly in the Scottish Highlands, Wales, and Cornwall, are in reality but corruptions of names of Christian origin which are in use elsewhere. Owen, Evan, and Eoghan (the latter often Anglicised into Hector) seem all to be forms of Johann or John. A change of name was sometimes made at confirmation.

Periods of religious and political excitement have had a very powerful influence in modifying the fashion in names. The Puritans would only admit of two classes of names, those directly expressive of religious sentiment—Praise-God, Live-well—and names which occur in Scripture; these latter indiscriminately made use of, however obscure their meaning, or however indifferent the character of the original bearer of them. Old Testament names were used in preference to New, probably because they did not convey the notion of a patron saint. Old Testament names still prevail largely in America, where exists a medley of Christian names from all possible sources. At the French Revolution, names supposed to savour of either loyalty or religion were abandoned, and those of Greek and Roman heroes came into vogue instead. The Augustan period of English literature gave a temporary popularity to such feminine names as Narcissa, Celia, Sabina. In Germany, the names in use are particularly free from foreign admixture; they are almost all either of Teutonic origin, or connected with the early history of Christianity. In Britain, the number of names has, particularly since the Reformation, been more limited than in most other countries. In some families of distinction, unusual names have been handed down from father to son for centuries—a g., Peregrine among the

Bertie, and Sholto in the Douglas family. The accumulation of two or more Christian names only became common in the present century, and another practice which has gained ground in Britain is the use of surnames as Christian names. More recently, various old names, particularly feminine names, as Maud, Florence, Ethel, have been withdrawn from their obscurity, and resuscitated.

The use of fixed family surnames cannot be traced much further back than the latter part of the 10th century. They first came into use in France, and particularly in Normandy. At the Conquest, they were introduced into England by the Norman adventurers, and were general at the Domesday Valuation. Many of the followers of William had taken names from their paternal chateaux or villages on the other side of the Channel, names which were used with the French preposition *de* before them. Their younger sons and others applied the 'de' to estates awarded them as their portion of the conquered country, and called themselves De Hastings, De Winton, &c., a prefix probably never in vernacular use in England, and completely discarded with the disappearance of Norman-French, unless in a few cases where it was retained for the sake of euphony, or from coalescing with the initial vowel, as in De la Beche, Danvers (d'Anvers), Dangerfield (d'Angerville). When English was used in place of Norman-French, the 'de' was always rendered into 'of'. The affectation of resuming it in recent times is as unwarrantable in theory as in taste. Such a designation as Lord De Tabley of Tabley House is an unmeaning tautology. The Scotch have a more expressive designation when they say Colquhoun of that Ilk. In France and Germany, a territorial surname (denoted by 'de' or 'von') came, when surnames spread to all classes, to be the mark of nobility, so much so that in later times, when any one was ennobled by the sovereign, the 'de' was prefixed to his previously plebeian and not territorial name. In Britain, the 'de' was never considered the test of nobility; the names of some of the most distinguished families were not territorial—e. g., Stewart, Butler, Spencer. In Scotland, surnames were hardly in use till the 12th c., and were for a long time very variable. The assumption of surnames by the common people is everywhere of much later date than their use by noble (gentle) families. As yet, they can hardly be said to be adopted by the people of the wilder districts of Wales.

There are many existing local surnames in Britain besides those derived from the names of the manors of the gentry or landholders. Farms, homesteads, the natural features of the country, all gave their names to those who resided at or near them; hence such names as Wood, Marsh, Dale. The preposition 'at' is in a few cases retained, as in Atwood, A'Court, Nash (atten-ash, i. e., at the ash). The travelling habits of the Scots account for such names as Inglis, Fleming, Welsh (the original of Wallace), applied to those who had visited foreign parts; and sometimes a Scotsman, wandering into England, returned with the acquired name of Scott.

A large class of surnames are patronymics, often formed by 'son,' or its equivalent in the language of the country, added to the Christian name of the father. Names of this sort often fluctuate from generation to generation. Alan Walterson had a son, Walter, who called himself Walter Alanson. The genitive case of the father's name sometimes served the same purpose, as Adams, Jones; and similarly in Italian, Desso, Dossi. A fashion of using 'Fitz,' the equivalent of 'son,' before the ancestral name, as in Fitzherbert, prevailed temporarily in Normandy, whence it was imported into

England. In the Highlands of Scotland, the prefix 'Mac' (Macdonald) served the same purpose, which, however, fluctuated far longer than the patronymic surnames of England and the Lowlands; so also the 'O' (grandson) of the Irish (O'Neil), and 'Ap' of the Welsh (Ap Rhys, otherwise Apreece). The 'de' of France had sometimes a similar origin, as in d'André, d'Hugues; and still more frequently the 'de,' 'dei,' or 'degli' of Italy—di Cola, di Giacomo.

Office, occupation, or condition, gives rise to surnames—e. g., Knight, Marshall, Page, Smith, Brewster, Shepherd; in Germany and Holland, Ranber and de Rogver (robber): and from such appellatives, patronymics may be again derived; thus, we have Smithson, de Maistre (master's son), M'Nab (son of the abbot), M'Pherson (son of the parson), del Sarto (son of the tailor), &c. So also personal qualities—Black, White, Strong, Stark, Lang (long), Littlejohn, Cruikshanks; and nicknames have not unfrequently been perpetuated as surnames. We have also surnames derived from the signs and cognizances which were borne in the middle ages, not only by inns and shops, but by private houses. John at the Bell became John Bell; at Middleburg, in Holland, Simon, apothecary in the 'Drake,' or Dragon, became Simon Draek; hence, probably, the frequency of family names derived from animals, and also of those beginning with 'Saint,' though this last class may, perhaps, sometimes have had its origin in the first owner of the name dedicating himself to the service of the saint in question. In Scotland and Ireland, 'The' is a distinctive title borne by the heads of some old families—as 'The Chisholm,' 'The O'Connor Don.' In the Highlands of Scotland, the chief of a clan is usually addressed by the name alone in a marked manner: thus, 'MacLeod' implies specially MacLeod of Dunvegan, in Skye, head of the clan MacLeod; 'Mackintosh,' in like manner, applies solely to Mackintosh of Moy, in Inverness-shire.

In England, the number of existing surnames approaches to 40,000, or about one to every five hundred individuals; in Scotland, there are far fewer surnames in proportion to the population. The remarkable predominance of certain surnames in certain localities—as Campbell, Cameron, Maclean in Argyleshire, Macdonald in Inverness, Mackay in Sutherland, Gordon and Forbes in Aberdeenshire, and Scott, Ker, Elliot, Maxwell, and Johnstone on the borders—arises from the clansmen having made a practice of taking the name of their chiefs, considering themselves members of their family by adoption, if not otherwise. Elsewhere than in Scotland, vassals often adopted the names of their lords, and servants those of their masters. Two or more surnames are often borne by one individual, in which case the paternal surname is sometimes placed first, sometimes last; and, in recent times, it is by the name which occurs last that the bearer of the two surnames is most frequently known.

The wife, with us at least, changes her surname to that of her husband on marriage. In the continent, it is not unusual for the husband to append his wife's name to his own; and in Spain, the wife retains her own name, while the son is at liberty to use either paternal or maternal name as he pleases, the choice generally falling on the best family.

Change of name.—Prior to the Reformation, surnames were less fixed than they have since become. Occasionally, younger sons, instead of retaining their patronymic, adopted the name of their estate or place of residence. A great matrimonial alliance was a frequent cause for adopting the patronymic of the wife. With the clergy, ordination was a common occasion of a change of name, the personal surname being

exchanged for the name of the place of birth—thus, William Longe became William of Wykeham. In time of political troubles, a new name was often assumed for concealment; and in Scotland, the name of M'Gregor was proscribed in 1664 by an act of the privy council. In modern times, injunctions in settlements of land, and deeds of entail, are frequent grounds for a change of name, it being made a condition that the devisee or donee shall assume a certain surname under penalty of forfeiture, a stipulation which the law recognises as valid. Such an obligation is often combined with one relative to arms. In a Scotch entail, it is a very frequent condition that each succeeding heir of entail, or husband of an heiress of entail, shall assume the *entailer's* name and *arms*, or his name and *arms exclusively*; in the former case, he may, if he pleases, continue to use his own surname along with the assumed one. The heir of entail is not held legally to take up any arms not otherwise his own, unless he have applied to the heraldic authorities for leave so to do. Where a Scotch entail contained an injunction to bear arms which had no existence in the official record of arms, the condition has not been held to be null; the heir of entail must apply to the Lord Lyon for a grant of arms bearing the designation of those disposed. In England, it used to be common to obtain a private act of parliament to authorise one to change his surname; and authority for such a proceeding has generally been given in later times by royal licence, which is granted only on a reasonable ground being established for the alteration, to the satisfaction of the kings-at-arms, to whom a remit is made. It has sometimes been supposed that this royal licence is necessary to legalise such a change, but the highest legal authorities have laid it down that there is nothing in the law of England to prevent any one, who may consider it for his interest so to do, to change his surname, or even his Christian name. The idea, lately prevalent to some extent, is equally erroneous, that an advertisement in a gazette or newspaper, or the execution of some deed, is a necessary form in order to effect a change of name. There are always great inconveniences in changing one's name, which sufficiently account for the general indisposition to do so, except from a questionable motive. As there is no law to prevent a person from changing his name, so there is, on the other hand, no law to compel third parties to use the new name, and disputes and annoyances arising from such a state of things are matters of course. The change tends to a certain extent to destroy the means of identification after the lapse of years, which may or may not be the object desired. Notwithstanding these difficulties and inconveniences, there are many examples of persons who have succeeded after a few years in being generally known under a new name, and of the public as well as his friends recognising it. The change of name, in general, produces no change whatever on the legal status. A party is equally punishable for swindling, larceny, and other cognate offences, whatever name he uses; and, on the other hand, if he is legatee, he is not prevented from establishing and receiving his legacy, whatever name he has adopted. It follows from what precedes that no person is punishable for using a new name, though it is sometimes an ingredient for a jury to take into consideration when they are required to infer a particular motive of conduct. The royal licence is practically required to be obtained by Englishmen (not Scotchmen) holding commissions in the army, as also when the change of name is to be accompanied by a change of arms, it being the practice of the English Heralds' College to refuse to

grant arms corresponding to such change, unless the royal licence have been obtained. In Scotland, a *bona fide* change of name requires neither royal, judicial, nor parliamentary authority, the sole exception being the case of members of the College of Justice, who require the permission of the Court of Session. A royal licence is not generally applied for by natives of Scotland, as it is not required to be produced to the Lord Lyon on applying for a corresponding change of arms. The arms will generally be granted when the Lord Lyon is satisfied that the change has been made on some reasonable ground, and not from a purely capricious motive; and the fact of the change of name, with the reason why it has been made, are narrated in the new patent of arms. When such change of surname and corresponding change of arms has been made by a Scotsman who is an officer in the army, the authorities of the War Office are in the habit of requiring a certificate from the Lyon Office to the effect that the change is recognised there.

Names of places.—These, like names of persons, belong, in a great measure, to the language of past races. All over Great Britain, a very large proportion are derived from the Celtic names for natural features of the country. From *Gwyng, afow, tam, tav, cluyd*—in the Celtic speeches equivalent to *water or river*—we have Esk, Avon, Wye, Thames, Tavy, Clyde. *Pen* or *Ben*, hill, gives rise to the names of hills in England and Wales (Penrhys, Penzance), and still more in Scotland (Ben Nevis). So, also, *cum, comb, valley*—as in Cumberland, land of valleys. The memory of the Roman invasion has been preserved in the termination *-chester* (derived from *castra*) in the names of towns, as Manchester. Though surnames often originated in local names, the reverse process also occurred; as where *ville, ton* or *ington, ham, or burgh*, has been appended to the name of the owner of the land, e.g., Charleville, Johnston, Wymondham, Edinburgh (i.e., Edwin's burgh).

See Wackernagel, 'Die Germanische Personennamen,' in the *Schweizerische Museum* (1837); Miss Yonge, *History of Christian Names* (Lond. 1863); Lower, *On English Surnames* (Lond. 1849); Professor Innes, *Concerning some Scotch Surnames* (Edin. 1860).

NAMUR, a province of Belgium, bounded on the N. by Brabant, E. by Luxembourg and Liege, W. by Hainault, and S. by France. Area about 1400 square miles. Pop. 301,397 (at the end of 1861). The principal rivers are the Meuse—which entirely intersects the province—the Sambre, and the Lesse. N. presents generally an alternation of fruitful valleys and low hilly tracts; but in some parts, where the heights constitute offshoots of the Ardennes, and are densely wooded, they attain a considerable elevation. With the exception of the land in the south-west, where there are large tracts of bog and heath, the soil is extremely rich, yielding abundant crops and fine pasture. The chief products of N. are wheat, oats, hops, oil yielding plants, and flax. Besides iron, copper, lead, and coal mines, N. has marble and slate quarries, and yields sulphur, alum, cadmium, alumina, flints, &c. It has good steel, iron, and smelting works, breweries, paper-mills, &c. N. is divided into the three arrondissements of Namur, Dinant, and Philippeville. At the close of the 12th c., N. was united to Luxembourg, after having existed as an independent countship for upwards of 150 years. Towards the middle of the 13th c., it passed by purchase to the House of Flanders, which retained possession of it till 1420; when, on the death of Count John III., without direct heirs, the countship, which was in a state of extreme financial embarrassment, was purchased for

132,000 gold ducats, by Philip the Good, Duke of Burgundy, and subsequently shared the fate of the other Burgundian states.

NAMUR (Flem. *Namen*), the chief town of the province of the same name, is situated at the confluence of the Sambre with the Meuse, and is a strongly fortified town and the seat of a bishop. Pop. 25,989 (at the beginning of 1862). Among its seventeen churches, the cathedral, or St Aubin's, which was consecrated in 1772, is one of the most beautiful churches of Belgium. N. has an academy of painting, a conservatoire for music, two public libraries, a museum; a theological seminary, and a college conducted by Jesuits. The present citadel was constructed in 1784, but the city has been fortified from the earliest period of its history; and in 1692, its defensive works were repaired and strengthened by Coehoorn, only, however, to be taken in the following year by Louis XIV. and Vauban, the latter of whom added considerably to its original strength. The reputation of its citadel made N. a prized stronghold in every war of later times; and after having been gallantly defended by its French conquerors, in 1815, against the Prussians under Pirch, it was finally restored to the Netherlands after the battle of Waterloo, and at once put into thorough repair. N. is noted for its cutlery, its leather-works, and its iron and brass foundries.

NANCY, one of the most beautiful towns of France, capital of the department of Meurthe, is situated on the left bank of the river of that name, at the foot of wooded and vine-clad hills, 220 miles east of Paris, on the Paris and Strasbourg Railway. Pop. 43,221. It is divided into the old and new towns (the former irregular and with narrow streets, the latter open and handsome), and comprises also two suburbs. It contains many handsome squares and imposing edifices, and owes much of its architectural ornamentation to Stanislaus Leczinaky, who, after abdicating the crown of Poland in 1735, continued to reside here as Duke of Lorraine till his death, in 1766. His statue stands in the Place Royale, a fine square, surrounded by important public buildings, as the Hôtel de Ville, theatre, &c. The gates of N. look more like triumphal arches than the ordinary entrances of a town. Among the institutions are the university-academy, the normal school, the school of medicine, the lyceum, the public library, and numerous art and scientific societies. Cotton, woollen, and linen manufactures are carried on; but the principal branch of industry is the embroidering of cambric, muslin, and jaconet goods.

N. is known to have been in existence in the 11th century. Two centuries later, it became the capital of the Duchy of Lorraine (q. v.). Charles the Bold was killed while besieging the city in 1477.

NANDU, or **AMERICAN OSTRICH** (*Rhea*), a genus of South American birds allied to the ostrich, cassowary, and emu, and most nearly to the ostrich, from which it differs in having the feet three-toed, and each toe armed with a claw; also, in being more completely feathered on the head and neck; in having no tail; and in having the wings better developed and plumed, and terminated by a hooked spur. The wings are indeed better developed than in any other of the *Struthionidae*, although still unfit for flight. The neck has sixteen vertebrae. There are at least three species. The best known species (*R. Americana*) is considerably smaller than the ostrich, standing about five feet high. It is of uniform gray colour, except on the back, which has a brown tint. The male is larger and darker coloured than the female. The back and rump are furnished with long feathers, but of a more ordinary kind

than those of the ostrich. This bird inhabits the great grassy plains of South America, southward of the equator, abounding on the banks of the La Plata and its more southern tributaries, and as far south as lat. 42° or 43°. Its range does not extend across the Cordilleras. It is generally seen in small troops. It runs with great celerity, using its wings in aid. It is polygamous, one male securing possession of two or more females, which lay their eggs in



Nandu (*Rhea Americana*).

a common nest, or drop them on the ground near the nest, to which the male rolls them. Contrary to the usual habit of birds, incubation is performed by the male. The N. is shy and wary, but is successfully hunted by the Indians, generally on horseback. The flesh of the young is not unpleasant. The N. is capable of being domesticated.—A smaller and more recently-discovered species (*R. Darwinii*) has light-brown plumage, each feather tipped with white. It inhabits Patagonia. A third species (*R. macrorhyncha*) is distinguished by its large bill.

NANKEEN CLOTH. Calico of the kind called 'nankeen,' or nankin, was formerly imported extensively from China to Europe, and said to be the manufacture of Nanking; the colour, a yellowish-buff, being a favourite one. It was supposed that the Chinese held a secret for dyeing this colour, which was found to be remarkably durable; but it became known that it was not an artificial colour at all, the cloth being made of a coloured variety of cotton, which was produced occasionally in China and India. Artificially dyed nankeen cloths now form a considerable export from England to China.

The colour of artificial nankeen cloth is produced by an elaborate process, in which the yarn or cloth is first dipped in a saturated solution of alum; then in a decoction of oak-bark; then in a bath of lime-water; and next in a bath of nitro-muriate of tin. Another, but less permanent, nankeen dye is produced by boiling annatto in a strong solution of pearl-ashes, and diluting with water to the required tint.

NANKING, capital of the province of Kiangsu, formerly the capital of China, on the Yangtse River, 90 miles from the beginning of its estuary, N. lat. 32° 40' 40", E. long. 118° 47'. Its name signifies the Southern Capital. Since the removal of the seat of government to Peking (Northern Capital), it has been called by the Chinese Kiangning-fu. The present city of N. is surrounded by a wall about fifty feet high, and has thirteen gates; it was about thirty-five miles in extent, with eighteen gates, when the city was the flourishing metropolis of the empire. According to Chinese accounts, the population of N. was once 4,000,000; but a more recent estimate

makes it 300,000. As the city has lately passed through so many vicissitudes, and is now the headquarters of the rebel forces, it is impossible to ascertain its present number of inhabitants. The gates differ somewhat from each other in their appearance and dimensions. Some of the finest are 30 or 40 feet high, by about 20 in width, and the arched gateways are 100 or more feet in length. In every provincial capital there is a Manchu garrison, or military colony, separated by a wall from that portion of the city which is occupied by the Chinese. Some of the finest streets of N. are to be found in the Tartar city; several being nearly 40 feet wide, having a space in the middle of about 8 feet in width, flagged with well-hewn blocks of blue and white marble, and on each side of this a brick pavement 14 feet or more wide. A deep canal or ditch runs from the river directly under the walls on the west, serving to strengthen the defences of the city on that side. The ancient palaces have all disappeared. The offices of the public functionaries are numerous, but, like the shops, present the general features common to all Chinese towns. The objects most worthy the inspection of the traveller are found, in ruins, outside the precincts of the modern city. Among these is the summer palace of the emperor Kienlung. It consisted of a number of one-story buildings, with spacious courts between, and flanked by smaller buildings on the sides. Enough still remains to shew that the workmanship was of the most elaborate and unique character. When under cultivation, the spot must have been exceedingly beautiful. A road of hewn stone, varying from 4 to 6 feet in width, leads to the capital, a distance of about 20 miles. The tombs of the kings are remarkable for their sepulchral statues, which form an avenue leading up to the graves; they consist of gigantic figures, like warriors cased in a kind of armour, standing on either side of the road, across which, at intervals, large stone tablets are extended, supported by huge blocks of stone instead of pillars. Situated at some distance from these statues, are a number of rude colossal figures of horses, elephants, and other animals, placed without any distinct arrangement, whose purpose may have been originally to ornament particular tombs. Among the ruins must be included the far-famed Porcelain Tower. It was erected by the emperor Yungloh, to reward the kindness of his mother; the work was commenced in the 10th year of his reign (1413), at noon, on the 15th day of the moon, in the sixth month of the year, and was completed in nineteen years. The board of works was ordered, according to the plan of the emperor, to build a tower nine stories high, the bricks and tiles to be glazed, and of 'fine colours'; and it was to be superior to all others, in order to make widely known the virtues of his mother. Its height was to be 322 feet. The ball on its spire to be of brass, overlaid with gold, so that it might last for ever and never grow dim. From its eight hooks as many iron chains extend to the eight corners of its highest roof; and from each chain nine bells, suspended at equal distances apart; these, together with eight from the corners of each projecting roof, amounted to 144 bells. On the outer face of each story are 16 lanterns, 128 in all; which, with 12 in the inside, make 140. It requires 64 cattles of oil to fill them; their light illumines the 'thirty-three heavens, shining into the hearts of all men, good and bad, eternally removing human misery.' On the top of the highest roof are two brazen vessels, weighing together 1200 pounds, and a brazen bowl besides, weighing 600 pounds. Encircling the spire are nine iron rings, the largest being 63 feet in circumference, and the

smallest 24 feet, altogether weighing nearly 5000 pounds. In the bowl on the top are deposited one white shining pearl, one fire-averting pearl, one wind-averting pearl, one water-averting pearl, one dust-averting pearl, a lump of gold weighing 50 ounces, a box of tea-leaves, 1000 taels of silver, one lump of orpiment, altogether weighing 4000 pounds; one precious stone-gem, 1000 strings of copper coin, two pieces of yellow satin, and four copies of Buddhist classics. The brilliancy of the edifice, — the cost of which was 2,485,484 taels, a tael being about 6s. 8d. — will endure, according to the Chinese annalist, to hundreds of generations, a monument of recompensing kindness to myriads of years. Therefore it is named Pau-gan-sz, i. e., Recompensing Favour Pagoda. In the spring of 1853, N. was taken by the Taiping rebels, who put the entire Manchu population to the sword. Since that period, N. has been the capital of Tien Wang; and the city is styled by the Taipings, Tien-king, the Celestial Capital, the greater part of which they have wholly laid in ruins, including the beautiful Porcelain Tower, that magnificent monument of the gratitude of a son for his mother's love. — Dr Macgowan, *North China Herald*.

NANTES (anc. *Nannetes*, or *Nannetes*), an important seaport town of France, capital of the department of Loire-Inférieure, is situated on the right bank of the Loire, 30 miles from its mouth, and at the point of confluence with it of the Erdre and the Sèvre-Nantaise, both navigable streams. Besides railways, there is communication with the interior by steamers on the Loire. The natural beauties of the site have been much improved by art, and now, the noble river on which the town is placed, covered with craft of every size and description, the islands that stud its channel, the meadows that skirt its banks, and the bridges (upwards of 16 in number) that cross it and its tributaries here, combine to make the scene a highly picturesque one. N. contains numerous squares and churches. Several districts of the town, especially in the more modern quarter, are nearly equal to the finest districts of Paris in regularity and elegance. This town possesses numerous striking and beautiful buildings; among which the Cathedral of St Pierre, containing the splendid monument of Francis II., the last Duke of Bretagne, and of Marguerite his wife; and the old castle, the temporary residence of most of the kings of France since Charles VIII., and built in 938, are the chief. There is a public library containing 45,000 vols.; a museum of paintings; and a museum of natural history. The quays, lined on one side with houses, and in some cases planted with trees, afford an agreeable and interesting promenade of about two miles in length. The most beautiful promenade, however, formed by the Cours St Pierre and the Cours St André, extends from the Erdre to the Loire. It is planted with four rows of trees, bordered with lines of palatial houses, and ornamented with statues. The harbour, 1968 yards in length, is capable of accommodating upwards of 200 vessels. Formerly, vessels of no more than 200 tons could reach the port, all vessels of greater burden unloading at Faimbeuf, at the mouth of the river; but within recent years, much has been done by dredging for the improvement of the river-bed, and large vessels can now reach the harbour. The chief manufactures of N. are varieties of linen and cotton fabrics, calicoes, flannels; musical, mathematical, and optical instruments; refined sugar and salt, chemical products, cordage, &c. It contains tanyards, copper foundries, brandy distilleries, &c., and numerous establishments engaged in the various manufactures to which a port gives rise, as

ship-building, the preparation of preserved meats, &c. In 1860, 2534 vessels, of 348,747 tons, entered and cleared the port. Trade with the West Indies is actively carried on here. Pop. (1862) 113,625.

NANTES, EDICT OF, the name given to the famous decree published in that city by Henri IV. of France, 13th April 1598, which secured to the Protestant portion of his subjects freedom of religion. Among its more important provisions were—liberty to celebrate worship wherever Protestant communities already existed; to establish new churches, except in Paris and the surrounding district, and in the royal residences; and to maintain universities, or theological colleges, of which they had four, those at Montauban, Saumur, Montpellier, and Sedan; adherents of the Reformed faith were also to be eligible to all civil offices and dignities; but, on the other hand, they were not allowed to print books on the tenets of their religion, except in those places where it existed; and they were obliged to outwardly celebrate the festivals of the Catholic Church, and to pay tithes to the Catholic priesthood. From this period, the Reformers or Huguenots (who then counted 760 churches) had a legal existence in France, but gradually their political strength was crushed by the mighty genius of Richelieu—who, however, never dreamed of interfering with their liberty of worship. Neither did his successors, Mazarin and Colbert; but under the influence of a 'penitence,' as corrupt and sensual as the sins which occasioned it, Louis XIV., after a series of detestable *Dragonades* (q. v.), signed a decree for the revocation of the edict, 18th October 1685.—The result of this despotic act was that, rather than conform to the established religion, 400,000 Protestants—among the most industrious, the most intelligent, and the most religious of the nation—quitted France, and took refuge in Great Britain, Holland, Prussia, Switzerland, and America. The loss to France was immense; the gain to other countries, no less. Composed largely of merchants, manufacturers, and skilled artisans, they carried with them their knowledge, taste, and aptitude for business. From them England, in particular, learned the art of manufacturing silk, crystal glasses, and the more delicate kinds of jewellery.

NANTUCKET, an island and town upon it, on the south-east coast of Massachusetts. The island is 15 miles long and an average of 4 wide, with an area of 50 square miles. It was bought from the Indians by Thomas Macy, in 1659, for £30 and two beaver-hats. Since that time its inhabitants have been engaged in the whale fisheries. The town has a deep and secure harbour, a large amount of shipping in the fisheries, 7 factories of sperm oil, candles, &c., 9 churches, 2 newspapers, population of about 6000.

NANTWICH, a small market town of Cheshire, England, on the Weaver, 20 miles south-east of Chester. Many of its houses are interesting from their age and construction, being built in many cases of timber and plaster, and with overhanging upper stories. The parish church, one of the finest country churches in England, has recently been restored at great cost. It was famous in former times for its brine-springs and salt-works. Shoes, gloves, and cotton goods are manufactured, and malting is carried on. Pop. (1861) 6225.

NANOS (Gr. a dwelling), the cell or enclosed chamber of a Greek temple.

NAPHTHA is derived from the Persian word *nafata*, to exude, and was originally applied to an inflammable liquid hydrocarbon (or rather a

mixture of several hydrocarbons) which exudes from the soil in certain parts of Persia. (According to Pelletier and Walter, it consists of three hydrocarbons—viz, $C_{11}H_{19}$, which boils at 190° ; $C_{12}H_{22}$, which boils at 230° ; and $C_{16}H_{34}$, which boils at 374° .) The term is, however, now used not only to designate a similar and almost identical fluid, that issues from the ground in many parts of the world, and is known as petroleum, rock-oil, &c., but is also applied to other liquids which resemble true naphtha in little else than in their volatility and inflammability. Thus, wood-spirit or methylic alcohol, is often spoken of as *wood-naphtha*, and acetone is sometimes described as naphtha. Coal-tar yields by distillation a liquid which presents all the physical, and most of the chemical characters of naphtha, and which is usually distinguished as coal-naphtha. See GAS-TAR.

Crude Naphtha, whether occurring as a natural product, or as obtained from coal-tar, is purified by agitation with strong sulphuric acid; after which it must be well washed with water (in which it is quite insoluble), and finally distilled from quicklime. Pure naphtha is colourless, and of a peculiar taste and odour; it is soluble in about eight times its bulk of alcohol, and dissolves in all proportions in ether and in the essential oils. Hot naphtha dissolves phosphorus and sulphur, but deposits them on cooling. It is an excellent solvent for gutta-percha, caoutchouc, camphor, and fatty and resinous bodies generally; and hence it is extensively used in the arts for these purposes, and its employment as a source of artificial light is now becoming universal. In consequence of its containing no oxygen, it is employed by chemists for the preservation of potassium and other metals, which have a powerful affinity for oxygen. Owing to its volatility and inflammability, it must be handled with great caution, many fatal cases having arisen from its vapour catching fire on the approach of a candle.

The principal kinds of naphtha known in commerce are native naphtha, coal naphtha, Boghead naphtha (also called paraffin oil and photogen), shale naphtha, and naphtha from caoutchouc or caoutchins.

Native naphtha, petroleum, or rock-oil, is found in many parts of the world, as in Japan, Burmah, Persia, the shores of the Caspian Sea, Siberia, Italy, France, and North America. It is of various degrees of consistency, from a thin, light, colourless fluid found in Persia, with a specific gravity of about 0.750, to a substance as thick as butter, and nearly as heavy as water. But all the kinds when rectified have nearly the same constitution. They contain no oxygen, and consist of carbon and hydrogen compounds only. Bitumen and asphaltum are closely allied substances in a solid or semi-solid form. From a very early period in Persia and Japan, and at least since last century in Italy, native naphtha has been used to burn in lamps.

Coal naphtha is distilled from Gas-tar (q. v.), and both it and native naphtha, when purified, possess similar properties. Coal naphtha is, however, of a higher specific gravity, viz, from 0.860 to 0.900, and has a more disagreeable and penetrating odour.

Boghead naphtha, or paraffin oil, has become, of late years, so important a manufacture that a brief history of its origin cannot be uninteresting. In the year 1847, Mr James Young, now of the Bathgate Chemical Works, had his attention called to a petroleum spring at Alfreton, in Derbyshire, from which he distilled a light thin oil for burning in lamps, obtaining at the same time a thicker oil, which was used for lubricating machinery. After a year or two the supply began to fail, but Mr Young, noticing that petroleum was dropping

from the sandstone roof of a coal-mine, conjectured that it originated by the action of heat on the coal-seam, the vapour from which had condensed in the sandstone, and supposed from this that it might be produced artificially. Following up this idea, he tried a great many experiments, and ultimately succeeded, by distilling coal at a low red heat, in obtaining a substance resembling petroleum, which, when treated in the same way as the natural petroleum, yielded similar products. The obtaining of these oils and the solid substance paraffin from coal formed the subject of his now celebrated patent, dated October 17, 1850.

It is at present (March 1864) a matter of dispute in the courts of law how far Mr Young's process is a new invention. Many years ago, Reichenbach had, by distilling 100 lbs. of pit-coal, obtained nearly two ounces of an oily liquid exactly resembling natural naphtha; and various other chemical writers are appealed to as proving that methods, substantially the same as Mr Young's, were known and practised. One thing seems to be admitted, that previous to Mr Young's patent, no one, in this country at least, had succeeded in producing the oil on a commercial scale.

The processes by which the oil and paraffin are obtained are simple. The material best adapted for the purpose is the well-known Boghead coal, which is a very rich gas coal, occurring in a field of limited extent near Bathgate, in Linlithgowshire. But all cannel or gas coals give the same products, and some of them in nearly as large quantity. The coal is broken into fragments like road metal, and gradually heated to redness in cast-iron retorts, which are similar to those used for coal-gas (see GAS), except that they are generally placed in an upright instead of a horizontal position. The retorts are usually about 10 feet long and 14 inches in diameter at the bottom, tapering to 12 inches at the top, and built in sets of four, so that one fire may heat each set. The coal is fed by means of a hopper on the top of the retort, and after passing through it at a low red heat, is drawn out as coke at the bottom, where there is a water lute to prevent the escape of oil or gas. There is a spherical valve in the hopper, counterpoised with a weight, which closes the retort at the top. The volatile matters distilled from the coal are conducted by a pipe to the condensers (which are similar to those used for coal-gas), where they are condensed into a thick black oil, of a specific gravity of about 0.900, along with a little water. Steam is sometimes passed through the retorts to facilitate the passage of the oil into the condensing-pipes as quickly as possible. Great care is necessary to prevent the heat from becoming too high, because gas and gas-tar and not paraffin oil are obtained when coal is distilled at a high temperature. A ton of Boghead coal yields practically about 120 gallons of crude oil, although with great care as much as 140 or 150 might be obtained.

The crude oil from the first distillation is then distilled again, either in cast-iron or malleable iron stills. The former are frequently long wide cylinders, and the latter are usually very strong steam boilers. From this second distillation a 'green oil' is obtained, and the residue is removed as coke from the bottom of the still. This oil is then mixed with from 5 to 10 per cent. of sulphuric acid, and afterwards with about the same quantity of soda, the mixtures being made in circular tanks with revolving stirrers. Both the acid and the soda mix with impurities which fall to the bottom as heavy tarry matters, and are run off by a stop-cock, till only the clear supernatant oil remains. After being so far purified, the oil is distilled once

more in an iron still. From this final distillation, a small quantity of light naphtha is first obtained, which is used for dissolving caoutchouc, three-fourths of what is left being a light and nearly colourless oil used for burning in lamps, and the remainder a thicker oil containing paraffin. This latter portion is pressed in a hydraulic press, which squeezes out the greater portion of the paraffin, leaving an oil which, either alone or when mixed with about a fourth part of rape oil, is sold for lubricating machinery.

The crude paraffin, after being subjected to hydraulic pressure three or four times, is treated with sulphuric acid and naphtha to remove impurities and colouring matter. It is finally boiled on the top of water to remove smell, and is then an exquisitely beautiful substance resembling the purest white wax. It is largely manufactured into candles, which equal, or even excel in appearance those made from wax, and are only about half as costly.

Shale naphtha, or 'shale oil,' is a substance which has been manufactured, for several years, from bituminous shales both in this country and on the continent. When the shale contains nitrogen and sulphur, from the presence of organic remains, such as that obtained in Dorsetshire, the naphtha has a fetid smell, which it is difficult to get rid of. When it is removed, however, by repeated purifications, the naphtha resembles the Boghead oil. Within the last two or three years, a burning oil of the same kind as the Boghead has been manufactured pretty extensively in Scotland and Wales from the bituminous shales of the coal-measures, which had previously been turned to no account.

Naphtha from caoutchouc or caoutchine is obtained from caoutchouc by destructive distillation. It is a fluid hydrocarbon, whose true composition seems not yet to have been made out. Caoutchine has the reputation of being one of the best solvents known for India-rubber.

Of the native naphthas we have already named, the Burmese (Rangoon) petroleum or rock oil is one of the best known. It is obtained by sinking wells about sixty feet deep in the soil, from which the crude substance oozes out, and is removed when a sufficient quantity has accumulated. It is about the consistence of goose-grease, and consists of several fluid hydrocarbons, with about ten or eleven per cent. of the solid hydrocarbon paraffin. The lightest naphtha obtained from this substance, known in commerce under the name of 'Sherwoodole,' has a very pleasant odour, and is in consequence much used for removing greasy stains from silks and other fabrics. The heavier naphthas it contains are also highly prized, both as burning and lubricating oils, on account of their agreeable smell. About 400,000 hogsheads of crude naphtha are annually obtained at Rangoon. The naphtha which is found abundantly at Baku, on the shores of the Caspian Sea, closely resembles the Rangoon in its qualities. There are volcanoes here and on several islands in the Caspian which are said to terminate their eruptions with outpourings of naphtha. The Persian naphtha is frequently pure enough for burning without rectification.

On account of its cheapness and abundance, the burning oil obtained from the North American petroleum springs has now become by far the most important of the native naphthas. The quantity of this oil which is at present imported into Great Britain is quite extraordinary, considering that the trade was only begun in 1859. The principal supplies are procured from Pennsylvania, Virginia, and Ohio. A considerable quantity has also been obtained at Enniskillen, in Canada.

Much curiosity exists respecting the origin of these great natural sources of petroleum, but no satisfactory explanation has yet been given. The theory that it has been distilled from the coal beds by subterranean heat is disputed by some geologists, on the ground that most of the wells are sunk in the Devonian rocks, below the coal-measures, though some of them are in the latter. Both in the States and in Canada, the oil varies from a thin and light-coloured to a very thick and dark-coloured kind. It is purified by similar processes to those described for the Boghead oil, and yields the same products—viz., a burning oil, a lubricating oil, and paraffin. The thick kinds contain the most paraffin. The following are the exports of petroleum from New York for the last three years: 1861, 1,102,239 gallons; 1862, 6,846,392 gallons; 1863, 19,674,897 gallons. The exports from New York appear to be rather more than all the other American ports put together.

The rapid increase in the importations of petroleum oil, and some accidents which occurred with it, led to the passing of an act of parliament in 1862, making it unlawful to keep more than 40 gallons of petroleum within 50 yards of a dwelling-house, or of a building in which goods are stored, without a licence from some local authority. In this act, any product of petroleum is included, which gives off an inflammable vapour at a temperature of less than 100° F. The alarm taken by the insurance offices at the increasing trade in this oil, also led to the construction of special warehouses for its reception at the Victoria Docks, London, and at the Liverpool docks. Special ships are, likewise, being introduced for this trade.

Terrible accidents have now and then happened with some of the more inflammable American oils, by reason of their vapours exploding in the reservoirs of lamps. Most of these have, no doubt, taken place with oils whose vapours form an explosive mixture with air at a temperature below 100° F., but they can hardly be considered safe if their vapours will take fire on the approach of a light at less than 120° F. The vapour of the burning oil from Boghead coal will not form an explosive mixture below 140° F., and is therefore quite safe. Even the most dangerous of the American oils can easily be rendered safe by removing the lighter naphthas which they contain. Coal-tar naphtha is more inflammable than any of them, but its dangerous properties are better known, and guarded against.

A commission appointed by the Navy Department of the Northern States of America, have recently, after several months of experimenting, recommended the use of petroleum to burn for the generation of steam, on the grounds that it is more economical than coal, and that, weight for weight, it will maintain steam three times as long.

NAPHTHALIC GROUP OR SERIES. The starting-point of the group is *Naphthalin* (C₁₀H₈), a substance of great interest in the history of organic chemistry, from its being that upon which Laurent chiefly founded his Theory of Substitutions. It may be obtained in various ways, but is most easily and abundantly produced from the last portions of the distillate of coal-tar, which become semi-solid on cooling. The liquid part of this mass is got rid of by pressure, and the naphthalin is then taken up by hot alcohol, from which it is obtained in a pure state by crystallisation and sublimation.

Naphthalin crystallises in large, thin, rhombic plates, which are unctuous to the touch, and have a pearly lustre. Exposed to light under a glass covering, it gradually sublimes at an ordinary temperature in splendid crystals. It has a somewhat tar-like odour, and a pungent and somewhat

aromatic taste. It fuses at 174°, and boils at 423°. Its specific gravity, in the solid state, is 1.15, and as a vapour, 4.528. It is not very inflammable, and when ignited, burns with a white smoky flame. It is insoluble in water, but dissolves readily in alcohol, ether, and the fixed and essential oils.

By acting on naphthalin with an excess of sulphuric acid, we obtain *sulpho-naphthalic acid* (C₁₀H₆S₂O₆ + 2Aq), from which, by substitution processes, a large number of compounds are produced. With nitric acid, naphthalin yields nitro-naphthalin [C₁₀H₇(NO₂)], binitro-naphthalin [C₁₀H₆(NO₂)₂], and trinitro-naphthalin [C₁₀H₅(NO₂)₃], the group (NO₂), or its multiples, being substituted for one, two, and three equivalents of the hydrogen of the naphthalin. The final product of the prolonged action, of boiling nitric acid on naphthalin is a mixture of oxalic and *naphthalic* or *phthalic acid*; the re-action being shewn by the equation:

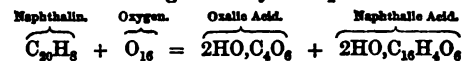

This acid is also obtained by the continued action of nitric acid upon alizarin, which is an important fact, since it indicates a connection between naphthalin and the colouring matter of madder.

Laurent has discovered a very numerous series of substitution compounds formed upon the type of naphthalin, into the composition of which chlorine enters. They are of little practical importance although their investigation has exerted a remarkable influence upon the progress of organic chemistry.

NAPIER, JOHN, Laird of Merchiston, was born at Merchiston Castle, near Edinburgh, in 1550, and died there on the 4th of April 1617. After attending the regular course in Arts at the university of St Andrews, he travelled for some time on the continent, and returned to his native country highly informed and cultivated for the age. Declining all civil employments, for which his many accomplishments eminently fitted him, he preferred the seclusion of a life devoted to literary and scientific study. From this time his history is a blank till 1593, when he published his *Plaine Discovery* (or 'Interpretation') of the whole *Revelation of Saint John* (Edin. 5th ed. 4to, 1645), a work displaying great acuteness and ingenuity, but, it is scarcely necessary to add, not in any sense a 'plaine discovery' of the apocalypse. In the dedication to King James VI., he gave his majesty some very plain advice regarding the propriety of reforming his 'house, family, and court;' and on republishing the work, he added a supplement, resolving 'certaine doubts mooved by some well-affected brethren.' About this time he seems to have devoted much of his time to the invention of warlike machines, but these inventions were never perfected, probably from motives of humanity. Like other eminent men of the time, N., though a strict Presbyterian, seems to have been a believer in astrology and divination, but there is no satisfactory proof that he ever practised these arts. In 1596, he proposed the use of salt as a fertiliser of land, an idea which, though scouted at the time, is now generally received. Another large blank in his history here occurs, and terminates in 1614, at which date he first gave to the world his famous invention of Logarithms (q. v.), in a treatise entitled *Mirifici Logarithmorum Canonis Descriptio* (4to, Edin.). This was followed by another work, *Rabdologia, seu numerationis per Virgulas libri duo* (Edin. 1617), detailing an invention for simplifying and shortening the processes of multiplication and division. See **NAPIER'S BONES. He also prepared a second work on Logarithms, shewing their mode of construction**

NAPIER.

and application, with an appendix containing several propositions of spherical trigonometry, and those formulæ which are now known by his name. This work was published after his death by his son Robert, under the title of *Mirifici Logarithmorum Canonis Constructio, &c., quibus accessere Propositiones ad Triangula spherica faciliore calculo resolvenda, &c.* (Edin. 1619), and occurs along with the *Canonis Descriptio*. The latter work is included in Baron Masere's extensive collection, the *Scriptores Logarithmici* (Lond. 1808). N.'s eldest son, Archibald, was raised to the peerage as the first Lord Napier by Charles I. in 1627, and his descendants still bear the title. Two lives of N. have been published, the one by the Earl of Buchan (1787), and the other by Mr Mark Napier (1834).

NAPIER, SIR CHARLES JAMES, G.C.B., English general, one of several brothers distinguished for their bravery, three of whom—Charles, William, and George—were known in the Peninsular War as 'Wellington's Colonels.' They were sons, by a second marriage, of Hon. Colonel George Napier, grandson of Francis, fifth Lord Napier, who was fifth in descent, but through two females in succession, from the inventor of Logarithms. Charles, the eldest, was born at Whitehall, Westminster, August 10, 1782. Before he had finished his twelfth year, young N. received a commission in the 22d Foot. His first service was in Ireland, where he assisted in putting down the rebellion. He commanded the 50th Foot during the retreat on Corunna; and at the fatal battle in which Sir J. Moore fell, he was wounded in five places and made prisoner. Marshal Ney dismissed him, with permission to go to England on parole. On his return, he engaged in literary works, and even wrote an historical romance. In 1811, he returned to the Peninsula. At Coa, where he fought as a volunteer, he had two horses shot under him. At Busaco, he was shot in the face, having his jaw broken and his eye injured. He recovered in time to be present at the battle of Fuentes d'Onoro and the second siege of Badajoz. After distinguishing himself in innumerable skirmishes, the daring soldier returned to England. He next took part in a fighting cruise off the Chesapeake, capturing American vessels, and making frequent descents upon the coasts. He did not return to Europe soon enough for Waterloo, but was engaged in the storming of Cambrai, and accompanied the army to Paris. After the peace he was, in 1818, made governor of the island of Cephalonia, the affairs of which he administered with great energy and intelligence. Being, however, of an excessively combative disposition, he became embroiled with the authorities at home. In 1841, he was ordered to India to assume the command of the army at Bombay. This was the most splendid period of his career, resulting in the conquest of Scinde against terrible odds. His destruction of a fortification called Emaun Ghur in 1843, was described by the Duke of Wellington as one of the most remarkable military feats he had ever heard of. The fearful battle of Meanee followed, where N., with 1600 English and sepoy, defeated near 30,000 Beloochees, strongly posted, with the loss of 6000 men. The Ameers surrendered, except Shere Mahomed, who brought 25,000 men into line of battle at Hyderabad. N. had only 5000 men, but in three hours his little army gained a decisive victory. A few days afterwards, N. was in the palace of the Ameers, and master of Scinde. He was fortunate in possessing the entire confidence of Lord Ellenborough, who made him governor of Scinde. His civil administration was scarcely less remarkable or less successful than his military operations. He

gained the respect and reverence of the inhabitants, but soon became engaged in an acrimonious war of despatches with the directors. In 1847, he returned to England. After attending a series of festivals in his honour, he lived in retirement until the disasters of the last Sikh war caused the eyes of his countrymen to be turned to the hero of Scinde as the deliverer of our Indian empire. He went to India, but found on his arrival that the Sikhs had been routed. He now turned his attention, as commander-in-chief of the army in India, to the subject of military reform. He bade a final adieu to the East in 1851, and returned to his native country, where he resided until his death, which took place at his seat, at Oaklands, near Portsmouth, August 29, 1853. He had then attained the rank of lieutenant-general, was G.C.B., and colonel of the 22d Foot. It must be remembered to his honour that he was the first English general who ever recorded in his despatches the names of private soldiers who had distinguished themselves, side by side with those of officers. Brave to rashness, ready alike with tongue, pen, and sword, quarrelsome with his superiors, but beloved by his soldiers, and, to crown all, of a strangely wild yet noble and striking appearance, N. was one of the most remarkable men of his time, and in losing him the country lost one of its brightest military ornaments. His statue has recently been erected in Trafalgar Square. The story of his *Conquest of Scinde* has been written by his brother, Lieutenant-General **SIR WILLIAM FRANCIS PATRICK NAPIER, K.C.B.**, born 17th December 1785, who served in the Peninsular campaign, and was engaged from 1824 to 1840 in preparing his *History of the Peninsular War*, the greatest military history in the English language. He died February 12, 1860, at Scinde House, Clapham, and was followed in a few weeks to the tomb by his wife, Lady Napier, niece of the great C. J. Fox. Her extraordinary skill in translating French documents written in cypher, and her indefatigable labours as her husband's amanuensis, are touchingly commemorated in the preface to the edition of the *History of the Peninsular War*, published in 1851.

NAPIER, SIR CHARLES, K.C.B., English admiral, was cousin to the hero of Scinde and the historian of the Peninsular War. His father was the Hon. Captain Charles Napier, R.N., second son of Francis, fifth Lord Napier. He was born March 6, 1786, at the family seat, Merchistoun Hall, in the county of Stirling. At 13, he went to sea as a naval volunteer. In 1808, he received the command of the *Recruit*, 18 guns, and had his thigh broken by a bullet while engaging within pistol-shot the *Diligente*, a French corvette of 22 guns. At the reduction of Martinique he took a principal part, accompanied by only five men. He kept up a running fight, in his 18-gun brig, with the rearmost of three French line-of-battle-ships, the *D'Hautpoull*, which escaped from Guadeloupe, and was thus instrumental in her capture. This obtained him a post-captaincy; but being thrown out of active service, he served ashore as a volunteer in the Peninsular army 'by way of amusement,' as he expressed it. 'Black Charley,' as he was called, was present at Busaco with his cousins, and received a wound in the battle. In 1811, he obtained the command of the *Thames*, 32 guns. He inflicted an incredible amount of damage upon the enemy in the Mediterranean, and put a stop to their attempts to construct a fleet. He also conducted several desperate land operations with such marked success, that a high authority has declared that his genius was essentially military. In 1814, he was ordered to America, and led the way in the hazardous

NAPIER'S BONES—NAPLES.

ascent and descent of the Potomac. He afterwards took an active part in the operations against Baltimore. After the war, he settled in Paris, where he established the first steamers on the Seine. In 1829, he received the command of the *Galatea*, a 42-gun frigate, and was employed 'on particular service' on the coast of Portugal and in the Azores. He thus became acquainted with the leaders of the Constitutional party, and accepted the command of the fleet of the young queen. He sailed in search of the Miguelite fleet, and, although vastly over-matched, did not hesitate to engage it. He ran his 32-gun frigate, the *Rainha*, alongside of the *Don John*, of 80 guns, and carried her by boarding. This action concluded the war, and placed Donna Maria on the throne. He was made admiral-in-chief of the Portuguese navy, and attempted to remodel it; but official and corrupt influence was too strong for him, and he returned to England. He was appointed to the *Powerful*, 84 guns, and when the war between the Porte and Mehemet Ali broke out, he was despatched to Beyrout. He organised a land force, with which he stormed Sidon, and defeated Ibrahim Pasha among the heights of Mount Lebanon. He took part in the naval attack on Acre, and did not hesitate to disregard the orders of his chief, Admiral Stopford, when he saw the way to bring the battle to a speedy termination. He next blockaded Alexandria, and concluded a convention with Mehemet Ali, which, although at first repudiated, was eventually adopted by the allied powers. In 1841, he was elected M.P. for Marylebone. In 1847, he received the command of the Channel fleet. When the Russian War broke out, he was sent out to command the Baltic fleet. The capture of Bomarsund failed to realise the high expectations formed of N.'s exploits. In 1855, he was returned to parliament as M.P. for Southwark, and, until his death, November 6, 1860, he laboured with success to reform our naval administration, and improve the condition of our seamen. He died at Merchiston Hall, Horndean, Hants, and was at the time of his death a vice-admiral and a knight of several foreign orders.

NAPIER'S BONES, an invention of the celebrated Napier (q. v.) of Merchiston, for the purpose of performing mechanically the operations of multiplication and division. The 'bones' were narrow

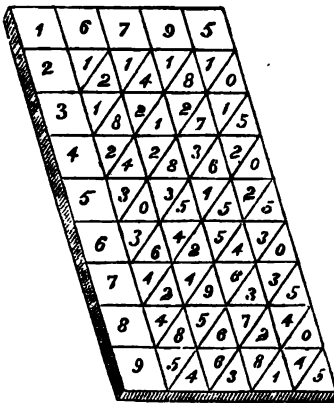

Napier's Bones.

slips of bone, wood, ivory, or metal, about 3 inches long by 3-10ths of an inch in breadth, and divided by transverse lines into nine compartments; each of these compartments being divided into two portions

by a diagonal line running from the upper right hand to the lower left hand corners. The 'bones' were divided into sets, all those of one set having the same digit occupying the top compartment, and the several multiples of that digit occupying in order the eight lower compartments; when the multiple consisted of two figures, these were placed one on each side of the diagonal line. There was necessarily a set of bones for each digit. There was also another rod similarly divided into compartments, in which were placed the nine digits; this was called the *index-rod*. Multiplication was performed as follows; e.g., if 6795 is to be multiplied by 97834, four rods (see fig.) whose top digits were 6, 7, 9, 5 are selected, and arranged in the order of the figures in the multiplicand, and the index-rod placed alongside them, as in the figure; the several figures of the multiplier are then sought for on the index-rod, the two lines of figures opposite each figure on the index are then added together diagonally, and the five sums thus obtained are arranged as follows:

9	61155
7	47565
8	54360
3	20385
4	27180

664782030 = the product required.

Division is performed in an analogous manner. The contemporaneous invention of logarithms for the same purpose of converting multiplication and division into addition and subtraction, caused Napier's bones to be overlooked, and they are now scarcely ever used.

NAPLES (Ital. *Napoli*, anc. *Neapolis*), a city of Southern Italy, capital of the province of Naples, is built partly at the base, partly on the slopes of two crescent-shaped acclivities on the famous bay of the same name. Pop. (1862) 447,065. Lat. 40° 51' 8" N., long. 14° 15' 5" E. The wonderful beauty of the site and of the surrounding prospect, the delicious softness of the climate, and the clear atmosphere, make N. famed among the cities of the world. It is one of the chief centres of commerce and industry of Italy, possesses a very extensive mercantile shipping, and is one of the principal stations of Mediterranean steam-navigation.

The public buildings of Naples are numerous and grand, but are devoid of architectural symmetry in consequence of the antiquity of their origin and the irregularity of their site. Many of the old streets are paved with lava, and inconveniently narrow; the houses in these quarters are of great height, and appear to overhang the narrow tortuous causeways beneath. The modern streets, however, are spacious and splendid. The city is divided into the Old and the New Town, or the East and West Crescents, by a lesser range of heights—viz., the Capodemonte, the St Elmo, and the Pizzofalcone, terminating in the rocky promontory called the Castel dell' Ovo. The eastern division of N. is the most ancient and the most densely peopled; it contains the principal public structures, and is intersected by the splendid Via or Street di Toledo. The western, or modern section, contains the famous Riviera di Chiaja, or the Quay, a fine road running along the bay in a curved course of three miles, flanked on the right by a row of palaces, and bordered on the left by the beautiful pleasure-grounds of the Villa Reale, which lie between it and the sea, and of which the natural beauty is heightened by the interspersions of temples, fountains, and statuary groups amidst the acacia, myrtle, and orange groves. The public squares, or *larghi*, of N. are adorned with fountains and obelisks; and within the precincts of the city,

NAPLES.

there are several highly-prized springs both of fresh and mineral waters. The fortified castles are numerous. Amongst the principal are the Castel Nuovo, called the Bastile of Naples, somewhat similar to the Tower of London, and adorned with a fine triumphal arch, erected in honour of Alfonso of Aragon; the Castel dell'Ovo, so called from its oval or egg shape, standing on a promontory, and connected by a bridge with the mainland; the Castel Capuano, of Norman origin; the Castel Sant' Elmo, on the hill of the same name, commanding a magnificent view from its ramparts, and formerly reputed for its immense strength; and the dismantled Castel del Carmine. The churches are upwards of 300, and many of them are rich in architectural and archaeological interest. The cathedral dedicated to St Gennaro (Januarius; q. v.) contains the celebrated phials in which the liquefaction of St Gennaro's blood is alleged to take place on two annual festivals; it also contains the tombs of Charles of Anjou and of Pope Innocent IV., besides numerous fine paintings and statues. The educational institutions of N. embrace famous schools of surgery, law, and general science. The philanthropical establishments are on an immense scale, and are richly endowed. There are also several theatres in the city, of which that of *San Carlo* (devoted to the Opera) is one of the largest and most celebrated in Italy; but the characteristic theatre of N. is the *Teatro di San Carlo*, the head-quarters of *Pulcinella* ('the Italian Punch.') There are four grand public libraries; and in the Museo Borbonico, N. contains an unrivalled collection of art, comprising frescoes, paintings, mosaics, sculptures, bronzes, antiquities, coins, medals, inscriptions, and the renowned collection of precious objects excavated from Herculaneum and Pompeii.

The environs of N., apart from their extreme beauty of scenery, are highly interesting. The locality which contains the tomb of Virgil, the disinterred towns of Herculaneum and Pompeii, the physical phenomena of Vesuvius, and the Roman remains of temples, villas, palaces, and tombs, must possess an inexhaustible source of interest for scientific, antiquarian, and classical investigators. The modern villas of N. are splendid and luxurious. One of the most striking features of N. is its unique population and the universal publicity in which life is passed. The inhabitants for ever swarm in the thoroughfares, where an incessant throng of vendors, purchasers, and idlers intermingling with asses, mules, hand-carts, and conveyances, dazzling the eye with their brilliant variety of costume, and the pantomimic expressiveness of their frantic gestures and attitudes; while the ear is stunned by the shrill conflicting cries of the ambulatory vendors of every conceivable commodity, by the piercing notes of the improvisator's song, and the uproarious hilarity and high-pitched patois of the countless masses, whose sole abode appears to strangers to be the thronged public squares and streets. The popular language of N., which is a corrupt dialect of Italian and Spanish, is in prevalent use among all classes of society; it lends itself especially to the satirical and facetious squibs and compositions in which the Neapolitans excel. The popular Neapolitan songs in the native patois are exquisitely naive and expressive in sentiment, and are set to popular melodies which exert a maddening charm over this southern populace. The physical condition of the lower classes of N., and especially of the *lazzaroni* (q. v.), has of late years sensibly improved both as regards raiment and lodging.

The name Naples (Gr. *Neapolis*, new city) had reference to an older town in the neighbourhood,

called originally Parthenope, and, after the foundation of the new town, Paleopolis (old town), which was situated most probably on the ridge called Posilipo, that separates the Bay of Pozzuoli or Baia from that of Naples. Both towns were Greek settlements, apparently colonies from the neighbouring Cuma, joined by immigrants direct from Greece. In 327 B.C., Paleopolis was besieged and taken by the Romans, and thenceforth disappears from history; Neapolis submitted without resistance, and became a favoured and faithful ally, or rather provincial city of Rome. It long, however, retained its purely Greek character and institutions; and there is evidence that the Greek language continued to be used, even in public documents, as late as the 2d c. of the Christian era. N. was a flourishing and populous city during the Roman empire; and, notwithstanding the vicissitudes of the Gothic conquest of Italy, and the reconquests by the Byzantine emperors, it continued to be one of the most important and opulent places in Italy. About the 8th c., it threw off allegiance to the Byzantine emperors, remained independent till it fell into the hands of the Normans in 1140 A.D., and became the capital of the kingdom of Naples.

NAPLES, BAY OF, an indentation of the Mediterranean Sea on the south-west coast of Italy, opposite the city of Naples, is 20 miles wide from Cape Miseno on the north-west to Cape Campanella on the south-east, and from this line extends inland for about ten miles. The scenery is very beautiful. On the shores are many towns and villages; the prospect is bounded on the east by Mount Vesuvius, and on the outskirts of the bay are the islands of Ischia and Capri.

NAPLES. The Italian provinces (formerly kingdom) of N. and Sicily, or the Two Sicilies, occupy the south end of the Italian peninsula, and consist of the continental territory of N. and the insular dependency of Sicily. The distinctive physical features of N. and Sicily are noted under the names of the different provinces of Italy and in the article SICILY. They are favoured by nature with a salubrious and almost tropical climate, unbounded fertility, and teeming population; and they present natural features of rare attractiveness. The rural population are an acute, frugal, and laborious race, and form a strong contrast to their idle and debased brethren of the towns. For statistics of products, exports, and population, see ITALY and SICILY. N., in ancient times, was divided into numerous petty states independent of each other, and its inhabitants were of various races. Many of these states arose from Greek colonies, which had been founded in the country previous to the 7th c. B.C. The ancient historical importance of N. is attested by the splendour of its cities, and the warlike renown of its population. On its conquest by the Romans, the great Neapolitan cities severally adopted the municipal, federative, or colonist form of government, and gradually assimilated their laws and customs to those of their conquerors. After the downfall of the Western Empire, N. was seized by Odoacer, but soon afterwards (490 A.D.) it was subjected by the Goths, and in the following century by the Lombards, who established in it various independent duchies, as Benevento, Spoleto, Salerno, Capua, &c. Most of these were overthrown by invading bands of Arabs, Saracens, and Byzantines, who were in turn expelled, and the whole country subdued by the Normans in the 11th century. The Normans subsequently erected N. and Sicily into a kingdom, and established a new political, ecclesiastical, and military system. To the Norman

NAPLES—NAPOLEON BONAPARTE

dynasty succeeded that of the Hohenstaufen, whose rule was marked by an immense intellectual and social advancement of the people; but the vindictive enmity with which the papal see regarded this dynasty, led to the invasion of N. by Charles of Anjou, who, notwithstanding the heroic resistance of King Manfred (q. v.), by the battle of Benevento (1266) annihilated the power of the Hohenstaufen. The ascendancy of Charles of Anjou was further effectually secured by the treacherous defeat and decapitation (1268) of Konradin (q. v.), the last male-heir to the throne. By the *Sicilian Vespers* (q. v.) the island of Sicily was, however, wrested in 1282 from his grasp, and became an appanage of the Spanish crown. The predominance of the Neapolitan Guelph or papal party during the glorious reign of Robert I., who was the patron of Dante and Boccaccio, the depraved libertinism of his heiress and granddaughter Joanna, the fearful ravages committed by predatory bands of German mercenaries and by the plague, the futile attempts of the Anjou sovereigns to recover Sicily, and the envenomed feuds of rival claimants to the throne, are the leading features of the history of N. during the rule of this dynasty, which expired with the profligate Joanna II. in 1435; and was followed by that of Aragon, which had ruled Sicily from the time of the Sicilian Vespers. During the tenure of the Aragon race, various unsuccessful attempts were made by the House of Anjou to recover their lost sovereignty; and the country, especially near the coast, was repeatedly ravaged by the Turks (1480). In fact, after the death of Alfonso, the first ruler of the Aragon dynasty, the country groaned under a load of misery. Wars, defensive and offensive, were incessant, the country was impoverished, and a conspiracy of the nobles to remedy the condition of affairs was productive of the most lamentable results, both to the conspirators themselves, and to the other influential Neapolitan families. In 1495, Charles VIII. invaded N., and though he was compelled to withdraw in the same year, his successor, Louis XII., with the treacherous assistance of Ferdinand (the Catholic) of Spain, succeeded in conquering the country in 1501. Two years afterwards, the Spaniards under Gonsalvo di Cordova (q. v.) drove out the French, and the country from this time became a province of Spain. Sicily had previously (1479) been annexed to the same kingdom. During the two centuries of Spanish rule in N., the parliaments which had existed from the time of the Normans fell into desuetude, the exercise of supreme authority devolved on viceroys, and to their ignorance, rapacity, and oppressive administration may be solely ascribed the unexampled misery and abasement of this period. In the words of Sismondi, 'no tax was imposed save with the apparent object of crushing commerce or destroying agriculture, and the viceregal palace and the tribunals of justice became public offices in which the highest dignities and most sacred interests of the state were openly bartered to the wealthiest bidder.' During the Spanish rule, a formidable rebellion took place in 1647, headed first by Masaniello (q. v.), and afterwards by Henry V., Duke of Guise; the whole population of the province renounced their allegiance to their Spanish sovereigns, but the arrival of a new viceroy, who was equal to the occasion, resulted in the capture of the Duke of Guise and the re-subjugation of the country. At length, during the war of the *Spanish Succession* (q. v.), N. was wrested from Spain by Austria in 1707, and Sicily in the following year; but while N. was secured to Austria by the treaties of Utrecht (1713) and Rastadt (1714), Sicily was handed over to Savoy by the former treaty. In 1720, however,

both Sicilies were reunited under the Austrian rule, and in 1735 were given to Don Carlos, third son of Philip V. of Spain, who ascended the throne as Charles I., and founded the Bourbon dynasty. His reign was marked by equity and moderation; great reforms were effected in the administration of public affairs, science and literature were encouraged, and splendid works of public utility were erected throughout the kingdom. It was during his reign that Pompeii and Herculaneum were discovered. His successor, Ferdinand IV., followed in the course of legislative reform; but on the proclamation of the French Republic (1789), his states were invaded by a French army, and the kingdom of N. was erected into the Parthenopean Republic (1799). Ferdinand retired with his court to Sicily, and for a brief period enjoyed the restoration of his sovereign rights in N.; but a second invasion by Napoleon (1806) ended in the proclamation of his brother, Joseph Bonaparte, as king of N.; and on this latter assuming the Spanish crown in 1808, that of N. was awarded to Joachim Murat, brother-in-law of Napoleon. On the defeat and execution of Murat in 1815, the Bourbon monarch, Ferdinand IV., was restored. The liberal insurrectionary movements in N. in 1821 and 1830 were the forerunners of the revolution of 1848; and in each case the party of progress was combated by the respective kings with ruthless severity, and perfidious concessions, to be cancelled and avenged with sanguinary fury when the disarmed and credulous patriots were at the mercy of the sovereigns. See article GARIBALDI for the ultimate overthrow of the Bourbon dynasty in the kingdom of N., and its subsequent annexation to the kingdom of Italy under King Victor Emmanuel; also articles FERDINAND II. and ITALY. For the history of Sicily previous to its annexation to and during its various separations from N., see SICILY.

NAPLES-YELLOW is a pigment used by artists. It consists of antimoniate of lead, and is obtained by the direct combination of antimonic acid and oxide of lead under the influence of heat.

NAPOLEON BONAPARTE, Emperor of the French, was born at Ajaccio, in the island of Corsica, 15th August 1769. (For an account of the family to which he belonged, see **BONAPARTE, FAMILY OF**.) At the age of ten, he entered the Military School at Brienne, as a king's pensioner. Here he remained five years and a half. During that period, he displayed a great aptitude and predilection for mathematics, history, and geography, and an indifference to merely verbal and literary studies. His manner was sombre and taciturn, but as Bourrienne (who was his schoolfellow) says, this arose chiefly from the circumstance that he was a foreigner, poor and unaccustomed to the use of French, which he first learned at Brienne. In October 1784, he proceeded to the Military School to complete his studies for the army, and in rather less than a year obtained his commission as sub-lieutenant in the artillery regiment *de la Ferre*. When the Revolution broke out, N. was in garrison at Valence. He took the popular side, but in a quiet and undemonstrative way, for he did not love the boisterous enthusiasm of unmanageable mobs. When the armed rabble of Paris poured out to the Tuileries on the famous 20th of June 1792, N., who was then in the city, followed the 'despicable wretches' (as he called them), along with his friend Bourrienne; he saw them force the poor king to stick the red cap on his head, and smile fatuously from the windows of his palace. 'It is all over henceforth with that man,' said the young officer, and returned to Paris graver and more thoughtful than Bourrienne had ever seen him. After the scenes of

NAPOLEON BONAPARTE

the 10th August, he left for Corsica, where General Paoli held the chief command. The excesses of the Septembrists and Terrorists, however, induced Paoli to throw off his allegiance to the Convention, and to seek the assistance of England. N. was active but unsuccessful in his opposition to the designs of the general, and was obliged, along with his relatives, to flee from the island.

He now petitioned the Convention for employment, and was sent to assist in the reduction of Toulon, with the rank of lieutenant-colonel of artillery. The city was captured (19th December 1793) entirely through the strategic genius of N.; and in the following February he was raised to the rank of brigadier-general, and placed at the head of the artillery in the army of the south. Later in the year, he was sent to Genoa, to examine the state of the fortifications of the city, and to discover the political disposition of the inhabitants. In the beginning of 1795, he was again in Paris seeking active employment, and thinking, from sheer ennui, of transferring his services to the Sultan of Turkey. The Convention was now in great peril, on account of the mutinous spirit of the arrondissements of the capital, and, on the suggestion of Barras, Carnot, Tallien, and others, N. was made commander of the troops provided for its defence. On the 13th Vendémiaire (4th October 1795), the national guard, 30,000 strong, attempted to force its way into the Tuileries, where the Convention was sitting, but was routed and dispersed by a terrible cannonade directed by the young artillery officer. N. was immediately appointed to the command of the army of the interior. About this time, he made the acquaintance of Josephine Beauharnais, whom he frequently met at the house of Madame Tallien. Captivated by her elegant manners and amiable disposition, he proposed marriage to the graceful widow, and was accepted. The ceremony took place 9th March 1796. A few days before, he had been appointed to the supreme command of the army of Italy, and he was obliged to leave his bride almost at the altar. On his arrival, he found the troops in a wretched condition. He had only 36,000 available men, and even these were half-starved, and only half-clothed, to oppose to an Austrian and Piedmontese force of 75,000. Yet he was not afraid to undertake the conquest of Upper Italy. Leaving Nice at the close of March, he won his first victory over the Austrians at Montenotte (11th April), which opened the Apennines for him; three days later, a second success at Millesimo separated the allied armies; and, finally, his victory at Mondovi (on the 22d) compelled Sardinia to implore peace. He now hoped to utterly crush the Austrian army under Beaulieu, and at the battle of Lodi (on the 10th May) nearly accomplished it. His opponent did not venture to defend the line of the Mincio, but hastily throwing a garrison into the city of Mantua, retreated into the Tyrol. N. immediately entered Milan, and took possession besides of all the principal cities of Lombardy. Now began that system of enormous and unscrupulous plunder in Northern and Central Italy which gives something of a barbaric character to the conquests of the French. The Directory gave orders that N. should levy contributions from all the states which he had gratuitously freed, and according to his own account, he sent to France not less than 50,000,000 francs. His officers and commissaries actually seized whatever they wished, provisions, horses, and all manner of stores; and because Pavia ventured to make some slight resistance to the shameful extortions of the Republicans, N. gave it up to havoc for 24 hours! A body of savans (including Monge, Berthollet, and others) were

despatched to Italy to superintend the spoliation of its artistic treasures; and both now and in the subsequent Italian campaigns, pictures, statues, vases, and MSS. were carried off in great numbers, to gratify the vanity of the Parisian sight-seers. In this way, Lombardy, Parma, Modena, Bologna, and the States of the Church were savagely harried before the end of June—Pope Pius VI., in particular, being forced to submit to conditions of extreme rigour.

Meanwhile, Austria had resolved to make another effort for the recovery of Lombardy. About the close of July, Marshal Wurmser advanced from Trent at the head of 60,000 men, forced Napoleon to raise the siege of Mantua, but was himself defeated, with the loss of all his cannon, near Castiglione (5th August), and again at Bassano (8th September), in consequence of which, he was driven to take refuge within the fortress of Mantua with some 16,000 troops—the shattered remains of his 60,000. Austria, however, was not disheartened. A *third* army was despatched in two divisions: 30,000 from Carinthia, under Marshal Alvinzi; and 20,000 from the Tyrol, under General Davidowich. This was a terrible campaign for N.; his veterans were exhausted, his new supports had not arrived; he himself was despondent, while the Austrians were fresh and hopeful. At first, the latter were completely successful; but the great victory of Arcole, won by N. (17th November) after three days' fierce fighting, in which he lost nearly all his general officers, decided the fate of the campaign. His dispatches to the Directory, penned about this period, shew how thoroughly he apprehended the state of parties in Italy, and also how utterly indifferent he was to any considerations beyond those that advanced the interests of France. In January 1797, a fourth campaign was commenced by Austria. At the head of 50,000 fresh troops, Alvinzi descended from the Tyrol, but was completely routed by N. at Rivoli, on the 14th of the month; while not long after, Wurmser was starved into surrender at Mantua. A *fifth* army was assembled on the Tagliamento, under the command of the Archduke Charles: but his troops were mainly raw recruits, while those of N. were inured to war, and flushed with innumerable triumphs. In consequence, he was forced to retreat, which, however, he did slowly and in good order, hoping to surround his opponent in the interior of the country. N.'s design was to march on Vienna, and he actually penetrated as far as Judenburg, in Upper Styria, only eight days' march from the capital. The Austrian government at length was seized with alarm, made overtures of peace; and finally, on the 17th October 1797, the famous treaty of Campo-formio was signed, by which Austria ceded the Netherlands, Lombardy, and some other smaller territories to France; while she herself obtained in return, through disgraceful treachery on the part of the victor, possession of the province of Venice. It is generally said that N.'s military genius was never more brilliantly displayed than in these early Italian campaigns. In ingenuity of plan, celerity of movement, audacity of assault, he far outshines all his adversaries; it is, moreover, but just to him to state further, that he made desperate efforts to stop the excesses of the most scoundrelly commissariat in Europe; and that while in the main he shewed no hesitation in carrying out the brigand-like orders of the Directory, he does not appear to have appropriated a single penny to himself. It was power, not gold, that he cared for.

In December 1797, N. returned to Paris, where he was received with the utmost enthusiasm. At this time, there was much talk, and probably

NAPOLÉON BONAPARTE.

some vague design, on the part of the Directory, of invading England, and N. was appointed commander-in-chief of the invading army. It has been thought, however, that this was merely a feint to mask the real design of the Directory, viz., the invasion of Egypt, as perhaps a preliminary step to the conquest of British India. Be that as it may, an expedition against Egypt was resolved on by the Directory; and on the 19th of May 1798, N. sailed from Toulon, with a fleet containing 30,000 soldiers, and a body of savans to investigate the antiquities of the country. He reached Alexandria on the 29th of June. At this moment, France was at peace with Turkey; the invasion of Egypt, a Turkish dependency, was therefore an act utterly unjustifiable, and reminds us not of European warfare, but rather of the irruption of a horde of barbaric Tartars. N. having landed his troops, captured Alexandria, and marched on Cairo. The Mamelukes prepared resistance; but on the 21st July, at the battle of the Pyramids, they were completely defeated, and the French became, in a surface-way, masters of Egypt. N. now entered the capital, and immediately commenced to reorganise the civil and military administration of the country—for he took a great, but also an ostentatious pleasure in this sort of work. Meanwhile, on the 2d of August, Nelson had utterly destroyed the French fleet in Aboukir Bay, and so cut off N. from communication with Europe. A month later, the sultan declared war against him. This was followed by disturbances in Cairo, which were only suppressed by horrible massacres. It was obviously necessary that N. should go somewhere else. He resolved to meet the Turkish forces assembling in Syria; and in February 1799, crossed the desert at the head of 10,000 men, stormed Jaffa on the 7th March, after a heroic resistance on the part of the Turks; marched northwards by the coast, and reached Acre on the 17th. Here his career of victory was stopped. All his efforts to capture Acre were foiled through the desperate and obstinate valour of old Djeddar Pasha (q. v.), assisted by Sir Sidney Smith, with a small body of English sailors and marines. On the 21st of May, he commenced his retreat to Egypt, leaving the whole country on fire behind him, and re-entered Cairo on the 14th of June. It was during his absence that the savans made their valuable researches among the monuments of Upper Egypt. About the middle of July, the Sultan landed a force of 18,000 men at Aboukir, who were attacked by N. on the 25th, and routed with immense slaughter. But the position of the victor was far from comfortable, and he therefore resolved to return to France—especially as news had come to him of disasters in Italy and confusions in Paris. On the 23d of August, he sailed from Alexandria, leaving his army behind him, under the command of Kleber; and after narrowly escaping capture by the English fleet, landed near Fréjus on the 9th October. He hastened to Paris, soon mastered the state of affairs, threw himself into the party of Sieyès, and overthrew the Directory (q. v.) on the famous 18th Brumaire. A new constitution was drawn up, chiefly by Sieyès, under which N. became First Consul, with the power of appointing to all public offices, of proposing all public measures in peace or war, and the entire command of all administrative affairs civil and military. In a word, he was ruler of France; and though far from satisfied with the clumsy machinery of Sieyès's plan, he could afford to wait the future. About the end of January 1800, he took up his residence in the Tuileries. The country was tired of revolutions, discords, and confusions; it was proud of its young leader, who seemed inspired but

not enlaved by the ideas of his age, and who knew how to enforce obedience, as well as to panegyric principles. It therefore regarded his assumption of sovereign power with positive satisfaction. N. displayed extraordinary vigour as an administrator, recruited the national treasury, by various sagacious expedients, repealed the more violent laws passed during the Revolution, such as punishment for matters of opinion, reopened the churches, and terminated by policy the Vendean struggle. But he knew well that his genius was essentially military, and that his most dazzling and influential triumphs were those won on the battle-field. France was still at war with Austria, and he resolved to renew the glories of his first Italian campaign. Leaving Moreau in command of the army of the Rhine, he assembled, with wonderful rapidity and secrecy, an army of 36,000 men on the shores of the Lake of Geneva, and on the 13th May (1800), began his magnificent and daring march across the Alps. Almost before the Austrian general, Melas, was aware, N. had entered Milan (2d June). Twelve days afterwards, was fought the fiercely contested yet decisive battle of Marengo, which compelled the Austrians to resign Piedmont with all its fortresses, and (for the second time) Lombardy to the French. Later in the year, hostilities were recommenced; but the Austrians, beaten by Moreau in Germany (at Hohenlinden, &c.), and by N. in Italy, were at last forced to make peace; and on the 9th February 1801, signed the treaty of Lunéville, which was mainly based on that of Campo-formio. In the course of the same year, France and England also made peace, but the treaty (known as that of Amiens) was not definitively signed till the 27th of March 1802. Not less important for the consolidation of affairs in France was the famous *Concordat* (q. v.) between N. and Pope Pius VII., also concluded in 1801. In January 1802, N. became President of the Cisalpine Republic; and on the 2d August following, was declared Consul for life by a decree of the French senate.

Meanwhile, N. was busy superintending the drawing up of a code of civil laws for France. He assembled the first lawyers in the nation, under the presidency of Cambacérès, and frequently took part in their deliberations; the results of their labours were the *Code Civil des Français*, *Code de Procédure*, *Code Penal*, and *Code d'Instruction Criminelle*, besides commercial and military codes, all of which often go loosely under the name of the *Code Napoléon*. The first of these is an admirable production, and is in force to the present day. Considerable attention was besides paid to such branches of education as were likely to promote efficiency in the public service. Mathematics, physical science in all its departments, engineering, &c., were as vigorously encouraged as philosophy, ethics, and political speculation were discouraged. But the best proof that N. wanted not an educated people, but only active and expert tools and agents, was the indifference that he manifested to primary and elementary education. In a population of 32,000,000, the number of pupils under ten years is given by Fourcroy at only 75,000! The internal government was the scene of despotic centralisation. N. appointed all prefects of departments, and all mayors of cities, so that not a vestige of provincial or municipal freedom remained. He ruled France as he ruled the army of France, and was already an emperor in almost everything but the name.

Peace between France and England did not last long. N.'s policy in Italy irritated the British government, and as remonstrances were ineffectual, war was declared against France, 18th May 1803. The English fleet scoured the seas, paralyzing the

NAPOLÉON BONAPARTE.

commerce of France; while N. threatened to invade England, and assembled a large army at Boulogne. So utterly did he misconceive the character and condition of Englishmen, that he felt sure (by his own statement) he should be welcomed as a liberator by the people! While these warlike preparations were going on, occurred the dangerous conspiracy of the Chouan chief, George Cadoudal (q. v.), Pichegru (q. v.), Moreau (q. v.), and others. Its discovery (February 1804) alarmed N. excessively, and led to what has been considered one of the blackest deeds in his career—the murder of the Duke d'Enghien (q. v.) on the 20th of March following. He now appears to have felt it necessary to assume the title of emperor. France, he alleged, wanted an empire as a symbol of permanent security. An appeal was made to the nation. Upwards of 3,000,000 votes were given in favour of the proposed change in the form of government; only 3000 or 4000 against it. But where there is no municipal freedom, one does not know what value to put on votes. On the 18th May, N. assumed the title of Emperor at St Cloud, and was crowned by, or rather in the presence of, the pope (for N. rudely crowned himself), on the 2d December. In the following summer (May 26), he was also crowned king of Italy, in the great cathedral of Milan; and Eugene Beauharnais, his step-son, was appointed to the office of Viceroy.

This policy of aggrandisement, which set at naught the conditions of the treaty of Lunéville, alarmed the other nations of Europe, especially Austria, who saw her Italian possessions seriously threatened. In 1805, a coalition was formed between England, Russia, Austria, and Sweden, mainly through the persevering policy of the first of these countries; and war again broke out in the month of September. N. acted with amazing celerity. Concentrating his widely-scattered forces at Mainz, he marched at once across Bavaria, compelled General Mack to capitulate at Ulm with 20,000 men (17th October); and on the 13th of November entered the capital of Austria. France was electrified; the rest of Europe was thunder-struck. But a more glorious triumph was yet to come. The Russian army was already in Moravia, under the immediate command of the Emperor Alexander I., and was there being joined by the scattered Austrian troops. N. did not lose a moment. Hurrying north, he gave battle to the allies at Austerlitz, on the 2d of December. The contest was tremendous; but the victory was complete. N.'s opponents were utterly crushed; and next day the Austrian emperor sought an interview, and sued for peace. A treaty was signed at Presburg on the 26th December, by which Austria ceded to France all her Italian and Adriatic provinces; other changes effected by it were, the dissolution of the old German empire, and the formation of the *Confederation of the Rhine* (q. v.).

In February 1806, a French army conquered Naples, and the crown was conferred by N. on his brother Joseph; in the following June, another brother, Louis, was made king of Holland. Prussia, now, when it was too late, assumed a hostile attitude. She had hung off partly through fear and partly through selfishness, from the great anti-French coalition of the previous year, and now, when circumstances were almost hopelessly adverse, she madly rushed against her colossal enemy. Austria, with more magnanimity than prudence, lent her help, but the star of N. was still in the ascendant. The battle of Jena (October 16) absolutely annihilated the power of Prussia; five days later, N. entered Berlin, whence he issued (November 21) his celebrated 'Decrees' against British commerce, hoping to ruin her by shutting out her ships from

every harbour in Europe. His expectations, it need hardly be said, were disappointed. His policy well-nigh ruined the commerce of his own and other countries, but it only increased the prosperity of England. Her fleets and cruisers swept the seas; nothing could be got from the colonies save through her, and the merchants of the continent were obliged—in order to supply their customers as before—to let her carry on a vast contraband traffic. See **ORDERS IN COUNCIL.**

After the capture of Berlin, N. proceeded northwards to encounter the Russians, who were advancing to the help of Prussia. On his way, he summoned Poland to rise, but only with partial success. At Pultusk (December 28, 1806), and at Eylau (February 8, 1807), the French were beaten and driven back on the line of the Vistula; but after some months, he received heavy reinforcements, and on the 13th of June, fought and won the great battle of Friedland, which led to the treaty of Tilsit, signed on the 7th of July. By a secret article of this treaty, Russia promised to close her ports to British vessels. It is important to observe here, that, as the military triumphs of N. increased, the civil and political liberties of his subjects diminished. Consequent on the treaty of Tilsit, a decree of the imperial senate abolished the tribunate—the only political body in France that preserved the semblance of national self-government. In August, N. created his brother Jerome sovereign of Westphalia—having patched up a kingdom for him in his usual unscrupulous way—and soon after, entered on a war with Portugal—the beginning of the great Peninsular War. The occasion of the war was the refusal of the Prince-regent of Portugal to carry out the Berlin decree in regard to British shipping. In March 1808, occurred that extraordinary instance of trepanning at Bayonne, by which the whole royal family of Spain fell into the hands of N.; and in the following July, his 'dearly beloved brother' Joseph was ordered to exchange the throne of Naples for the 'crowns of Spain and the Indies.' His successor was the 'handsome swordman' (*beau sabreur*), Joachim Murat. Spain rose in insurrection, and an English force, under Sir John Moore, was despatched to its assistance. N. invaded the country about the close of October, defeated the Spanish forces, and captured Madrid (4th December). But his presence was urgently needed elsewhere, and he was forced to let Soult and other generals conduct the war in the Peninsula. Austria, again irritated and alarmed at his aggressive policy, especially in Italy (where he had seized Tuscany and the States of the Church), once more prepared for war, which broke out in the spring of 1809. Her army of Germany, commanded by the Archduke Charles, was in splendid condition; but still fortune was adverse. N. hurried into Bavaria, routed the Archduke at Eckmühl (22d April), compelled him to retreat into Bohemia; and on the 12th of May, entered Vienna for the second time. But the struggle was not over. The Archduke rallied his scattered forces, worsted N. in the terrible conflicts of Aspern and Essling (21st and 22d May), and drove him to take refuge for a time on an island of the Danube. The battle of Wagram (6th July), however, once more prostrated, or at least intimidated Austria; and on the 14th of October, she signed the peace of Schönbrunn.

N. appears to have now come to the conclusion, that he could only put a stop to the hostile machinations of the old legitimate dynasties by intermarrying with some one of them. Besides, his wife Josephine had no children—and he was ambitious of perpetuating his power in his family. With that callousness to everything except his own interests,

NAPOLÉON BONAPARTE

which is a prominent feature of his character, he immediately proceeded to divorce her. The act of divorcement was solemnly registered on the 16th December. Less than three months afterwards, he married Maria Louisa, Archduchess of Austria. He was now at the zenith of his power, and so, according to the old Greek belief, Nemesis was on his track. What caused his ruin was really that outrage on civilisation—the Berlin Decrees. Russia found it impossible to carry it out, without permanent injury to her great landowners; Sweden and other countries were in a similar predicament. This led to evasions of the decree, and these, again, involved Russia particularly in further complications, until finally, in May 1812, N. declared war against her; and in spite of the advice of his most prudent counsellors, resolved to invade the country. Every one knows the dreadful history of the Russian campaign. N., wringing contingents from all his allies—Germans, Austrians, Italians, Poles, and Swiss—concentrated between the Vistula and the Niemen an army of half a million of men. The vast horde crossed the latter river (24th and 25th June) in three divisions, captured Wilna (28th June), and ravaged Lithuania. The Russian generals retreated before the invading host, deliberately wasting the country, and carrying off the supplies, but avoiding, as far as possible, all engagements—their design being to surround N. in the heart of the country, and by the help of famine and the rigours of a northern winter, to annihilate him in his hour of weakness. N. followed up the retreating foe with reckless resolution. He risked everything upon the chance of striking some overwhelming blow. The horrors of his march—in Lithuania alone, 100,000 dropped off (dead, sick, or captured by the swarms of Cossacks that hung upon his flanks)—are too familiar to require description. When he reached Smolensk (18th August), the Russians had just left it—on fire! Three weeks or so later, he made up on the enemy at Borodino, where an obstinate and bloody battle was fought (7th September). The French remained in possession of the field, but of nothing else. A week after, N. entered Moscow, hoping to find rest for a time in the ancient metropolis of the country. But the city was deserted by its inhabitants; and on the 16th, a fire broke out, which raged till the 19th, and left Moscow a heap of ruins. After five weeks' stay, N. was obliged to commence his retreat (19th October). His army was reduced to 120,000 men. The winter set in much earlier than usual, and he had to return through the very districts which had been wasted on his advance. When he left Smolensk (14th November), he had only 40,000 fighting-men; when he crossed the Beresina (26th and 27th November), he had not more than 25,000. With the excuse—which was in itself no doubt true—that his presence was urgently needed in France, he now abandoned the miserable remains of his army; and, on the 5th of December, leaving Murat in command, set out in a sledge for Paris, where he arrived on the 18th of the same month. He instantly set about a fresh conscription; and in the spring of 1813, marched into Germany at the head of 350,000 men; but the Russian campaign had broken the spell of terror which his name had till then exercised. The spirit of all Europe was thoroughly roused. A conviction was—somewhat unconsciously—seizing every mind (at the close of the campaign of 1814, even France shared it), that the world had had 'enough of Bonaparte' (*assez de Bonaparte*). Prussia, in particular, was burning to wipe out the disgrace of Jena, and all the bitter humiliations to which she had been subsequently subjected. The victories of the British in Spain, the fame of which was spreading all over the continent, also proved to her that French

soldiers *could* be beaten, not once or twice only, but through whole campaigns. An alliance was formed between the king of Prussia and the Emperor Alexander. At first, Austria remained neutral, but afterwards she joined the coalition. N.'s military genius, it has been often remarked, never shewed to greater advantage than in this and the next campaign, which cost him his crown and his liberty. He was for some months successful in winning battles—at Lützen (2d May), Bautzen (21st May), and Dresden (24th, 25th, and 27th August); but the invincible temper of the allies, who knew that he was playing his last card, made these victories almost fruitless. They were convinced that one grand defeat would neutralise all his triumphs. This was inflicted, after several minor defeats, at Leipzig—the great *Battle of Nations*, as it has been called (16th, 18th, and 19th October). The result justified their expectations—N. was hopelessly ruined! He commenced his retreat towards France, followed by the allies. When he recrossed the Rhine, he had only 70,000 or 80,000 men left out of his 350,000. All the French garrisons in the Prussian towns were compelled to surrender. N. appeared at Paris 9th November; and though great discontent prevailed in the country, and a spirit of opposition shewed itself even in the legislative body, the senate decreed, at his bidding, another conscription of 300,000 men, with which N. began, in January 1814, to attempt to drive the allies out of France. The skill and energy which he displayed were extraordinary; but they only marked the intensity of his despair. On the 30th of March, the allied forces captured, after a severe engagement, the fortifications of Paris; next day, the Emperor Alexander and the king of Prussia entered the city *amid the shouts of the populace*; on the 4th of April, N. abdicated at Fontainebleau. He was allowed to retain the title of emperor, with the sovereignty of the island of Elba, and an income of 6,000,000 francs, to be paid by the French government. A British ship conveyed him to Elba, where he arrived on the 4th of May.

After a lapse of ten months, most of which was spent in intrigues, N. made his escape from the island, landed near Frejus on the 1st of March 1815, and appealed again to France. The army went over to him in a body, and several of his marshals, but the majority remained faithful to Louis XVIII. On the 20th of March, he reached Paris, reassumed the supreme power, promised a liberal constitution, and prepared once more to try the fortune of battle with the allies. At the head of 125,000 men, he marched (15th June) towards Charleroi, on the Flemish frontier, where the English and Prussian forces were assembling. The Duke of Wellington, who, the year before, had completed the deliverance of Spain, was appointed by the Congress of Vienna commander-in-chief of the armies of the Netherlands. The campaign lasted only a few days. On the 16th, N. defeated the Prussians, under Marshal Blücher, at Ligny, which compelled Wellington to fall back on Waterloo, where, on the 18th, was fought the most memorable and decisive battle of modern times. It resulted in the utter and irretrievable ruin of Napoleon. The despot, who knew what awaited him—for France had *not* recalled him from Elba; he came at the desire of a faction, whose interests were identical with his—returned to Paris. The House of Representatives fiercely insisted on his abdication. He did so (22d June) in favour of his son, Napoleon II.; they further demanded that he should leave the country for ever, and he retired to Rochefort, with the design of embarking for the United States. On the 7th July, the allies again entered Paris, and refused

to acknowledge the acts of the French provisional government. N., who saw that he could not escape either by sea or land, voluntarily surrendered (15th July) to Captain Maitland of the *Bellerophon*, claiming the protection of British laws! It was, however, resolved by the British government to confine him for life on the islet of St Helena, a lonely rock in the Southern Atlantic, 1000 miles from the coast of Africa. He was conveyed thither by Admiral Cockburn, and landed at St Helena, 16th October 1815. The remainder of his life was politically insignificant. His chronic quarrels with his governor—or *jailer*, as the French prefer it—Sir Hudson Lowe; his conversations with friends and visitors about his past career; his deliberate attempts to falsify history in his writings, are familiar to every one. After more than a year of bad health, he expired, 5th May 1821. He was buried with military honours. In 1840, his remains were removed to France, and deposited in the *Hôtel des Invalides*.

NAPOLÉON, or, in full, NAPOLÉON JOSEPH CHARLES PAUL BONAPARTE, a French prince and general of division, is the son of Jerome, king of Westphalia, and of Frederica, Princess of Württemberg, and was born at Trieste, in Austria, 9th September 1822. When the insurrection broke out in the Romagna in 1831, he was staying in Rome with his grandmother, Madame Letitia Bonaparte, but was forced to leave the city on account of his cousins (see LOUIS NAPOLÉON) being implicated in the revolutionary disturbances. He was then taken to Florence, and afterwards placed at a boarding-school in Geneva, where he remained two years, 1833—1835. His studies were completed at the Military School of Ludwigsburg, in Württemberg, in 1840, after which he travelled for five years in Germany, England, and Spain. In 1845, he obtained from the French minister, Guizot, permission to visit Paris under the name of the Comte de Montfort; but his relations with the democratic party, and his advanced political opinions, rendered him suspected by the government, who ordered him to quit the country. He, however, again made his appearance on the eve of the revolution of February 1848. After the fall of Louis-Philippe, he offered his services to the provisional government, and was elected by the Corsicans a member of the Constituent Assembly, where he voted with the moderate republicans. He held for a short time, in 1849, the office of minister-plenipotentiary at Madrid. After the *coup d'état*, he withdrew into private life; but on the restoration of the Empire he reappeared to share in the honours that now fell thickly on his family. By a decree of the senate, 23d December 1853, he was pronounced a French prince, with the right to a place in the Senate and the Council of State; at the same time, he received the insignia of the Grand Cross of the Legion of Honour, and—though he had not served—the rank of General of Division. In the Crimean war, he commanded a division of infantry-reserves at the battles of Alma and Inkermann, but soon after returned to France, on the plea of ill-health. N. was President of the Imperial Commission of the Paris Exhibition in 1855. In 1858, he was appointed head of the ministry for Algiers and the colonies, but held the office only for a short time. During the same year he married the Princess Clotilde, daughter of Victor Emmanuel, and in the Italian war of 1859, commanded the French army of reserve in the south of Italy, but was not engaged in actual hostility. In 1861, he made a speech in the senate, reflecting on the Orleans family, for which he was challenged by the Duc d'Aumale. The challenge was not accepted, much to the disgust of the French army. N. was President of the French Commission

representing France at the London Exhibition of 1862.

NAPOLI DI ROMANIA. See NAUPLIA.

NARAKA is the hell of the Hindus. Manu (q. v.) enumerates twenty-one hells or divisions of N., and gives a general description of the tortures which await the impious there. 'They will be mangled (in these hells) by ravens and owls; they will swallow cakes boiling hot, walk over burning sands, &c.' The Purān's, however, are more systematic. The Viahn'u-Purān'a, for instance, not only names twenty-eight such hells, but distinctly assigns each of them to a particular class of sinners. Thus, a man who bears false witness, or utters a falsehood, is condemned to the hell *Raurava* (i. e., Fearful); one who causes abortion, plunders a town, kills a cow, or strangles a man, goes to the hell *Rodha* (i. e., Obstruction); the murderer of a Brāhman, stealer of gold, or drinker of wine, goes to the hell *S'akara* (i. e., Swine); and so on. Besides these twenty-eight hells, however, which the Purān'a knows by name, we are told of 'hundreds and thousands of others in which sinners pay the penalty of their crimes.'

NARBONNE, a town in the south of France, in the department of Aude, 55 miles south-west of Montpellier, on a branch (La Robine) of the Canal du Midi. It is the *Narbo Martius* of the Romans; but there is reason to believe that it was well known to the Greeks 500 years before the Christian era. It was colonised by the Romans 118 B. C., and probably got the designation Martius from Q. Marcius Rex, one of the consuls at the time. Situated only about 8 miles from the sea, on the direct road into Spain and into the basin of the Garonne, N. was in early times a place of great commercial prosperity. It was the second settlement founded in South Gallia by the Romans, and was considered by them an important acquisition, both for its strength and as the key to the road into Spain. Under Tiberius, it flourished greatly; the arts and sciences being cultivated with success, and its schools rivalling for a long time those of Rome. About 309 A. D., it became the capital of Gallia Narbonensis, and contained among other buildings a capitol, theatre, forum, aqueducts, triumphal arches, &c. It was taken in 719 by the Saracens, who planted here a Moslem colony, and destroyed the churches. In 859, it fell to the arms of the Northmen. During the 11th and 12th centuries, it was a flourishing manufacturing city, but subsequently it fell into comparative decay, and is now entirely destitute of any monument of its former splendour. A considerable number of architectural fragments—as capitals, marble slabs with inscriptions, friezes, &c.—have been found, and have been grouped into a collection of antiquities.

The present very dirty town contains one imposing building, the Cathedral of St Just, founded in 1271, but still unfinished. The honey of N. is the best in France, both for colour and flavour. Manufactures are carried on to some extent. Pop. about 12,000.

NARCISSUS, according to a Greek fable, was the son of the river god Cephissus and of the nymph Liriope or Liriocessa of Thespie, in Bœotia. He was a youth of extraordinary beauty, of which he was excessively vain; and for this he was punished by Nemesis, by being made to fall in love with himself on seeing the reflection of his own face in a fountain. He died of this love-sickness; and on the place where he died, sprung up the flower which bears his name. The story of N., finely narrated by Ovid, is of comparatively late origin.

NARCISSUS—NARDOO.

NARCISSUS, a genus of plants of the natural order *Amaryllidaceae*, having a perianth of six equal petal-like segments, and a bell-shaped corona of various magnitude. The species are natives of the south of Europe, the north of Africa, and the temperate parts of Asia. The Common Daffodil (q. v.) is the only one which can be regarded as



Narcissus Poeticus.

truly a native of Britain. Many are cultivated in gardens, for the sake of their beautiful and often fragrant flowers, which in general appear early in the season. Some of them are known by the names of Daffodil (q. v.) and Jonquil (q. v.). The name *N.* is popularly restricted to those which have flat—not rush-like—leaves, and a short not bell-shaped corona. Of these, one of the best known is the Poet's *N.* (*N. poeticus*), with generally one-flowered scape, the flower white and fragrant, the corona with a deeply-coloured border; others, with one or two flowers on the scape, are in common cultivation.—The **POLYANTHUS NARCISSUS** (*N. tazetta*) has a number of flowers on the scape. It grows wild in stony places near the Mediterranean and eastwards to China. Many varieties of it are in cultivation. It is not only grown in gardens and green-houses, but in water-glasses, like the hyacinth. It is very common in gardens in India, where it is highly esteemed as a flower. The narcissi in general are propagated either by seed, or by offset bulbs. They succeed best in a rich light soil.

NARCO'TICS (Gr. *narkē*, stupor) are remedies which, in moderate doses, lessen the action of the nervous system. Their full operation is sleep or coma. Opium is the type from which most descriptions of this class of medicines have been drawn; but although most narcotics more or less resemble opium in their action, almost every one presents some peculiarity in the way in which it affects the system. These medicines are primarily stimulating, especially when given in small or moderate doses; but this stage of their action is comparatively short; and when the dose is large, the excitement is scarcely perceptible. Their power of inducing sleep has procured for them the names of Hypnotics and Soporifics; while many of them are termed Anodynes, from their possessing the property of alleviating pain. Next to opium, Henbane, Indian Hemp, and Aconite may be regarded as the most important narcotics. It has been already mentioned that there are differences in the mode of operation of the different members of this class. 'Some dilate, while others contract the pupil; some appear to concentrate their sedative action more particularly upon the functions of the encephalon, others upon the contractile power of the alimentary and bronchial tubes, while a strict distinction is to be drawn between those which occasion constipation and those which do not; all these things being of great practical importance.'—Ballard and Garrod's *Elements of Materia Medica*, p. 13.

Narcotics are usually administered either with

the view of inducing sleep or of alleviating pain or spasm. As, however, their action is much modified by a variety of circumstances—such as age, idiosyncrasy, and prolonged use—they should be administered with extreme caution; and as a general rule, only under competent advice. The various quack medicines for children which are known as *Carminatives*, *Soothing Syrups*, &c., contain some form of opium, and are a fertile cause of the great mortality that occurs in early life, especially among the poorer classes.

It is almost unnecessary to add, that all the narcotics when taken in excess are poisonous.

NARCOTINE ($C_{20}H_{27}NO_{14} + 2Ag$) is one of the organic bases or alkaloids occurring in opium, in which it usually exists in the proportion of 6 or 8 per cent. It is nearly insoluble in water, but dissolves readily in alcohol, ether, and chloroform. Its ethereal solution, when submitted to spontaneous evaporation, yields it crystallised in colourless acicular groups or in rhombic prisms. A mixture of concentrated sulphuric and nitric acids produces a blood-red colour with narcotine and its compounds. Narcotine possesses very slight alkaline properties; its salts do not readily crystallise, and are even more bitter than those of morphia, although the substance itself is almost tasteless. When first discovered (in 1803), it was supposed to be the stimulant principle of opium; but in reality it possesses very little activity. It has been prescribed in gradually increased doses up to a scruple, without the least injury. Its sulphate has been used in India as a substitute for quinine; and nearly 200 cases of intermittent and remittent fevers, treated by it with success, have been published by Dr O'Shaughnessy.

NARD AND NARDO'STACHYS. See SPIKE-NARD.

NARDOO (*Marsilea quadrifida*), a plant of the acotyledonous natural order *Marsileaceae* (q. v.), the only plant of that order which is used in any way by man. It has but recently become known to botanists. It is found in Australia, and affords important supplies of food to the natives of some

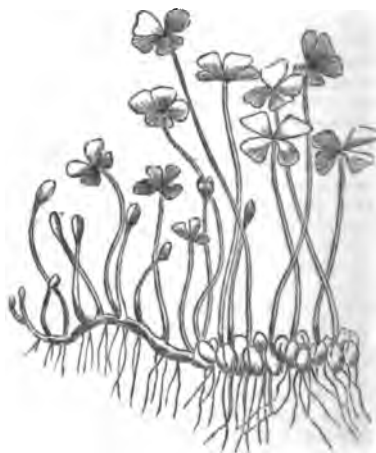

Nardoo (Marsilea quadrifida).

regions; it has also been of great use to some recent exploring-parties. It grows in places occasionally covered with water; vegetating whilst moisture abounds, and then exhibiting abundance of green clover-like foliage, the leaves consisting of three leaflets at the top of a stalk some inches in length.

When the water dries up, the remains of the plants are often covered with dried mud. It is then that the spore-cases are gathered for food. They are oval, flattened, about an eighth of an inch in length, hard and horny, and requiring considerable force to pound them when dry, but becoming soft and mucilaginous when moistened. The spore-cases, pounded with their contents, are made into cakes like flour.

NARDUS, a genus of grasses, having a simple spike, spikelets all on one side, no glumes; each spikelet consisting of one floret, which has two



Nardus Stricta.

pales, the outer ending in a long point. *N. stricta* is one of the most common of British grasses, growing in dry elevated situations, and very characteristic of them. It grows in tufts, and is often called MAT-GRASS. It is perennial, purplish, short, rigid, and very worthless, as almost no animal but the goat will eat it.

NAREW, a river of West Russia, an affluent of the Bug, rises in the government of Grodno, and flows west-south-west to the main stream, which it joins at Sierock, after a course of 294 miles. The waters of the N. are about as great in volume as those of the Bug. It is navigable to Tykoczin, 150 miles from its mouth.

NARO, a town of Sicily, in the province of Girgenti, and 14 miles east of the town of that name. It has 10,000 inhabitants, who trade in oil, wine, and sulphur. Numerous tombs, medals, and other antiquities have been found here.

NARSES, a celebrated statesman and general, and almost the last stay of the old Roman empire in Italy, was born towards the last quarter of the 5th century. The place of his birth is uncertain. His parentage was obscure, and he was probably sold as a slave in childhood, having, according to the barbarous usage of the period, been previously emasculated. From some menial office in the imperial household at Constantinople, he rose by successive steps to the post of *cubicularius*, or private chamberlain of the Emperor Justinian, and ultimately to that of keeper of the privy purse. In the difficult art of courtiership, N. long maintained a pre-eminence. More remarkable, however, considering

his condition, was the distinction which he attained in military affairs. In 538, he was sent to Italy in command of a body of troops, professedly to act in concert with Belisarius (q. v.); but in reality, it is conjectured, with a secret commission to observe and to control that general. After some successes, N., having disputed with Belisarius, assumed an independent authority; but his separate command was unfortunate, and he was recalled to Constantinople in 539. After some years, however, Belisarius was recalled, and N. was appointed to the chief command in Italy. His conduct of that expedition extorted the admiration even of his enemies. Not having the command of a sufficient number of transports, he marched his army along the whole circuit of the shore of the Adriatic, and while the enemy's fleet were still in possession of the sea, was enabled to encounter them in the plain of Sentaglio, near Tagina, where, after a desperate engagement, the Goths were totally defeated, and their king, Totila, slain. N. took possession of Rome, and after a series of successes both in Southern and Northern Italy, completely extinguished the Gothic power in that peninsula. Justinian appointed N. exarch of Italy in 553. He fixed his court at Ravenna, and continued, till the death of Justinian, to administer the affairs of Italy with a vigour and ability which did much to stay the progress of that decay which had long infected all its social, political, and military institutions. The only blot on the character of his administration is the avarice with which he is charged by his contemporaries. His exactions pressed heavily on the exhausted resources of the population; though their severity may be in some degree palliated by the splendour and utility of the public works on which he partly expended the public resources. On the death of Justinian, his ascendancy came to an end. The Romans, on the accession of Justin, complained to him of the exactions of N., and that emperor deprived him, in 565, of his office; a proceeding to which a special indignity was imparted by an insulting message from the empress, that it was time for him to 'leave arms to men, and to spin wool among the women of the palace.' To this bitter taunt (according to Paulus Diaconus, *De Gest. Long.* ii. 6), N. replied that he would 'spin for her a thread which she would find it hard to unravel;' and he is accused of secretly intriguing with Alboin, king of the Lombards, to incite a new invasion of Italy, at the same time submissively offering his services to the emperor for the purpose of repelling the invasion. This account, however, seems uncertain, and perhaps improbable; and as N. died at Rome in 568, just on the eve of the Lombard invasion, no light is thrown upon this story by the actual events of the war. His age at the time of his death is a subject of much curious controversy. According to the popular account, it was no less than 95 years; but this is doubted by most of the historians.

NARTHEX, a part of the early Christian churches separate from the rest by a railing or screen, and to which the catechumens and penitents were admitted.

NARVA, a Russian town, 95 miles west-south-west of St Petersburg, is situated on the Narova, ten miles from its mouth in the Gulf of Finland. It was founded in 1233 by Waldemar II., king of Denmark, and came into the possession of Russia in 1704. The navigation of the Narova is impeded by a waterfall near N., 14 feet high. In 1861, 465 vessels entered and cleared the port. About 7200 pounds of flax are exported annually, besides deals and timber. On the waterfall above the town,

there are saw-mills, and an extensive cotton-mill, which employs 1700 workmen. Though belonging to the government of St Petersburg, N. is ruled by the laws of the Baltic provinces. Here, in November 1700, Charles XII., with 8000 men, defeated a Russian army of 60,000 men, under Peter the Great and the Duke of Croy. Pop. 7255.

NARVAEZ, DON RAMON MARIA, Duke of Valencia, a Spanish general and statesman, was born at Loja, in Andalusia, 4th August 1805, and when very young, served in the war of Liberation against the French. He was an officer in 1820, when constitutional government was re-established in Spain, and in 1822, when a reactionary party of the royal guard took up arms to destroy the work of the revolution, N. ranged himself on the side of the liberals, and contributed by his courage to the repression of the mutiny. Shortly after, under the command of Mina, he made the campaign of Catalina against the guerillas, who were assisted by the monks. The invasion of Spain by a French army in 1823 forced him to retire from active life. He withdrew to Loja, and lived there in obscurity until the death of Ferdinand VII. in 1832. In 1834, as captain of chasseurs, he maintained a hot struggle against the Carlists of the Basque provinces, and signalled himself in various engagements. In 1836, he commanded a division under the orders of Espartero, and in November of that year, completely routed the Carlist leader, Gomez, near Arcos. This was a decisive moment in his career. He now became immensely popular, aspired to the highest offices of the state, and was regarded as the rival of Espartero. In 1838, by acts of terrible severity, he cleared the district of La Mancha of brigands, and was appointed in 1840 captain-general of Old Castile, and general-in-chief of the army of reserve. When Espartero gave General Alaix a place in the ministry, N. resigned his command. He took part in the insurrection against Espartero that broke out at Seville in 1840, but that having failed, he was compelled to flee to France, where he was shortly after joined by Queen Christina (see MARIA CHRISTINA), and commenced those plots against the government of Espartero which, in 1843, effected its overthrow. In 1844, he was appointed president of council, and created Duke of Valencia. His ministry was thoroughly reactionary. He recalled Maria Christina, and revised the liberal constitution of 1837. The progressista party was dissatisfied, and petty insurrections broke out, which the rigorous soldier-statesman repressed with an iron hand. But his dictatorial manners finally alienated even his personal friends, and his ministry was overthrown (10th February 1846). After a brief exile as special ambassador at the French court, he returned to power in 1847, but soon afterwards quarrelled with Queen Christina, and found it necessary again to retire from office in 1851. The cause of the quarrel is said to have been the indifferent respect which N. shewed to the children of Queen Christina by her second marriage. In 1856, on the overthrow of O'Donnell's ministry, he again became president of council, and immediately commenced to strengthen the royal authority, and to restrict the liberty of the press. But some of his measures were distasteful to the conservative party, and in November 1857 his ministry was forced to make way for that of Armero-Mon.

NARWHAL (*Monodon or Narwhalus*), a genus of *Cetacea*, of the family *Delphinidae*, resembling *Beluga* (q. v.) in form and in the want of a dorsal fin, but remarkably characterised by having no teeth at all, except two in the upper jaw, supposed

to be canines, which sometimes remain quite rudimentary, even in the mature animal, as they are in the young, and are sometimes developed into great spirally twisted straight tusks, passing through the upper lip, and projecting like horns in front. Only one species is ascertained, *M. monoceros* or *N. vulgaris*; the other species which have been described by naturalists having been founded on exaggerations and untrustworthy observations. It inhabits the Arctic seas, and is very rarely found so far south as the Shetland Isles, although an accidental wanderer has reached the coast of England. Narwhals are often seen in great numbers among the ice-fields, and in the creeks and bays of the most northern coasts. They commonly



Narwhal (*Monodon monoceros*).

associate in small herds. The tusks are much more frequently developed in the male than in the female, but in the female also they sometimes attain a large size. It is but rarely that both tusks are largely developed, although they sometimes are so, and then diverge a little; one of them generally continues rudimentary, or attains a length only of a few inches, whilst the other becomes a great horn, projecting straight in front, from which the animal has received the name of SEA UNICORN. A mature N. is generally about 15 or 16 feet in length, without reckoning the tusk, which is from 6 to 10 feet long. The body is less thick than that of the *Beluga*; the head is small, the forehead rises abruptly, the muzzle is very obtuse, the upper jaw projects a little; the first half of the body is nearly cylindrical, the remainder to the tail fin is conical. The tusk is hollow nearly to the point. Its use is rather conjectured than known. It is probably a weapon of defence, but Scoresby has suggested that it may be also used for breaking thin ice in order to obtain opportunity for respiration; and for killing fish, as he found remains of skates and other flat-fish in the stomach of a N., which it is not easy to imagine how a toothless animal, with rather small mouth and lips, could capture and swallow, unless the formidable tusk were first employed. Cephalopodous molluscs, however, are believed to constitute a principal part of the food of narwhals. The N. is a very active animal, swimming with great rapidity, lively, and playful. A group of narwhals playing together, projecting their great horns from the sea, and crossing them in their sport, is a very interesting sight. The N. is pursued by the Greenlanders and other inhabitants of the north, for the

sake of its blubber, with which its whole body is invested to the thickness of about three inches, amounting to nearly half a ton in weight, and yielding a large proportion of excellent oil. The tusks are also valuable, being of an extremely compact white substance—denser, harder, and whiter than ivory—which is used as a substitute for ivory. The kings of Denmark have long possessed a magnificent throne of this material, which is preserved in the Castle of Rosenberg. The flesh of the N. is used by the Greenlanders as food. Great medicinal virtues were formerly ascribed to the tusks; but were merely imaginary.

NASALIS, or **PROBOSCIS MONKEY** (*Nasalis larvatus*), a monkey allied to the *Doucs* or *Semnopithecus*, but distinguished from all other monkeys by an extreme elongation of nose, that organ being nearly four inches in length in the mature animal. In the young, the nose is comparatively undeveloped. The nostrils are placed quite at the extremity of the nose, and are separated merely by a thin



Proboscis Monkey (*Nasalis larvatus*).

cartilage. Of what use the magnitude of its nose is to the animal, is unknown. The N. inhabits Borneo and neighbouring islands. It is gregarious. It is an animal of about three feet in height, if placed erect, a position it does not often assume. It can leap fifteen feet or more. Its fur is thick, not long, nor woolly; chestnut red, and in some parts golden yellow.

NA'SCENT STATE, in Chemistry. When an element or compound is liberated from some chemical combination in which it had previously existed, the element or compound so liberated is at the moment when it escapes said to be in a nascent state; and it is *then* often capable of exerting far more powerful combining action with other bodies than it can exhibit when brought in contact with them *after* it has been liberated. Arsenic and hydrogen will not directly combine if brought in contact with one another under ordinary circumstances, but the application of Marsh's test (see **ARSENIC**) depends upon the direct union of the nascent hydrogen (liberated by the decomposition of the water) with the arsenic, giving rise to arseniuretted hydrogen gas. Again, if hydrated protoxide of nickel (NiO,HO) be suspended in a solution of caustic potash (KO,HO), it will undergo no change if a current of oxygen gas be passed through the solution; but if a current of chlorine be substituted for the oxygen, the whole of the metallic protoxide will be converted into the brown sesquioxide

(Ni_2O_3), the resulting decomposition being shewn in the equation:

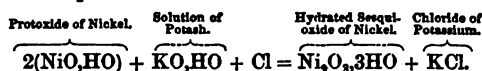

This change arises from the action of the chlorine upon the potash, during which chloride of potassium (KCl) is formed, while the nascent oxygen which is liberated from the potash combines with the oxide of nickel. Again, cyanogen (C_2N) and chlorine do not enter directly into combination, but if cyanogen at the instant that it is liberated from one of its compounds (as, for example, cyanide of mercury) comes in contact with chlorine, the two combine; and many other examples of similar action might be adduced.

NA'SEBY, a parish and village of England, in the county of Northampton, 12 miles north of the town of that name. Pop. (1861) 811. The battle of N., between Charles I. and the parliamentary army under Fairfax and Cromwell, took place here, June 14, 1645. It resulted in the total defeat of the royalists, the king being compelled to flee, after losing his cannon and baggage, and nearly 5000 of his army as prisoners.

NASH, RICHARD, better known by the name of *Beau Nash*, a fashionable character of the last century, who attained to a very remarkable notoriety, was the son of a Welsh gentleman, and was born at Swansea, in Glamorganshire, October 18, 1674. After studying at Oxford, he held for some time a commission in the army, and subsequently took rooms in the Temple, but the dissipations of society had more attraction for him than the pursuits of law. He became a diner-out, a frequenter of good society, and contrived to support himself by gambling. But the grand turning-point in his fortunes was his visit, in 1704, to Bath—then a favourite haunt of elegant invalids, and the scene of the gayest intrigues. N. undertook the management of the public balls, which he conducted with a splendour and decency never before witnessed. In this way he came to acquire an imperial influence in the fashionable society of the place. It appears that he was also distinguished by a species of sentimental benevolence. He played hard and successfully; yet if he heard an individual sighing behind his chair: 'Good Heavens! how happy would that money make me,' N. would thrust his own winnings into his hands, with theatrical generosity, and exclaim: 'Go, and be happy.' His own equipage at this period of his career was sumptuous. He used, we are told, to travel to Tunbridge in a post-chariot and six grays, with outriders, footmen, French-horns, and every other appendage of expensive parade. He is praised for the great care which he took of the morals of the young ladies who attended the Bath balls, always putting them on their guard against needy adventurers—like himself. In his old age, Beau N. sank into poverty, and often felt the want of that charity which he himself had never refused. He died at Bath, February 3, 1761, at the age of 87.

NASH, JOHN, an architect, was born in London in 1752. He underwent the usual course of training for his profession, but after practising for a few years, withdrew from it, and entered into various speculations by which he lost considerable sums. Returning to his profession, he met with great success, and in 1792 settled in London, where he speedily rose to eminence. On the strength of having obtained a patent in 1797 for improvements in the construction of the arches and piers of bridges, he was in the habit of claiming a great

part of the credit of introducing the use of cast-iron girders. A large part of his time was occupied in designing and constructing mansion-houses for the nobility and gentry in England and Ireland, but he is chiefly celebrated in connection with the great street improvements in London. From February 1815, when he was appointed 'architect, valuer, and agent to the Board of Woods and Forests,' down till near the end of his professional career, he was busily engaged in the planning of routes, grouping of buildings, and fixing of sites. Regent Street, Haymarket Theatre, Langham Place Church, and the terraces in Regent's Park, are specimens of his designs. The Pavilion at Brighton was another of his works. He retired from his profession in 1834, and died May 18, 1835. N., notwithstanding his many defects, possessed great power of effective grouping, as is well shewn in his works. In the architecture of mansion-houses, the designing of 'interiors' was his forte.

NA'SHUA, a manufacturing city of New Hampshire, U. S., at the junction of the Merrimack and Nashua Rivers. The falls of the latter afford water-power to six large manufacturing companies, which have extensive cotton-mills, machine-shops, &c. It has 10 churches, 3 banks, 2 newspapers. Pop. (1860) 10,065.

NA'SHVILLE, a city, port of entry, and capital of Tennessee, U. S., on the Cumberland River, 200 miles above the Ohio, and a little north of the centre of the state. The river is navigable by steam-boats of 1500 tons fifty miles above Nashville. Five railways connect it with a vast and fertile country. It is a handsome, well-built city, with a state-house, which cost a million of dollars; court-house, university, hospital, custom-house, theatre, penitentiary, Free Academy, Protestant and Catholic orphan asylums, 27 churches, 5 daily papers, 8 weekly, and 8 monthlies. It has a large commerce, flour and planing mills, manufactories of engines and machinery, and the extensive book-publishing house of the Southern Methodists. Near the city are the State Lunatic Asylum, and the 'Hermitage,' once the residence of President Jackson. In the war of secession, N. was taken by the Federals under General Rosecranz, and occupied by a military governor. Pop. in 1860, 16,987.

NA'SSAU, an independent duchy of Germany, lying between 49° 50' and 50° 50' N. lat., and 7° 30' and 8° 45' E. long., is bounded on the W. and S. by the Main and the Rhine, the Prussian-Rhenish provinces, and the grand duchy of Hesse; on the E. by the Hesse and Frankfurt territories; and on the N. by Westphalia. Area, 1795 square miles. Pop. 456,567, at the close of 1861. The duchy of N. is a compact state, possessing very great physical advantages. In its southern districts, nearly the whole of its area is occupied by the Taunus Mountains, whose highest point, the Great Feldberg, attains an elevation of about 2750 feet. This range includes within its boundaries the fertile valleys known as the Rheingau. The northern part of the duchy includes the barren highlands of the Westerwald, whose most considerable peak, the Salzburger Head, is nearly 2000 feet high. Besides the Rhine and the Main, which are the boundary-rivers, N. is traversed from east to west by the Lahn, which becomes navigable at Weilburg, and is augmented by the confluence of numerous other streams, as the Weil, Embe, Aar, Dill, and Elbe. The productiveness of the soil is proved by the excellent quality of the numerous vegetable products, which include corn, hemp, flax, tobacco, vegetables, and fruits, including grapes, which

yield some of the most highly esteemed Rhenish wines. The hills are well wooded, and abound with game of various kinds, and the rivers yield an abundance of fish and crustaceans. In the more mountainous districts, iron, lead, copper, and some silver is obtained, together with good building-stone, marble, and coal; the chief mineral wealth is, however, derived from the numerous springs, which, directly and indirectly, bring the government a clear annual gain of more than 100,000 gulden. The most noted of these springs, of which there are more than 100, are Wiesbaden, Weilbach, Langen-Schwalbach, Schlangenbad, Ems, Selters, and Geilnau, the majority of which are the property of the duke.

N., which is divided into 28 districts, has few towns of any commercial importance, but it boasts of many fashionable watering-places, which are annually crowded with visitors from every part of the world. Of these, the most considerable are Wiesbaden (q. v.), the capital of the duchy (pop. 16,000), Schwalbach, Schlangenbad, Fachingen, Selters, and Geilnau. Höchst, an active little place on the Main, is the only manufacturing town of the duchy, but a brick trade is carried on at many small ports on the Rhine, Main, and Lahn, from whence the mineral waters, wines, and other natural products of the country are exported. The exports are wine—including some of the choicest kinds, as Hochheimer, Johannisberger, Rudesheimer, Markbrunner, Aasmannshauer—mineral waters, corn, iron, manganese, cattle, &c.; while the imports embrace colonial products, manufactured goods, salt, jewelry, &c.

N. has a representative form of government, based on the constitution of 1814; and the duke, who is also a Count-Palatine of the Rhine, Count of Sayn, Königstein, Katzenellenbogen, and Dietz, &c., is assisted in the government by a council of state, presided over by a prime minister. The legislative assembly consists of an upper chamber, composed of 24 representatives, chosen for six years, and a second chamber, chosen annually. Nearly half the population belong to the Catholic Church, which is under the ecclesiastical jurisdiction of the Bishop of Limburg, who is assisted by a board of commissioners, located at Eltville, on the Rhine; and excepting about 8000 persons, who belong to the Jewish and other persuasions, the remainder of the people, including the reigning house, profess the 'evangelical' form of German Protestantism, and are comprehended in one episcopal see under the Bishop of Wiesbaden. Ample provisions are made in the duchy for popular education, in furtherance of which there are upwards of 700 elementary schools, with about 1000 teachers, 10 normal schools, a gymnasium, various training, theological, polytechnic, military, and other educational institutions. In accordance with a treaty with Hanover, Göttingen constitutes the university for arts for N., which has also a Roman Catholic theological faculty in conjunction with Hesse-Cassel at the university of Marburg. Wiesbaden, which is the principal seat for all national institutions of literature, science, and benevolence, has a good public library, containing 60,000 volumes, a museum, &c.

N. occupies, in conjunction with Brunswick, the thirteenth place in the limited council of the diet, but it has two votes in the *plenium*, or full council. It furnishes a contingent of 4279, with a reserve of 1833 men, to the federal army.

The receipts, according to the budget of 1862, were 3,693,967 florins derived from the crown domains and indirect taxes, and 301,400 florins from indirect taxation, while the expenditure was

estimated at 5,117,831 florins. The national debt at the close of 1861 represented a capital of 6,755,500 florins. The duke, who is in possession of very extensive domains, ranks as one of the richest princes of Germany.

In tracing the history of N. to its earliest origin, we find that the districts now known by that name were anciently occupied by the Alemanni, and on the subjugation of the latter people by the Franks, became incorporated first with the Frankish, and next with the German empire. Among the various chiefs who raised themselves to independent power in this portion of the Frankish territories, one of the most influential was Otto of Laurenburg, brother of King Conrad I., who became the founder of two distinct lines of princes. The heads of these lines were Walram and Otto, the sons of Count Henry I., who, in 1255, divided the land between them. Walram II., the elder, was the progenitor of the house of Laurenburg, which, towards the close of the 12th c., assumed its present name of N. from the name of its chief stronghold; while Otto, the younger, by his marriage with the heiress of Gelders, founded the line of Nassau-Gelders, whose last male representative died in 1423, but which still survives through a female branch, in the family now occupying the throne of the Netherlands. This junior branch of the house of Nassau, by inheritance from a collateral representative, acquired possession, in 1544, of the principality of Orange; and since that period, the representatives of the Otto line have been known as Princes of Orange (q. v.). The Walram line, which in 1292 gave an emperor to Germany, in the person of Adolf of N., was subdivided by the descendants of that prince into several branches, until, by the successive extinction of the other lines, the Nassau-Weilburg family, which at present reigns over the duchy, was left, in 1816, the sole heir and representative of the Walram dynasty in Germany. N. had been declared a duchy in 1806, and in 1817 the reigning Duke William granted a new constitution; but during the first sittings of the assembly, dissensions arose between the ducal government and the representatives, the former having attempted to establish the proposition that the ducal domains were the unconditional property of the royal house, and that all the expenses of the state would consequently have to be met by taxation.

This proved a fruitful source of dissension between the duke and his people, and the opposition and discontent to which it gave rise, were not finally allayed till 1834, when a more liberal ministry, under Count Walderdorff, succeeded the unpopular cabinet which had hitherto directed public affairs. Concessions were made by the ducal government, which met the requirements of the chambers, and a satisfactory compromise was effected in regard to the crown revenues. In 1836, N. joined the German *Zoll-Verain*, and subsequently to that period, it has continued to advance in material prosperity. The reigning Duke Adolphus William, who succeeded his father, Duke William, in 1839, shewed the same conservative tendencies as his predecessor. The revolutionary crisis of 1848 found the people, who had been harassed by over-government and by a jealous dread of liberal sentiments, ripe for insurrection. The peasantry rose *en masse* in the rural districts, and revenged themselves for the severity of the game-laws and other obnoxious restrictions, by perpetrating the most wanton destruction of game and wood in the forests belonging to the crown and nobility. These disorders were speedily put down by the aid of federal troops, but notwithstanding the concessions made by the government, the relations between the people and their ruler

continued for many years to be unsatisfactory. Of late years there are appearances of greater unanimity between the government and the representatives of the people.

NASSAU, the capital of New Providence, the principal of the Bahamas (q. v.), is pleasantly situated on the face of a hill, in lat. 25° 5' N., long. 71° 21' W. Pop. 7000. The town is well laid out, has several handsome public buildings, and an excellent harbour, drawing from 12 to 15 feet of water. The climate is very salubrious, and N. is a great resort of invalids from the north. N. exports cotton, pimento, and salt. In 1860, 219 vessels of 15,649 tons entered, and 209 vessels of 16,553 tons cleared the port. Since the outbreak of the civil war in the United States, it has become notorious in connection with the blockade-runners.

NASTURTIUM. See CRESS and TROPÆOLUM.

NATAL. The region now forming the colony of Natal derives its name from its being discovered by the Portuguese on Christmas-day 1498. It was visited about 1822 by several white traders from the Cape, who found the country in possession of the Zulu chief Chaka, who ruled in a most sanguinary manner over all the tribes, from the Umsimoulu to the St Lucia River. He was killed and succeeded by his brother Dingaan in 1838, but the latter having treacherously murdered a party of emigrant Dutch Boers, who had paid him a friendly visit by invitation to buy land, he was attacked and finally destroyed by the Boers, who at that time had emigrated from the Cape Colony in large numbers, and who made his brother Panda paramount chief in his stead, and then settled themselves down in the country as his lords and masters. The British government, however, now interfered, and after a severe struggle on the part of the Boers, the country was formally proclaimed a British colony on the 12th May 1843, since which time it has progressed very satisfactorily, and bids fair to become one of the most valuable dependencies of the British crown on the African continent.

The colony of Natal looks out on the Indian Ocean, being situated on the south-east coast of Africa, about 800 miles east-north-east of the Cape of Good Hope, between the 29 and 31 parallels of south latitude. Its north-eastern boundary is the Tugela or Buffalo River, which divides it from Zululand, and its south-western boundary is the Umsimoulu, separating it from Kaffraria proper. A lofty and rugged range of mountains called the Quathlamba, or Drachenberg, divide it from the Free State and Basutoland, and it contains a well-defined area of about 25,000 square miles.

These mountains are composed of a confused mass of granite, gneiss, sandstone, basaltic veins, and shale, and present both the flat top and serrated summits of the chain, of which they are a continuation, so well known in the Cape Colony as the Sneeuwberg and Stormbergen. About lat. 28° 30', these mountains seem to reach their culminating-point, and probably attain a height of 10,000 feet, forming a summit line of watershed, from which flow to all points of the compass the waters of the Orange, Umzimvoobo, Vaal, Tugela, and other large South African streams. Towards the coast, these mountains present a scarped and almost inaccessible face; towards the interior, however, they gradually die away into the immense rolling plains of the Free State. Many offshoots from these mountains traverse the colony, dividing it into a series of steps or plateaux, gradually rising from the coast region to the foot of the mountains, and forming so many zones of natural productions.

The coast region, extending about 25 miles inland,

is highly fertile, and has a climate almost tropical, though perfectly healthy. Sugar, coffee, indigo, arrow-root, ginger, tobacco, and cotton thrive amazingly, and the pine-apple ripens in the open air with very little cultivation. The midland terrace is more fit for the cereals and usual European crops, while on the higher plateau, along the foot of the mountains, are immense tracts of the finest pasturage for cattle and sheep.

The climate is very salubrious; the thermometer ranges between 90° and 38°, but the heat, even in summer, is seldom oppressive. The mean temperature at Pietermaritzburg, the capital, is 3°·5 above that of Cape Town. The winter begins in April and ends in September; the average number of rainy days being 13. In the summer season the thunder-storms are very frequent and severe. The annual rainfall on the coast is about 32 inches. Inland, it varies a good deal in different districts, and is greatest in summer. The south-east is the prevailing wind here in the summer months, as in the Cape Colony. Occasionally the sirocco or hot wind from the north-west is felt, which generally terminates in a thunder-storm.

N. has but one great harbour on its coast, and that is D'Urban, or Port Natal, in lat. 29° 40'. It is completely landlocked, but a bar prevents vessels above a certain tonnage from entering. There is, however, generally a depth of water on it varying from 9 to 18 feet. There is secure holding-ground in the outer anchorage. The harbour of D'Urban is of great importance to N., as it is the only one worthy of the name on the south-east coast. Many important engineering operations are now carrying on, which, it is supposed, will considerably increase the depth of water at the entrance. The principal rivers are the Tugela or Buffalo, the Umcomanzi, Umgani, and Umzimculu; like the majority of South African rivers, they are of no use for purposes of inland navigation; but their streams are permanent, and often available for irrigating purposes, thus giving N. in one very essential point a decided superiority over the Cape Colony.

Coal, copper-ore, iron, and other minerals are found in several places, and there is no doubt when the great mountain-range is properly explored, that it will be found very rich in mineral wealth. Large forests of valuable timber abound in the kloofs of all the mountain-ranges, and many tracts along the coast are also well wooded. N. is divided into the following counties: D'Urban and Victoria on the coast region; Pietermaritzburg, Umcomanzi, and Umooti, central; and Klip River and Weenen at foot of the mountains. The capital is Pietermaritzburg, with about 2000 inhabitants, on a tributary of the Umgani River, about 50 miles inland. It possesses three banks, a large military establishment, and many substantial public buildings. Its name is a compound of the Christian name of Pieter Rietief, and the surname of Gert Maritz, two celebrated leaders of the emigrant boers who were murdered by Dingaan. D'Urban, or Port Natal, is also a very flourishing town, having a railway connecting the landing-place at Point Natal with the town, and a population of about 1200. It has 2 newspapers, and several banks and other public institutions. Verulam, Weenen, and Ladysmith are also flourishing towns, and several other new villages have been recently formed.

N. is governed by a lieutenant-governor, nominally subordinate to, although actually independent of, the governor of the Cape, and has recently received a constitution somewhat similar to that of the Cape Colony. Municipal institutions have been granted to the principal towns. It forms the diocese of a colonial bishop, and many mission stations of the Wesleyan, American, Norwegian, and Berlin

missions exist. Education is receiving much attention, and schools are multiplying.

There are no practicable roads across the mountains except the Do Beer and Beruidenhout Passes, which lead by a very circuitous route across the Free States to the Cape Colony. The numerous rapid streams which run from the mountains render internal communication often very difficult, and few of them have as yet been bridged over.

The principal articles of export from N. are sugar and arrow-root; besides a large home and inland consumption, above 2000 tons of sugar have been exported during the last two years, worth more than £50,000 sterling. The total value of exports may be estimated at £120,000, and is annually increasing, and comprises horses, ivory, sugar, coffee, arrow-root, wool, hides, feathers, molasses, and rhinoceros' horns. The value of imports is about £385,000. The revenue of the colony may be estimated at £54,000, principally raised from custom-duties, transfer dues, and taxes on native huts, &c. In 1843, the value of imports was £11,712, that of exports £1261, while the revenue was only £12,000. N. productions were very respectably represented in the Great Exhibition of 1862, and formed one of the most interesting of all our colonial compartments. The population of N. consists of the original Dutch emigrant Boers, who remained in the country after it became a British colony; of English and German settlers; and the remains of the broken Zulu tribes, who originally possessed the country. They may be estimated at 10,000 white, of whom two-thirds are of English birth, and 120,000 natives, who are the most docile and industrious of all the Kafir races, and, when properly managed, make excellent servants. It is intended to introduce both Chinese and Coolie labour, for the purpose of extending the sugar-plantations in the coast region.

In 1861, 97 ships, of 18,000 tons burden, arrived at the port, and 100 ships left the same with cargoes of colonial produce.

The large animals are gradually disappearing, although elephants are still occasionally met with in the dense bush of the coast region. Lions, leopards, wolves, and hyenas still hang on the outskirts of civilisation. The smaller antelopes are plentiful, and alligators are met with in nearly all the rivers north-east of the Umzimculu. N., besides several poisonous snakes, produces a small species of boa, which sometimes attains a length of 16 feet. The hippopotamus is still found near the mouths of the rivers on the eastern frontier.

The botany of this region resembles that of Kaffria proper, although generally of a more tropical character. All the timber-trees of the Cape Colony are found here, besides many new ones. The climate of the coast region, however, is too warm for the grape, at least for the purpose of wine-making.

The distance overland from Cape Town to Pietermaritzburg is about 1200 miles. By sea, about 850 miles to Port Natal. The road between N. and the Cape Colony, along the coast, is very difficult to travel, owing to the great number of rivers to be crossed. The distance from King William's Town, in British Kaffria, to D'Urban is about 300 miles, and has been ridden in six days.—Mann's *Natal*; Hall's *South African Geography*; personal knowledge.

NATAL, or RIO GRANDE DO NORTE, a fortified seaport of Brazil, capital of the province of Rio Grande do Norte, and built on low lands about three miles from the mouth of the river of that name, 100 miles north of Parahiba. In the year 1859—1860, 52 vessels of 16,337 tons entered and cleared the port. Pop. estimated at 10,000.

NATAL—NATIONAL CONVENTION.

NATAL, JOHN WILLIAM COLENSO, D.D., BISHOP of, a divine of the Church of England, was born in 1814, and educated at St John's College, Cambridge, where he graduated as Second Wrangler and Smith's Prizeman in 1836. From 1838 to 1842, he was one of the masters of Harrow School, and for the next four years, tutor of St John's College. In 1846, he was appointed rector of Farnett St Mary, in the county of Norfolk, and in 1854, first Bishop of N., South Africa. The works by which he was, until recently, most widely known were his two treatises on Algebra and Arithmetic. The treatise on Algebra was first published in 1849, and that on Arithmetic in 1853. They soon acquired great popularity, and have been adopted as text-books in many of the principal schools and colleges in Great Britain. He has also published other educational works. He first attracted public notice, however, by the dedication of a volume of Sermons to the Rev. Mr Maurice (q. v.), at the moment when that gentleman was in disgrace with the 'orthodox' section of the religious world. His affection and respect for Mr Maurice were further shewn by his edition of the *Communion Service, with Selections from Writings of the Rev. F. D. Maurice* (1856). In the same year appeared his *Ten Weeks in Natal*; in 1861, his *Translation of the Epistle to the Romans, commented on from a Missionary Point of View*; and *A Letter to his Grace the Archbishop of Canterbury, upon the Question of the Proper Treatment of Cases of Polygamy, as found already existing in Converts from Heathenism*, in which he recommends, on grounds both of reason and Scripture, that converts to Christianity, already possessing several wives, should not be forced to put them all away, except one. He admits that monogamy is most in harmony with the genius of Christianity, but would enforce it only in the case of those who married after their conversion. The outcry raised by his professional brethren against the *Letter* was sufficiently loud, but it was nothing to the tempest of disapprobation that burst forth in the following year (1862), when he published *The Pentateuch and Book of Joshua Critically Examined*, in which he endeavoured to prove that, as they stand, these books are not the products either of the age to which they are usually assigned, or of the authors whose names they bear; and that they are not entirely historical, but in many most important passages are overlaid with legendary, mythical, and symbolical incidents—the growth of ages, and the result of afterthought interpreting events and supplying wants. Replies and 'refutations' innumerable have made their appearance, in spite of which the bishop has announced his intention of critically examining the rest of the Bible. The second, third, and fourth parts of this remarkable work have since appeared, distinguished by precisely the same qualities as the first.

NATANT. See **NAIANT**.

NATATORES (Lat. swimmers), the name given by Illiger, and many other ornithologists, to the order of birds called *Palmipedes* (q. v.) by Cuvier.

NATCHEZ, a city and port of entry in Mississippi, U.S., on the east bank of the Mississippi River, 280 miles north of New Orleans. It is finely situated on the bluff, 150 feet high, which here forms the bank of the river. A portion of the town at the bottom of the bluff is called Natchez-under-the-Hill, and was formerly the resort of the river gamblers, pirates, and other desperate characters. The city has eight churches, a court-house, jail, United States Marine Hospital, and two daily papers. It is the shipping port of a large and fertile cotton district, and has steam-boat

connections with the whole Mississippi valley. N., which derives its name from a noted tribe of Indians, was settled by the French in 1716, and destroyed by the Indians in 1729, who were subsequently defeated, and banished to the West Indies. Pop. in 1860, 13,553.

NATION (Lat. *natio*, from *natus*, born), a word used in two distinct senses. 1. A state or independent society united by common political institutions; 2. An aggregate mass of persons connected by ties of blood and lineage, and sometimes of language. The modern dogma of nationalism, as maintained by a class of continental politicians, starts from an assumption that a nation in the latter sense ought necessarily to be also a nation in the former, and endeavours to assign limits to the several races of Europe, with the view of erecting each into a distinct state, separated from other states or nationalities. The extreme politicians of the national school seem to consider the supposed rights of nationalities as paramount even to the obligations of treaties, and the political conjunction of one nationality with another is looked on by them as an adequate ground for a revolt or separation, apart altogether from the question whether the nationality is well or ill governed. In point of fact, the different races in Europe are so commingled, that any reconstruction of the political map of Europe, on ethnological principles, would be impossible, even if desirable. The blood of nine-tenths of Europe has been mixed within the historical period. The test of language, on which nationality has sometimes been based, is a deceptive one, in so far as it is indefinite and perpetually fluctuating. The people on the frontier between two races, as in the South Tyrol, generally speak two languages. Then we have dialects, like the Walloon, the Grödnerisch of the Tyrol, and the Romansch of the Grisons—as also the Breton, Welsh, Gaelic, and Irish languages, which could hardly be made the basis of independent communities. The wellbeing of the people governed is properly the end of all government, and it has practically not been always found that a state is better governed when it consists of one race only, than when it includes an aggregate of races. Highly diversified nationalities may be united in one political system, provided only that the government respects and consults the peculiarities of the several races, and does not attempt to force the usages, habits, or language of one on the rest. See **ETHNOLOGY**.

NATIONAL CONVENTION, an assembly of deputies of the people, which assumed the whole government of France on the overthrow of the throne in 1792. When the National Assembly (see **ASSEMBLY, NATIONAL**) had decreed the suspension of the king, 10th August 1792, it appointed the election of the N. C., which commenced its sittings 21st September. Its first act was to declare France a republic, 25th September. Upon this followed the trial and condemnation of the king. Through the support of excited mobs, the extreme Jacobin party became predominant in the Convention; where, from the elevated seats on which its members sat, it received the name of the *Mountain* party. The *Revolutionary Tribunal* was established; the chief administration of affairs was intrusted to the *Committee of Public Safety*, which exercised the most despotic powers. The Girondists (q. v.), at first a powerful party in the Convention, were destroyed, many of them perishing by the guillotine; and a new constitution, thoroughly democratic, was adopted, 10th August 1793; but its operation was suspended until peace should be restored. Meanwhile, the actual rulers of the country displayed marvellous energy; almost a million of citizens being placed under arms, and

immense provision of all warlike stores made by means of requisitions. They also proceeded with merciless severity against their political opponents, dealing with them as traitors; hundreds of thousands were thrown into prison, and the number who died by the guillotine increased daily both in Paris and throughout France. The N. C. itself latterly became subject to the dictatorial power of Robespierre; many of its members were guillotined within a few weeks; and independent opinion was no longer expressed. The overthrow of Robespierre was followed by a great reaction; the Jacobins were suppressed; and finally, the N. C., after concluding peace with Prussia and Spain, dissolved itself 26th October 1795 (4th Brumaire of the year IV.), leaving to the nation a new constitution, which placed the government in the hands of a Directory (q. v.).

NATIONAL COVENANT. See COVENANT.

NATIONAL DEBT. See DEBT, NATIONAL.

NATIONAL EDUCATION. The general subject of Education has been already treated under that head. By the term 'National Education' is understood (1) the means taken by the body of any nation, either through the state or other organisations, for educating the people; (2) the objects which the nation ought to place before itself in its educational measures. These questions involve the whole inner and outer history of education, and are far too large and important to be capable of such treatment here as would convey accurate notions to the reader. All we can do is to glance slightly at the history of the two branches into which the subject divides itself. Among ancient nations, and among not a few nations now existing, education in any definite sense did not, and does not, exist for the masses of the people. The children grow up in reflective or unreflective imitation of their fathers. But at all times, nations which have quite emerged from the savage state, have had some more or less organised scheme of education for the leisured and governing classes. The purpose kept in view in such education has been to fit the pupils to discharge certain duties of war or government. In addition to this, the priesthood had the education which their traditional hymns, laws, and customs afforded. That man as such, apart from any special practical end, should be educated, was an idea late of being recognised, and occurred first to the Greeks, to whom the world owes so much. But neither among them nor their imitators, the Romans, was the education of the masses of the people ever contemplated. Education, properly so called, was confined to a few. In the centuries which succeeded the introduction of Christianity, the church was the great educating body—training those intended for the service of the altar, not only in Christian doctrine, but in all the learning of the past. This, at least, was the general tendency of education in the church. But it was not till the Reformation in the 16th c. that learning, even to the limited extent of reading and writing, was considered a worthy object of pursuit by any save those who, in some form or other, were destined to be drawn within the clerical ranks. The Reformation introduced the idea of educating the masses of the people—the leaders of this movement being, no doubt, forced to this conclusion by the necessity which their view of man's personal religious obligations imposed on them. It was manifestly a corollary from the position they took up that every man's intellect should be so trained as to be able to read, and inquire, and think for itself. It was only very slowly that so large a conception of the sphere of education could be given

effect to. Gradually, however, popular schools arose in many parts of the continent of Europe, especially in Germany, and the number of gymnasia or grammar-schools was, during the same period, increased. In Scotland, so early as 1606, the government took up the matter, and ordained that there should be a school as well as a church in every parish, at the same time providing for their maintenance by a tax on land, and for their management by putting them under a certain number of those who paid the tax conjoined with the minister of the parish—all being subject to the presbyteries within whose bounds they were situated. The example of Scotland cannot be said to have been followed on anything like a national scale by any country till after the French Revolution had exhausted itself. Since 1815, the distinguishing idea of government administration may be said to be the necessity of educating the people, and all the people—even the outcast and the criminal. During the last fifty years, all the German states, and more especially Prussia and Saxony, have developed excellent national systems of education, and France has followed their example. Russia and the new Kingdom of Italy are also now organising primary instruction; and at the same time, as in all European countries, they are making provision for the instruction and professional training of the teachers in Normal Schools (q. v.). The schools for instructing the middle classes, and grammar-schools (French, *lycées*; German, *gymnasiums*), whose object is to prepare pupils for the universities, have received increased attention. Universities themselves, too, have been further developed, their curricula extended in range, their objects elevated, and their number increased.

To return to primary instruction. In England there is no national system, properly so called; but voluntary efforts are largely aided by the state in the form of Privy Council grants. These grants have also been extended to Scotland, as it became necessary to supplement the parochial schools there, owing to the increase of population. The principal conditions on which these grants are made are, that they are only to supplement local efforts, that the schools pass a satisfactory examination before a government inspector, and that the Bible be read in them. As much additional religious instruction may be given as the school-managers please, but no schools will be admitted to Privy Council aid from which the Bible is excluded. Under the stimulus afforded by these grants, the educational wants of England have, since 1839, been to a great extent supplied; but many districts are still unprovided with schools, and many more are very badly supplied. A national system—that is to say, a system which would insure that a school was brought within reach of every child—is what England is tending to, and must ultimately have. Meanwhile differences of opinion as to the management of schools supported, as the schools under a 'national system' must be supported, namely, by a compulsory tax, and as to the kind of religious instruction to be given, divide parties, and make an immediate settlement of this all-important question impracticable. In Scotland the same evils exist as in England; but, owing to its admirable and ancient Parochial School System, to a very much less extent. A very considerable party, both in England and Scotland, desire to cut the knot of the educational difficulty by uniting on the subject of secular instruction, and making separate provision for religious instruction by the various sects. This party is commonly called the Secular party. See also VOLUNTARIANISM.

In Ireland, a national system instituted and

NATIONAL GUARD—NATURAL HISTORY.

maintained by the state exists, and one of its main features is the separation of the religious from the secular teaching—at least in theory. The extent to which this principle has been encroached upon in the course of working out the scheme, is not accurately known, but is worthy of special inquiry.

In the British colonies, as in the United States of America, adequate state systems of education have been provided on the basis of the secular principle.—Further details of the external history of primary education in England, will be found under PRIVY COUNCIL, COMMITTEE OF, ON EDUCATION.

NATIONAL GUARD, an armed organisation of the inhabitants of towns for local defence, differs from the British Militia and Volunteers, in that it is at the disposal of the respective municipalities rather than of the crown. From this circumstance, the National Guard has always been an eminently democratic force, dependent on the approbation of the multitude, powerful when aiding a revolt, but impotent against disturbers of tranquillity. Italy, Greece, and some other nations, have at times maintained this civic force: but the country where it arose, and whence it has derived its historic fame, is France. For a description of the celebrated French National Guard, see GARDES SUISSES.

NATIVE, a term much employed in Mineralogy to designate substances found as minerals, which are also, and most of them more abundantly, obtained from other minerals by chemical processes. Thus silver found pure, or nearly so, is called *Native Silver*, whilst almost all the silver used in the world is procured from ores in which it exists variously combined. The term native is more commonly applied to the metals than to any other substances.

NATRON, or **TRONA**, is a term which is employed in commerce to designate an impure sesquicarbonate of soda ($2\text{NaO}, \text{HO}, 3\text{CO}_2, + 3\text{Aq}$), which always contains sulphate of soda and chloride of sodium. It is obtained from the margins of lakes in Egypt, Siberia, Tibet, &c., and from the borders of the Black and Caspian Seas.

NATRON LAKES. Natron was one of the substances employed, at an early period, by the ancient Egyptians for the embalming of the mummies. It was called *hesmen* by the ancient Egyptians, and, together with the lakes from whence it was derived, is mentioned in texts of the 12th dynasty, B. C. 1800 circa. These lakes are in the vicinity of Zakeek, a village lying west of the Damietta branch of the Nile, south of the Lake Mareotis and Alexandria. The lakes, eight in number, are below the level of the sea, and the natron is obtained by evaporation, the best called *sallance*, or royal, being crystallised almost pure. The locality is also renowned for four monasteries, Deyr Suriani, St Maiarius, Amba Bishoi, Deyr Baramoos, containing libraries of Arabic, Coptic, and Syriac MSS., many of which obtained by Archdeacon Tattam, and other travellers, have enriched the national collections with Syriac MSS. of great interest relating to theology and ecclesiastical history. Their present population is about 300, but in the time of St Pachomius, 5000 anchorites dwelt here.

Lepsius, *Todt. Taf.* vii. c. 17, l. 17; Wilkinson, *Mod. Egypt*, i. 332; Brugsch, *Wanderung nach Natron Klötern* (12mo, Berl. 1855).

NAT'TERJACK. See TOAD.

NATUNA ISLANDS, THE, lie to the north-west of Borneo, between $2^{\circ} 28'$ and $4^{\circ} 56'$ N. lat., and $107^{\circ} 57'$ and $108^{\circ} 15'$ E. long. They are densely wooded and mountainous, Ranay, on Great Natuna, rising to a height of 3500 feet. The largest of the

islands is about 600 square miles. Pop. of the whole about 1300, who grow rice, maize, sago, coconuts, &c., and exchange the produce of their fishings, their sago and cocoa-nut oil, for rice, iron, and cottons, at the European settlements on the Strait of Malacca.

NATURAL, in Music, a note belonging to the diatonic scale of C, and neither elevated by a sharp nor depressed by a flat. When a note has been so elevated or depressed, the natural sign \natural prefixed to it on its recurrence restores it to its place on the scale. When music is written on a key with a signature of sharps or flats, it is the office of the natural sign to counteract the signature as regards the note to which it is prefixed.

NATURAL HISTORY, in the widest sense, includes all natural science, and has the whole of creation for its subject. In this sense the term was employed by the philosophers of antiquity. But it is now limited to those branches of science which relate to the crust of the earth and its productions. Of these, geology and mineralogy have for their subject inorganic portions of creation; botany and zoology, the various branches of which are often pursued as separate sciences, with physiology, have for their subject organised creatures. Natural history takes cognizance of the productions of nature, and of their relations to each other, with all the changes on the face of the earth, and all the phenomena of life, both animal and vegetable. It derives assistance from other sciences, particularly chemistry and natural philosophy; and some of the branches of chemistry may also be regarded as branches of natural history. When man himself is considered as a subject of scientific study, psychology must be added to the branches of natural history, but in the term as commonly employed this can scarcely be said to be included.

In every department of natural history, classification is of the utmost importance, and scarcely less important is a scientific nomenclature suited to the classification. The subjects of study are so incalculably numerous, that an arrangement of them in well-defined groups is necessary to any considerable attainment in the knowledge of them; and it is only by systems of classification which arrange smaller groups in larger, and these in larger and larger again, that natural history has been brought to its present state. The very division of natural history into different sciences is a result of such a classification, and implies a recognition of the largest and highest groups. It is not always in the establishment of these groups that the greatest difficulty is experienced. The primary distinction of all the subjects of natural history into organised and unorganised, or into those having life and those not having life, presents itself very readily to every mind. And equally natural and necessary is the distinction of organised beings into Plants and Animals, however difficult it has been found to draw the precise limit between the lowest of plants and the lowest of animals. Another distinction readily presents itself to the student of living beings, in the kinds which retain the same characters from one generation to another. But here arises one of the most important of all the questions of natural history, what a *species* is, and how it differs from a *variety*. For this we refer to the article SPECIES. But much difference of opinion as there is on this point, the common and long-prevalent notion may be assumed, as suitable enough for guidance in all that relates to classification, that those are distinct *species* which cannot by any change of circumstances—or, let it be said, by any *ordinary* change of circumstances, and within any *moderate* period of

time—be so modified as to be transmuted one into another, whilst those are only *varieties* of which the modification and transmutation can be thus effected. Thus, in botany, *Brassica oleracea* is a species, of which kale, cabbage, cauliflower, broccoli, Brussels sprouts, &c., are varieties. Species, grouped together, according to their natural affinities, form *genera*; but a *genus* does not necessarily consist of more species than one; for, whilst some contain hundreds of species, others, apparently very distinct, contain only one as yet known to naturalists. The distinctions by which genera are separated are of course arbitrary, and are admitted to be so by those who deny that the distinctions between species are arbitrary, or that there is any uncertainty about them but what arises from the imperfection of our knowledge; for, at present, it must be admitted on all hands, that the uncertainty is in innumerable instances very great, what are species and what are varieties. The great object, however, in the formation of *genera* is that they shall be accordant with the facts of nature; and so in regard to the larger or higher groups which are composed of associated genera, as tribes, families, orders, classes, &c. But in all this, the great difficulty is that affinities exist on many sides; and that groups cannot be satisfactorily arranged in the order of a series, but often rather as if they radiated from a common centre; whilst otherwise viewed, the same groups might seem to radiate very differently from another common centre. A *natural system* is one framed with the utmost possible regard to all these facts; an *artificial system* fixes on one class of facts and proceeds upon it, in disregard of all others. See **BOTANY.**—In the inorganic departments of nature, a *species* is of course something different from what it is in the organic. But classification still proceeds on the recognition of facts in nature itself, which it is sought to exhibit in the groups that are formed. See **MINERALOGY.**

The nomenclature of natural history, in so far as it relates to organic beings, continues essentially as it was established by Linnæus. See **GENUS.** The names have in many cases been changed, but not the mode of nomenclature.

NATURAL OBLIGATION, in Law, means an obligation which is supposed to be prescribed by the law of nature, as the obligation of a parent to maintain his child. In England, such an obligation is not recognised by the common law, and therefore it was necessary in the Poor-Law statutes to punish by a penalty parents who, being able, refused or declined to maintain their children. In Scotland, the natural obligation of a parent to maintain his child is, however, recognised by the common law, though it is also enforced by the Poor-Law statute.

NATURAL PHILOSOPHY is a term frequently employed in Great Britain to designate that branch of physical science which has for its subject those properties and phenomena of bodies which are unaccompanied by any essential change in the bodies themselves. It thus includes the various sciences which are classed under *Physics* (q. v.) in the limited sense of that term.

NATURAL THEOLOGY is the name given to that branch of moral science which concerns itself with the evidences for the existence of God, drawn from an inquiry into the constitution of the universe. It is believed by the majority of philosophical thinkers, that these evidences warrant the belief in a Being of infinite power, wisdom, benevolence, and justice. There are, however, philosophers of great eminence who deny that there is such a thing as Natural Theology, who say that nature, at the best, gives forth an uncertain sound regarding the

existence of a Supreme Being, and that a logical demonstration of such existence is impossible, and has always broken down. This view is held, for example, both by atheists like David Hume, and by the new Scotch-Oxonian school of metaphysicians, of whom the principal representative is Mr Mansel. The standard English work on the subject has long been Paley's *Natural Theology* (Lond. 1802; new edition by Lord Brougham and Sir Charles Bell, 1836). The Bridgewater and Burnett Treatises are also contributions to this branch of science.

NATURALISATION, the act of placing an alien in the position, or investing him with the rights, of a natural-born citizen. A person naturalised for the purpose of protection or allegiance, is generally supposed to be incorporated with the naturalising country; but if he has been the subject of a country which does not allow him to shake off his allegiance, and he find himself, by the breaking out of war, in a situation in which his duties to his country of birth and of adoption are at variance, the former country will consider him in the light of a rebel, and not a lawful enemy, if he be found in the service of the latter. As a general rule, a wife by marriage acquires the nationality of her husband, and the naturalisation of a father carries with it that of his minor children.

In the United Kingdom, till lately, naturalisation could only be effected by act of parliament. By 7 and 8 Vict. c. 61, the power is vested in the principal secretaries of state, any one of whom, on receiving a petition from an alien intending to reside in the United Kingdom, and desirous to be naturalised, may issue a certificate, to be enrolled for preservation in Chancery, granting to the memorialist, on condition of his taking a prescribed oath within sixty days, all the privileges of a natural-born British subject, except that of becoming a member of Privy Council or of either House of Parliament. The secretary must except these rights, and may except others. By the same statute, every person born of a British mother shall be capable of holding real and personal estate. An *alien friend* may hold every species of personal property except chattels real, and a subject of a friendly state residing in any part of the United Kingdom may hold lands and tenements for 21 years. The same privileges are extended to persons naturalised before this act, who have resided five consecutive years in the United Kingdom. A foreigner who has served two years on board a British ship in time of war, becomes thereby, *ipso facto*, naturalised.

A subject of France, by the now existing law of that country, loses his native character by naturalisation in a foreign country, or acceptance of office abroad without permission of the state, or even by establishing himself permanently out of his country. He may recover his rights by renunciation of his foreign office or domicile, and due application to the state.

In Prussia, the higher administrative authorities have it in their power, except in a few special cases, to naturalise any stranger who satisfies them as to his conduct and means of subsistence. Nomination to a public office confers, *ipso facto*, naturalisation. A Prussian subject cannot emigrate without sanction of the authorities; and having emigrated with their sanction, he loses his citizenship.

In Austria, the higher administrative authorities may confer the rights of citizenship on a person who, after ten years' residence within the empire, has been allowed to exercise a profession. A foreigner employed as a public functionary becomes thereby invested with rights of citizenship; but admission into the army has not this effect. The same rule as in Prussia prevails with regard to emigration.

In Bavaria, citizenship may be conferred by royal decree, or by a domicile acquired by a stranger who is free from personal subjection to another state. It is lost by emigration, or by acquisition, with the royal permission, of citizenship elsewhere.

In Württemberg, a stranger must belong to a commune in order to acquire the rights of citizenship, unless he be nominated to a public function. Citizenship is lost by emigration, or by acceptance of office in another state.

In the kingdom of the Netherlands, the power of naturalising rests in the crown.

In Russia, naturalisation is effected by taking an oath of allegiance to the emperor; but a naturalised stranger is at liberty to renounce his naturalisation, and return to his country.

In the American States, congress alone has the power of establishing a uniform rule of naturalisation.

A collective naturalisation of all the inhabitants of a country takes place when it is incorporated into another country by cession, gift, or conquest. See ALIEN.

NATURALISED. In the language of botanists and zoologists, those plants and animals are said to be *naturalised* in any country, which, having been introduced into it by man, have established themselves so as to exist without his care. A plant or animal is never said to be naturalised so long as it exists merely in a state of cultivation or domestication, but is so when it becomes truly wild, and, unaided, competes successfully for a place among those which are indigenous to the country. Thus, the horse is not naturalised in Britain, or in most of the countries in which it is most highly valued; but both the horse and the ox may be said to be naturalised in South America. Many of the plants now most characteristic of Southern Europe, are sometimes said to have been originally introduced from the East; and some that are abundant in many parts of Britain were in all probability brought from the continent of Europe. Some of these almost evince their foreign origin by growing chiefly near ruins, or in places which have long been the seats of human habitation. Many plants now naturalised in Britain appear to have been originally brought for medicinal use, although now disregarded. In many cases, however, naturalisation has taken place without any attempt having ever been made by man to introduce the plant even for cultivation; and thus many European weeds are now common in America, the seeds having found their way thither with those of more valuable plants, or in some such accidental manner. The same thing has taken place as to animals. Thus, mice and rats find their way from one country to another; thus the bed-bug found its way at no remote date to Britain; other insects have been even more recently introduced with foreign productions of different kinds; and a mollusc (see DREISSENA), previously unknown, has established itself in some British rivers and canals. The pheasant may be mentioned as an instance of naturalisation in Britain, designed and successfully accomplished by man. An *Acclimatisation Society* has recently been formed in London, which has for its object the naturalising, rather than what may more strictly be called the acclimatizing, of animals deemed suitable and desirable. It is unquestionable that much may be done by naturalisation of animals, not only to render rural scenes more attractive, but also to increase their economical productiveness. Perhaps nothing of this kind has received so little of the attention due to its importance as the naturalisation of fishes. See PISCICULTURE.

NATURE-PRINTING. This is a process by which engravings or plates answering thereto are produced by taking impressions of the objects themselves, and printing from them. There is some dispute as to the original inventor of this art; Denmark claims it for a native of Copenhagen, Peter Kyle, a goldsmith, who died about 1833, leaving the MS. description of his invention in the archives of the Royal Collection of Engravings in that capital. It is, however, admitted that no use was made of his invention. In 1853, Alois Auer, director of the State printing establishment of the Austrian empire, published his process, and also some very beautiful works illustrated by this art. About the same time, in this country, Mr G. W. Aitkin made known his discovery of an exactly similar process, and shewed some very beautiful plates of feathers, ferns, &c. But whatever other claims may be advanced, it is certain that Alois Auer holds undisputed right to the title of original inventor and practical applier of the invention. The process is very simple, as practised by Auer; but it cannot be applied to any objects except those with tolerably flat surfaces, such as dried and pressed plants, embroidery and lace, and a very few animal productions. The object is placed between a plate of copper and another of lead, both worked smooth, and polished; they are drawn through a pair of rollers, under considerable pressure—M. Auer says forty to fifty tons; then, when the plates are separated, it is found that a most beautiful and perfect impression of the object has been made in the leaden plate. This may be used directly as an engraved plate, if only a very few impressions are wanted; but as it is too soft to resist the action of the press for practical purposes, a fac-simile of it is obtained in copper by the electrotype process, which is used as the printing-plate. The best practical use to which nature-printing has yet been applied is the multiplication of patterns of lace and other figured surfaces, either in textile materials or metals, for trade purposes. Lace-prints especially are so exactly like the originals, that the most fastidious can require nothing more; hence the cutting up of valuable pieces of lace for patterns has been saved. The late Mr Henry Bradbury, of the firm of Bradbury and Evans, London, made nature-printing his special study, and produced the exquisite works, *Nature-printed Ferns*, and *Nature-printed Sea-Weeds*, in two vols. each. London: Bradbury and Evans.

NAUMA'CHIA, a Greek word, signifying literally a naval battle, afterwards, among the Romans, a spectacle which consisted in the imitation of a naval battle. Julius Cæsar was the first to introduce a naumachia into Rome, 46 B. C., causing a portion of the Campus Martius to be dug to form a lake, on which the 'spectacle' came off. Augustus made an artificial lake (*stagnum*) near the Tiber for the same purpose, which was afterwards frequently used for naumachia. Claudius also exhibited a splendid one on Lake Fucinus. Nero, Domitian, and others were likewise fond of such amusements. The combatants were termed *Naumacharistæ*; they were for the most part either captives or condemned criminals; and the rival fleets took their names from the famous maritime nations of antiquity: Tyrians and Egyptians, Rhodians and Sicilians, Persians and Athenians, Corcyræans and Corinthians, Athenians and Syracusans. The magnificence of these spectacles may be estimated from the fact, that in the one exhibited on Lake Fucinus, 19,000 men were engaged. These *naumachia* were not *sham-fights*, any more than ordinary gladiatorial combats. Both sides fought on in real earnest for dear life until one was utterly

overpowered; and as a rule, multitudes were 'butchered to make a Roman holiday.'

NAUMBURG, a town of Prussian Saxony, in the government of Merseburg, situated 17 miles south-west of the town of that name, on the Saale, in the midst of a striking amphitheatre of vine-clad hills. Besides its cathedral—a noble Gothic structure, completed in 1249, with two choirs, and containing many beautiful sculptures—there are several other churches. The manufactures are cotton and woollen fabrics, leather, and chemical products. Wine is grown in the vicinity in considerable quantity—116,347 gallons yearly. During the Thirty Years' War, and in the campaigns of 1806 and 1813, N., in which the Prussian magazines were lodged, was a place of great importance. Five annual fairs are held here. Pop. 13,797.

NAUPLIA, a small fortified town and seaport in the Morea, Greece, at the northern extremity of the Gulf of Argos or Nauplia, and 7 miles south-east of the town of Argos. It is laid out in the manner of a European town. Its roadstead is one of the best in Greece. In the Church of St Spiridion, Capo d'Istria was assassinated in 1831. N. is of high antiquity. At an early period it was the port and arsenal of Argos. In the 13th c., it was occupied by the Venetians, and was taken by the Turks in 1540. From 1824 to 1835, it was the capital of Greece, and had a population of upwards of 12,000; but on the removal of the court to Athens, it fell into decay. Pop. about 4000.

NAUSEA is a distressing sensation always referred to the stomach. It is unattended by pain, but is usually accompanied by a feeling of general languor or debility, a small and often irregular pulse, a pale, cool, and moist skin, general muscular relaxation, an increased flow of saliva, and a sensation that vomiting will supervene. It is most commonly a direct symptom of disease or disorder of the stomach, but sometimes it is a very important indirect symptom of disease of some part at a distance from the stomach—as, for example, the brain or the kidney. The nausea which is so troublesome to pregnant women is due to the irritation excited by the enlarged uterus being reflected by nervous agency to the stomach.

NAUTÆ, CAUPONÆ, &c. These words are the commencement of an edict in Roman law, which made shipmasters, innkeepers, and stables liable for the safety of the goods brought into the ship, inn, or stable. The same doctrine is adopted by the common law of England and Scotland, subject to variations produced by the Carriers' Act, and Railway and Canal Traffic Act, so far as regards carriers and railway and canal companies.

NAUTICAL ALMANAC, a work projected for the special behoof of astronomers and navigators. See **ALMANAC**. It is chiefly valuable to the latter class from its containing tables of the 'lunar distances'—i. e., distances of the moon from a few (5 to 7) of the more prominent stars, given for every three hours throughout the year—by which, at the present day, longitudes (see **LATITUDE AND LONGITUDE**) are most conveniently and accurately determined. To the astronomer, the *Nautical Almanac* furnishes a great mass of important data; it gives the position of the moon in right ascension and declination for every hour, and the sun's latitude and longitude for every day in the year; it shews the obliquity of the ecliptic, the sun's and moon's parallax, aberration, &c., at different times; it supplies the necessary data for the determination of the real or apparent size, position, and motion of the planets and their satellites; it fixes accurately the places of about 150 fixed stars, and gives full

details concerning eclipses, occultations, transits, and other celestial phenomena occurring during the year. It is generally issued four years in advance for the sake of mariners going on long voyages.

NAUTILUS, a genus of *tetrabranchiate Cephalopoda* (q. v.), extremely interesting as the existing representatives of an order of molluscs now reduced to a very few species, but of which the fossil remains attest the great abundance in former geological periods. The species of this genus are found only in the seas of warm climates. One or more of them must have been known to Aristotle, as appears from his description, which, however, is not minute. Yet it is but recently that they came under the observation of modern naturalists; and they were very imperfectly known, till a specimen, obtained by Dr Bennett in a bay of the New Hebrides in 1829, was submitted to the examination of Professor Owen, and became the subject of a valuable memoir by him. The shell, indeed, has long been common enough in collections, being plentifully found, entire or in fragments, on many tropical shores; but from the shell alone, little could be learned concerning the animal to which it belonged. The shell is spiral, the spire not at all elevated; and thus, in external form, resembles the shells of many species of snail; but internally, it is *camerated*, or divided into chambers, by transverse curved partitions of shelly matter. In a very young state, this structure does not exist; but as the animal increases in size, it deserts its first habitation, which then becomes an empty chamber, and so proceeds from one to another still larger, occupying the outermost only, but retaining a connection with all by means of a membranous tube (*septacule*) which passes through the centre of each partition. The use of this connection is not known; but the most probable supposition is, that the animal is enabled, by throwing air or some kind of gas into the empty chambers of the shell, or by exhausting them of air, to change the total weight, so that it may rise or sink in the water at pleasure. It commonly inhabits the bottom of the sea, where it creeps about, probably like the gastropods, by means of a large muscular disc with which the head is furnished; but it sometimes rises to the surface, and is to be seen floating there. Dr Bennett states that the specimen which he fortunately captured, attracted his attention when thus floating, as an object resembling a dead tortoise-shell cat. The story of its spreading a sail is as fabulous as the similar story regarding the argonaut. The head and arms can be protruded from the shell, and can also be completely retracted within it. There are numerous arms attached to the head, nineteen in the best known species; there are also numerous other tentacles; but none of these organs are furnished with suckers, and they are feeble in comparison with the corresponding organs of many of the higher or dibranchiate cephalopods. The mouth is of the parrot's bill form, as in the other cephalopods; but the mandibles are not entirely composed of horny matter, their extremities being calcareous and of a hardness apparently adapted for breaking shells. Their edges are also notched, and shew an adaptation for crushing rather than for cutting. The tongue is large. The gizzard is muscular. The food appears to consist, at least in great part, of crustaceans.

Only three species of N. are known, of which the best known and apparently the most abundant, is the **PEARLY N.** (*N. pompilius*), which is found in the Indian and the Pacific Oceans. Its shell is beautifully nacreous within; and is externally porcelain-like, white, and streaked with reddish chestnut. The shell, being large, thick, and strong, is used for a variety of purposes by the natives

NAUVOO—NAVAL RESERVE.

of the East Indies and South Sea Islands; it is also made into ornaments of various kinds in China and elsewhere. The animal is eaten by the Fijians and other South Sea islanders, and is much esteemed as an article of food. The Fijians capture it by means of a basket-trap, somewhat like those used for catching lobsters, baited with boiled crayfish.

The name PAPER N. has sometimes been given to the Argonaut (q. v.).

Fossil Nautilus.—About one hundred and fifty species of fossil shells have been referred to this genus. They occur in all the strata from the Upper Silurian to the most recent deposits. Numerous forms, however, which exhibit very wide differences, have been incongruously associated under this generic name. The paleozoic nautili are so remarkable, that they must certainly be referred to one or more separate genera: some of the carboniferous species have a square back, and the whorls either compact or open in the centre, while the last chamber is more or less disunited from the shell; and the Devonian *Clymenia* has angular sutures and an internal siphuncle. Until a careful revision of this section of the Cephalopoda is made, it will be better to consider the species as belonging to the family *Nautilida*, and not to the genus *Nautilus*.

NAUVOO, a town in Illinois, United States of America, on the east bank of the Mississippi River, 220 miles above St Louis. It was built by the Mormons in 1840, and in 1846 contained a population of 15,000. Its principal feature was a great temple of polished marble, original in style, and imposing in appearance. After the murder of Joseph Smith, the Mormon prophet (see MORMONS), and the expulsion of his followers, the temple was burned. The town was afterwards bought and occupied by a French Socialist community, under the leadership of M. Cabet. This experiment having proved, like others, a failure, the once famous city has been reduced to an inconsiderable village.

NAVAL ARCHITECTURE. See SHIP-BUILDING.

NAVAL CADETS are the youths training for service as naval officers. Every admiral on hoisting his flag may nominate two, every captain one cadet. The boy must be over twelve and under fourteen years of age, and must prove that he has had a fair elementary education. After two years' service, he becomes eligible for Midshipman (q. v.). In time of peace, about 190 cadets are annually required for the navy.

NAVAL CROWN, in Heraldry, a rim of gold round which are placed alternately prows of galleys and square sails. The device is said to have originated with the Roman emperor Claudius, who, after the conquest of Britain, instituted it as a reward for maritime services. He who first boarded the enemy's ship, and was the occasion of its being captured, was entitled to a naval crown. A naval crown supporting the crest in place of a wreath, occurs in various grants of arms in the early part of the present century, to the naval heroes of the late war. The crest of the Earl of



Naval Crown.

St Vincent, bestowed on him after his victory over the Spanish fleet in 1797, is issuing out of a naval crown or, enveloped by a wreath of laurel vert, a demi-pegasus argent maned and hooped of the first and winged azure, charged in the wing with a fleur-de-lis or.

NAVAL RESERVE, ROYAL, is a sort of militia, auxiliary to the royal navy. It is a force held in

high esteem by naval men; and is considered an extremely valuable reserve of trained men ready to man the fleet in case of emergency. The force was instituted in 1859, under the Act 22 and 23 Vict. c. 40. That act authorises the engagement of 30,000 men, each for a period of five years, and provides that each shall be trained, for 28 days in every year, to the use of arms and naval tactics, either in Her Majesty's ships or on shore. In case of national emergency, these men can, by royal proclamation, be called out for service in the navy in any part of the world, for periods not exceeding five years. While training and while called out for actual service, the men receive the same wages as corresponding ratings in the royal navy: in addition, they each receive, as retaining fee, a sum of six pounds for every year in which the regulated training has been completed. On actual service, after three years—whether of uninterrupted service, or at broken intervals—the volunteer becomes entitled to twopence extra per diem. The man can terminate his engagement at the end of five years, unless on actual service, when the Queen may require him to complete five years of such service before discharging him. During the continuance of his engagement, he must not embark on voyages which shall entail a longer absence from the United Kingdom than six months, unless with special permission of the Admiralty. The periods for training are made as far as practicable to suit the sailor's convenience: he may break the 28 days into shorter periods, none being less than seven days. He is drilled as near as practicable to his own home, the drilling being intrusted to the officers of the Coast-guard. While drilling, if on board a Queen's ship, he has the regulation victuals; if billeted on shore, while training for great-gun exercise in batteries, he is allowed 1s. 4d. a day for victuals. It is optional with the volunteer to renew his engagement from time to time, as the respective periods of five years expire; and at about the age of 45, he becomes entitled to a pension of £12 or upwards for the rest of his life, subject to the usual obligation of service in certain circumstances in the navy, which all pensioners are under. This pension may be commuted, if desired, into one of less amount, to last until the death of the longest liver of the volunteer and his wife.

To be eligible for the Royal Naval Reserve, a man must be a British subject, under 35 years of age, in good health, and, within the preceding ten years, must have served at least five years at sea, of which one year shall have been as able seaman. Soldiers, militiamen, and Coast Volunteers are ineligible, and subject to a penalty if they join; but a member of the last force may obtain his discharge therefrom for the purpose of joining the Naval Reserve. Penalties are enacted in case men fail to attend: and failure after proper notice to come up for actual service is held equivalent to desertion. While training or on duty, the men are liable to all the punishments, as they are entitled to all the rights and privileges of regular seamen. The men considered most desirable are (1) those having fixed residences, and personally known to the shipping-master or his deputies; and (2) men having regular employment in the coasting-trade, or in vessels the business of which brings them back to the same ports at frequent and known intervals. In 1864, about 16,000 men belonged to the Naval Reserve, and were in a state of great efficiency.

In 1861, the system of the Reserve was extended—by the Act 24 and 25 Vict. c. 129—to officers of the merchant-service, certificated masters and mates being respectively granted commissions in the Naval Reserve as lieutenants and sub-lieutenants. The

holders are required to train for 28 days annually on board Her Majesty's ships, and are liable to be called out for actual service when required. When training, or on actual service, lieutenants receive 10s., and sub-lieutenants 7s. a day, with all the privileges, pensions for wounds, pensions to widows, uniforms, &c., of naval officers of corresponding rank. The number of these officers allowed by regulation is 130 lieutenants, and 270 sub-lieutenants: of these, in 1864, commissions had been granted to 130 lieutenants and 90 sub-lieutenants. The total cost of the Naval Reserve, officers and men, for the year 1864—1865, is estimated at £204,439.

NAVAN, a market town of Meath County, Ireland, situated at the junction of the Boyne and Blackwater, 28 miles north-west of Dublin, with which city it is connected by the Dublin and Drogheda, and also by the Meath Railway. Pop. (1861) 3855, of whom 3679 were Catholics, 154 Protestants of the established church, and the rest Protestants of other denominations. N. is one of the most ancient boroughs of English foundation in Ireland, and previous to the Union, returned two members to the Irish parliament. It is a place of considerable inland trade, and possesses a flax-mill, several flour-mills, and two paper-mills, besides a tannery, a brewery, and two distilleries. There are also an endowed school, a Roman Catholic seminary (one of the first opened in Ireland after the repeal of the penal law), and three national schools, containing (1861) 944 pupils, of whom 309 were boys, and 635 girls. The girls' school is attached to the Roman Catholic convent.

NAVARI'NO, or Neo-Castro, a seaport and citadel on the south-west coast of the Morea in Greece, contains only 2000 inhabitants, but is of importance from its position, commanding the entrance of the Bay of Navarino, at the southern extremity of which it is situated. On the island of Sphagia or Sphacteria, which closes the bay's mouth, was formerly situated Pylus Messeniaca, the town of Nestor, in a spot where now stands Old Navarino or Palsocastron. The Bay of Navarino was the scene of a great sea-fight between the Athenians under Cleon, and the Spartans (425 B.C.), in which the latter were defeated; and on the 20th October 1827, it saw the annihilation of the Turkish and Egyptian navies by the combined British, French, and Russian fleets under Sir Edward Codrington.

NAVARRE, a province, and formerly a kingdom of Spain, is bounded on the N. by France, on the S. and E. by Aragon, and on the W. by the Biscays; and is situated in 42° 20'—43° 15' N. lat., and 0° 50'—2° 30' W. long. Area about 4000 square miles. Pop. 297,422 (in 1857). The country is mountainous, being bounded and traversed by the Pyrenees, spurs of which occupy almost the whole of the province in its northern and eastern parts. The highest peaks are Altovisear, Adi, Alcorrunz, and Ruña. N. is watered by the Bidassoa, the Anezo, and by the Ebro, together with its tributaries, the Ega and Aragon, on the level shores of which corn, wine, and oil of good quality are produced. Some of the valleys which intersect the mountain-ranges, as those of Roncesvalles, Lescon, Bastan, and Roncal, have a fruitful soil, and yield good crops; but in the mountain districts, husbandry is impracticable, and the inhabitants nearly all follow the chase, as much from necessity as inclination; and while a large number of the Navarrese are soldiers, a still larger proportion are smugglers—the proximity of the province to France, and the dangerous character of the almost inaccessible mountain

passes which alone connect the two countries, holding out many inducements and facilities in the way of smuggling. The mountain forests still harbour bears, wolves, wild-cats, goats, deer, and an abundance of game of every other kind. Iron and salt are the chief mineral products of the district, but these are obtained in sufficient quantities to be exported. The people of N. are a hardy, brave, and hospitable race, loyal to the sovereign, attentive observers of the forms of their religion, and, except in the matter of smuggling, honest and moral; but they are passionate and distrustful, prone to anger, and keen in avenging an insult, real or imaginary. Although not industrious, the people follow a few branches of industry, and manufacture glass, leather, soap, chocolate, &c., of good quality.

The Navarrese, with few exceptions, are members of the church of Rome, to whose tenets they cling with superstitious devotion. They have always intermarried chiefly among their own compatriots, and are a nearly pure Basque race. In the mountainous districts, Basque is still spoken, but in the plains, the modern Castilian form of Spanish is rapidly supplanting the ancient language of the country. The chief town is Pamplona (q. v.).

The territory known from an early period of Spanish history under the name of N., was occupied in ancient times by the Vascones, who were subdued by the Goths in the 5th century. After having become gradually amalgamated with their conquerors, the people continued to enjoy a species of turbulent independence under military leaders until the 8th c., when they were almost annihilated by the hordes of Arabs who were rapidly spreading their dominion to all parts of the peninsula. The Gothic Vascones of N., who had been converted to Christianity, offered a gallant resistance to their infidel invaders, and although repeatedly beaten, they were not wholly subdued. The remnant which escaped the sword of their Moslem enemies took refuge in the fastnesses of the mountains, and choosing a knight of their number, Garcia Ximenes, as their leader or king, they sallied forth, and by their gallant resistance, compelled the Arabs to leave them in the enjoyment of an independence greater than that of the neighbouring states. On the extinction of the race of Ximenes, in the middle of the 9th c., the Navarrese elected as their king Inigo Sanchez, Count of Bigorre, in whose family the succession remained till the marriage of Philip the Fair with Queen Joanna I. of N.; and the accession of the former to the throne of France in 1285, rendered N. an appanage of the crown of France. It continued a part of that kingdom during the successive reigns of Louis X., Philip V., and Charles the Fair; but on the death of this last in 1328, France fell to the family of Valois, and the daughter of Louis X., the rightful heir, succeeded to N. as Joanna II. The events of the kingdom present no features of interest during the next hundred years. The marriage of Blanche, daughter of Charles III. of N., with John II. of Aragon, in 1442, did not produce an annexation of N. to Aragon, as John suffered his wife to rule her own kingdom as she pleased, and even after her death and his subsequent re-marriage, he resigned the government entirely to his son by Blanche. This son, known as Charles, Prince of Viano, having attempted to remain neutral in his father's quarrels with Castile, John expelled him and his elder sister Blanche, who sided with him, from N., and conferred the kingdom on Leonora Countess de Foix, his younger daughter, by Blanche, whose marriage completed the disorganisation which these family quarrels had commenced. Her son, Francis, called Phebus, from his beauty, succeeded in 1479, and his sister Catherine

in 1483. Ferdinand and Isabella sought to marry the young queen to their son and heir, the Prince of Asturias, but her mother, a French princess, married her to Jean d'Albret. Ferdinand, however, was not willing to let the prize escape him, and on some slight pretext he seized N. in 1512. After this act of spoliation, there remained nothing of ancient N. beyond a small territory on the northern side of the Pyrenees, which was subsequently united to the crown of France by Henri IV. of Bourbon, King of N., whose mother, Jeanne d'Albret, was granddaughter of Queen Catharine; and hence the history of N. ends with his accession to the French throne in 1589. The Navarrese were, however, permitted to retain many of their ancient municipal charters and constitutional privileges, after their incorporation with the other domains of the Spanish crown, and these prerogatives were not taken from them till the reign of the present queen, when the active aid which they had furnished to the Pretender, Don Carlos, drew upon them the ill-will of the government, and led, at the close of the Carlist war, to the abrogation of their *fueros*, or national assemblies, and to the amalgamation of their nationality with that of the kingdom at large.

NAVE. See CHURCH.

NA'VEW (Fr. *Navette*), a garden vegetable, much cultivated in France and other parts of the continent of Europe, although little used in Britain. It is by some botanists regarded as a cultivated variety of *Brassica napus*, or Rape (q. v.), whilst others refer it to *B. campestris*, sometimes therefore called Wild N., the species which is also supposed to be the original of the Swedish Turnip (q. v.). The part used is the swollen root, as in the turnip, but it is rather like a carrot in shape. Its colour is white. Its flavour is much stronger than that of the turnip. It succeeds in any soil, but is of best quality in a dry light soil. The seed is sown in spring, and the plants thinned out to five inches apart.

NAVICULA (Lat. a little ship), a genus of *Diatomaceæ* (q. v.), receiving its name from the resemblance of its form to that of a boat. Some of the species are very common.

NAVICULAR DISEASE, in the Horse, consists in strain of the strong flexor tendon of the foot, at the point within the hollow of the fetlock, where it passes over the navicular bone. It is most common amongst the lighter sorts of horses, and especially where they have upright pasterns, out-turned toes, and early severe work on hard roads. It soon gives rise to a short tripping yet cautious gait, undue wear of the toe of the shoe, wasting of the muscles of the shoulder, and projecting or 'pointing' of the affected limb whilst standing. When early noticed, and in horses with well-formed legs, it is often curable; but when of several weeks' standing, it leads to so much inflammation and destruction of the tendon and adjoining parts, that soundness and fitness for fast work are again impossible. Rest should at once be given, the shoe removed, the toe shortened, and the foot placed in a large, soft, hot poultice, changed every few hours. Laxative medicine and bran mashes should be ordered, and a soft bed made with old short litter. After a few days, and when the heat and tenderness abate, cold applications should supersede the hot; and, after another week, a blister may be applied round the coronet, and the animal placed for two months in a good yard or in a grass field, if the ground be soft and moist; or, if sufficiently strong, at slow farm-work on soft land. Division of the nerve going to the foot removes sensation, and consequently lameness; and

hence is useful in relieving animals intended for breeding purposes or for slow work. The operation, however, is not to be recommended where fast work is required; for the animal, insensible to pain, uses the limb as if nothing were amiss, and the disease rapidly becomes worse.

NAVIES, ANCIENT AND MEDIEVAL. The ancient method of naval warfare consisted, in great part, in the driving of *beaked* vessels against each other; and therefore skill and celerity in manœuvring, so as to strike the enemy at the greatest disadvantage, were of the utmost importance. The victory thus usually remained with the best sailor. This mode of conflict has been attempted to be revived at the present time, and vessels called 'steam-rams' are specially constructed for this species of conflict. The earliest powers having efficient fleets appear to have been the Phœnicians, Carthaginians, Persians, and Greeks; the Greeks had fleets as early as the beginning of the 7th c. B. C.—the first sea-fight on record being that between the Corinthians and their colonists of Corcyra, 664 B. C. The earliest great battle in which tactics appear to have distinctly been opposed to superior force, and with success, was that of Salamis (480 B. C.), where Themistocles, taking advantage of the narrows, forced the Persian fleet of Xerxes to combat in such a manner, that their line of battle but little exceeded in length the line of the much inferior Athenian fleet. The Peloponnesian War, where 'Greek met Greek,' tended much to develop the art of naval warfare. But the destruction of the Athenian marine power in the Syracusan expedition of 414 B. C., left Carthage mistress of the Mediterranean. The Roman power, however, gradually asserted itself, and after two centuries, became omnipotent by the destruction of Carthage. For several following centuries, the only sea-fights were occasioned by the civil wars of the Romans. Towards the close of the empire, the system of fighting with pointed prows had been discontinued in favour of that which had always co-existed—viz., the running alongside, and boarding by armed men, with whom each vessel was overloaded. Onagers, ballistæ, &c. were ultimately carried in the ships, and used as artillery; but they were little relied on, and it was usual, after a discharge of arrows and javelins, to come to close quarters. A sea-fight was therefore a hand-to-hand struggle on a floating base, in which the vanquished were almost certainly drowned or slain.

The northern invaders of the empire, and subsequently the Moors, seem to have introduced swift-sailing galleys, warring in small squadrons and singly, and ravaging all civilised coasts for plunder and slaves. This—the break-up of the empire—was the era of piracy, when every nation, which had more to win than lose by freebooting, sent out its cruisers. Foremost for daring and seamanship were the Norsemen, who penetrated in every direction from the Bosphorus to Newfoundland. Combination being the only security against these marauders, the medieval navies gradually sprang up; the most conspicuous being—in the Mediterranean, those of Venice, Genoa, Pisa, Aragon; on the Atlantic sea-board, England and France. In the Mediterranean, Venice, after a long struggle with the Genoese, and subsequently with the Turks, became the great naval power. The Aragonese fleet gradually developed into the Spanish navy, which, by the epoch of Columbus, had a rival in that of Portugal. Many struggles left, in the 16th and 17th centuries, the principal naval power in the hands of the English, French, Dutch, Spaniards, and Portuguese. The present state of these and other existing navies will be briefly given under NAVIES, MODERN.

NAVIES—NAVIGATION.

NAVIES, MODERN. Dating the modern navies of the world from the 16th c., we find the British navy rising from insignificance by the destruction of the Spanish Armada in 1588; a blow which Spain never recovered, and which the Dutch, whose naval force had acquired tremendous strength in their struggle for independence, increased the weight of, by their triumph in 1607, in the Bay of Gibraltar. At this time, there was no decisive superiority of the fleet of England over that of France; but each was inferior to the Dutch navy. The Commonwealth and reign of Charles II were signalised by the struggle for mastery between the English and Dutch; when victory, after many alternations, finally sided with the former. Through the 18th c., the English and French were the principal fleets; but Louis XVI gave a decided superiority to the navy of France; and at the period of the American War, the naval power of England was seriously threatened. Spain, Holland, and Russia (now for the first time a naval power) had meanwhile acquired considerable fleets; and the 'armed neutrality,' to which the northern powers gave their adherence, rendered the British position most critical. However, the slowly roused energy of her

government, the invincible courage of her seamen, and the genius of her admirals, brought Britain through all her trials. Camperdown broke the Dutch power; many battles weakened the French navy; and at Trafalgar, in 1805, it, with the Spanish power, was swept from the ocean. The United States had in the meantime augmented their fleet, and in the war of 1812—1814, maintained a glorious struggle; but their navy is distinguished rather for the power of its individual ships than for the number of vessels. The growth, in recent times, of the British navy will be found under **NAVY, BRITISH**. The Emperor Napoleon III has greatly enlarged and improved the French navy, which is now not very inferior to that of England. During the American War of Secession, a vast fleet of gun-boats, 'monitors,' and iron-clad vessels of all classes, has been created; but the ships appear chiefly adapted for river and coast service.

The following table, showing the principal naval statistics of the several countries, is compiled from the latest returns; but these returns are made in such varying forms, and are so incomplete in some cases, that comparison is difficult:

NAVIES OF THE WORLD, 1864.

Country.	Armour-plated Vessels.		Effective Line of Battle Ships.		Effective Frigates.		Effective Smaller Vessels.		Total Guns.	Total Men.	Approximate Total Cost.
	Ready.	Building.	Steam.	Sailing.	Steam.	Sailing.	Steam.	Sailing.			
America, United States of, . . .	54		...	6	9	6	200	92	3308	40,000	\$12,650,000
Austria, . . .	5	2	1	...	5	2	53	49	1084	13,991	1,170,000
Brazil,	1	22	15	241,940
Chili,	1	4	4	...	29	753	...
Denmark, . . .	3	1	1	2	5	4	21	28	929
France, . . .	19	24	26	6	48	24	234	75	9765	40,765	6,629,980
Great Britain, . . .	23	12	62	9	81	19	371	71	2500	71,260	10,422,210
Greece,	1	...	7	24	154	1,225	...
Haiti,	3	4
Italy, . . .	5	8	1	...	4	3	70	14	1023	18,000	3,229,592
Netherlands, . . .	6	2	5	7	53	72	1720	9,008	699,124
Peru,	1	...	6	10	84	2,000	...
Portugal,	1	...	1	12	21	295	2,267	252,250
Prussia,	3	31	45	221	...	240,000
Russia, . . .	3	...	9	9	20	5	217	48	2291	52,751	2,224,767
Spain,	1	2	18	3	106	87	...	23,572	1,636,225
Sweden and Norway,	2	6	2	7	24	355	2609	...	421,022
Turkey,	1	2	6	5	7	11	17	1212	24,000	790,200
" Egypt,	1	6	4	2	6	30
Venezuela,	2	4

NAVIGATION, HISTORY OF. In its widest sense, this subject is divisible into three sections—the history of the progressive improvement in the construction of ships, the history of the growth of naval powers, and the history of the gradual spread and increase of the science of navigation. Although these three sections are to some extent interwoven, the present article will be limited to a consideration of the last, the first two being sufficiently described under **SHIP-BUILDING**, and **NAVIES**.

The first use of ships, as distinguished from boats, appears to have been by the early Egyptians, who are believed to have reached the western coast of India, besides navigating the Mediterranean. Little, however, is known of their prowess on the waves; and, whatever it may have been, they were soon eclipsed by the citizens of Tyre, who, to make amends for the unproductiveness of their strip of territory, laid the seas under tribute, and made their city the great emporium of Eastern and European trade. They spread their merchant fleets throughout the Mediterranean, navigated Solomon's squadrons

to the Persian Gulf and Indian Ocean, and planted colonies everywhere. Principal among these colonies was Carthage, which soon outshone the parent state in its maritime daring. The Carthaginian fleets passed the Pillars of Hercules, and, with no better guide than the stars, are believed to have spread northward to the British Isles, and southward for some distance along the west coast of Africa. From the 6th to the 4th centuries B.C., the Greek states gradually developed the art of navigation, and at the time of the Peloponnesian war, the Athenians appear to have been skilful tacticians, capable of concerted manœuvres. The Greeks, however, were rather warlike than commercial in their nautical affairs. In the 4th c. B.C., Alexander destroyed the Tyrian power, transferring its commerce to Alexandria, which, having an admirable harbour, became the centre of trade for the ancient world, and far surpassed in the magnitude of its marine transactions any city which had yet existed. Rome next wrested from Carthage its naval power, and took its vast trade into the hands of the Italian

sailors. After the battle of Actium, Egypt became a Roman province, and Augustus was master of the enormous commerce both of the Roman and the Alexandrian merchants. During all this period, the size of the vessels had been continually increasing, but probably the form was that of the galley, still common in the Mediterranean, though a more clumsy craft than now. Sails were known, and some knowledge was evinced even of beating up against a foul wind; but oars were the great motive-power; speed was not thought of, a voyage from the Levant to Italy being the work of a season; and so little confidence had the sailors in their skill or in the stability of their ships (still steered by two oars projecting from the stern), that it was customary to haul the vessels up on shore when winter set in. During the empire, no great progress seems to have been made, except in the size of the vessels; but regular fleets were maintained, both in the Mediterranean and on the coast of Gaul, for the protection of commerce. Meanwhile the barbarian nations of the north were advancing in quite a different school. The Saxon, Jutiah, and Norse prows began to roam the ocean in every direction; in small vessels, they trusted more to the winds than to oars, and, sailing singly, gradually acquired that hardihood and daring which ultimately rendered them masters of the sea. The Britons were no mean seamen, and when Carausius assumed the purple in their island, he was able, for several years, by his fleets alone to maintain his independence against all the power of Rome.

The art of navigation became almost extinct in the Mediterranean with the fall of the empire; but the barbarous conquerors soon perceived its value, and revived its practice with the addition of new inventions suggested by their own energy. The islanders of Venice, the Genoese, and the Pisans, were the carriers of that great inland sea. Their merchants traded to the furthest Indies, and their markets became the exchanges for the produce of the world. Vast fleets of merchant galleys from these flourishing republics dared the storm, while their constant rivalries gave occasion for the growth of naval tactics. So rich a commerce tempted piracy, and the Moorish corsairs penetrated everywhere on both sides of the straits of Gibraltar in quest of prey; evincing not less skill and nautical audacity than savage fury and inhuman cruelty. But the Atlantic powers, taught in stormy seas, were rearing a naval might that should out rival all other pretenders. The Norsemen extended their voyages to Iceland, Greenland, and Newfoundland, while they first ravaged and then colonised the coasts of Britain, France, and Sicily. The sea had no terrors for these hardy rovers; their exploits are imperishably recorded in the Icelandic Sagas, and in the numerous islands and promontories to which they have given names.

Early in the 15th c., the introduction of the mariner's compass rendered the seaman independent of sun and stars—an incalculable gain, as was soon shewn in the ocean-voyages of Columbus, Cabot, and others. In 1492, Columbus rendered navigation more secure by the discovery of the variation of the compass. Between that and 1514, the 'cross-staff' began to be used; a rude instrument for ascertaining the angle between the moon and a fixed star, with the consequent longitude. Early in the 16th c., tables of declination and ascension became common. In 1537, Nuñez (Nonius), a Portuguese, invented various methods of computing the rhumb-lines and sailing on the great circle. In 1545, the two first treatises on systematic navigation appeared in Spain, one by Pedro de Medina, the other by Martín Cortes. These works were speedily trans-

lated into French, Dutch, English, &c., and for many years served as the text-books of practical navigation. Towards the end of the century, Bourne in England, and Stevin in Holland, improved the astronomical portion of the art, while the introduction of time-pieces and the Log (q. v.) rendered the computation of distance more easy.

It would be tedious to enumerate the successive improvements by which the science of navigation has been brought to its present high perfection; but as conspicuous points in the history of the art, the following stand out: The invention of Mercator's chart in 1569; the formation by Wright of tables of meridional parts, 1597; Davis's quadrant, about 1600; the application of logarithms to nautical calculations, 1620, by Edmund Gunter; the introduction of middle-latitude sailing in 1623; the measure of a degree on the meridian, by Richard Norwood, in 1631. Hadley's quadrant, a century later, rendered observations easier and more accurate; while Harrison's chronometers (1764), rendered the computation of longitude a matter of comparatively small difficulty. Wright, Bond, and Norwood were the authors of scientific navigation, and their science is now made available in practice by means of the *Nautical Almanac*, published annually by the British Admiralty. The more important points of the science of navigation are noticed under such heads as DEAD-RECKONING, LATITUDE AND LONGITUDE, GREAT-CIRCLE SAILING, SAILINGS, &c.

NAVIGATION, LAWS AS TO. By the law of nature and of nations, the navigation of the open sea is free to all the world. The open sea means all the main seas and oceans beyond three miles from land. The sea within three miles from land is called the territorial sea, and each state has a kind of property in such sea, and has a right to regulate the use thereof. Hence, it was natural that in early times, before the laws of commerce were properly understood, each state should endeavour to exclude foreigners from that part of the sea so as to secure to its own subjects the benefits of the carriage of goods in ships, which has always been an increasing source of wealth. In England, however, as in most countries, the first care seems to have been bestowed on the navy, as the great means of defending the realm against enemies, and trading-ships came to be first subject to statutory regulation only as being in some way ancillary to the interests of the navy. The laws of Oleron were the first code of maritime laws which obtained notice as well as general acceptance in Europe, in the time of Edward I., and the authorship of those laws is claimed by Selden and Blackstone for Edward I., though the point is disputed by the French writers. By a statute of Richard II., in order to augment the navy of England, it was ordained that none of the lieges should ship any merchandise out of the realm except in native ships, though the statute was soon varied and seldom followed. At length, in 1650, an act was passed with a view to stop the gainful trade of the Dutch. It prohibited all ships of foreign nations from trading with any English plantation without a licence from the Council of State. In 1651, the prohibition was extended to the mother-country, and no goods were suffered to be imported into England or any of its dependencies in any other than English bottoms, or in the ships of that European nation of which the merchandise was the genuine growth or manufacture. At the Restoration, these enactments were repeated and continued by the Navigation Act (12 Char. II. c. 18), with the further addition, that the master and three-fourths of the mariners should also be British subjects. The object of this act was to encourage British shipping, and was long believed to be wise and

salutary. Adam Smith, however, had the sagacity to see that the act was not favourable to foreign commerce or to opulence, and it was only on the ground that defence was more important than opulence, that he said it was 'perhaps the wisest of all the commercial regulations of England.' In 1826, the statute 4 Geo. IV. c. 41 repealed the Navigation Act, and established a new system of regulations, which were further varied by subsequent statutes, till, under the influence of the free-trade doctrines, new statutes were passed, which reversed the ancient policy. By the law, as now altered, foreign vessels are allowed free commercial intercourse and equality with the ships of this country and its dependencies, except as regards the coasting-trade of the British possessions in Asia, Africa, and America, for the coasting-trade of the United Kingdom is now entirely thrown open to all comers. The advantages of equality and free trade are, however, so far qualified, that in the case of the ships of those nations which do not concede to British ships like privileges, prohibitions and restrictions may be imposed by order in council.

As regards those laws of navigation which affect the property and management of ships, a complete code of regulations is contained in the Merchant Shipping Acts, which are 17 and 18 Vict. c. 104, 18 and 19 Vict. c. 91, 25 and 26 Vict. c. 63. It will be necessary only to indicate the leading divisions of this subject. 1. As to ownership, registration, and transfer of merchant-ships. No ship is deemed a British ship unless she belong wholly to natural-born subjects, denizens, naturalised persons, or bodies corporate, having a place of business in the United Kingdom or some British possession. Every British ship, with a few exceptions as to old ships and small vessels, must be registered, otherwise, it is not entitled to the protection of the British flag. The Commissioners of Customs indicate at what port in the United Kingdom ships may be registered by their officers, and when registered, the ship is held to belong to that port. The name of the ship and its owners must be stated; and as regards joint-ownership, a ship is capable only of being subdivided into sixty-four shares, and not more than thirty-two owners shall own one ship. These registered owners are deemed the legal owners, and so long as the register is unchanged, the ship is held still to belong to them. The only way of transferring the property is by a bill of sale under seal; or if a mortgage is made, it must be made in a particular form, and duly registered, and the priority of title as between several mortgages is regulated by the date of the entry in the register. 2. As regards the laws concerning merchant seamen, there is established in every such seaport a superintendent, whose business it is to afford facilities for engaging seamen, by keeping registers of seamen and superintending the making and discharging of contracts. No person is allowed to be employed in a foreign-going ship as master, or as first, or second, or only mate, or in a home-trade passenger-ship as master, or first or only mate, unless he has a certificate of competency or a certificate of service, issued by the Board of Trade only to those who are deemed entitled thereto. The master of every ship above 80 tons burden shall enter into an agreement, of a certain form, with every seaman he carries from the United Kingdom, and in which the names of the seamen, wages, provisions, capacity of service, &c., are set forth. The seamen are not to lose their wages though no freight is earned, or the ship lost. The men are also to have a berth of a certain size, and the ship to be supplied with medicines, log-book, &c. In order to secure general information, every master of a foreign-going ship is bound, within 48 hours after

arriving at the final port of destination in the United Kingdom, to give in a list with full particulars to the local superintendent of the Mercantile Marine Office. 3. As regards the liability of ship-owners for loss or damage, it is provided by statute, that no owner of a sea-going ship shall be liable to make good any loss or damage occurring without his actual fault or privity, to goods or things on board, by reason of fire on board the ship; or to any gold, silver, diamonds, watches, jewels, or precious stones on board, by reason of robbery or embezzlement, unless the true nature and value of such articles have been inserted in the bill of lading. And in cases where loss to goods occurs without his actual fault or privity, the owner shall not be liable in damages to an aggregate amount exceeding £8 per ton of the ship's tonnage. In case of loss of life or personal injury caused by mismanagement of the ship, but without the actual fault or privity of the owners, they shall not be liable beyond £15 per ton. In case of accidents, whereby a large number of persons have been killed or injured, and to prevent a multiplicity of actions, the sheriff of the county is to empanel a jury, and inquire into the question of liability. If the owners are found liable, then £30 is to be assessed as the damages for each case of death or personal injury. In case of death, such sum is to be paid to the husband, wife, parent, or child of the deceased. If any person consider this is not sufficient damages, then, on returning such sum, he may commence an action; but unless he recover double that sum, he must pay the costs. See also PILOTS and LIGHT-HOUSES.

NAVIGATORS' or SAMO'AN ISLANDS, a group of nine islands, with some islets, in the Pacific Ocean, lying north of the Friendly Islands, in lat. 13° 30'—14° 30' S. and long. 168°—173° W. The four principal islands of the group are Mauna, Tutuila, Upolu, and Savaii. Of these, Savaii, 40 miles in length by 20 miles broad, and having a population of 20,000, is the largest. Area of the group estimated at 2650 square miles; population about 56,000. With the exception of one (Rose Island), the N. I. are all of volcanic origin. For the most part they are lofty, and broken and rugged in appearance, rising in some cases to upwards of 2500 feet in height, and covered with the richest vegetation. The soil, formed chiefly by the decomposition of volcanic rock, is rich, and the climate is moist. The forests, which include the bread-fruit, the cocoa-nut, banana and palm trees, are remarkably thick. The orange, lemon, tacca (from which a kind of sago is made), coffee, sweet potatoes, pine-apples, yams, nutmeg, wild sugar-cane, and many other important plants, grow luxuriantly. Until recently, when swine, horned cattle, and horses were introduced, there were no traces among these islands of any native mammalia except a species of bat. The natives are well formed (especially the males), ingenious, and affectionate. The women, who superintend the indoor work and manufacture mats, are held in high respect. There are English and American mission stations on the islands, as well as several Roman Catholic establishments, and many of the natives have embraced Christianity. The government is that of the hereditary chiefs; the supreme power resting in the hands of a certain body of chiefs, called the Molo, or 'conquering party.' Trade is carried on with Sydney.

NAVY, BRITISH. Owing to the insular position of Great Britain, her navy has long been considered a matter of vital importance, and is the service in which every inhabitant takes a peculiar pride. In

considering the history of the British navy, it is convenient to divide the subject into *matériel* and *personnel*. The latter had no distinct organisation till the time of Henry VIII.; but of the former, we recognise in the earliest times the germ of subsequent glories. Carausius, a Roman general who had thrown off his dependence on the empire, maintained himself in England for several years by his fleet, with which he prevented the imperial forces from reaching the island. The Saxons brought maritime prowess with them to the British shores, but appear soon to have lost it amid the rich provinces in which they settled. Some organisation for the defence of the coast was, however, maintained, and Alfred the Great availed himself of it to repulse the Danes; he at the same time raised the efficiency of his navy by increasing the size of his galleys, some being built which were capable of being rowed by thirty pair of oars. Under his successors, the number of vessels increased, and both Edward and Athelstan fought many naval battles with the Danes. Edgar aspired to be lord of all the northern seas, and had from three to five thousand galleys, divided into three fleets on the western, southern, and eastern coasts respectively; but the size of most of these ships was very insignificant, and the greater part were probably mere row-boats. Ethelred II. formed a sort of naval militia, enacting that every owner of 310 hydes of land should build and furnish one vessel for the service of his country.

William the Conqueror established the Cinque Ports, with important privileges, in return for which they were bound to have at the service of the crown for 15 days in any emergency, 52 ships carrying 24 men each. Richard I. took 100 large ships and 50 galleys to Palestine. John claimed the sovereignty of the seas, and required all foreigners to strike to the English flag; a pretension which has been the cause of some bloody battles, but which England proudly upheld in all dangers. (This honour was formally yielded by the Dutch in 1673, and the French in 1704; and, although not now exacted in its fulness, the remembrance of the right survives in requiring foreign vessels to salute *first*.) In the same king's reign, a great naval engagement with the French took place (1293) in mid-channel, when 250 French vessels were captured. The Edwards and the Henries maintained the glory of the British flag;

had 'grete shippes, carrakes, barges, and ballyngers;' and at one time collected vessels enough to transport 25,000 men into Normandy. Henry VII. was the first monarch who maintained a fleet during peace; he built the *Great Harry*, which was the earliest war-vessel of any size, and which was burned at Woolwich in 1553.

To Henry VIII., however, belongs the honour of having laid the foundation of the British navy as a distinct service. Besides building several large vessels, of which the *Henry Grace de Dieu*, of 72 guns, 700 men, and probably about 1000 tons, was the most considerable, he constituted a permanent personnel, defining the pay of admirals, vice-admirals, captains, and seamen. He also established royal dockyards at Deptford, Woolwich, and Portsmouth; and for the government of the whole service, instituted an Admiralty and Navy Board, the latter being the forerunner of the present Trinity Board. When this king died, he left 50 ships of various sizes, manned by about 8000 hands.

Under Edward VI., the navy fell off, but was sufficiently important in the succeeding reign for the English admiral to exact the salute to his flag from Philip II. with a larger Spanish fleet, when the latter was on his way to espouse Queen Mary. Elizabeth had the struggle with the Spanish Armada to try her navy, and left 42 ships, of 17,000 tons in all, and 8346 men—15 of her ships being upwards of 600 tons. From this period the tonnage of the ships steadily increased. Under James I. and Charles I., Mr Phineas Pett, M.A., the first scientific naval architect, remodelled the navy, abolishing the lofty forecastles and poops, which had made earlier ships resemble Chinese junks. In 1610, he laid down the *Prince-Royal*, a two-decker, carrying 64 large guns; and in 1637, from Woolwich, he launched the celebrated *Sovereign of the Seas*, the first three-decker, and certainly the largest ship hitherto constructed on modern principles. She was 232 feet in length, of 1637 tons, and carried at first 130 pieces of cannon; but being found unwieldy, was cut down, and then proved an excellent ship. She was burned in 1696.

Prince Rupert's devotion to the crown was had for the navy, for he carried off 25 large ships; and Cromwell, on acceding to power, had but 14 two-deckers. His energy, however, soon wrought a change, and in five years he had 150 ships, of which a third were of the line; his crews amounted to 20,000 men. During the Protectorate, Peter Pett, son of Phineas, built the *Constant Warwick*, the earliest British frigate, from a French design and pattern. Cromwell first laid navy estimates before parliament, and obtained £400,000 a year for the service. The Duke of York, afterwards James II., assisted by the indefatigable Mr Samuel Pepys, did much for the navy, establishing the system of Admiralty government much on its present footing. In his time, Sir Anthony Deane improved the model of ships of war, again after a French design. James left, in 1688, 108 ships of the line, and 65 other vessels; the total tonnage of the navy, 101,892 tons; the armament, 6930 guns; and the personnel, 42,000 men. William III. sedulously augmented the force, foreseeing its importance to his adopted country. When he died, there were 272 ships of 159,020 tons, and the annual charge for the navy had risen to £1,056,915. George II. paid much attention to his fleets, and greatly augmented the size of the ships; he left, in 1760, 412 ships of 321,104 tons. By 1782, the navy had risen to 617 sail of 500,000 tons; and by 1802, to 700 sail, of which 148 were of the line. In 1813, there were 1000 ships (256 of the line), measuring about 900,000 tons, and carrying 146,000 seamen and



The Great Harry.

Edward III., in person, with the Black Prince, at the battle of Sluys, in 1340, defeated a greatly superior French fleet, with 40,000 men on board. Henry V.

NAVY—NAZARETH.

marines, at an annual charge of about £18,000,000. Since the peace in 1815, the number of vessels has been greatly diminished, although their power has vastly increased.

The progressive augmentation of size in vessels may be judged from the increase in first-rates. In 1677, the largest vessel was from 1500 to 1600 tons; by 1720, 1800 had been reached; by 1745, 2000 tons; 1780, 2200 tons; 1795, 2350 tons; 1800, 2500 tons; 1808, 2616 tons; 1853, 4000 tons. From 1841, a gradual substitution of steam for sailing vessels began, which was not completed, however, till 1859. Since 1860, another reconstruction is in



The Warrior Iron-clad Screw Steam War-ship.

course of taking effect, iron-sided or armour-plated frigates, impervious to ordinary shot, being substituted for timber-vessels. At the same time, three and two deckers are ceasing to be employed, enormous frigates replacing them of a tonnage far exceeding the largest three-deckers of former times; they mount fewer guns, but those they carry are of stupendous calibre, and of rifled bore. The *Northumberland*, one of the largest frigates of this new class, is of 6621 tons, 1350 horse-power, and 38 large guns.

On the 1st of February 1864, the effective vessels of the navy were as follows: 16 armour-plated frigates (6 building); 2 turret or cupola vessels (both building); 3 armour-plated corvettes



The Duke of Wellington Line of Battle Screw Steam-ship, 131 guns.

(1 building), and 4 sloops (3 building); floating-batteries, 7; 70 ships of the line (3 building, and 2 without steam); 67 frigates (4 building, and 12

without steam); 28 corvettes (2 building); 70 sloops (3 building, and 6 without steam); 69 smaller steamers (1 building); 270 gun and mortar vessels (11 building, and 65 without steam); with 16 transports and 8 yachts, giving a total of 623 vessels. In 1863, 155 vessels were at sea, 97 on harbour and home service; 75 were employed in the coast-guard, or as tenders and cruisers. The personnel of the navy amounts, for 1864, to 71,950 men, including 18,000 marines, but excluding artificers and labourers in dockyards; the armament being about 9500 guns, mostly of heavy calibre. The annual charge for the year 1864—1865 is estimated at £10,432,610, which may be thus broadly subdivided:

Wages, Victuals, and Clothing of Officers and Men,	\$4,178,766
Admiralty Office,	168,005
Coast-guard, Coast Volunteers, and Naval Reserve,	300,718
Scientific Branch (Surveying, Hydrography, &c.),	71,376
Dockyards and Victualling Yards,	1,574,761
Stores for Building and Repairing Ships,	1,826,313
Miscellaneous Services,	615,968
Half-pay and Pensions,	1,281,974
Conveyance of Troops,	314,230
	£10,432,610

Information on the various points of detail connected with the navy, will be found under the respective heads, as ADMIRAL, CAPTAIN, HALF-PAY, SHIP-BUILDING, SIGNALS, &c.

NA'XOS, the largest, most beautiful, and most fertile of the Cyclades, is situated in the *Ægean*, midway between the coasts of Greece and Asia Minor. Extreme length, about 20 miles; breadth, 15 miles. Pop. about 20,000. The shores are steep, and the island is traversed by a ridge of mountains, which rise in the highest summit, *Dis*, upwards of 3000 feet. The plains and valleys are well watered; the principal products and articles of export are wine, corn, oil, cotton, fruits, and emery. The wine of *N.* (the best variety of which is still called in the islands of the *Ægean*, *Bacchus-wine*) was famous in ancient as it is in modern times, and on this account the island was celebrated in the legends of *Dionysius*, and especially in those relating to *Ariadne*. Among its antiquities are a curious Hellenic tower, and an unfinished colossal figure, 34 feet long, still lying in an ancient marble quarry in the north of the island, and always called by the natives a figure of *Apollo*. It was ravaged by the Persians, 490 *B.C.*, and after the conquest of Constantinople by the Latins, became the seat of a dukedom, founded by the Venetians. It now forms a portion of the kingdom of Greece (*q. v.*). *Naxos*, the capital, with a population of about 5000, is situated on the north-west coast, contains 16 Greek, and 4 Catholic churches, and 3 convents, and is the seat of a Greek and a Latin bishop. Its citadel was built by the Venetian duke, *Marco Sanudo*.

NAZARENE (*Gr. Nazarenos* and *Nazaraios*, an 'inhabitant of Nazareth') was used by the Jews as one of the designations of our Lord, and afterwards became a common appellation of the early Christians in *Judæa*. Although, originally, it is but a local appellation, there can be no doubt that as Nazareth was but a second-rate city of the despised province of *Galilee*, it was eventually applied to our Lord and his followers as a name of contempt (*John xviii. 5, 7; Acts xxiv. 5*).

NA'ZARETH, a small town or village of Palestine, anciently in the district of *Galilee*, and in the territory of the tribe of *Zebulun*, 21 miles south-east of *Acra*. It lies in a hilly tract of country, and is built partly on the sides of some rocky ridges, partly in some of the ravines by which they are seamed. It is celebrated as the scene of the *Annunciation*, and the place where the Saviour

spent the greater part of his life in obscure labour. Pop., according to Dr Robinson, 3120, of whom 1040 are Greeks, 520 Greek Catholics, 490 Latins, 400 Maronites, and 690 Mohammedans. Porter thinks 4000 a moderate estimate. In the earliest ages of Christianity, N. was quite overlooked by the church. It did not contain a single Christian resident before the time of Constantine, and the first Christian pilgrimage to it took place in the 6th century. The principal building is the Latin convent, reared, according to pious tradition, on the spot where the angel announced to the Virgin the birth of her Saviour-son; but the Greeks have also erected, in another part of N., a church on the scene of the Annunciation. Besides these rival edifices, the traveller is shewn a Latin chapel, affirmed to be built over the 'workshop of Joseph,' also the chapel of 'the Table of Christ' (*Mensa Christi*), a vaulted chamber, containing the veritable table at which our Lord and his disciples used to eat; the synagogue, out of which he was thrust by his townsmen; and 'the Mount of Precipitation,' down which he narrowly escaped being cast headlong. The women of the village have been long famous for their beauty.

NAZARITES (from Heb. *nazar*, to separate) denoted among the Jews those persons, male or female, who had consecrated themselves to God by certain acts of abstinence, which marked them off, or 'separated' them, from the rest of the community. In particular, they were prohibited from using wine or strong drink of any kind, grapes, whether moist or dry, or from shaving their heads. The law in regard to N. is laid down in the Book of Numbers (vi. 1—21). The only examples of the class recorded in Scripture are Samson, Samuel, and John the Baptist, who were devoted from birth to that condition, though the law appears to contemplate temporary and voluntary, rather than perpetual Nazariteship.

NEAGH, LOUGH, the largest lake of the British Islands, is situated in the province of Ulster, Ireland, and is surrounded by the counties of Armagh, Tyrone, Londonderry, Antrim, and Down. It is 18 miles (English) in length, and 11 miles in breadth, contains 98,255 acres, is 120 feet in greatest depth, and is 48 feet above sea-level at low water. It receives the waters of numerous streams, of which the principal are the Upper Bann, the Blackwater, the Moyola, and the Main; and its surplus waters are carried off northward to the North Channel by the Lower Bann. Communication by means of canals subsists between the Lough and Belfast, Newry, and the Tyrone coal-field. In some portions of the Lough, the waters shew remarkable petrifying qualities, and petrified wood found in its waters is manufactured into hones. The southern shores of the Lough are low and marshy, and dreary in appearance. It is well stocked with fish, and its shores are frequented by the swan, heron, bittern, teal, and other water-fowl.

NEAL, DANIEL, a dissenting minister and author, was born in London, December 14, 1678. He was educated first at Merchant Taylors' School, and afterwards at Utrecht and Leyden, in Holland, and in 1706 succeeded Dr Singleton as pastor of a congregation in his native city. N.'s first work was a *History of New England* (1720), which met with a very favourable reception in America. Two years afterwards, he published a tract, entitled *A Narrative of the Method and Success of Inoculating the Small-pox in New England by Mr Benjamin Colman*, which excited considerable attention; but the production on which his reputation rests is his *History of the Puritans* (4 vols. 1732—1738), a work

of great labour, and invaluable as a collection of facts and characteristics both to churchmen and dissenters, though, of course, written in the interest of the latter. It involved its author in several controversies, which failing health rendered it impossible for him to prosecute. N. died at Bath, April 4, 1743.

NEAL, JOHN, an American author and poet, of Scottish descent, was born at Falmouth, now Portland, Maine, August 25, 1793. His parents belonged to the Society of Friends, of which he was a member until disowned, at the age of 25, because he failed to live up to the rule of 'living peaceably with all men.' With the scanty education of a New-England common school, he became a shop-boy at the age of 12; but learned and then taught penmanship and drawing. At the age of 21, he entered a haberdashery trade, first in Boston, and then in New York; and a year after, became a wholesale jobber in this business at Baltimore, in partnership with another American literary and pulpit celebrity, John Pierpont. They failed in 1816, and N. turned his attention to the study of law. With the energy which acquired for him the sobriquet of 'Jehu O'Catarract,' affixed to his poem, *The Battle of Niagara*, he went through the usual seven years' law-course in one, besides studying several languages, and writing for a subsistence. In 1817, he published *Keep Cool*, a novel; the next year, a volume of poems; in 1819, *Otho*, a five-act tragedy; and in 1823, four novels—*Seventy-six*, *Logan*, *Randolph*, and *Errata*. These impetuous works were each written in from twenty-seven to thirty-nine days. In 1824, he came to England, where he became a contributor to *Blackwood's* and other magazines and reviews, and enjoyed the friendship and hospitality of Jeremy Bentham. On his return to America, he settled in his native town, practised law, wrote, edited newspapers, gave lectures, and occupied his leisure hours in teaching boxing, fencing, and gymnastics. Among his numerous works are *Brother Jonathan*, *Rachel Dyer*, *Bentham's Morals and Legislation*, *Authorship*, *Down-easters*, &c. After a long silence, devoted to professional business, he published, in 1854, *One Word More*; and in 1859, *True Womanhood*. The latter work, though a novel, embodies the more serious religious convictions of his later years. He is said to be now engaged upon an autobiography, and a revision of his voluminous writings, which, with glaring faults of haste and inexperience, are full of genius, fire, and nationality.

NEANDER, JOHANN AUGUST WILHELM, by far the greatest of ecclesiastical historians, was born at Göttingen, 16th January 1789, of Jewish parentage. His name prior to baptism was David Mendel. By the mother's side, he was related to the eminent philosopher and philanthropist Mendelssohn (q. v.). He received his early education at the Johanneum in Hamburg, and had for companions, Varnhagen von Ense, Chamisso the poet, Wilhelm Neumann, Nooldt, and Sieveking. Already the abstract, lofty, and pure genius of N. was beginning to shew itself. Plato and Plutarch were his favourite classics as a boy; and he was profoundly stirred by Schleiermacher's famous *Discourses on Religion* (1799). Finally, in 1806, he publicly renounced Judaism, and was baptized, adopting, in allusion to the religious change which he had experienced, the name of N. (Gr. *neos*, new; *aner*, a man), and taking his Christian names from several of his friends. His sisters and brothers, and later his mother also, followed his example. He now proceeded to Halle, where he studied theology with wonderful ardour and success under Schleiermacher,

and concluded his academic course at his native town of Göttingen, where Planck was then in the zenith of his reputation as a church historian. In 1811, he took up his residence at Heidelberg University as a privat-docent; in 1812, he was appointed there extraordinary professor of theology; and in the following year, was called to the newly established university of Berlin as Professor of Church History. Here he laboured till his death, July 14, 1850. N. enjoyed immense celebrity as a lecturer. Students flocked to him not only from all parts of Germany, but from the most distant Protestant countries. Many Roman Catholics, even, were among his auditors, and it is said that there is hardly a great preacher in Germany who is not more or less penetrated with his ideas. His character, religiously considered, is of so noble a Christian type that it calls for special notice. Ardently and profoundly devotional, sympathetic, glad-hearted, profusely benevolent, and without a shadow of selfishness resting on his soul, he inspired universal reverence, and was himself, by the mild and attractive sanctity of his life, a more powerful argument on behalf of Christianity than even his writings themselves. Perhaps no professor was ever so much loved by his students as Neander. He used to give the poorer ones tickets to his lectures, and to supply them with clothes and money. The greater portion of what he made by his books, he bestowed upon missionary, Bible, and other societies, and upon hospitals. As a Christian scholar and thinker, he ranks among the first names in modern times, and is believed to have contributed more than any other single individual to the overthrow, on the one side, of that anti-historical Rationalism, and on the other of that dead Lutheran formalism, from both of which the religious life of Germany had so long suffered. To the delineation of the development of historical Christianity, he brings one of the broadest, one of the most sagacious (in regard to religious matters), one of the most impartial yet generous and sympathetic intellects. His conception of church history as the record and portraiture of all forms of Christian thought and life, and the skill with which, by means of his sympathy with all of these, and his extraordinary erudition, he elicits, in his *Kirchengeschichte*, the varied phenomena of a strictly Christian nature, have placed him far above any of his predecessors. N.'s works, in the order of time, are: *Ueber den Kaiser Julianus und sein Zeitalter* (Leip. 1812); *Der Heil. Bernhard und sein Zeitalter* (Berl. 1813); *Genetische Entwicklung der vornehmsten Gnostischen Systeme* (Berl. 1818); *Der Heil. Chrysostomus und die Kirche, besonders des Oriente, in dessen Zeitalter* (2 vols. Berl. 1821—1822; 3d ed. 1849); *Denkwürdigkeiten aus der Geschichte des Christenthums und des Christlichen Lebens* (3 vols. Berl. 1822; 3d ed. 1845—1846); *Antignosticus, Geist des Tertullianus und Einleitung in dessen Schriften* (Berl. 1826); *Allgemeine Geschichte der Christlichen Religion und Kirche* (6 vols. Hamb. 1825—1852); *Geschichte der Pflanzung und Leitung der Kirche durch die Apostel* (2 vols. Hamb. 1832—1833; 4th ed. 1847); *Das Leben Jesu Christi in seinem geschichtlichen Zusammenhange*, written as a reply to Strauss's work (Hamb. 1837; 5th ed. 1853); *Wissenschaftlichen Abhandlungen*, published by Jacobi (Berl. 1851); *Geschichte der Christlichen Dogmen*, also published by Jacobi (1856). The majority of these works, including the most important, have been translated into English, and form more than a dozen volumes of Bohn's 'Standard Library.'

NEAP-TIDES. See TIDES.

NEARCHUS, the commander of the fleet of Alexander the Great in his Indian expedition,

327—326 B. C., was the son of one Androtimus, and was born in Crete, but settled in Amphipolis. In 329 B. C., he joined Alexander in Bactria with a body of Greek mercenaries, and when the latter ordered a fleet to be built on the Hydaspes, N. received the command of it. He conducted it from the mouth of the Indus to the Persian Gulf, in spite of great obstacles, resulting partly from the weather and partly from the mutinous disposition of his crews. N. left the Indus on the 21st of September 325, and arrived at Susa, in Persia, in February 324, shortly after Alexander himself, who had marched overland. Fragments of his own narrative of his voyage have been preserved in the *Indica* of Arrian.—See Dr Vincent's *Commerce and Navigation of the Ancients in the Indian Seas* (vol. i. pp. 68—77, Lond. 1807), and Geier's *Alexandri Magni Historiarum Scriptores* (pp. 108—150).

NEATH, a parliamentary and municipal borough and river-port of the county of Glamorgan, South Wales, on a navigable river of the same name, seven miles north-east of Swansea. It is built on the site of the Roman station *Nidum*, and it contains the remains of an ancient castle, burned in 1231. In the immediate vicinity are the imposing ruins of Neath Abbey, described by Leland as 'the fairest abbey in all Wales,' but now sadly decayed and begrimed by the smoke and coal-dust of the public works of the district. There are at N. several extensive copper and tin works. Copper, spelter, iron and tin plates, and fine bricks are extensively exported, stones are quarried, and coal and culm are raised. The trade of the port has largely increased within late years. Pop. (1861) 6810.

NEB-NEB, or NIB-NIB, the dried pods of *Acacia Nilotica*, one of the species of *Acacia* (q. v.) which yield gum-arabic, and a native of Africa. These pods are much used in Egypt for tanning, and have been imported into Britain. They are two or three inches long.

NEBRA'SKA, a territory belonging to the United States of America, lying in lat. 40°—43° N., and long. 95°—110° W.; bounded N. by the territory of Dakota, from which it is partly separated by the Missouri River and its branch, the Niobrara; E. by Iowa and Missouri, from which it is separated by the Missouri River; S. by the state of Kansas, and the territories of Colorado and Utah; and W. by Utah and Washington territories; being about 540 miles from east to west, and from 130 to 200 from north to south, having an area estimated (*American Almanac*, 1863) at 100,000 square miles. The chief towns are Omaha City, the capital, and Nebraska City, both on the Missouri River, and each having about 2000 of a population. N. is a vast plain rising gradually toward the Rocky Mountains, with immense prairies, the haunts of vast herds of buffalo, and with fertile and well-timbered river-bottoms. The chief rivers are the Missouri on its eastern, and the Niobrara on the northern boundary, the Platte or Nebraska, and the Republican Fork of the Kansas, and their branches. The Platte Valley, running through the whole centre of the territory, is broad and fertile. There are quarries of sandstone, a soft limestone which hardens on exposure, and thin beds of coal. In the mountainous western region are mines of gold, silver, copper, and cinnabar. Between the fertile lands of the eastern and central portion and the mountains is a great desert valley of 30 by 90 miles, 300 feet deep, full of rocky pinnacles, and rich in fossil remains. The climate is dry and salubrious, with an abundance of clear sunny days. The country produces wheat, maize, hemp, tobacco, and fruits in abundance, while the rolling

prairies afford unequalled pasturage. The Omahas, Pawnees, Otoes, Sioux, and other wild tribes hunt over the unoccupied territories, but the immigration chiefly of Germans and Irish is progressing rapidly. Erected as a territory in 1854, it had, in 1860, a population, exclusive of Indians, of 28,836.

NEBRASKA, or **PLATTE**, a river of Nebraska Territory, United States of America, rises in the Rocky Mountains, lat. 42° 30' N., long. 109° W., and flowing easterly 600 miles through the entire territory, watering its great valley, falls into the Missouri.

NEBUHADNEZZAR. See **BABYLON**.

NEBULÆ, a name given to indistinct patches of light in the heavens, which were at one time supposed to proceed from aggregations of rarely distributed matter belonging to distant worlds in the course of formation. By the gradual improvement of telescopes in power and distinctness, these nebulae have, one after another, become resolved into clusters of distinct stars, and it is now generally supposed that such a resolution of all nebulae which have been observed is only limited by the power of the telescope. It is probable that the group of stars with which our system is immediately surrounded, and which forms to our eyes the galaxy which studs the firmament, would, if looked upon from the immeasurable distances at which these so-called nebulae are situated, itself assume the appearance of such a nebula; and that in the intervals there exist spaces as void of starry worlds as these are comparatively full of them. See **STARS**. Some nebulae are of a round form, presenting a gradual condensation towards the centre; others consist of one star surrounded by a nebulous haze; while a third class present just the same appearance as would be exhibited by the solar system, if seen from a point immensely distant. These and other phenomena suggested to Laplace the idea, afterwards developed into a theory, and known as the *nebular hypothesis*, that these nebulae were systems in process of formation; the first stage presenting an agglomeration of nebulous matter of uniform density, which, in the second stage, shewed a tendency to gradual condensation towards the centre; and, finally, the nebulous matter round the now-formed centre of the system, separated itself into distinct portions, each portion becoming condensed into a planet. The same opinion regarding the formation of planets from nebulae was put forward by Sir John Herschel in 1811; but the subsequent discoveries made by Lord Rosse have shewn the fallacy of this theory, by proving that the nebulae upon which the hypothesis was founded, were really clusters of stars like other nebulae.

NEBULY, one of the partition lines in Heraldry, which runs out and in, in a form supposed to represent the uneven edges of clouds.

NECESSARIES. See **KTR**.

NECESSITY. This word occurs in connection with two different philosophical subjects, namely, the freedom of the will (see **FREE-WILL**), and the nature of our belief in fundamental truths, such as the axioms of mathematics, the law of causation, and the reality of a material world. It is alleged by some philosophers, that the truths held by us as most certain are the result of experience, and that the degree of certainty is but a measure of the universality of the experience. Others contend that such first principles as the axioms of mathematics are not only true, but *necessarily* true; we not only do believe them, but we *must* believe them. Such

necessity, it is argued, cannot come from mere experience, and therefore implies an innate or intuitive source. Hence the theory of necessary truth is only another name for the theory of instinctive or intuitive truth.

Necessity is a word too vague in its signification to serve as a leading term in philosophy. There are several meanings attaching to it, which should be clearly set forth before entering on the discussion of such questions as those above mentioned.

1. Necessity, in the first place, means that one fact or statement is *implied* in another. Thus, if we say that all the apostles were Jews, it follows necessarily that Peter was a Jew; this is not a new fact, but merely a re-assertion of a portion of the same fact. We are not at liberty to affirm a thing in one form, and then deny the same thing when expressed in a different form. If we say this room is hot, it is repeating the assertion in another way, to say that it is not cold. These truths follow by necessary inference. Hence the general axiom of the syllogism, that what is true of a whole class must be true of each individual, is a necessary truth in this sense. In affirming such a truth, we merely declare that we shall be consistent, and that when we have affirmed a proposition in company with other propositions, we are prepared to affirm it when taken apart from the others. This kind of necessity is sometimes called Logical necessity, and sometimes Mathematical necessity. We might call it Deductive necessity, or necessity by Implication.

2. A second meaning is Inductive certainty; or the certainty that arises from a well-grounded experience. That lead will sink in water; that animals need food and air in order to live; that warmth promotes vegetation; are truths that we call necessary, in the sense of being so certain that we may always count upon them. We presume with the highest confidence, that an unsupported body will fall to the ground, not because the fact of falling is implied in the fact of matter, but because nature has uniformly conjoined the two facts. We can speak even of moral necessity; by which we mean only uniform sequence and consequent certainty. When we declare that children, whose education has been neglected, must fall into evil courses, we declare what experience has shewn us will happen in relation to the human mind.

3. When necessity means neither deductive implication, nor inductive certainty, it refers us to a peculiar test supposed to apply to the truths in dispute—namely, the inconceivableness of their opposite. It is said that, not only can we not *believe* in the opposite of the axiom, that 'the sums of equals are equal,' but we cannot even *conceive*, imagine, or picture to ourselves the opposite of it. This impossibility of conceiving the contradiction of any statement, is regarded by many as a peculiarly cogent circumstance in its favour. It distinguishes the axiomatic first principles from the truths of inductive science, these having, it is said, an inferior order of certainty. To this it may be replied, however, that men's power of conceiving is so much affected by their education and habits, that many things, whose opposites were at one time inconceivable, have since been found to be false. For example, the notion that men could live at the antipodes was once reckoned inconceivable, and we now know it to be a fact. An unvarying association will often produce a disability to conceive anything different.

In commencing a discussion as to the necessary character of any truth, the disputants should agree beforehand which of the three meanings they intend. In the controversy on the Mathematical axioms, maintained between Dr Whewell on the one hand, and Sir John Herschel and Mr J. S. Mill on the

other, the third meaning is more particularly involved. The doctrine of Inconceivability, as the test of truth, has been put forward by Mr Herbert Spencer, under the title of the Universal Postulate (*Principles of Psychology*, Part I).

NECHÉS, a river of Texas, U. S., rises in the central eastern portion of the state, and flows south by east, 200 miles, into Sabine Bay, where its waters, with those of the Sabine River, find their way, by Sabine Pass, into the Gulf of Mexico.

NECKAR, one of the largest tributaries of the Rhine, and the principal river of Württemberg, rises near to the source of the Danube, on the eastern declivity of the Black Forest, and close to the village of Schweningen. It has a winding course of 240 miles, first north-east to its junction with the Fils, then north to its junction with the Jart, and finally north-west to Mannheim, where it joins the Rhine. The principal places on its banks are Tübingen, Heilbronn, Heidelberg, and Mannheim. Its course, leading first through a deep and narrow dale, leads afterwards through a succession of wide and fertile tracts, enclosed by soft vine-clad hills. The scenery of its banks is, in general, very beautiful, and in many places highly romantic. From Cannstadt, about midway in its course, the N. is navigable; steamers ply regularly to Heidelberg. Good wines are grown on its banks. Chief affluents, on the left, the Enz; on the right, the Fils Rems, the Kocher, and the Jart.

NECKER, JACQUES, a famous financier and minister of France, was born, 30th September 1732, at Geneva, where his father, a native of Brandenburg, but of Anglo-Irish descent, was professor of German law. He became a banker in Paris, and acquired a large fortune during the Seven Years' War. After retiring from business, he became the representative of his native city at the French court; and also acquired a high but not exactly a solid reputation by his publications on political economy and finance, particularly his *Essai sur la Législation et le Commerce de Grains* (Par. 1775). In this essay he appears as the opponent of the wise Turgot's liberal measures in regard to the traffic in grain, and claims for the state the right of fixing its price, and if it thinks it necessary, of prohibiting its exportation. On the removal of Turgot from office in June 1776, N. was called to assist in financial affairs, and after the brief administration of Clugny, he was made General Director of Finances in June 1777. N. could not conceal his elation. This was his weak point. He had all the vanity, egotism, and love of show that marked his brilliant but superficial daughter. Nevertheless, he succeeded not only in meeting the exigencies of the American war, but in restoring to some degree of order the general financial affairs of the country, though mainly by the perilous expedient of borrowing, which he was enabled to do to an almost unlimited extent, owing to the confidence reposed in his financial dexterity. Some years he borrowed as much as 490 millions of francs. His Protestantism, however, and some retrenchments which he made in the royal household, with his publication on the financial affairs of France (*Compte Rendu*, which produced an immense sensation), made him an object of great dislike to the queen and court, and on 12th May 1781 he was suddenly dismissed. He retired to Geneva, where he was visited, from motives of sympathy and respect, by the highest personages in the realm, the Prince of Condé, the Dukes of Orleans and Chartres, the Prince of Beauvau, the Duke of Luxembourg, Maréchal de Richelieu, the Archbishop of Paris, &c. but returned to Paris in 1787, from which he was soon

banished on account of an attack which he published on the financial management of the reckless and ignorant Calonne. In the financial and political crisis, however, which followed upon the financial administration of Loménie de Brienne, Louis XVI. found himself under the necessity of calling N. in November 1788 to the office of Comptroller General of Finances and Minister of State. N. recommended the calling of the States General, and thereby acquired the greatest popularity. He failed, however, in the difficulties which ensued, having no capacity for political affairs in other than their mere financial aspects. When the court, on 23d June 1789, determined upon nullifying the resolution of the third estate, N. hesitated, and the king therefore dismissed him on 11th July, and required him to leave the French dominions immediately. He obeyed, but the disturbances of the 12th, 13th, and 14th of July (on the last of which days the Bastille was taken) were the result of his dismissal, and the king was under the necessity of recalling him. He now allied himself with Mounier and other ministers for the introduction of a constitution like that of Britain, with two chambers or Houses of Parliament; but this caused a great diminution of his popularity, and he was unable to contend in debate with Mirabeau and other great leaders of the National Assembly. On the rejection by the assembly of his scheme of a loan, and the adoption instead of it of Mirabeau's scheme of assignats, he resigned his office in September 1790, and retired to his estate of Coppet, near Geneva, where he died, 9th April 1804. Besides the works already mentioned, he published several on political and on religious subjects, particularly a work on the French Revolution (4 vols. Par. 1796), which has been frequently reprinted. His daughter was the celebrated Madame de Staël.

NECK-MOULDING. A moulding at the junction of the capital and shaft of a column. The plain space between the astragal of the shaft and the mouldings of the cap of the Roman Doric order is called the neck.

NECROMANCY (Gr. *nekros*, dead, and *mantia*, divination), a mode of divination by the conjuring up of the dead to question them concerning the future. It originated in the east, and in times of the most remote antiquity. It is condemned in the Old Testament; and the story of the witch of Endor affords a remarkable illustration of it, which has not a little perplexed interpreters of Scripture. The eleventh book of Homer's *Odyssey* bears the title of *Nekromanteia*, and in it the shade of Tiresias is represented as brought up and consulted by Ulysses. In most parts of Greece, necromancy was practised by priests or consecrated persons in the temples; in Thessaly, it was the profession of a distinct class of persons called Psychagogoi ('Evokers of Spirits'). The practice of it in that country was ultimately connected with many horrid rites, in which human blood, half-burned portions of bodies from funeral piles, the immature foetus cut out of the womb, &c., were employed, and sometimes human beings were slain, that their spirits might be consulted ere they finally passed into the lower world. The establishment of Christianity under Constantine caused necromancy to be placed under the ban of the church. There are evident traces of necromancy in some of the older Norse and Teutonic poems. The mediæval belief in the evocation of spirits belongs rather to sorcery than to necromancy. See Peucer's *Commentarius de Præcipuis Divinationum Generibus* (Zerbst, 1691).

NECROPHILISM, an unnatural and revolting love or appetite for the dead which has manifested

itself in various ways. Consorting or living with the dead has been observed as a characteristic of melancholia. Individuals have inhabited graveyards, preferring the proximity and association of corpses with which they had no tie, to the cheerfulness and comforts of home; and there is recorded one notorious case, in which a gentleman, although on bad terms with his wife while alive, carried her body with him through India, scandalising the natives, and outraging the feelings of all, by placing the coffin under his bed. This hideous tendency may enter into certain developments of cannibalism, where the feast is celebrated in memory of a departed friend, rather than in triumph over a slain foe. It is affirmed that there were anthropophagous epidemics in 1436 and 1500; and the history of vampirism connects that delusion with the moral perversion now described. Patients in asylums, especially in continental asylums, are still often encountered who bemoan the crime of having devoured the dead, and violated charnel-houses. The most extraordinary exhibition of necrophilism is where individuals, not in fancy but in reality, have exhumed corpses, to see them, to kiss them, to carry them away to their own homes, or to mutilate and tear them to pieces. It is worthy of notice that, so far as such cases have been observed in this country, they have been confined to communities living in remote places, of rude and unenlightened character, and cherishing the superstitions of ages and states of society with which they have no other connection, and of which they have almost lost the recollection.—*Annales, Médico-Psychologiques*, t. viii. p. 472.

NECROPOLIS, a Greek term, meaning the city of the dead, and applied to the cemeteries in the vicinity of ancient cities. It occurs in classical antiquity only as applied to a suburb of Alexandria, lying to the west of that city, having many shops and gardens and places suitable for the reception of the dead. The corpses were received and embalmed in it. Here Cleopatra, the last of the Ptolemies, applied the asp to her breast, to avoid the ignominy of being led in triumph by Augustus. The site of the necropolis of ancient Alexandria seems to have been where are now the catacombs, consisting of galleries and tombs hollowed out of the soft calcareous stone of which the city is built, and lying at the extremity of the city. The term necropolis is now, however, used in a much more extended sense, and applied to all the cemeteries of the ancient world. These consisted either of tombs, constructed in the shape of houses and temples, and arranged in streets, like a city of the dead; or else of chambers hollowed in the rock, and ornamented with façades, to imitate houses and temples. Such cemeteries are to be distinguished from the *columbaria*, or subterranean chambers of the Romans, in which their urns were deposited; or the rows of tombs along the Via Appia; or the cemeteries of the Christians, whose bodies were deposited in the ground. The most remarkable necropolises are that of Thebes in Egypt, situated at a place called Gournah, on the left bank of the Nile, capable of holding 3000 persons, and which it is calculated must at least have contained 5000 mummies; those of El-Kab or Eileithyia; of Beni-Hassan, or the Speos Artemidos; and of Madfun or Abydos; of Siwah or the Oasis of Ammon. See **OASIS**. In Africa, the necropolis of Cyrene is also extensive; and those of Vulci, Corneto, Tarquinii, and Capua are distinguished for their painted tombs (see **TOMBS**), and the numerous vases and other objects of ancient art which have been exhumed from them. Large necropolises have also been found in Lycia, Sicily, and elsewhere.

Strabo, xviii. p. 795—799; Plutarch, vit Anton; Letronne, *Journal des Savans*, 1828, p. 103; Dennis, *Cities and Cemeteries of Etruria*, i. 412, i. 276—358.

NECRO'SIS (Gr. *nēkros*, dead) is a term employed to denote the death or mortification of bone, but often restricted to the cases in which the shaft of a long bone dies, either directly from injury or from violent inflammation, and is enclosed by a layer of new bone; the death of a thin superficial layer, which is not enclosed in a shell of new bone, being usually termed *exfoliation*.

The bones of the lower extremity—the femur and tibia—are those which are most frequently affected by necrosis. The lower jaw is, however, extremely often affected by it, in persons engaged in making lucifer-matches; the disease being set up by the pernicious action of the vapour of phosphorus. The dead bone, known as the *sequestrum*, generally consists of the circumference of the shaft only, and not of the interior, and the inside of the dead portion presents a rough appearance, as if worm-eaten. If the membrane investing the bone (the periosteum) remain healthy, it deposits lymph, which speedily ossifies, forming a shell of healthy bone, which completely invests the dead portion.

The essential point in the treatment is the removal of the *sequestrum*, which is too purely a surgical operation to be described in these pages.

NECTAR, the name given by Homer, Hesiod, Pindar, and the Greek poets generally, and by the Romans, to the beverage of the gods, their food being called *Ambrosia* (q. v.). But Sappho and Alcman make nectar the food of the gods, and ambrosia their drink. Homer describes nectar as resembling red wine, and represents its continued use as causing immortality. By the later poets, nectar and ambrosia are represented as of most delicious odour; and sprinkling with nectar, or anointing with ambrosia, is spoken of as conferring perpetual youth, and they are assumed as the symbols of everything most delightful to the taste.

NECTARINE. See **PEACH**.

NECTARY, in Botany, an organ in the flowers of many phanerogamous plants, devoted either to the secretion or the reception of honey. Of the former kind are nectariferous glands, scales, and pores; of the latter, tubes, cavities, &c. But the term was for a long time very vaguely employed by botanists, and seemed to be found convenient for the designation of any part of a flower for which no other name was known. Thus amongst the parts called nectaries by the older botanists, may be found those now called *Disc* (q. v.), and that which bears the name of *Corona* (q. v.).

NEEDFIRE (Ger. *nothfeuer*; allied to Sw. *gnida*, to rub; Eng. *knead*), fire obtained by the friction of wood upon wood, or the friction of a rope on a stake of wood, to which a widespread superstition assigns peculiar virtues. With varieties of detail, the practice of raising needfire in cases of calamity, particularly of disease among cattle, has been found to exist among most nations of the Indo-European race. It has been supposed effectual to defeat the sorcery to which the disease is assigned. When the incantation is taking place, all the fires in the neighbourhood must be extinguished, and they have all to be relighted from the sacred spark. In various parts of the Scottish Highlands, the raising of needfire was practised not long ago, and it is perhaps still had recourse to in some very remote localities. The sacrifice of a heifer was thought necessary to insure its efficiency. The ways of obtaining fire from wood have been various; one is by an apparatus which has been called the 'fire-churn,' a cylinder turning on a pivot, and furnished

NEEDLES.

with spokes, by means of which it is made to revolve very rapidly, and fire is generated by the friction. Fire struck from metal has been supposed not to possess the same virtue, and in some instances the persons who performed the ceremony were required to divest themselves of any metal which might be about them. In its origin, the fire-churn was considered a model of the apparatus by which the fires of heaven were daily rekindled. It is still in daily use in the temples of the Hindus. The same superstition was doubtless the origin of the story of Prometheus (q. v.). See Grimm's *Deutsche Mythologie*; Supplement to Jamieson's *Scottish Dictionary*.

NEEDLES are instruments of metal, or other material, for the purpose of carrying the thread in sewing, embroidery, knitting, netting, and other similar operations. They are generally made of metal, but bone, ivory, and wood are also used; for ordinary needle-work, called sewing, they are made of fine steel, and are too well known to need description; for other kinds of work, they are often much larger and differently formed, according to the requirements of the work to be done.

Needle-making is an important branch of industrial art, and it has of late years attained to extraordinary perfection. Small bars of steel, not thicker than a good-sized bristle, can be made perfectly round, pointed at one end with wonderful accuracy, pierced at the other end with an oval hole, the sides of which are so smoothly rounded that there is no friction upon the thread, and the whole of each instrument, not more than an inch in length, beautifully polished, and sold at less than a shilling per hundred, notwithstanding that a large part of the operations required in their manufacture are manual. The first operation, after the wire has been selected, and its thickness accurately gauged, is to cut it into eight-foot lengths; this is done by winding it in a coil of 16 feet circumference, and then cutting this coil into exact halves



Fig. 1.

with powerful cutting shears. The coiling of the wire is so managed, that there are 100 pieces in each half when cut; the bundles of 100 wires are again cut into the necessary lengths for two needles; and so well arranged are the cutting shears, that a man can easily cut enough for 1,000,000 needles in a day of 12 hours. The pieces cut from a coil, although now reduced to the length of two small needles, are nevertheless somewhat curved; they are therefore collected into bundles of about 6000, and placed in two iron rings, which hold them loosely together, as in fig. 1; they are then slightly softened



Fig. 2.

by firing, and are laid on an iron plate or bench, and are pressed with a small curved bar (fig. 2) in two or three positions, by which the operator manages to make them all perfectly straight. They are now taken to the grinder, who sits in front of his grindstone upon a seat which is hollow, and forms an air-shaft open towards the stone; through this a blast of air is forced when the wheel is in motion, which carries away from the grinder every particle of the subtle dust from the needle points and the stone. Before this humane invention, which has rendered the operation quite innocuous, the loss of life in this manufacture was more serious than in any other

industrial occupation. The operator, with great tact, holds about 25 of the wires, by means of his thumb, pressed against the inside of his fingers, the wires, which are held straight and applied to the grindstone, being dexterously turned round on the inside of the hand by means of the thumb, until they are ground sharp at one end; they are then reversed, and the other ends are similarly sharpened (fig. 3). They are next taken to the *impressing* machine, which in principle consists of a weight hanging to a block, which is raised by the hand and let fall at pleasure; the wires are placed in succession under this, so that the falling weight strikes each wire exactly in the middle, and there flattens it, as in fig. 4. The hardening of the flattened part by

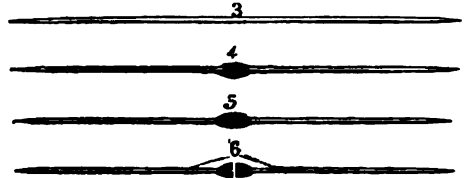

Figs. 3, 4, 5, 6.

the blow is removed in the annealing oven, and the holes are next punched, two in each flattened portion, as in fig. 5. These are either done by hand-punches worked by children, who acquire great nicety in the operation, or by a machine on the same principle as the *impressing* machine; this not only punches the two holes, but also forms a small cross-cut between them (as seen in fig. 5), which is otherwise made by a file. At this cross-cut the wire is broken in two, and may now be regarded as two rudely-formed needles (fig. 6), each having a flattened and pierced head, as shewn in fig. 7. A number of these are now threaded (*spitted*) on a thin



Fig. 7.

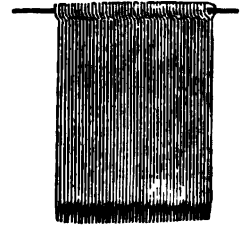

Fig. 8.

wire, as in fig. 8, and are placed in a vice, which holds them firm and straight, so that the workman can file the heads on the top and sides, so as to remove all the burred edge outside the dotted lines in fig. 7. The next process is *oil tempering*, for which they are made hot, and immersed in sufficient oil to coat them thoroughly; the oil is then burned off, an operation which renders the needles brittle. They are then weighed out into lots of about 500,000 each, and after being shaken so that they lie side by side, they are laid on a square piece



Fig. 9.

of strong canvas, and a quantity of sand and emery-powder being mixed with them, they are corded up very securely into a long roll (fig. 9), from 18

inches to 2 feet in length. A number of these rolls or bundles are placed on a movable wooden slab, in the *scouring machine*, and over them is placed another heavily weighted slab. The action of the machine, of which these slabs form part, is to move them backwards and forwards in opposite directions, the bundles of needles acting as rollers, the pressure upon which works the enclosed needles, sand, &c. together, so that after eight to ten hours, which this operation occupies, instead of the blackened appearance they had when it commenced, they are white and silvery-looking. They are now removed to an exactly similar machine, where they are polished. Here they are separated from the sand and emery, and are removed to other canvas squares; and when mixed up with a paste of *putty-powder* and oil, are again corded up, and made to roll backwards and forwards under the weighted wooden slab of the *polishing machine* for four hours more. The next process is to remove them from the canvas, and agitate them in a vessel with soft-soap and water, to remove the oil and putty-powder, and next to dry them in ash-wood saw-dust. They are now highly polished and well tempered, but not all of exactly the same length, nor are the eyes perfect; they are therefore passed to a person who, by nice management of a small gauge, sorts them very quickly into certain lengths (*evening*), and arranges them all in one direction (*heading*). They then pass on to be drilled, an operation requiring great nicety, as the small oval holes have to be so polished all round, as not to cause any friction on the thread in sewing with them; a clever workman will drill and polish the holes of 70,000 needles per week. The needle is now practically finished, but many minor operations are considered necessary to produce high-finish; these we purposely omit, to avoid complicating our description. It is, however, worthy of remark, that this little instrument, which costs so much labour for its formation, has by these operations acquired immense value. The wire of which the ordinary-sized needles are made is so thin, that $5\frac{1}{2}$ pounds go to form 74,000 needles. Of ordinarily sized needles, $2\frac{1}{4}$ millions weigh 3 cwt., and are worth rather more than £200, although the steel wire of which they were made was only worth £14 at the commencement of the manufacture. English-made needles are the best in the world, and are chiefly made in Redditch and the neighbourhood, where, and in other parts of the county of Worcester, this manufacture employs a large number of persons.

NEEM-TREE. See MELIACÆ.

NEERWINDEN, a small village of Belgium, in the north-west corner of the province of Liege, is celebrated in history for the great victory gained by the French under Luxembourg over the English under William III. (29th July 1693); and also for the defeat of the French under Dumouriez by the allies under the Prince of Coburg (18th March 1793).

NE EXEAT REGNO is the title of a writ issued by the Court of Chancery to prevent an individual leaving the kingdom, unless he gives security to abide a decree of that court. The writ was originally resorted to in cases of attempts against the safety of the state, but is now issued in cases where an equitable debt or demand is sought to be substantiated by a bill or proceeding in Chancery. The writ is only granted where the party usually resides within the jurisdiction. It resembles the process which is known in the common-law courts as arresting and holding to bail, and in Scotland as arresting a person in *meditatione fuge*.

NEGATIVE, in Photography, is that kind of photographic picture in which the lights and shadows

of the natural object are transposed; the high lights being black, and the deep shadows transparent, or nearly so. Negatives are taken on glass and paper by various processes, and should indicate with extreme delicacy, and in reverse order, the various gradations of light and shade which occur in a landscape or portrait. A negative differs from a positive inasmuch as in the latter case it is required to produce a deposit of pure metallic silver to be viewed by *reflected* light; while in the latter, density to *transmitted* light is the chief desideratum; accordingly inorganic reducing and retarding agents are employed in the development of a positive, while those of organic origin are used in the production of a negative. Adopting the collodion process (which has almost completely replaced every other) as a type of the rest, the conditions best adapted for securing a good negative may be briefly indicated, leaving it to the reader to apply the principles involved to any process he may desire to practise.

The possession of a good lens and camera being taken for granted, and favourable conditions of well-directed light being secured, all that is necessary is to establish a proper and harmonious relation between the collodion bath, developer, and time of exposure. A recently-iodised collodion will generally be tolerably neutral, in which case, if the developer be at all strong, and the weather warm, the bath should be decidedly acid, or *fogging* will be the result. Should the collodion, however, be red with free iodine, a mere trace of acid in the bath will suffice, while the development may be much prolonged, even in warm weather, without fogging. If the simple fact be borne in mind that the presence of acid, either in the bath collodion or developer, retards the reducing action of the developer, it will suffice to guide the operator in many difficulties. The value of a negative consists in the power it gives of multiplying positive proofs. See POSITIVE PRINTING; also PHOTOGRAPHY.

NEGATIVE QUANTITIES are generally defined as quantities the opposite of 'positive' or 'numerical' quantities, and form the first and great point of difference between algebra as a separate science, and arithmetic. In the oldest treatises on algebra they are recognised as distinct modifications of quantity, and existing apart from, and independent of positive quantity. In later times, this opinion was vigorously combated by many mathematicians, among whom Vieta occupied a prominent place; but the more eminent analysts retained the old opinion. Newton and Euler distinctly assert the existence of negative quantities as quantities less than zero, and the latter supports his opinion by the well-known illustration of a man who has no property, and is £50 in debt, to whom £50 requires to be given in order that he may have nothing. After all, this discussion is little more than a verbal quibble, though interesting from the prominent position it for a long time held. It had its rise in the difficulty of satisfying the requirements of a constantly progressing science by the use of signs and forms retaining their original limited signification. It was soon felt that the limited interpretation must be given up; and accordingly an extension of signification was allowed to signs and modes of operation. + and -, which were formerly considered as merely symbols of the arithmetical operations of addition and subtraction, were now considered as 'general cumulative symbols, the reverse of each other,' and could signify gain and loss, upwards and downwards, right and left, same and opposite, to and from, &c. Applying this extended interpretation of signs to a quantity such as -4, we obtain at once a true idea of a negative quantity; for if +4 signifies 4 inches *above* a

certain level, -4 signifies 4 inches below that level, and therefore, though a positive quantity in itself (a negative being, strictly speaking, an impossible existence), it may be fairly considered to be less than zero, as it expresses a quantity less by 4 than 0 inches above the level. Keeping this idea in view, it has been conventionally agreed to admit the existence of negative quantities as existing *per se*. The only errors which can flow from this arise from misinterpretation of results, for the four fundamental operations of addition, subtraction, multiplication, and division are unaffected by the extended interpretation of signs. The following is an illustration of the value of an extended interpretation of the negative sign, shewing at the same time how much more general are the ideas conveyed by algebraic expressions than by ordinary language: If at the present time a father is 60 years, and his son 20 years old, when will the father be three times as old as his son. This problem, when solved, gives -5 as the number of years which must elapse before the father's age is three times the son's. Now, at first sight, this result appears to be absurd, but when we consider the terms of the problem, its explanation is easy. The question asked pointed to a number of years to come, and had the result turned out to be positive, such would have been the case, and the fact of its being negative directs us to look in a 'contrary' direction, or backwards to time past; and this is found to satisfy the problem, as 5 years 'ago' the father was 45 and his son 15.

Negative quantities arise out of the use of general symbols in subtraction, as in the formula $a - b$, where we may afterwards find that b is greater than a . See SUBTRACTION.

NEGRI'TOS, or NEGRI'LLOS (Spanish, diminutive of Negroes), is the name given by the Spaniards to certain Negro-like tribes inhabiting the interior of some of the Philippine Islands, and differing essentially both in features and manners from the Malay inhabitants of the Eastern Archipelago. They bear a very strong resemblance to the Negroes of Guinea, but are much smaller in size, averaging in height not more than four feet eight inches, whence their appellation of N., or little Negroes. They are also called by the Spaniards *Negrillos del Monte*, from their inhabiting the mountainous districts for the most part; and one of the islands where they are most numerous, bears the name of *Isla de los Negros*. These N. are also known by the names Aeta, Aigta, Ite, Inapta, and Igolote or Igorote. They are described as a short, small, but well-made and active people, the lower part of the face projecting like that of the African Negroes, the hair either woolly or frizzled, and the complexion exceedingly dark, if not quite so black as that of the Negroes. The Spaniards describe them as less black and less ugly than the Negroes—*Menos Negros y menos feos*. All writers concur in speaking of them as sunk in the lowest depths of savagedom, wandering in the woods and mountains, without any fixed dwellings, and with only a strip of bark to cover their nakedness. Their only weapons are the bow and arrow; and they live upon roots, wild fruits, and any sort of animals that they can surprise in their haunts, or conquer in the chase. By the Malays, they are despised and hated; and the buffalo-hunters in the woods, when they meet with them, do not scruple to shoot them down like wild beasts or game. 'It has not come to my knowledge,' says a Spanish writer, 'that a family of these Negroes ever took up their abode in a village. If the Mohammedan inhabitants make slaves of them, they will rather submit to be beaten to death than undergo any bodily fatigue; and it is impos-

sible, either by force or persuasion, to bring them to labour.' The same writer, an ecclesiastic, speaks of them as gentle and inoffensive in their manners, whenever he himself came in contact with them; and although informed that some of them were cannibals, he was not inclined to believe the report. Dr Carl Scherzer, the historian of the circumnavigation of the *Novara*, when at Manila, had an opportunity of seeing a Negrita girl whom he thus describes: 'This was a girl of about twelve or fourteen years of age, of dwarf-like figure, with woolly hair, broad nostrils, but without the dark skin and wide everted lips which characterize the Negro type. This pleasing-looking, symmetrically-formed girl had been brought up in the house of a Spaniard, apparently with the pious object of rescuing her soul from heathenism. The poor little Negrilla hardly understood her own mother-tongue, besides a very little Tagal, so that we had considerable difficulty in understanding each other.'

According to Spanish statements, the N. are found only in five of the Philippine Islands—namely, Luzon, Mindoro, Panay, Negros, and Mindanao—and are estimated at about 25,000 souls. Remnants of them exist, however, in the interior of some of the other islands in the Eastern Archipelago; and they are scattered, also, though in small numbers, through certain islands of Polynesia. They are altogether an island people, and are hence treated of by Prichard under the designation of Pelagian Negroes. By Dr Pickering they are treated of as a distinct race, resembling the Papuan, but differing from it in the diminutive stature, the general absence of a beard, the projecting of the lower part of the face or the inclined profile, and the exaggerated Negro features. The hair, also, is more woolly than that of the Papuans, though far from equalling that of the Negroes in knotty closeness. By Latham, the N. are classified under the subdivision of 'Oceanic Mongolids, C,' which subdivision is further modified by him into the designation of 'Amphinesians' and 'Kelsenonesians.' The N. out of the Philippine Islands are found for the most part in the islands embraced under the latter designation, as New Guinea, New Ireland, Solomon's Isles, Louisiade, New Caledonia, and Tasmania or Van Diemen's Land. Except in the last-mentioned island, however, the N., strictly speaking—that is, the blackish people with woolly hair—do not preponderate over the other native tribes less strongly marked with Negro features; while in Tasmania itself, the race has almost entirely disappeared, amounting at present to not more than two or three dozen souls. Dr Pickering is of opinion, that the Negrito race 'once occupied more space than it does at this time, and that it has in many instances preceded the dissemination of other races.' We conclude with a description of a Negrito native of Erromango (the island where the missionary Williams was murdered), supplied to Dr Pickering by Horatio Hales, his associate in the United States exploring expedition. 'He was above five feet high,' says Mr Hales, 'slender and long limbed; he had close woolly hair, and retreating arched forehead, short and scanty eyebrows, and small snub nose, thick lips (especially the upper), a retreating chin, and that projection of the jaws and lower part of the face, which is one of the distinctive characteristics of the Negro race. . . . Placed in a crowd of African blacks, there was nothing about him by which he could have been distinguished from the rest.' See PAPUANS and POLYNESIANS.

NEGRO, RIO. See RIO NEGRO.

NEGRO MINSTRELSY, a species of singing which originated among the negro slaves of the

United States, and is now popular at public entertainments. The sentiment of the earlier of these negro melodies was of the most simple kind, the words mostly broken English, and the harmonies confined chiefly to two chords—the tonic and dominant. How the airs were composed has been a matter of curious inquiry. Some of them are believed to be broken down and otherwise altered old psalm-tunes, which had been caught up by the more musical of the negro race. In some instances, the singing of the melodies is accompanied with grotesque gestures; the effect being to give the idea of good-nature and love of fun in the dark-skinned minstrels. Negro melodies may be said to have been made known by Mr D. Rice, who first in New York, in 1831, and afterwards in London, created a sensation by his singing of *Jim Crow*. Other songs followed, such as *Jim along Josey*, and *Buffalo Gals*; and from less to more, there was created a very characteristically national music, if the Americans will allow us to call it so. Becoming extensively popular, and addressed to fashionable audiences, this negro minstrelsy now comprehends a large variety of songs, with airs of a pleasing kind, the whole much in advance of the original negro compositions. For these improvements, the world is indebted, among others, to Mr E. P. Christy, who began as conductor of a band of minstrels at Buffalo in 1842, and who established himself in New York in 1846. At first, his troupe were called the 'Virginia Minstrels,' but afterwards they were known as the 'Christy Minstrels.' Mr Christy's great success in this species of entertainment brought other leaders and troupes into the field. In most cases, the members of the negro minstrel troupes are only negroes in name, with faces and hands blackened for the purpose. See *Christy's Minstrels' New Songs, with Music*, edited by J. Wade. London, 1859.

NEGROES (from the Spanish word *negro*, black; Lat. *niger*) is the name given to a considerable branch of the human family, possessing certain physical characteristics, which distinguish it in a very marked degree from the other branches or varieties of mankind—more especially the so-called whites or Europeans. In Blumenbach's fivefold division of mankind, the Negroes occupy the first place under the variety *Ethiopian*, which likewise embraces the Kafirs, Hottentots, Australians, Afrikanians, and Oceanic Negroes. In Latham's threefold division, they are placed among the *Atlantides*, and form the primary subdivision of *Negro Atlantides* in that author's classification; while in Pickering's elevenfold division, they occupy the last place in his enumeration of the races of mankind.

Both Prichard and Latham strongly protest against the common error of looking upon the term Negro as synonymous with African. 'It ought to be remembered,' says the former, 'that the word Negro is not a national appellation, but denotes the ideal type constituted by the assemblage of certain physical characteristics, which is exemplified in the natives of Guinea in Western Africa, and in their descendants in America and the West Indies.' And Latham in like manner observes: 'No fact is more necessary to be remembered, than the difference between the Negro and African; a fact which is well verified by reference to the map. Here the true Negro area—the area occupied by men of the black skin, thick lip, depressed nose, and woolly hair—is exceedingly small; as small in proportion to the rest of the continent, as the area of the district of the stunted Hyperboreans is in Asia, or that of the Laps in Europe. Without going so far as to maintain that a dark complexion is the exception rather than the rule in Africa, it may safely be said that the

hue of the Arab, the Indian, and the Australian is the prevalent colour. To realise this we may ask, what are the true Negro districts? and what those other than Negro? To the former belong the valleys of the Senegal, the Gambia, the Niger, and the intermediate rivers of the coast, parts of Sudania, and parts about Sennaar, Kordofan, and Darfúr; to the latter, the whole coast of the Mediterranean, the Desert, the whole of the Kafir and Hottentot areas south of the line, Abyssinia, and the Middle and Lower Nile. This leaves but little for the typical Negro.' Bearing in mind this limitation of the primitive area of the Negro, we shall next proceed to speak of his prominent physical characteristics.

The Negro has a black skin, unctuous and soft; woolly hair; thick lips; the lower part of the face prognathic, or projecting like a muzzle; the skull long and narrow; and a low, retreating forehead. The skull of the Negro is remarkably solid and thick, so that in fighting they often butt against each other like rams, without much damage to either combatant; and it is likewise so flat that burdens are easily carried upon it. According to Camper's lateral admeasurement, the head of the Negro shews an angle of 70°, while that of the European shews one of 80°, on which difference of 10°, as he considered, depends the superior beauty of the latter. There is not much dependence, however, to be placed on such a mode of admeasurement; and the same may be said of Blumenbach's vertical method. According to this, a considerable difference would appear to exist between the skull of the Negro and that of the European. 'But,' says Dr Prichard, 'I have carefully examined the situation of the foramen magnum in many Negro skulls; in all of them its position may be accurately described as being exactly behind the transverse line bisecting the antero-posterior diameter of the basis cranii. This is precisely the place which Owen has pointed out as the general position of the occipital hole in the human skull. In those Negro skulls which have the alveolar process very protuberant, the anterior half of the line above described is lengthened in a slight degree by this circumstance. If allowance is made for it, no difference is perceptible. The difference is in all instances extremely slight; and it is equally perceptible in heads belonging to other races of men, if we examine crania which have prominent upper jaws. If a line is let fall from the summit of the head at right angles with the plane of the basis, the occipital foramen will be found to be situated immediately behind it; and this is precisely the case in Negro and in European heads.' There is, in fact, neither in this respect—the conformation of the Negro skull—nor in any other, solid ground for the opinion hazarded by some writers, and supported either through ignorance or from interested motives by many persons—that the Negro forms a connecting link between the higher order of apes and the rest of mankind. The difference is certainly considerable between the highest European and the typical Negro, but the gulf between them both and the highest of the Simia is so nearly of the same width, that the difference is scarcely distinguishable. But the skin, hair, skull, lips, maxillary profile, and general facial appearance of the Negro, are not the only features that distinguish him in a great degree from the European, and seem to stamp him as a distinct variety of the human race. 'In the Negro,' says Prichard, 'the bones of the leg are bent outwards. Soemmering and Lawrence have observed that the tibia and fibula in the Negro are more convex in front than in Europeans; the calves of the legs are very high, so as to encroach upon the hams; the

feet and hands, but particularly the former, are flat; and the os calcis, instead of being arched, is continued nearly in a straight line with the other bones of the foot, which is remarkably broad.' As to the supposed excessive length of the forearm in the Negro, a circumstance also dwelt upon as shewing an approach to the anthropoid apes, facts are altogether against the statement; there being no greater difference than is observable in individuals of any other variety of mankind. In stature, the Negro is very much on a par with the European, often reaching six feet, and rarely declining below five and a half. Into the discussion as to the cause of the blackness of the skin in the Negro we have not space to enter. It is generally supposed to depend upon the greater amount of pigment cells in the *Retæ Malpighii*, and in the greater number of cutaneous glands, as compared with the skin of Europeans. In the skin of the Negro there is much oily matter, and he perspires profusely, which serves to keep him in health, while it diffuses a smell far from agreeable to bystanders whose olfactory nerves are at all sensitive. Of the hair of the Negro, Dr Prichard remarks: 'I am convinced that the Negro has hair properly so-called, and not wool. One difference between the hair of a Negro and that of a European, consists in the more curled and frizzled condition of the former. This, however, is only a difference in the degree of crispation, some European hair being likewise very crisp. Another difference is the greater quantity of colouring matter or pigment in the hair of the Negro. It is very probable that this quality is connected with the former, and is its cause, though we cannot determine in what manner one depends upon another; but as these properties vary simultaneously, and are in proportion one to another, we may infer that they do not depend upon independent causes.'

The Negroes, in their native seat, comprise various independent tribes, which are thus classified and enumerated by Dr Latham: 1. *Western Negro Atlantide*, embracing the Woloffs, Sereres, Serawolli, Mandingos, Felups, &c.; Fantis, &c.; the Ghá, the Whidah, Maha and Benin tribes, the Grebo, &c. 2. *Central Negro Atlantide*, embracing the Yarriba, the Tapua, Haussa, Fulahs, Cumbri, Sungai, Kissúr, Bornú, &c.; Begharmi, Mandara, Mobba, Furians, Koldagi. 3. *Eastern Negro Atlantide*, embracing the Shillúk, &c.; Qámamyl, Dallas, &c.; Tibboo, Gongas. This list might, of course, be still further enlarged by reference to the works of Barth, Livingstone, Speke, and other travellers, whose researches have been published since the appearance of Dr Latham's *Varieties of Man*, in 1850.

While these several tribes have their distinctive peculiarities, they yet bear a strong general resemblance to each other, not only in their physical appearance, but in their intellectual capacities, moral instincts, customs, and manners. The Negro intellect is generally acknowledged to be inferior not only to the European, but to that of many primitive races not as yet brought within the pale of civilisation, while it is superior to that of the Australians, Bushmen, and Esquimaux. Some tribes are sunk in the lowest depths of barbarism, and are either ferocious savages, or stupid, sensual, and indolent. This is the case, for the most part, according to Prichard, where the exaggerated Negro type is discernible, as among the Bulloms, Papals, and other tribes on the coast of Western Guinea; also among the tribes near the slave coast, and in the Bight of Benin, where the slave-trade has been carried on to the greatest extent. In other parts they shew a capacity for practising the arts of life. They are ingenious in the construction of their dwellings, they have some knowledge of the working of iron

and other metals, they manufacture arms, dress and prepare the skins of animals, weave cloth, and fabricate numerous useful household utensils. Neither are they altogether deficient in a knowledge of agriculture. These marks of civilisation are, for the most part, apparent in the districts either wholly or partially converted to Mohammedanism. Mungo Park, in his account of Segó, the capital of Bambarra, describes it as a city of 30,000 inhabitants, with houses of two stories high, having flat roofs, mosques in every quarter, and ferries conveying men and horses over the Niger. 'The view of this extensive city,' he says, 'the numerous canoes upon the river, the crowded population, and the cultivated state of the surrounding country, formed altogether a prospect of civilisation and magnificence which I little expected to find in the bosom of Africa.' All tribes of Negroes appear to be passionately fond of music, and shew no little skill in the manufacture of musical instruments. They also express their hopes and fears in extemporary songs. Where Mohammedanism has not been introduced, the religion of the Negroes is nothing but a debased *fetish* worship. They make fetiches of serpents, elephants' teeth, tigers' claws, and other parts of animals, at the dictation of their *fetish man*, or priest. They also manufacture idols of wood and stone, which they worship; and yet, under all this, they have some idea of a Supreme Being. They believe in good and evil spirits, and are perpetually practising incantations to ward off the baneful influence of their spiritual enemies. Their religion, in fact, is one altogether of fear; and as this generally leads to cruelty, we find them for the most part indifferent to the sacrifice of human life. In some parts they even offer up human victims to propitiate their deities. They are cruel to their enemies and prisoners, and often shed blood for the mere savage delight they experience in seeing it flow from their victims. We need only allude to the inhuman *customs*, as they are called, of Dahomey, and the *Yam* and *Adai customs* of the Ashantees, as described by Bowdich, in support of this statement.

This same indifference to human suffering, coupled with the passion of avarice, has doubtless been the mainspring of the slave-trade carried on during so many centuries between the Negroes and European traders in the western coast of Africa. Begun by the Portuguese as early as 1503, when Negro slaves were first imported into the West Indies, sanctioned by Ferdinand of Aragon in 1511, and subsequently by Charles V., legalised in England under Elizabeth, and eventually practised by every maritime nation of Europe, this infamous trade flourished under the sanction of law as late as the year 1807, when it was happily abolished by act of parliament in Great Britain, and is now treated as piracy by almost every civilised nation. Even still, however, it is practised by lawless men, notwithstanding the humane efforts of Great Britain, France, and the United States to suppress it; and the encouragement which it has given to the petty chieftains on the slave coast, and the country behind it, to enrich themselves at the expense of their fellow-countrymen, has contributed more than anything else to retard the progress of civilisation in that part of Africa. 'The region mentioned,' says Prichard, 'has been the great seat of the exportation of Negro slaves, and the tribes on the coast have been reduced to the lowest state of physical and moral degradation by the calamities and vices attendant on that traffic. Throughout Negroland, and especially this part of it, the inhabitants of one district in the interior, the dwellers on one mountain, are ever on the watch to seize the wives and children

of the neighbouring clans, and to sell them to strangers; many sell their own. Every recess, and almost every retired corner of the land, has been the scene of hateful rapine and slaughter, not to be excused or palliated by the 'spirit of warfare, but perpetrated in cold blood, and for the love of gain.'

The custom of polygamy prevails among all the Negro tribes, and where these are constituted into nations or kingdoms, as in Dahomey, the sovereign has often as many as two or three thousand wives, whom he occasionally disposes of as presents to his chief officers and favourites.

The languages of the various nations and tribes of Negroes are very numerous. Vocabularies of nearly 200 languages have been brought from Africa by the Rev. Dr Koelle. 'A slight examination of these vocabularies,' says Mr Edwin Norris, 'seems to shew that there are among the Negro idioms a dozen or more classes of languages, differing from each other at least as much as the more remote Indo-Germanic languages do.' To these Negro idioms Dr Krapf has given the name of *Nigro-Hamitic Languages*. These may perhaps have affinities with some of the other African tongues, but not with any of the great well-defined families of languages. For further information upon this subject, we must content ourselves with referring to Dr Prichard's *Natural History of Man*, and especially to a learned note by Mr Edwin Norris, in vol. i. of that work, page 323.

Of the condition and prospects of the Negroes in the various countries into which they have been imported during the prevalence of the slave-trade, we have scarcely room to speak. They are found in all the West India Islands, to the number of about 3,000,000; in the United States, Brazil, Peru, and other parts of South America; also in the Cape Verde Islands, Arabia, Morocco, &c. In the British West India Islands they were emancipated from slavery in 1834, and in those belonging to France in 1848. Indeed, slavery now exists nowhere in the West Indies, with the single exception of Cuba. In the United States, the Negroes amount to about 4,000,000. Many of these have been emancipated in the course of the civil war still (1864) raging, and all the Negroes of Secession masters have been declared emancipated by proclamation of President Lincoln and act of the Federal congress; at the same time that indemnities have been promised to such loyal states as of their own accord decree emancipation. So far Negro slavery, as an institution of the United States, has received more than one severe blow; neither can its total extinction, we think, be far distant, whatever may be the results politically of the present contest between Federals and Confederates.

NEGROPONT. See EUBŒEA.

NEGROS, ISLA DE. See PHILIPPINE ISLANDS.

NEGUNDO, a genus of trees of the natural order *Aceraceæ* (see MAPLE), differing from the maples chiefly in the dioecious flowers being destitute of petals, and in the pinnated ash-like leaves. The COMMON N. or ASH-LEAVED MAPLE, is a native of North America, and now not infrequent in Britain as an ornamental tree.

NEGUS, a compound of either port or sherry wine and hot water sweetened with sugar and flavoured with lemon-peel and spices. It is a favourite beverage in England, and derives its name from a Colonel Negus, who claimed to be the inventor.

NEHEMIAH, son of Hachaliah, probably of royal descent, is first mentioned in the Bible as cupbearer to Artaxerxes Longimanus in his palace at Shushan about 444 B. C. Having learned the

sad fate of the returned colonists in Jerusalem, he prevailed upon the king to send him to his brethren there with full powers 'to seek their welfare.' For twelve years (444—432), he was untiringly engaged as 'Governor' in works for their safety from within and without: reafortifying the city walls, notwithstanding the hindrances and dangers that beset him on all sides; inducing people from the country to take up their permanent abode in the city, thus promoting its prosperity; and finally, and above all, rekindling the flame of ancient piety and the enthusiasm for the observance of the Law in the hearts of the rough immigrants. He then returned to Persia, trusting to the new vitality which his reforms had, as he thought, infused into the Jewish commonwealth. But not long afterwards—within a period which it is extremely difficult now to fix—he had again to obtain leave from the king, for the purpose of abolishing the many abuses that had crept in during his brief absence from Jerusalem. His energies now were chiefly directed against the foreign elements mixed up with the people, both privately and publicly. He enforced the rigorous observation of Feast and Sabbath, and rearranged the Temple service in accordance with its primeval purity, procuring at the same time the means for its proper support by inducing the people to offer the tithes as of old. His second stay at Jerusalem seems to have lasted between ten and fifteen years; but the dates, as gathered from circumstantial evidence only, are exceedingly vague. He seems to have lived to an old age, but the place and year of his death are unknown. What was the part he took in the formation and redaction of the biblical canon, cannot be investigated in this place. But there can hardly be a doubt, that among the reformatory works undertaken by him, the collection, and perhaps the edition of some of the books of the Old Testament must be included.

The Book known under his name (in 13 chapters) is believed only partly his own work. Recent investigation ascribes to him only the first six chapters, part of the seventh, and the last chapter and half; the rest being a compilation by other hands. Its style and character are very simple, free from anything supernatural or prophetic. Its language resembles much that of Chronicles and Ezra, and is replete with Aramaisms and other foreign, partly Persian words. Originally considered a mere continuation of the Book of Ezra, it was by the Greeks and Latins at first called 'The Second Book of Ezra.' Gradually, however, it assumed its present independent position in the canon after Ezra. It is supposed to have been written or compiled towards the end of N.'s life.

NEILGHERRY (properly NILGIRI) HILLS (Skr. *nīla*, blue, and *giri*, mountain), a remarkable group of mountains in the south of Hindustan, entirely isolated, with the exception of a precipitous granite ridge, 15 miles in width, which connects it with the high table-land of Maisur on the north. Lat. 11° 10'—11° 38' N., long. 76° 30'—77° 10'. The shape of the group is that of a triangle, of which one side faces the district of Malabar on the west. Greatest length, about 40 miles; average breadth, about 15 miles. The base of the mountains is covered by a dense and unhealthy forest, swarming with wild animals, among which are the elephant and tiger; but in the higher regions of the Hills, wood is comparatively scanty. The surface of the group is undulating, rising, in the peak of Dodabetta, near the centre, to the height of 8760 feet, the greatest height, as yet ascertained, in India south of the Himalayas. The Hills for the most part consist of granite, covered often to the depth of

upwards of ten feet by a richly productive black soil. There are several morasses yielding peat, which is used for fuel. The higher lands form a fine open grass country, covered with the vegetation of the temperate zone, and inhabited by a most remarkable tribe, the *Tudas* or *Toruvars* (herdsmen). This tribe numbers only about 2000 persons. The men are tall and handsome, with Roman noses, fine teeth, and large expressive eyes; the women are singularly beautiful. Their religion is Theism; they have no idols. Owing to their great elevation, the N. H. have a delightfully cool climate, and are much resorted to on this account by invalided Europeans. The principal station, and the only place on the Hills that deserves the name of a town, is Utakamand, situated in the centre of the Hills, at an elevation of 7300 feet above sea-level. Its climate is cold and damp during the monsoon; at other times it is intensely dry, and the mean annual temperature is 68°.

NEILGHERRY NETTLE (*Girardinia Leche-naultii*), a plant of the natural order *Urticeæ*, nearly allied to the true nettles, and possessing in a high degree the stinging power which is common in them. It is frequent on all the higher ranges of the Neilgherry Hills. The bark yields a valuable fibre, which the natives obtain by first boiling the whole plant, to destroy its stinging properties, and then peeling the stalks. The fibre is of great delicacy and strength, and is worth £200 a ton in England. The cultivation of the plant is therefore thought likely to be remunerative.—Markham's *Travels*.

NEIRA. See **MOLUCCAS**.

NEIßSE, a town of Prussian Silesia, and a fortress of the second rank, is situated in a broad valley on the Neisse, an affluent of the Oder, 30 miles southwest of Oppeln. It consists of the town proper on the right bank, of the Friedrich's Town, and of the Preussen Fort on the left bank. It contains two great squares, has five Catholic and two Evangelical churches, a hospital, theatre, &c. It carries on manufactures of arms, chemical products, and tobacco, and establishments for spinning and weaving are in operation. Pop. 18,000, including a garrison of 5035 men. N., formerly the chief town of a principality of the same name, and the residence of a prince-bishop, has frequently been the scene of conflict.

NEJIN, an ancient town of Little Russia, in the government of Tchernigof, on the Oster, an affluent of the Dnieper, about 80 miles north-east of Kiev. It fell into the hands of the Lithuanians in 1320, and of the Poles in 1386, but was annexed to Russia in 1654. N. is an industrious town of 18,050 inhabitants, many of whom are Greek immigrants, who settled here during the reign of Catherine II. The principal branch of industry is the cultivation of tobacco. Great quantities of leaf-tobacco are sent hence to St Petersburg, Riga, and Mittau. The chief institutions are two monasteries, 25 churches, and a lyceum.

NELSON, HORATIO, the greatest of Britain's admirals, was born on the 29th September 1758, at Burnham Thorpe, Norfolk, of which place his father, Edmund Nelson, was rector. His mother's maiden name was Suokling, and through her he could claim a collateral kinship with the celebrated Sir Robert Walpole. As a child, he was feeble and sickly; and throughout life his small, frail, and attenuated frame seemed to consort but poorly with the daring and impetuous spirit which 'stirred and lifted him to high attempts.' At the age of 13, he entered the royal navy, commencing his career in the *Raisonnable*, 64 guns, commanded by his uncle, Captain

Suokling. Then, even more than now, promotion in the first stages of the profession was determined by Admiralty interest; and fortunately for him and for England, his uncle, shortly afterwards becoming comptroller of the navy, was able to facilitate his rise. His promotion was nearly as rapid as it could be, and before he was quite 21, he had attained the rank of post-captain, which fairly opened the way for him to the higher honours of the service. Up to this time, no opportunity had been afforded him of achieving any marked distinction, but to all who were brought into contact with him, he had already approved himself a bold and capable officer. Henceforward, for some years, he was nearly constantly employed in a variety of harassing services; and in all his conduct was such, that in no long time he had made for himself a brilliant reputation. His growing fame was as yet, however, chiefly confined to professional circles, no very signal exploit having brought his name prominently before the public. But with the advent of the war with revolutionary France, the time had come when he was to 'flame amazement' on the world by a series of noble deeds, in the lustre of which all other naval glory looks pale. In his obscure years, he seems to have been cheered under what pained him as unmerited neglect by that precience of a grand destiny, which has so often preluded to a career of exceptional splendour. Thus, on one occasion, he writes: 'They have not done me justice. But never mind. One day I'll have a gazette of my own.' And subsequently the same confidence is expressed with something like the depth of a religious conviction: 'One day or other I will have a long gazette to myself. I feel that such an opportunity will be given me. I cannot, if I am in the field of glory, be kept out of sight; wherever there is anything to be done, *there Providence is sure to direct my steps*.' In 1793, appointed to the *Agamemnon*, 64 guns, he took a distinguished part, among other services, in the sieges of Bastia and Calvi, in Corsica, losing an eye at the last of these; and in the celebrated action of Sir John Jervis off Cape St Vincent with the Spanish fleet, to a manoeuvre of extreme and masterly daring, executed by Nelson in defiance of orders, that officer was mainly indebted for the splendid success obtained, and the peerage with which it was rewarded. Though in the interval an expedition which he commanded against Teneriffe had failed disastrously, with loss to himself of his right arm in the assault, it was on all hands admitted that everything was done on the occasion which skill and valour in their highest combination could effect, and N., on his return to England in 1797, was received with general acclamation. He was invested with the Order of the Bath, and a pension of £1000 a year was voted to him. Being next year intrusted with a fleet, he signalled this his first independent command of any magnitude by the stupendous victory of the Nile, memorable in naval annals as the completest annihilation of an enemy on record. See **ABOUKIR**. Finding the French fleet—to which his own was considerably inferior in force—skilfully moored so as to defy ordinary attack, he adopted the novel expedient of doubling on the enemy's ships, and was rewarded with success the most consummate. Of the French line of battle, two ships only escaped to be afterwards captured; and it was considered that solely to a wound in the head, which in the heat of the action prostrated N., did even these owe their temporary safety. Honours were now from all quarters showered upon him; and in particular the gratitude and enthusiasm of his countrymen were signified by the title bestowed

on him of Baron Nelson of the Nile, and a grant of £2000 a year for his own life, and the lives of his two immediate successors. For his services immediately subsequent, in effecting the expulsion of the French from Naples, the Neapolitan king rewarded him with the Dukedom of Bronte and a domain of £3000 a year. These last honours, however, were in one sense dearly purchased. The single suspicion of a blot on his public fame is in regard of his relations with the corrupt court of Naples, and of certain questionable acts into which by these he was led. The only flaw in his private character was his infatuated attachment to Lady Hamilton, the wife of the English ambassador, a woman of questionable antecedents, but perilous fascination, with whom he was here thrown in contact. The influence which she now obtained over him, she continued to the end to exercise. Early in life he had married, and married happily. If to the charms of an impure adventuress he sacrificed, on his return to England, the wife to whom before he had been tenderly devoted, it is not necessary to indulge in comment. Let us compassionate the one cruel frailty of a man in all else and in his proper nature, as gentle and generous as he was brave.

His next magnificent exploit was the battle of Copenhagen in 1801, in which, after a struggle of terrible severity, he shattered the naval power of Denmark, and along with it the dreaded coalition against England of the three northern kingdoms. Never were the characteristic and heroic qualities of the man more brilliantly displayed than on this most trying occasion. In the moral courage to accept responsibility at all hazards, no man ever surpassed him. In the heat of the battle, his chief, Sir Hyde Parker, in deadly anxiety as to the issue of what at a distance seemed to be a hopeless conflict, signalled him to discontinue action. 'Damn the signal!' said N., when this was reported to him. 'Keep mine for closer battle flying. That's the way I answer such signals. Nail mine to the mast.' And with the certainty of professional disgrace and ruin staring him in the face in case of failure, he worked out his grand triumph.

Had N.'s services here ceased, his fame would still have been assured as the greatest of England's naval heroes. But a crowning glory awaited him. In the earlier part of 1805, glowing with fierce ardour and impatience, he had chased half round the world a French fleet of nearly double the force of his own, scared by the very terror of his name; and on the morning of the memorable 21st October of that year, the desire of his eyes was satisfied, when in the Bay of Trafalgar he saw before him the combined navies of France and Spain moving to meet him in frank fight. Of the glorious consummation which followed, we need not speak in detail. Ere night, the power of France upon the seas was annihilated, and her threatened invasion of England had become an abortive dream. But N. was no more. He died as such men wish to die, amid the thunders of his mightiest victory.

The character of N. was, for a man of his greatness, unusually simple and transparent. A more absolute singleness of aim and aspiration than his, it is difficult even to conceive of. Literally on fire with that ardour and passion of enthusiasm, without some tincture of which scarce any man perhaps has ever yet achieved distinction, he was driven by it imperiously in one direction. The greatest of sailors—he was a sailor and little else. Of his genius for command, it would be idle at large to speak. In coolness, foresight, promptitude, instant intuitive decision, and a daring which, even when it seemed at times to touch temerity, was

yet regulated throughout by the nicest calculations of reason, he has perhaps never been quite equalled on the element. His nature was most noble and humane. His heart was as soft as a woman's, and overflowed with all liberal generousities. He had but to be known to be beloved; and of the tender chivalry of his relations with his gallant brethren in arms, it is touching to read.

NELU'MBO (*Nelumbium*), a genus of aquatic plants similar to Water Lilies, and often included under that name, as well as by some botanists in the natural order *Nymphaeaceae* (q. v.); although by others constituted into a distinct order, *Nelumbiaceae*, differing in the want of albumen in the seed, and in the distinct carpels, which are one-seeded, and buried in the cavities of a large fleshy receptacle, which eventually becomes a broad hard bed, full of holes, with the large seeds half buried in them. The flowers and leaves are very similar to those of water-lilies. The species are few, and are found in the warm parts of Asia, in the north of Africa, and in North America. They are all distinguished by the beauty of their flowers. *N. speciosum* is the EGYPTIAN BEAN of Pythagoras,



Lotus (Nelumbium speciosum) :

A, the ripe receptacle of *Nelumbium speciosum*; B, a seed; C, a seed, with the two cotyledons so separated as to show the large plumule which they enclose.

the *Lotus* (q. v.) of the Hindus, held sacred by them and by the people of Thibet. It is also much esteemed and cultivated in China, and elsewhere in the East, for its seeds, roots, leaf-stalks, and flower-stalks, all of which are eaten. It has been used as food by the Egyptians from remote antiquity. The seeds are in size and shape like acorns, with a taste more delicate than that of almonds. The root contains much starch, and *Chinese arrow-root* is said to be obtained from it. Slices of it are often served up at table in China. Great quantities are pickled with salt and vinegar, and eaten with rice. The powdered root makes excellent soup with water or milk. The flowers are generally rose-coloured, seldom white. The ancient Egyptian mode of sowing this plant, by enclosing each seed in a ball of clay, and throwing it into the water, is practised at the present day in India.—*N. luteum* is a North American species, extending almost as far north as Philadelphia; with yellow flowers. The seeds are sought after by children and by Indians, and the farinaceous roots are agreeable when boiled.

NEMAT/ELMIA (derived from the Gr. words *nema*, a thread, and *helmins*, an intestinal worm) is the term given by recent zoologists to a large and important class of the subdivision *Vermes* of the *Articulata*. The worms belonging to this class

of a more or less elongated cylindrical form. Their skin is thick and strong, and is usually wrinkled in such a manner as to give the body an annulated appearance, which, however, disappears if the animal is placed in water. The nervous system in the higher forms (as the *Ascarida*) consists of two lateral ganglia at the anterior extremity, which are united by a slender nervous ring, and from which two lateral nervous trunks proceed to the posterior part of the body; while in the lower forms no distinct nervous system can be recognised. No special organs of the senses are met with; but a general sense of touch is probably present. The digestive organs are extremely simple. In one order (the *Acanthocephala*), no trace of an intestinal canal can be detected; in another order (the *Gordiacea*), there is a mouth, but no anus; while the higher forms are provided with mouth, intestinal canal, and anus. In the higher forms, a kind of vascular system is developed in the skin, in the shape of canals, in which the nutrient fluid is propelled by the movements of the body. No distinct respiratory organs can be detected; but in some genera there are glands whose object is not clearly known. These worms are unisexual; but the males are comparatively rarely found, and are always smaller than the females. With the exception of two families—the *Urolabea* and *Anguillulidæ*, or paste and vinegar eels—all the animals of this class are parasitic; indeed, Carus, in his *Handbuch der Zoologie* (1863), vol. ii. p. 458, goes so far as to say that 'probably all the nematelmia live as parasites, either during their whole lives or during certain stages of their existence.'

The N. are sometimes termed *Round-worms*, just as the *Platyelmia* (tape-worms, flukes, &c.) are called *Flat-worms*. Most commonly, however, the term round-worm is restricted to the *Ascaris lumbricoides*, the most common of the human entozoa. This class is divisible into three very distinct orders—viz., the *Acanthocephala*, which are destitute of an intestinal canal; the *Gordiacea*, which possess an intestinal canal, but no anus; and the *Nematoidæ*, which possess a perfect intestinal canal, provided with two orifices.

NEMATŌIDEA constitute the highest order of the Nematelmia, and indeed of intestinal worms generally, inasmuch as they present a distinct nervous system, a complete intestine provided with mouth and anus, and distinct sexual organs. The history of their development is not fully known; but there is no reason to believe that these animals undergo any remarkable metamorphoses, although some perforate the intestinal walls, and become encysted in parenchymatous organs. The great majority of the N. are parasitic. The N. are divided by Carus into twelve families, all the members of which are known only in a parasitic state of existence, excepting certain genera of the first and second family.

Although the intestinal canal is the most common residence of these worms, some, as *Trichina spiralis*, are found chiefly in the muscles; others, as *Filaria medinensis*, in the subcutaneous cellular tissue; and others in the kidneys, lungs, &c. See ENTŌZOA. For further information regarding these worms, the reader is referred to Eberth's *Untersuchungen über Nematoden* (4to, 1863).

NĒMĒA, anciently the name of a deep and well-watered valley of Argolis, in the Peloponnesus, between Cleonæ and Phlius. It lies north and south, and is from two to three miles long, and more than half a mile broad. It possessed a sacred grove, with a magnificent temple of Zeus, and was celebrated for the games called the *Nemean Games*,

which took place four times in two Olympiads in an adjacent woody valley. This was one of the great national festivals of the Greeks, and, according to one legend, was founded by the seven princes who were combined against Thebes; according to another, by Hercules after his victory over the Nemean Lion. The games consisted partly of exercises of bodily skill and strength—such as chariot-racing, quoit-throwing, wrestling, running in armour, horse-racing, boxing, throwing the spear, and archery, and partly of musical and poetical competitions. The prize was originally a crown of olive twigs, afterwards of parsley. We have eleven odes by Pindar in honour of victors in the Nemean Games.

NĒMĒRTĒS, a genus of marine *Annelida*, the type of a family, *Nemertida*, remarkable for the prodigious length which some of the species attain, which, in their most extended state, is 30 or 40 feet. But the animal which stretches itself out to this length, is capable of suddenly contracting itself to three or four feet. The structure is similar to that of leeches, but there is no sucker. These annelids feed upon molluscs by sucking them out of their shells. They generally lurk in the mud or sand of the sea-coast, and are sometimes drawn up with the nets or lines of fishermen. They twine themselves into knots and coils, apparently inextricable, but without any real entanglement. The life-history of the *Nemertida* is curious. The embryo has at first a ciliated, non-contractile, oval body; from which there issues a small actively contractile worm, leaving behind it the oval skin, and this worm grows to the size already mentioned. The larval state, however, exhibits a cleft with raised edges, which becomes the mouth of the perfect animal.

NĒMĒSĪS, according to Hesiod, the daughter of Night, was originally the personification of the moral feeling of right and a just fear of criminal actions—in other words, of the conscience. Afterwards, when an enlarged experience convinced men that a Divine will found room for its activity amid the little occurrences of human life, N. came to be regarded as the power who constantly preserves or restores the moral equilibrium of earthly affairs—preventing mortals from reaching that excessive prosperity which would lead them to forget the reverence due to the immortal gods, or visiting them with wholesome calamities in the midst of their happiness. Hence originated the latest and loftiest conception of N., as the being to whom was intrusted the execution of the decrees of a strict retributive providence—the awful and mysterious avenger of wrong, who punishes and humbles haughty evildoers in particular. N. was thus regarded as allied to Atē (q. v.) and the Eumenides (q. v.). She was sometimes called Adrastea and Rhanmusia, the latter designation being derived from Rhanmus, a village of Attica, where she had a temple. She was represented in the older times as a young virgin, resembling Venus; in later times, as clothed with the tunic and peplos, sometimes with swords in her hands and a wheel at her foot, a griffin also having his right paw upon the wheel; sometimes in a chariot drawn by griffins. N. is a frequent figure on coins and gems.

NĒNAGH, a market town of Tipperary county, Ireland, distant 95 miles south-west from Dublin; pop. (1861) 6438, of whom 5898 were Roman Catholics, 530 Protestants of the Established Church, and the rest Protestants of other denominations. N. is the assize town of the North Riding of Tipperary, and is a place of more than ordinary pretensions, as well in its public buildings as in the general character of the houses. The ancient keep, called

Nenagh Round, is a striking object, and the court-house, jail, barrack, and union workhouse are imposing edifices. There is a free school, and three national schools, containing (1861) 1175 pupils, of whom 730 are females, and 445 boys. N. is almost entirely without manufactures, but is a place of considerable inland trade.

NEOPHYTE (Gr. *neophytos*, from *neos*, new, and *phuo*, to grow), the name given in early ecclesiastical language to persons recently converted to Christianity. The word is used in this sense by St Paul (1 Tim. iii. 6), and is explained by St Gregory the Great as an allusion to 'their being newly planted in the faith' (Epp. b. v. ep. 51). It differed from Catechumen (q. v.), inasmuch as it supposed the person to have not only embraced the doctrines of the church, but also to have received baptism. St Paul, in the passage referred to, directs Timothy not to promote a neophyte to the episcopate; and this prohibition was generally maintained, although occasionally disregarded in very extraordinary circumstances, such as those of St Ambrose (q. v.). The duration of this exclusion was left for a time to the discretion of bishops; but several of the ancient synods legislated regarding it. The third council of Arles, 524, and the third of Orange in 538, fix a year as the least limit of probation. In the modern Roman Catholic Church the same discipline is observed, and extends to persons converted not alone from heathenism, but from any sect of Christians separated from the communion of Rome. The time, however, is left to be determined by circumstances. The name neophyte is also applied in Roman usage to *newly-ordained priests*, and sometimes, though more rarely, to the *novices* of a religious order.

NEO-PLATONISTS, the name given to an illustrious succession of ancient philosophers who claimed to found their doctrines and speculations on those of Plato. Strictly speaking, however, the Platonic philosophy—that is, in its original and genuine form—expired with Plato's immediate disciples, Speusippus and Xenocrates. Arcesilaus (q. v.), the founder of the New Academy, and at a later period Carneades (q. v.), introduced and diffused a sceptical *Probabilism*, which gradually destroyed that earnest and reverent spirit of intellectual inquiry so characteristic of the great pupil of Socrates. The course of political events in the ancient world also largely assisted in bringing about the same result. The triumphs of the Roman power had been accomplished at the expense of national liberties, and had issued in a general deterioration of moral character, both in the East and the West. Public men, especially, sought, above all things, material gratifications, and came to look upon philosophy itself as only a more exquisite kind of luxury. It was quite natural, therefore, that Scepticism and Eclecticism should become the prevalent forms of philosophy. Besides, the speculations of the older philosophers were felt to be unsatisfactory. When men began to review the long succession of contradictory or divergent systems that had prevailed since the time of Thales the Milesian, in the gray dawn of Greek history, a suspicion appears to have sprung up that reality, certainty, truth, was either not attainable, or could only be attained by selecting something from every system. Moreover, the immensely extended intercourse of nations, itself a result of Roman conquest, had brought into the closest proximity a crowd of conflicting opinions, beliefs, and practices, which could not help occasionally undergoing a confused amalgamation, and in this way presented to view a practical eclecticism, less refined and philosophical indeed than the speculative systems of the day, but

not essentially different from them. This tendency to amalgamation shewed itself most prominently in Alexandria. Placed at the junction of two continents, Asia and Africa, and close to the most cultivated and intellectual regions of Europe, that celebrated city naturally became a focus for the chief religions and philosophies of the ancient world. Here, the East and the West, Greek culture and Oriental enthusiasm, met and mingled; and here, too, Christianity sought a home, and strove to quell, by the liberality of its sympathies, the myriad discords of Paganism. 'Greek Scepticism,' says Mr Lewes, 'Judaism, Platonism, Christianity—all had their interpreters within a small distance of the temple of Serapis.' It is not wonderful, therefore, that a philosophy, which so distinctly combines the peculiar mental characteristics of the East and the West, as that promulgated by the Neo-Platonists, should have originated in Alexandria. Yet, at the same time, it is but right to notice, as does M. Matter in his *Histoire de l'École d'Alexandrie*, that it soon ceased to have any local connection with the city. Its most illustrious representatives were neither natives of Alexandria, nor members of the famous Museum, and they had their schools elsewhere—in Rome, in Athens, and in Asia.

It is not easy to say with whom *Neo-Platonism* commenced. Scholars differ as to how much should be included under that term. By some it is used to designate the whole new intellectual movement proceeding from Alexandria, comprising, in this broad view, the philosophy, 1st, of Philo-Judeus and of Numenius the Syrian; 2d, of the Christian Fathers (Clemens Alexandrinus, Origen, &c.); 3d, of the Gnostics; and 4th, of Ammonius Saccas and his successors. Others, again, would exclude the second of these (though the Alexandrian divines frequently Platonicise); while a third party is disposed to restrict the application of the term to the fourth. The last of these modes of regarding Neo-Platonism is the one most current, and is perhaps the most convenient and definite; yet Bouterwek, Tennemann, Lewes, &c., agree in considering Philo-Judeus (q. v.), an Alexandrian Jew, and (in part) contemporary of Jesus Christ, as the first of the Neo-Platonists—that is to say, as the first who endeavoured to unite the mysteries of Oriental belief with the dialectics and speculations of the Platonists. A similar course was at least partially pursued by the Christian fathers of Alexandria, partly from a predilection for the philosophy in which they had been reared, and partly from a desire to harmonise reason and faith, and to make their religion acceptable to thoughtful and educated pagans; hence, they too may, not without reason, be classed along with Philo, though their spirit and aim are distinctively and even strongly Christian. In Gnosticism, on the other hand, speaking generally, the lawless mysticism of the East predominated, and we see little either of the spirit or logic of Plato. They may therefore be dismissed from the category of Neo-Platonists. Regarding Philo-Judeus and the Alexandrian divines, it must be noticed that they wrote and taught in the interests of their own religion, and had no idea of defending or propagating a heathen philosophy. It is this which strikingly distinguishes them from the school founded by Ammonius Saccas, and also from an independent group of pagan teachers and authors who likewise flourished in the first and second centuries after Christ, and whose main object was to popularise and diffuse the ethics and religious-philosophic system of Plato, by allegorically explaining the ancient mysteries of the popular belief in harmony with the ideas of their master, but, at the

same time, blending with these many Pythagorean and Aristotelian notions. The best-known names of this group are Plutarch (q. v.) and Appuleius (q. v.). These men have a better claim to the title of Neo-Platonists than any of the others. They adhered far more closely to their great master, and were, in fact—to the best of their ability—simply popular exponents of his philosophy. Living at a time when paganism was in a moribund condition, they sought to revive, purify, and elevate the faith in which their fathers had lived. Christianity, a young, vigorous, and hostile system, was rooting itself in the hearts of men deeper and deeper every day, and these disciples of Plato—tenderly attached to their ancestral religion—felt that something must be done to preserve from going out the fires that were feebly burning on the altars of the ancient gods.

But these commentators and expositors of Plato were not remarkable for their philosophical power; a fresh stream of life was first poured into the old channels of Platonic speculation by Ammonius Saccas (q. v.) and Plotinus (q. v.), and it is this fact which gives the school which they established its best claim to the exclusive title of *Neo-Platonist*. 'In no species of grandeur was the Alexandrian school deficient,' as M. Saisset justly observes: 'genius, power, and duration have consecrated it. Re-animating during an epoch of decline the fecundity of an aged civilisation, it created a whole family of illustrious names. Plotinus, its real founder, resuscitated Plato; Proclus gave the world another Aristotle; and in the person of Julian the Apostate, it became master of the world. For three centuries it was a formidable rival to the greatest power that ever appeared on earth—the power of Christianity; and if it succumbed in the struggle, it only fell with the civilisation of which it had been the last rampart' (Lewes's *Biog. Hist. Phil.* p. 259). The essence of all the Alexandrian speculations, we have stated, consists in the blending of Platonic ideas with Oriental mysticism; the peculiarity of the *Neo-Platonists*, strictly so-called, lies simply in the novelty, audacity, and ingenuity of their reasonings. They aimed at constructing a religion on a basis of dialectics. They strove to attain a knowledge of the Highest, and the way in which they endeavoured to accomplish this was by assuming the existence of a capacity in man for passing beyond the limits of his personality, and acquiring an intuitive knowledge of the absolute, the true—that which is beyond and above the fluctuations and dubieties of 'opinion.' This impersonal faculty is called *Ecstasy*. By means of it, man—ceasing, however, it should be observed, to be individual man, i. e., *himself*—can identify himself with the Absolute (or Infinite). Plotinus, in fact, set out from the belief that 'philosophy' (i. e., 'Absolute Truth') is only possible through the identity of the thinker, or rather of the subjective thought, with the thing thought of, or the objective thought. This intuitive grasp or 'vision' of the Absolute is not constant; we can neither force nor retain it by an effort of will; it springs from a divine inspiration and enthusiasm, higher and purer than that of poet or prophet, and is the choicest 'gift of God.'

The god of Plotinus and the other Alexandrians is a mystical Trinity, in the exposition of which they display a dialectical subtlety that even the most ingenious of the schoolmen never reached. The Divine Nature contains within it three Hypostases (Substances); its basis, if we may so speak, is called Unity, also poetically Primitive Light, &c. This Unity is not itself any *thing*, but the principle of all things; it is absolute good, absolute perfection; and though utterly incapable of being conceived by

the understanding, there is that in man that assures him that it—the incomprehensible, the ineffable, *is*. 'It has neither quantity nor quality; neither reason nor soul; it exists neither in motion nor repose; neither in space nor time; it is not a numeric unity nor a point; . . . it is pure *Esse* without Accident; . . . it is exempt from all want or dependency, as well as from all thought or will; it is not a thinking Being, but Thought itself—the principle and cause of all things.' To the sceptic this 'Primitive Light,' we are afraid, will not seem very luminous. From 'Unity,' as the primordial source of all things, emanates 'Pure Intelligence' (*Nous*—the *Vernunft* of modern German metaphysics); its reflection and image, that by which it is intuitively apprehended; from Pure Intelligence, in turn, emanates the 'Soul of the World' (*Psyche tou pantos*), whose creative activity produces the souls of men and animals, and 'Nature'; and finally, from Nature proceeds 'Matter,' which, however, is subjected by Plotinus to such refinement of definition that it loses all its grossness. Unity, Pure Intelligence, and the World-Soul thus constitute the Plotinian Triad, with which is connected, as we have seen, the doctrine of an eternal Emanation, the necessity of which he endeavours to demonstrate by the most stringent logic. Human souls, whose source is the Pure Intelligence, are—by some mysterious fate—imprisoned here in perishable bodies, and the higher sort are ever striving to reascend to their original home. So Plotinus, when in the agonies of death, said calmly to his friends: 'I am struggling to liberate the divinity within me.'

The most distinguished pupil of Plotinus was Porphyry (q. v.), who mainly devoted himself to expounding and qualifying the philosophy of his master. In him we see, for the first time, the presence of a distinctively anti-Christian tendency. Neo-Platonism, which can only be properly understood when we regard it as an attempt to place Paganism on a philosophical basis—to make the Greek religion philosophical, and Greek philosophy religious—did not *consciously* set out as the antagonist of Christianity. Neither Ammonius Saccas nor Plotinus assailed the new faith; but as the latter continued to grow, and to attract many of the most powerful intellects of the age into its service, this latent antipathy began to shew itself. Porphyry wrote against it; Iamblichus (q. v.), the most noted of his pupils, did the same. The latter also introduced a theurgic or 'magical' element into Neo-Platonism, teaching, among other things, that certain mysterious practices and symbols exercised a supernatural influence over the divinities, and made them grant our desires. Magic is always popular, and it is therefore not wonderful that Iamblichus should have had numerous followers. *Ædesius* succeeded to his master's chair, and appears to have had also a considerable number of disciples. To the school of one of them the Emperor Julian belonged, whose patronage for a moment shed a gleam of splendour over Neo-Platonism, and seemed to promise it a universal victory. After a succession of able, but not always consistent teachers, we reach Proclus (q. v.), the last great Neo-Platonist, who belongs to the 5th c., a man of prodigious learning, and of an enthusiastic temperament, in whom the pagan-religious, and consequently anti-Christian, tendency of the Neo-Platonic philosophy culminated. His ontology was based on the Triad of Plotinus, but was considerably modified in detail; he exalted 'Faith' above 'Science' as a means of reaching the Absolute Unity; was a believer in Theurgy, and so naturally laid great stress upon the ancient Chaldean oracles, Orphic hymns, mysteries, &c., which

he regarded as divine revelations, and of which he considered himself—as, indeed, he was—the last great ‘interpreter.’ His hostility to the Christian religion was keen; in its success he saw only the triumph of a vulgar popular superstition over the refined and beautiful theories of philosophy; it was as if he beheld a horde of barbarians defacing the statues and records of the Pantheon. The disciples of Proclus were pretty numerous, but not remarkable for high talent. Perhaps the ablest of his successors was Damascius, in whose time the Emperor Justinian, by an arbitrary decree, closed the schools of the heathen philosophers. ‘The victims,’ says Cousin (*Cours d’Histoire de la Philosophie Moderne*), ‘of fierce retaliation, and of an obstinate persecution, these poor Alexandrians, after having sought an asylum in their dear East, at the court of Oshroes, returned to Europe (533 A.D.), were dispersed over the face of the earth, and the most part extinguished in the deserts of Egypt, which were converted for them into a philosophic Thebaïs.’ See Fichte, *De Philosophia Novæ Platonice Origine* (Berl. 1818); Bouterwek, *Philosophorum Alexandrinorum ac Neo-Platoniorum, recensio accurata* (Gött. 1821); Matter, *Essai Historique sur l’Ecole d’Alexandrie* (2 vols. Par. 1820); Simon, *Histoire de l’Ecole d’Alexandrie* (2 vols. Par. 1845); Barthélemy St Hilaire, *De l’Ecole d’Alexandrie* (Par. 1845); Lewes, *Biographical History of Philosophy* (1867); and Tennemann’s *Manual of the History of Philosophy* (trans. by Morrell; Bohn, 1852).

NEOZOIC (Gr. new life), a term introduced by Edward Forbes to include all the strata from the Trias to the most recent deposits. They are generally divided into the two great groups of Secondary and Tertiary Rocks. This division is, however, quite arbitrary—the chief point of difference depending on the occurrence in the Tertiary deposits of species supposed to be the same as some still living. There is no palæontological nor petralogical break similar to that which exists between the Permian and Trias. Forbes, accordingly, suggested the obliteration of the division between the Secondary and Tertiary series, and the division of all geological time into two epochs—the Palæozoic and the Neozoic.

NEPA AND NEPIDÆ. See WATER-SCORPION.

NEPAUL, an independent kingdom of Hindustan, comprises a portion of the southern slope of the Himalayas, is bounded on the N. by Tibet, on the S. and W. by British India, and on the E. by Sikim, a protected state. Long. 80° 15’—88° 15’ E. It is 500 miles in length, by about 100 miles in average breadth. Area, 54,000 square miles; pop. estimated at 1,940,000. The kingdom is separated from the plains of India by the long narrow strip of land, resembling an English down, but unhealthy, called the Terai, which extends along the whole southern border. North of this, and running parallel with it, is the great forest of N., from 8 to 10 miles broad. North of this strip is a tract of hilly country, and above that are two tracts of greater elevation, the first of which may be called mountainous, while the second might appropriately be called Alpine, if it did not comprise among its mountains, peaks, which, like Mount Everest and Dhawalagiri, attain almost twice the elevation of Mont Blanc. The principal rivers are the Kurnalli, the Rapti, the Gunduk with its great tributaries, and the Sun Kosi. The climate, most unhealthy in the Terai, is healthy and pleasant in the hilly and mountainous districts, suggesting that of Southern Europe. In the *Valley of N.*—the district surrounding the capital—the heat of Bengal, which is felt in

the hollows, may be exchanged for the cold of Russia by ascending the slopes of the hills which enclose it. The soil is extremely rich and fruitful. Barley, millet, rice, maize, wheat, cotton, tobacco, sugarcane, pine-apple, and various tropical fruits are cultivated. Gold has not been found, but iron and copper mines are worked. The inhabitants consist mainly of two tribes—the Ghurkas, whose chief occupation is war, and the Newars, who are principally artisans. The capital of the country is Khatmandu (q. v.).

NEPENTHES, the only known genus of a natural order of exogenous plants called *Nepenthaceæ*, consisting of herbaceous or half-shrubby plants with dioecious flowers, natives of swampy ground in India and China, chiefly remarkable for their leaves. Each leaf consists of a dilated foliaceous petiole, prolonged beyond its foliaceous part, as if it were the prolongation of the midrib of a leaf,



Pitcher Plant (*Nepenthes distillatoria*).

and terminating in a pitcher (*ascidium*), from which the name PITCHER PLANT has been very generally given to the species of this order. The pitcher is terminated by a lid, which is regarded as the true blade of the leaf. The fluid found in these pitchers is probably in some way useful for the nourishment of the plant, and is a secretion of the plant itself. It varies much in quantity. Insects often enter the pitcher, and are drowned in it. It contains binoxalate of potash. Pitcher plants (*N. distillatoria*) are not uncommon in our hothouses.

NEPHELIUM. See LITCHI.

NEPHRITE, a mineral which is not unfrequently called Jade (q. v.), and of which Axestone (q. v.) is very generally considered a variety. It is composed of silica, magnesia, and lime; is compact, with a coarse splintery fracture, very tenacious, sometimes translucent, greasy to the touch, and of a green or greenish colour. It is found in granite, gneiss, greenstone, &c., in many parts of the world. Very fine specimens are brought from Persia, Siberia, and China, and are known as *Oriental Jade*. The kind called *Indian Jade* is olive green, and strikes fire with steel; that from China is whitish, and does not strike fire. N. is used for ornaments. The Turks make it into handles for sabres and daggers. Many imaginary virtues were once ascribed to it, such as the cure of epileptic fits and of nephritic (Gr. *nephrōs*, kidney) complaints; hence its name.

NEPHRITIS (Gr. *nephros*, kidney), inflammation of the Kidneys (q. v.).

NEPOMUC. See JOHN OF NEPOMUK.

NEPOS, CORNELIUS, a Roman historian, born in the 1st c. B. C., but the place and precise time of his birth are unknown. He was the friend of Cicero and Catullus. The only work of N.'s which has survived (if indeed it be his), is a series of twenty-five generally brief biographies of warriors and statesmen, mostly Greeks. These biographies are distinguished by the purity of their Latinity, the conciseness of their style, and their admirable exhibition of character, but sufficient care has not been exercised in the examination of authorities, nor is the relative importance of things duly regarded. Until the middle of the 16th c., these biographies, on the strength of the titles given in the various MSS., were generally ascribed to Æmilius Probus, a writer who lived in the latter part of the 4th c.; but in 1569, an edition was put out by the famous Dionysius Lambinus, who pronounced the so-called *Lives* of Æmilius Probus to be in reality the lost work of Cornelius Nepos, *De Viris Illustribus*. His weightiest argument is drawn from the excellence of the Latin, and the chastity of the style, so unlike the corrupt and florid language of the Decline. Many critics hold that these *Lives* ought to be regarded as an abbreviation of the work of N. by Probus. This hypothesis is not without its difficulties, but it is perhaps the least objectionable of any. There are many editions, among which may be mentioned those of Van Staveren (Leyd. 1773), of Tzschucke (Gott. 1804), and of Bremi (Zur. 1820); and the book is in general use as a school-book. It has been very frequently translated into English and other languages.

NEPTUNE, an ancient Italian god. It is doubtful whether he was originally a marine deity at all,



Neptune.

for the old Italians were the very opposite of a maritime people, yet his name is commonly connected with *nato*, to swim; hence at an earlier period he may have borne another designation, afterwards forgotten. When the Romans became a maritime power, and had grown acquainted with Grecian mythology, they, in accordance with their usual practice, identified him with the Greek god whom he most resembled. This was *Poseidon*, also *Poteidan* (connected with *potos*, a drink, *pontos*, the sea, and *potamos*, a river). Poseidon appears in his most primitive mythological form as the god of water in general, or the fluid element. He was the son of Cronos (Saturn) and Rhea, and a brother of Jupiter. On the partition of the universe amongst the sons of Cronos, he obtained the sea as his portion, in the depths of which he had his palace near Ægæa, in Eubœa. Here also he kept his brazen-hoofed and golden-maned steeds, in a chariot drawn by which

he rode over the waves, which grew calm at his approach, while the monsters of the deep, recognising their lord, made sportive homage round his watery path. But he sometimes presented himself at the assembly of the gods on Olympus, and in conjunction with Apollo, built the walls of Troy. In the Trojan war he sided with the Greeks; nevertheless he subsequently shewed himself inimical to the great sea-wanderer Ulysses, who had blinded his son Polyphemus. He was also believed to have created the horse, and taught men its use. The symbol of his power was a trident, with which he raised and stilled storms, broke rocks, &c. According to Herodotus, the name and worship of Poseidon came to the Greeks from Libya. He was worshipped in all parts of Greece and Southern Italy, especially in the seaport towns. The Isthmian games were held in his honour. Black and white bulls, boars, and rams were offered in sacrifice to him. N. was commonly represented with a trident, and with horses or dolphins, often along with Amphitrite, in a chariot drawn by dolphins, and surrounded by tritons and other sea-monsters. As befitted the fluctuating element over which he ruled, he is sometimes figured asleep or reposing, and sometimes in a state of violent agitation.

NERBU'DDAH, a river of Hindustan, rises in the Vindhya Mountains, at a height of from 3000 to 4000 feet above sea-level, in lat. 22° 40' N., long. 81° 52' E. It flows west, past Jabalpur (190 miles from its source), where the great depression between the Vindhya Mountains on the north and the Satpura Mountains on the south, known as the Valley of the N., begins. The other principal towns on its banks are Hoshangabad, Burwani, and Barneh. At Hoshangabad it is 900 yards wide, and from five to six feet in depth. At Barneh it begins to expand into a wide estuary, and after flowing 30 miles further, it falls into the Gulf of Cambay. Entire length about 800 miles, of which 90 miles are navigable for river-boats.

NERCHI'NSK, an important mining town of Russia, Eastern Siberia, in the Trans-Baikal Territory, on the Nercha, a tributary of the Shilka, in lat. 51° 58' N., long. 116° 35' E., 4707 miles from St Petersburg. It was founded in 1658, and has from 4000 to 5000 inhabitants. The district, of which N. is the centre, yields 2166 pounds of gold yearly, together with large quantities of silver, lead, and iron, and precious stones. The only tin-mines in the empire are worked here. The soil in the vicinity is fertile, and the climate mild and agreeable.

NEREIS, a genus, and **NEREIDÆ**, a family of *Annelida*, having a long slender body, a distinct head, with tentacles and eyes; the whole body



Nereis.

covered with tubercles, and the gills lobed and tufted. They are all marine, and generally hide under rocks or in the sand. They swim actively,

by rapid and undulating inflections of the body, and by the aid of numerous oars arranged along the sides; each formed of a stout footstalk, numerous bristles, and a flap. The proboscis is thick, strong, and armed with two jaws.

NEREITES, the name given to animals which have left their impress on the Silurian Rocks, and which exhibit a form similar to the modern Nereis. They occur on the surface of the laminae of fine shales, over which, when it was soft, the creature moved, leaving a long and tortuous trail, which is generally found to terminate in a more defined representation produced apparently by the body itself, although every trace of it has disappeared. See ICHNOLOGY, fig. 2.

NERI, PHILIP DE, a saint of the Roman Catholic Church, and founder of the Congregation of the Oratory (q. v.), was born of a distinguished family in Florence, July 21, 1515. His character, even in boyhood, foreshadowed the career of piety and benevolence to which he was destined, and he was commonly known among his youthful companions by the name of 'good Philip.' On the death of his parents, he was adopted by a very wealthy uncle, with whom he lived for some time at San Germano, near Monte Cassino, and by whom he was recognised as his destined heir. But he relinquished all these prospects, for a life of piety and charity, and having come to Rome in 1534, he there completed his philosophical and theological studies, and won the esteem and reverence of all by his extraordinary piety, and his benevolence and activity in every good work whether of charity or of religion. Although he did not receive priest's orders till 1551, he had already been for years one of the most earnest and devoted in all the pious works of Rome for the instruction of the poor, the care of the sick, and the reclamation of the vicious; and in 1550, in unison with several of his friends, he established a confraternity for the care of poor pilgrims visiting Rome, and other houseless persons, as well as of the sick generally, which still subsists, and which has numbered among its associates many of the most distinguished members of the Roman Catholic Church. This confraternity, however, is chiefly noteworthy as having been the germ of the far more celebrated CONGREGATION OF THE ORATORY (q. v.), which was founded by St Philip in concert with his friends Baronius and Tarugio, both afterwards cardinals, Sabriati, and some others. Besides the general objects above indicated, and the spiritual duties designed for the personal sanctification of the members, the main object of this association was the moral instruction and religious training of the young and uneducated, who were assembled in chapels or oratorios, for prayer and for religious and moral instruction. As a further means of withdrawing youth from dangerous amusements, sacred musical entertainments (thence called by the name of *oratorio*) were held in the oratory, at first consisting solely of hymns, but afterwards partaking of the nature of sacred operas or dramas, except that they did not admit the scenic or dramatic accompaniments of these more secular compositions. Religious and literary lectures also formed part of his plan, and it was in the lectures originally prepared for the Oratory that, at the instance of N., the gigantic *Church History* of Baronius had its origin. The personal character of N., the unselfish devotedness of his life, his unaffected piety, his genuine love of the poor, his kindly and cheerful disposition, and, perhaps, as much as any of the rest, a certain quaint humour, and a tinge of what may almost be called drollery which pervaded many of his sayings and doings, contributed to popularise his institute,

and to engage the public favour for himself and his fellow-labourers. He himself enjoyed the reputation of sanctity and of miracles among his fellow-religionists almost beyond any of the modern saints; and he may still be described as emphatically the popular saint of the Roman people. He lived to an extreme age in the full enjoyment of all his faculties, and in the active discharge to the last of all the charitable duties to which his life had been devoted. He died at the age of 80, May 26, 1595. He was canonised by Gregory XV. in 1622. His only literary remains are his *Letters* (8vo, Padua, 1751); the *Constitutions* of his congregation, printed in 1612; some short spiritual treatises, and a few sonnets which are printed in the collection of *Rime Oneste*.

NERIUM. See OLEANDER.

NERO, Roman emperor from 54 A.D. to 68 A.D., was born at Antium, on the coast of Latium, 15th December 37 A.D., and was the son of Cn. Domitius Ahenobarbus and of Agrippina, the daughter of Germanicus Cæsar, and sister of Caligula. His mother becoming the wife of the Emperor Claudius, Claudius adopted him (50 A.D.), and his name, originally L. Domitius Ahenobarbus, was changed to Nero Claudius Cæsar Drusus Germanicus. After the death of Claudius (54 A.D.), the Prætorian Guards, at the instigation of Afranius Burrhus, their prefect, declared him emperor, instead of Claudius's son Britannicus, and their choice was acknowledged both by the senate and the provinces. His reign began with the semblance of moderation and good promise, under the guidance of Burrhus and his tutor Seneca the philosopher; but the baleful influence of his mother, together with his own moral weakness and sensuality, frustrated their efforts, and he soon plunged headlong into debauchery, extravagance, and tyranny. He caused Britannicus, the son of Claudius, to be treacherously poisoned at the age of 14, because he dreaded him as a rival, and afterwards (59 A.D.) caused his own mother Agrippina (with whom he was latterly on bad terms) to be assassinated, to please his mistress Poppæa Sabina (the wife of his principal boon-companion Otho, afterwards emperor), in order to marry whom he also divorced and afterwards put to death his wife Octavia (aged 20), the sister of Britannicus. The low servility into which the Roman senate had sunk at this time, may be estimated from the fact that it actually issued an address congratulating the hateful matricide on the death of Agrippina. N. himself, on the other hand, confessed that he was ever haunted by the ghost of his murdered mother. The affairs of the empire were at this time far from tranquil. In 61 A.D., an insurrection broke out in Britain under Queen Boadicea, which was, however, suppressed by Suetonius Paulinus. The following year saw an unsuccessful war against the Parthians in Armenia. At home, matters were not much better. The emperor was lampooned in verse; the senate and priesthood, alike venal, were also satirised by audacious malcontents; Burrhus, a valuable friend, died; and even Seneca, though not a great moralist, out of his books, thought it only decent to remove from court. In July 64, occurred a great conflagration in Rome, by which two-thirds of the city were reduced to ashes. N. himself is usually believed to have been the incendiary. It is said that he admired the spectacle from a distance, reciting verses about the burning of Troy, but many scholars are doubtful whether he really had any hand in it. At all events he laid the blame on the Christians—that mysterious sect, who, like the Jews in the middle ages, were the cause of all otherwise inexplicable calamities, and persecuted them with great fury. Moreover, he rebuilt the

city with great magnificence, and reared for himself on the Palatine Hill a splendid palace, called, from the immense profusion of its golden ornaments, the *Aurea Domus*, or Golden House; and in order to provide for this expenditure, and for the gratification of the Roman populace by spectacles and distributions of corn, Italy and the provinces were unsparingly plundered. A conspiracy against him failed in the year 65, and Seneca and the poet Lucan fell victims to his vengeance. In a fit of passion he murdered his wife Poppaea, by kicking her when she was pregnant. He then proposed to Antonia, the daughter of Claudius, but was refused, whereupon he caused the too fastidious lady to be put to death, and married Stabilla Messallina, after killing her husband. He also executed or banished many persons highly distinguished for integrity and virtue. His vanity led him to seek distinction as a poet, a philosopher, an actor, a musician, and a charioteer, and he received sycophantic applauses, not only in Italy, but in Greece, to which, upon invitation of the Greek cities, he made a visit in 67. But in 68, the Gallic and Spanish legions, and after them the Prætorian Guards, rose against him to make Galba emperor, and N. fled from Rome to the house of a freedman, Phæon, about four miles distant. The senate, which had hitherto been most subservient, declared him an enemy of his country, and the tyrant ended his life by suicide, 11th June 68. One is sorry to learn that such a wretch had a taste for poetry, and was skilled in painting and modelling.

NERVA, M. COCCURIUS, a Roman emperor, elected by the senate after the murder of Domitian, 18th September 96. He was born 32 A.D., of a family belonging to Narnia, in Umbria, and twice held the honour of consulship before his election to the dignity of emperor. He displayed great wisdom and moderation, rectified the administration of justice, and diminished the taxes; but finding himself, upon account of his advanced age, not vigorous enough to repress the insolence of the Prætorian Guards, he adopted M. Ulpius Trajanus, then at the head of the army of Germany, who succeeded him on his death, 27th January 98. After his decease, he obtained an apotheosis.

NERVOUS SYSTEM, THE, is composed in all vertebrated animals of two distinct portions or systems—viz., the *cerebro-spinal* and *sympathetic* or *ganglionic*.

The *cerebro-spinal system* includes the brain and spinal cord (which form the *cerebro-spinal axis*), and the cranial and spinal nerves. It was termed by Bichat the nervous system of animal life, and comprises all the nervous organs concerned in sensation, volition, and mental action.

The *sympathetic system* consists essentially of a chain of ganglia connected by nervous cords, extending from the cranium to the pelvis, along each side of the vertebral column, and from which nerves with large ganglionic masses proceed to the viscera and blood-vessels in the cavities of the chest, abdomen, and pelvis. It was termed by Bichat the nervous system of organic life, since it seems to regulate—almost or quite independently of the will—the due performance of the functions of the organs of respiration, circulation, and digestion.

The essential parts of the *cerebro-spinal axis* are described in the articles BRAIN, CEREBRUM and CEREBELLUM, and SPINAL CORD. The brain and spinal cord are covered and protected by three membranes or *meninges*, as they are frequently termed—viz., the *dura mater*, the *arachnoid*, and the *pia mater*. The *dura mater* is a strong fibrous membrane, which supplies the cranial bones with

blood in early life, and adheres firmly to their inner surface. It is less closely attached to the bony walls of the spinal canal. Inside the cranium it gives off processes (such as the *falk cerebri*, *tentorium cerebelli*, and *falk cerebelli*) which divide and support different parts of the brain; it gives a strong fibrous sheath to every nerve; and by splitting into two layers at certain points, it forms receptacles for venous blood, which are termed SINUSES (q. v.). The *arachnoid* (so called from its being supposed to be as thin as a spider's web) is a serous membrane, and, like all serous membranes, is a closed sac, consisting of a parietal and a visceral layer. The parietal layer adheres to the inner surface of the *dura mater*, to which it gives a smooth, polished appearance; while the visceral layer somewhat loosely invests the brain and spinal cord, from direct contact with which, however, it is separated by the intervention of the *pia mater* and some loose areolar tissue. In most regions there is an interval between the visceral layer of the *arachnoid* and the *pia mater*, which is called the *sub-arachnoid cavity*, and is filled during life by the *cerebro-spinal fluid*. This fluid, which varies in quantity from two to ten ounces, keeps the opposed surfaces of the *arachnoid* in close contact, and affords mechanical protection to the nervous centres which it surrounds, and guards them against external shocks. It is accumulated in considerable quantity at the base of the brain, where it serves for the protection of the large vessels and nerves situated there. In fracture of the base of the skull, the draining away of this fluid, often in very large quantity, through the external auditory meatus, is often one of the most significant symptoms. It is doubtless secreted by the *pia mater*, which is the immediate investing membrane of the brain and spinal cord. This membrane consists of minute blood-vessels, held together by an extremely fine areolar tissue. It dips down between the convolutions and fissures of the brain, and is prolonged into the interior, forming the *velum interpositum* and the choroid plexuses of the fourth ventricle. It is by means of this membrane that the blood-vessels are conveyed into the nervous substance.

We now proceed to notice the nerves connected with the cerebro-spinal centre or axis. These are usually described in two classes—the *spinal* and the *cranial* or *encephalic*. The former class consists of all those which arise from the spinal cord, and emerge from the spinal canal through the intervertebral foramina; while the latter includes those which arise from some part of the cerebro-spinal centre, and emerge through foramina in the cranium or skull.

The *Spinal Nerves* (exclusive of the spinal accessory nerve, which, from the fact that it emerges from the skull, is usually ranked among the cranial nerves) are thirty-one on either side, there being a pair for each pair of intervertebral foramina (whose formation is described in the article VERTEBRÆ AND VERTEBRAL COLUMN), and for the foramina between the atlas (the first or highest vertebra) and the occipital bone at the base of the skull. Every spinal nerve arises from the cord by two roots, an anterior and a posterior, of which the latter is distinctly the larger. Each root passes out of the spinal canal by a distinct opening in the *dura mater*. Immediately after its emergence, a ganglion is seen on the posterior root, and in the anterior surface of this ganglion the anterior root lies imbedded. Just beyond the ganglion, but not at all previously, the nervous fibres of both roots intermingle, and a compound nerve results. The trunk thus formed separates immediately after it has passed through the intervertebral canal into two divisions—the anterior and posterior—each of which contains

filaments from both roots, and possessing, as will be immediately shewn, perfectly different functions. These divisions, of which the anterior is considerably the larger, proceed to the anterior and posterior parts of the body respectively, and are

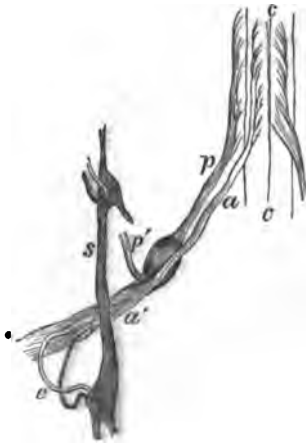

Fig. 1.—Roots of a Dorsal Spinal Nerve, and its union with the Sympathetic:
e, e', anterior fissure of the spinal cord; *a*, anterior root; *p*, posterior root with its ganglion; *a'*, anterior division or branch; *p'*, posterior branch; *s*, sympathetic; *e*, its double junction with the anterior branch of the spinal nerve by a white and a gray filament, the respective natures of which are subsequently described.—From Todd and Bowman.

distributed to the skin and the muscles. The anterior branch communicates with the sympathetic nerve, as is shewn in the figure. The mode of connection of the roots of the nerves with the cord is noticed in the article SPINAL CORD. These nerves are arranged in classes, according to the regions of the spine in which they originate, and we thus speak of eight cervical, twelve dorsal, five lumbar, and six sacral nerves on either side.

The discovery of the separate functions of the anterior and posterior roots of the spinal nerves, which has been characterised as the first important step towards a right understanding of the physiology of the nervous system, was made by our distinguished countryman Sir Charles Bell, although there is reason to believe that Magendie, without any knowledge of Bell's experiments, arrived at similar conclusions at nearly the same time. The original experiments consisted in laying open the spinal canal in rabbits, and irritating or dividing the roots of the spinal nerves. It was observed that irritation of the anterior roots caused muscular movement, and that the posterior roots might be irritated without giving rise to any muscular action; while division of the posterior roots did not impair the voluntary power over the muscles. Hence it was inferred that the anterior roots were motor (or conveyed motive power to muscles), and the posterior roots not motor; but it was not fully determined what degree of sensibility remained in parts supplied from the divided roots. Numerous physiologists arrived at similar results to those of Bell; but the most conclusive experiments are those of Müller, who operated on frogs, in which, from the great width of the lower part of the spinal canal, the roots of the nerves can be exposed with great facility. In these experiments, it was found that irritation of the anterior root always excited muscular contraction, while no such effect followed irritation of the posterior root; that section of the anterior root caused paralysis (or loss of power) of

motion, while section of the posterior root caused paralysis of sensation; and that when the anterior roots of the nerves going to the lower extremity were cut on one side, and the posterior roots on the other, voluntary power without sensation remained in the latter, and sensation without voluntary motion in the former. The obvious conclusion to be derived from these experiments is, that the anterior root of each spinal nerve is *motor*, and the posterior *sensitive*. (In place of the terms *sensitive* and *motor*, the terms *afferent* and *efferent* are now frequently used. The functions of the nerves being to establish a communication between the nervous centres and the various parts of the body, and *vice versa*; an *afferent* nerve communicates the impressions made upon the peripheral nervous ramifications to the centres, while an *efferent* nerve conducts the impulses of the nervous centres to the periphery.)

The *Cranial Nerves*, although twelve in number on either side, were arranged by Willis (*Cerebri Anatomie; cui accessit Nervorum Descriptio et Usus*, 1664), whose system is still generally adopted, in nine pairs, which, taken from before backwards in the order in which they are transmitted through the foramina at the base of the skull, stand as follows: 1st, Olfactory; 2d, Optic; 3d, Motores Oculorum; 4th, Pathetic; 5th, Trifacial; 6th, Abducentes; 7th, Portio Dura or Facial, Portio Mollis or Auditory; 8th, Glossopharyngeal, Par Vagus or Pneumogastric, Spinal Accessory; 9th, Hypoglossal.

They may be subdivided into three groups, according to their functions—viz *Nerves of Special Sense*—the Olfactory (see *Nose*), Optic (see *EYE*), and Auditory (q. v.); *Nerves of Motion*, or *Afferent Nerves*—the Motores Oculorum, Pathetic, Abducentes, Facial, and Hypoglossal; and *Compound Nerves*—the Trifacial, Glossopharyngeal, Pneumogastric, and Spinal Accessory.

The reason why no nerve of Taste is included in the above arrangement amongst the nerves of special sense will be subsequently seen; and we proceed briefly to notice the functions of the motor cranial nerves.

The 3d, 4th, and 6th pairs—the *Motores Oculorum*, *Pathetic*, and *Abducentes*—together make up the apparatus by which the muscles of the orbit (the four Recti, the superior and inferior Oblique, and the Levator Palpebræ) are called into motion, and are sufficiently noticed in the article *EYE*.

The *Facial Nerve*, or the *Portio Dura* of the 7th pair, is divisible into three stages. The first stage is the intracranial, from its origin to its exit from the cranial cavity, in association with the *Portio Mollis*, or *Auditory Nerve* (q. v.), at the internal auditory meatus. The second stage is contained in the *Aqueduct of Fallopius*, a bony canal lying in the petrous portion of the temporal bone. In this stage it anastomises with other nerves, and thus *sensory* fibres are introduced into it from the 5th pair and other sources, which make irritation of some of its branches to cause pain. The third stage commences with the emergence of the nerve through the stylo-mastoid foramen. The nerve now lies in the parotid gland (which is not shewn in the figure), and after giving off the *posterior auricular*, and a few smaller branches, finally divides into the *temporal*, *facial*, and *cervical* branches (see 3, 5, and 9 in fig. 2). This diverging distribution of the nervous branches over the face forms the *pes anserinus* of the older anatomists, from the supposed resemblance to the expanded foot of a goose. Careful dissection of this nerve shews that the great majority of its fibres are distributed to muscles; and indeed, if we except the muscles of mastication, which receive their motor power from the 3d division of the 5th

pair, this may be regarded as the general motor nerve of the face. The muscles which are supplied by the facial nerve are chiefly those upon which



Fig. 2.—Distribution of the Facial Nerve and of the Branches of the Cervical Plexus :

1, the facial nerve at its emergence from the stylo-mastoid foramen; 3, temporal branches communicating with (4) the frontal branches of the fifth or trifacial nerve; 5, infra-orbital branches, communicating with (6) the infra-orbital branches of the fifth nerve; 7, maxillary branches communicating with (8) the mental branch of the fifth nerve; 9, cervico-facial branches; 15, the spinal accessory nerve giving off a branch to the trapezius muscle.

the aspect of the countenance and the balance of the features depend. The power of closing the eyelids depends upon this nerve, as it alone supplies the orbicularis palpebrarum; and likewise that of frowning, from its influence upon the corrugator supercilli. Anatomy indicates that this nerve is the motor nerve of the superficial muscles of the face and ear, and of the deep-seated muscles within the ear. This conclusion is abundantly confirmed by comparative anatomy. For wherever the superficial muscles of the face are well developed, and the play of the features is active, this nerve is large. In monkeys it is especially so. That extremely mobile instrument, the elephant's trunk, is provided with a large branch of the facial as its motor nerve. In birds, on the other hand, it is very small.—Todd and Bowman, *Physiological Anatomy and Physiology of Man*, vol. ii. p. 107.

Before Sir Charles Bell commenced his experiments on the functions of the nerves, it was believed that the facial was the nerve of sensibility of the face, and it was on several occasions divided with the view of relieving tic douloureux, of which it was supposed to be the seat. But the operation, of course, yielded no relief, and always inflicted a permanent injury, since it was succeeded by paralysis of the facial muscles, with total loss of control over the features and over the closing of the eye, on the side on which the operation was performed.

The treatment of facial palsy which is often, especially if it arises from cold, a very temporary affection, although usually a very alarming one to the patient and his friends, is described in the article PARALYSIS.

The *Hypoglossal Nerve* (derived from the Greek words *hypo*, under, and *glotta*, the tongue) escapes from the cavity of the skull by the anterior condyloid foramen, and passes outwards and forwards around

the pharynx to the interior surface of the tongue, where it breaks up into its terminal branches, which supply the muscular structure of that organ with motor power. This nerve communicates with the pneumogastric nerve, with the sympathetic (by branches derived from the superior cervical ganglion), and with the cervical plexus, soon after its emergence from the cranium; and subsequently, as it curves round the occipital artery (see fig. 3), it

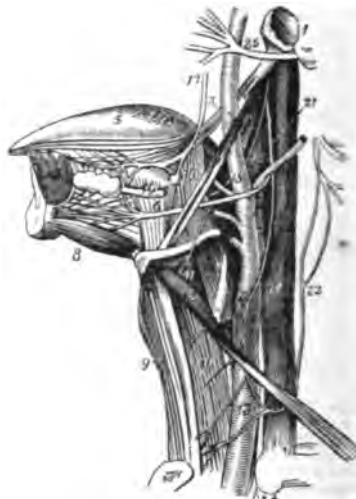

Fig. 3.—This figure illustrates the Anatomy of the Side of the Neck, and shows, *inter alia*, the Nerves going to the Tongue :

1, portion of temporal bone, showing the external auditory meatus and mastoid and styloid processes; 5, the tongue; 13, the common carotid artery; 14, the internal jugular vein; 15 and 16, the external and internal carotids; 17, the gustatory branch of the fifth nerve; 20, the glossopharyngeal nerve; 21, the hypoglossal nerve; 22, the descending noni; 24, the pneumogastric nerve, lying between the carotid artery and the jugular vein; 25, the facial nerve.

gives off the long anastomosing branch known as the *Descendens noni*.

Experiments on living animals, comparative anatomy, and pathological investigations, alike indicate that this is the motor nerve of the tongue. In cases of paralysis of this nerve, the power of articulation is much injured or totally destroyed; and this is often one of the first symptoms which lead the physician to apprehend serious cerebral lesion.

We now proceed to the consideration of the *Compound Nerves*, beginning with the *Trifacial or Fifth Nerve*. This nerve, as was first pointed out by Sir Charles Bell, presents a remarkable resemblance to the spinal nerves in its mode of origin; for it arises by two roots, one large and the other small, and on its larger root, as on the posterior and larger root of the spinal nerves, is a distinct ganglion; the two roots being quite distinct until after the formation of the ganglion, when the lesser one coalesces with the lowest branch, which emerges from the ganglion to form the inferior maxillary nerve. This ganglion, which is known as the Gasserian Ganglion, and which is formed upon the larger root of the nerve, lies upon the upper surface of the petrous portion of the temporal bone, and is of a somewhat triangular form, with its base directed forwards and outwards. From this base there proceed three nerves—viz the ophthalmic, on the inside; the superior maxillary, in the middle; and the inferior maxillary, externally. The first two of these nerves consist exclusively of fibres

from the ganglionic root, while the third—the inferior maxillary—is composed of fibres from both roots, and is therefore a compound nerve. From the mode of distribution, as well as from that of origin, it is inferred that the ophthalmic and superior maxillary are purely sensory, while the inferior maxillary is a motor and sensory nerve. (We have not inserted a special figure of this complicated nerve; the frontal branch of the ophthalmic division is, however, shewn in No. 4, fig. 2, while the infra-orbital branches of the superior maxillary division, and the mental branches of the inferior maxillary division, are shewn in Nos. 6 and 8 of the same figure; while the gustatory or lingual branch of the last-named division is shewn in No. 17, fig. 3. The nasal branches also shewn in one of the diagrams illustrating the article NOSE.) Experiments on living animals confirm the inference that have been drawn on anatomical grounds. Division of the ophthalmic or of the superior maxillary nerve, induces loss of sensibility without any serious impairment of muscular power; but when the inferior maxillary nerve, on either side, is divided, the power of mastication is destroyed on that side, and the sensibility of the tongue and of the lower part of the face on that side is lost.

The lingual or gustatory branch of the inferior maxillary is distributed to the mucous membrane and papillæ at the fore part and sides of the tongue, where it acts both as a nerve of common sensibility and of taste. (The consideration of the respective parts which this nerve and the glossopharyngeal play in the sense of taste, is considered in the articles TONGUE and SENSE OF TASTE.)

The trifacial nerve is the seat of the affection known as tic-douloureux, and described in the article NEURALGIA. It is in the dental branches of this nerve that toothache is situated; and in the process of teething in young children, the irritation of these branches, consequent upon the pressure of the teeth, often gives rise to convulsions, by being conveyed to the medulla oblongata, and exciting motor nerves by reflex action.

The *Glossopharyngeal Nerve* is principally an afferent or sensory nerve, but has a small motor root. It escapes from the cranium in association with the pneumogastric and spinal accessory nerves, through the same foramen as that through which the jugular vein emerges. It then descends by the side of the pharynx, and after anastomosing with the facial and pneumogastric nerves, and giving off a branch to the tympanum of the ear, terminates in branches to the mucous membrane of the base of the tongue, of the palate, tonsils, and pharynx, and in twigs to the digastric and stylopharyngeal muscles; so that its distribution is almost entirely to sentient surfaces (see fig. 3, No. 20). From a careful examination of the investigations of Dr John Reid and others regarding the functions of this nerve, Todd and Bowman arrive at the following conclusions: 1. 'It is the sensitive nerve of the mucous membrane of the fauces and of the root of the tongue, and in the latter situation it ministers to taste and touch, as well to common sensibility; and being the sensitive nerve of the fauces, it is probably concerned in the feeling of nausea, which may be so readily excited by stimulating the mucous membrane of this region.' 2. 'Such are its peripheral organisation and central connections, that stimulation of any part of the mucous membrane in which it ramifies, excites instantly to contraction all the facial muscles supplied by the pneumogastric and the facial nerves; and the permanent irritation of its peripheral ramifications, as in the case of sore throat, will affect other muscles supplied by the facial nerve likewise. It is therefore an excitor of

the movements necessary to pharyngeal deglutition.' —*Op. cit.* vol. ii. p. 119.

The *Pneumogastric Nerve*, or *Par Vagus*, is distributed to so many important organs (the larynx, heart, lungs, stomach, &c.), and is of such great physiological importance, that a special article is devoted to its consideration.

The *Spinal Accessory Nerve* is more remarkable for its peculiar course than in any other respect. It rises from the spinal cord at the level of the fifth or sixth cervical nerve, passes upwards between the anterior and posterior roots of the cervical nerves into the skull, and emerges from the cranial cavity with the two preceding nerves. It is chiefly distributed to the trapezius muscle. See Fig. 2, No. 15.

In the above remarks on the cranial nerves, we have omitted all notice of their points of origin, as that subject is sufficiently noticed in the article BRAIN.

We shall now briefly notice the mode in which the extremities receive their nerves. These nerves are derived from the spinal nerves, through the intervention of what is termed in anatomy a *plexus*. Four or five nerves proceed from the spinal cord for a certain distance, without any communication with each other. They then divide, and from the conjunction of the adjacent branches new nerves result, which again subdivide and interchange fibres. From the net-work or plexus thus formed nerves emerge, each of which is composed of fibres derived from several of the original branches. The most important of these plexuses are found in the regions of the neck, the axilla, the loins, and the sacrum, and are known as the cervical, brachial, lumbar, and sacral plexuses.

The *Brachial Plexus* is formed by communication

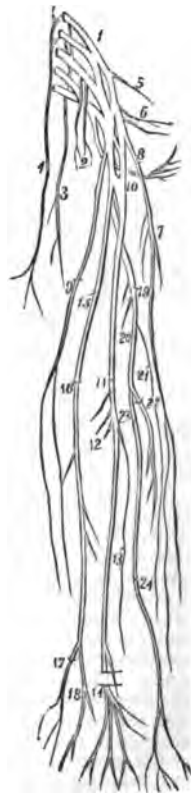

Fig. 4.—A diagram shewing the Brachial Plexus of Nerves of the left side, with its branches. Front view.

- 1, the brachial plexus; 2 and 3, the anterior and posterior thoracic nerves; 4, the phrenic nerves going to the diaphragm; 7 and 9, the external and internal obtuse nerves; 10, the origin of the median nerve (which receives its name from taking a course along the middle of the forearm to the palm of the hand); 12 and 13, branches of this nerve; 14, the point at which it passes under the annular ligament, and divides into its terminal branches, which are distributed to the thumb and to all the fingers except the little finger, and the outside of the ring-finger, which are supplied by (15) the ulnar nerve, whose terminal branches are shewn at 18; 19, the musculo-spiral nerve (the largest of the plexus); 23, 24, the radial nerve, one of the branches of the musculo-spiral.

between the anterior roots of the last four cervical nerves and the first dorsal nerve. These nerves are

nearly equal in size, and their mode of distribution is sufficiently explained by the diagram. The branches emerging from this plexus supply the shoulder and the arm; and the names of the most important of these branches are given in the description attached to the figure.

The *Lumbar and Sacral Plexuses*, with the nerves of the lower extremity, are shown in fig. 5. The

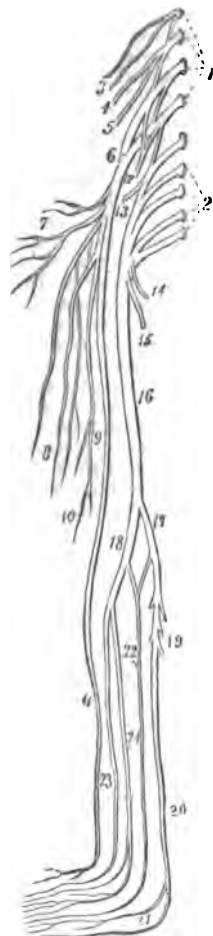

Fig. 5.—A diagram showing the Lumbar and Sacral Plexuses, with the Nerves of the lower extremity.

- 1, the first four lumbar nerves which, with the branch from the last dorsal, form the lumbar plexus; 2, the four upper sacral nerves, which, with the last lumbar, form the sacral plexus; 3, the anterior crural or femoral nerve; 7, 8, 9, 10, its branches; 11, its terminal branch, the long or internal saphenous; 13, the gluteal nerve; 15, the lesser sciatic or salsia nerve (the largest nerve in the body), dividing at about the lower third of the thigh, into 17, the popliteal nerve, and 18, the peroneal nerve; 19, muscular branches of the popliteal, given off in the posterior region of the knee; 20, the posterior tibial nerve, dividing, at 21, into the internal and external plantar nerves, which are distributed to the sides of the toes, in precisely the same manner as the median and ulnar nerves are distributed to the fingers; 22, the external saphenous nerve; 23 and 24, the two terminal branches of the peroneal nerve—viz. the anterior tibial and the musculo-cutaneous nerves.

description attached to the diagram sufficiently explains the mode of formation and the distribution of the branches of these plexuses.

The general arrangement of the *sympathetic system*, or, as it is sometimes termed, the *sympathetic nerve*, has been already noticed at the beginning of this article. Its cephalic portion consists of four ganglia on either side—viz., (1) the Ophthalmic, or Lenticular Ganglion; (2) the Spheno-palatine, or Meckel's Ganglion; (3) the Otic, or Arnold's Ganglion; and (4) the Submaxillary Ganglion. They are all closely connected with the branches of the trifacial nerve. The cervical portion contains three ganglia, the dorsal twelve, the lumbar four, the sacral five, and the coccygeal one, which, instead of lying on the side of the vertebral column, is placed in front of the coccyx, and forms a point of convergence for the two ganglionated cords which run from the cervical to the sacral region parallel to one another. Each ganglion may be regarded as a distinct nervous centre, from which branches pass off in various

directions. In addition to the cords of communication between the ganglia, certain sets of nerves may be usually traced—viz. (1) *visceral nerves*, which generally accompany branches of arteries to the viscera (the lungs, heart, kidneys, liver, spleen, and intestine, &c.); (2) *arterial branches*, distributed to arteries in the vicinity of the ganglia; and (3) branches of *communication* with the cerebral and spinal nerves, an example of which is shown in fig. 1.

The distribution of the sympathetic nerve on the right side is shown in fig. 6. The only nerve that our limited space will permit us to notice is the *great splanchnic*. This nerve arises by separate roots from the 5th, 6th, 7th, 8th, and 9th thoracic ganglia. These roots (see the figure) unite to form a large round cord, which passes obliquely downwards and forwards, and after entering the abdomen by piercing the diaphragm, ends in a large and complex ganglion, the *semilunar ganglion*, which lies upon the side and front of the aorta, at the origin of the coeliac axis. The semilunar ganglia, with the nerves entering and emerging from them, combine to form the *solar plexus*, which, from the mass of nervous matter which it contains, has been termed the *abdominal brain*. It is in consequence of the existence of this great nervous centre, that a blow in the region in which it lies always inflicts a severe nervous shock, and not unfrequently causes death.

Experiments and clinical observations lead to the conclusion, that the sympathetic system supplies motor power to many of the internal viscera, especially the heart and the intestinal canal; that it also contains sensitive fibres, as is shown by the sufferings of patients during the passage of a gall-stone or a renal calculus through a duct, whose sole nervous energy is derived from this system; that it presides over the process of secretion in the most important glands; and that it operates on the blood-vessels in causing them to contract, while the cerebro-spinal nerves produce the opposite effect.

On examining different parts of the nervous system under the microscope, we find that the nervous matter is distributed in two forms, the *vesicular* and the *fibrous*. The vesicular matter is gray in colour, and granular in texture, contains nucleated nerve cells, and is largely supplied with blood; it is immediately associated with mental actions, and is the seat in which the force manifested in nervous action originates. The fibrous matter is, in most parts, white and composed of tubular fibres, though in some parts it is gray and consists of solid fibres; it is less vascular than the former, and is simply the conductor of impressions made upon it. When these two kinds of matter are united together into a mass they form a *nervous centre*, such as the brain or spinal cord, while the *nerves* passing to and from them are composed of threads of fibrous matter. The nervous matter of both kinds is a soft, unctuous substance, with very slight tenacity; the softness being in a great measure due to the large quantity of water which it contains.

The *fibrous* form is the most extensively diffused throughout the body. It forms a large portion of the nervous centres, and is the main constituent of all the nerves. It occurs in two varieties—viz. as the *tubular fibre*, or the *nerve tube*, and the *gelatinous fibre*, the latter being of comparatively rare occurrence, and being found chiefly in the sympathetic system.

When a *tubular fibre* is viewed by reflected light, it presents a beautiful pearly lustre, and appears to be homogeneous. But if viewed by transmitted light, with a sufficient magnifying power, indications of structure become visible. Externally, there is the

NERVOUS SYSTEM.

tubular membrane (A d, d, fig. 7), a homogeneous and probably very delicate elastic tissue, according to Todd. Within the edge of the tubular membrane, on

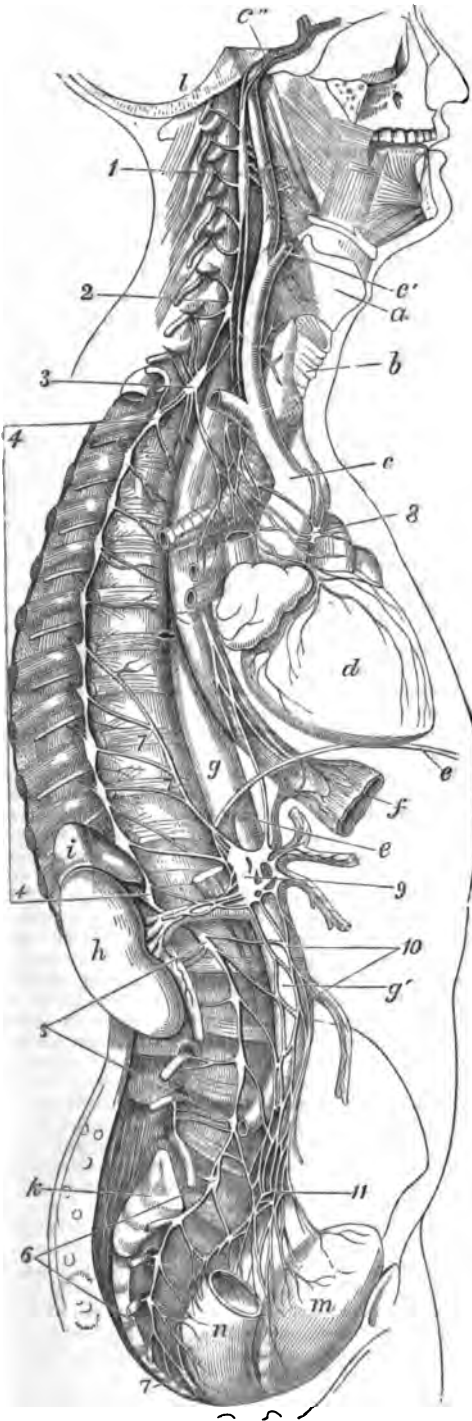

Fig. 6.—The Sympathetic Nerve; the right lateral walls of the chest and abdomen, and the stomach,

intestines, liver, spleen, and pancreas being removed to bring it in view:

- 1, 2, 3, the superior, middle, and inferior cervical ganglia; 4, the two lines from this figure include the twelve dorsal ganglia; 5, include the four lumbar ganglia; 6, include the five sacral ganglia; 7, the ganglion impar; 8, cardiac plexus; 9, solar plexus; 10, aortic plexus; 11, hypogastric plexus; a, the larynx; b, the trachea; c, arch of the aorta; c', external carotid; c'', internal carotid; d, the heart; e, e, the diaphragm; f, the cardiac end of the œsophagus; g, thoracic, and g', abdominal aorta; h, the kidney; i, the supra-renal capsule; k, the sacrum; l, the section of base of the skull; m, the bladder; n, the lower portion of the rectum.

either side are seen two thicker and darker lines (A c, c, b), which appear to mark the outer and inner limits of the structure known as the *white substance of Schwann*, which forms a tube within the tubular membrane; and within the white substance of Schwann is a transparent material occupying the axis of the nerve tube, and commonly known as the *axis cylinder* (A a). By the application of reagents, it is seen that the chemical composition of the white substance is different from that of the axis cylinder, and hence the functions of these two parts are doubtless different; the latter is in general soft and pulpy. The nerve-tubes are cylindrical in form, and lie parallel to one another, without any inosculation, if we except their frequent terminations in loops. Their average diameter is about $\frac{1}{1000}$ th of an inch.

The *gelatinous fibres* are flattened, soft, and homogeneous in appearance, and contain numerous round or oval nuclei (see fig. 7, C). Their diameter is about $\frac{1}{1000}$ th of an inch. In appearance they much resemble the fibres of unstripped muscle.

The *vesicular form* of nervous matter is of a dark reddish-gray colour, is found only in the nervous centres, is always well supplied with capillaries, and consists essentially of nucleated cells or vesicles, which are most commonly globular or ovoidal, but often present one or more tail-like processes, when they are termed *caudate* (see fig. 8).

These caudate vesicles present great difference in shape and size. The processes are very delicate, and readily break off close to the vesicle. They probably either serve to connect distant vesicles, or else become continuous with the axis cylinders of the tubular fibres.

We may now consider the way in which the nerves and nervous centres are made up of these anatomical elements.

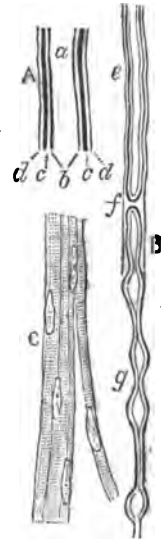

Fig. 7.

A, diagram of tubular fibre of a spinal nerve; a, axis cylinder; b, inner border of white substance; c, c, its outer border; d, d, tubular membrane; B, tubular fibres; e, e, in a natural state, shewing the parts as in A; f, the white substance and axis cylinder interrupted by pressure, while the tubular membrane remains; g, the same, with varicosities which are especially apt to be exhibited in the nerves of the special senses, and of young animals generally; C, gelatinous fibres from the solar plexus, treated with acetic acid to exhibit their cell-nuclei; B and C magnified 320 diameters; A on a considerably larger scale. —From Todd and Bowman.

A *nerve* is composed of a bundle of tubular fibres surrounded and connected by areolar tissue, which forms a sheath known as the *neurolemma*, whose

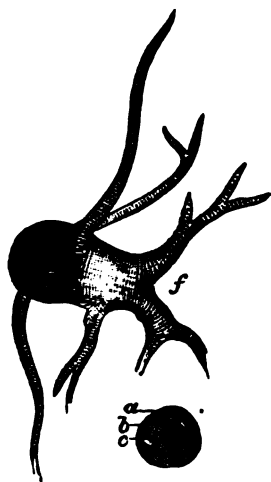

Fig. 8.

a, a globular nerve-vesicle from the Gasserian ganglion of the human subject; b, its nucleus; c, its nucleolus, magnified 300 diameters; f, caudate vesicle from the gray matter of the spinal cord, magnified 300 diameters.—From Todd and Bowman.

office is to protect the delicate tubes, and to support the capillaries from which they derive their nourishment.

The *nervous centres* exhibit a union of the vesicular and fibrous textures, which may be variously arranged. In the Brain (q. v.) the vesicular matter lies externally, forming the gray or cineritious substance; in the spinal cord, on the other hand, the vesicular or gray matter lies in the central portion,

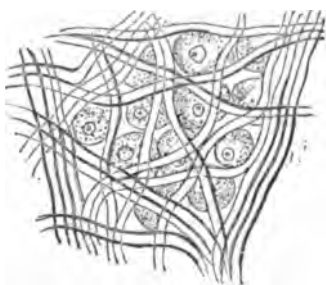

Fig. 9.—A small piece of the Otic Ganglion of the Sheep, slightly compressed, shewing the interlacement of the nervous fibres and vesicular matter.

and the fibrous or white matter is external to it; while in the ganglia the two structures are more or less uniformly associated (see fig. 9).

From the observations which have been made in an earlier part of this article on the functions of individual nerves, it is sufficiently obvious that it is through the instrumentality of the nervous system that the mind influences the bodily organs, as when volition or emotion excites them to action; and that, conversely, impressions made on the organs of the body affect the mind, and excite mental perceptions through the same channel. 'In this way,' to quote the words of Dr Todd, 'the nervous system becomes

the main agent of what has been called the life of relation; for without some channel for the transmission of the mandates of the will to the organs of motion, or some provision for the reception of those impressions which external objects are capable of exciting, the mind, thus completely isolated, could hold no communion with the external world.' The nature of the connection between the mind and nervous matter is, and must ever be, the deepest mystery in physiology, and one into which the human intellect can never hope to penetrate. There are, however, many actions of the body in the production of which the mind has no share. Of this kind are the nervous actions, which are associated with the functions of organic life, such as digestion, respiration, and circulation. Again, there is another class of actions for which two nerves (an afferent or excitor, and a motor) and a nervous centre are necessary. These are the actions known as *reflex* or *excito-motory*, for the full investigation of which physiology is especially indebted to the labours of the late Dr Marshall Hall. For example, the movement of the oesophagus in propelling the food onwards to the stomach, is caused by the stimulus of the food acting on the excitor or afferent nerves, which, through the spinal cord, excite the motor or efferent nerves, and thus give rise to the necessary muscular action. When the edge of the eyelid is touched, the excitor nerve (a branch of the ophthalmic division of the fifth or trifacial nerve) conveys the impression of the stimulus to the nervous centre, and the eye is at once closed by the motor influence, which is transmitted by a branch of the facial nerve to the orbicular muscle. In such cases as these—and they form a very numerous class—the mind takes no part. In some of them it is conscious of the application of the stimulus, as well as of the muscular act which follows; but even in these cases no effort of the will could modify or interrupt the sequence of the phenomena.

It has been already shewn that the stimuli, by which the action of nerves is commonly excited, are of two kinds, mental and physical, and the change which these stimuli produce in a nerve develops the power known to physiologists as the *vis nervosa*, or nervous force. 'The nervous force,' says Dr Sharpey, in his recent *Address on Physiology* (1862), 'has long been likened to electricity, but rather through a vague perception of analogy than from any rigorous comparison. It is true that electric force is developed in the nerves, and even exhibits modifications connected with different conditions of nervous action. Still, it must be borne in mind that the evolution of electricity is a common accompaniment of various processes involving chemical change, whether within the living body or in external nature; and the tendency of recent speculation is not towards the identification of the nerve force with electricity, but rather to suggest that the two stand related in the same way as electricity and other physical forces are related to each other—that is, as manifestations of a common force or energy, of which they, severally, are the special modifications.' The velocity with which impressions are transmitted by the nerves has been recently made the subject of investigation, but it is doubtful how far the observations are to be depended on, in consequence of the various sources of fallacy by which such experiments are beset. According to Hirsch, the velocity is 34 metres, or about 112 feet per second in man; while Helmholtz fixes it at 190 feet per second in the frog.

The description of the nervous system given in the foregoing pages is applicable, with slight modifications, to all the Vertebrates; the main differences

being in the degree of the development of the brain—a point which has been already noticed at the commencement of the article BRAIN. For a sufficient notice of the plan of the nervous system in the Invertebrate animals, the reader is referred to the articles ARTICULATED ANIMALS, MOLLUSCA, and RADIATA. It is only in the lowest subdivision of the Animal Kingdom, the PROTOZOA, that no traces of a nervous system can be detected.

For further information on the subject of this article, the reader is referred to Dr Carpenter's works on *Human and Comparative Physiology*, to Dr Todd's article on 'The Nervous System' in *The Cyclopædia of Anatomy and Physiology*, to Todd and Bowman's *Physiological Anatomy and Physiology of Man*, and to Funke's *Lehrbuch der Physiologie*.

NESS (identical with Eng. *nose*, A.-S. *noose*, Ger. *nase*, Ice. *nes*, Lat. *nasus*, Fr. *nez*), a geographical termination, signifying promontory. Names in *-ness* abound among the Orkney and Shetland Islands, and on the coast of Caithness; and they occur, though less frequently, along the east coast of Great Britain, as far as Dungeness in Kent. As the corresponding Scandinavian termination *-naes* prevails in the names of promontories in Norway, Sweden, and Denmark (e. g., Lindesnaes, in south of Norway), the existence of names in *-ness* in Britain is held as an evidence of Scandinavian and Danish colonisation. Grianes, on the north coast of France, points to the same source.

NESS, LOCH, a long narrow lake in Inverness-shire, Scotland, extends north-east and south-west, and is 23 miles in length, and 1½ mile in average breadth. Its north-east extremity reaches a point 6 miles south-west of the town of Inverness. It receives the Morriston, the Oich, the Foyers, and other streams, and its surplus waters are carried off to the Moray Firth by the River Ness. It lies in the valley of Glenmore, and is enclosed by mountain masses averaging 1000 feet in height; but the scenery on its banks is not strikingly picturesque. In many places it is about 130 fathoms in depth, and owing to the length of time which this immense body of water takes to cool down to the freezing-point, ice never forms to any considerable extent.

NESSELRODE, KARL ROB., COUNT, one of the most eminent diplomatists of modern times, was born, 14th December 1780, at Lisbon, where his father, a descendant of an ancient noble family on the Lower Rhine, was then Russian ambassador. He early devoted himself to a diplomatic career, gained in a high degree the esteem and confidence of the Emperor Alexander, and in 1813 was one of the representatives of Russia in the important negotiations which took place between the powers who combined against France. In 1814, he accompanied the Russian emperor to France, and on 1st March signed the treaty of the Quadruple Alliance at Chaumont. He was also one of those who concluded the treaty with Marshal Marmont for the surrender of Paris. He continued to take a principal part in all the negotiations which ended in the Peace of Paris; and was one of the most prominent and active of the plenipotentiaries in the Congress of Vienna. He was one of the most active diplomatists of the Holy Alliance, and accompanied the Emperor Alexander to the Congresses of Aix-la-Chapelle, Troppau, Laibach, and Verona. The Emperor Nicholas reposed in him the same confidence, and under his reign he conducted the Russian policy in the affairs of Greece and Turkey. Amidst the European convulsions of 1848 and 1849, Russia, under his guidance, refrained from interference, till opportunity occurred of dealing a deadly blow to the revolutionary cause in Hungary; and,

at the same time, of bringing Austria very much under Russian influence. Being one of the chiefs of the German or moderate party in Russia, N. is supposed to have exerted himself strenuously to preserve peace with the Western Powers; and after the war had broken out in 1854, and the ill success of Russia was manifest, he undoubtedly strove for the re-establishment of peace, and for the assembling of a congress to settle all disputes. After the accession of Alexander II. he retired from the direction of foreign affairs, and was succeeded in that department by Prince Alexander Gortchakov, but retained the dignity of chancellor of the empire, and a seat in the ministerial council. He died at St Petersburg, 23d March 1862.

NESTOR, according to ancient Grecian legend, the son of Neleus and Chloris, born in the Messenian Pylos, escaped destruction when Hercules slew all his brothers, being then a dweller among the Geronians, with whom he was brought up. He married Eurydice, by whom he became the father of a numerous family. In his youth he was distinguished for valour in wars with the Arcadians, Eleians, and the Centaurs, and in his advanced age for wisdom. Although he was an old man when the expedition against Troy was undertaken, he joined it with his Pyliaus in sixty ships. Homer makes him the great counsellor of the Grecian chiefs, and extols his eloquence as superior even to that of Ulysses. His authority was even considered equal to that of the immortal gods. N. returned in safety to his own dominions after the fall of Troy, along with Menelaus and Diomedes, and continued for long to rule over the people of Pylos.

NESTORIANS, a sect of the 5th c., so called from its founder NESTORIUS, under which head their distinctive doctrine, as well as their history up to the time of its condemnation, are sufficiently detailed. Of the later history it will be enough to say that, even after the Council of Ephesus, Nestorianism prevailed in Assyria and Persia, chiefly through the influence of the well-known school of Edessa. Although vigorously repressed in the Roman empire, it was protected, and probably the more on that account, by the Persians, and ultimately was established by King Pherozes as the national church, with a patriarch resident at Seleucia; its fundamental doctrine, as laid down in the synod of Seleucia in 496, being the existence of two distinct persons as Christ, united solely by a unity of will and affection. Under the rule of the califs, the N. enjoyed considerable protection, and throughout the countries of the East their community extended itself. Of their condition in Central Asia during the mediæval period, some account will be found under the head of PRESTER JOHN. In the middle of the 12th c., their church reckoned no fewer than 90 bishops under regular metropolitans, together with 56 others, whose special dependencies are unknown; but in the destructive career of Tamerlane, they shared the common fate of all the representatives of the eastern civilisation. In the 16th c., a great schism took place in this body, of which a portion renounced their distinctive doctrine, and placed themselves under the jurisdiction of the Roman pontiff, to whom, under the title of Chaldean Christians, they have since remained faithful. The others still maintain their old creed and their ancient organisation. Their chief seat is in the mountain-ranges of Kurdistan. They are at present a poor and illiterate race, numbering about 140,000, and subject to a patriarch residing at Diz (who is always chosen from the same family, and takes invariably the name of Schamun, or Simon) and 18 bishops. All these are bound to observe

celibacy, but marriage is permitted to the priests and inferior clergy. Their liturgical books recognise seven sacraments, but confession is infrequent, if not altogether disused. Marriage is dissoluble by the sentence of the patriarch; communion is administered in both kinds; and although the language of the liturgy plainly implies the belief of transubstantiation, yet, according to Layard, that doctrine is not popularly held among them. The fasts are strict, and of very long duration, amounting to very nearly one half of the entire year. They pray for the dead, but are said to reject the notion of purgatory, and the only sacred image which they use or reverence is that of the cross. The N. of Kurdistan, like the Christians of the Lebanon, have suffered much from time to time through the fanaticism of the wild tribes among whom they reside. In a massacre in 1843, and again in 1846, many fell victims, and even still they owe much of their security to the influence exercised in their favour by the foreign representatives at the Turkish and Persian courts.

There is another body of N. who have existed in India from the period of the early migrations of the sect, and who are called by the name of Syrian Christians. Their chief seat is in Travancore, where they number about 100,000, and are subject to a patriarch. Among both bodies of N., European missionaries, Catholic and Protestant, have of late years endeavoured to effect an entrance, but the details would be out of place here. See *A Residence of Eight Years in Persia, among the Nestorian Christians*, by Rev. Justin Perkins, Andover, 1843.

NESTORIUS, a native of Germanicia, a city of Northern Syria, in the patriarchate of Antioch, was probably a disciple of the celebrated Theodore of Mopsuestia; and having received priest's orders at Antioch, became so eminent for his fluency, if not eloquence, as a preacher, and for grave demeanour and exemplary life, that on occasion of a dispute about the election of a patriarch of Constantinople he was selected by the emperor, in 428 A.D., to fill the vacant see. Soon after his consecration, a controversy arose as to the divine and human natures of our Lord, in which N. took a leading part. One of the priests, who followed N. to Constantinople, Anastasius, having in a sermon, which was by some ascribed to N. himself, denied that the Virgin Mary could be truly called the 'Mother of God,' being only in truth the mother of the man Christ, N. warmly defended Anastasius, espoused this view, and elaborated it into the theory which has since been known by his name, and which equivalently, if not in formal terms, exaggerated the distinction of two natures in our Lord into a distinction of two persons—the human person of Christ and the Divine Person of the Word. An animated controversy ensued, which extended from Constantinople to the other patriarchates, and drew from Cyril, patriarch of Alexandria, a formal condemnation of the doctrine of N. in twelve anathemas still preserved, and a similar condemnation, accompanied by a threat of deposition and excommunication, from Celestine, bishop of Rome, unless he would withdraw the obnoxious doctrine. N. remaining firm in his opinions, a general council was convened at Ephesus in 431, at which Cyril took the most active and prominent part, and in which, notwithstanding the absence of the patriarch of Antioch and his bishops, N. was condemned and deposed. Considerable opposition was offered to this judgment for a time, but ultimately N. was confined in a monastery near Constantinople, whence, after four years, still persisting in his views, he was banished to the Greater Oasis in Upper Egypt, and after several changes of his place of confinement, died in exile. The

account given by Evagrius, that his death was caused by a disease in which his tongue was eaten by worms, rests, according to Evagrius himself, on a single and unnamed authority. The more probable narratives ascribe his death to the effects of a fall. The date of this event is uncertain. It was after 439, when Socrates wrote his history (*Hist. Eccl.* vii. 34), but there is little doubt that he was already dead in 450, when the Eutyopian controversy first began to attract notice.

NESTS (Lat. *nidus*, Gael. *nead*; allied to German. *nesten*, Sax. *nestan*, Lat. *nectere*, to sew, bind, or tie) are the structures which animals prepare for the rearing of their young. They are very different, not only when the creatures which construct them belong to widely separated divisions of the animal kingdom, but often when the animals are of the same class, or even when they are nearly allied; and whilst some construct very simple nests, and those of others are very curious and elaborately framed, some make no nest at all. Among MAMMALS, the only nest-builders are certain rodents, as mice, dormice, squirrels, &c. The structures of some of the species are as artfully contrived and as beautiful as the nests of birds. It is among BIRDS that nest-making is most general; although there are not a few species which merely scrape a hole in the ground, and many sea-fowls lay their eggs on ledges of naked rock. The situations chosen by birds for their nests are very various, each species affecting some particular kind of situation, as each species also exhibits a uniformity in choice of materials and in form and mode of structure; these particulars, however, being all liable to modification—within certain limits—according to circumstances. Some birds' nests consist merely of a few straws or leaves collected together; some, of such materials as twigs, straws, moss, hair, &c., very nicely interwoven, and often with a lining finer than the framework; some, as those of swallows, are made of clay or other soft material, which hardens as it dries. Birds' nests are generally open at top, but some, as those of swallows, are so placed under a projection of rock or of a building, as to be covered, and have the opening at the side; whilst others are vaulted, and have the opening at the side. Some are situated in holes excavated in clayey, loamy, or sandy banks. The nests of troupials, baltimorees, weaver-birds, &c., are remarkable for the ingenious contrivance displayed in them; and a very singular nest is that of the tailor-bird, made by sewing together the edges of leaves. These are noticed in the articles on these birds. Many birds are as solitary as possible in their nidification; whilst others, as rooks and herons, congregate in large communities.—No REPTILES are known to construct nests; their utmost approach to it being to make a hole for their eggs in sand, or in some other suitable situation.—The nests of FISHES have recently attracted much attention of naturalists. It is supposed that the ancients were acquainted with the nest-building instinct of some fishes; but it was unknown to modern naturalists till 1838, when Mr Edwards discovered it in a species of Stickleback (q. v.). It now gives interest to many a fresh-water aquarium. Not many fishes are yet known as nest-builders. Among them are gobies and the goramy. Many are known not to construct nests. The salmon and others exhibit an approach to the nest-building habit, in making a place for their eggs in the sand or gravel which they choose for a spawning-bed.—Many INSECTS—a small proportion, however, of the whole number, and mostly *Hymenoptera*—construct nests, as bees, wasps, and ants. The nests of the social bees and wasps are also their ordinary habitations, but the nests of solitary bees are entirely



NESTS—NETHERLANDS.

devoted to their young. A few insects, not hymenopterous, as some weevils, may also be said to make nests; but among insects provision for the wants of the young is usually made in very different ways. Certain spiders, amongst which may be named the water-spider, construct nests.—The instinct of nest-making, connected as it is with the instinctive care for their young which the Creator has made so important a part of the nature of so many animals, is by no means an index either of that care or of the affection with which, in many cases, it is conjoined; and some of the animals which construct no nest are among those in which affection for their young is exhibited in the highest degree.—The nest-making instincts of animals seem to be a very essential part of their constitution; and even in the most perfect domestication are still retained and exhibited; although the accommodation to circumstances which is also manifested shews something—and that not inconsiderable—of reason.

NESTS, EDIBLE, an important article of commerce between the Eastern Islands and China, and of luxury in China, are the nests of several species of Swallow (q. v.), of the genus *Collocalia*. The best known of these birds, *C. esculenta*, is about 4½ inches in length, 11 inches in expanse of wing, dusky black above, pale ash-colour beneath. The nest is shaped like that of the common swallow, and adheres to a rock; vast numbers being found together—often in absolute contiguity—in caves of the Eastern Archipelago; as those of the same and allied species are in other islands of the East Indies. The nests are formed of a gelatinous substance—the finest being transparent, or nearly so—with a somewhat fibrous structure, and are now believed to be made of sea-weeds of the genus *Gelidium* (q. v.). The nests are collected by means of ladders, and often by means of ropes, which

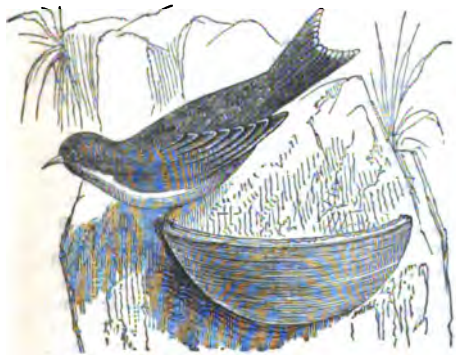

Chinese Swallow and Nest.

enable the gatherers to descend from the summit of a precipice, like the rock-fowlers of the North. The gathering of the nests takes place after the young are fledged. In the Chinese market the nests are sold for prices varying according to the quality, from £2 to £7 per pound, and they are of course used only by the most wealthy, chiefly for thickening rich soups. They are very wholesome and nourishing, but quite devoid of the peculiar properties which the Chinese ascribe to them.—The Dutch used to export from Batavia about 1000 peekuls of these nests annually, a peekul being about 25 pounds, and worth from 1000 to 1500 dollars. The greater part, however, were brought from more eastern islands. The nests weigh about half an ounce each.

NETHERLANDS, THE KINGDOM OF, lies between 50° 43' and 53° 36' N. lat., and 3° 22'

and 7° 16' E. long., is bounded on the N. by the North Sea, E. by Hanover and the western part of Prussia, S. by Liège, Belgian Limburg, Antwerp, East and West Flanders, W. by the North Sea. Its greatest length from north to south is 195 English miles, and its greatest breadth from the west, on the North Sea, to the extremity of Overysseel, on the east, 110 English miles. It contains 12,597 square miles. Pop., including the grand duchy of Luxemburg, 3,611,172. The following table gives the population, 1st January 1863, the area of the provinces, including the reclaimed Haarlem Lake, and the provincial capitals:

Provinces.	Area in Sq. Miles.	Pop. 1863.	Provincial Capitals.
North Brabant,	1960	414,665	's Hertogenbosch.
Gelderland, .	1948	411,947	Arnhem.
South Holland, .	1162	642,688	The Hague.
North Holland, .	1050	554,221	Haarlem.
Zeeland, .	865	172,249	Middelburg.
Utrecht, . . .	632	165,681	Utrecht.
Friesland, . .	1253	279,154	Leeuwarden.
Overysseel, . .	1374	341,633	Zwolle.
Groningen, . .	696	314,425	Groningen.
Drenthe, . . .	1017	100,506	Assen.
Limburg, . . .	840	318,775	Maastricht.
	12,597	3,416,144	
Grand Duchy of Luxemburg, }	987	195,028 *	Luxemburg.
Total, . . .	13,584	3,611,172	

The population averages 271 to the square mile, but in Drenthe falls as low as 98, and in South and North Holland rises to 546 and 528; Utrecht, Limburg, and Zeeland being the next densely peopled. In 1861, the births amounted to 125,023, of which 5084 were illegitimate. In communities of more than 10,000, these were as 1 to 24.59, and in the others 1 to 37.64 of the total births, the average being 1 to 24.59. In the province of Utrecht, 1 to 19.32, the maximum; and in Friesland, 1 to 47.77, the minimum.

The leading mercantile places are Amsterdam, Rotterdam, Dordrecht, Alkmaar, Middelburg, Schiedam, Leyden, Delft, Gouda, Utrecht, Amersfort, Groningen, Meppel, Zwolle, Kampen, Deventer, Arnhem, Nymegen, Tiel, Gorinchem, 's Hertogenbosch, Tilburg, and Breda.

Physical Aspect.—The land is generally flat and low, much of it being below the level of the sea, rivers, and canals, especially in North and South Holland, Zeeland, the southern part of Gelderland, and Friesland. Along the west coast, the low lands are protected from the sea by a line of sand-hills or downs; and where that natural defence is wanting, strong dykes have been constructed, and are maintained at great expense, to keep back the waters. The greatest of these dykes are those of the Helder and of West Kapelle, on the east coast of Walcheren (q. v.), which require, each, upwards of £6000 annually to keep them in order. Engineers, called the officers of the Waterstaat, take special charge of the dykes and great national hydraulic works, the expense of which is reckoned at about half a million sterling. A hilly district stretches from Prussia through Drenthe, Overysseel, the Veluwe or Arnhem district of Gelderland, the eastern part of Utrecht, into the Betuwe or country between the Maas and the Waal. This tract of country has many pretty spots, is of a light sandy soil, well watered, and when not cultivated, is covered with heath or oak-coppice. The greatest part of the N. is very fertile, the low lands and drained lakes, called Polders (q. v.), being adapted for pasturing cattle, and the light soils for cereals and fruits; but in some

* Population in 1860.

NETHERLANDS.

districts there are sandy heath-clad plains, extensive peat-lands, and undrained morasses, which industry is rapidly bringing under cultivation.

Islands, Rivers, Canals, &c.—The islands may be divided into two groups, of which the southern, formed by the mouths of the Schelde and Maas, contains Walcheren, South and North Beveland, Schouwen, Duiveland, Tholen, St Philipaland, Goeree, Voorne, Putten, Beyerland, Ysselmonde, Rozenburg, and the island of Dordrecht. The northern group contains the islands at the entrance of the Zuider Zee and along the coasts of Groningen and Friesland, as Wieringen, Texel, Vlieland, Terschelling, Ameland, Schiermonnikoog, and Rottum. In the Zuider Zee are Marken, Urk, and Schokland.

The chief rivers are, the Rhine, Maas, and Schelde. Important branches of these are the Waal, Lek, Yssel, Roer, &c.

Water-ways are more numerous than in any other European country, the immense tracts of meadowland and the fertile polders being girdled by large canals, and cut in all directions by smaller ones for drainage and communication. Those of most importance to the national trade are, the North Holland Canal, constructed 1819—1825, to connect the port of Amsterdam with the North Sea; the Voorne Canal, from the north side of Voorne to Hellevoetsluis, which shortens the outlet from Rotterdam; the South Willemsvaart, through North Brabant, Dutch and Belgian Limburg, from 's Hertogenbosch to Maastricht, being 71½ English miles in length, and having 24 locks. Besides these, there are numerous important canals, connecting rivers, and cutting the kingdom into a network of water-courses. The North Holland Canal is 52 English miles long, 120 feet broad, 20 feet deep, and has 5 great locks, each 190 feet in length, and 24 in breadth. A new canal, which is not in any part to be less than 80 yards broad, and which will reduce the distance from Amsterdam to the North Sea from 52 to 15 English miles, has been planned, and a concession granted, the haven of which, on the North Sea, is to be near Wyk-aan-Zee, in about 52° 29' N. lat., and 4° 36' E. long., and the total expense, including the recovering of 15,000 acres of land from the Y, is reckoned at fully 1½ millions sterling.

Railways have been constructed to the extent of about 266 miles, forming lines of communication between the principal cities of the N., and with Prussia to the south-east, and Belgium to the south-west. The receipts of the three main lines in 1860 amounted to £354,150. In 1863, another main line was opened, and on the budget of that year stood an item of ten million guilders for railway-works.

Climate, Agriculture, Produce, &c.—The climate of the N. is variable, chilly colds often closely succeeding high temperatures, inducing various forms of fever and ague, and requiring peculiar care as to clothing, &c. In summer, the thermometer sometimes rises above 80°, and even to 90° F. in the shade, and a winter of great severity usually occurs every fifth year, when carriages and heavily-laden wagons cross the rivers and the Y on the ice, and thousands enjoy the national pastime of skating.

The farms are generally small and well cultivated, though the implements are old-fashioned and clumsy. Much progress is being made in reclaiming the sandy wastes, in Drenthe and Overijssel, by planting them with fir and oak, and sowing buckwheat, oats, and rye. The best implements are also being gradually introduced from England, and the steam-plough has, in 1862, been put in operation on the lands of the drained Haarlem Lake. The following table shews the

agricultural products, with their values, for 1858, according to government returns :

	Gulden.
Wheat to the value of	16,792,886
Rye,	29,514,689
Barley,	10,236,129
Oats,	12,262,537
Beans,	4,646,646
Pease,	229,383
Buckwheat,	7,237,823
Coals,	4,482,597
Potatoes,	28,719,465
Madder,	4,972,376
Chicory,	601,553
Flax,	5,544,747
Hemp,	847,140
Hops,	55,400
Tobacco,	1,058,730
Various,	1,486,323
Total,	138,977,630

or £11,813,101 sterling. In 1860, wheat occupied 201,080 acres; rye, 479,230 acres; barley, 104,951 acres; oats, 213,662 acres; potatoes, 250,658 acres; flax, 38,300 acres.

In 1860, the N. possessed 243,454 horses, 1,287,538 head of cattle, 865,728 sheep, 114,903 goats, and 270,586 pigs. The leading agricultural products of Zeeland are wheat and madder; in South Holland, madder, hemp, butter, and cheese; in North Holland, butter and cheese are extensively made, and cattle, sheep, and pigs reared and exported. The horses of Friesland, Zeeland, and Gelderland are of first-rate quality. The exportation of butter from Holland and Friesland, and of Edam, Leyden, Gouda, and Frisian cheese is large; in 1860, amounting to 1,973,506 Dutch pounds of cheese and 622,256 of butter. Fruit is abundant, and in several provinces, as Gelderland, Utrecht, and Drenthe, much attention is paid to bees. In Haarlem and neighbourhood, tulips and hyacinths are much cultivated, realising a large annual amount. In 1862, the parish of Bloemendaal, near Haarlem, sold of these bulbs to the value of £17,000. Wild ducks, snipes, plovers, and hares are plentiful; and there are also conies, partridges, pheasants, and deer—game forming an article of export.

Geology, Mineralogy, &c.—The N. are of recent formation, and consist of an alluvial deposit, chiefly of a deep, rich clayey soil, superimposed on banks of sand, marine shells, and beds of peat and clay. It appears that at some distant period there had been a depression of the land below its former level, enabling the sea to burst through its sand-banks, submerge the land, and form new deposits. The higher districts are composed of sand-drift mingled with fertile earths, and resting on a bed of clay. Coal is worked in Limburg; and a soft sandstone, which becomes fit for building purposes after having been some time exposed to the atmosphere, is quarried in the southern part of that province, which has also pipe and other clays. Valuable clays for pottery, tile and brick making, abound in the various provinces.

Manufactures, Industries, &c.—The chief manufactures are linen, woollen, cotton, and silk fabrics; paper, leather, glass, &c. Leyden and Tilburg are famed for woollen blankets, wool-dyed pilot, fine cloths, and friezes; 's Hertogenbosch for linens and rich damasks; calicoes, shirtings, drills, table-cloths, striped dimities are made at Almelo, Amersfort, and in the leading towns of Overijssel. Good imitation Smyrna and Scotch carpets, and carpets of hair and wool, are manufactured at Deventer, Delft, Arnhem, Hilversum, Utrecht, and Breda; Turkey-red yarns, dyed silks, and silk stuffs at Roermond, Utrecht, Haarlem, &c.; leather, glass, firearms, at Maastricht and Delft; iron-founding, rolling and

NETHERLANDS.

hammering of lead and copper, cannon-founding are carried on at the Hague, &c.; and powder-mills at Muider; Oudenkerk, Middelburg, 's Hertogenbosch, Amsterdam, Nymegen, &c., have important breweries, those of 's Hertogenbosch producing (1862) upwards of 1,250,000 bottles. Waalwyk, Heusden, and surrounding districts, manufacture boots and shoes, of which Heusden sent to North and South Holland 1,000,000 pairs in 1862. Gin is distilled at Schiedam, Delft, Rotterdam, and Weesp. Amsterdam has the largest diamond-cutting trade in the world, 10,000 souls depending on that branch of industry. Sugar-refining is largely carried on at Amsterdam, Rotterdam, and Dordrecht, from all of which sugar is exported to Russia, the Levant, and countries of Europe. Paper is chiefly made in Holland and Gelderland. The leading letter-type foundries are at Amsterdam and Haarlem. Manufactures of every kind are being rapidly increased in number, and adding to the material prosperity of the Netherlands. The chief motive power is the windmill, which forms a never-failing element in the scenery; but of late years, steam is becoming more general. In 1854, the steam-engines employed in factories were 464, with 7980 horse-power; and in 1857, they amounted to 662, of 11,139 horse-power.

Many people are employed in the immense inland shipping-trade which the canal net-work has fostered, there being, when the last census was taken, 6684 ships inhabited by families, or one inhabited ship to 81 houses. The houses were 542,295; families, 668,911. Fishing, not only in the inland waters, the coasts, and bays of the North Sea, but also on the coast of Scotland, is vigorously pursued. In 1861, the herring-fishing in the North Sea produced 29,260 barrels, valued at £46,920; on the N. coasts, to the value of £37,034; and in the Zuider Zee, additional, were taken 25,420,000 herrings. The anchovy take, almost exclusively in the Zuider Zee, amounted to 6992 ankers, valued at about £4903; and 3,065,000 oysters were obtained from the various oyster-beds, besides extensive fishings of cod, ling, turbot, flounders, soles, shrimps, haddock, &c.; and from the rivers, salmon, eels, perch, &c.

Exports, Imports, Shipping, &c.—The N. is peculiarly a mercantile as well as agricultural country; its merchants not only importing and exporting the products of their colonies and the surplus of their own country, but also those of other lands. The general imports (1861) amounted to a value of £39,873,752, of which from Great Britain were £11,487,495; the exports to £34,095,358, of which £6,981,560 were to Great Britain. The leading exports, in 1860, were:

Cheese, . . .	1,973,506	Dutch pounds of 17½ oz. avoird.
Butter, . . .	622,256	" " " "
Refined Sugar, . . .	10,689,750	" " " "
Flax, . . .	3,615,676	" " " "
Madder, . . .	1,542,694	" " " "
Cattle, . . .	32,749	head.
Sheep, . . .	27,139	" "
Pigs, . . .	22,474	" "
Gin, . . .	48,214	barrels.
Garacine, . . .	£130,458	sterling in value.

In 1861, the laden ships, which cleared in-bound, amounted to 8599, having a tonnage of 1,688,114; those in ballast being 470 ships of 66,237 tons. Of the in-bound ships, 3831 were N. and 2251 British. Cleared out-bound, laden, 4659 ships of 1,031,650 tonnage; in ballast, 4472 of 739,739 tons burden. Along the rivers were cleared, in-bound, 20,838 Belgian, Prussian, and Hanoverian laden ships, having a tonnage of 1,734,822, and 3583 empty of 223,177 tons; also 84 rafts of wood, of 12,966 tons weight. Outward bound along the rivers, 12,092 laden, amounting to 1,045,930 tons, and empty 10,081 ships of 852,961 tons.

Religion, Language, Education, &c.—About one-third of the population belong to the Roman Catholic Church; 67,000 are Jews, and the remainder Protestants, of whom 1,900,000 are Dutch Reformed. There are (1863) 1495 Dutch Reformed clergymen and 1612 Roman Catholic. For the Reformed religion, stands on the budget for the year the sum of £150,408, and for the Roman Catholic Church, £56,230.

There are five dialects spoken respectively in Groningen, Friesland, Gelderland, Holland, and Zeeland. These differ considerably from each other, and the Frisian is not at all understood by natives of the other provinces. The written language is the Dutch, that branch of the great Teutonic stock which preserves more of its original character than the rest of the same family. It possesses numerous words the same as Lowland Scotch, and bears a strong affinity to the Old Saxon English, as the following Dutch proverb shews:

Wen de wyn is in den man,
Is de wysheid in de kan.

The kingdom of the N. has produced many great names in all branches of literature and science. Coster (q. v.), according to his countrymen, invented printing, Leeuwenhoek the microscope, and Huygens applied the pendulum. Out of a long list of distinguished names, may be mentioned those of Erasmus, Scaliger, Heinsius, Hugo de Groot (Grotius), Huygens, Leeuwenhoek, Vitringa, Boerhave, and the poets Hooft, Vondel, and Cats; whilst the writings of Van der Palm, Van Lennep, Des Amorie van der Hoeven, Haafner, Stuart, Van Kampen, and those of the poets Bilderdijk, Da Costa, De Bull, Van den Berg, ter Haar, and Hofdyk, shew that literature is not waning. Exclusive of newspapers, there are 226 magazines and periodicals published in the N., of which 67 are religious, 42 on art, belles-lettres, and general literature, and 7 on antiquity, history, &c. Leading painters of the old Dutch school were Rembrandt, Gerrit (Gerard) Dou, Gabriel Metz, Jan Steen, Paul Potter, Ruydaal, Van der Helst; and among those of the present century, Ary Scheffer, Koekkoek, Schelfhout, Pieneman, Kruseman, Van Os, Craeyvanger, ten Kate, Israels, Bles, Louis Meyer, Roeloff, Springer, &c., have distinguished themselves.

There are universities at Leyden, Utrecht, and Groningen; *atheneums* or colleges at Amsterdam, Deventer, and Maastricht, the students attending which must be examined for degrees at one of the universities. Latin schools are in all the leading towns. The universities and *atheneums* have faculties of theology, medicine, philosophy, law, and letters. There are also the Royal Military and Naval Academy at Breda, and that for engineers and the India civil service at Delft; seminaries in several places for the training of the Roman Catholic clergy; and others, especially in Amsterdam, for those of the smaller Protestant sects; and many literary, scientific, and agricultural institutes.

Each community or parish must have, at least, one elementary school, supported from the local public funds, in which reading, writing, arithmetic, history, geography, &c. are taught. A higher class of schools includes also foreign languages. All are under government inspectors, and the teachers must undergo stringent examinations on all the branches before obtaining permission to teach. Many society or subscription schools are being erected all over the land, with a normal school at Nymegen, not under government surveillance, and including religious instruction, which is excluded from the national public schools. The members of these

NETHERLANDS.

societies pay a yearly subscription and a small fee for each pupil sent by them to the school, a select number acting as managers. There are national normal schools at 's Hertogenbosch, Haarlem, and Groningen, the pupil-teachers boarding themselves, and receiving, at 's Hertogenbosch, £21 a year, and at Haarlem, £24. The attendance at school is about 1 to 8 of the population in winter, and 1 to 10 in summer. On 15th October 1862, there were in North Holland at school 63,333 children out of a population of 554,221, or about 1 to 8½. Of these, 33,914 were educated free of payment.

Army, Navy, &c.—The strength of the army, in time of peace, should be 60,000 men, but (1863) there is a deficiency of 10,000, even on paper. It is composed of volunteers, and of one man for every 500, drawn by lot for five years' service. There is also a local force, called the Schutterij, drawn by lot from those between 25 and 34 years of age, to assist in keeping order in peace, and in case of war, to act as a mobile corps, and do garrison duty. If attacked on the land-side, 90,000 men are required for the defences, and if by land and sea, 108,000. The first, or Maas line of defence, is formed by Maastricht, Venlo, Grave, 's Hertogenbosch, Woudrichem, Geertruidenberg, Willemstad, Breda, and Bergen-op-Zoom. The second line is formed by Nymegen, Forts St Andries and Loevestein and Gorinchem. The inner line of Utrecht is formed by various forts from Naarden, Utrecht to Gorinchem, which, by inundations, can make the provinces of North and South Holland into an island. There are many other forts, batteries, and strengths at the mouths of the rivers and along the leading ways.

The royal navy consists of 3 steam-frigates, 2 steam-corvettes, 38 screw steam-ships, 13 paddle do., 5 floating-batteries, 2 ships of the line, 7 frigates, 6 corvettes, 11 smaller vessels, 1 transport ship, 13 used for defences, and 35 gun-boats. There is also (1863) an armour-plated steam gun-boat building. The effective strength is 6291 men and 1850 guns. Prince Frederic, uncle of the king, is admiral, the Prince of Orange vice-admiral, and his majesty is commander-in-chief of the land and naval forces.

Revenue, Expenditure, &c.—The revenue of 1862 amounted to £8,396,912, and the expenditure to £8,259,631. The budget for 1863 was, revenue, £8,976,000; and expenditure, £8,330,000. Among items of revenue were, direct taxes, £1,750,310; excise, a million and a half sterling; indirect taxes, over a million; profit from the colonial produce, two millions sterling; &c. Among items of expenditure, a million and a quarter sterling for public works; over a million for emancipation of the West India slaves; £2,509,220 as interest of national debt, &c. The India revenue for 1861 amounted to £9,069,983, and the expenditure to £8,533,147 sterling.

From 1850 to and with 1862, there has been paid off £17,311,104 from the national debt, lessening the annual interest by the sum of £532,146. In 1863, the debt amounted to about 65½ millions sterling, and the interest payable to £2,500,080. The material prosperity of the N. is rapidly increasing, and a sum of probably not less than 300 million pounds is invested by N. capitalists in the funds of other nations.

The chief colonies are Java, Sumatra, Borneo, Celebes, the Spice Islands, and Papua or New Guinea, in the East; and Surinam, Curaçao, and its dependencies, in the West Indies, with factories on the coast of Guinea. Colonial pop. about 18 millions.

Government, Franchise, &c.—The government of the N. is a limited constitutional monarchy, heredi-

tary in the male line, and by default of that in the female. The crown-prince bears the title of Prince of Orange, and attains his majority at 18, when he takes his seat in the council of state. The executive is vested in the king, with a council of state composed of twelve members, nominated by his majesty, and the ministers of the Interior, Foreign Affairs, Finance, War, the Colonies, Marine, and Justice, the last-named taking charge of ecclesiastical affairs through two administrators, or under-secretaries of state, for the Protestant and Roman Catholic Churches. The legislative power is shared by the king and the two chambers of the States-general; the first chamber having 39 members, elected for nine years, by the provincial states, one-third of their number retiring every three years. The second chamber is composed of 72 members, chosen by electors above 23 years of age, who pay from £1, 14s. to £13, 12s. of direct taxes, according to the size and importance of the electoral district. These are elected for four years, one half of the chamber retiring every two years. For members of the town-councils, the electoral qualification is half the above sum. The members of both chambers must be 30 years of age before the day of election, and those eligible for the first chamber are the nobility. This exceedingly high franchise, which, in Amsterdam, is a higher direct tax than the rental qualification of Great Britain, makes an election a thing of no interest except to a few. In 1861, only 21·2 per cent. of the electors of Amsterdam gave their votes, and the maximum in any place was 46 per cent., in Assen, the capital of Drenth.

The king nominates the governors of provinces, the burgoemeesters of every city, town, or village, and a host of other officials. The cities, towns, and rural parishes are governed by a council, burgoemeester (mayor or provost), and wethouders (aldermen or bailies). The council consists of from 7 to 39 members, according to the population, who are chosen for six years, one-third part retiring every two years. The council selects out of their number from 2 to 4 wethouders for six years, one-half retiring every third year. These, with the burgoemeester, form the local executive. The law departments are the High Council, the provincial courts of justice, those of the arrondissements and cantons; appeal in many cases being open from the lower to the higher courts.

History.—Nothing is known regarding the original inhabitants of the N.; but about a century and a half before our era, the people known as the Batavi came out of Hesse, where they were living in hostility with their neighbours, and settled down between the Rhine and the Waal. At this time, the Frisians occupied the country north of the Rhine to the Elbe. The Batavi and Frisians differed little in appearance, manner of life, and religion. They clothed themselves with skins, lived by fishing, hunting, and pasturing cattle, possessing horses, cows, and sheep; were faithful, open-hearted, chaste, and hospitable. The songs of the bards composed their literature and history. Warlike and brave, they selected their leader for his courage and prowess, were armed with the bow and a short spear. They worshipped the sun and moon, and held their meetings in consecrated woods.

The Romans having subdued the Belge, next attacked the Frisians, who agreed to pay a tribute of ox-hides and horns, but continued restless and rebellious. The Batavi became allies of Rome, paying no tribute, but supplying a volunteer contingent, chiefly of cavalry, which decided the battle of Pharsalia in favour of Cæsar, and formed a gallant band of the Roman armies in all parts of the

NETHERLANDS.

empire. About 70 A. D., Claudius Civilis, a Batavian, whose original name has not been preserved, made a bold effort to overthrow the Roman power in Rhenish or Germanic Gaul, but he was finally compelled to sue for peace. Towards the close of the 3d c. began the inroads of the Franks, followed by the Saxons and other races; and in the 5th c., the Batavi had ceased to exist as a distinct people. The Franks continued to spread, and with them the Christian religion, Dagobert I., one of their princes, erecting a church at Utrecht, which, 695, became the seat of a bishopric. The Frisians were opposed to, and the last to embrace, Christianity, to which they were forcibly converted by Charles Martel. At the end of the 8th c., all the Low Countries submitted to Charlemagne, who built a palace at Nymegen, on the Waal. The feudal system now began to develop itself and expand into dukedoms, counties, lordships, and bishoprics, which the dukes, counts, and bishops, especially the counts of Holland and bishops of Utrecht, endeavoured to enlarge and to rule over with as little submission to their superior as possible. The Crusades weakened the power and drained the resources of the nobles and priesthood, so that, during the middle ages, cities began to assume importance, strengthen themselves with walls, choose their own rulers, and appear in the state meetings. In 1384, the county of Flanders passed, through marriage, to the Duke of Burgundy, whose grandson, Philip the Good, made it his special life-effort to form the N. into a powerful kingdom. He bought Namur, inherited Brabant with Limburg, and compelled Jacoba of Bavaria to resign Holland and Zeeland. Charles V., as heir of the house of Burgundy, inherited and united the N. under his sceptre, and the country attained to prosperity, through the encouragements which he gave to commerce and shipping. Philip II., who succeeded his father, 1556, by his harsh government and persecution of the Reformers, excited the N. to rebellion, which, after a struggle of 80 years, resulted in the firm establishment of the Republic of the United Provinces. The founder of the independence of the N. was William of Nassau, Prince of Orange, called in history the Silent, who freely sacrificed his own property, and put forth every effort to unite the discordant states of the South with those of the North in resisting the Spanish yoke. Retiring to Holland, and banding together several provinces for mutual defence, by an agreement made at Utrecht, 1579, he perseveringly opposed the efforts of Spain; and in 1609, the independency of the United Provinces (the boundaries of which nearly coincided with those of the present kingdom of the N.), was virtually acknowledged by the Spanish king, an armistice for twelve years being signed at Antwerp, April 9 of that year. The struggle was renewed and carried on till 1648, when all the powers acknowledged the independence of the United Provinces by the treaty of Munster, while the Belgic provinces, divided among themselves, remained submissive to Spain and to the Roman Catholic Church.

Prince William the Silent did not live to see his efforts for freedom crowned with success. Excited by religious fanaticism, and the hope of a great reward, Balthazar Gerard or Guion, 1584, shot the prince in his house at Delft, from a narrow passage, as he was stepping from the dining-room to ascend an adjoining stair which led to the second floor. With the 17th c., the United Provinces began to advance in power and wealth, their ships visiting all parts of the world. Meanwhile, the contest between the Arminians and Calvinists broke out, and raged with fury for many years; Grotius and others fleeing to other lands, and the statesman

Oldenbarneveld suffering on the scaffold at the age of 72. The United Provinces were presided over by the Princes of Orange till the troubles at the end of the 18th c. began the long European war, which the battle of Waterloo brought to a close. The National Convention of France having declared war against Great Britain and the Stadtholder of Holland, 1793, French armies overran Belgium, 1794; and being welcomed by the so-called patriots of the United Provinces, William V. and his family, January 1795, were obliged to escape from Scheveningen to England in a fishing junk, and the French rule began. The United Provinces now became the Batavian Republic, paying eight and a half millions sterling for a French army of 25,000 men, besides giving up important parts of the country along the Belgian frontier. After several changes, Louis Bonaparte, 5th June 1806, was appointed king of Holland, but, four years later, was obliged to resign because he refused to be a mere tool in the hands of the French emperor. Holland was then added to the Empire, and formed seven departments. The fall of Napoleon I., and dismemberment of the French Empire, led to the recall of the Orange family, and the formation of the Southern and Northern Provinces into the ill-assorted Kingdom of the N., which in 1830 was broken up by the secession of Belgium. In 1839, peace was finally concluded with Belgium; but almost immediately after, national discontent with the government shewed itself, and William I., in 1840, abdicated in favour of his son. The N. being moved by the revolutionary fever of 1848, King William II. granted a new constitution, according to which new chambers were chosen, but had scarcely met when he died, March 1849, and the present king, William III., ascended the throne. The nation is prosperous, and the East India colonies, which were a burden in the earlier years of the kingdom, have long been a source of profit.

A bill for the emancipation of the slaves in the N. West India possessions passed both chambers, 8th August 1862, and received the royal assent. It decreed a compensation of 300 guilders for each slave, except those of the island of St Martin, who were to be compensated for at 30 guilders each. The freed negroes may choose the place to labour, but must be able to satisfy the government officers that they are employed somewhere. This surveillance to continue during ten years. The law came into force 1st July 1863, and in Surinam and all the other colonies the day passed quietly over. Those, however, interested in agriculture have sent an address to the minister of the colonies, protesting against the high-wages tariff as hostile to the successful carrying on of their operations. The rate, however, is not higher than the planters in the neighbouring British colony of British Guiana are accustomed to pay. In the budget for 1863, provision was made for the extraordinary expenses connected with the emancipation to the amount of £1,065,366, of which £867,000 as compensation for the slaves of Surinam, and £21,250 as premiums for free labour. For Curaçao and its dependencies, £166,090 of compensation money, fully £12,000 being for various other outlays connected with the change. The number of slaves set free may be stated in round numbers to be 42,000, of whom 35,000 are in Dutch Guiana.

On 16th July 1863, a treaty was signed at Brussels by all the naval powers for the buying up of the toll levied, under treaty arrangements, by the king of the N., on vessels navigating the Schelde (q. v.), the king of Belgium binding himself also to reduce the harbour, pilot, and other charges on shipping within that kingdom.

NETHERLANDS TRADING COMPANY—NETLEY.

The N. have suffered much from floods, either caused by the breaking in of the sea, or by the descent of masses of water from Germany, while the rivers of the Rhine delta were blocked up with ice. The Zuider Zee (q. v.), which contains 1365 square miles, was of trifling extent till the flood of All Saints' Day, 1247, when the North Sea swallowed up a large tract of country. In 1277, the Dollart Gulf, in Groningen, was formed at the mouth of the Ems, by floods in the spring and autumn of that year, which destroyed 33 villages and 100,000 people. The immense waste of waters, known as the sunken South Holland Waarde, or Biesbosch, arose out of the breaking of one of the dykes, 1421, by which 72 villages were laid under water, only 34 of them reappearing. In modern times, great floods, but fortunately with only temporary results, have occurred in 1809, 1825, and 1855. That of 1855, which placed the town of Veenendaal, in Gelderland, and an extensive tract of country under water, was caused by a rapid thaw in the high lands of Germany pouring down torrents of water into the N. while the rivers were ice-locked after a winter of unusual severity.—See *Aardrijksbeschrijving Door, C. Beyer; Nederland-Geographisch-Historisch Overzicht Door, Luit. L. G. Beausar; Statistiek Jaarboek* (Witkamp, Amsterdam), an excellent book of reference, which is published yearly up to the present time; the Provincial Annual Reports, &c.

NETHERLANDS TRADING COMPANY, a chartered joint-stock association, with limited liability, formed to aid in developing the natural resources of Java. The Company possesses peculiar privileges, acting exclusively as the commission agents of the Netherlands government in all import and export transactions with the East India colonies, as well as doing a large private business as merchants. Private enterprise having failed to develop the trade of Java, after that island was restored to the Netherlands, King William I., in 1824, erected the Trading Company, with a capital of upwards of 3 millions sterling, not only becoming a large shareholder, but guaranteeing an interest of 4 per cent. on the paid-up capital. The early transactions were unprofitable, and in 1827 the king had to pay a part, and in 1830 the whole of the guaranteed interest. From that date, it has prospered and handed over, from the trade of Java (q. v.), large surplus balances into the national revenue. The head office of the directors is at Amsterdam, with agents at Rotterdam, Middelburg, Dordrecht, and Schiedam; the principal factory at Batavia, with agencies at the chief ports in Java and the other Netherlands possessions in the Eastern Archipelago. Immense quantities of goods suited for the colonial markets are bought, shipped from Holland and sold by the Company, for the account and at the risk of government; all the produce derived from the crown-lands being also placed in the factories, forwarded to Holland, arranged according to quality, and disposed of at the Company's periodical sales in Amsterdam, Rotterdam, &c. In 1857, one-third part of the calicoes, drills, and shirtings sent to Java was by the Trading Company, and the proportion of the trade from Java to the Netherlands which it enjoys, will appear from the following table:

SHIPPED FROM JAVA TO THE NETHERLANDS, IN 1857, BY

	Trading Company.	Private Merchants.
Nutmegs,	5,259	422 picols.
Cinnamon,	1,169	1,070 "
Indigo,	247,375	326,111 lbs.
Tobacco,	438,260	22,265 "
Sugar,	892,848	478,073 picols.
Coffee,	93,848	16,902 "

The present capital of the Company is 31 million

guilders, and 5 millions of a reserve fund, or £3,150,000. The amount of commission paid by government is privately arranged according to circumstances. For many years the shares have been at a considerable premium, selling (1863) at 149, and the dividends average 10 per cent.

The success of the Trading Company depends mainly on the culture system, which was introduced into Java in 1830. Under the native rule, the land belonged to the princes, and the cultivators paid one-fifth of the produce, and one-fifth of their labour as ground-rent. The Dutch, by conquest, are now the proprietors of the greater part of the island, and exact the old produce rent, relaxing the labour to one-seventh, directing the holders of crown-lands to plant one-fifth of their cultivated fields with the crop best adapted for the soil and required for the European market. The government also has supplied, free of interest, enterprising young men with the capital necessary to erect and carry on works for the preparation of the raw materials, to be repaid in ten yearly instalments, beginning with the third year. The landholders of a certain district allotted to a sugar-mill were bound to supply a fixed quantity, receiving advances upon the crop to enable them to bring it forward. The rule of fixed quantity was relaxed in 1860, and has caused great discontentment among the contractors. The European residents and their assistants, the native princes, chiefs, and village head-men, receive a percentage according to the quantity which is manufactured from the produce delivered, so that all are interested in taking care that the lands are cultivated and the crops cared for. Sugar, tobacco, and tea are prepared by contractors; indigo, cochineal, coffee, cinnamon, and pepper by the natives under European surveillance, all passing into the Trading Company's factories for shipment to the Netherlands. The objections to the system are, that it does not leave the labour of the natives free, and that the passing of so much of the export and import trade through one favoured company injures the general merchant. On the other hand, it must be said that the Dutch government only carries out the old law, and it is therefore not regarded by the peasantry as an infringement of their rights; and the merchants and capitalists of the Netherlands did not of themselves put forth sufficient efforts to work out the natural capabilities of Java when it returned under Dutch rule.

NETLEY, ROYAL VICTORIA HOSPITAL AT, is a superb building, on the shore of Southampton Water, for the reception of invalids from the army on foreign service, and from among the troops serving in the adjoining military districts. In times of peace, it is only necessary to use a portion of the vast structure; but in the event of a European war, in which the British army should take part, the exigencies of the service would probably tax its accommodation to the utmost. There is provision for 1000 patients, with power to increase the number if necessary. The medical staff of course varies in proportion to the work to be done; but at present (1864) it consists of a governor, a paymaster, a captain of orderlies, an assistant-commandant, and 16 medical officers and purveyors of various ranks. The total cost of the construction of this hospital, which was commenced in 1855, has been about £350,000. Attached is the Medical School for candidates for the army medical department, the students having the best means of practical instruction in the wards of the hospital. N. is also the headquarters of the female nurses of the army, who are under the control of a lady stationed here as superintendent-general. Complete arrangements have been made for the landing of wounded men in front

of the hospital, and for conveying them thither with the least disturbance. There is no doubt as to the convenience of this great hospital for its purposes; but some questions have been raised, under high sanitary authority, as to the salubrity of the site, adjacent as it is to the wide banks of mud which Southampton Water uncovers at low tide.

NETS are fabrics in which the threads cross each other at right angles, leaving a comparatively large open space between them; the threads are also knotted at the intersections. In this respect, netting differs essentially from weaving, where the intersecting threads simply cross each other. The open spaces in nets are called *meshes*, and these correspond in size with an instrument used in net-making, consisting of a flat piece of wood or other hard substance, usually about the shape and size of a common paper-knife. In addition to this, a peculiar kind of needle (fig. 1) is used, upon which a large quantity of the thread is placed, by winding it from end to end between the forked extremities; the holes

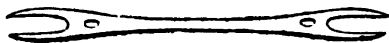

Fig. 1.

are used to insert the end of the thread, to prevent it slipping off at the commencement of the winding. The art of net-making has been practised from the earliest times by the most savage as well as the most civilised nations. Even where the art of weaving was quite unknown, as in some of the South Sea Islands when first discovered, that of netting was well understood; and it is easy to see that the human race could not help learning the value of this art from seeing how frequently land and water animals get entangled in the shrubs and weeds through which they attempt to pass; hence we find amongst savage tribes, almost universally, nets are used not only for fishing, as with us, but also for entrapping land animals. We have ample illustrations of the uses of nets for both purposes in the bas-reliefs of Assyria, Greece, and Rome, and in the mural paintings of Egypt.

Until recently, nets have been always made by hand, and generally the thread has been a more or less thick twine of hemp or flax, the thickness of the twine and the size of the mesh depending upon the kind of fish for which it was made; recently, however, great improvements have been made in the manufacture of nets, and machinery of a most beautiful automatic kind has been introduced by Messrs Stuart of Musselburgh, whose manufactory is of vast extent. This establishment commences with the raw materials, which are hemp, flax, and cotton, the last having been extensively employed for herring and sprat nets of late years. Hemp, however, is the chief material for net-making; and in order to prepare it, it is first passed in long rolls through a machine consisting of two rollers with blunt ridges, the upper of which is kept down on the material by means of a hanging weight, consisting of a loaded box suspended to a chain from the axle of the roller. After the fibre has passed through this, it is much more supple than before, and is then *hackled*; this process is also done by machinery, which was first introduced into this manufactory for hemp-hackling, and succeeds admirably. It subsequently passes through the carding, roving, and spinning processes, as in all other kinds of yarn, and is finally twisted into threads or twines of the required thickness. Messrs Stuart have in one room 4000 spindles at work, besides the carding and twist machines. Of their patent loom they have 200 at work, the largest

of which makes nets 480 meshes in width. It would be useless to attempt to describe these ingenious looms, which are worked by hand, otherwise than by saying that their leading features are like the stocking-frames; a series of sinkers push forward, pull down, and pass in and out the thread, which is carried from one side of the web to the other by long iron needles, which act as shuttles passing not over-quickly from a long box on each side of the loom, as in fig. 2, which shews the box, *a*, with

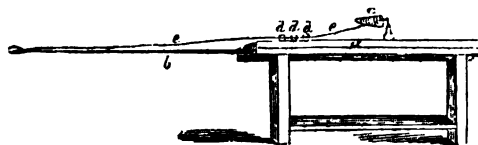

Fig. 2.

shuttle-needle, *b*, protruded; *c* is the bobbin of twine which feeds the needle, and for this purpose must have a conical form, which is most ingeniously given it by a special contrivance, in the twisting-machine; *d, d* are small rings, through which the twine, *ee*, passes, to prevent it being given off too quickly, or in knots or kinks. This simple yet most effective contrivance is worked by wheels and jointed rods, and might be advantageously applied to many other purposes. After the net comes from the loom, it goes to the finishers, who, by hand, make the addition of a kind of selvage, consisting of several thicknesses of twine, to give strength to the edges. The nets are then ready for use, and are sent in vast numbers to all parts of the world.

A great variety of nets are in use amongst fishermen, but the principal are the *seine*, *trawl*, and *drift nets*. The seine is a very long but not very wide net, one side of which is loaded with pieces of lead, and consequently sinks; the other, or upper, is buoyed with pieces of cork, and consequently is kept up to the surface. Seines are sometimes as much as 190 fathoms in length. When stretched out, they constitute walls of network in the water, and are made to enclose vast shoals of fish. The trawl is dragged along the bottom, by the fishing-boat; and the drift-net is like the seine, but is not loaded with lead; it is usually employed for mackerel fishing.

Various kinds of nets are used in bird-catching, one of which is noticed in the article CLAP-NET. Nets are used in catching quadrupeds, chiefly for the purpose of enclosing spaces within which they are, but sometimes also for throwing upon them to confuse and entangle them.

Nets are used by gardeners to protect crops from birds; also to protect the blossoms of trees from frost, and it is wonderful how well this object is accomplished, even when the meshes are pretty wide, and the sun's rays have very free access.

NETTING, NAVAL. A *boarding-netting* is formed of strong rope, and stretched above the bulwarks of a ship, over the port-holes, &c., to a considerable height, for the purpose of preventing the entrance of boarders from hostile boats. In positions where boat attacks are feasible, ships are thus protected at night, and at other times when attempts at boarding are anticipated.

The *hammock-netting* is in the bulwarks of a ship, usually in the waist, and its purpose is to keep the hammocks of the crew when stowed there during the day; thus netted together, the hammocks form a valuable barrier against bullets.

Hatchway-nettings are of inch rope, and are placed

NETTLE—NETTLE-RASH.

over the open hatchways during fine weather, to prevent persons from falling through.

NETTLE (*Urtica*), a genus of plants of the natural order *Urticeae*, having unisexual flowers, the male and female on the same or separate plants; the male flowers with a 4-parted perianth, and four stamens; the female flowers with a 2-parted perianth and a tufted stigma; the fruit an acheneum. The species are herbaceous plants, shrubs, or even trees, many of them covered with stinging hairs, which pierce the skin when touched, and emit an acrid juice, often causing much inflammation and pain. When a N. is grasped in such a way as to press the hairs to the stem, no stinging ensues; but the slightest inadvertent touch of some of the species produces very severe pain. The stinging of the native nettles of Europe is trifling in comparison with that of some East Indian species. *U. crenulata* is particularly notable for the severity of the pain which it produces, without either pustules or apparent inflammation. The first sensation is merely a slight tingling, but within an hour violent pain is felt, as if a red-hot iron were continually applied, and the pain extends far from the original spot, continues for about twenty-four hours and then abates, but is ready to return in its original intensity on the application of cold water, and does not cease for fully eight days. Cold water has a similar effect in increasing or renewing the pain of all kinds of nettles. Still more formidable than this species is *U. urentissima*, the *Devil's Leaf* of Timor. Of British species, the most venomous, but the most rare, is the **ROMAN N.** (*U. pilulifera*); next to it is the **SMALL N.** (*U. urens*), frequent about towns and villages, and in waste and cultivated ground; whilst the least venomous is the most common and only perennial species, the **GREAT N.** (*U. dioica*), everywhere abundant, but particularly near human habitations, or their former sites, the desolation of which it may be said to proclaim. The roots of nettles, boiled with alum, afford a yellow dye; and the juice of the stalks and leaves has been used to dye woollen stuffs of a beautiful and permanent green. The young shoots of *U. dioica* are used in some parts of Scotland and other countries as greens, and their peculiar flavour is much relished by some, although, in general, the use of them is confined to the poor; which, however, is probably the result of mere prejudice. Whatever it is that gives nettles their stinging power, is dissipated by boiling. The high value of nettles as food for swine, is well known to the peasantry of many countries; the Great N. is cultivated in Sweden for fodder of domestic animals; nettles are also highly esteemed as food for poultry, particularly for turkeys. The seeds are extremely nutritious to poultry; and are given to horses by jockeys, in order to make them lively when they are to be offered for sale. The stalks and leaves of nettles are employed in some parts of England, for the manufacture of a light kind of beer, called *N. beer*, which may be seen advertised at stalls, and in humble shops in Manchester and other towns. The *best* fibre of nettles is useful for textile purposes. Yarn and cloth, both of the coarsest and finest descriptions, can be made of it. The fibre of *U. dioica* was used by the ancient Egyptians, and is still used in Piedmont and other countries. When wanted for fibre, the plant is cut in the middle of summer, and treated like hemp. The names *N. Yarn* and *N. Cloth* are, however, now commonly given in most parts of Europe to particular linen and cotton fabrics.—The fibre of *U. cannabina*, a native of the south of Siberia and other middle parts of Asia, is much used; and from that of *U. Whitlavi*, both fine lace and strong ropes can be manufactured. The fibre

of *U. Japonica* is much used in Japan, and that of *U. argentea* in the South Sea Islands; that of *U. Canadensis* is used in Canada.—The seeds and herbage of *U. membranacea* are used in Egypt as emmenagogue and aphrodisiac; and somewhat similar properties are ascribed to *U. dioica*.—*U. tuberosa* produces tubers, which are nutritious, and are eaten in India, raw, boiled, or roasted.—Australia produces a magnificent tree-nettle, *U. gigas*, abundant in some parts of New South Wales, ordinarily from 25 to 50 feet high, but sometimes 120 or 140 feet, with trunk of great thickness, and very large green leaves, which, when young, sting violently. In some places, it forms *scrub forests*, and its stinging leaves form a great impediment to the traveller.

NETTLE-RASH, or **URTICARIA** (Lat. *urtica*, a nettle), is the term applied to a common form of eruption on the skin. The eruption consists of wheals, or little solid eminences of irregular outline, and either white or red, or most commonly both red and white, there being a white centre with a red margin. The rash is accompanied with great heat, itching, and irritation; the appearance on the skin and the sensation being very much like the appearance and feeling produced by the stinging of nettles; and hence the origin of its names.

The disease may be either acute or chronic. In the acute form, feverishness usually precedes the rash by a few hours, although sometimes they commence together. The disorder is always connected with some derangement of the digestive organs, and it may often be traced to the imperfect digestion of special articles of food, such as oatmeal, the kernels of fruit, strawberries, cucumbers, mushrooms, and especially oysters, musels, and crabs, which are eaten with perfect impunity by most persons. An hour or two after the offending substance has been swallowed, there is a feeling of nausea, with oppression about the pit of the stomach; the patient often complains of giddiness, and the face frequently swells; the skin then begins to tingle, and the eruption breaks forth; vomiting and diarrhoea often supervene, and act as a natural cure; but even when they do not occur, the violence of the rash usually subsides in a few hours, and the disorder altogether disappears in a day or two.

The chronic form is often very troublesome, and frequently comes on periodically in the evening. Cases are reported in which persons have been afflicted for ten years continuously by this form of the disease. Patients have left off all their customary articles of diet, one by one, without in all cases meeting with relief; and hence it may be inferred, that although the disease depends in all cases on a disordered condition of the digestive organs, it is not always the consequence of some special offending article having been swallowed.

The main treatment of the acute form consists in expelling the offending matter by an emetic and by purgatives, and the cure is thus usually completed. In the chronic form, the patient should, in the first place, determine whether the rash is caused by any particular article of diet, and if this seems not to be the case, an attempt must be made to improve the state of the digestive organs. A few grains of rhubarb taken daily, just before breakfast and before dinner, will sometimes effect a cure. If this simple remedy fails, Dr Watson recommends the trial of a draught composed of the infusion of serpentaria (about an ounce and a half), with a scruple each of the carbonates of magnesia and soda. He adds, that although external applications are usually of little avail, he has found that dusting the itching surface with flour sometimes affords temporary relief; and that a still more useful

NETTLE-TREE—NEUHAUSEL.

application is a lotion composed of a drachm of the carbonate of ammonia, a drachm of the acetate of lead, half an ounce of laudanum, and eight ounces of rose-water.

NETTLE-TREE (*Celtis*), a genus of deciduous trees of the natural order *Ulmaceae*, with simple and generally serrated leaves, considerably resembling those of the Common Nettle, but not stinging. The genus is distinguished chiefly by its fruit, which is a fleshy, globose, or sub-globose 1-celled drupe. The Common or European N. T. (*C. Australis*) is a native of the south of Europe, the west of Asia, and the north of Africa. It grows to the height of 30—40 feet, and is a very handsome tree, often planted along public walks in the south of France and north of Italy. The wood is very compact, very durable, and takes a high polish. It was formerly much imported into Britain for the use of coachmakers. It is used in Italy by musical-instrument makers for flutes and pipes. The flowers are inconspicuous, axillary, and solitary; the fruit black, resembling a small wild cherry, not eatable till after the first frosts, and then very sweet. The kernel yields a useful fixed oil. The tree succeeds well in the south of England.—*C. occidentalis* is a native of North America from Canada to Carolina, sometimes there called the N. T., sometimes the SUGAR BERRY. Its leaves are much broader than those of *C. Australis*, its fruit very similar. It is a much larger tree, attaining a height of 60—80 feet.—Another American species, *C. crassifolia*, often called HACKBERRY or HAGBERRY, and HOOP ASH, is very abundant in the basin of the Ohio and westward of the Mississippi. It grows to a great height, but the trunk is not very thick. The wood is not much valued, but is said to make very fine charcoal. The fruit is black, and about the size of a pea.—The inner bark of *C. orientalis*, consisting of reticulated fibres, forms a kind of natural cloth, used by some tribes of India.—A number of other species are natives of the warm parts of America and of Asia.

NEU-BRANDENBURG, a town of Mecklenburg-Strelitz, and the largest and most beautiful in the duchy, is situated on Lake Tollens, 17 miles north-north-east of Neu-Strelitz. It is regularly built, contains two churches, a castle, &c., is the centre of a picturesque district, and the seat of considerable industry. Pop. 6766.—About half a league from N., on a rock overlooking Lake Tollens, stands the ducal pleasure-castle of Belvedere, commanding, it is said, the most beautiful prospect in Mecklenburg.

NEUBURG, an ancient town of Bavaria, is picturesquely situated on the right bank of the Danube, 29 miles north-north-east of Augsburg. It contains a handsome palace, the chateau of the Dukes of Bavaria of the line of Pfalz-Neuburg, who resided here from 1596 to 1742. The palace contains a collection of ancient armour. Brewing and distilling are carried on, and there is a considerable commercial trade on the Danube. Pop. 6769.

NEUFCHATEL, or NEUCHATEL, known also as *Neuenburg*, a canton in the west of Switzerland, between Lake Neuchatel and the French frontier, in lat. 46° 52'—47° 10' N., and long. 6° 28'—7° 5' E. Area, 304 square miles. Population, 87,369, at the close of 1860. N. lies in the midst of the Jura Mountains, four chains of which, running from north-east to south-west, traverse the canton, and are separated by elevated longitudinal valleys. The most easterly of these is a broken chain, running parallel to the lake of Neufchatel, on whose banks, and on the second and lower ranges beyond it, the vine is carefully cultivated. This second chain has five principal passes, the highest of

which, La Tourne, has an elevation of about 4000 feet. The third and fourth ranges, abutting on France, consist for the most part of barren hills, separated by elevated valleys; but here and there these high lands are well wooded and fruitful, producing corn, good pasture, fruits, &c. The greater number of the numerous streams which water the canton flow into the Rhine. Among these mountain torrents, the principal are the Reuse, the Seyon, and the Serriere, the two former of which, together with the rivers Orbe and Broie, are the feeders of the Lake of Neufchatel, known also as the Lake of Yverdun. The Thiele serves as its outlet, and carries its waters into the neighbouring lake of Biemme, and into the river Aar. The lake is 25 miles long, and from 3 to 5½ miles wide. Its level above the sea is 1420 feet, and it has a depth of 400 or 500 feet.

The natural products are iron ores, coal, asphalt, fruit, including grapes—from which good red and white wines are made—timber and corn, although the latter is not grown in sufficient quantity for the demands of the home consumption. The rearing of cattle constitutes an important branch of industry, and large quantities of cheese are exported; but the speciality of the canton is watch-making, which occupies from 18,000 to 20,000 persons, and is prosecuted in detail at the homes of the work-people, in the rural districts, where some families manufacture only special parts of the machinery, while others are engaged solely in putting together the separate portions that have been manufactured by others; and the watches thus prepared are exported in large quantities to every part of Europe and America. Mulin-printing employs upwards of 10,000 persons, and lace is extensively made by the country-women of the Val de Travers.

The climate of N. varies greatly with the locality; being temperate on the shores of the lake, cooler in the valleys, and severe on the mountain-sides. The population, with the exception of between 5000 and 6000 Catholics, belongs to various Protestant denominations.

The history of N. was identical with that of Burgundy, till the 11th c.; and after the principality had been for a time incorporated with the territories of the Counts of Chalons, to whom it had been granted in 1288, by Rudolph of Hapsburg, it passed to the House of Longueville. In 1707, on the extinction of the N. branch of the latter family, 15 claimants came forward to advance more or less valid pretensions to the N. territory. Frederick I. of Prussia, who based his claim to the principality of N. on the ground of his descent from the first Prince of Orange, a descendant of the House of Chalons, was the successful candidate; and from his time it continued associated with Prussia till 1806, when Napoleon bestowed it upon General Berthier; but in 1814, it was restored to the House of Brandenburg. This connection with the Prussian monarchy has been wholly dissolved since 1857, and N. is now a member of the Swiss Confederation.

NEUFCHATEL or **NEUENBURG**, the chief town of the canton (pop. 7727), occupies a magnificent site on the north-west shore of the Lake of Neufchatel, and is noted for its many charitable institutions, and for the beauty of its charmingly situated environs.

NEUHAUS, a town of Bohemia, on the Neescharka, about 70 miles south-south-east of Prague. Its palace, belonging to Count Czerny, is a splendid edifice. Cloth, paper, and chemical products are manufactured. Pop. 7600.

NEUHAUSEL (Hung. *Eroek-Ujvár*), a town of Hungary, on the right bank of the Neutra, 74 miles

north-west of Pesth, by the Vienna and Pesth Railway. It was formerly strongly fortified, and played an important part in the Turkish wars. No traces of its fortifications now remain. Pop. 7300, chiefly engaged in agriculture and the rearing of cattle.

NEURALGIA (Gr. *neuros*, a nerve; *algos*, pain) is a term employed to designate pain of a purely nervous character, usually unaccompanied by inflammation, fever, or any appreciable change of structure. The pain, which occurs in paroxysms, usually followed by complete remissions, is of every possible degree and character, being described in different cases as piercing, tearing, burning, &c. These paroxysms may occur at intervals of a few seconds only, or they may take place daily or on alternate days, or they may be separated by much longer intervals, which are often, but by no means always, of a regular length. With the pain, there is frequently spasmodic twitching of the adjacent muscles. The duration of the disease is very uncertain. The patient may have only a single attack, or he may be liable to recurring attacks for months, years, or even for his whole life; it is, however, very seldom that the disease occurs but once. Death scarcely ever results directly from this affection, but the pain may, by its severity and persistence, gradually undermine the constitution.

The disease may attack any part of the body where there are nerves; but in no part does it occur so frequently as in the face, when it is popularly known as *Tic Douloureux*; its seat being in the facial branches of the fifth pair of nerves (the trifacial nerves—see fig. 2 in NERVES). The following graphic description of the ordinary varieties of this form of neuralgia is borrowed from Dr Watson's *Lectures on the Principles and Practice of Physic*: 'When the uppermost branch of the trifacial nerve is the seat of the complaint, the pain generally shoots from the spot where the nerve issues through the superciliary hole; and it involves the parts adjacent, upon which the fibrils of the nerve are distributed—the forehead, the brow, the upper lid, sometimes the eyeball itself. The eye is usually closed during the paroxysm, and the skin of the forehead on that side corrugated. The neighbouring arteries throb, and a copious gush of tears takes place. In some instances, the eye becomes blood-shot at each attack; and when the attacks are frequently repeated, this injection of the conjunctiva may become permanent.

'When the pain depends upon a morbid condition or morbid action of the middle branch of the nerve, it is sometimes quite sudden in its accession, and sometimes comes on rather more gradually; being preceded by a tickling or pricking sensation of the cheek, and by twitches of the lower eyelid. These symptoms are shortly followed by pain at the infra-orbital foramen, spreading in severe flashes (so to speak) over the cheek, affecting the lower eyelid, ala nasi, and upper lip, and often terminating abruptly at the mesial line of the face. Sometimes it extends to the teeth, the antrum, the hard and soft palate, and even to the base of the tongue, and induces spasmodic contractions of the neighbouring muscles.

'When the pain is referrible to the inferior or maxillary branch of the fifth pair of nerves, it darts from the mental foramen, radiating to the lips, the alveolar processes, the teeth, the chin, and to the side of the tongue. It often stops exactly at the symphysis of the chin. Frequently it extends in the other direction, to the whole cheek and to the ear. During the paroxysm, the features are liable to be distorted by spasmodic action of the muscles of the jaw, amounting sometimes to tetanic rigidity, and holding the jaw fixed and immovable.

'The paroxysms of suffering in this frightful disease are apt to be brought on by apparently trivial causes—by a slight touch, by a current of air blowing upon the face, by a sudden jar or shake of the bed on which the patient is lying, by a knock at the door, or even by directing the patient's attention to his malady, by speaking of it or asking him questions about it. The necessary movements of the face in speaking or eating are often sufficient to provoke or renew the paroxysm. At the same time, firm pressure made upon the painful part frequently gives relief, and causes a sense of numbness to take the place of the previous agony' (vol. i. pp. 723, 724).

Tic douloureux is the form of severe neuralgia which is by far the most commonly met with; the reason probably being, that the trifacial nerve, lying superficially, and being distributed over a part of the surface which is usually unprotected by any artificial covering, is very liable, for that reason, to be affected by exposure to atmospheric influences, which are undoubtedly to be included among the exciting causes of this disease. Amongst other seats of neuralgia may be mentioned the arm, especially the forearm, the spaces between the ribs, especially between the sixth and ninth, and the lower extremity, where it most frequently affects the sciatic nerve, giving rise to the affection known as *SCIATICA*, which, however, not always being pure neuralgia, will be noticed in a separate article.

The causes of neuralgia are various. Excluding inflammation of the nervous trunk or *neuritis*, the pain may be excited by a tumour pressing on the nerve, or originating in its substance; or by roughness of a bony surface with which the nerve may be in contact, as when it passes through a foramen; or it may be due to tumours within the cranium, or a morbid state of the spinal cord. Sometimes, again, irritation applied to one branch of a nerve will give rise to pain at the extremity of another branch of the same nerve, the sensation being reflected along the branch which is not directly exposed to the irritation. In this way we may explain the pain in the shoulder which often accompanies disease of the liver; the pain in the thigh, which is often associated with irritation of the kidney; the pain in the left arm, which is often coincident with disease of the heart, &c. Persons suffering from debility, anæmia, and a gouty or rheumatic constitution, are so especially liable to neuralgia, that these conditions—as also exposure to malarious influences—must be placed among the predisposing causes. Amongst the exciting causes, exposure to cold and wet, or to a cold dry east wind, is the most frequent; but fatigue, strong mental emotions, the abuse of tea, coffee, tobacco, and alcoholic drinks, a wound or bruise, the retrocession of gout, rheumatism, or cutaneous eruptions, &c., occasionally suffice to excite the disease.

The resources of the *materia medica* have been exhausted in searching for remedies for this cruel disease. Dr Elliotson believes that 'in all cases of neuralgia, whether exquisite or not, unaccompanied by inflammation, or evident existing cause, iron is the best remedy;' and there can be no doubt that when the disease is accompanied with debility and paleness, no remedy is likely to be so serviceable. If the digestive organs are out of order, the neuralgia may not unfrequently be removed or alleviated by correcting their unhealthy state. 'Dr Rigby tells us that having suffered in his own person an intense attack of *tic douloureux*, which opium did not assuage, he swallowed some carbonate of soda dissolved in water. The effect was almost immediate; carbonic acid was eructed, and the pain quickly abated. In this case, the pain depended upon the

mere presence of acid in the stomach. More often the cause of offence appears to lie in some part of the intestines; and purgatives do good. Sir Charles Bell achieved the cure of a patient upon whom much previous treatment had been expended in vain, by some pills composed of cathartic extract, croton oil, and galbanum. He mixed one or two drops of the croton oil with a drachm of the compound extract of colocynth; and gave five grains of this mass, with ten grains of the compound galbanum pill, at bedtime. Other cases have been since reported, both by Sir Charles and by others, in which the same prescription was followed by the same success.—Watson, *op. cit.* p. 727.

When the disease occurs in a rheumatic person, iodide of potassium (from three to five grains taken in solution three times a day before meals) sometimes gives great relief. When the paroxysms occur periodically—as, for example, with an interval of 24 or 48 hours—sulphate of quinine in doses of from 10 to 20 grains between the paroxysms, will usually effect a cure; and if the disease resist comparatively small doses, the quantity may be increased to half a drachm, or a drachm if necessary. Arsenic acts in the same manner as quinine in these cases, but usually less effectually.

The inhalation of chloroform will sometimes give permanent relief, and always gives temporary ease, and shortens the period of suffering.

The injection of a certain quantity of a solution of muriate of morphia, by means of a sharp-pointed syringe, into the cellular tissue beneath the skin over the painful spot, very often gives immediate relief. For the discovery of this mode of treating neuralgia, we are indebted to Dr Alexander Wood of Edinburgh. At one time—about half a century ago—it was a common practice to divide the trunk of the painful nerve, with the object of cutting off the communication between the painful spot and the brain; but in many instances the operation signally failed, and it is now never resorted to. A much simpler operation, namely, the extraction of a canine tooth, has often been found to give permanent relief in cases of facial neuralgia, and in such case a careful examination of the teeth should usually be made.

Local applications can be of no permanent service in cases where the pain results from organic change, or from general constitutional causes; they will, however, often give considerable temporary relief. Amongst the most important local applications may be mentioned laudanum, tincture of aconite (or aconitina ointment, in the proportion of one or two grains to a drachm of simple ointment or cerate), belladonna-plaster, and chloroform (which should be applied upon a piece of linen saturated with it, and covered with oiled silk, to prevent evaporation).

Lastly, neuralgia being a purely nervous affection, is often influenced by means calculated to make a strong impression on the mind of the patient; and hence it is that galvanic rings, electric chains, mesmeric passes, homœopathic globules, and other applications, which, like these, act more upon the mind than upon the body of the patient, occasionally effect a cure.

NEURITIS is the term applied to inflammation of the nerves. The disease is rare, and not very well defined. The symptoms closely resemble those of neuralgia. Rheumatism seems, in most cases, to be the cause of the disease, which must be treated by bleeding, leeching, purging, and low diet. Anodynes are also required for the relief of the pain; and of these, Dover's Powder, in tolerably full doses, is perhaps the best.

NEUROPTERA (Gr. nerve-winged), an order of

mandibulate insects, having four nearly equal and membranous wings, all adapted for flight, divided by their nervures into a delicate net-work of little spaces, and not covered with fine scales, as in the *Lepidoptera*. The wings are often extended horizontally when at rest, nearly as in flight; but the position is various. The form of the wing is generally somewhat elongated. The body is generally much elongated, particularly the abdomen. The head is often large, the compound eyes very large, and there are often also simple or stemmatic eyes. The habits are predaceous, at least in the larva state; often also in the pupa and perfect states, the food consisting of other insects, often caught on the wing. The power of flight is accordingly great in many. The larvæ and pupæ are often aquatic. The females have no sting, and only a few have an ovipositor. The metamorphosis is complete in some, incomplete in others. Dragon-flies, May-flies, scorpion-flies, ant-lions, and termites, or white ants, belong to this order.

NEU'SATZ (also *Neoplanta* or *Uj-Videk*), a town of the Austrian empire, in the Servian Wojwodschafft, is situated on the left bank of the Danube, opposite Peterwardein. Its origin dates from the year 1700, and in the year 1849 it numbered nearly 20,000 inhabitants. A bridge, 840 feet in length, extends between N. and the town and fortress of Peterwardein. N. is the seat of the Greek non-unioned Bishop of Bács. On the 11th June 1849, it was taken from the Hungarian insurgents by the imperial troops, and was almost wholly destroyed. It appears, however, to be again reviving. It is a station for steamers on the Danube, and carries on an important and active trade. Pop. 10,000.

NEUSE, a river of North Carolina, United States of America, rises near the middle of the northern boundary of the state, and, after a south-easterly course of 250 miles, falls by a broad channel into Pamlico Sound, which communicates by several inlets with the Atlantic Ocean. It forms the harbour of Newbern.

NEU'SIEDL, LAKE (Hung. *Ferto-tava*), a small lake on the north-west frontier of Hungary, 22 miles south-east of Vienna. It is 23 miles in length, and about 6 miles in average breadth, with a mean depth of 13 feet. Its waters are light-green in appearance, and are brackish in taste. The slopes of the Leitha Mountains in the vicinity produce excellent wine.

NEU'SOHL (Hung. *Besztercze-Bánya*), a beautiful and thriving town of Hungary, the chief place of the richest mining district in the country, is situated in a hill-enclosed valley on the right bank of the Gran, about 85 miles north of Pesth. N., consisting of the town proper (pop. 6200) and five suburbs, contains a population, in all, of upwards of 10,000, who are employed in the copper and iron mines of the vicinity, in the smelting-houses, and in the manufacture of beet-root sugar, paper, colours, &c. It is the seat of a bishop, and contains a beautiful cathedral, a bishop's palace, and two evangelical churches, and several other handsome edifices.

NEUSS, a fortress and flourishing manufacturing town of Rhenish Prussia, near the left bank of the Rhine, with which it is connected by the river Erft, 4 miles south-west of Düsseldorf. Its church of St Quirinus, a beautiful edifice, and a notable specimen of the transition from the round to the pointed style, is supposed to have been built in 1209. N. is the principal grain-market of the province, and carries on manufactures of woollen and other cloths, ribbons, hats, vinegar, &c. It is supposed to be

NEUSTADT—NEUTRALS.

the *Novesium* of the Romans, sacked by Attila in the year 451. Pop. 9776.

NEUSTADT (Polish, *Prudnitz*), a town of Prussian Silesia, 29 miles south-west of Oppeln. It is the seat of considerable manufacturing industry, woollen and linen fabrics being the staple goods manufactured. Damask-weaving alone employs 660 hands, and 380 looms. Pop. 7263.

NEUSTADT, or **WIENER-NEUSTADT**, one of the most beautiful towns of Lower Austria, called, from its loyalty, 'the ever-faithful town' (*ewig getreue Stadt*), is situated 28 miles south of Vienna, on the Vienna and Gloggnitz Railway, and is also connected with the capital by a canal. It is surrounded by a broad and deep ditch, and by a fortified wall pierced by four gates. The town is overlooked by the large old castle of the Dukes of Babenberg, now a military academy for the preparatory instruction of officers of the line. It accommodates from 400 to 500 pupils. The castle contains a fine Gothic chapel (date, 1460), rich in painted windows. It is the burial-place of the Emperor Maximilian. On the 14th September 1834, the whole town, with the exception of fourteen houses, was destroyed by a dreadful conflagration, which involved the loss of many lives. The new town has been laid out with great taste and regularity. The canal (40 miles in length) and the railway to Vienna, and the converging roads from Styria and Hungary, are the sources of the prosperity of the town. In N. machinery is extensively constructed; and sugar-refining and manufactures of silk, velvet, and cotton fabrics, fayence, leather, &c., are carried on. Pop. 13,700.

NEUSTADT AN DER HARDT, a small town of Rhenish Bavaria, charmingly situated on the Speyerbach, at the foot of the Hardt Mountains, 12 miles north of Landau. Its church, with several curious monuments of the Counts Palatine, and with some ancient fresco-paintings, was finished in the 14th century. It carries on some manufactures, together with the brewing of beer. Pop. 7600.

NEUSTADT-E-BERSWALDÉ, a town of Prussia, in the province of Brandenburg, in a pleasant district on the Finow Canal, 28 miles north-east of Berlin, on the Berlin and Stettin Railway. It is well known on account of its mineral springs, and carries on extensive manufactures in steel, iron, copper, brass, paper, and porcelain. Pop. 6153.

NEUSTADTL AN DER WAAG, a town near the north-west frontier of Hungary, 33 miles north-north-west of Neutra. Here excellent red wine is grown, and there is a good trade in grain, wool, sheep-skins, and wax. Pop. 6750, nearly half of whom are Jews.

NEU-STRELITZ, the capital and the residence of the court of the grand duchy of Mecklenburg-Strelitz, pleasantly situated in a hilly district, between two lakes, 60 miles north-north-west of Berlin. It was founded in 1733, is built in the form of an eight-rayed star, and contains the ducal palace, with a library of 70,000 vols., and having magnificent gardens attached. Pop. 7390, who are supported chiefly from the expenditure of the court, and by brewing and distilling. A mile south of the town is Alt-Strelitz, with the largest horse-market in the duchy.

NEUSTRIA, or **WEST FRANCE** (*Francia Occidentalis*), the name given in the times of the Merovingians and Carolingians to the western portion of the Frank empire, after the quadruple division of it which took place in 511. N. contained three of these divisions. It extended originally from the mouth of the Scheldt to the Loire, and was

bounded by Aquitania on the S., and by Burgundy and Austrasia (*Francia Orientalis*) on the E. The principal cities were Soissons, Paris, Orleans, and Tours. Bretagne was always loosely attached to Neustria, of which the strength lay in the Duchy of France. After the cession of the territory afterwards called Normandy to the Normans in 912, the name Neustria soon fell into disuse.

NEU-TITSCHHEIN, a small manufacturing town of Moravia, on the Titsch, 80 miles north-east of Brünn. It contains an old castle, and carries on manufactures of cloth and woollen goods, dyeing, and wagon-making. Pop. 8000.

NEUTRAL AXIS, the name given to an imaginary line through any body which is being subjected to a transverse strain; and separating the forces of extension from those of compression. If the ratio of the resistances to extension and compression were the same for all substances, and depended merely on the form of the body, then in all bodies of the same form the neutral axis would have a definite geometrical position; but it has been satisfactorily proved, by Mr Eaton Hodgkinson, that this ratio has a separate value for each substance. In wood, where the ratio is one of equality, the neutral axis in a beam supported at both ends, whose section is rectangular, passes lengthwise through the centre of the beam; while in cast-iron, in which the resistance to compression is greater than that to extension, it is a little above, and in wrought iron, in which the contrary is the case, it is a little below, the centre.

NEUTRAL SALTS. See **SALTS**.

NEUTRALS, nations who, when a war is being carried on, take no part in the contest, and evince no particular friendship for, or hostility to, any of the belligerents. As a general rule, neutrals should conduct themselves with perfect impartiality, and do nothing which can be considered as favouring one belligerent more than another.

The duties and obligations of neutrals at sea have given rise to many complicated questions. It is allowed on all hands that a neutral state forfeits her character of neutrality by furnishing to either belligerent any of the articles that come under the denomination of Contraband of War (q. v.). If she does so, the other belligerent is warranted in intercepting the succours, and confiscating them as lawful prize. Contraband of war, besides warlike stores, has sometimes been held to include various other articles, a supply of which is necessary for the prosecution of the war; and it has been doubted how far, in some circumstances, corn, hay, and coal may not come under that category.

An important question regarding the rights of neutrals is, whether enemies' goods not contraband of war may be lawfully conveyed in neutral bottoms. The principle that free ships make free goods, was long resisted by this and other maritime countries, and the general understanding has been, that belligerents have a right of visiting and searching neutral vessels for the purpose of ascertaining—1st, whether the ship is really neutral, as the hoisting of a neutral flag affords no absolute security that it is so; 2d, whether it has contraband of war or enemies' property on board. Neutral ships have therefore been held bound to provide themselves with passports from their government, and such papers as are necessary to prove the property of the ship and cargo, and it is their duty to heave to when summoned by the cruisers of either belligerent. It has been considered that a neutral ship which seeks to avoid search by crowding sail or by open force, may be captured and confiscated. When a merchant-ship is sailing under convoy of a vessel

of war, it has been said that the declaration of the officer in command of the convoy that there is no contraband of war or belligerent property on board, is sufficient to bar the exercise of the right of search.

A declaration having important bearings on the rights of neutrals, was adopted by the plenipotentiaries of Great Britain, Austria, France, Prussia, Russia, Sardinia, and Turkey, assembled in congress at Paris, on April 16, 1856. By its provisions, 1. Privateering is abolished. 2. A neutral flag covers enemies' goods, with the exception of contraband of war. 3. Neutral goods, with the exception of contraband of war, are not liable to capture under the enemy's flag. 4. Blockades, in order to be binding, must be effective, that is, maintained by a force sufficient really to prevent access to the coast of the enemy.

It has sometimes been proposed to exempt private property at sea from attack during war—such a project, however, seems inexpedient. There may be a propriety in respecting the property of individuals on land, in a time of war, because its destruction, however injurious to the persons immediately concerned, can have little influence on the decision of the contest. But at sea, private property is destroyed because those from whom it is taken, being purveyors or carriers for the community at large, its loss must seriously affect the public, and have no small influence in bringing the contest to an end. See **BLOCKADE, PRIVATEER.**

NEUWIED, a town of Rhenish Prussia, on the right bank of the Rhine, 8 miles below Coblenz. It is the capital of the principality of Wied, now mediatised and attached to Prussia, and is the seat of the princes of Wied, with a beautiful castle. It was founded in the beginning of the 18th c. by Prince Alexander of Wied-Newweid, who, offering perfect toleration in religious matters, as an inducement, invited colonists of whatever persuasion to settle here. The town is well built, with wide, straight streets, running at right angles to each other, and contains the churches of Protestants, Catholics, Jews, Herrnhuters, &c. The inhabitants are well conditioned and industrious. Pop. 7240, who carry on manufactures of hosiery, woollen and cotton fabrics, iron-ware, leather, and tobacco.

NEVA, a river of Russia, in the government of St Petersburg, flows westward from the south-west corner of Lake Ladoga to the Bay of Cronstadt, in the Gulf of Finland. Its length, including windings, is about 40 miles, 9 miles of which are within the limits of the city of St Petersburg; and in some places it is 2100 feet broad, and about 56 feet deep; although at Schlusenburg, where it issues from the lake, and at St Petersburg, where it enters the sea by several branches, it is shallow. From Cronstadt, goods are brought to St Petersburg in lighters or in small steamers. By the Ladoga Canal, the N. communicates with the vast water-system of the Volga, and thus it may be said to join the Baltic with the Caspian Sea. Its current is very rapid, and the volume of its waters is immense. It is covered by drift-ice for upwards of five months—from about the 25th November to the 27th April. An extensive traffic is carried on on its waters, both from the interior and from the Baltic.

NEVADA TERRITORY, in the west of the U.S. of America, is bounded on the W. by California—the boundary-line being the meridian of 116° W.—on the E. by Utah Territory, and on the N. by Oregon, and was organised in 1861. Its area is estimated at 80,000 square miles; and its pop. at 50,568, of whom 23,000 are Indians. The chief river is the

Humboldt, which flows west-south-west, and ends in the marsh called the Sink of the Humboldt. The principal lakes are the Mud Lakes, Pyramid Lakes, and the Walker and Carson Lakes. The country is traversed by mountains, in short ranges, rising to upwards of 6000 feet, and running from north to south. Of the 9 counties already formed, 7 have numerous mines either of gold or silver. The whole country is rich in mineral wealth. Besides gold and silver, quicksilver, lead, and antimony are found. The territorial capital is Carson City (pop. 2500), but the principal town is Virginia City (pop. 3000). In the autumn of 1862, the population was rapidly increasing, and the stocks of the mining companies were rising in value.

NEVERS, a town of France, capital of the department of Nièvre, and formerly the capital of the province of Nivernais, is built on a hill in the midst of fertile plains, at the confluence of the Loire and the Nièvre, 140 miles south-south-east of Paris. Highly picturesque, as seen from a distance, its interior shews steep, winding, and badly paved streets. It contains a beautiful cathedral of the 10th c., and a fine public garden; the large cavalry barrack, the fine bridge of 20 arches over the Loire, and the triumphal arch, erected in 1746, to commemorate the battle of Fontenoy, are also worthy of mention. N. is the see of a bishop, contains a public library, and has numerous educational, scientific, and benevolent institutions, and an arsenal. There is here an important cannon-foundry, and the principal manufactures are porcelain and earthenware, glass, brandy, iron cables and chains, and anvils. Pop. 16,082.

N., the *Noviodunum* of the Romans, existed prior to the invasion of Gaul by Julius Cæsar. It has been the seat of a bishop since the beginning of the 6th c., when it was called Nevirnum, became a county in the 10th c., and was erected into a duchy by Francis I. in 1538.

NEVILLE'S CROSS. See **BRUCE, DAVID.**

NEVIS, a small island of the West Indies, belonging to Great Britain, forms one of the group of the Lesser Antilles, and lies immediately south-east of St Christopher's, from which it is separated by a strait called the *Narrows*, two miles wide. It is circular in form, rises in a central peak to the height of about 2500 feet, and has an area of 20 square miles. Pop. (1861) 9822, of whom only 260 were white. Charlestown, a seaport, with a tolerable roadstead, situated on the south-west shore of the island, is the seat of government, consisting of a government council and general assembly. The soil is fertile, and the principal products are sugar, molasses, and rum. In 1860, sugar to the value of £36,123 was produced; molasses, £2790; and rum, £1740, the produce in the last article being for that year unusually small. In 1860, 433 vessels of 26,259 tons entered and-cleared, and the value of the imports was £35,255, and of the exports, £40,666; the revenue, £5596; the expenditure, £5129. In 1860, there were 13 schools on the island, attended by 2108 scholars.

NEW ALBANY, a town in Indiana, U. S., on the north bank of the Ohio River, at the foot of the falls, opposite Portland, and two miles below Louisville, Kentucky; a finely situated, well-built town, having 22 miles of streets, 5 ship-yards, 8 foundries, 22 churches, and is the site of Asbury College and a collegiate institute. It has a large river-trade and railway connections with Indiana and Kentucky. Pop. (1860) 12,647.

NEW BEDFORD, a seaport city of Massachusetts, U. S., on Buzzard's Bay, 56 miles south of Boston. Since 1755, it has been the chief centre of

NEW BRITAIN—NEW BRUNSWICK.

the American whale-fisheries, and is the richest town, in proportion to its population, in America. Of 547 vessels belonging to the port, 399 are whalers, which, in 1859, brought home 2,236,438 gallons of sperm-oil, 4,715,583 gallons of whale-oil, and 2,010,882 lbs. of whalebone. It has 13 oil and candle factories, 4 soap factories, several large cotton-mills, hoop-iron manufactories, barrel factories, 24 churches, 4 banks, 2 daily and 3 weekly newspapers, a public library of 13,000 volumes, city-hall, custom-house, alms-house, &c., with extensive railway and steam-boat connections. Pop. (1860) 22,300.

NEW BRITAIN, a manufacturing village in Connecticut, U. S., 10 miles south of Hartford, engaged in the production of stockinet goods, locks, jewellery, hooks and eyes, and various kinds of hardware. It has six churches. The water supply is from a reservoir of 175 acres, with a head of 200 feet, supplying public fountains with jets of 140 feet, and dispensing with fire-engines. Pop. (1860) 5212.

NEW BRITAIN, the name of one principal, and of several subsidiary islands in the Pacific Ocean, in lat. between 4°—6° 30' S., and long. between 148°—152° 30' E. The principal island, 300 miles in length, and having an area of 12,000 square miles, lies east of New Guinea, from which it is separated by Dampier's Straits. The surface is mountainous in the interior, with active volcanoes in the north, but along the coast are fertile plains. Forests abound in the island, and palms, sugar-cane, breadfruit, &c., are produced. The inhabitants, the number of whom is unknown, are described as a tribe of 'oriental negroes,' and are well formed, active, and of a very dark complexion. They are further advanced in civilisation than is usual among the Polynesians, have a formal religious worship, temples, and images of their deities. N. B. was first seen by Le Maire and Schouten in 1616, but Dampier, at a later date, was the first to land.

NEW BRUNSWICK, a city of New Jersey, U. S., is on the south bank of the Raritan River, at the head of navigation, 15 miles from its mouth, 30 miles south-west of New York, on the New Jersey Railway, and the Delaware and Raritan Canal. It has extensive manufactures of cotton, leather, india-rubber, paper-hangings, iron, and machinery, 16 churches, 2 banks, 2 daily and 3 weekly newspapers. It is the seat of Rutgers' College and Theological Seminary. Pop. (1860) 11,255.

NEW BRUNSWICK, a British colony, on the north-east coast of North America, is bounded on the N.W. by Canada and the Bay of Chaleur, on the N.E. by the Gulf of St Lawrence and the Strait of Northumberland, on the S. by Nova Scotia and the Bay of Fundy, and on the S.W. by the state of Maine. It has an area of 32,000 square miles, or 17,600,000 acres (rather more than the area of Scotland), and a population, in 1861, of 252,047. The coast-line is 500 miles in extent, and is indented by spacious bays, inlets, and harbours, which afford safe and commodious anchorage for shipping. The chief are Fundy, Chignecto, and Cumberland Bays, the two last being merely extensions of the first; Passamaquoddy Bay in the south; Verte, Shediac, Cocaigne, Richibucto, and Miramichi Bays on the north-east, and the Bay of Chaleur, 80 miles long by 27 broad, in the north-west. The province of N. B. abounds in rivers. The principal are the St John's and the St Croix, the former 450, and the latter 100 miles in length, and both falling into the Bay of Fundy; and of the rivers that flow eastward into the Gulf of St Lawrence, the Richibucto, the Miramichi, and

the Restigouche. The province contains numerous lakes, one of which, Grand Lake, is 100 square miles in area. Most of the others are much smaller. The surface is for the most part flat or undulating. With the exception of the district in the north-west bordering on Canada and the river Restigouche, no portion of N. B. is marked by any considerable elevation. Here, however, the country is beautifully diversified by hills of from 500 to 800 feet in height. These elevations, which form an extension of the Appalachian range, are interspersed with fertile valleys and table-lands, and are clothed almost to their summits with lofty forest-trees. In this district the scenery is remarkably beautiful. In the south of the colony the surface is broken up by great ravines, and the coast is bold and rocky. The shores on the east coast, and for twenty miles inland, are flat. The soil is deep and fertile. Of the whole acreage, 14,000,000 acres are set down as good land, and 3,600,000 acres as poor land. In 1851, 643,954, and in 1861, 835,108 acres were under cultivation. Timber is as yet the principal vegetable product, but wheat, oats, buckwheat, barley, rye, potatoes, and hay are raised. 206,635 bushels of wheat were raised in 1851, and 279,775 bushels in 1861. In 1851, 1,411,164 bushels of oats were raised, and in 1861, 2,656,883 bushels, or 104 bushels for every inhabitant. N. B. contains a rich and extensive wheat-producing district; but the inhabitants, dividing their time between farming, lumbering, fishing, ship-building, and other pursuits, and following no regular system of tillage, have not much advanced the agricultural condition of the country for several years. The climate is remarkably healthy, and the autumn—and especially the season called the Indian summer—is particularly agreeable, and the severity of the winter has been already much mitigated by the clearing of the forests. In the interior, the heat in summer rises to 80°, and sometimes to 95°; and in winter, which lasts from the middle of December to the middle of March, the mercury sometimes falls as low as 40° below zero. At Fredericton, the capital, situated on St John's River, 65 miles from the south, and 130 miles from the north coast, the temperature ranges from 35° below to 95° above zero, and the mean is about 42°.

The northern districts of the province, from the Bay of Chaleur to the St John, are occupied by metamorphic slates. In the south, the carboniferous and new red sandstone systems (including deposits of red marl and gypsum, and extensive beds of coal) prevail. One-third of the surface of N. B. is covered by a bed of coal. Many of the coal-measures, however, are thin and impure; but the coal of Albert county is the most valuable deposit of bituminous matter on the American continent, and is apparently inexhaustible. It yields 100 gallons of crude oil per ton. From this deposit, £46,875 worth of coal was exported in 1859, and the stockholders were drawing 110 per cent. profit. Throughout the province, 2842 tons of coal were raised in 1851, and 18,244 tons in 1861; but mining has not yet become an important branch of industry. Gold and silver occur in N. B.; copper and iron ore of excellent quality abound; gypsum, plumbago, and limestone are very abundant, and the freestone of the province, unsurpassed for beauty and durability, commands a high price in the States. In 1861, 42,965 casks of lime, 42,476 grindstones, 14,080 tons of building stone, and 14,000 tons of gypsum were brought into the market. Wild animals abound in the province; the lakes and rivers are well-stocked with fish, and along the coasts cod, haddock, salmon, and other fish are caught in great plenty. In 1861, the total value of fish caught was £108,000, exclusive of the value of the fish consumed by the inhabitants. In

1860, 6707 vessels of 1,297,374 tons entered and cleared. The exports consisted of timber (in deals, boards, pine timber, &c., to the value of £621,455), fish, oil, and building and grindstones, amounting in all to £916,372. The imports consisted of manufactured fabrics, grain, hardware, tea, preserved meats, spirits, molasses, and sugar, and amounted to £1,448,740. In 1861, there were in the colony 92,025 cattle, 69,642 milch cows, 35,830 horses, 214,096 sheep, and 74,057 pigs. In 1861, there were 866 collegiate, grammar, and other schools, attended by nearly 29,000 pupils. In the same year the revenue amounted to £178,664, and the expenditure to £174,419. There were two lines of railway in operation in 1861—the line from St John's (at the mouth of the river of the same name) to Shediac, and that from St Andrew's to Woodstock. The length of both railway-lines is 190 miles, and there are also in the colony 450 miles of telegraph. Around the coasts and along the bank of the rivers there are excellent public and coach roads. Of the entire population, 85,238 are Catholics, 42,776 Episcopalians, 36,631 Presbyterians, and 57,730 Baptists. Chief towns, the city of St John (pop. 27,317), and Fredericton, the political capital (pop. 5652).

The province of N. B., together with that of Nova Scotia, originally formed one French colony, called Acadia, or New France. It was ceded to the English in 1713, and was first settled by British colonists in 1764. Twenty years subsequently, in 1784, it was separated from Nova Scotia, and erected into an independent colony.

NEW CALEDONIA, an island of the South Pacific Ocean, belonging to France, and lying about 720 miles east-north-east of the coast of Queensland, in Australia, in lat. 20°–22° 30' S., long. 164°–167° E. It is about 200 miles in length, 30 miles in breadth, and has a population estimated at 60,000. It is of volcanic origin, is traversed in the direction of its length, from north-west to south-east, by a range of mountains, which in some cases reach the height of about 8000 feet, and is surrounded by sand-banks and coral-reefs. There are secure harbours at Port Balade and Port St Vincent, the former on the north-east, the latter on the south-west part of the island. In the valleys the soil is fruitful, producing the cocoa-nut, banana, mango, breadfruit, &c. The sugar-cane is cultivated, and the vine grows wild. The coasts support considerable tracts of forest, but the mountains are barren. The inhabitants, who resemble the Papuan race, consist of different tribes, some of which are cannibals. N. C. was discovered by Captain Cook in 1774. In 1854 the French took official possession of it, and it is now comprised under the same government with Otaheite and the Marquesas Isles. Missionaries have been established on the island, and many of the natives are said to have embraced Christianity.

NEW COLLEGE, OXFORD. The College of St Mary of Winchester, in Oxford, commonly called New College, was founded by William of Wykeham, Bishop of Winchester and Lord High Chancellor in 1366. The buildings are magnificent, and the gardens of great beauty. The most remarkable peculiarity of New College is its connection with Winchester School, another noble foundation of Wykeham. After the kin of the founder (to whom a preference was always given), the fellows were to be taken from Winchester. The late practice was that 'two founders,' as they were called, were put at the head of the roll for Winchester, and two others at the head of the roll for New College. In 1851, the college consisted of a warden and 70 fellows (elected in this way

from Winchester), 10 chaplains, 3 clerks, and 16 choristers. By the ordinances under 17 and 18 Vict. c. 81, considerable changes were introduced, but the connection of the college with Winchester was in great measure preserved. The number of fellows was fixed at 30. Of these, 15 are open only to those who have been educated at Winchester, or who have been for 12 terms members of New College. The other 15 are open without restriction. The value of the fellowships is not to be more than £200 per annum, so long as their number is less than 40. There are also to be 30 scholarships, tenable for five years, of value not less than £80 per annum, inclusive of rooms, to be appointed by the warden and fellows of New College, by the election of boys receiving education at Winchester School. No conditions of birth are to be regarded in the election either of fellows or scholars. By a subsequent statute, the chaplains are made 3 in number, and from 8 to 10 choral scholars are added, to be upon an equality with the other scholars. This college presents to 37 benefices, and elects the warden of Winchester College.

NEW ENGLAND, a collective name given to the six eastern states of the United States of America—Maine, New Hampshire, Vermont, Massachusetts, Rhode Island, and Connecticut—including an area of 65,000 square miles. The people, distinctively known as Yankees, and mostly descended from an English Puritan and Scottish ancestry, are engaged in commerce, fisheries, and manufactures, and are celebrated for industry and enterprise. This region was granted by James I. to the Plymouth Company in 1606, under the title of North Virginia, and the coast was explored by Captain John Smith in 1614. See accounts of the several States.

NEW FOREST, the name of a district in Hampshire (q. v.), triangular in shape, and bounded on the W. by the river Avon, on the S. by the coast, and on the N.-E. by a line running from the borders of Wiltshire along the Southampton Water. Area about 64,000 acres. This triangle appears to have been a great wooded district from the earliest times, and its present name dates from the Norman Conquest, when it was regularly afforested. Since that period it has remained a possession of the crown, subject to rights of 'pannage,' vert (green-wood) and turf-cutting, claimed by various estates in or near the Forest. During the 'pannage' month, which commences at the end of September, and lasts for six weeks, the borderers drive in herds of swine to feed on the mast in the Forest, and this right they obtain by paying a small annual fee in the Stewards Court at Lyndhurst, which is considered the capital of the Forest. Formerly, this district was the haunt of numerous 'squatters,' but their huts are now rarely to be seen. Gipsies, however, still congregate here in considerable numbers. In 1854, a commission was appointed to examine the extent and nature of the rights of pannage, &c., claimed by the foresters and borderers, and in a large majority of cases the claims were confirmed. The principal trees in the forest are the oak and beech, with large patches of holly as underwood. The oaks have been much used as timber for the British navy. Tracts of exquisite woodland scenery are everywhere to be met with. The afforestation of this district by the Conqueror, enforced by savagely severe Forest laws, was regarded as an act of the greatest cruelty, and the violent deaths met by both of his sons, Richard and William Rufus—both of whom were killed by accidental arrow-wounds in the Forest—were looked upon as special judgments of Providence. A small breed of pony lives wild under its shelter.

NEW GRANADA—NEW HAMPSHIRE.

NEW GRANADA (since 1858 the official designation has been *The Granadian Confederation*, and since 1862, *The United States of Colombia*), a republic in the north-west of South America, bounded on the N. by the Caribbean Sea; on the W. by Costa Rica, a republic of Central America, and by the Pacific; on the S. by Ecuador and Brazil; and on the E. by Venezuela. By the constitution of June 15, 1858—a constitution framed after the model of that of the United States of America—N. G. was divided into the following 8 'States': Panama, Bolivar, Cauca, Antioquia, Cundinamarca, Boyaca, Santander, and Magdalena. Entire area, 333,000 square miles; pop. about 2,263,000, of whom more than one-half are whites. The country is intersected by three great ranges of the Andes, which spread out like the rays of an open hand from the plateau of Pasto and Tuquerrez in the south (14,000 feet high), and are known as the Western, Central, and Eastern Cordillera. Between these chains lie the long and beautiful valleys of the Cauca and the Magdalena. The Central Cordillera is the highest chain, rising in Nevada de Tolima to a height of 18,020 feet, and from one of its peaks, near the frontiers of Ecuador, called Paramo de las Papas, descend the two principal rivers of N. G., the Magdalena and its tributary the Cauca, flowing north into the Caribbean Sea, besides several affluents of the Amazon in the east, and one or two streams flowing westward into the Pacific. The Eastern Cordillera is by far the largest chain, and consists of a series of vast table-lands, cool and healthy, where the white race flourishes as vigorously as in Europe. This temperate region is the most densely peopled portion of the Confederation, being, in some places, at the rate of 2600 to the square league. Bogota (q. v.) the present capital, is situated on one of these plateaux, at an elevation of 8694 feet. Eastward from this Cordillera stretch enormous plains as far as the Orinoco, the greater part of which belongs to N. G., and through which flow the Meta, the Guaviare, and other tributaries of the Orinoco. The geology of the country is very extraordinary. 'Everywhere,' we are told, 'are found traces of stupendous cataclysms, and a disarrangement and intermixture of primitive and sedimentary rocks, which seem to put all classification at defiance.' In the course of one day's journey, the traveller may experience in this country all the climates of the world. Perpetual snow covers the summits of the Cordilleras; while the rich vegetation of the tropics covers the valleys. With its great variety of levels and climates, N. G. yields naturally an equally great variety of productions: cattle, horses, wheat, and other European grains, maize, tobacco, coffee, plantains, cotton, cacao, sugar, cedar, mahogany, cinchona bark, ipecacuanha, gold, silver, copper, iron, and lead, coal, emeralds, pearls, and rock-salt. In 1858, according to official statements, the trade of the five ports, Panama, Santa Marta, Riochacha, Cartagena, and Savanilla, stood as follows:

	ARRIVED.		CLEARED.	
	Ships.	Tons.	Ships.	Tons.
British, . . .	170	138,609	172	139,393
Total, . . .	489	232,588	533	240,363

The total annual value of the exports of N. G. amounted in the same year to about 14,000,000 dollars.

By the constitution, complete toleration in matters of religion and worship, the freedom of the press, a system of parish-schools, with gratuitous primary education, and many other important helps to civilisation and liberty have been established. The inhabitants rank first among the South Americans

in point of literary and scientific culture. There are at present about 800 public schools in the country, 60 seminaries and colleges for higher and professional instruction, 47 printing establishments, 40 periodicals, and numerous literary, scientific, and benevolent institutions.

The chief aborigines of the country, called *Chibchas* or *Muyecas*, held a high rank among the semi-civilised nations of the New World. They are said to have been frugal and industrious, with a well-organised government and a very passable religion—for heathens. They were conquered by Ximenes de Quesado (1536—1537), and their descendants are now 'Christians,' and speak the Spanish language. Several of the other tribes still maintain a savage mode of life; and some, as the *Mesayos*, are even said to be cannibals. In 1718, N. G. was erected into a vice-royalty by Spain. In 1819, it became independent, and then joined with Ecuador and Venezuela to form the republic of Colombia; but the union was dissolved in 1829—1830, and N. G. was organised as a separate republic in 1832. After several changes in the constitution (in 1843, 1851, 1853), a complete fundamental change was made in 1858, by which the separate 'provinces' were changed into 'states,' associated under a federal government like the 'United States' of North America, but self-governing in all internal affairs. In 1860, another revolution broke out, and for more than two years, the country was devastated by civil war. Finally, on the 29th September 1862, a convention was concluded between the Conservatives, or Federalists, and the 'Liberals,' which put an end to the strife. As the victory lay with the latter, certain changes have again been made in the constitution, and the country is now officially designated the 'United States of Colombia.' The first election of a president under the new form of the constitution was decreed to take place April 1, 1864.

NEW GUI'NEA. See PAPUA.

NEW HAMPSHIRE, one of the original thirteen United States of America, in lat. 42° 41'—45° 11' N., long. 70° 40'—72° 28' W., is 176 miles long, and on an average 45 miles wide, having an area of 9280 square miles, or 5,939,200 acres. It is bounded N. by Canada, E. by Maine and the Atlantic Ocean, S. by Massachusetts, and W. by Vermont, from which it is separated by the Connecticut River. It has ten counties; the chief towns are Manchester, Portsmouth, Dover, Nashua, Keene, and Concord, the capital. The population, except the recent influx of Irish in the manufacturing towns, is almost entirely descended from the original English and Scottish settlers. It has 18 miles of sea-coast, and one seaport, Portsmouth, at the mouth of the Piscataqua River, with a deep and commodious harbour. Its other chief rivers are the Connecticut and the Merrimack. It is a state of mountains and lakes, much visited by tourists, and called 'The Granite State' and 'The Switzerland of America.' The White Mountains lie in the north central region. Their highest summits are Mount Washington, 6285 feet; and Mount Lafayette, 5500 feet. A notch in the White Mountains, 2 miles long, and in the narrowest part only 22 feet wide, affords passage to a road and mountain stream, and is much visited. The lakes and rivers of N. H. occupy in all about 110,000 acres. Lake Winnepiseogee is 25 miles long by 1 to 10 miles wide, with 360 islands, from a few yards to many acres in area, mostly covered with evergreens. The rocky strata consist of metamorphic rocks, mica and talcose slates, quartz, granular limestones, granite, gneiss, and contain magnetic and specular iron ores, beryls, tourmalins, mica, graphite, and steatite or

NEW HARMONY—NEW JERSEY.

soap-stone. The soil, except in the fertile valleys, is better adapted to pasturage than culture. The winters are long and cold, so that in the mountainous regions mercury sometimes freezes. In the forests are oak, maple, pine, hemlock, spruce, &c. The chief agricultural products are maize, rye, oats, apples, potatoes, and products of the dairy. Numerous waterfalls give motive-power to 44 cotton factories, 61 woollen, 29 iron, and many paper-mills, &c. The state has 621 miles of railway, 51 banks, 1 college (Dartmouth), 700 churches, 38 newspapers, an excellent system of free schools, and government and judiciary similar to all the American states. N. H. was settled in 1623 by colonists from Hampshire in England, who suffered during the colonial period from Indian wars and depredations. The state was organised in 1776. It has furnished a multitude of emigrants to the newer and more fertile western states. Pop. in 1810, 214,360; in 1840, 284,574; in 1860, 326,072.

NEW HARMONY, a township of Indiana, first settled in 1815 by a German community of religious socialists, called Harmonists, under the leadership of George Rapp. In 1824, the village and domain was purchased by Robert Owen, for an experimental community on his system. After the speedy failure of this society, the property was bought by William Maclure for a School of Industry. It is now a flourishing western village, of about 700 inhabitants.

NEW HAVEN, the chief city, seaport, and semi-capital of Connecticut, U. S., at the head of a bay, 4 miles from Long Island Sound, 76 miles east-north-east of New York. Its broad streets are shaded with elms, and the public squares, parks, and gardens, with its handsome public and private edifices, make it one of the most beautiful of American cities. It is the seat of Yale College (q. v.), which has 8 large buildings and a Gothic library, 150 feet long. There are a handsome custom-house, state-house, hospital, 32 churches, academies and schools, 8 banks, 4 daily papers, and 3 ornamental cemeteries. There are large manufactories of carriages, clocks, and leather, iron and india-rubber works. A railway and steam-boats connect it with New York and the New England towns. It was settled from London in 1638. Pop. (1860) 39,268.

NEW HEBRIDES, a group of islands situated in the Pacific Ocean, to the north-east of New Caledonia, and to the west of the Fijis, extending in S. lat. between 14° and 20°, and in E. long. between 167° and 170°. Total area estimated at 2500 square miles. They are regarded as the most easterly point of the western division of Polynesia. The group embraces Espiritu Santo (65 miles long by 20 broad), Mallicollo (60 miles long by 28 broad), Vati Ambrym, Annatom, Erromango, Tanna, with an active volcano, and Aurora. Most of the group are hilly and well-wooded, some even mountainous. The most important woods are ebony and sandal; the principal edible products, yams, bananas, cucumbers, cocoa-nuts, and sweet potatoes; and the only animal of consequence, a diminutive species of hog, which, when full-grown, is no bigger than a rabbit. The inhabitants, who number about 200,000, are fierce, but excessively dirty and unintelligent. Erromango is a well-known name in missionary history, being the scene of the barbarous massacre of the Rev. John Williams—generally called the Martyr of Erromango.

NEW HOLLAND, the former name for Australia (q. v.).

NEW INN HALL, OXFORD. This Hall, with certain gardens adjoining, was presented to the warden and fellows of New College, by William of

Wykeham in 1392. The first principal on record occurs in 1438. During the Civil War it was used as a mint for Charles I. It was restored to the purposes of instruction by Dr Cramer, the late principal, who erected a handsome building for the use of the students.

NEW IRELAND, a long narrow island in the Pacific Ocean, lying to the north-east of New Britain (q. v.), from which it is separated by St George's Channel; lat. 2° 40'—4° 52' S., long. 150° 30'—152° 50' E. Length about 200 miles; average breadth, 12 miles. The hills rise to a height of from 1500 to 2000 feet, and are richly wooded. The principal trees are cocoas on the coast, and in the interior forests of areca-palm. The chief products are sugar-cane, bananas, yams, cocoa-nuts. Dogs, pigs, and turtles abound. The natives are apparently of the same race as the inhabitants of Australia; but our information about them is extremely scanty.

NEW JERSEY, one of the original thirteen U. S., in lat. 38° 55'—41° 21' N., and long. 73° 58'—75° 29' W., 167 miles long, with an irregular shape, and an extreme breadth of 96 miles, containing an area of 8320 square miles, or 5,324,800 acres; bounded N. by New York, E. by the Hudson River and the Atlantic Ocean, S. by the ocean and Delaware Bay, and W. by Delaware Bay and River, which separate it from Delaware and Pennsylvania. It has 21 counties. The chief towns are Trenton, the capital, Newark, Patterson, Jersey City, New Brunswick. Its coast-line is 120 miles, or, including bays, 540 miles. Besides its bordering rivers, the Hudson and Delaware, its principal streams are the Passaic, Hackensack, and Raritan. The northern portion of the state is hilly and mountainous. The Palisades, a wall of perpendicular trap-rocks, from 200 to 500 feet high, form the western bank of the Hudson River for fifteen miles, and one of the grandest features of its scenery. The central portion of the state is a rolling country, and the southern and eastern portion a sandy plain declining to the sea. Five geological belts cross the state, containing a sandy pine plain with bog iron ore, shelly marls used for manure, glass sand, green-sand or marl, plastic clay, used in making firebricks, metamorphic rocks, argillaceous red sandstone, copper ores, gneiss with specular and magnetic iron ores, red oxide of zinc, and Franklinitic iron. Among the most attractive features in the scenery are the Falls of the Passaic, the Delaware Water Gap, and Schooley's Mountain. Atlantic City, a bathing-place on the sea-coast, connected by railway with Philadelphia, is a fashionable summer resort. The climate is mild, the soil north of the pine plains fertile, the country healthy, except the malarious river-bottoms. The state has 24,000 farms, producing wheat, maize, oats, common and sweet potatoes, apples, peaches, plums, grapes, melons, and garden vegetables for the great neighbouring markets of New York and Philadelphia. There are 21 cotton-factories, 41 woollen, 119 iron-works, with extensive manufactories of machinery, locomotives, carriages, glass, boots and shoes, &c. The state draws a large revenue from 611 miles of railway, and several important canals, connecting New York and the coal regions of Pennsylvania. There are 4 colleges, normal and free schools, 814 churches, 51 periodicals, including 6 daily papers. The government is similar to those of all the states.

N. J. was settled in 1620 by Dutch and Swedes. Taken by the English, it was ceded by Charles II. to the Duke of York; it was retaken by the Dutch in 1673, and afterwards bought by William Penn and other Friends, who have here numerous descendants. It was the scene of some of the most

important military movements of the War of Independence, and of the battles of Trenton, Princeton, Monmouth, and Germantown. Pop. in 1820, 277,575; in 1840, 373,306; in 1860, 672,031.

NEW JOHORE, formerly Tanjong Putri, a Malay settlement on the southern extremity of the Malay peninsula. Here the rajah or Tumpongong of Johore, who is an independent sovereign, occasionally resides. The climate is healthy; large quantities of gambir and pepper are raised in the vicinity; saw-mills on an extensive scale are in operation. Vessels of the largest draught can approach close to the shore. The valuable timbers of these immense forests are yet scarcely known, but must find their way to the Indian, if not European markets, ere long. Population in the N. J. territory about 20,000, chiefly Chinese.

NEW LONDON, a city and port of entry, in Connecticut, U. S. of America, on the right bank of the river Thames, 3 miles from Long Island Sound, 50 miles east of New Haven. It is a rich and handsome town, with a custom-house, 10 churches, academy, 17 public schools, 2 daily and 4 weekly papers, 4 banks, several iron-foundries and steam saw-mills, a machine-manufacturing company, a deep secure harbour, protected by a fort of 80 guns, with 37,490 tons of shipping, much of it engaged in the whale fisheries, and railway and steam-boat communications. Pop. (1860) 10,115. It was settled in 1644, and in 1781 burned by General Arnold.

NEW MALTON. See MALTON.

NEW MEXICO, a territory belonging to the U. S., formerly a state of Mexico, in lat. 31° 10'—38° N., long. 103°—117° 9' W., 700 miles from east to west, and 350 to 400 from north to south, with an area of 243,063 square miles; bounded N. by the territories of Nevada, Utah, and Colorado; E. by the Indian territory and Texas; S. by Texas and Mexico; and W. by California. Its chief towns are Santa Fé, Taos, Socorro, and Mesilla. Its chief rivers are the Rio Grande, which crosses the territory from north to south; the Pecos, a branch of the Rio Grande; the Colorado, on the California boundary; the Gila, which rises in the Rocky Mountains, and flows westwards into the Colorado. These rivers and their branches water broad and fertile valleys, and supply the lack of rain by irrigation. Two great chains of the Rocky Mountains or Cordilleras pass through the eastern portion of the territory from north to south, and lesser mountain-ranges diversify the west, rising to elevations of 12,000 feet. The climate is cold in the elevated regions, hot in the plains, but everywhere dry and healthy. Heavy rains fall in July and August, but the rest of the year is dry. The productions are wheat, maize, fruits, and tobacco, with abundant pasturage. There are numerous mines of gold, silver, copper, iron, and salt. Merchandise is transported from St Louis and Texas in wagon or mule trains. The Indian population consists of 34,000 of the wild and predatory tribes of Navajoes, Apaches, Utahs, Comanches, &c., who possess large herds of horses, and make perpetual war upon the neighbouring settlements, and 10,000 semi-civilised or village tribes, who live by agriculture or the mines. This territory was explored by the Spaniards in 1537, who opened mines, established missions, and made some progress in civilising the natives. In 1846, Santa Fé, the capital, was taken by an American expedition under General Kearney. At the close of the war in 1848, N. M. was ceded to the United States, and erected into a territory in 1850. White pop. in 1860, 93,541.

NEW ORLEANS, a city and port of entry of Louisiana, U. S., on the left bank of the Mississippi

River, 100 miles from its mouth, lat. 29° 58' N., long. 90° W. The city is built on the alluvial banks of the river, on ground lower than the high-water level, protected from inundations by the levees or embankments, which extend for hundreds of miles on both banks of the river. The streets descend from the river bank to the swamps, and the drainage is by canals which open into Lake Pontchartrain, which is on a level with the Gulf of Mexico. The city is long and narrow, extending about six miles along the river, on an inner and outer curve, giving it the shape of the letter S. The older portion, extending around the outer curve, gave it the name of 'the Crescent City.' N. O. is the great port of transhipment for a large portion of the cotton crop of the southern American States, the sugar crop of Louisiana, and the produce of the vast region drained by the Mississippi and its tributaries. It commands 20,000 miles of steam-boat navigation, and is the natural entrepôt of one of the richest regions of the world. In 1860, its exports were 108,293,567 dollars; imports, 22,920,849 dollars. The receipts of cotton were 109,000,000 dollars; of all produce, 185,000,000 dollars, giving employment to more than 2000 ships and steamers. The custom-house is one of the largest buildings in America. The hotels, theatres, and public buildings are on a magnificent scale. There are a branch mint, several large hospitals, 6 orphan asylums, 2 medical colleges, the Jesuits college, Roman Catholic cathedral, 60 churches, 10 daily newspapers, extensive cotton-presses, cotton and sugar warehouses, 11 banks, and all the facilities for a vast commerce. Besides the great river, N. O. has railways connecting it with the north, east, and west. It is a beautiful, and, but for the very frequent visits of the yellow fever, a healthy city. This epidemic is chiefly fatal to unacclimatised strangers, of whom it has sometimes carried off more than 8000 victims. The soil is full of water, so that no excavations can be made. The largest buildings have no cellars below the surface; and in the cemeteries there are no graves, but the dead are placed in tombs, or 'ovens,' above ground. N. O. was settled by the French in 1718; with Louisiana, it was transferred to Spain in 1763; soon after retransferred to France, and sold, with a vast territory drained by the Mississippi and Missouri, by Napoleon I. to the United States in 1803. In 1815 it was successfully defended against a British army, under General Packenham, by General, afterwards President Jackson. In 1860, Louisiana having seceded from the Union, N. O. became an important centre of commercial and military operations, and was closely blockaded by a Federal fleet. An expedition of gun-boats, under Commander Faragut, forced the defences near the mouth of the river, April 24, 1862; the city was compelled to surrender, and occupied by General Butler as military governor. In 1803, on its cession to the Union, the population was about 8000, mostly French and Spanish; in 1820, it had increased to 27,000; in 1860, to 168,823, and consisted of Americans, French creoles, Irish, Germans, and 13,380 slaves.

NEW RED SANDSTONE. A large series of reddish coloured loams, shales, and sandstones, occurring between the Carboniferous Rocks and the Lias, were grouped together under this name, in contradistinction to the Old Red Sandstone group, which lies below the Coal-measures, and has a similar mineral structure. Conybeare and Buckland proposed the title Poikilitic (Gr. variegated) for the same strata, because some of the most characteristic beds are variegated with spots and streaks of light-blue, green, and buff, on a red base. In the progress of geology, however, it was found that two very distinct periods were included under

these names; and the contained fossils of each group were found to be so remarkably different, that the one period was referred to the Palæozoic series under the name Permian (q. v.), while the other, known as the Trias (q. v.), was determined to belong to the Secondary series.

NEW ROSS, a seaport and parliamentary borough of Ireland, situated on the estuary of the Barrow, partly in the county of Kilkenny, but chiefly in that of Wexford, distant 84 miles south-south-west from Dublin. Pop. in 1861, 7115, of whom 6491 are Catholics, 539 Protestants of the Established Church, and the rest Protestants of other denominations. N. R. is an ancient town, having been surrounded by walls about the middle of the 13th century. Before the union, it returned two members to parliament, of whom one was withdrawn by the Act of Union. It is now a place of considerable commerce, and the modern part of the town on the Wexford side is built with considerable regularity and taste. On the Kilkenny side is a straggling suburb called Rosbercon, connected with N. R. by a wooden bridge and causeway, remarkable for its length, which is nearly 700 feet. The port is approachable at spring-tides by ships of 800 tons, and at all times by vessels of 200 tons; and there is a communication by river and canal with Dublin, and also with Limerick. The town is managed by a board of twenty-one commissioners. It possesses no manufactures of any importance.

NEW RUSSIA. See **RUSSIA**.

NEW SHO'REHAM See **SHOREHAM**.

NEW SIBERIA, a group of islands in the Arctic Ocean, lying north-north-east of the mouth of the River Lena, in Eastern Siberia. Lat. 73° 20'—76° 12' N., long. 135° 20'—150° 20' E.; area, 20,480 square miles. The principal are Kotelnoi (the largest), Liakov, Fadievskoi, and New Siberia. The coasts are in general rocky, and are covered all the year round with snow. The islands are very important, on account of the immense multitude of bones and teeth of mammoths, rhinoceroses, buffaloes, &c., which are found in the soil. They are now uninhabited, but there are traces of former inhabitants. Neither bush nor tree is to be seen anywhere.

NEW SOUTH WALES, a British colony in the south-east of Australia. It originally comprised all the Australian settlements east of the 135th meridian, but the formation, successively, of the separate colonies of South Australia (1836), Victoria (1851), and Queensland (1859), has reduced it to more moderate dimensions. It is now bounded on the N. by a line which, beginning at Point Danger, in lat. 28° 8' S., follows several lines of heights across the Dividing Range till it meets the 29th parallel, which forms the rest of the boundary westward; on the W. by the 141st meridian; on the E. by the Pacific Ocean; and the line separating it from Victoria on the S. runs from Cape Howe, at the south-east of the island, north-west to the source of the Murray (q. v.), and then along that stream, in a direction west by north, to the western boundary of the two colonies. Area, 478,861 square miles, or more than five times that of the island of Great Britain; pop. (1861) 350,860, of whom 193,488 were males, and 152,372 were females. The more general physical character of the country is described under the head of **AUSTRALIA**. Within the colony of N. S. W. the mountain-range, which girdles nearly the whole island, is most continuous and elevated, and is known as the Dividing Range. The section of this mountain system on the southern boundary of the colony, called the Australian Alps, rises in Mount

Kosciusko to 6500 feet. From this the range extends northward, the water-shed being from 50 to 150 miles distant from the east coast, and thus divides the colony into two slopes, with two distinct water-systems. The rivers on the eastern side descend with great rapidity, and in oblique tortuous courses, their channels often forming deep ravines. Many of them are navigable in their lower course for sea-going steamers. The principal are the Richmond, Clarence, M'Leay, Manning, Hunter, Hawkesbury, and Shoalhaven. The Hunter River, about 60 miles north of Sydney, opens up one of the most fertile and delightful districts in the country. The Dividing Range, which, opposite to Sydney, is called the Blue Mountains, being singularly abrupt and rugged, and full of frightful chasms, long presented an impenetrable barrier to the west, and kept the colonists shut in between it and the sea, and utterly ignorant of what lay beyond. At last, in 1813, when the cattle were likely to perish in one of those long droughts that appear to visit this country at intervals of a dozen years, three adventurous individuals scaled the formidable barrier, and discovered those downs on the western slope which now form the great sheep-ranges of Australia. A practicable line of road was immediately constructed by convict labour, and the tide of occupation entered on the new and limitless expanse. The numerous streams that rise on the west side of the water-shed within the colony, all converge and empty their waters into the sea through one channel within the colony of South Australia. The southern and main branch of this great river-system is the Murray. The other great trunks of the system are the Murrumbidgee, which is navigable; the Lachlan, at times reduced to a string of ponds; and the Darling. The Macquarie, passing through the rich district of Bathurst (q. v.), is a large tributary of the Darling, but it reaches it only in the rainy seasons. The coast-line from Cape Howe to Point Danger is upwards of 700 miles long, and presents numerous good harbours formed by the estuaries of the rivers. Owing to the great extent of the colony, stretching as it does over eleven degrees of latitude, the climate is very various. In the northern districts, which are the warmest, the climate is tropical, the summer heat occasionally rising in inland districts to 120°, while on the high table-lands, weeks of severe frost are sometimes experienced. At Sydney, the mean temperature of the year is about 65°. The mean heat of summer, which lasts here from the beginning of December to the 1st of February, is about 80°, but it is much modified on the coast by the refreshing sea breeze. The annual fall of rain is about 50 inches. Rain sometimes descends in continuous torrents, and causes the rivers to rise to an extraordinary height. Sometimes the rains almost fail for two or three years in succession (see **AUSTRALIA**). Along the coast for 300 miles from the northern boundary, the soil and climate are admirably adapted for the growth of cotton, and that plant has already been cultivated as far south as the river Manning (lat. 32° S.). Further south, the climate is more temperate, and is fitted to produce all the grain products of Europe. Immense tracts of land, admirably adapted for agriculture, occur in the south-western interior; while in the south-east coast districts, the soil is celebrated for its richness and fertility. In the north, the cotton and tobacco plants, the vine, and sugar-cane are grown, and pine-apples, bananas, guavas, lemons, citrons, and other tropical fruits are produced. In the cooler regions of the south, peaches, apricots, nectarines, oranges, grapes, pears, pomegranates, melons, and all the British fruits, are grown in perfection, and sometimes in such abundance that

the pigs are fed with them. Wheat, barley, oats, and all the cereals and vegetables of Europe, are also grown.

Hitherto, however, agriculture has been only of secondary importance, the predominating interest being the pastoral. In 1861, there were only about 261,000 acres of land in cultivation, of which about one-half was sown with wheat, one-fifth with maize, one-fifth with barley, oats, and green food for cattle, and the remainder was appropriated to potatoes, vineyards, and orchards. The colony usually produces little more than half the wheat necessary for the inhabitants, the rest being imported from South America, South Australia, and California. Considerable attention has of late years been bestowed on the cultivation of the vine and the manufacture of wine. The produce in 1862 was nearly 100,000 gallons of wine and 709 gallons of brandy, at the rate of about 160 gallons per acre.

The great produce of the colony is wool, the export from Sydney in 1861 being 12,809,362 lbs., valued at £1,123,699. Sheep-farming requires a large capital, together with skill and experience; and the sheep-farmers or squatters form the territorial aristocracy of the colony. All the best pasture-land has long been taken up and rented (for periods of 10—15 years) from the crown under certain conditions. Stations, or the right of grazing, with the stock on them, are continually advertised for sale; the price of a station is according to the number of cattle or sheep on it. The question of the rent that the 'squatters' should pay (which used to be about £10), and of the tenure by which the pasture-lands should be held, was long a source of agitation and bitterness in the colony. They now pay about a farthing a year for each sheep the run can support. According to the present regulations, arable lands are disposed of by two distinct systems of sale: one, to the highest bidder at auction in unlimited quantities; the other, at a fixed price in limited quantities. By this last, known in the colony as 'Free Selection before Survey,' the intending cultivator can first select for himself, and then secure in fee-simple a quantity not less than 40, and not more than 320 acres, at the rate of 20s. per acre, on condition of residing on his farm, improving a portion of it, and not subletting it.

The extent of the coal-fields of N. S. W. is as yet imperfectly known. With the present limited amount of labour, about 20,000 tons are produced weekly from the collieries now in operation. Iron, lead, and numerous copper mines are worked. Gold was discovered here in May 1851, and in that year gold was exported to the amount of £468,336. This amount was increased to £2,660,946 in 1852, but subsequently, owing to the discovery of the richer diggings of Victoria, gold-mining in this colony began to languish. Since 1857, however, the annual amounts delivered by the escorts have been steadily increasing, that for 1861 being 403,139 ounces (value, in round numbers, £1,600,000). In 1861, there were in the colony 6,119,163 sheep, 2,408,586 cattle, and 251,497 horses. From statistical tables of the British colonies, presented to the Houses of Parliament in 1862, we find the revenue of N. S. W. for 1860 stated at £1,880,508, and the expenditure at £2,047,955. In 1860, the imports, consisting principally of linens and drapery, leather, tea, wool, beer, flour, and hardware, amounted to £7,519,285; and the exports, consisting of gold, wool, hides, tallow, cotton goods, sugar, grain, and coal, to £5,072,020. The Sydney branch of the Royal Mint has, since its institution in 1855, issued 8½ million pounds in sovereigns and half-sovereigns. From Sydney there are three lines of railway

already open to considerable distances, and in course of further extension; and there is telegraphic communication with the capitals of the other colonies. N. S. W. is self-governed, with a governor appointed by the Queen, a responsible ministry, a legislative council nominated by the crown, and a House of Assembly elected by permanent residents. As regards religion, all sects are on a footing of equality, and each receives aid from the state according to its numbers; but state aid is likely before long to cease. At the census of 1861, there were 34,769 scholars (about 1 in 10 of the population) attending the primary schools, to which the state contributed at the rate of £1, 14s. 11d. per scholar. For the higher education, see SYDNEY. The capital is Sydney, with a population of 94,000; and the other chief towns are Parramatta, Bathurst (q. v.), Goulburn, Maitland, Newcastle, Grafton, Armidale, and Albury, with populations ranging from 3000 to 8000.

N. S. W. took its origin in a penal establishment, formed by the British government in 1788 at Port Jackson, near Botany Bay (latitude, 34°). The prisoners, after their period of servitude, or on being pardoned, became settlers, and obtained grants of land; and these 'emancipists' and their descendants, together with free emigrants, constitute the present inhabitants. Transportation to N. S. W. ceased in 1840, and up to that date, the total number of convicts sent thither amounted to 60,700, of whom only 8700 were women. They were assigned as bond-servants to the free settlers, who were obliged to furnish them with a fixed allowance of clothing and food. In 1833, there were 23,000 free males and 13,500 free females, to 22,000 male and 2700 female convicts; and of the free population, above 16,000 were emancipists. The following table shews the recent rate of increase in houses and persons:

	Houses.	Persons.	Males.	Females.
1861.....	57,418	350,860	196,488	152,372
1856.....	39,373	251,215	138,683	112,632
	18,039	99,645	59,905	39,740

In 1860, the number of immigrants that arrived was 16,073, of whom 11,092 were adult males, 3345 adult females, and 1638 children; and in the same year 6847 persons, of whom 5368 were males and 1479 females, left the colony. The permanent increase of population by immigration to N. S. W. in 1860, was thus about 10,000.

NEW STYLE. See CALENDAR, DATE.

NEW SWINDON. See SWINDON.

NEW-YEAR'S DAY, the first day of the year. The custom of celebrating by some religious observance, generally accompanied by festive rejoicing, the first day of the year, appears to have prevailed among most of the ancient nations. The Jews, the Egyptians, the Chinese, the Romans, and the Mohammedans, although differing as to the time from which they reckoned the commencement of the year, all regarded it as a day of special interest. In Rome, the year anciently began in March; and when Numa, according to the ancient legend, transferred it to the 1st of January, that day was held sacred to *Janus Bifrons*, who was thus supposed to turn at once back upon the old year and forward into the new. On the establishment of Christianity, the usage of a solemn inauguration of the New Year was retained; but considerable variety prevailed, both as to the time and as to the manner of its celebration. Christmas Day, the Annunciation (March 25th), Easter Day, and March 1st, have all, at different times or places, shared with the 1st of January the honour of opening the New Year; nor was it till

NEW-YEAR'S DAY—NEW YORK.

late in the 16th c., that the 1st of January was universally accepted as the first day of the New Year. The early fathers—Chrysostom, Ambrose, Augustine, Peter Chrysologus, and others—in reprobation of the immoral and superstitious observances of the pagan festival, prohibited in Christian use all festive celebration; and, on the contrary, directed that the Christian year should be opened with a day of prayer, fasting, and humiliation. The mandate, however, was but partially observed. The festal character of the day, generally speaking, was pertinaciously preserved, but the day was also observed as a day of prayer; and this character was the more readily attached to it when the year began with the 1st of January, as that day, being the eighth after the nativity of our Lord, was held to be the commemoration of his circumcision (Luke ii. 21).

The social observances of the first day of the New Year appear to have been in substance the same in all ages. From the earliest recorded celebration, we find notice of feasting and the interchange of presents as usages of the day. Suetonius alludes to the bringing of presents to the capital; and Tacitus makes a similar reference to the practice of giving and receiving New Year's gifts. This custom was continued by the Christian kingdoms into which the Western Empire was divided. In England we find many examples of it, even as a part of the public expenditure of the court, so far down as the reign of Charles II.; and, as all our antiquarian writers mention, the custom of interchanging presents as common in all classes of society. In France and England it still subsists, although eclipsed in the latter country by the still more popular practice of Christmas gifts. In many countries, the night of New-Year's Eve, 'St Sylvester's Eve,' was celebrated with great festivity, which was prolonged till after 12 o'clock, when the New Year was ushered in with congratulations, complimentary visits, and mutual wishes for a Happy New Year. This is an ancient Scottish custom, which also prevails in many parts of Germany, where the form of wish—'Prosit (for the Lat. *prosit*)—Neu-jahr'—'May the New Year be happy'—sufficiently attests the antiquity of the custom. In many places the practice of tolling bells at midnight, and thus 'ringing in the New Year,' is still observed. Many religious communions are wont to celebrate it with a special service. In the Roman Catholic Church, the *Te Deum* is still sung at the close of the old year; and New-Year's Day is a holiday of strict obligation.

NEW YORK, one of the thirteen original states of the United States of America, now the most important in population and wealth, occupies an irregular triangular area from the Atlantic Ocean to the great lakes, lat. 40° 29' 40"—45° 0' 42" N., long. 71° 51'—79° 47' 25" W. The state is 412 miles from east to west, 311 from north to south, with an area of 50,519 square miles, or 32,392,160 acres; bounded N. by Lake Erie, Lake Ontario, the river St Lawrence, and Canada; E. by Lake Champlain, and the states of Vermont, Massachusetts, and Connecticut, and by the Atlantic Ocean; S. by the ocean, New Jersey, and Pennsylvania; W. by Pennsylvania, the Niagara River, and the lakes which make its irregular north-western boundary. The state has 60 counties. Its chief towns are New York City, Albany, the capital, Buffalo, Rochester, Oswego, Troy, Hudson, Syracuse, Utica, &c. Pop. nearly 4,000,000, of whom 1,000,000 are of foreign birth, 500,000 being Irish and about 250,000 Germans. N. Y., though resting only one corner upon the Atlantic, has its sea-coast extended by Long Island, Staten Island, &c., to 246 miles; while it has a lake coast of 352 miles, and borders for 281 miles on

navigable rivers. The Hudson, broad and deep, with tides flowing 150 miles, joins at Albany a system of canals, which connect New York City with the great-western lakes and the river St Lawrence. The state is also traversed by railway-lines in every direction. The centre is beautified by many picturesque lakes, and its north-eastern portion and the banks of the Hudson by fine mountain scenery. The Blue Ridge of the Alleghanies forms the Highlands, whose peaks rise 1500 feet from the Hudson; north of these, the Katskills rise to a height of 3900 feet, with a large hotel for summer visitors at an elevation of 2000 feet; while Mount Marcy and Mount Anthony, peaks of the Adirondacs, in the wild region west of Lake Champlain, are 5337 and 5000 feet high. The chief rivers, besides the Niagara and St Lawrence, are the Hudson, its chief branch the Mohawk, the Genesee, and the sources of the Delaware, Susquehanna, and Alleghany. Its geology presents a series of older rocks, from the Azoic to the lower members of the Carboniferous. Red Sandstone of the Middle Secondary period is found on the borders of New Jersey; drift and boulders are found everywhere; the great metamorphic belt passes along the eastern line, and granite with iron occurs in the north-east. There is no coal, but rich beds of marble near New York City; productive salt-springs in the centre of the state, yielding 7,000,000 bushels a year; petroleum and natural gas, enough in some cases to light large villages, in the west. Among the mineral springs, those of Saratoga and Ballston have a wide reputation. The climate, mild on the coast, is cold in the northern counties. The soil, particularly of the western and limestone regions, is very fertile, producing the finest wheat, maize, apples, peaches, melons, grapes, &c., in abundance. In 1860, N. Y. state produced 3,000,000 tons of hay, 9,000,000 bushels of wheat, 27,000,000 of oats, 19,000,000 of maize, 14,000,000 apples, 5,000,000 lbs. maple-sugar, 40,000,000 lbs. cheese, 9,000,000 lbs. wool. Among the natural curiosities are the Falls of Niagara; of the Genesee, three cascades of 96, 25, and 84 feet in 2½ miles; of the Trenton, which falls 200 feet in 5 cascades; the Taghanie Falls, of 230 feet; and the oft-painted Falls of the Kaaterskill, 175 and 85 feet, in a gorge of the Katskill Mountains. There are 24,833 manufacturing establishments, employing 215,000 persons, and a capital of 317,000,000 dollars; 35 railways extend 2622 miles; the Erie Canal is 350 miles, and all the New York canals 855 miles; 300 banks of issue have a circulation of 37,000,000 dollars. There are 5077 churches; 11,621 public schools, with school libraries of 1,271,000 volumes; 1520 private schools; 208 academies, a state normal school, teachers' institutes in 50 counties, 14 colleges, 7 medical colleges, 10 theological institutes. Of paupers, in 1860, 13,428 were in poorhouses, and 125,000 had outdoor relief, and 65,000 were foreigners. There were 2169 convicts in 4 state-prisons, who cost the state 282,705 dollars, of which they earned 238,627 dollars. There are 559 newspapers, and 112 other periodicals—73 daily, 401 weekly, 113 monthly, 16 quarterly; but a large number of these are published in the city of New York, and circulated over the Union. The government consists of a governor, two houses of legislature, 8 judges of the court of appeals, 33 justices of the supreme court, and judges of inferior courts—all elected by the people.

The earliest exploration of New York by Europeans was in 1609 by Hendrick Hudson, who took possession of the country on the river which bears his name for the Dutch; and by Champlain, a Frenchman, who explored Lake Champlain from Canada. It was possessed by the Iroquois, or

Five Nations, and the Algonquins. In 1621, the Dutch made a settlement on Manhattan Island, which they bought for 24 dollars, and founded New Amsterdam, now New York. In 1664, N. Y. was taken by the English. At this time it had more slaves than Virginia. The frontier settlement suffered in wars with the French and Indians. In the War of Independence (1776), Washington was driven from New York City, which was held by the British till the end of the war; but Westpoint was held, and Burgoyne, after two severe battles near Saratoga, compelled to surrender. The state constitution was adopted in 1777; in 1825, the opening of the Erie Canal gave a great impetus to the prosperity of the state. The population, in 1800, was 586,756; 1820, 1,372,812; 1840, 2,428,921; 1860, 3,880,735.

NEW YORK, the most important city and seaport of the U. S., and the third in the civilised world, is situated on the east side of the mouth of the Hudson River, at its confluence with a narrow strait called East River, which opens into Long Island Sound, in the state of New York, 18 miles from the ocean. Lat. 40° 42' 43" N., long. 74° 0' 3" W. The city comprises the island of Manhattan, formed by the Hudson River, and the East River, and separated from the mainland by a narrow strait called Harlem River, on the east side, and on the west by Spuyten Duyvel Creek, and also includes several smaller islands, containing the fortifications in the harbour, and the public institutions in the East River. The island on which the city is built is 13½ miles long, and with an average breadth of 1¼ths of a mile, comprising 22 square miles. A rocky ridge runs through the centre, rising at Washington Heights, 238 feet. The compactly-built city extends five miles from the 'battery' at its southern point, and is laid out regularly into 141,486 lots. Avenues, 100 feet wide and 8 miles long, in straight lines, are crossed at right angles by streets from 80 to 120 feet wide, extending from river to river. The city is connected with the mainland of N. Y. by bridges across the Harlem River, and with New Jersey, Long Island, and Staten Island by fifteen steam-ferries, which carry daily hundreds of thousands of passengers. Ten railways radiate from the city, while the finest passenger steam-boats in the world pass up the Hudson, Long Island Sound, and down the Narrows, through the lower bay. The harbour, formed by the upper and smaller bay, with its two arms, which almost enclose the city, is one of the finest in the world. There are 60 piers for shipping on the west, and 70 on the east side of the city. The harbour is defended by twelve forts, mounting 1500 guns. The streets are traversed by 24 lines of omnibuses and horse-railways, five of which carried, in 1859, 32,000,000 passengers.

The city is built of brick, brown sandstone, and white marble. Among its finest edifices are the City Hall, Custom House, Trinity Church, Grace Church, two universities, cathedral, Academy of Music, Cooper Institute, and the numerous great hotels, several of which have accommodations for more than a thousand persons. Of 274 churches, 43 are Protestant Episcopal, 25 Roman Catholic, and the others of all denominations. There are 52 ward or grammar schools, 35 primary, 8 for coloured children, 12 corporate and 4 normal schools, a free academy, having 29 teachers, and free evening schools. Besides, there are 35 Roman Catholic schools, and colleges and academies of the religious orders. Columbia College is one of the oldest in the country; the University of the City of New York has been more recently established. Each has departments of law and medicine, and there are two other medical colleges, several theo-

logical seminaries, and many private academies. The hospitals and institutions of charity are on a liberal scale; and besides legal outdoor relief, the poor are visited and cared for by a public society, with agents in every district. Among the charities are asylums for insane, blind, deaf and dumb, madalens, foundlings, &c. The Astor Free Library, founded by John Jacob Astor, has 100,000 carefully selected volumes; the Mercantile Library, 60,000 volumes, with a large reading-room; Society Library, 40,000; Historical Society, 30,000, with rich museums of antiquities; the Cooper Institute, a present to the city by Peter Cooper, has a free reading-room, picture-gallery, art-schools, &c. Annual art exhibitions are given by the National Academy of Design, Dusseldorf and International Galleries. The Academy of Music, or Opera House, has seats for 4700 persons, and eight or ten theatres give nightly entertainment to 20,000. The Central Park, laid out in the finest style of landscape-gardening, is two and a half miles long by three-fifths of a mile wide. Eight smaller public parks are scattered over the city. The Croton Aqueduct brings a river of pure soft water from 40 miles distance, which is received in reservoirs of a capacity of 1,200,000,000 gallons, and distributed through 270 miles of pipes, with such a head as to supply public fountains of 60 and 80 feet jet, and the upper stories of most buildings. Eleven markets supply annually 140,000,000 lbs. beef, 25,000,000 lbs. mutton, 56,000,000 lbs. pork, and immense quantities of poultry, game, fish, oysters, fruits, and vegetables. The city government is composed of a mayor, boards of aldermen and councilmen, and bureaux of various departments. The police numbers about 1600, with salaries of 800 to 5000 dollars a year. The stations are connected by telegraph, and have lodging for destitute persons. A sanitary squad has charge of the public health. The Commissioners of Charity and Correction have direction of asylums, hospitals, and prisons. Commissioners of Emigration receive and attend to the wants of immigrants. A volunteer fire department, of 4227 members, mans 50 steam and hand engines, 56 hose-carts, and 17 hook and ladder trucks. A militia division of sixteen regiments has an arsenal, several armouries, and an efficient organization. The mortality is 1 in 35, the most fatal diseases being consumption, cholera infantum, scarlet fever, and measles. Intramural interments are forbidden, and large and highly-ornamental cemeteries have been opened on Long Island.

N. Y. is the great centre of American finance and commerce. It receives 66 per cent. of all imports, and sends out 35 per cent. of all exports. Its tonnage of shipping is 1,444,361. It has 25 ship-yards, and numerous manufactories of steam-engines, machinery, furniture, clothing, carriages, sugar-refineries, and pianoforte factories. Its numerous presses issue 256 periodical publications—18 daily, 11 semi-weekly, 114 weekly, 101 semi-monthly and monthly, and 12 quarterly. There are 13 German papers, 2 French, 1 Spanish, and 2 Welsh. There are 10 or 12 large book-publishing houses, some of which are among the largest in the world.

N. Y., the Nieu Amsterdam of the Dutch, was founded in 1621; in 1664 it was taken by the English. At the period of the revolution, it was smaller than Philadelphia or Boston; but increased in importance, especially after the completion of the Erie Canal had opened to it the commerce of the west. In 1789, 2086 persons died of yellow fever; in 1832, 3513 of cholera; in 1835, a fire destroyed a large portion of the business part of the city, with a loss of 18,000,000 dollars. In 1741, in consequence of a supposed negro plot to burn the city, 13



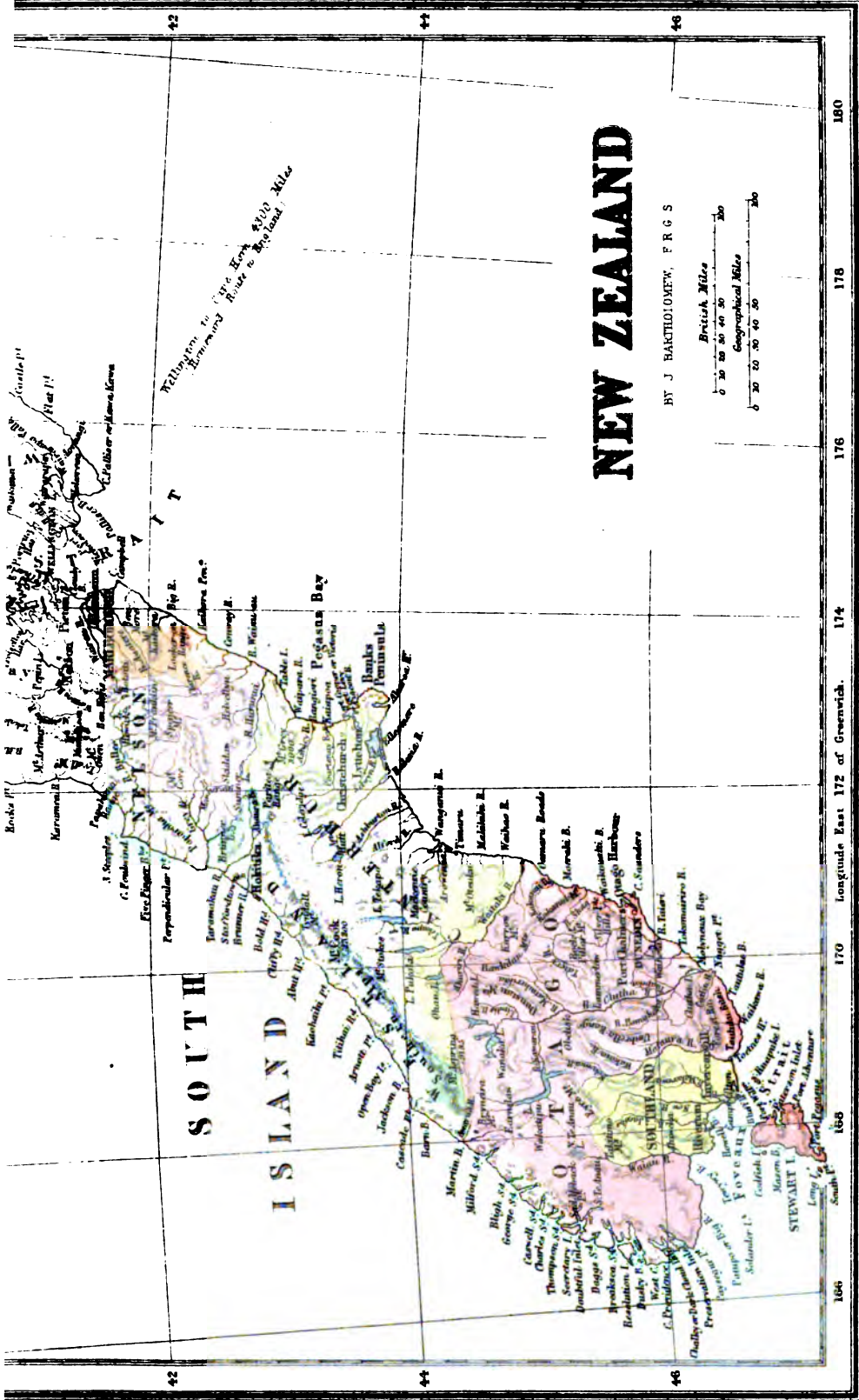

Wellington to Cape Horn 4700 Miles
 Estimated Route to New Zealand

NEW ZEALAND

BY J. BAKTHOLOMEW, F.R.G.S.

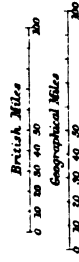

SOUTH ISLAND

166 170 174 178 180

Longitude East 172 of Greenwich.

166 170 174 178 180

42 44 46

South Is.

W & R CHAMBERS, LONDON & EDINBURGH.

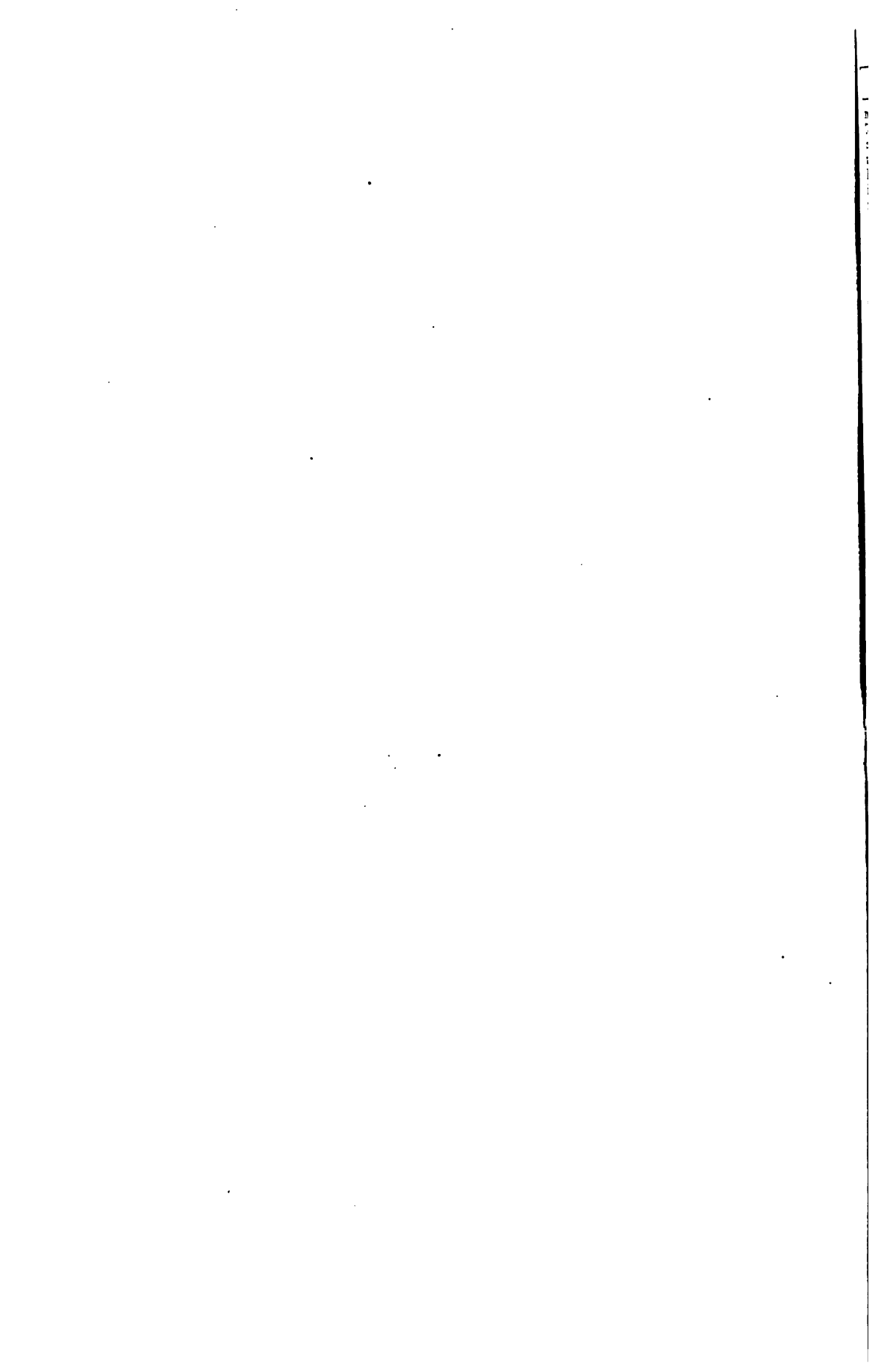

NEW ZEALAND.

negroes were burned at the stake, 20 hanged, and 78 transported. In 1863, in a riot caused by the conscription, the popular fury again turned against the negroes, and numbers were murdered. The population in 1850 was 515,647; in 1860, 813,666; but including the suburbs, within a radius of five miles from the centre, the population is about 1,200,000.

NEW ZEALAND, a British colony in the South Pacific Ocean, consists of three islands, two large and one much smaller, and of a number of islets scattered round the coasts. These islands, named respectively North, Middle, and South or Stewart's Island, are situated about 6500 miles west from the coast of South America, and about 1200 miles south-east of Australia. The group is irregular in form, but may be said to extend from the south in a north-north-east direction, and, like the peninsula of Italy, resembles a boot in shape. North Island is 500 miles long, and 200 miles in greatest breadth from east to west; Middle Island is 650 miles long, and 210 miles in greatest breadth; South Island is triangular in shape, and has an area of about 900 square miles. Area of the three islands about 95,000 square miles. The North is separated from the Middle Island by Cook's Strait, which is 18 miles wide at its eastern and 90 miles wide at its western end; the Middle is separated from the South Island by Foveaux Strait, which averages about 20 miles in width. The group extends in lat. from 34° 15' to 47° 30' S., and in long. from 166° to 179° E.; being thus almost the antipodes of the British Isles.

Coast Line.—Of the entire coast line of about 4000 miles, nearly 1500 miles is formed by the shores of North Island, which are deeply indented, and contain many excellent harbours. Commencing from North Cape, and going south-east round the island, the chief harbours are Monganui, Wangarua, the Bay of Islands, Auckland, Mercury, and Tauranga Bays, and the ports of Wellington, Manukau, and Hokianga. On the north and south coasts of Middle Island, which are much broken, the harbours are numerous and excellent; on the eastern coast, the principal harbours are Akaroa, Victoria, and Dunedin. On the coasts of South Island, there are also good ports.

Surface.—The New Zealand Islands are of volcanic origin, and a great portion of the entire area is occupied by mountains, among which are many extinct and a few active volcanoes. In North Island, Mount Ruapahu, the highest summit of the central range, is 9000 feet in height, and is capped with perpetual snow. In the same range is Tongariro, an active volcano, 6000 feet high. A continuous range of mountains runs along the western coast of Middle Island, and assumes the form of table-lands and isolated peaks toward the east. This range rises in Mount Cook to about 14,000 feet. In Southern Island, the greatest elevation is about 3000 feet. The mountains are mostly clothed with evergreen forests of luxuriant growth, interspersed with fern-clad ranges, and occasionally with treeless grassy plains. Extensive and rich valleys and sheltered dales abound in North Island; and in the east of Middle Island there are many expansive plains of rich meadow-land, admirably adapted either for agriculture or cattle-breeding. Water and water-power are found in great abundance in the colony, and the numerous rivers are subject to sudden floods from the melting of the mountain snows. As a rule, however, the streams are short, and are not navigable for more than 50 miles above their mouths. The chief is Waikato River, in North Island, which, issuing from the Taupo Lake (30 miles long by 20 broad), flows in a northern direction for 200 miles, and reaches the

sea on the west coast. In Middle Island, the rivers Clutha, Mataura, and Waiau, all flowing south, are among the chief. Around Lakes Rotomahana and Rotorua are a number of grand and beautiful geysers, which throw up water heated to 2° above the boiling-point. The geology of N. Z. is remarkable in a high degree. The mountains, which are of every variety of outline, are chiefly composed of the lower slate-rocks, intersected with basaltic veins, primary sandstone, and limestone. Beds of coal and lignite exist, and the former have been to some extent worked.

Soil, Climate, and Productions.—Of the whole surface-extent of N. Z. (nearly 70,000,000 acres, little short of the combined area of England and Wales, Scotland, and Ireland), one-fourth is estimated to consist of dense forest tracts, one-half of excellent soil, and the remainder of waste lands, storie-hills, and rugged mountain regions. Nearly 40,000,000 acres are supposed to be more or less suitable for agriculture and cattle-breeding. The soil, although often clayey, has in the volcanic districts more than a medium fertility; but the luxuriant and semi-tropical vegetation is perhaps as much due to excellence of climate as to richness of soil. Owing to the prevalence of light and easily worked soils, all agricultural processes are performed with unusual ease. The climate of N. Z. is one of the finest in the world. The country contains few physical sources of disease; the average temperature is remarkably even at all seasons of the year, and the atmosphere is continually agitated and freshened by winds that blow over an immense expanse of ocean. In a word, the climate much resembles that of England, with half the cold of the English winter; while the summer is longer and somewhat warmer, the atmosphere is more breezy and pure, and there are many more fine days throughout the year. In North Island, the mean annual temperature is 57°; in South Island, 52°. The mean temperature of the hottest month at Auckland is 68°, and at Otago 58°; of the coldest month, 51° and 40°. The air is very humid, and the fall of rain is greater than in England, but there are more dry days. All the native trees and plants are evergreens. Forests, shrubberies, and plains are clothed in green throughout the year, the results of which are, that cattle, as a rule, browse on the herbage and shrubs of the open country all the year round, thus saving great expense to the cattle-breeder; and that the operations of reclaiming and cultivating land can be carried on at all seasons. The seasons in N. Z. are the reverse of ours; January is their hottest month, and June the coldest. All the grains, grasses, fruits, and vegetables grown in England are cultivated in this country with perfect success, being excellent in quality and heavy in yield; while, besides these, the vine is cultivated in the open air, and maize, the taro, and the sweet-potato are cultivated to some extent in the sunny valleys of North Island. The entire acreage under crop in N. Z. in 1851 was 29,140; in 1858, it was 141,007; in December 1861, 226,500; while in that year the total acreage fenced was 409,473. The principal crops were wheat, barley and oats, potatoes, and sown grass. It is estimated that, in 1863, 300,000 acres were under crop. Besides a few harmless lizards, a small species of rat is the only indigenous four-footed animal found in either of the great islands. Hawks are numerous. The country is destitute of snakes, and possesses no insect so noxious as the English wasp. The pig, introduced by Cook, runs wild, and the red and fallow deer, the pheasant, partridge, quail, &c., and the commoner domestic

animals introduced by colonists, thrive well. In December 1861, there were in the possession of European colonists 28,275 horses, 193,285 horned cattle, 2,276,583 sheep, 12,191 goats, 43,270 pigs, and 236,098 poultry. Coal in abundance, and of good quality, as well as iron, gold, silver, tin, copper, &c., are distributed over the colony. For statistics of the quantity of gold exported, see article Otago. Valuable timber is in great abundance. The number of inhabitants in 1858, was 59,328; in 1861, 98,971; and in 1863, 196,500. In the same year, the revenue (one half of which is derived from the 'wild land' fund) amounted to £1,000,000; the public debt to about £2,000,000. The exports, consisting principally of gold, wool, ores, and timber, amounted in 1862 to £2,422,734; the chief items being gold dust, to the value of £1,591,389, and wool (10,000,000 lbs.), to the value of £674,226; and the imports, consisting of British manufactures, tea, coffee, &c., imported for the most part direct from London, amounted to £4,626,062.

The colony is divided into the following nine provinces: Auckland, Taranaki, Wellington, Hawke's Bay, Nelson, Marlborough, Canterbury, Otago, and Southland. The government is administered by a governor and four judges appointed by the crown, a Legislative Assembly appointed by the governor, and a House of Representatives elected by the people. Grammar and free schools, endowed from the public revenues of the various provinces, and the church and Wesleyan colleges at Auckland, are the principal educational institutions. In December 1861, 68·67 per cent. of the entire population of European descent could read and write; and at that time 44·89 per cent. of the population belonged to the Church of England, 21·41 to the Presbyterian churches, and 10·98 to the Roman Catholic Church. The excess of immigration over emigration in 1862 was 20,991, which was distributed among the provinces in the following proportions: Otago, 14,058; Auckland, 3277; Canterbury, 2768; Southland, 517; Nelson, 271; Wellington, 99; and Hawke's Bay, 3.

The New Zealanders, or Maories (q. v.), numbering, in 1863, no more than 56,000, are located, with the exception of a few hundreds, in North Island.

N. Z. was discovered by Tasman in 1642, and was repeatedly visited by Captain Cook, who surveyed the coasts in 1770. After the settlement of Port Jackson, in New South Wales, the English and American ships engaged in the capture of the multitudes of whales that frequent those seas, had recourse to the coasts of N. Z. for provisions and shelter, especially in the excellent harbours of the Bay of Islands. N. Z. flax came also to be an article of traffic, and individual Englishmen began to settle on the coasts, and intermarry with the natives, and acquire land in right of their wives, or of purchase. Missionary enterprise began in 1814, favoured by various chiefs, who made grants of land to the missions. The missionaries not only laboured to convert the natives, but introduced improved culture among them, and did what they could to protect them from the injustice, fraud, and oppression of the Europeans that visited the islands, or had acquired settlements. More effectually to secure this object, a British resident or consul was appointed in 1833, but without any authority. In the meantime, a desultory colonisation and the purchase of rights to land from the natives for a few hatchets or muskets were going on; and to put an end to this state of anarchy, a lieutenant-governor was appointed, who, in 1840, concluded, at Waitangi, a treaty with the native chiefs, whereby the sovereignty of the islands was ceded to Britain, while the chiefs were guaranteed the full possession of

their lands, forests, &c., so long as they desired to retain them: the right of pre-emption, however, was reserved for the crown, if they wished to alienate any portion. Thus N. Z. became a regular colony, the seat of government of which was fixed on the Bay of Waitemata, and called Auckland. The previous year an association, called the New Zealand Company, had made a pretended purchase of tracts amounting to a third of the whole islands, and for a dozen years most of the colonisation of N. Z. was conducted under its auspices. The conduct of the company is considered to have been on the whole prejudicial to the prosperity of the colony; and after a long conflict with the government, they resigned, in 1852, all their claims—which the government had never confirmed—on condition of receiving £268,000 as compensation for their outlay. The unscrupulous way in which the Company and others often took possession of lands which the natives conceived themselves to have a right to, brought on, between 1843 and 1847, a series of perilous and bloody conflicts with those warlike tribes. They seemed, however, to have laid aside their hostility, and to have begun to compete with the white colonists in industry of every kind, as well as in civilisation generally. But in 1861 another outbreak took place, mostly confined to the Waikato river, and the province of Taranaki, the head-quarters of the Maories. The latest accounts, however (March 1864), seem to indicate that the last sparks of rebellion are either being crushed, or are dying out.

NEW ZEALAND FLAX. See **FLAX**, **NEW ZEALAND**.

NEWARK, a municipal and parliamentary borough of England, in the county of Notts, on the Great Northern and Midland Railways, and on a navigable branch of the river Trent, sixteen miles south-west of Lincoln. The parish church, a large and elegant edifice, though often rebuilt, still shews traces of its original Norman character. N. is approached from the north by a causeway a mile and a half long, carried over the flat island formed by the Trent on the west and the Newark branch on the east. The Castle of Newark, in which King John died in 1216, was built early in the 12th century. N. is said to be the greatest malting town in England; there are numerous flour-mills and breweries, and an extensive trade in corn, malt, flour, cattle, wool, and coal. It returns two members to parliament. Pop. (1861) 11,515.

NEWARK, a city and port of entry of New Jersey, U. S., on the west bank of the Passaic River, twelve miles from New York, on the New Jersey Railway. It is a handsome and industrious city; its principal street is two miles long, 132 feet wide, shaded by great elms, and bordering on three public parks. It contains a custom-house and post-office, 58 churches, 40 public schools, 5 banks, 9 newspapers, and extensive manufactories of leather, patent leather, enamelled cloth, carriages, saddles and harness, boots and shoes, clothing, hats, jewellery—547 establishments producing annually 25,000,000 dollars. It was settled in 1666 by a Puritan colony from Connecticut. Pop. in 1860, 71,941.

NEWBERN, a city and port of entry of North Carolina, U. S., on the south bank of the Neuse River, at its confluence with the Trent, 30 miles from its mouth in Pamlico Sound. It exports tar, turpentine, naval stores, flour, and lumber. Pop. in 1860, 5434.

NEWBURG, a village of New York, U. S., on the west bank of the Hudson, 61 miles north of New York, amid the grand scenery of the highlands. Its handsome edifices, villas, and gardens,

on a gentle slope from the river, command a noble prospect. It contains a court-house, five foundries, a cotton factory, breweries, a railway carriage manufactory, 2 pianoforte manufactories, steam-boiler works, 5 soap factories, 41,000 tons of shipping, a large lumber trade, 23 churches, 5 banks, schools, and academies. It was Washington's headquarters during a critical portion of the War of Independence. Pop. in 1860, 15,198.

NEWBURY, a municipal borough and market-town of England, Berkshire, on both banks of the Kennet, seventeen miles west-south-west of Reading. The church, a venerable specimen of the Perpendicular style, was built in the reign of Henry VII.; but the tower was built by John Winchcombe, a clothier and famous citizen of N. in the reign of Henry VIII., and known then, and subsequently, as *Jack of Newbury*. N. is best known for two hard-fought battles between the Royalist and Parliamentary forces which took place here—the first in September 1643, the second in October 1644. In the former, the victory was undecided; in the latter, the advantage was on the side of the Parliamentarians. Pop. (1861) 6161.

NEWBURYPORT, a city and port of entry of Massachusetts, U. S., on the south bank of the Merrimack River, three miles from its mouth, 34 miles north-east of Boston. Lat. 42° 48' 30" N., long. 70° 52' 3" W. It is a pretty town, built on a swell of land rising 100 feet from the river. High Street, three miles long, shaded with trees, a beautiful Mall, and pond of six acres, are its chief ornaments. It has 16 churches, in one of which is the tomb of Whitefield, who died here (1770), 3 banks, 4 manufacturing companies, making 10,000,000 yards of cloth annually, several ship-yards, and manufactories of machinery, hats, clothing, &c.; two daily papers, one of which was established in 1786; a free high school, and a free library of 10,000 volumes. Pop. in 1860, 13,401.

NEWCASTLE, DUKE OF, THOMAS PELHAM HOLLES, minister of the first two Georges, born in 1692, and representative of the noble family of the Pelhams, played a prominent, but by no means illustrious part in the political history of his time. While a very young man, he succeeded to the family peerage by the death of his father, Lord Pelham, and George I. rewarded his attachment to the House of Brunswick by creating him first, Earl of Clare, and afterwards Duke of Newcastle. He was made Secretary of State when but thirty years old, although the king declared that he was not fit to be chamberlain to the smallest court in Germany. There was much of the absurd and grotesque in his character. Macaulay says of him, that 'his gait was a shuffling trot; his utterance a rapid stutter; he was always in a hurry; he was never in time; he abounded in fulsome caresses, and in hysterical tears.' Yet this man was during thirty years Secretary of State, and for near ten years First Lord of the Treasury! He served under Sir R. Walpole, retained his secretaryship in the 'broad-bottomed administration' in 1744, and in 1754 succeeded his brother, Mr Pelham, as head of the government. In 1757, he was compelled to take the first William Pitt (afterwards Earl of Chatham) into his ministry, and to give him the lead in the House of Commons, and the supreme direction of the war and of foreign affairs. A succession of brilliant victories followed—N. being only nominal head of the administration—and the great commoner had almost brought the war to a successful termination, when the accession of George III. led to the resignation of Mr Pitt, and the replacement of N., in May 1762, by Lord Bute, as head of the

ministry. N. declined a proffered pension, with the remark that if he could no longer serve he would not burden his country. In the Rockingham ministry, formed in 1765, N. filled the office of Privy Seal. He died November 17, 1768. His title descended to Henry, 9th Earl of Lincoln, whose great-grandson,

HENRY PELHAM-CLINTON, fifth Duke of Newcastle, and twelfth Earl of Lincoln, was born 1811, and educated at Christ-Church, Oxford. He represented South Notts in parliament from 1832 to 1846, when he was ousted by the influence of his father, the fourth duke, for supporting Sir R. Peel in his free-trade measures. He adopted politics as a profession; was a Lord of the Treasury in the brief Conservative administration of 1834—1835; and First Commissioner of Woods and Forests in the Peel administration, from 1841—1846. He was then made chief Secretary to the Lord-lieutenant of Ireland, but went out of office with his chief a few months afterwards. He succeeded to the dukedom in 1851, and returned to office in 1852, filling the post of Secretary of State for the Colonies (which formerly included the department of war) in the Aberdeen government. The war with Russia broke out, and in June 1854 it was found necessary to create a Secretary of State for War, and the new office was assigned to Newcastle. The 'horrible and heart-rending' sufferings of the British army before Sebastopol in the winter months of 1854 raised a storm of popular discontent, and when the House of Commons determined to inquire into the conduct of the war, the duke resigned. Yet, as is now acknowledged, no blame was attributable either to the Minister for War or his subordinate, Mr Sidney Herbert. They were called upon to administer a vicious system of military organisation, which broke down under the strain brought to bear upon it. N. was re-appointed Colonial Secretary in the second administration of Lord Palmerston, and has held the seals with general approval from 1859 to the present date (1864). In 1860, as Secretary of State for the Colonies, he accompanied the youthful Prince of Wales during a tour in Canada and a portion of the United States, and on his return received the Order of the Garter from the Queen.

NEWCASTLE-UNDER-LYME, a parliamentary and municipal borough of England, in the county of Stafford, 16 miles north-north-west of the town of that name. A branch-railway connects it with the North Staffordshire line, and a branch-canal with the Grand Trunk Navigation. One of its churches, rebuilt early in last century, has a very old square tower of red sandstone. The Free Grammar School has an income of about £100 a year, and was founded in 1602. Hats are the principal branch of manufacture, and silk, cotton, and paper-mills are in operation. N. is surrounded by the famous potteries of the county, and coal-mines are worked in the vicinity. Pop. 12,938.

NEWCASTLE-UPON-TYNE the chief town of Northumberland. Lat. 54° 58' 11" N., long. 1° 36' 36" W. It has the privileges of a county of itself. Gateshead, which stands upon the opposite side of the river, though in a different county, and having a separate jurisdiction, is virtually a part of Newcastle. According to the census of 1861, N. contained a population of 109,108, Gateshead, 33,587; making together, 142,695 inhabitants. N. sends two members to parliament.

The Romans had a stationary camp here, called Pons Ælii—one of the chain of forts by which the Wall of Hadrian was fortified. On the withdrawal of the Romans, the deserted camp became the

residence of a colony of monks, and the town was called Monkchester. Robert, Duke of Normandy, a son of the Conqueror, hastily built a castle here in the lifetime of his father. Hence the modern name of New Castle. William Rufus rebuilt his brother's castle, surrounded the town with a wall, and gave the inhabitants peculiar privileges. The present castle, which displays better than any other in England the genius of Norman military architecture, was erected by Henry II. between the years 1172 and 1177. N. being made the rendezvous of the vast armaments which the first three Edwards led into Scotland, it was in their time surrounded with new walls of unusual strength and magnitude; portions of them yet remain.

The town stands partly upon an elevated platform, and partly upon the north bank of the river, hence the streets in the lower part of the town are steep. The more ancient houses are chiefly built of timber; the upper stories project beyond the lower; dormer-windows and gable-ends appear in the roof. On the failure of timber, brick was resorted to; but all the modern streets have been built of stone, of which there is abundance in the neighbourhood. Chiefly through the instrumentality of one man of humble origin—Richard Grainger—N. has, in modern times, received the addition of many streets, squares, and public buildings, which in point of architectural effect are scarcely to be excelled by any in the kingdom. An extensive conflagration, in 1854, led the way to still more recent improvements. The river is crossed by two bridges—an ordinary street bridge, and a railway viaduct at a high level. The ordinary bridge replaces one which was carried away by a great flood in 1771. It is of stone, and has nine arches. It will soon be removed, to make way for another, so constructed as to admit of the passage of ships. The railway bridge forms one of the engineering triumphs of Robert Stephenson; it consists of six cast-iron arches, supported upon piers of masonry. The length of the viaduct is 1337 feet, and the height of the railway above high-water mark, 112. Below the railway, this gigantic structure carries a carriage-way for ordinary traffic, by which the precipitous streets on both sides of the river are avoided.

There are 13 churches and chapels in the town connected with the Established Church, and about 28 belonging to other classes of worshippers. The mother-church (St Nicholas) is a noble edifice, chiefly in the Decorated style; its steeple, which is singularly light and bold, is early Perpendicular. Many of the new churches are structures of considerable elegance. In the Guild Hall, situated beside the river, an old and somewhat inconvenient building, the town assizes are held; in the Moot Hall, a modern and very handsome Grecian building, overlooking the Tyne bridge, the county courts assemble. A new and very spacious town-hall has recently been built on a block of ground facing St Nicholas Church; associated with it are a corn-market and offices for the transaction of the town business. The market for the sale of butcher-meat and vegetables is probably the most spacious and commodious in the kingdom. All the railways entering the town, terminate in a large station near its centre. Nearly 70 trains arrive and depart daily. A commodious hotel is attached to the station. A building intended by Mr Grainger as an exchange, but now used as a news-room, is one of the most novel and elegant apartments used for that purpose in the kingdom. The jail, a heavy and costly mass of building, occupies a low and confined situation; it has been recently adapted to the carrying out of the separate system. The theatre is the great ornament of Grey Street, the handsomest street in

the town; it was designed after the Pantheon at Rome. The principal monuments in N. are a column, surmounted by a statue of Earl Grey, to commemorate the passing of the Reform Bill, and a bronze statue to George Stephenson.

In order to supply the wants of N. and its thickly-peopled neighbourhood, its markets are conducted on a large scale. The corn-market is held on Tuesday and Saturday; the hay-market and the cattle-market on Tuesday. During the year 1862, 54,936 fat cattle, 286,110 sheep and lambs, and 34,544 swine were sold in the cattle-market. A very large market is held every Thursday morning for the sale of butter, bacon, cheese, eggs, and other articles of country produce. Saturday is general market-day. N. is well supplied with water, derived from the streams and minor rivers to the north-west of the town.

The trade of N. consists chiefly in coal, and in those articles in the production of which great heat is required. The N. coal-trade had its origin in the reign of Henry III. This branch of industry is not now confined to N., but is spread over the greater part of the sea-board of Northumberland and the whole of Durham. Twenty-two millions of tons of coal are annually raised in the northern coal-field, giving direct employment to upwards of 60,000 persons. More than two and a half millions of tons of coke are annually manufactured. Until recently, very little iron was smelted on the Tyne; since the discovery of the Cleveland ironstone, the manufacture has prodigiously increased. The present make in the district of which N. is the centre, is about 600,000 tons yearly. There are annually produced on the Tyne 3000 tons of steel. Large quantities of lead, the produce of the mines of Alston Moor and Weardale, are brought to N. for shipment. Here, too, the silver is extracted, and the lead is rolled into sheets and pipes, or converted into shot, litharge, red and white lead. Copper, to the extent of £100,000 worth, is annually got from the copper pyrites used at the chemical works of the Tyne.

At N. the railway system had its origin. Here, as might be expected, locomotive and engineering establishments are found upon a great scale. The ordnance works of Sir William Armstrong at Elswick, a western suburb of N., are well known. Iron ship-building is carried on upon the Tyne to a great extent; vessels amounting to 51,236 tons were launched in 1863. N. occupies an important position in the manufacture of soda, bleaching-powder, vitriol, and other chemical products. There are decomposed in the district 100,000 tons of salt per annum. Earthenware is largely manufactured; window-glass and flint-glass have declined, but bottles are made to an enormous extent; impressed glass is largely manufactured, and plate-glass is made. Glass-staining has attained a large measure of perfection under Mr Wailes. The firebrick trade is a new element of industry, which has already attained gigantic proportions. About 80,000,000 firebricks are annually made, besides gas-retorts and sanitary pipes, which are sent all over the world. About 100,000 grindstones leave the N. quarries annually. Portland, and other cements, are made to the extent of 11,000 tons in a year. About 500 persons are employed in the town in hat-making; they produce between 500 and 600 dozens of hats and caps every week. Some celebrated paper-mills and large tanning establishments are in the vicinity of Newcastle. Coach-building has largely increased of late years.

The river Tyne, from the sea to N., forms a natural dock for the accommodation of shipping. Two artificial docks have, however, been constructed, and a third is in contemplation. To the Tyne (divided

into the ports of N., North and South Shields) belongs a larger amount of shipping (393,321 tons) than to any single port in the kingdom, except Liverpool and London.

Of the benevolent institutions established in N., the most important are an infirmary, a dispensary, and asylums for the blind, the deaf and dumb. The Literary and Philosophical Society, the Society of Antiquaries, the Natural History Society, the Mechanics' Institution, and the Institute of Mining Engineers, successfully cultivate their several fields of labour.

Amongst the eminent natives of Newcastle may be named Lords Stowel, Eldon, and Collingwood, Mark Akenaide, and Hutton, the mathematician. Intimately connected with it, though not born in it, were Thomas Bewick, the engraver, Robert Morrison, the Chinese scholar, and George and Robert Stephenson.

NEWEL, the central column or spindle formed by the ends of the steps of a circular staircase, and round which the stair winds. In turret-stairs, it is a plain roll; but in Elizabethan and old Scotch castles, there are frequent examples of handsome staircases of this kind with ornamental newels.

NEWFO'UNDLAND, an island and British colony of North America, lies in the Atlantic Ocean, at the mouth of the Gulf of St Lawrence, separated from Labrador on the north by the Straits of Belle Isle (about 12 miles broad), and extending in lat. from 46° 38' to 51° 37' N., and in long. from 52° 44' to 59° 30' W. In shape it resembles an equilateral triangle, of which Cape Bauld on the north, Cape Race on the south-east, and Cape Ray on the south-west, form the angles. It is 370 miles in length, 290 miles in breadth, about 1000 miles in circumference, and has an area of 38,850 square miles; pop. (1861) 122,252.

Of the entire acreage of the island, 3,000,000 acres are set down as *good*, and about 20,000,000 as *poor* land. The island, as seen from the sea, presents a wild and sterile appearance. Its surface is diversified by mountains, marshes, barrens, ponds, and lakes. The mountains in the Avalon Peninsula (stretching south-east from the main portion of the island, and connected with it by an isthmus of only about three miles in width) rise, in some cases, to 1400 feet above sea-level; while, both here and along the western shore, the height of 1000 feet is frequently reached. The number of the lakes and 'ponds' (the latter name being used indiscriminately for a large or a small lake) is remarkable, and it has been estimated, though, perhaps, with some exaggeration, that about one-third of the whole surface is covered with fresh water. The 'barrens' occupy the tops of hills. The coast-line is everywhere deeply indented with bays and estuaries, many of which are spacious enough to contain the whole British navy. Of these inlets, the principal, beginning from the northern extremity of the island, are Hare, White, Notre Dame, Bonavista, Trinity, Conception, St Mary's, Placentia, Fortune, St George's, and St John's Bays. These bays vary in length from 25 to 70 miles, are of great breadth, and are lined—as indeed the whole coast is—with excellent harbours. The rivers, none of which are navigable for any distance, communicate between the lakes of the interior and the shore, and are narrow and winding; occasionally, however, they are turned to account in driving machinery. The main streams are the Exploit, with its affluent the Great Rattling, and the Humber. The soil is sterile and unproductive, although there is considerable cultivation along the sea-board of the settled districts, which are limited principally to

the south-east coast; and a large portion of the land around St John's (q. v.) is under cultivation. The great body of the people are employed either in the fisheries or in establishments connected with them, and little attention has hitherto been paid to the culture of the soil; but there are now prospects of improvement in this respect. In 1861, 41,108 acres were under crops. In 1845, the only crops raised were oats and hay; but within recent years, large supplies of grain, vegetable, and garden seeds have been imported; and in 1861, 550,317 bushels of potatoes were produced, and turnips, hay, carrots, clover, barley, and oats were cultivated with success. The island is rich in useful minerals, among which are silver, copper, galena, marble, limestone, gypsum, roofing-slate, and coal—the last found only in small quantities. Lead, silver, and copper mines are worked, though mining is still in its infancy here. Trees, of which the chief are the fir, birch, willow, and mountain-ash, flourish and reach their natural size only in the low and fertile districts.

The fisheries are of two kinds—the 'Shore Fishery' and the 'Bank Fishery'; the former comprises the shores and bays of N.; the latter comprises a great tract known as the 'Banks' of N., from 500 to 600 miles in length, and about 200 miles in breadth. The Banks form the greatest submarine plateau known; the depth of the water is from 20 to 108 fathoms, and the most productive 'ground' is said to extend between lat. 42° and 46° N. Great variety of valuable fish is found in the waters around the colony, as the cod, salmon, herring, &c. The principal articles of export are fish—comprising dry cod, herring, and salmon—and cod-oil. Of dry cod, 1,138,544 quintals, value £846,238, were exported in 1860; 63,711 barrels of herrings, value £31,856; 3963 tierces of salmon, value £18,824; 53,866 gallons of molasses, value £4713; 4574 tuns cod-oil, value £118,949. The imports are chiefly provisions—as bread, butter, tea, &c.—cordage and cables, and manufactured goods. The imports and exports for 1860 amounted in value to £1,254,123 and £1,271,712 respectively. 375,232 seals were obtained in 1861, and in that year the total value of the products of the sea amounted to £1,269,546. In 1857, 777 vessels, manned by 14,433 men, were engaged in the seal and other fisheries; the number of boats employed was 11,683, and the number of nets and seines, 2354. The total number of men (exclusive of French) employed in the fisheries of N., in 1861, was 24,000. The revenue in 1860 was £180,841; the expenditure, £125,758. In that year, 2717 vessels, of 404,294 tons, entered and cleared the ports. The customs duties amounted, in 1860, to £106,646.

In 1861, there were in the island 260 educational institutions, attended by 12,230 pupils, and maintained at a cost of £11,187, of which government pays about a fourth part. Of the entire population of the island, 55,309 are Catholics, 42,638 Episcopalians, 20,144 Methodists, 822 Presbyterians, a small number of Baptists, Congregationalists, &c. There are no railways in the island, and its peculiar configuration renders even road-making a matter of great difficulty. There are no roads across the island; they are confined chiefly to the south-eastern and south-western sea-board. There is fortnightly communication in summer between St John's and Halifax by steamer. On the colony and connected with it, 400 miles of lines of telegraph have been constructed, 50 miles of which, from Cape Ray to Cape Breton, are submarine.

The early history of N. is involved in obscurity. It was discovered June 24, 1497, in the reign of Henry VII., by John Cabot; and the event is noticed by the following entry in the accounts of the privy-purse expenditure: '1497, Aug. 10. To

hym that found the New Isle, £10.' It was visited by the Portuguese navigator, Gaspar de Cortereal, in 1500; and within two years after that time, regular fisheries had been established on its shores by the Portuguese, Biscayans, and French. In 1578, 400 vessels, of which 50 were English, were engaged in the fishery. Sir Humphrey Gilbert, with his ill-fated expedition, arrived in St John's harbour, August 1583, and formally took possession of the island in the name of Queen Elizabeth. In the return voyage, the expedition was scattered by a storm, and the commander lost. In 1621, Sir George Calvert (afterwards Lord Baltimore) settled in the great peninsula in the south-east, and named it the *Province of Avalon*. The history of the island during the 17th and part of the 18th centuries, is little more than a record of rivalries and feuds between the English and French fishermen; but by the Treaty of Utrecht (1713), the island was ceded wholly to England; the French, however, retaining the privilege of fishing and drying their fish on certain portions of the coast. A governor was appointed in 1728. The present form of government, established in 1855, consists of the governor, a legislative council (appointed by the crown), and a general assembly (elected by the people). The coast of Labrador on the mainland, and the island of Anticosti, have been included, since 1809, within the jurisdiction of the governor of Newfoundland.

NEWFOUNDLAND DOG, one of the most sagacious and esteemed of the large kinds of dog. It is said to have been originally derived from Newfoundland, where it is used chiefly as a beast of draught, to convey light loads of wood or provisions, on sledges, over rugged tracks. Multitudes of these dogs, in St John's and elsewhere, are left to shift



Newfoundland Dog.

for themselves during the fishing season; and are again called to service when required by their masters. There are several varieties of N. D., particularly a smooth breed, with rather small head, white and spotted with black, which seems now to be extinct; a very large breed, with broad muzzle, head raised, noble expression, waved or curly hair, very thick and bushy curled tail, black and white colour; and a smaller, almost black breed. Some of the breeds seem to be crossed with hounds and other dogs. The N. D. is remarkable for memory, and for patience and forbearance of temper. It is, however, apt to become irascible in confinement, and will then bite even its master. Some of the most interesting anecdotes of the affection and sagacity of the dog, relate to the Newfoundland Dog. No dog excels it as a water-dog. Its paws are half-webbed. Its power of endurance in swimming is very great.

NEWGATE, a celebrated London prison, stands at the western extremity of Newgate Street, opposite the Old Bailey. It is the chief criminal prison for the city and county. The exterior presents high dark stone walls, without windows, and with entrances from the side next the Old Bailey, in front of which public executions take place. The earliest prison here was in the portal of the *new gate* of the city, as early as 1218; and hence the name. About two centuries afterwards, it was rebuilt by the executors of Sir Richard Whittington, whose statue with a cat stood in a niche, till its destruction by the great fire of London in 1666. Shortly after, it was reconstructed, from which time, till 1780, the date of the erection of the present edifice, its condition was, in a sanitary point of view, horrible. Mr Akerman, one of the keepers, in his evidence before the House of Commons in 1770, stated, as a proof of this, that in the spring of 1750 the jail distemper, spreading to the adjoining Sessions House, caused the death of 'two of the judges, the lord mayor, and several of the jury and others, to the number of sixty persons and upwards.' The place, however, is now kept in the cleanest possible condition. The cells for condemned prisoners are at the north-east corner, next to Newgate Street. The *Newgate Calendar* contains biographical notices of the most notorious murderers, burglars, thieves, and forgers who have been confined within its walls.

NEWMAN, JOHN HENRY, D.D., was born in London, February 21, 1801, and educated at the school of Dr Nicholas, at Ealing, whence he passed, in 1816, to Trinity College, Oxford, of which college he became a scholar by competitive examination in 1818. Having graduated in 1820, he was elected Fellow of Oriol College in 1822, where he attracted the notice of Dr Whately, and was by him employed in the preparation for publication of his well-known *Treatise on Logic*, and introduced to the editor of the *Encyclopaedia Metropolitana*, to which he became a contributor. He was ordained in 1824; and in the following year, his friend Dr Whately having been appointed head of St Alban's Hall, N. was by him selected as his vice-principal; but on being named tutor in his own college in 1827, as also public examiner, he resigned the vice-principalship. In 1828, he was presented to the vicarage of St Mary's, Oxford, in which church the sermons which he delivered at a late period had an extraordinary influence in forwarding the religious movement with which his name is permanently associated. At this period, N. was an earnest antagonist of the Roman Catholic Church. He was one of those who transferred their support from Sir Robert Peel to Sir Robert Inglis on occasion of the former's introducing the Roman Catholic Relief Bill; and he was one of the most active in commencing and carrying on the so-called Oxford movement—the great object of which was to counteract as well the Romanising as the dissenting tendencies of the time, by restoring and bringing into notice what N. and his friends believed to be the catholic character of the English Church. With this view, he commenced, in 1833, the series known as the *Oxford Tracts*, to which he was himself one of the chief contributors; and in 1838, he also became editor of the *British Critic*, which was an organ of the same views, and, in conjunction with Drs Pusey and Keble, of a *Library of Translations from the Greek and Latin Fathers*. He continued the publication of the Tracts up to the 90th Number, which was written by himself, and the tendency of which was so distasteful to the Anglican authorities, that the Heads of Houses at Oxford condemned the Tract, and the Bishop of Oxford called on N. to discontinue the publication—a request with which he at once complied.

The *British Critic* continued for some time longer to advocate the same opinions; but in 1843 that publication also was discontinued; and N., who had for some time resided at Littlemore, near Oxford, engaged, in company with some of his more youthful adherents, in study and ascetic exercises, thenceforward confined himself chiefly to his Littlemore residence, and eventually, in October 1845, was admitted into the Roman Catholic Church, a step which was immediately followed by the publication of a work on the *Development of Doctrine*, which was intended as an explanation of the process through which the writer's own mind had passed. Soon afterwards, N. repaired to Rome, where, after some preparation, he was admitted to orders in the Roman Catholic Church; and in 1848, on his return to England, he established a branch of the Congregation of the Oratory of St Philip Neri, of which he was himself appointed the superior. In 1852, he was appointed rector of the Catholic University established in Dublin, an office which he held for five years, afterwards returning to the house of the Oratory, Birmingham, where he still (1864) resides, and in connection with which he has established a school of higher studies for the youth of the Roman Catholic religion. Dr N., in addition to the large share which he had in the publications already named, is the author of several very important works, written as well before as after his withdrawal from Anglicanism. Of the former period, are his *History of the Arians*, *Prophetic Office of the Church*, *The Church of the Fathers*, an *Essay on Miracles*, a *Translation of the Treatises of St Athanasius*, with many learned Dissertations, and several volumes of Sermons. To the latter period belong the *Development of Christian Doctrine*, *Lectures on Catholicism in England*, *On Anglican Difficulties*, and *On University Education*. N. is also the author of two works of fiction, *Loss and Gain*, and *Callista*, a classical and Christian story of the 5th c.; and he was the editor, and in part compiler, of a series of *Lives of the English Saints*.

NEWMAN, FRANCIS WILLIAM, brother of the preceding, was born in London in 1805, and educated at the school of Ealing. Thence he passed to Worcester College, Oxford, where he obtained first-class honours in classics and mathematics in 1826, and, in the same year, a fellowship in Balliol College. This fellowship, however, he resigned; and he withdrew from the university in 1830, at the approach of the time for taking the degree of M.A., declining the subscription to the Thirty-nine Articles, which was required from candidates for the degree. After a lengthened tour in the East, he was appointed classical tutor in Bristol College, 1834. In 1840, he accepted a similar professorship in Manchester New College; and finally, in 1846, his great reputation for scholarship, and his general accomplishments, led to his appointment to the chair of the Latin Language and Literature in the London University. During all this time, he has not only been an active contributor to numerous literary and scientific periodicals, and to various branches of ancient and modern literature, but has also had a leading part in the controversies on religion, in which he has taken the line directly opposite to that chosen by his elder brother, being no less ardent as a disciple of the extreme rationalistic school than John Henry Newman of the dogmatical. These opinions, and the system founded upon them, form the subject of his well-known work, *Phases of Faith*, or *Passages from the History of My Creed* (1850); and of many essays in the *Westminster, Eclectic*, and other Reviews; but he is also the author of very many separate publications. Of these, several regard the fundamental questions of the controversy

to which we have referred—as, *Catholic Union*; *Essays Towards a Church of the Future* (1844); *A State Church not Defensible* (1846); a *History of the Hebrew Monarchy* (1847); *The Soul, its Sorrows and Aspirations* (1849). Others are on political or social topics—as, *Radical Reforms*, *Financial and Organic* (1848); *The National Debt* (1849); *The Crimes of the House of Hapsburg* (1851); *Lectures on Political Economy* (1857). A large number, in fine, are devoted to historical, classical, and scientific subjects, the most important of which are *Contracts of Ancient and Modern History* (1847); *Regal Rome* (1852); translations into 'unrhymed metre' of the *Odes of Horace* (1853), and the *Iliad of Homer* (1856); a treatise on *Difficulties of Elementary Geometry*; and several other educational works.

NEWMARKET, a market-town of England, famous for its horse-races, is situated in a valley 13 miles east-north-east of Cambridge, and is partly in the county of that name and partly in Suffolk. It contains many well-built and elegant houses, the residences in many cases of gentlemen who are drawn hither from their interest in the *Turf*. The market-house and the famous Jockey Club are the chief edifices. Malt-making and brewing are carried on to some extent; but the town owes its prosperity to the horse-races, and nearly the half of the population are jockeys, grooms, trainers, or stablemen. The race-course of N., owned partly by the Jockey Club, and partly by the Duke of Rutland, is said to be the finest in the world, and the training-ground bears a similar character for excellence. There are seven race-meetings held here annually. See HORSE-RACING. Pop. (1861) 4069.

NEWPORT, a parliamentary and municipal borough, market-town, and river-port of England, chief town of the Isle of Wight, and situated near the centre of that island, on the Medina, which is navigable up to this point. St Thomas's Church, founded in 1854, on the site of an ancient structure built in the reign of Henry III., is a handsome edifice, and contains a monument erected by Her Majesty in memory of the Princess Elizabeth, daughter of Charles I., who died at Carisbrooke Castle, September 8, 1650. Among the educational establishments of N. is the Free Grammar School, in which frequent meetings and negotiations between Charles I. and the Parliamentary Commissioners took place. About a mile north of N. is Carisbrooke Castle, where the king was confined under the guardianship of Colonel Hammond for twelve months (1647—1648). There are several important institutions in the vicinity, as the Albany Barracks, the House of Industry, and the Parkhurst Prison for juvenile convicts. Manufactures of lace are carried on to some extent. Vessels of considerable tonnage can ascend to the quay at high tides. Pop. (1861) 7934.

NEWPORT, a thriving market-town, parliamentary and municipal borough, and river-port of England, in the county of Monmouth, and 24 miles south-south-west of the town of that name, on the Usk, and about four miles from the mouth of that river. It was anciently the port of the city of Caerleon, about three miles further up the river; but during the present century, it has become a shipping port of considerable importance, being the outlet of the produce of the extensive collieries, and iron and tin works of the neighbourhood. It possesses a number of recently-erected public buildings, has spacious docks, manufactures nails and spikes extensively, exports iron and coal largely, and carries on an excellent general trade. In 1862, 10,625 vessels, of 894,263 tons, entered and

cleared the port. N. unites with Monmouth and Uk in sending a member to parliament. The remains of Newport Castle are now used as a brewery. Pop. (1861) 23,249.

NEWPORT, a city and port of entry, and semi-capital of Rhode Island, U. S., on the west shore of the *island* of Rhode Island in Narraganset Bay, 5 miles from the ocean. Lat. 41° 29' N., long. 71° 19' 12' W. It has a deep, excellent harbour, defended by Forts Adams and Wolcott. It has a state-house, custom-house, market, the Redwood Library, many large hotels, and elegant villas; is renowned for fine scenery and sea-bathing; and is one of the most fashionable watering-places in America. The town also contains cotton and other manufactories. It was settled, in 1638, by 17 adherents of Roger Williams, who followed him in his banishment from Massachusetts. It was occupied by 8000 British troops during the War of Independence, and was for a time the residence of Bishop Berkeley. Pop. in 1860, 10,508.

NEWPORT, a city of Kentucky, U. S., on the Ohio River, opposite Cincinnati, and on the east side of the mouth of the Licking River, opposite Covington. It contains a United States arsenal, and several iron foundries and rolling mills. Pop. in 1860, 10,046.

NEWPORT-PAGNELL, a small market-town of England, in Buckinghamshire, on the Ousel, 50 miles north-north-west of London. Lace is manufactured extensively, and there is a good trade in corn, coal, and timber. Pop. (1861) 3676.

NEWRY, a seaport and parliamentary borough, situated partly in the county of Armagh, but principally in the county of Down, Ireland, distant from Dublin 63 miles north, and from Belfast 38 miles south-south-west, with both which places it is connected by a branch-railway communicating with the Dublin and Belfast Junction Railway. Population in 1861, 12,334, of whom 7803 were Roman Catholics, 2411 Protestants of the Established Church, 1874 Presbyterians, and the rest Protestants of other denominations. N. is a town nearly coeval with the English invasion, having grown up around a monastery founded in 1183, and a castle subsequently erected by De Courcey. This castle was the scene of several struggles; and in most of the civil wars of Ulster, N. suffered severely. It was incorporated as a borough, with a corporation and two members of parliament, by James I. Since the Union, it returns but one member, and the corporation having been abolished by the Irish Municipal Reform Act, the affairs of the town are now administered by 21 commissioners. It is traversed by a river of the same name, which falls into Carlingford Lough, and by a canal, by which the navigation is prolonged to Lough Neagh, a distance of 32 miles. The town is handsomely and compactly built. The quays are lined with spacious warehouses, and there are several mills, tanyards, coach and car manufactories, and iron foundries. Linen, cotton, and iron manufactories are also carried on. In 1862, 1965 vessels of 25,249 tons, entered and cleared the port. Steam-vessels ply to Liverpool and Glasgow from Warrenpoint, a port five miles distant, on Carlingford Lough, which is connected with N. by a ship-canal, admitting vessels drawing 15 feet of water, as well as by the river.

NEWSPAPER, a periodical publication printed and distributed for the circulation of news. From the broadsheet relating the most meagre intelligence without comment or inference, the newspaper has gradually grown up into a powerful political, as well as social engine, diffusing information on all subjects of interest, circulating advertisements, and

acting on the public mind, in times of excitement, to an extent that has led it to be called a fourth estate of the realm.

The earliest approach to the newspaper is to be found in the *Acta Diurna*, or *Acta Publica*, of ancient Rome, an official gazette, which in the later times of the republic, and during the empire, appeared daily under sanction of the government. The contents of these *Acta* consisted of an enumeration of the births and deaths in Rome, an account of the money paid into the treasury, and everything relating to the supply of corn; extracts from the *Acta Forensica*, including the edicts of magistrates, the testaments of distinguished men, reports of trials, with the names of the acquitted and condemned, a list of the magistrates who were elected; extracts from the *Acta Senatus*, an account of public affairs and foreign wars, of the births, deaths, festivals, and movements of the imperial family; and generally, news relating to public buildings, funerals, games, fires, sacrifices, and miracles, as well as amatory stories. The *Acta* seem to have been drawn up under the superintendence of censors, questors, and other magistrates, by officers called *actuarii*, assisted by clerks and notaries; and their publication consisted in posting them in some public place in the city, where they could be read by any one who pleased. They continued to be issued until the downfall of the Western Empire, but there seems never to have been anything corresponding to them at Constantinople.

The beginnings of the newspaper of modern Europe are traceable to Germany and to Venice. Soon after the invention of printing, in the latter half of the 15th c., small news-sheets, called *Relationes* and the *Neue Zeitung*, appeared in Augsburg, Vienna, Ratisbon, and Nürnberg, generally in the form of a letter. The extant numbers contain, among other matters, accounts of the discovery of America, of the conquests of the Turks, of the French and Austrian war in Italy, with such local occurrences as executions, inundations, earthquakes, burnings of witches, and child-murders committed by the Jews. More important, perhaps, were the official *Notizie Scritte*, first issued by the Venetian government in the 16th c., containing accounts of the wars carried on by the Republic, and other events of general interest. At first they were not printed, but were to be seen in various public places on payment of a small coin, called a *Gazeta*, whence the name 'Gazette.' After they were allowed by the government to be printed, they obtained a wide circulation over the whole of Europe.

The earliest English newspapers, or news-letters, belong to the reign of James I., and were printed in the form of small quarto pamphlets. Some copies of a sheet, called the *English Mercury*, purporting to be published by authority of Queen Elizabeth in 1588, the period of the Spanish Armada, have been proved by Mr Watts of the British Museum to be literary forgeries, executed about 1766. The first English newspapers appeared at occasional and irregular intervals—the earliest of them, so far as ascertained, is entitled *News out of Holland*, and was published for M. Newbery in 1619. In 1622, these occasional pamphlets were converted into a periodical weekly publication, entitled *The Certaine News of the Present Week*, edited by Nathaniel Butter. About the same time appeared the *London Weekly Courant*. A large number of publications, hardly deserving the name of newspapers, were circulated during the civil war, with such names as *England's Memorable Accidents*, *The Kingdom's Intelligencer*, *Mercurius Aulicus*, *The Scots Intelligencer*, *The Parliament's Scout*, *The Parliament's Scout's Discovery*, or *Certain Information*,

NEWSPAPER.

The Scots Dove, The Parliament Kite, The Secret Owl, Mercurius Mastic, Mercurius Democritus, Mercurius Acheronticus, or News from Hell, &c. The arrangement of the news is poor in the extreme, and what few comments there are, are of the most virulent description. The Long Parliament subjected the newspaper press to a censorship, which became more strict under Charles II. The first English newspaper which could properly be considered a vehicle of general information, was the *Public Intelligencer*, established by Sir Roger L'Estrange in 1663; it was dropped on the appearance of *The London Gazette*, the first number of which was published November 7, 1665, at Oxford, where the court was residing in consequence of the plague being then in London. A second paper, called *The Observer*, was afterwards started by L'Estrange, who, in 1680, exercised his authority as licencier of the press by issuing a proclamation 'for suppressing the printing and publishing of unlicensed news-books and pamphlets of news.' Small as was the sheet, a difficulty often arose how to fill it. One publisher was in the way of supplying the dearth of news by a passage from the Bible; another announced that 'blank space is left that any gentleman may write his own private business.'

Up to the reign of Queen Anne, few of the newspapers appeared oftener than once a week. From the interest excited by Marlborough's victories arose a demand for more frequent intelligence, and besides 17 newspapers published three times a week, the *Daily Courant*, established in 1709, was issued every day except Sunday. Of the more noted London newspapers, the *London Daily Post and General Advertiser* was established in 1726, and in 1752 became the *Public Advertiser*; a celebrity attaches to it from having been the medium in which 'Junius's Letters' first appeared. The *St James's Chronicle* arose from an amalgamation of two papers, the *St James's Post* and *St James's Evening Post*, both which began in 1715. The *North Briton*, edited by Wilkes, first appeared in 1762. The *Morning Chronicle*, discontinued in 1862, dates from 1770; the *Morning Post*, from 1772; the *Morning Herald*, from 1781; the *Times* first appeared in 1788, as a continuation of the *London Daily Universal Register*, which had been established three years earlier.

During the reign of George III. prosecutions were rife against newspaper writers and editors; their result, generally, was to give a greatly increased currency to the doctrines assailed, and to confer a fictitious importance on the traders in politics, by whom many of the journals were conducted. The first attempt at parliamentary reporting was resented by the House of Commons as a breach of privilege, but the resolutions and the imprisonments of 1771 all ended in the tacit concession of publicity of discussion which has ever since prevailed.

The newspapers of Great Britain have, within the present century, greatly increased in size and improved in literary character. In both respects they are far in advance of the journals of any other country. Each number of the *Times* now consists in general of 24 pages, and contains upwards of 5000 advertisements. The success of the *Times* is mainly due to the enterprise of its original promoter, Mr Walter, who was the first to introduce various important improvements in the art of printing, and made a strong effort to secure the best literary talent attainable in all departments of his journal. One of the most notable incidents in the history of the *Times*, was the exposure, through means of its Paris correspondent, of a gigantic scheme of forgery, planned in France in 1840—a scheme which contemplated the almost simultaneous presentation, at the chief

banking-houses of the continent, of forged Letters of Credit from Glyn and Co. The failure of the conspiracy was mainly due to the exertions made by the *Times*. One of the parties implicated, brought an action for libel against the printer, and obtained a verdict of one farthing damages. A public subscription was raised to defray the expenses incurred in defending the action; when the proprietors of the *Times*, declining personally to accept the sum subscribed, invested it in two *Times* scholarships in connection with Christ's Hospital and the City of London School, for the benefit of pupils proceeding thence to Oxford or Cambridge.

The editing of one of the leading London newspapers involves an immense daily expense, and the co-operation of a number of talented writers. The principal editor, as representative of the proprietors, has the whole oversight and responsibility intrusted to him. He occasionally furnishes the leading article, but it is more frequently composed by one of a staff of literary contributors, who are bound on the shortest notice to write on any subject which the editor may assign. The leader is in form a relic of the time when the newspaper was the newsletter; it is its professed object to analyse, condense, and explain public transactions, to scrutinise what is doubtful or suspicious in the conduct of public men, and to expose sophistry and imposture. Under the editor are various sub-editors, having the superintendence respectively of the London, the provincial, the foreign, the literary, the industrial, and other departments. The commercial article is furnished every evening by a contributor in the City. There are twelve to sixteen parliamentary short-hand reporters, who are continually relieving one another, besides reporters attached to the courts of law, and correspondents who furnish accounts of public meetings and local news of various kinds. The foreign intelligence, a most important department in the great London journals, is furnished by correspondents in all parts of the world, some of them, particularly those employed in time of war, being men of very high reputation in the literary world.

A stamp-duty on newspapers was imposed in 1713 by 10 Anne, c. 19, amounting to one halfpenny on 'half a sheet or less,' and one penny 'if larger than half a sheet, and not exceeding a whole sheet.' The duty was raised $\frac{1}{4}$ d. by 30 Geo. II. c. 19; another halfpenny was added by 16 Geo. III. c. 34; still another by 29 Geo. III. c. 50; and a further addition of $\frac{1}{4}$ d. was made by 37 Geo. III. c. 90, amounting to $\frac{1}{2}$ d. in all. Act 6 and 7 Will. IV. c. 76, reduced the stamp-duty to $\frac{1}{4}$ d., with the addition of $\frac{1}{4}$ d. or $\frac{1}{8}$ d. when the sheet contained upwards of 1550, or of 2295 square inches on each side. An additional $\frac{1}{4}$ d. was chargeable on a Supplement. By 18 and 19 Vict. c. 27, passed in 1855, the newspaper stamp was abolished, a change which occasioned an immense increase in the number of newspapers, and diminution of their price, though many of the cheap papers then started were of very brief duration. The repeal of the paper-duty, which took effect on October 1, 1861, also added, though to a much less considerable extent, to the number and cheapness of newspapers. The number of stamps issued on British newspapers was $\frac{7}{8}$ millions in 1753, 16 millions in 1800, and 65,741,271 in 1850.

In 1843, the number of newspapers published in London was 79; at present, it is about 230. The increase in the circulation of the individual newspapers is, however, greatly more than the increase in the number of newspapers. A few of the daily papers have attained a circulation of 70,000, and some of the weeklies a still larger circulation. The *Times*, which wields a far greater political influence

than any other paper, hardly circulates 60,000 copies daily. Of the London papers, twenty are published daily, some of them being, however, mere reprints of the morning paper, with what further news has been received during the day. Four are purely commercial. Of the remaining fifteen, four profess Conservative principles, and ten Liberal of various shades. The *Times* professes to be Independent. One daily paper is printed in French. The prices of the daily papers vary from $\frac{1}{4}$ d. to $\frac{3}{4}$ d. Of the 210 newspapers not daily, most are published once, some twice, some three times a week, and some once a fortnight. They comprise 8 agricultural, 9 sporting, 12 commercial, and 5 railway journals; 9 papers purely literary, or literary and scientific, 5 military, 4 musical, 2 theatrical, 4 photographic, 2 electrical, 4 chemical, 7 legal, and 4 medical. There is a *Court Chronicle*, a *Court Circular*, and a *Court Journal*, a French, a German, an Anglo-American, and a Russian weekly paper. There are 6 pictorial, and 2 humorous papers. Of the remaining weekly papers, but a few possess strong political principles, most devote themselves to the spread of general intelligence. The bakers, drapers, grocers, and pawnbrokers have their respective journals; the builders and booksellers have each three; and there are many newspapers with a purely local circulation, some confined to the obscurer quarters of London. The price of the weekly papers varies from $\frac{6}{12}$ d. to $\frac{1}{12}$ d. or $\frac{1}{4}$ d.

The earliest English provincial newspaper is believed to be the *Norwich Postman*, published in 1708, at the price of a penny, but 'a halfpenny not refused.' It was followed, in 1714, by the *Norwich Courant*, or *Weekly Packet*. A *York Courant*, *Leeds Courant*, and *York Journal* were established about 1720; the *Manchester Gazette* in 1730, and the *Oxford Journal* in 1740. In 1843, 212 newspapers were published in provincial towns of England, and 8 in Wales. The provincial newspapers of England now number about 680, besides 37 belonging to Wales, and 14 to the Channel Islands. About a fifth of the number profess Conservative or Liberal-Conservative principles, a half Liberal, a small number perfect independence in politics, and the rest are avowedly neutral. More than half do not exceed $\frac{1}{12}$ d. in price, and there are but a very few conducted with anything like ability. The news are for the most part taken from the London papers, and a characteristic feature of many second-class provincial papers is a column of gossip or scandal, entitled a letter 'From Our London Correspondent.'

The newspaper press of Scotland began during the civil wars of the 17th century. A party of Cromwell's troops, who arrived at Leith in 1652 to garrison the citadel, brought with them a printer named Christopher Higgins, to reprint the London paper, *Mercurius Politicus*. The first number was issued on the 26th October 1653, and in November 1654 the establishment was transferred to Edinburgh, where the reprinting went on till 1660. On the 31st December 1660, the first number was published of the *Mercurius Caledonius*, which professed to furnish information regarding the 'affairs in agitation in Scotland, with a survey of foreign intelligence.' It lived only three months, and was succeeded by *The Kingdom's Intelligencer*. The *Edinburgh Gazette*, an official paper published by authority, was established in 1669 by James Watson, a printer of eminence and skill. In 1708, Watson also started the *Edinburgh Courant*, which only attained its 55th number, and in 1708 the *Scots Courant*. In 1718, the town-council of Edinburgh gave a privilege to James M'Ewan to print the *Edinburgh Evening Courant* three times a week, on

condition that before publication he should give 'ane coppie of his print to the magistrates.' This paper is yet flourishing as the principal Conservative journal in Scotland. The still surviving *Caledonian Mercury* was first published on the 28th of April 1720. The *Scotsman* came into existence in 1817, under the conduct of Mr Charles M'Laren, and, for a short time, of Mr J. R. M'Culloch, the political economist. The earliest Scottish provincial newspaper was the *Glasgow Courant*, established in 1715. The *Glasgow Herald*, established in 1803, and the *Scotsman*, in Edinburgh, are understood to have the largest circulation among Scottish daily newspapers. The *Aberdeen Journal* was founded in 1746 by Mr James Chalmers; the first number contained an account of the battle of Culloden. The number of newspapers published in Scotland in 1843 was 69; it is now 154, 19 of that number belonging to Edinburgh. A few of the leading newspapers of Scotland contain articles approaching in talent to those of the best English newspapers, and exercise considerable political influence, at least in matters relating to Scotland. 18 of the Scottish papers are regarded Conservative, 91 Liberal, 14 Independent, and the rest neutral in politics. Of the whole 155, ten only are daily papers, four of the ten being published in Edinburgh, three in Glasgow, two in Dundee, and one in Greenock. The price of the daily papers is $\frac{1}{12}$ d., that of the weeklies and bi-weeklies varies from $\frac{1}{4}$ d. to $\frac{1}{12}$ d.

In Ireland, a news-sheet, called *Warranted Tidings from Ireland*, was printed during the rebellion of 1641; but the first Irish newspaper, properly so called, was the *Dublin Newsletter*, commenced in 1685. *Pue's Occurrences*, a Dublin daily paper, originated in 1700, was continued for half a century. It was followed, in 1728, by another daily paper, *Faulkner's Journal*, established by George Faulkner, 'a man celebrated for the goodness of his heart, and the weakness of his head.' The oldest existing Dublin newspapers are *Saunders'* (originally *Eadaile's Newsletter*, begun in 1744, and the *Freeman's Journal*, instituted under the name of the *Public Register* by Dr Lucas, in 1755. The *Limerick Chronicle*, the oldest Irish provincial paper, dates from 1768. Ireland possessed 79 newspapers in 1843, and has now 140. Most of them are characterised by an energy of language, and a strength of political bias, unknown in the other parts of the United Kingdom. About 40 profess Conservative, 40 Liberal, 3 revolutionary, and 11 independent views in politics; 40 are politically neutral. About 12 are avowed supporters of Protestantism, the rest are either Roman Catholic or neutral.

Of the 32 newspapers belonging to the Channel Islands, the Isle of Man supports 2 Conservative, 1 Liberal, and 1 neutral journal. Jersey has 6 journals, 3 printed in French and 3 in English. 3 are Liberal, a fourth Conservative, and a fifth Liberal-Conservative. Guernsey has an official Gazette printed in French, which is Protestant and Liberal, besides a Liberal and a Liberal-Conservative paper.

In the British colonies, newspapers are numerous, including some in India, printed in the Bengalee and other native languages. *Hickings Gazette*, the first Anglo-Indian newspaper, appeared at Calcutta in 1781; it was followed, in 1784, by a small official sheet, the *Calcutta Gazette*, or *Oriental Advertiser*. The still surviving *Bengal Hurkuru* was established in 1795. In the earlier times of Indian newspapers, though there was no direct censorship, exemplary punishment was often inflicted on the authors of offensive paragraphs. In 1794, Mr Ducane, editor of the *World*, was transported to Europe for an inflammatory address to the army which appeared

in his paper; and a similar result followed, in 1798, to another editor, who made some severe observations on the official conduct of a local magistrate. A censorship, established by Lord Wellesley in 1799, was abolished by the Marquis of Hastings in 1818; but a licence, revocable at pleasure, was required to be taken out by every printer of a newspaper. In 1832, the Indian press consisted of 6 European and 5 native journals. The licensing system was done away with by Lord Metcalfe's law of 1835, a step disapproved of by the East India directors. Lord Metcalfe's law remained in force till the sepoy mutiny, since which event there has been a return to the system of licences. In 1855, from 55 to 60 newspapers were published in the native languages of India.—The first Australian paper was the *Sydney Gazette*, founded in 1803 by George Howe, a Creole of St Kitts. Hobart Town had its journal in 1804, and in 1824 newspapers began to multiply in the Australian colonies. The principal are now the *Sydney Herald*, the *Sydney Monitor*, the *Argus* of Melbourne, and the *South Australian Gazette*. The materials for printing this last-named paper were carried out by the original South Australian colonists, the first number having been previously printed in England. A similar course was adopted by the first New Zealand colony in 1839, in founding their *New Zealand Gazette* and *New Zealand Advertiser*. Several English newspapers are published in the Sandwich Islands, and Tahiti has, since 1844, had its *L'Océanie Française*.

France.—The earliest French newspaper is said to have been established by Théophraste Renaudot, a physician, in the beginning of the 17th century. The first number of his *Gazette* appeared in 1631. In the following year, through interest of Cardinal Richelieu, he obtained a royal privilege for his *Gazette*; it was continued weekly up to 1762, and then began to appear twice in the week, and to combine advertisements with public news. Commercial intelligence was added in 1765, and in 1792, theatrical announcements. In 1650 was started the *Gazette Burlesque*, a journal in verse, edited by the poet Jean Loret, devoted in a great measure to the *Chronique Scandaleuse* of Paris; and in 1672, the *Mercurie Galant*, a political and literary journal, which afterwards became the *Mercurie de France*, and was continued during the Revolution, and down to 1815. The first French daily newspaper was the *Journal de Paris*, which began in 1777, and was discontinued in 1819. A large crop of journals sprang into being with the Revolution, organs respectively of Republicans, Jacobins, and Royalists, but most of them had a very brief existence. Under the first Napoleon the freedom of the press was much restricted. By one of his earliest ordinances as First Consul, all the newspapers were suppressed except 13, and under the Empire the tolerated journals were allowed to be little more than echoes of the official *Moniteur*. From the danger which attended the handling of political questions, arose the practice of filling a large portion of the sheet with the 'Feuilleton,' consisting of a sketch or tale by a popular writer, which has ever since been a characteristic of French journalism. During the Restoration period, the press being again less fettered, there was a large increase in the number of newspapers. In 1826, there were 127, and in 1829, 307 newspapers published in Paris. The July Revolution at first added still further to their number; but the restrictive measures of 1834, consisting in the imposition of a stamp-duty, and of an obligation to find security to the amount of 24,000 francs, led to the collapse of a large proportion of the then existing journals. The *Moniteur*, *Débats*, and *Presse* were in possession of the government,

and for a time also the *Constitutionnel*, and every shade of political opinion had its recognised organ. Emile de Girardin's scheme of widening the circulation of the government organ, the *Presse*, by bringing down the subscription price from 80 to 40 francs, had the result of reducing the price of the opposition journals also. Cheap newspapers being thus established, it soon appeared that with the class among whom they circulated most widely the feuilleton was regarded of more importance than the political article, and it thus became the policy of the journalists to pay enormous sums to the cleverest novelists of the day, in order to retain them in their service. 100,000 francs paid by Dr Véron of the *Constitutionnel* to Eugène Sue for his *Juif Errant*, turned out as profitable a speculation for the journalist as for the novelist.

The Revolution of 1848, like the revolutions that had gone before it, gave birth to a multitude of short-lived journals. General Cavaignac suppressed some, and extinguished others, by a return to the system of sureties. Under the present emperor as president, a law was passed obliging the author of every newspaper article to affix his name to it. In February 1852, the press laws were incorporated with increased stringency into a *Décret organique sur la presse*. The newspapers, with exception of *La Presse*, have risen to their old prices. There are now 14 daily papers published in Paris, the most important being the *Siècle*, *Presse*, *Constitutionnel*, *Patrie*, *Débats*, and the official *Moniteur*. The French provincial papers are destitute of all weight, political or literary.

Belgium.—In the Low Countries an illustrated war gazette, called the *Nieuwzijdjnghe*, was first published in 1605; it was the precursor of the *Gazette van Antwerpen*, which survived till 1805. During the Spanish and Austrian rule, each town had its privileged newspaper, but the press was considerably fettered in the expression of political opinion. Under the French rule, most of these journals disappeared or sunk into insignificance. The *Annales Politiques* was a political journal of considerable popularity during last century. Since the Revolution of 1830, the press has been subject to few restraints, the newspapers have been numerous, and some few of them well conducted. The *Indépendance Belge* has a large circulation, and exercises considerable political influence. It is the property of a company of bankers, and is conducted by a Frenchman of talent and liberal sentiments. The *Moniteur Belge* was instituted as the official organ of the ministry in 1830. The organ of the government is now the *Echo du Parlement*; it is in politics what is there called 'anti-Catholic,' that is, anti-ultramontane. A larger circulation is enjoyed by the *Journal de Bruxelles*, the *Emancipation*, and the *Echo Belge*, three papers in the interest of the *parti prêtre*, and supplied abundantly with correspondence from Rome. The *National* is a republican journal, bombastic and extravagant in character. The *Précurseur d'Anvers*, and the *Écœut* of Antwerp, have also a considerable circulation—the latter is at once ultramontane and ultra-democratic.

Holland.—The earlier newspapers of Holland were in some respects, particularly in the accuracy of their information, in advance of those of other countries, but gave far more prominence to commercial than to political intelligence. They all bore the name of *Courant* appended to the name of the town where they were published. Though subject to no censorship since 1815, it was not till 1830 that they began to comment on political occurrences. At present the principal Dutch journals are the *Algemeene Handelsblad* of Amsterdam, the *Harlemsche Courant*, and the *Journal de la*

Haye and Staats Courant—both published at the Hague.

Switzerland.—Switzerland being a confederation of states, each with its own institutions, the Swiss newspapers have always had a very local character; but they are numerous, and some of those belonging to the more important cantons, particularly Berne, Zürich, Basle, Aargau, Geneva, have of late years greatly improved in character.

Germany.—Though in Germany the *Relationen*, above alluded to, were in some sort the precursors of newspapers, yet no serial newspaper, properly so called, seems to have existed till 1615. Frankfurt was the first town that possessed its journal; next followed Fulda, Hildesheim, and Herford. The earliest Leipzig newspaper was instituted in 1660. The first newspaper with a staff of foreign correspondents was the *Hamburgische Correspondent*; but no German newspaper can be said to have had any political weight till the institution of the *Allgemeine Zeitung*, founded by Cotta in 1798, which still takes rank as the first paper in Germany. It first appeared at Tübingen, and after changing its place of publication to Stuttgart and Ulm, eventually removed to Augsburg. During French ascendancy, the German papers were little more than echoes of the Parisian; but a number of journals of a more national character sprung up during the war of liberation. The abuse of the liberty of the press after 1830, led to the imposition by the diet of restrictions of a somewhat severe character on newspapers. The multitudinous journals of 1848 vanished very speedily; but within the last ten years there has been a decided advance in the character, literary and political, of the German newspapers, and more freedom of discussion has latterly been allowed. The advance has of late been most marked in the newspaper press of Austria. The leading papers of Vienna, the *Ost Deutsche Post*, *Wiener Zeitung*, and *Oesterreichische Zeitung* are, both in a literary and political point of view, greatly improved. In Prussia the *Berliner Privilegierte Zeitung*, the *Berlinsche Nachrichten*, and the *Kölnische Zeitung*, the principal journal of the Rhenish provinces, are conducted with fair ability. The *Neue Preussische Zeitung* of Berlin, better known as the *Kreuz Zeitung*, is the most important organ of the reactionary party.

Italy.—We have mentioned the early *Notizie Scritte* or *Gazettes* of Venice. The news-sheets which followed them were in disfavour with the see of Rome; and a memorable bull denouncing them was issued by Gregory XIII. Up to 1847, the newspapers of Italy were small, politically insignificant, and subject to a strict censorship. With the accession of Pope Pius IX., a flood of political journals made their appearance, one or two of which only were conducted with any approach to talent, and few lasted above a year. In the Sardinian dominions there continued to be no fewer than 45 political papers published in 1852, 41 of which were printed in Italian and 4 in French. Of that number a great many soon afterwards collapsed. The removal of the former restrictions of the press in other parts of the Kingdom of Italy has started into life a number of newspapers. Seventeen political and ten partially political papers are now published in the dominions of Victor Emmanuel, besides 31 periodicals, many of which answer more or less to our ideas of a newspaper. Few of these newspapers are as yet of much promise. The leaders are poor, no great social or commercial questions are discussed, and each journal is the mere advocate of one or other of the political parties. The best of them, on the whole, is the *Nazione* of Florence, which may be compared to some of the second-rate French papers. *L'Opinione* is the ministerial organ,

L'Armonia and *La Civiltà Cattolica* belong to the 'Neri' and 'Codini,' and *Il Dritto* and *L'Unità Italiana* are the acknowledged organs of the Mazzini party. Humorous newspapers, after the model of our *Punch*, are abundant. In Rome, the principal newspaper is the *Giornale di Roma*, the chief periodical of the 'Neri,' small in size, and containing only what public news the government thinks it prudent to circulate.

Spain.—Sheets called *Relaciones*, giving accounts of important occurrences, used to appear in Spain at irregular intervals in the 17th c., occasionally in the form of romances; but no Spanish newspaper, properly so called, existed till last century, and fifty years ago Madrid possessed but one journal. The first approach to political journalism followed in the wake of the Peninsular War and the establishment of the Cortes. The gross licence with which many of the then established papers were conducted, led, in 1824, to the suppression of all except the *Diario* and *Gaceta* of Madrid, the *Gaceta de Bayona*, and a few which were purely commercial or scientific. At present, about 40 journals are published in Madrid, politically and in every other respect very unimportant; the most read are the *España* and *El Clamor Público*. The press of Portugal is as insignificant: the official organ is the *Diario do Governo*.

Sweden and Norway.—The earliest Swedish newspaper seems to have been the *Ordinarie Post Tidende*, established in 1643, and continued till 1680. It was followed by the *Relationes Curiosæ* in Latin (1682—1701). Two French papers, the *Gazette Française de Stockholm* and the *Mercur de Suède*, existed in Sweden in the second half of last century, but politically the newspaper press cannot be said to have had any influence until the establishment of the *Argus* by Johanssen in 1820. For a number of years the principal journals of Sweden were the *Fäderneslandet*, the organ of the royalists, and the *Aftonbladet*, that of the reformers. The latter, on King Oscar's accession, ceased to be an opposition journal. The official paper is the *Post och Inrikes Tidningar*. Every provincial town has now its journal, and there are about 114 newspapers in all published in Sweden. Of the Norwegian papers, the oldest is the *Christiania Intelligentsædler*, founded in 1763. *Den Constitutionelle* is the government journal, and *Den Morgenblad* the organ of the opposition.

Denmark.—In Denmark journalism is still more recent. Up to 1830 only two newspapers were published in Copenhagen, both entirely made up of extracts from foreign journals. Since 1834, there has been an improvement in the character, and increase in the number of the Danish journals. They numbered 36 in 1849. The oldest newspaper now existing in Denmark is the semi-ministerial *Berlingske Tidende*, founded in 1749. The *Fädrelandet* is the journal of the Scandinavian popular party.

Russia.—The earliest newspapers in Russia were published under the personal surveillance of Peter the Great, first in Moscow and afterwards in Petersburg, to report the progress of the war with Sweden. Political journalism, properly so called, has, however, never flourished in Russia, and has, in fact, only been allowed in important political crises—as the French invasion of 1812, the Polish insurrection of 1830, and recently during the Crimean War, when the journalists were allowed to exercise their ingenuity in defending the government policy. The largest circulation was at that time attained by the *Sjævernaja Ptsch'eta*, or 'Northern Bee,' which had its feuilleton. Generally speaking, the Russian newspapers occupy themselves with scientific and literary

subjects rather than public or political news. The *Journal de St Petersburg*, in French, is the organ of the court, and has considerable circulation out of Russia.

Turkey.—The first newspaper in Turkey was founded, in 1795, by M. Verminhac, envoy-extraordinary of the French government to the court of Selim III, and printed in French at Pera. A Frenchman of the name of Blacque established at Smyrna, in 1825, the *Spectateur de L'Orient*, afterwards the *Courrier de Smyrne*, which had considerable political influence during the Greek war. The same M. Blacque afterwards edited the official journal of the Porte, called the *Moniteur Ottoman*, which has, since 1832, been reprinted in Turkish under the name of the *Taqutmi Vaqdi*. The *Taqutmi* was till lately a very badly printed sheet, but it has much improved, and now issues weekly instead of monthly, sometimes containing very fair literary and political articles. But the most important Turkish paper is the *Djeridei Havadis*, founded in 1843 by Mr Alfred Churchill, an Englishman born in Turkey, who is still its conductor and owner. It embraces a great variety of matter, a court gazette, official appointments, home and foreign news, advertisements, prices of stocks, and a feuilleton. There are besides in Constantinople two new and popular papers, called the *Terguman Ahwal*, or 'Interpreter of Events,' published three times a week, and the *Tas veeri Evkiar*, or 'Mirror of Thoughts,' published twice a week. The latter has a scientific and literary repute. The Turkish papers have no leading articles, and from the constitution of political society in Turkey, there can be no avowed opposition to the policy of the government. The Turkish capital possesses also an Armeno-Turkish paper, printed in the Armenian character; an Arabic, and an Italian paper; as also the *Commerce de Constantinople* and *Courrier de Constantinople* in French.

Greece.—Various newspapers in modern Greece appeared at Paris and Vienna before Greece obtained her independence; but the first political journal published in Greece was the *Hellenikis Salpigis*, founded in 1824, and soon followed by the *Hellenika Chronika* and *Hellenikos Telegraphos* in Missolonghi, the *Philos tou nomou* at Hydra, the *Ephemerides Athenaikai* at Athens, and the official *Genikis ephemeristis Hellados* published at Nauplia, with its opponent the *Apollon*, which afterwards became the *Athena*. Most of these papers disappeared in 1833 on the system of sureties being introduced. The *Soter* was established as the government organ in 1833. From fifty to sixty newspapers are now published in Greece, the largest number in Athens, and several in the Ionian Islands. Generally speaking, the Greek papers make no endeavour to lead the parties in the state, but are rather distinguished by a blind subserviency to their passions and extravagances.

American States.—In America, the earliest newspaper was the *Boston Newsletter*, founded in 1704, insignificant in size and contents, and conducted by John Campbell, the postmaster of the town. A rival to it appeared, in 1719, in the *Boston Gazette*, 'published by authority.' The *Boston Newsletter*, however, thrived in spite of opposition. With the name changed to the *Massachusetts Gazette and Boston Newsletter*, it was the support of the British rule against the desire for independence, and ceased to appear when the British troops evacuated Boston. The *New England Courant*, established in 1721, was at first printed by James Franklin, and afterwards edited by his brother the famous statesman. It lasted but six years, but a subsequent newspaper, entitled the *Pennsylvania Gazette*, was started by

Benjamin Franklin in 1729, and continued weekly till 1765. *Ede's Boston Gazette*, begun in 1755, was for a long time the chief organ of the popular party, and conducted with considerable talent; in it appeared John Adams's 'Letters of Novanglus.' The *Massachusetts Spy* was another paper of note on the revolutionary side. After being temporarily removed from Boston to Worcester, and suspended for a couple of years, it was resumed, and is still in existence. At the revolution, the New England colonies possessed 13 newspapers; Pennsylvania, 8; New York, 3; and the middle and southern colonies, 10. All were published weekly. In 1861, there were 450 daily papers in the union, three quarters of them being in the non-slaveholding states. At present there are in the state of New York alone 72 daily papers and 851 periodicals, a few of which are monthlies, not coming under the denomination of newspapers. The largest circulation is enjoyed by the *New York Herald*, a journal generally in possession of the earliest news on matters of finance and trade, but which is allowed on all hands to have risen to importance by a system of personal abuse and blackmail. Next in point of circulation is the *Tribune*, the leader in so-called reforms, which, notwithstanding its extreme politics, is, according to our notions, more respectable. The *New York Times*, on the same political side, is considered less scrupulous. The *Journal of Commerce*, a democratic (i. e., Conservative), and, in some measure, Puritan paper, and the *Freeman's Journal*, were noted for standing firm against the present war (1864) and in favour of state rights, in consequence of which they were excluded from the mails and virtually suppressed. The editor of the *Freeman's Journal* was eventually imprisoned in Fort Lafayette. The new school of Puritans (the party represented by the Rev. Mr Beecher), whose characteristic is to intensify all popular movements, has also its organ, the *Independent*.

All the other numerous journals of the American States are, compared with those of New York, accounted provincial. The state of Illinois has 453 periodicals, of which 28 are daily newspapers. California has 17 daily and 87 weekly papers. Nashville, in Tennessee, with a population of 23,000 inhabitants, had, at the beginning of the civil war, 21 periodicals, 4 of them daily papers; and New Orleans, with a population of 170,000, had 48 periodicals, including 8 daily papers. Each county, comprising, on an average, 360 square miles, has generally two or three papers—one being republican, another democratic, and if there is a third, it is probably the organ of some religious or other sect. These papers, sold at a very low price, are, in a great measure, filled with local and quack advertisements. The printer is, in most cases, the editor, and the village lawyer supplies leaders seasoned with coarse and personal invective. Some of them have been successfully started with no larger a capital than £100 of borrowed money.

There is an immense collection of newspapers in the British Museum, which belonged in part to the library of Sir Hans Sloane, in part to that of Dr Charles Burney. See Andrews's *History of British Journalism*, London, 1859.

NEWT, or EFT (*Triton*), a genus of batrachians of the family *Salamandridæ*, more aquatic in their habits than the salamander, to which, in form and characters, they are very similar, having an elongated body and tail, and four small weak limbs. The tail is vertically compressed, and a crest is often developed on the back and tail, but the crest is characteristic of the males in the breeding season, and the tail becomes rounded when the animals leave the water, as they often do, particularly in

the latter part of summer or in autumn; which, along with other variations apparently dependent on circumstances, have caused no little multiplication of specific names. The most abundant British species is the COMMON N., or SMOOTH N. (*T. punctatus*, *Lisocriton punctatus*, or *Lophinus punctatus*), which is from $\frac{3}{4}$ to 4 inches long, brownish gray above, yellowish beneath, spotted with black, with a soft, smooth skin, and two bands of pores on the head; a well-known inhabitant of stagnant pools and ditches, often found also under stones and in other damp situations. The WARTY N. (*T. palustris*, or *crispatus*), also pretty common, is 5 or 6 inches in length, blackish brown above with round spots of a darker tint, bright orange or orange-yellow with black spots on the under parts, the sides dotted with white, and the tail often exhibiting a white band, the skin rough or warty, and with many pores. The dorsal and caudal crests of the Warty N. are separate; those of the Common N. are united. Many other species occur in other parts of the world. They all feed on animal food, of which tadpoles and aquatic insects form the chief portions. They deposit their eggs on the leaves of aquatic plants, each egg separately, twisting or folding the leaf with their feet so as to conceal the egg, which is surrounded by a viscous substance, so that the leaf is retained in this form. The transformations of newts are noticed, and illustrations given, in the article **BATRACHIA**. They very frequently change their skin. They possess, in an extraordinary degree, the power of reproducing lost members—a limb, a tail, even an eye—in every respect perfect. Spallanzani, who made many observations on this subject, found that the same member could be reproduced a number of times successively. Newts are also capable of surviving, although long frozen up in ice, and return to activity when a thaw takes place. A strong and almost universal popular prejudice exists against them as most noxious animals, although they are not in the slightest degree venomous. They have recently, however, begun to be more favourably regarded in consequence of the frequency of aquaria, of which they are interesting inmates.—It is a curious fact that Linnæus, contrary to his usual discriminating penetration, confounded newts with lizards, which they resemble merely in form, differing widely in the most important characters. That they are often confounded by the unscientific is not wonderful.

NEWTON, SIR ISAAC, the most remarkable mathematician and natural philosopher of his own or perhaps of any other age, was born at Woolthorpe, in Lincolnshire, in the year 1642. That year, remarkable in English history for the breaking out of the civil war between Charles I. and the parliament, is doubly remarkable in the history of science by the birth of N. and the death of Galileo. The circumstances with which the pursuit of truth, in scientific matters, was at this time surrounded in the respective countries of these great philosophers, were not more different than the characters of the philosophers themselves. Galileo died a prisoner, under the surveillance of the Inquisition, 'for thinking, in astronomy,' as Milton says, 'otherwise than the Franciscan and Dominican licensers thought.' In England, it had become the practice, and soon became the fashion, through the influence of Bacon and Descartes, to discard altogether the dictates of *authority* in matters of science. The dispositions of the two philosophers were happily suited to the situations in which they thus found themselves. Galileo's was a mind whose strength and determination grew by the opposition it encountered. The disposition of N., on the other hand, diffident of the value and interest of his own

labours, and shrinking from the encounter of even scientific controversy, might have allowed his most remarkable discoveries to remain in obscurity, had it not been for the constant and urgent solicitation of his friends that they should be published to the world.

N. received his early education at the grammar school of Grantham, in the neighbourhood of his home, at Woolthorpe. On the 5th of June 1661, he left home for Cambridge, where he was admitted as subsizar at Trinity College. On the 8th of July following, he matriculated as sizar of the same college. He immediately applied himself to the mathematical studies of the place, and within a very few years must have not only made himself master of most of the works of any value on such subjects then existing, but had also begun to make some progress in the methods for extending the science. In the year 1665, he committed to writing his first discovery on fluxions; and it is said that in the same year, the fall of an apple, as he sat in his garden at Woolthorpe, suggested the most magnificent of his subsequent discoveries—the law of universal gravitation. On his first attempt, however, by means of the law so suggested to his mind, to explain the lunar and planetary motions, he employed an estimate then in use of the radius of the earth, which was so erroneous as to produce a discrepancy between the real force of gravity and that required by theory to explain the motions, corresponding to the respective figures 16:1 and 13:9. He accordingly abandoned the hypothesis for other studies. These other pursuits to which he thus betook himself, consisted chiefly of investigations into the nature of light, and the construction of telescopes. By a variety of ingenious and interesting experiments upon sunlight refracted through a prism in a darkened apartment, he was led to the conclusion that rays of light which differ in colour, differ also in refrangibility. This discovery enabled him to explain an imperfection of the telescope, which had not till then been accounted for. The indistinctness of the image formed by the object-glass was not necessarily due to any imperfection of its form, but to the fact of the different coloured rays of light being brought to a focus at different distances. He concluded rightly that it was impossible for an object-glass consisting of a single lens to produce a distinct image. He went further, and too hastily concluding, from a single experiment, that the dispersive power of different substances was proportional to their refractive power, he pronounced it impossible to produce a perfect image by a combination of lenses. This conclusion—since proved erroneous by the discovery of the achromatic telescope by Mr Chester More Hall, of More Hall, in Essex, about 1729, and afterwards, independently, by Mr Dollond in 1751—turned N.'s attention to the construction of reflecting telescopes; and the form devised by him is the one which, at later periods, reached such perfection in the hands of Sir William Herschel and Lord Bossa.

It was on the 11th January 1671 that N. was elected a member of the Royal Society, having become known to that body from his reflecting telescopes. At that period he resumed his calculations about gravitation, employing the more correct measure of the earth obtained by Picard in 1670, does not clearly appear; but it was in the year 1684 that it became known to Halley that he was in possession of the whole theory and its demonstration. It was on the urgent solicitation of Halley that he was induced to commit to a systematic treatise these principles and their demonstrations. The principal results of his discoveries were set down in a treatise called *De Motu*

Corporum, and were afterwards more completely unfolded in the great work entitled *Philosophiæ Naturalis Principia Mathematica*, which was finally published about midsummer 1687.

Shortly before the *Principia* was given to the public, N. had been called to take an active part in defending the rights of the university against the illegal encroachments of James II. The conspicuous part which he had taken on that occasion procured him a seat in the Convention Parliament, in which he sat from January 1689 to its dissolution in 1690. In 1696, he was appointed Warden of the Mint, and was afterwards promoted to the office of Master of the Mint in 1699, an office which he held till the end of his life. He again took a seat in parliament, in the year 1701, as the representative of his university. Thus engaged in the public service, he had little time left for mere scientific studies—pursuits which he always held of secondary importance to the public duties in which he was engaged. In the interval of public duty, however, N. shewed that he still retained the scientific power by which his great discoveries had been made. This was shewn in his solution of two celebrated problems proposed, in June 1696, by John Bernoulli, as a challenge to the mathematicians of Europe. A similar mathematical feat is recorded of him so late as 1716, in solving a problem proposed by Leibnitz, for the purpose, as he expressed it, of feeling the pulse of the English analysts. When in parliament, N. recommended the public encouragement of the invention of a method for determining the longitude—the first reward in consequence being gained by John Harrison for his chronometer. He was President of the Royal Society from 1703 till his death, a period of twenty-five years, being each year re-elected. In this position, and enjoying the confidence of Prince George of Denmark, he had much in his power towards the advancement of science; and one of his most important works during this time was the superintendence of the publication of Flamsteed's *Greenwich Observations*—a task, however, not accomplished without much controversy and some bitterness between himself and that astronomer. The controversy between N. and Leibnitz, as to priority of discovery of the differential calculus, or the method of fluxions, was raised rather through the partisanship of jealous friends, than through the anxiety of the philosophers themselves, who were, however, induced to enter into and carry on the dispute with some degree of bitterness and mutual recrimination. The verdict of the impartial historian of science must be, that the methods were invented quite independently, and that, although N. was the first inventor, a greater debt is owing by later analysts to Leibnitz, on account of the superior facility and completeness of his method. The details of these controversies, with all other information of the life of this philosopher, will be found admirably collected in the *Life* by Sir D. Brewster, who writes with not only an intimate acquaintance with N.'s works, but in the possession of all the materials collected in the hands of his family. N. died on 20th March 1727, and his remains received a resting-place in Westminster Abbey, where a monument was erected to his memory in 1731. A magnificent full-length statue of the philosopher, executed by Roubiliac, was erected in 1755 in the antechapel of Trinity College, Cambridge. This work was assisted by a cast of the face taken after death, which is preserved in the university library at Cambridge. In 1699, N. had been elected a foreign associate of the Academy of Sciences, and in 1703, he received the honour of knighthood from Queen Anne. Among the best editions of N.'s principal works are the

quarto edition of the *Optics* (Lond. 1704), and the quarto edition of the *Principia*, published at Cambridge in 1713.

NEWTON, THOMAS, an English prelate of the 18th c., was born at Lichfield, January 1, 1704. He was educated at Westminster School, and afterwards at Trinity College, Cambridge, where he took the degree of M.A. in 1730, in which year also he was ordained priest. After holding several minor preferments, he was made Bishop of Bristol in 1761, and died 14th of February 1782. Without any remarkable merit, N. has, one cannot well say how, succeeded in obtaining a place in literary history. His two productions, whose fortunes have surpassed their deserts, are an edition of *Milton's Paradise Lost* (2 vols. 1749), with a memoir of the poet, and critical and explanatory notes; and *Dissertations on the Prophecies* (3 vols. 1754—1758). Besides these, he wrote occasional sermons, and a host of scriptural dissertations, the theology of which is reckoned not always 'orthodox.'

NEWTON, a township in Massachusetts, United States of America, on Charles River, eight miles west of Boston. It contains two villages, Upper Falls and Lower Falls, with five paper-mills, a cotton factory, a Baptist theological seminary, and 12 churches. Pop. (1860) 8382.

NEWTON-ABBOT, a market town of England, in the county of Devon, beautifully situated in a vale on the river Lemon, 15 miles south-south-west of Exeter. The portion of the town called Newton-Bushel is on the left side of the stream. It has been undergoing considerable improvements within recent years. William of Orange, after landing at Torbay, in 1688, made his first public declaration here. Pop. (1861) 5221.

NEWTON-IN-MAKERFIELD, a thriving manufacturing and market town of England, in Lancashire, 15 miles west of Manchester, on the Manchester and Liverpool Railway. Two large iron foundries, as well as printing, paper and sugar works, an oil-distillery, and a brick, tile, and pot manufactory are in full operation. There is a beautiful lake in the town, called Newton Mere, which is covered during the summer months with the pleasure-boats of the townspeople. Horse-races are held here in June, and horse and cattle fairs in May and August annually. The election of M.P.'s for South Lancashire takes place in Newton. Cotton and flour mills, iron foundries and glass-works are in operation; and bricks are made. Pop. (1861) 5909.

NEWTON-UPON-AYR, a burgh of barony and parish of Scotland, in the county of Ayr, on the north side of the river Ayr, and united with the town of that name by three bridges. See AYR. Pop. of burgh, 4807. N. has ship-building docks, roperies, and iron and brass foundries. It exports 100,000 tons of coal annually.

NEWTON'S RINGS. In his investigations of the colours produced by thin plates of any material, solid, fluid, or gaseous, Sir Isaac Newton hit upon the following mode of exhibiting the colours produced by a film of air. He took two lenses, one convexo-plane, its convex side having a radius of 14 feet, the other equi-convex, with the radii of its surfaces 50 feet, and laid the first with its plane surface downwards on the top of the second, thus producing a thin film of air between the lenses; the film being thinnest near the centre, and becoming gradually thicker outwards. On slowly pressing the upper lens against the under one, a number of concentric coloured rings, having the point of contact of the lenses for their centre, appeared, and increased in size when the pressure was increased.

These rings, or more properly systems of rings, are seven in number, and each of them is composed of a number (ranging from eight in the first or smallest ring, to two in the outermost) of rings of different colours, the colours, though different in each of the systems of rings, preserving the same arrangement as the colours of the spectrum, of which they seem to be modifications; thus, in the second ring the inside colour is violet, and the outside scarlet red. The colours are very distinct in the first three systems of rings, but become gradually confused and dull towards the outside, till they almost fade away in the seventh system. The centre is deep black. The thickness of the air-film at the centre is about half a millionth of an inch, and increases gradually to nearly 100,000 of an inch, when the colours disappear.

NEWTOWN, a modern manufacturing town of North Wales, in the county of Montgomery, 8 miles south-west of the town of that name, on the right bank of the Severn, and on the Montgomery Canal, which connects it with the inland navigation of the country. It is the centre of the flannel manufactures of the county. It has 40 factories, employing in all 960 men. Pop. (1861) 5916.

NEWTOWNARDS, a market town of the county Down, Ireland, 12 miles east from Belfast by railway. Pop. (1861) 9521, of whom 5855 are Presbyterians, 1765 Protestants of the Established Church, and 1139 Roman Catholics, and the rest Protestants of various denominations. It is a neat and well-built town, of considerable trade, and with extensive maulin, flax spinning, and weaving factories. Since the Union, it has ceased to be a parliamentary borough. The affairs of the town are administered by commissioners.

NEWTOWN-LIMAVADY (Ir. *Leim-a-madha*, 'The Dog's Leap'), a market town of the county of Londonderry, Ireland, and 16 miles east-north-east of the town of Londonderry. Pop., in 1861, 2734, of whom 931 are Presbyterians, 873 Catholics, 803 Protestants of the Established Church, and the rest Protestants of other denominations. N.-L., in the period anterior to the establishment of English rule, was the seat of the powerful sept of the O'Caahans, or O'Kanes; and during the wars of the Revolution, owing to its importance as a native stronghold, and its many historical associations, it was the scene of more than one struggle between the followers of James II. and those of William. Its chief importance at present is as a centre of the flax trade, once the staple of that district, and again rising in importance.

NEXT FRIEND is, in English Law, the name given to the person in whose name, or rather by whose agency, an infant—i. e., a person under the age of 21—sues in the courts of law and equity. The object is chiefly to have some party responsible for costs in case the infant fails in the action. In practice, the father, if alive, is usually the next friend, but any substantial person may be so. In the Court of Chancery, a married woman sues or appears by the intervention of a next friend, where she is personally interested.

NEY, MICHEL, a celebrated marshal of the first French empire, was the son of a cooper, and was born at Saarlouis, 10th January 1769. He was a non-commissioned officer in a hussar regiment when the Revolution began, and afterwards rapidly rose to high military rank. For the capture of Mannheim by a *coup de main*, he was made a general of division in 1799. He was interim commander of the army of the Rhine for a short time, during which he frustrated by a bold

diversion an important movement of the Archduke Charles against Massena and the army of Switzerland. After the peace of Lunéville, Bonaparte, anxious to win N., with other republicans, to his party, brought about his marriage with a young friend of Hortense Beauharnais, and appointed him inspector-general of cavalry. On the establishment of the empire, he was made a marshal. In 1805, he stormed the intrenchments of Elchingen, and was created Duke of Elchingen. He afterwards rendered important services in the Tyrol; contributed much to the French successes of 1806 and 1807; and served in Spain with great ability in 1808 and 1809, till he was dismissed by Massena, the commander-in-chief, on a dispute about the plan of the campaign. Chagrined by this, and dissatisfied with Napoleon's despotism, he remained for some time inactive; but in 1812 received the command of the third *corps d'armée*, and greatly distinguished himself at Smolensk and the Moskwa, in consequence of which he was created Prince of the Moskwa. He also displayed great abilities in the French retreat. He had a principal part in the campaigns of 1813 and 1814, but after the capture of Paris, he urged the emperor to abdicate, and submitted to Louis XVIII., who loaded him with favours. On Napoleon's return from Elba, N. assured the king of his fidelity, and was sent against Napoleon at the head of 4000 men; but finding the emperor to be received with general enthusiasm, and his own soldiers to be favourable to his cause, N. went over to his side. In the battle of Waterloo, he commanded the centre, and had five horses shot under him. After the capitulation of Paris, he yielded to the entreaties of his family to retire to Switzerland; but a costly Egyptian sabre, the gift of Napoleon, led to his being suspected by an official, and arrested. He was condemned to death for high treason, and was shot in the garden of the Luxembourg on 7th December 1815. He left three sons, who published his *Mémoires* (2 vols. Par. 1833).

N'GA'MI, LAKE. The existence of lakes in the interior of Africa was vaguely known as far back as the days of Herodotus; and the earliest modern maps, shew at least half-a-dozen large and small, one of which is about the size, and very nearly in the position of that shallow reservoir of surface drainage which was discovered, or at least first visited by a European in 1849, when Dr Livingstone and Mr Oswell, who were aware of its existence from native report, reached its shores by a circuitous route from the Cape Colony. Although since ascertained to be of little importance in the physical geography of these regions, Lake N. was at first supposed to be in some way connected with the larger inland seas of Nyassa, Victoria Nyanza, and Taryanaka. It is situated between the 20th and 21st parallels of S. lat., and between the meridians 22° 10' and 23° 30' E. long., at a height of about 2500 feet above the level of the sea, and is connected by a series of sluggish anastomosing streams with the river-system of the Zambezi; its extent as well as depth varies with the fall of rain in the country to the north of it, but its average size may be taken at 70 miles long, by a breadth of 20 and a depth varying from 3 to 23 feet. In 1853, Lake N. was reached from the west coast near Walfish Bay by the traveller Andersson, and there is now a well-beaten route for traders between these two places, and a considerable quantity of ivory and ostrich feathers are annually collected in the neighbourhood of the lake. The principal characteristics of the region are rivers, with very sluggish current, and often flowing in different directions to and from the lake, large salt-pans and extensive

dry flats, covered with dense bush, the haunt of elephants and other large animals.

In 1855, the well-known sportsman and traveller, F. Green, ascended the River Tonka, which flows into the north-west angle of Lake N., as far north as the town of Lebebe, in 18° 11' lat., and then supposed that a communication existed with the waters of Cuanene, a river of the west coast. If such is the case, it would be a curious phenomenon in physical geography, communicating, as we know Lake N. also does, with the Zambezi, a river of the east coast.

NIAGARA, a river of North America, which flows from Lake Erie northwards into Lake Ontario. It is about 36 miles in length, and its descent from the level of the one lake to that of the other is about 334 feet. On issuing from Lake Erie, it is three-quarters of a mile broad; but as it flows on, it becomes several miles wide, making room for a number of islands, the largest of which, Grand Island, is 12 miles long, and from 2 to 7 broad. At the foot of Grand Island, which reaches within $\frac{1}{4}$ mile of the Falls of N., the river is contracted to a breadth of $\frac{2}{4}$ miles, and grows narrower as it proceeds. By this, and by the descent in the channel, which is about 60 feet in the mile above the Falls, are produced the swift currents known as the Rapids, in which the river, notwithstanding its great depth, is perpetually white with foam. At the Falls, which are 22 miles from Lake Erie, the river is divided by an island containing about 75 acres, called Goat Island; but in consequence of a bend in the channel, by far the larger portion of the water is sent down by the Canadian side. On this side, therefore, is the grander cataract which has been named the Horseshoe Fall, but no longer bears the name appropriately, as the precipice has been worn from a curved into a somewhat angular shape. This process of wearing away goes on gradually still, a large projection on the Canadian bank, known as the Table Rock, having partly fallen off in 1863. The Horseshoe Fall is above 600 yards in breadth, and about 154 feet in height. The water is so deep that it retains its green colour for some distance below the brow of the precipice; and it rushes over with such force, that it is thrown about 50 feet from the foot of the cliff. One may thus, having donned an oil-skin dress, enter two or three yards behind the curved sheet of water; but the spray is so blinding, the din so deafening, and the current of air so strong, that it requires a tolerably calm nerve and firm foot. The separation caused by Goat Island leaves a large wall of rock between the Canadian and American Falls, the latter being again divided by an islet at a short distance from Goat Island. This fall is from eight to ten feet higher than the Horseshoe, but only about 220 yards broad. A little above the Fall, the channel is divided by Bath Island, which is connected by bridges with Goat Island and the American shore. A small tower, approached from Goat Island, has been built on a rock over the brow of the Horseshoe Fall; and from this the finest view on the American side may be obtained, the Table Rock on the Canadian side giving the completest view of the entire cataract. The Falls can also be seen from below on both sides, and every facility is given for viewing them from all the best points, while magnificent hotels, Canadian and American, offer their inducements to the tourist to stay till he has received the full influence of the scenery. The river is crossed about 200 or 300 yards below the Falls, where it is 1200 yards broad. The current is lessened for about a mile, but increases again as the channel becomes narrower and the descent greater. Between three and four miles below the Falls, a

stratum of rock runs across the direct course of the river, which, after forming a vast circular basin, with an impassable whirlpool, is forced away at right angles to its old channel. The celebrated wire suspension-bridge for the Great Western Railway, with a road beneath for vehicles and foot-passengers, crosses the river $\frac{1}{4}$ mile below the Fall; it is 800 feet long, 40 broad, and 200 feet above the surface of the water.

NIAGARA, chief town of Lincoln County, Canada West, is situated on Lake Ontario, at the mouth of the river Niagara, and is distant by water from Toronto 36 miles. Burned down in December 1813 by the American General M'Clure on his retreat, it was afterwards rebuilt, and promised to be a flourishing town; but its trade has fallen off within the last few years, and its population, which was once much larger, had decreased in 1861 to 2070.

NIAS, an important island belonging to Holland, lies to the west of Sumatra, in 0° 18' 54"—1° 35' N. lat., and 97°—98° E. long., and has an area of about 1575 square miles. In 1857, when the Dutch took complete possession of the island, the population was reckoned at 170,000. There are several places where ships can anchor and take in provisions, water, &c. On the east coast is the village Nias, and on the west, Silorongang. Little islands and coral reefs lie here and there on the coast, which in some places is steep, while mountain-chains run from the south-east to the north-west. There is a greater breadth of excellent farming-grounds than the population, reduced by internal wars and the exportation of slaves, can properly cultivate. They grow rice, cocoa-nuts, bananas, tobacco, sugar-canes, &c., and annually about 110,000 lbs. of pepper. Cattle and horses have been imported, and they pay great attention to the raising of pigs and fowls. Formerly, about 500 Niassers were carried away annually as slaves to Batavia and other places, and though this traffic has been in a great measure suppressed, it is still to some extent carried on.

The Niassers are of the Malay race, but fairer than the Malays usually are. They are gentle, sober, and peaceful, remarkably ingenious in handicraft, ornamenting their houses with wood-carvings, forging arms, &c. The women labour in the fields, the children weave mats, while the men look after the live-stock, and hunt the deer and wild swine. They worship a superior deity, and fear a powerful one, who pursues them if they do evil. Polygamy is permitted, but is rare. The gift to the bride's family is from 60 to 500 dollars. Divorce is not allowed, and adultery is punished by the death of both parties. Dead bodies are placed in coffins above the ground, and creepers and flowering shrubs planted, which speedily grow up and cover them. Trade is on the increase.—See *Malayan Miscellanies*, vol. ii.; *Het Eiland Nias*, door H. J. Domis; *Crawford's Descriptive Dictionary* (London, 1856); *Tydschrift voor Ned. Indië*, 1854, 1860, &c.

NIBBY, ANTONIO, a Roman archæologist of high celebrity, was born in 1792. He was one of those who, following in the footsteps of Winkelmann, made an elaborately minute investigation of the remains of antiquity their special study. The first work that made him known was his translation of Pausanias, with antiquarian and critical notes. In 1820, he was appointed Professor of Archæology in the University of Rome. In the same year appeared his edition of Nardini's *Roma Antica*; and in 1837—1838, he learned and admirable *Analisi Storico-topografico-antiquaria della carta de Contorni di Roma*, to which was added (1838—1840) a description of the city of Rome itself. Among his other writings, may be mentioned his *Le Mura di Roma disegnate*

da W. Gell, and a large number of valuable treatises on the form and arrangement of the earliest Christian churches, the Circus of Caracalla, the Temple of Fortuna at Præneste, the graves of the Horatii and the Curatii, &c. N. died 29th December 1839.

NIBELUNGENLIED, or '*Nibelunge Not*,' as the words are written in the oldest manuscripts, is one of the most finished specimens of the genuine epic of Germany belonging to the middle ages. There exist twenty more or less perfect manuscript copies of this curious poem, the earliest of which belong to the beginning of the 13th c., from which period till the middle of the 16th c. it enjoyed the greatest popularity among Germans of all classes. Nothing certain is known of the author or authors of the work beyond the fact, that it was put into its present form by a wandering minstrel in Austria about or prior to the year 1210, which is the date of the oldest accredited manuscript. According to W. Grimm and Lachmann's critical analysis of the poem, it is in itself a compilation of pre-existing songs and rhapsodies, strung together into one whole upon a plan remarkable for its grand simplicity, although less skill is shewn in some instances in the manner in which the several parts are connected. In the more authentic manuscripts the poem consists of only twenty parts, and it is conjectured that the latter portions of the epic, which are given only in some of the texts, as that of St Gall, are the composition of later compilers. The epic cycle embraced in the N. may be more specially regarded as the fusion of the history of the mythical people, called in the poem the Nibelungen, with five leading groups of myths, in which are incorporated the adventures of some of the most universally popular personages belonging to the semi-historic myths of mediæval German folk-lore, as, for instance, the hero Siegfried with his mantle of invisibility, and the lovely Icelandic heroine Brunhilt; King Günther of Burgundy, and his fair sister, Kriemhilt, the wife of Siegfried; Haco of Norway, Dietrich (Theodoric the Great, king of the Ostrogoths of Berne (Verona), and Etzel (Attila), king of the Huns. The loves and feuds, and the stormy lives and violent deaths of these national heroes and heroines, are skillfully intertwined in the N., and artistically made to centre round the mythical treasure of the Nibelungen, which, after the murder of Siegfried, who had brought it from the far north, is secretly buried by his murderer Haco beneath the Rhine, where it still remains. The poem, in its rude but strict versification, tells the tale of Kriemhilt's vengeance for her husband's death with a passionate earnestness that carries the sympathies of the reader with it, until the interest culminates in the catastrophe of the fierce battle between the Burgundians and Huns at the court of Etzel, whose hand Kriemhilt has accepted, the better to accomplish her purposes of revenge. The tale of horrors fitly closes with the murder of Kriemhilt herself, after she has satisfied her vengeance by slaying with Siegfried's sword his murderer Haco. This tale, which seemed to echo back the clash of arms and strife of passion which characterised the early periods of German history, kept a firm hold on the imaginations of the people till the taste for polemic writings, fostered, if not created at the period of the Reformation, caused this as well as many other treasures of folk-lore to be almost lost sight of and forgotten. Attention was, however, again drawn to it in the 18th c., by the publication of detached portions of the poem by Bodmer, *Chriemhilden-Rache* (Zurich, 1751), and by Müller in his *Sammlung deutscher Gedichte aus dem 12—14 Jahrh.* (Berl. 1782); but it was not till comparatively recent times that the value of the work

in an historical and philological point of view was recognised. Lachmann, who had submitted the poem to a critical examination, made known the result of his investigations in an edition published at Berlin, 1826, and again in his treatise *Zu den Nibelungen und zur Klage* (Berl. 1836). W. Grimm has also given a comprehensive analysis of the poem in his *Deutschen Heldensage* (Gött. 1829). Among the various translations into modern German, those of Simrock (Berl. 1827) and Pfitzer (Tüb. 1842) are the best. All the manuscripts of the N. comprise another poem under the title of *Die Klage*, which treats of the burial of the heroes who fell in the conflict at Etzel's court, and the laments which were composed in commemoration of that event. It is of greater antiquity than the N., and, like it, the work of an unknown author. A critical analysis of the N. will be found in Carlyle's *Miscellaneous Essays*.

NICÆA. See NICE.

NICARAGUA, a republic of Central America, bounded on the N. by the republic of Honduras, on the W. by the Caribbean Sea, on the S. by the republic of Costa Rica, and on the E. by the Pacific; lat. 10° 45'—15° N.; long. 83° 20'—87° 30'; area about 57,000 square miles; pop. estimated at 400,000, of whom about 30,000 are whites, 10,000 negroes, the rest Indians and Mestizoes. N. is traversed by two ranges of mountains—the western, which follows the direction of the coast-line, at a distance of from 10 to 20 miles from the Pacific; and the eastern (a part of the great range of the Cordilleras), which runs nearly parallel to it, and sends off several spurs towards the Caribbean Sea. The former is generally high and volcanic, but sinks at times almost to the level of the plains. Between the two ranges lies a great interior basin, containing the lakes of N. (q. v.) and Managua. The principal rivers are the Rio Coco, or Segovia, forming part of the boundary between Honduras and N.; the Escondido, or Blewfields; and the San Juan, all of which flow into the Caribbean Sea. The eastern coast of N. is called the Mosquito Coast. The country is in many places densely wooded—the most valuable trees being mahogany, logwood, Nicaragua wood, cedar, and Brazil wood. The pastures are splendid, and support vast herds of cattle. The chief products are sugar-cane (softer and juicier than the Asiatic variety), cacao, cotton, indigo, tobacco, maize, and rice; with nearly all the fruits and edibles of the tropics, plantains, bananas, tomatoes, bread-fruit, arrow-root, citrons, oranges, limes, lemons, pine-apples, guavas, &c. The chief vegetable exports are sarsaparilla, aloe, ipecacuanha, ginger, copal, gum-arabic, caoutchouc, &c. The northern part of N. is rich in minerals, gold, silver, copper, iron, and lead, but the mines are not so carefully worked now as under the Spaniards. The incessant political distractions of the country have notoriously all but destroyed the material prosperity of the country. The seat of government is Managua, with 10,000 inhabitants; but the largest town and former capital is St Leon, with a population of 35,000. N. is divided into the five 'departments' of Rivas or Meridional, Granada or Oriental, Leon or Occidental, Segovia or Septentrional, and Matagalpa.

N. was discovered in 1521 by Gil Gonzales de Avila, and conquered by Pedro Arias de Avila, the governor of Panama in 1522. In 1821—the great year of revolution in Central America—it threw off allegiance to Spain, and after a desperate and bloody struggle, secured its independence by the help of the 'liberals' of San Salvador. N. now became the second state in the federal republic of Central

America, but on the dissolution of the union in 1839, became an independent republic. In 1847—1848, a dispute broke out between N. and Great Britain about the Mosquito Coast, which led to some hostilities, and was only finally settled in 1860. Meanwhile, in 1855, a civil war had broken out between the so-called 'Conservatives' and 'Liberals,' which resulted in the victory of the latter, who were, however, obliged to call in the help of the since notorious Colonel William Walker (see *FULL-BUSTERS*).

By the constitution of 19th August 1858, the republic of N. is governed by a president, who is elected by universal suffrage, and holds office for four years. There are two legislative chambers—the Senate and the House of Representatives. Liberty of speech and of the press exists, but is not absolutely guaranteed. The Roman Catholic religion, however, is the only one publicly tolerated, but the services of other religious bodies may be privately performed.

NICARAGUA, LAKE (native, *Cocibolca*), a sheet of fresh-water in the republic of the same name, 110 miles long, and from 30 to 50 broad. Its elevation above the Pacific, from which it is separated by a low range of hills—at one point only 48 feet higher than the lake itself—is little more than 100 feet. The principal rivers flowing into it are the Mayales and Malacoloja on the north, and the Frio on the south; the only one flowing out is the San Juan (formerly *Usaquadero*), which unites it with the Caribbean Sea. Its islands are numerous, lying mostly in groups; the principal are Ometepe, Zapatero (uninhabited, but with extensive ruins and monolithic idols), Salentanami, and the Corales, a cluster of several hundred volcanic islets lying round the base of the volcano of Mombacho, in the north-west of the lake. The scenery is surpassingly beautiful, and even grand. Lake N. is also interesting on account of the facilities which it presents for water communication between the Atlantic and Pacific Oceans.

NICA'STRO, a town of Naples, province of Calabria Ultra II., is most beautifully situated west of the Apennines, on the margin of the coast plains, and commanding views of the sea, 24 miles south of Cosenza. It is the see of an archbishop. There are hot springs in the vicinity. Pop. stated at 7000 and 10,200.

NICCOLA PISANO, a distinguished sculptor of Pisa, to the influence of whose works the rise or restoration of sculpture in connection with Gothic architecture is mainly attributable. There is no record of the date of his birth, but from an inscription on a celebrated fountain in Perugia, designed by him and executed by his son Giovanni, it is evident that he was born at the beginning of the 13th century. His earliest work is supposed to be the 'Deposition' over one of the doors of the façade of the cathedral at Lucca, dated 1233. He worked on the principle of studying nature, modified or corrected by the ideal of antique sculpture; and it is said that he first adopted this principle from the sculpture on an ancient sarcophagus brought from Greece in the ships of Pisa; but though most of the finest specimens of Greek sculpture were not discovered till long after N.'s time, he must have had an opportunity of studying many important remains on the various classic ruins with which Italy abounds. This sculptor's reputation is supported by three important works, which remain and are still admired for their excellence—the pulpit of the baptistery at Pisa, the 'Arca' or shrine of St Dominic for the church of that saint at Bologna, and the pulpit of the cathedral at Siena. The first

of these was finished in 1260, and is reckoned the most elegant pulpit in Italy. It is of white marble, six-sided, supported by seven Corinthian columns, and adorned with five bas-reliefs of subjects from the New Testament. The second work, the 'Arca' of St Dominic, is one of even greater extent. It is composed of six large bas-reliefs, delineating the six principal events in the legend of St Dominic, and is ornamented with statues of our Saviour, the Virgin, and the four doctors of the church. The operculum or lid was added about 200 years afterwards. The subjects on the pulpit at Siena, the third of these works, are the same as those on that at Pisa, with the substitution of the 'Flight into Egypt' and the 'Massacre of the Innocents' for the 'Presentation,' and the enlargement of the concluding composition, the 'Last Judgment.' In these compositions there is great felicity of invention and grouping, truth of expression, and grace in the attitudes and draperies; and in that of the 'Last Judgment' the boldness displayed in the naked figures, twisted and contorted into every imaginable attitude, is wonderful, and evinces the skill with which N. drew on the antique and on nature. But it must be admitted that there is a degree of confusion or overfulness in the grouping, and that the heads of his figures are often large in proportion to the bodies; faults incidental to all early efforts. In this last work, it appears by the contract for its execution, that N. was assisted by his scholars Lapo and Arnolfo, and his son Giovanni; and this accounts for a certain feebleness that may be observed in portions of it. He died at Pisa, in 1276 or 1277, and was buried in the Campo Santo. N.'s influence on art extended widely; his pupils Arnolfo and Lapo executed numerous works at Rome, Siena, and other cities. His son and heir in reputation, though not his equal in talent, Giovanni Pisano, was constantly engaged on works of importance; in Pisa, where the Campo Santo (for he was also an architect) was erected from his designs; in Naples, which he visited on the invitation of Charles I. of Anjou; at Arezzo, where he executed the marble shrine of St Donato for the cathedral; at Orvieto, the bas-reliefs on the *facciata* of the Duomo, by many ascribed to N., being by him; at Pistoja, where he executed the pulpit, &c. The year of his death is not ascertained; it was probably about 1320. After Giovanni's death, the Pisan school split into two principal branches, Florence and Siena; that of Naples may also be reckoned a branch, from the influence exercised over it by Giovanni.—**ANDREA PISANO**, the ablest of Giovanni's pupils, was called to Florence to execute in marble the statues, bas-reliefs, &c., designed by Giotto in ornamenting the cathedral of S. Maria del Fiore, then in course of erection. The talent he displayed soon raised him to a high position and important employment. He executed numerous statues for the façade of the cathedral, and a bronze gate for the baptistery, of very great excellence. This gate still exists, along with the later and still more celebrated gates of Ghiberti. Under the influence of Giotto's genius, he became completely Giottesque in thought and style; and his works bear so distinctly the impress of that master-mind, that the design of many of them, and particularly the baptistery gate, are ascribed to Giotto. He died in 1345, aged 76. See Vasari; *Christian Art*, by Lord Lindsay; Agincourt, *Davia Memorie Storiche*; Rosini, *Storia*, &c.; Cicognara (tom. i.), *Monumenti Sepolcrali della Toscana*.

NICCOLINI, GIOVANNI BATISTA, a distinguished modern poet, was born in 1785, in the vicinity of Pisa, of a noble but impoverished family. N.'s first literary efforts were full of high promise of the classical and antique beauties which characterize

his finest compositions, and in 1810 he was crowned by the Crusca Academy. Through the influence of the queen of Etruria, he was appointed secretary of the Academy of Fine Arts, where he delivered to the young artists lectures on history and mythology; but on the fall of the Bonaparte sovereigns, this post was withdrawn from the poet. In 1805, the Grand Duke Ferdinand appointed him librarian in the Pitti Palace, an office he resigned in order to escape the servility of court dependence. By the death of a relative he acquired wealth and the power of exclusively devoting himself to literature, and published several much-admired essays and lectures; and in 1827 appeared his noble work, *Antonio Foscarini*. In 1844, N. published anonymously his best poem—*Arnolfo da Brescia*—and nothing finer has been written in modern Italian, whether it be viewed as a classical creation, full of life and poetry, or as a work of glowing patriotism. N. lived in the enjoyment of fame and honours to a ripe old age, and died at Florence in 1861.

NICE, or NICEÆA, formerly a city of Bithynia, in Asia Minor, situated on the eastern shore of Lake Ascania. It was built, or rather rebuilt (for an older town had existed on its site), by Antigonus, the son of Philip (316 B.C.), and received the name of Antigonæia, which Lysimachus changed to Niceæa, in honour of his wife. It was a handsome town, and of great importance in the time of the Roman and Byzantine emperors; all the streets crossed each other at right angles, and from a magnificent monument in the centre the four gates of the city were visible. It is famous in ecclesiastical history for two Councils held in it, the First and Seventh Ecumenical Councils. The FIRST COUNCIL OF N. was held 325 A.D., and was convened by the Emperor Constantine, in concert, according to Roman Catholic historians, with the Roman pontiff, for the purpose of defining the questions raised in the Arian (q. v.) controversy. The details of the proceedings, so far as regards Arius, will be found in that article. The supporters of Arius at first are said to have numbered upwards of twenty; but ultimately the decree condemning him was subscribed by the whole body of the Council, the number of dissentients being, according to the highest computation, only five, while the most probable account reduces it to two. The NICENE CREED adopted in this Council forms the subject of a separate article. In addition to the Arian question, the Council of N. also deliberated on a schism, called the Meletian Schism, which at that time divided the church of Egypt, and the particulars of which have formed a subject of recent controversy. The decree of N. appears to have been founded on a compromise, but did not effectually suppress the schism. The decree of N. on the celebration of Easter was of wider application, and met with universal acceptance, the few recusants being thenceforward called Quarto-decimans (q. v.). This Council also enacted twenty canons of discipline. For a minute and picturesque description of this council, see Dean Stanley's *History of the Eastern Church*.—The SECOND COUNCIL OF N., called also the Seventh Ecumenical Council, was assembled under the Empress Irene (787), who was regent during the minority of her son Constantine, for the purpose of reconsidering the subject of Images. The tenor of the decree on Images is detailed under that head. In the West, the question of the acceptation of this council was the subject of considerable controversy, arising, in great measure, from a grossly erroneous Latin translation of the acts, which for a time obtained extensive circulation.

NICE (Ital. *Nizza*), chief town, since 1860, of the department of the Alpes Maritimes, France, is situated on both sides of the river Paglione, 100 miles south-south-west of Turin, in lat. 43° 42' N., and long. 7° 17' E. Pop. 36,800. It consists of three principal parts—the *Quartier de la Croix de Marbre*, or *New Town* (on the right bank of the Paglione), the *Old Town*, and the *Port*. The first of these is much frequented by foreigners, particularly English (whence its name of 'English town'). It is close upon the river, has a handsome quay filled with gay shops, and a splendid square called the *Jardin Public*. Two bridges over the Paglione connect it with the Old or Upper Town, which extends back to the foot of a hill called the *Castle Hill*. The Old Town is excessively dirty, and has narrow, stinking streets, with macaroni and confectionary shops, grocery establishments, slaughter-houses, &c. The Port, almost separated from it by the *Castle Hill*, is crowded with a seafaring population. The harbour admits vessels drawing fifteen feet of water, but is difficult of entrance. The *Castle Hill*, an isolated mass of limestone 800 feet high, receiving its name from having been formerly crowned by a strong castle, now in ruins, is laid out in public gardens, and affords an extensive and splendid prospect out to sea. There are some very fine buildings in the *Rue St François de Paule* and the *Corso*, where the theatre, the public library, and the principal cafés are situated. The *Place St Dominique* is the chief centre of business. The most attractive promenade in the Old Town is the *Terrace*, from 15 to 20 feet high, erected as a protection to the town against a stormy sea. But the most agreeable and fashionable drive and promenade is the *Promenade des Anglais*, extending for a mile along the shore from the right bank of the Paglione, and skirted on one side by elegant villas and hotels. Beggars are numerous, owing, doubtless, to the great influx of visitors. The climate of N. is extremely mild and salubrious in winter, and the town is, in consequence, a favourite residence of invalids from more northern regions. Not less than 5000 or 6000 English are constantly here in the hotels, boarding-houses, and private lodgings. The mean temperature of N., deduced from fifteen years' observation, has been found to be 60½° F.; the greatest heat (July and August), 88½°; the greatest cold (January), 27¼°. Invalids should take care to lodge where they are sheltered from the currents of cold air that often come down the valleys like streams from the snow-clad Alps lying to the north.

The ancient Ligurian town of Niceæa, founded, it is said, by a colony of Phœceans from Massalia (Marseille), became subject to Rome in the 2d c. B.C. It probably occupied the *Castle Hill*, rather than the site of the present city. Subsequently it passed into the hands of the Goths, Burgundians, Visigoths, kings and counts of Arles, the Angevine sovereigns of Naples, and the Dukes of Savoy (1338), in whose family it remained till 1860, when it was ceded to France.

NICENE CREED, a detailed statement of doctrine, which forms part of the liturgy of the Roman, Oriental, and Anglican Churches, and is also received as a formulary by many of the other Protestant communions. It was drawn up principally by Hosius of Corduba, and is called by the name of the Council of Nice, although nearly one half of its present clauses formed no part of the original Nicene formulary; while, on the other hand, that document contained a series of anathemas condemnatory of specific statements of Arius, which find no place in the present so-called Nicene creed. The distinctive characteristic of the creed drawn up in the Council was the word

Homoousios. (See HOMOOUSIAN.) Its clauses correspond (except in a few verbal details) with those of the modern formulæ as far as the words 'I believe in the Holy Ghost;' after which follow the anathemas referred to above. The remaining clauses of the present creed, although they seem to have been in public use earlier, were formally added in the First Council of Constantinople (381), with the exception of the clause, 'And from the Son,' which was introduced in various churches of the West in the 5th and 6th centuries; and ultimately its formal embodiment in the creed, has continued a subject of controversy with the Greeks to the present day. See GREEK CHURCH. This creed appears to have been used in the public liturgy from the latter part of the 5th century. Its position in the liturgy varies in the different rites. In the Roman liturgy it is read on all Sundays, feasts of our Lord, of the blessed Virgin Mary, apostles' days, and all the principal festivals, but not on week-days, or the minor saints' days.

Several Arian creeds, in opposition to that of Nice, were drawn up at Sirmium and elsewhere (see LIBERTUS), but none of them met with general acceptance.

NICHE, a recess formed in a wall to contain a statue or some ornamental figure. In classic architecture, the niches are generally square recesses with canopies formed by small pediments. In Gothic architecture, the niche is one of the most frequent and characteristic features; the doorways, buttresses, and every part of the buildings being in many instances ornamented with niches and statues in endless variety.

NICHOLAS, the name of five among the Roman pontiffs, of whom the following alone appear to call for separate notice.—N. I. was born of a noble Roman family, and on the death of Benedict III., in 858, N. was elected to succeed him, and was consecrated in St Peter's Church, in the presence of Ludwig II., emperor of Germany. The earliest incident of importance of his pontificate is his conflict with Photius (q. v.), who had been intruded into the see of Constantinople after the deprivation of Ignatius. N. demanded from the emperor the restoration of Ignatius, as well as the withdrawal of certain attempted invasions of the jurisdiction of the West. On the refusal of his demands, N. excommunicated Photius (see GREEK CHURCH), and that patriarch, in return, assembled a council at Constantinople, and retorting upon his rival the same sentence, alleged that with the translation of the seat of civil sovereignty from Rome to Constantinople the ecclesiastical supremacy was likewise transferred. The Emperor Michael supporting Photius in his claim, N. failed to command submission to his sentence; nor was it till the following reign, that of Basil the Macedonian, that Photius was deposed, and Ignatius restored to his see. Meanwhile, however, N. had been embroiled with the Emperor Ludvig. The pope had been appealed to by the unjustly divorced wife of Ludvig's younger brother, Lothaire, king of Lorraine, and had appointed legates to inquire into and report upon the case; and the legates having exceeded their powers by giving a sentence in favour of Lothaire, the pope declared their sentence null, and excommunicated them. Ludvig espoused their cause, and marched his troops to Rome, in order to enforce satisfaction. After some hostile demonstrations, the emperor, terrified, it is said, by his own sudden illness, and some fatalities which befell his followers, desisted from the enterprise, and withdrew his troops. Lothaire was forced to make submission; the decree of N. was enforced, and Theutberga was formally reinstated in her

position as a wife and queen. N. died in 868.—**NICHOLAS V.** was originally called Thomas Parentucelli. Born at Pisa in 1398, he was educated at Florence and Bologna, and having fixed his residence in the latter city, he was eventually named bishop of that see by the pope, Eugenius IV. During the troubled period of the Councils of Basel and Florence, and in the difficult negotiations with the German and other churches which arose therefrom, he conducted himself with such ability and prudence, that on the death of Eugenius IV. he was chosen to succeed him on March 6, 1447. At this time, the anti-pope, Felix V., still maintained himself, although supported by a very small party; but N. prevailed on him to abdicate, and thus restored the peace of the church in 1449. In the judgment of the literary world, however, the great distinction of the pontificate of N. lies in the eminent service which he rendered to that revival of letters which dates from his age. The comparative repose in which he found the world at his accession, enabled him to employ, for the discovery and collection of the scattered master-pieces of ancient learning, measures which were practically beyond the resources of his predecessors. He despatched agents to all the great centres, both of the East and of the West, to purchase or to copy every important Greek and Latin manuscript. The number collected by him was above 5000. He enlarged and improved the Roman university. He remodelled, and may almost be said to have founded, the Vatican Library. He caused translations to be made into Latin of most of the important Greek classics, sacred and profane. He invited to Rome the most eminent scholars of the world, and extended his especial patronage to those Greeks whom the troubles of their native country drove to seek a new home in the West. Alarmed by the progress of the Turkish arms in Asia, he endeavoured to arouse the Christian princes of Europe to the duty of succouring their brethren of the East; but the age of enthusiasm was past, and he was forced to look on inactively at the fall of Constantinople in 1453. This event, by forcing a large number of learned Greeks to repair to Italy and other countries of the West, contributed powerfully to that progress of learning which N. had deeply at heart; but he scarcely lived to enjoy this result, having died two years later, in 1455, at the comparatively early age of 57. He must not be confounded with an anti-pope of the same name, Peter de Corbario, who was set up, in 1328, by Ludvig of Bavaria, in antagonism to John XXII. (q. v.).

NICHOLAS I., more properly NIKOLAI PAULOVITCH, emperor of Russia, was the third son of Paul I., and was born at St Petersburg, 7th July 1796. He was very carefully educated under the eye of his mother, a princess of Wurtemberg, and subsequently devoted his attention to military studies and political economy, without, however, giving evidence of any natural capacity for these subjects. He visited England and other European countries in 1816, and in the same year made a tour through the Russian provinces. On 13th July 1817, he married Frederika-Louisa-Charlotte - Wilhelmina, the eldest daughter of Frederic William III. of Prussia, and lived in domestic retirement till the death of Alexander I. (December 1825), when, owing to the resignation of his elder brother Constantine, he succeeded to the throne of Russia. A long-prepared military conspiracy broke out immediately after his accession, which he suppressed with great vigour and cruelty. Capital punishment, which had been abolished by the Empress Elizabeth, was revived, for the purpose of inflicting it upon the leaders of the insurrection.

The rebels were hunted down with merciless energy, and in no case, even after the rebellion ceased to be in the least degree dangerous, was their punishment commuted. Instead of pursuing the course upon which Alexander had entered—cultivating the mind of the nation, so as to base his government upon education and intelligence—N., after a brief ebullition of reformatory zeal, reverted to the ancient policy of the Czars, absolute despotism, supported by mere military power. His first great measure, the codification of Russian law, was commenced in 1827, and completed in 1846.

Soon after his accession, a war with Persia commenced, but it was concluded on 28th February 1828, by the peace of Turkmanahai, which gave a considerable extent of territory to Russia. In the same year he entered upon a war with Turkey, in which victory, though at enormous cost, constantly attended his arms, and the peace of Adrianople (q. v.) obtained for Russia another increase of territory, the free navigation of the Danube, with the right of free passage between the Black and Mediterranean Seas. The political movements of 1830, in the west of Europe, were followed by a national rising of the Poles, which was suppressed after a desolating contest of nine months, in which the utmost efforts of the whole military resources of Russia were required. N. punished the rebellion by converting the kingdom of Poland into a mere Russian province, and strove to extinguish the Polish nationality. This policy, however, was viewed with great dissatisfaction throughout Europe, and the vanquished Poles were everywhere regarded with general sympathy. Russia, by N.'s mode of government, became more and more separated from the fellowship of the western nations. Intellectual activity was, as far as possible, restrained to things merely practical, education limited to preparation for the public service, the press was placed under the strictest censorship, and every means used to bring the whole mind of the nation under official guidance. His Slavism (q. v.) also prompted him to Russianise as much as possible all the inhabitants of the empire, and to convert Roman Catholics and Protestants to the Russian Greek Church, of which the Czar is the head. The independence of the mountaineers of the Caucasus was inconsistent with his schemes, and war was consequently waged against them with the greatest energy and perseverance, although with little success, and at the cost of immense sacrifices both of money and lives. The extension of British influence in Central Asia was also viewed by him with alarm, and was attempted to be counteracted by various means, amongst which was the expedition for the conquest of Khiva in 1839, which failed so signally (see *КИРВА*). Between 1844 and 1846, he visited England, Austria, and Italy. During the political storm of 1848—1849 he abstained from interference, watching, however, for an opportunity of doing so with advantage to Russian interests. The opportunity was at last found in the request of the emperor of Austria for his assistance to quell the Hungarian insurrection. This good service rendered Austria, as he thought, a faithful and firm ally. He succeeded at the same time in drawing closer the bonds of alliance between the Russian and Prussian monarchies, a proceeding fraught with the most mischievous consequences to the latter power. The re-establishment of the French empire still further tended to confirm these alliances, and led N. to think that the time had at length come for carrying into effect the hereditary Russian scheme for the absorption of Turkey; but the unexpected opposition of Britain and France, and his own

invincible repugnance to give up his long-planned scheme of conquest, brought on the Crimean War, during the course of which he died at St Petersburg, March 2, 1855, of atrophy of the lungs; but his death was undoubtedly hastened by chagrin at the repeated defeats which his arms sustained, and by over-anxiety and the excessive labour he underwent to repair his losses. He was remarkable for temperance, frugality, and patriotism, but equally so for vanity and ostentation. He was fanatically beloved by his Russian subjects, and was at the same time regarded by them with feelings of awe, a tribute to his lofty stature and imperial deportment, which gave him the most intense pleasure. In fact, this extreme vanity seems, to some extent, to have affected his mind, and to have been partly the cause of his political blundering towards the close of his reign.

NICIAS, a famous Athenian statesman and general during the Peloponnesian War, was the son of Niceratus, a very wealthy citizen, who had acquired his fortune by working the silver-mines at Laureium. N. belonged to the aristocratic party, and after the death of Pericles, presented himself as the opponent of Cleon, the great popular or demagogic leader. He was not a man of quick, brilliant, audacious genius, like Alcibiades; on the contrary, he was remarkably wary and cautious, even at times to timidity. Success generally accompanied his enterprises against the Spartans and their allies. In 427 B. C., he captured the island of Minoa; next year he ravaged the island of Melos and the coasts of Locris; the year following that, he obliged the Spartan force in Sphacteria to surrender, and also defeated the Corinthians. In 424 B. C., he made havoc of part of Laconia, captured the island of Cythera, and achieved several other successes. After the death of Cleon, he brought about a peace between the Spartans and Athenians, 421 B. C. Six years afterwards, the Athenians, at the instigation of Alcibiades, resolved on a great naval expedition against Sicily. N. was appointed one of the commanders, although he had strongly protested against the undertaking. In the autumn of 415 B. C., he laid siege to Syracuse, and was at first successful, but subsequently experienced a series of disasters; his fleet was destroyed, and his troops began a retreat towards the interior of Sicily. They were speedily forced to surrender, and N. was put to death 414 B. C. See Thirlwall's and Grote's *Histories of Greece*, and Plutarch's *Life of Nicias*.

NICKEL (symbol, Ni; equivalent, 29.5; specific gravity, 8.8) is a grayish-white glistening metal, capable of receiving a high polish, of about the same hardness as iron, and, like that metal, malleable and ductile. It has about the same fusibility as wrought iron, but is less readily oxidised than that metal, since it remains unchanged for a long time in a moist atmosphere, and is very little attacked by dilute acids. It is strongly magnetic, but loses this property when heated to 660°. It dissolves in hydrochloric and dilute sulphuric acid with a development of hydrogen gas, and is very readily oxidised in nitric acid.

N. only occurs in the native state in meteoric stones, in which it is always present in association with the iron which forms the principal part of those masses. It is found in tolerable abundance in Saxony, Westphalia, Hungary, Sweden, &c., where it occurs in the form of *kupfernickel* (so called from its yellowish-red colour), which is a combination of N. and arsenic. The metal is obtained on the large scale (for the purpose of making German silver (q. v.) and other alloys) either from this compound or *spies*, which is an impure arsenio-sulphide of N., formed

during the manufacture of *Smalt* (q. v.), by somewhat complicated chemical processes. In small quantities, it may be obtained by reducing one of its oxides by means of hydrogen at a high temperature, or by exposing the oxalate to a very high temperature in a crucible lined with charcoal.

N. forms two compounds with oxygen—viz., a protoxide, NiO, and a sesquioxide, Ni₂O₃, which is not basic, and may be passed over without further notice. The *protoxide* occurs as a greenish-gray powder, which exhibits no magnetic properties, and is insoluble in water. It is obtained by heating the carbonate or the *hydrated protoxide* in a closed crucible. The hydrated protoxide, NiO.HO, is obtained by precipitation from a solution of one of its salts by potash. The salts of the protoxide and their solutions are of a delicate, very characteristic green colour; but in the anhydrous state most of them are yellow. The neutral salts, soluble in water, slightly redden litmus, have a sweetish astringent metallic taste, and when administered in moderate doses, excite vomiting. The most important of the salts is the sulphate (NiO.SO₄ + 7 Ag), which crystallises in beautiful green rhombic prisms. It is obtained by dissolving the metal or its oxide in dilute sulphuric acid; and is the source from which the other salts of N., the carbonate, oxalate, &c., are obtained. The principal use of N. is in the composition of various alloys, such as German Silver (q. v.).

The sulphate of N. has been prescribed successfully by Professor Simpson in cases of severe headache.

NICOBAR ISLANDS, a group of islands in the Indian Ocean, north-west of Sumatra, and forming, with the Andamans (q. v.), an extension of the great island chain of which Java and Sumatra are the principal links. Lat. 6° 40'—9° 20' N., long. 93°—94° E. They are divided by the Sombrero Channel into two groups, of which the principal members are the Great N. (area about 260 square miles), and the Little N. (area 86 square miles). Population in all, estimated at 6000, who are principally Malays. The cocoa-nut and banana grow everywhere on the shores. The soil is fertile, the mean annual temperature is 70° F., and the climate is so unhealthy, that the islands are quite unsuited for colonisation. The Danes claimed the islands in 1841, but abandoned their claim in 1848. The inhabitants are known in several instances to have seized vessels that have touched at the N. I., murdered the crews, and rifled and sunk the ships.

NICOLAI, CHRISTOPH. FRIEDR., a celebrated German author, bookseller, and publisher, was born 18th March 1733, at Berlin, where his father was also a bookseller. He devoted himself very earnestly to literary and philosophical studies, and early distinguished himself by his *Briefen über den jetzigen Zustand der schönen Wissenschaften* (Berl. 1756), in which he exposed the errors of both Gottsched and Bodmer, then carrying on a controversy which was agitating the literary world of Germany. He became the associate of Lessing and Moses Mendelssohn. Jointly with the latter, he edited for some time the admirable *Bibliothek der schönen Wissenschaften* (Leip. 1757—1758); and with Lessing, he gave to the world *Briefe, die neueste deutsche Literatur betreffend* (24 vols. Berl. 1759—1765). By this he was led to conceive the plan of the *Allgemeinen deutschen Bibliothek* (106 vols. 1765—1792), a periodical which he edited for many years, and which contributed much, particularly in the early period of its existence, to the progress of literature and improvement of taste in Germany, but was too frequently characterised by an undue acerbity of

tone. N.'s hostility to the new schools of literature and philosophy, which sprang up in Germany, exposed him to attacks from the pens of Herder, Goethe, Schiller, Lavater, and Fichte. His death took place 8th January 1811.

Among N.'s works may be mentioned his *Topographisch-historische Beschreibung von Berlin und Potsdam* (Berl. 1769, 3d edit. 1786); *Characteristischen Anekdoten von Friedrich II.* (Berl. 1788—1792), both of permanent value; some novels, as his *Leben und Meinungen des Magisters Sebalduß Nothanker* (4th edit. Berl. 1799); *Geschichte eines dicken Mannes*, a sharply satirical performance (2 vols. Berl. 1794); *Beschreibung einer Reise durch Deutschland und die Schweiz* (Berl. 1781; 3d edit. 12 vols. 1788—1796); an autobiography, published in the *Bildnissen jetzt Ueber Berliner Gelehrten*; and a work entitled *Ueber meine gelehrte Bildung, über meine Kenntnisse der Critischen Philosophie und meine Schriften dieselbe betreffend, und über die Herren Kant, J. B. Erhard, und Fichte* (Berl. 1799).

NICOLAS, St., a highly popular saint of the Roman Catholic Church, and revered with still greater devotion by the Russian Church, which regards him as a special patron, was one of the early bishops of Myra in Lycia. The precise date of his episcopate is a subject of much controversy. According to the popular account, he was a confessor of the faith in the last persecution under Maximian, and having survived until the Council of Nice, was one of the bishops who took part in that great assembly. This, however, seems highly improbable. His name does not occur among the signatures to the decrees, nor is he mentioned along with the other distinguished confessors of the faith who were present at the council, either by the historians, or what is more important, by St Athanasius. He may, with more probability, be referred to a later period; but he certainly lived prior to the reign of Justinian, in whose time several of the churches of Constantinople were dedicated to St Nicolas. Of his personal history hardly anything is certainly known, and the great popularity of the devotion to him rests mainly on the traditions, both in the West and in the East, of the many miracles wrought through his intercession. He is regarded, in Catholic countries, as the especial patron of the young, and particularly of scholars. In England, his feast was celebrated in ancient times with great solemnity in the public schools, Eton, Sarum Cathedral, and elsewhere; and a curious practice, founded upon this characteristic of St N., still subsists in some countries, especially in Germany. On the vigil of his feast, which is held on the 6th December, a person in the appearance and costume of a bishop assembles the children of a family or of a school, and distributes among them, to the good children, gilt nuts, sweetmeats, and other little presents, as the reward of good conduct; to the naughty ones, the redoubtable punishment of the 'Klaubauf.' The supposed relics of St N. were conveyed from the east to Bari, in the kingdom of Naples, towards the close of the 11th c.; and it is a curious fact that in the Russian Church the anniversary of this translation, 9th May, is still observed as a festival.

NICOMEDEIA, the capital of ancient Bithynia, was situated at the north-eastern angle of the Gulf of Astacus, in the Propontis, now called the Bay of Ismid, was built about 264 A. D. by Nicomedes I., who made it the capital of his kingdom, and it soon became one of the most magnificent and flourishing cities in the world, and some of the later Roman emperors, such as Diocletian and Constantine the Great, selected it for their temporary residence. It

suffered greatly both from earthquakes and the attacks of the Goths. Constantine died at a royal villa in the immediate vicinity. Hannibal committed suicide in a castle close by. It was the birthplace of the historian Arrian. The small town of Ismid or Isnikmid now occupies its site, and contains many relics of ancient Nicomedeia.

NICO'POLIS, a Turkish city and fortress in Bulgaria, on the right bank of the Danube, occupies a line of limestone cliffs 56 miles west of Rustchuk. Although it occupies one of the most beautiful sites in the world, it is of little importance as a stronghold, as it is commanded by neighbouring heights. The city is divided into two portions; the fortress and Turkish town, defended on every side by batteries and ramparts, and the eastern quarter, comprising the dwellings of the Bulgarians, Wallachs, and Jews. N. is widely built, most of the houses being surrounded by gardens. It is an important market for Wallachian wares, but otherwise is not a great centre of trade. Wine is produced in the vicinity. Pop. 15,000.

N., the ancient *Nicopolis ad Istrum*, was founded by Trajan, and fragments of the old wall still remain. Here the Hungarians, under their king Sigismund, were defeated by the Sultan Bajazet I. in 1396. The city gives title to a Greek archbishop and to a Catholic bishop.

NICOTIANA. See TOBACCO.

NICOTINE, or **NICOTYLLIA** (C₁₀H₁₄N₂), is one of the natural volatile oily bases destitute of oxygen, and constitutes the active principle of the tobacco plant, in the leaves, roots, and seeds of which it occurs in combination with malic and citric acids. It is likewise contained in the smoke of the burning leaves. It is a colourless, intensely poisonous liquid, of specific gravity 1.027 at 66°, which boils at 480°, evolves a very irritating odour of tobacco, especially on the application of heat, is very inflammable, and burns with a smoky flame. It is moderately soluble in water, and dissolves readily in alcohol and ether. If exposed to the air, it absorbs oxygen, and becomes brown, and ultimately solid. The quantity of N. contained in tobacco varies from 2 to 8 per cent.; the coarser kinds containing the larger quantity, while the best Havannah cigars seldom contain more than 2 per cent., and often less.

A remarkable case of poisoning by N.—that of the Count Bocarmé, who was tried and executed in Belgium for the murder of his brother-in-law—is recorded in the *Annales d'Hygiène* 1851, and was the occasion of Orfila's publishing his *Memoire Sur la Nicotine*. A distinguished student of the College of Chemistry subsequently employed it for the purpose of suicide. The deaths that have taken place from the use of tobacco in the form of injection—of which several cases are on record—were doubtless due to the action of this substance.

NIEBUHR, KARSTEN, a distinguished geographer and traveller, was born in 1733, in the Hanoverian territory of Hadeln, on the confines of Holstein. Being early thrown on his own resources, he spent several years of his youth in the position of a day-labourer; but his natural energy having led him to apply himself to the study of geometry, and having acquired a small property, he went to Göttingen, where he attended the classes at the university until his resources were wholly exhausted. At this period he entered the Danish service, and in 1761 he joined the scientific expedition which King Frederick V. sent to explore certain portions of Arabia, with a view of illustrating some passages of the Old Testament. The expedition reached Cairo at the close of the year 1761, and after having carefully explored the pyramids, and crossed the desert to Mount

Sinai and Suez, proceeded to Arabia Felix. Here, however, the various members of the expedition, which included the eminent naturalist Forskål, all perished with the exception of N., who had himself suffered severely from fever. After the untimely death of his companions, he adopted the diet and dress of the natives—a measure to which he was probably indebted for the good health which he enjoyed during the rest of the travels, which he prosecuted with extraordinary resolution for more than six years. He proceeded as far as India, visiting also Persia and Asiatic Turkey, and continued the observations and researches of his late colleagues in addition to his own special geographical investigations. On his return to Denmark, in 1767, N. at once devoted himself to the task of publishing the results of his important mission, which appeared in German under the following titles, *Beschreibung von Arabien* (Copenh. 1772), and *Reisebeschreibung von Arabien und andern umliegenden Ländern* (Copenh. 1774—1778, 2 vols.); the publication of the third volume of this work was unfortunately delayed, in consequence of the pressure of numerous other engagements arising from his professional and official duties, and it was not till more than twenty years after his death that the book made its appearance under the supervision of N.'s daughter, and through the liberality of the eminent bookseller Perthes of Hamburg. In addition to these valuable observations, N. edited and published at his own cost the natural-history notes of his deceased friend and fellow-traveller, P. Forskål, which he arranged in two works, *Descriptiones Animalium, &c.* (Copenh. 1775), and *Flora Egyptiaco-Arabica* (Copenh. 1776). The accuracy of detail, fidelity of delineation, and careful avoidance of all exaggeration, which characterise N.'s geographical and social descriptions of Arabia and other Asiatic countries, have made his works classical text-books for all who wish to study the subject. Although N. accepted, in 1778, a civil post, which fixed his residence in the remote provincial town of Meldorf, in the Ditmarsh district of Holstein, where he devoted himself during the rest of his life to the fulfilment of his official duties, he never relinquished his interest in scientific inquiry, and contributed several valuable papers on the geographical and political history of the nations of the east to the *Deutsche Museum*, and other periodicals. He died in 1815, leaving a character of being at once one of the most truthful and scientifically exact travellers of modern times.

NIEBUHR, BARTHOLD GEORG, one of the most acute historians, critics, and philologists of modern times, was born August 27, 1776, at Copenhagen, where his father, Karsten Niebuhr (q. v.), then resided. The aptitude for learning which N. displayed almost from infancy, led him to be regarded as a juvenile prodigy, and unlike many other precocious children, his powers of acquiring knowledge kept pace with his advancing years. After a carefully conducted preliminary education, under the superintendence of his father, he spent a session at Göttingen studying law, and from thence proceeded in his 19th year to Edinburgh, where he devoted himself more especially to the natural sciences. On his return to Denmark, he became private secretary to the finance minister, Schimmelmann, and from that period till 1804 held several appointments under the Danish government, which, however, he was led to resign in consequence of his strongly pronounced political tendencies, which made him enter heart and soul into the feeling of hatred of Napoleon, which was at that time agitating the minds of Germans. In accordance with these views, N. entered the Prussian civil

service in 1806, and during the three succeeding years he shared in the vicissitudes which befell the government of his chief, Count Hardenberg, after the disastrous battle of Jena, and the consequent pressure of the Napoleonic influence on the management of the state. The opening of the university of Berlin in 1810 was a new era in the life of N., who, with the view of promoting the interests of the new institution, gave a course of lectures on Roman history, which, by making known the results of the new and critical theory which he had applied to the elucidation of obscure historical evidence, established his position as one of the most original and philosophical of modern historians. His appointment, in 1816, to the post of Prussian ambassador at the papal court, where he remained till 1823, gave him an opportunity of testing on the spot the accuracy of his conjectures in regard to many questions of local and social bearing. On his return from Rome, N. took up his residence at Bonn, where, by his admirable lectures and expositions, he contributed very materially to the development of classical and archæological learning. He was thus employed when the revolution of 1830 roused him from the calm of his literary pursuits. N.'s sensitive nature, unstrung by physical debility, led him to take an exaggerated view of the consequences of this movement, and to anticipate a recurrence of all the horrors of the former French revolution, and the result was to bring about a state of mental depression and bodily prostration, which ended in his death in January 1831. N.'s attainments embraced a more extensive range than most men are capable of grasping, for he was alike distinguished as a shrewd man of business, an able diplomatist, an accurate scholar, and a man of original genius. He had mastered twenty languages before the age of thirty, while the mass of facts which his tenacious memory retained, and the intuitive sagacity that enabled him to sift true from false historic evidence, and often to supply by felicitous conjecture the link wanting in some imperfect chain of evidence, exhibit the extraordinary scope of his intellect. It is not to be denied, however, that he is often arbitrary and unhistorical in his conjectures, and the stricter sort of sceptical critics, like the late Sir George Cornewall Lewis, even go so far as to regard his effort to construct a continuous Roman history out of such legendary materials as we possess as, on the whole, a failure. Among the many important works with which he enriched the literature of his time, the following are some of the most noteworthy: *Römische Geschichte* (3 Bde. Berl. 1811—1832; 2d edit. 1827—1842; 1833; 1853), the first two volumes have been translated by J. C. Hare and C. Thirlwall, and the third by Dr W. Smith and Dr L. Schmitz; *Grundzüge für die Verfassung Niederlande* (Berl. 1832); *Griech. Heroengeschichte* (Hamb. 1842), written for his son Marcus; the *Kleinen historischen und philologischen Schriften* (2 Bde. Bonn, 1828—1843), contain his introductory lectures on Roman history, and many of the essays which had appeared in the Transactions of the Berlin Academy. Besides these, and numerous other essays on philological, historical, and archæological questions, N. co-operated with Bekker and other learned annotators in re-editing *Scriptores historie Byzantine*; he also discovered hitherto unprinted fragments of classical authors, as, for instance, of Cicero's *Orations* and portions of Gaius, published the *Inscriptiones Nubienses* (Rome, 1821), and was a constant contributor to the *Rheinisches Museum für Philologie*, and other literary journals and societies of Germany.

NIELLO-WORK, a method of ornamenting metal plates by engraving the surface, and rubbing

in a black or coloured composition, so as to fill up the incised lines, and give effect to the intaglio picture. It is by no means quite certain when this art was originated; Byzantine works of the 12th c. still exist to attest its early employment. The finest works of this kind belong to the former half of the 15th c., when remarkable excellence in drawing and grouping minute figures in these metal pictures was attained by Maso di Finiguerra, an eminent painter, and student of Ghiberti and Massacio. In his hands it gave rise to copper-plate engraving (see ENGRAVING), and hence much interest attaches to the art of niello-cutting. Genuine specimens of this art are rare, some of those by Finiguerra are very beautiful and effective, the black pigment in the lines giving a pleasing effect to the surface of the metal, which is usually silver. Those of his works best known are some elaborately beautiful pattines wrought by him for the church of San Giovanni at Florence, one of which is in the Uffizia, and some are in various private collections. In the collection of Ornamental Art at South Kensington, there are no less than 17 specimens of this art.

NIE'MEN (called by the Germans *Memel*), a river in Prussia, rises a few miles south of the city of Minak, flows westward to Grodno 180 miles, north and west along the frontiers of the Polish province of Augustowo, and west through East Prussia to the Kurische Haff. Entire length, 640 miles. It is navigable for large craft at Grodno, 400 miles from its mouth, and is free of ice from March to November. Between Grodno and Kovno there are 55 rapids and shallows, and pilots are therefore required for the navigation of the river. At Winge, 8 miles below Tilsit, the N. divides into two branches, of which the northern, the Russ, reaches the Kurische Haff by nine mouths; and the southern, the Gilge, by seven mouths. The delta is traversed by numerous canals. The N. is of considerable commercial importance. Large barges bring down the produce of Lithuania and of a portion of Poland to Königsberg and Memel. Corn, hemp, flax, hides, and bacon are the principal articles brought from the interior. Its principal affluent is the Vilia on the right.

NIEPCE DE ST VICTOR, CLAUDE-FELIX-ABEL, a French chemist and photographer, was born at Saint Cyr, near Chalon-sur-Saone, 26th July 1805. He served for some time in the army; but having made an important chemical discovery in connection with dyeing, he was permitted to exchange into the municipal guard of Paris, that he might pursue his scientific studies with more facility. This was in 1845, at which time his attention having been forcibly attracted to the important discoveries in photography which had been made by his uncle Nicéphore Niepce (see PHOTOGRAPHY), he resolved to devote his energies to this subject. He was led, in 1847, to the discovery of methods for obtaining images on glass, coated with albumen, starch, or gelatin, and for reproducing designs by the use of vapour of iodine. His investigations were for a time interrupted by the revolution of 1848, but he soon resumed them, directing his attention more especially to the obtaining of photographic images in colours; and before the close of 1852, he had succeeded in obtaining faithfully coloured images of flowers natural and artificial, coloured engravings, gold and silver lace, &c., upon silvered plates which had been sensitised by a chloride of copper. In obtaining these pictures, both photographic printing and the camera were employed; but to his intense disappointment, he found that

the colours soon began to fade, and after a time disappeared. This process he named 'Heliochrome.' His third and most important invention, that of the art of 'Heliography,' or the production of engraved steel-plates by photography, was first communicated to the Academy of Sciences in May 1853. He does not deserve the credit of having originated the idea; for his uncle, previous to 1839, had communicated an imperfect sketch of a similar invention to M. Arago; and Mr Talbot and others had succeeded by a similar process in obtaining images of simple objects on steel-plates; but to N. belongs the credit of having removed the almost insurmountable manipulative difficulties, and rendered the process of much more general application, thus making it practically serviceable. He has since been employed in improving and perfecting his various discoveries.

In 1855, he published the various memoirs in which he had at different times communicated his three great discoveries to the Academy of Sciences, under the title of *Recherches Photographiques*, which was followed, in 1856, by *Traité Pratique de Gravure sur Acier et sur Verre*, and he has since presented to the Academy a number of memoirs on the action of light on a variety of substances, the last being *Sur l'Action de la Lumière et de l'Électricité* (February 1860). N.'s scientific studies have not interfered with his military promotion, as he was successively appointed chef-d'escadron, and (1854) commandant of the Louvre.

NIERSTEIN, a market village (pop. 2600) of Hesse-Darmstadt, in the province of Rhein-Hessen, and 9 miles south-south-east of Mayence, gives name to a well-known and highly-prized variety of Rhenish wine, which is produced in the neighbourhood.

NIEUWVELDT MOUNTAINS, a portion of the most northerly of the three ranges of mountains in Cape Colony, which at various distances from the southern coast all run parallel to it. Of these three ranges, the most northern attains the greatest altitude, having an average height of 7000 feet. The portion known as the N. M. extend in lat. 31° 40' to 32° 30' S., and are intersected by the meridian of 22° E. long. From their southern slopes, the Gamka or Lion River draws its head waters; and from their northern, the Gariep or Orange River obtains an important tributary in the Upper Zak.

NIEVRE, a central department of France, occupies a portion of the watershed between the Loire and the Seine, and is bounded on the west by the rivers Allier and Loire. Area, 1,694,469 acres; pop. (1862) 332,814. Mountains occupy the eastern border, and extend in a line of heights from south-east to north-west, dividing the department into two great declivities. The soil is generally rocky and sandy, cut up by ramifications, almost always wooded, of the mountains of Morvan. There are several plateaux more or less fertile, a number of hills covered with vines, and valleys productive in pastures; but the principal wealth of the department consists in its forests and minerals. The Nièvre, whence the name of the department, is an inconsiderable affluent of the Loire from the right. The three chief rivers—the Allier, Loire, and Yonne—are navigable, and the Yonne, which belongs to the system of the Seine, is connected with the Loire by a canal leading across the watershed. Of the entire area, 792,000 acres are (1864) in cultivable land, and more than a third of the whole surface is covered with forests, the timber from which, forming one of the principal sources of wealth, is conveyed by water in great quantities to Paris, &c.

About 6,000,000 gallons of wine are made yearly. From the mines of N. iron of good quality is obtained in abundance; lead, copper, and silver are also found; and there are coal mines, and quarries of marble and granite. Arrondissements, Nevers, Château-Chinon, Clamecy, and Cosne; capital, Nevers.

NIFLHEIM (from the same roots as Lat. *nebula*, cloud, and Eng. *home*), meaning the abode of clouds, was one of the nine separate abodes or homes, of which the old Scandinavians conceived the world as consisting in the beginning of time. It is the kingdom of cold and darkness, and is separated from Muspelsheim, the kingdom of light and heat, by a huge chasm (Ginungagap, yawning gap). Here flows the spring Hvergelmir, watched by the dragon Nidhugger; this spring sends out twelve ice-rivers, from the drops of which, thawed by sparks from Muspelsheim, sprang the chaotic giant Ymir and the cow Audhumbla. N. was also the abode of Hel (q. v.), the goddess of death, who here received all who died of sickness or old age.

NIGELLA, a genus of plants of the natural order *Ranunculaceæ*, having five coloured spreading sepals; five or ten small two-tipped petals, with tubular claw; the carpels more or less connected together, many-seeded; the leaves divided into



Nigella sativa :
a, top of stem, with leaves and flowers; b, fruit.

threadlike segments, the flowers solitary at the top of the stem or branches. They are annuals, natives chiefly of the countries near the Mediterranean and the warmer temperate parts of Asia. Some of them, occasionally seen in gardens in Britain, are vulgarly known by the names *Devil-in-a-bush* and *Devil-in-a-mist*. The seeds are aromatic, and somewhat peppery. Those of *N. sativa*, a species common in cornfields in the south of Europe, are supposed to be the **BLACK CUMMIN** of the ancients, and perhaps the **CUMMIN** of the Bible. The seeds of a species of *N.* are much used by the Afghans for flavouring curries. [The figure of *Nigella sativa* or Black Cummin is given by mistake instead of the true Cummin in the article **CUMMIN**.]

NIGER, the great river of Western Africa. Its name, according to Dr Barth, is a contracted form of one of the native names, *N-eghrrèu*, which, as well as all the other names, *Dhùkùdà* (*Jokiba*), *Máyo*, *I'oa*, *Kwàra* (*Quorra*), and *Báki-n-ráwa*, means simply 'the river.' The principal head-water rises on the slopes of Mount Loma, a peak of the Kong Mountains, in a barren, desolate, and treeless region, in lat. 9° 25' N., long. 9° 45' W., about 1600 feet above sea-level. It flows north-east to Timbúktu,

where it bends eastward, and after flowing in that direction for about 250 miles, it curves toward the south, and proceeds in a general south-south-east course, until arriving at the head of its delta, in lat. about 5° 30' N., it separates into many branches, and enters the Gulf of Guinea, between the Bights of Benin and Biafra. It is called the Timbri for the first 70 miles of its course, after which it receives the name of the Jolibá, or more correctly Dhiúlibá; and after passing Timbuktu, it is known principally as the Quorra. Little is known of its course until it reaches Segó (lat. 12° 30' N.), a distance of 350 miles from its source, but from that point it has been explored throughout nearly the whole of its course. From Segó to Timbuktu it flows through a fertile country, producing rice, maize, and vegetables, and abounding in good pasturage. In lat. 14° 10' N., the river separates into two branches; the western is called the Jolibá or Mayo, the eastern the Bara-Isa. These, as they proceed, are known as the White and Black Rivers respectively; and they unite after enclosing the island of Jimballa, 220 miles in length, and from 2 to 20 miles in breadth. The river again bifurcates before arriving at Timbuktu, and after passing that town, the two branches, on one of which—the northern—Cabra, the port of Timbuktu is situated, again unite. In the district of union, in the south-west of Timbuktu, the country far and wide is intersected by numberless streams, forming a complicated net-work of water-courses. The river then flows east, sending off many creeks and branches to Bamba; its banks here are low and marshy, and during the rainy season are overflowed. In this region, rice, tobacco, wheat, and even barley are grown. The river then passes the town of Burrum, where it curves to the south-east, and from this point—called from the bend, the *Knee of Burrum*—it bears the name Kwara or Quorra until it reaches the delta. Immediately below *Burrum*, the N. does not present an imposing appearance. Its bed resembles a broad marshy valley, enclosed by ridges of rock or high dunes, thickly overgrown with reeds and sedges, and cut up by numberless streams and creeks. At the ferry of Burri (lat. 15° 55' N.), the breadth of the river is from 800 to 900 yards; and here the whole valley, about 10 miles broad, is fruitful, carefully cultivated, and well peopled. Further south, the towns of Garu and Sandu are passed, and here the bed is rocky and the navigation dangerous. At the town of Say, the N., after reaching a breadth of from 2500 to 3000 paces, is narrowed to a width of 1000 paces, flows at the rate of three miles an hour, and is enclosed by rocky banks. From Say to Wara, the course of the N. remains still unknown. From Wara, it flows east-south-east to Rabba; and from this town to its mouth, the course of the river is comparatively well known. In lat. between 8° and 7° 30' N., it flows round the eastern shoulder of the Kong Mountains (2000 to 3000 feet high), and here the banks of the N. are extraordinarily beautiful. In lat. 7° 40' N., it receives the Benne from the east. The delta consists of an immense mangrove forest, cut up into islands by the numerous branches (22 in number) of the river. The principal mouths are the Bonny, Mari, and Nun.

The existence of the N. seems to have been first made known in ancient times by travellers from the southern shores of the Mediterranean, who, crossing the great desert, came upon the upper course of a great river flowing toward the rising sun. This river Herodotus supposed to be a branch of the Egyptian Nile. Pliny speaks of the *Nigris* of Ethiopia, but he also thought that it flowed into the Nile. No definite notion of the river had

been formed until it was visited by Mungo Park in July 1796, when this traveller explored its banks for a distance of 160 miles. See *PARK, MUNGO*. Caillié explored the river from the town of Jennee to Timbuktu; and the English expedition of 1832, under Lander and Allen, proved that the Quorra was navigable from Boussa to the sea; information, however, which was obtained at an immense cost of human life from the unhealthiness of the climate. Subsequent expeditions have ended with similar results. In 1854, Dr Barth followed the course of the river from Timbuktu to Say, and much of what is now known about the N. is due to his labours. The entire length of the river is estimated at upwards of 2500 miles.—Barth's *Travels in Central Africa*.

NIGHT-HAWK (*Chordeiles Virginianus*), a bird of the Gostucker family (*Caprimulgidae*), very common in America, from the Arctic islands to the West Indies. It is a bird of passage, visiting the north in summer. It is about nine inches in length, and 23 inches in expanse of wing. The gape is destitute of bristles. The tail is slightly forked. The general colour is brown, but it is much mottled and marked with white; and there is a white mark on the throat, in shape like the letter V. The N. is seen pursuing its insect

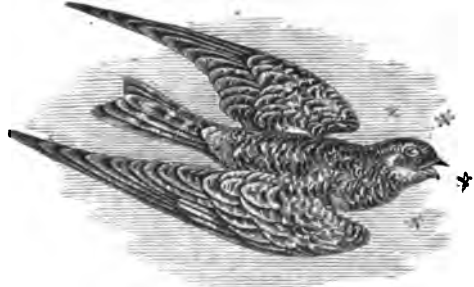

Night-hawk (*Chordeiles Virginianus*).

prey in the air, chiefly a little before sunset, and before dawn, and attracts attention by its rapid repetition of a sharp impatient cry, which has gained for it the name *Piramidig*. It produces also in its flight a remarkable hollow booming sound, 'like blowing into the bung-hole of a barrel,' in the moments of its perpendicular descent through the air. Its movements in the air are extremely beautiful and rapid. When fat and plump, as it usually is on its southward migration, it is esteemed for the table, and great numbers are shot.

NIGHT HERON (*Nycticorax*), a genus of *Ardeida* (see *HERON*), intermediate in form between bitterns and herons, but with shorter and thicker bill than either, and legs shorter than in herons. The COMMON N. H. (*N. Gardeni* or *Europæus*) is found in Europe, Asia, Africa, and North America, chiefly in the warmer temperate regions. It is most abundant in America, and is partly a bird of passage. It is a very rare visitant of Britain. Its length, from the tip of the bill to the end of the short tail, is fully two feet. It weighs nearly two pounds. Its plumage is soft, the general colour ash-gray, passing into black on the neck and head, and into white on the breast and belly. The back of the head is adorned with three very long white feathers, which hang down on the neck. The nests are built in trees, and in general many together, forming a *heronry*. The N. H. feeds chiefly by twilight or at night; and is never seen standing

motionless, like herons, but walks about in search of prey, by the sides of ditches, ponds, &c.; its food consisting chiefly of fishes, frogs, and other aquatic



Night Heron (*Nycticorax Gardeni*).

animals. Its cry is very loud and hoarse.—Other species of N. H. are found in Africa and Australia.

NIGHTINGALE, FLORENCE, famed for her labours in reforming the sanitary condition of the British army, is the daughter of William Shore Nightingale of Embly Park, Hampshire, and Leigh Hurst, Derbyshire, and was born at Florence in 1823. Highly educated, and brilliantly accomplished, she early exhibited an intense devotion to the alleviation of suffering, which, in 1844, led her to give attention to the condition of hospitals. She visited and inspected civil and military hospitals all over Europe; studied with the Sisters of Charity in Paris the system of nursing and management carried out in the hospitals of that city; and, in 1851, went into training as a nurse in the institution of Protestant Deaconesses at Kaiserswerth, on the Rhine. On her return to England, she put into thorough working order the Sanatorium for Governesses in connection with the London institution. Ten years was the term of apprenticeship thus served in preparation for the work of her life. In the spring of 1854, war was declared with Russia, and a British army of 25,000 men sailed to the East. Alma was fought on the 20th of September, and the wounded from the battle were sent down to the hospitals prepared for their reception on the banks of the Bosphorus. These hospitals were soon crowded with sick and wounded, and their unhealthy condition became apparent in a rate of mortality to which the casualties of the fiercest battle were as nothing. In this crisis, Miss N. offered to go out and organise a nursing department at Scutari. Mr Sydney Herbert, then at the war-office, gladly accepted, and within a week from the date of the offer—viz., on the 21st of October—she departed with her nurses. She arrived at Constantinople on the 4th of November, the eve of Inkermann—the beginning of the terrible winter campaign—in time to receive the wounded from that second battle into wards already filled with 2300 patients. Her devotion to the sufferers can never be forgotten. She has stood twenty hours at a stretch, in order to see them provided with accommodation and all the requisites of their condition. But she saw clearly in the bad sanitary arrangements of the hospitals the causes of their frightful mortality, and her incessant labour was devoted to the removal of these causes, as well as to the mitigation of their effects. In the spring of 1855, while in the Crimea organising the nursing-departments

of the camp-hospitals, she was prostrated with fever, the result of unintermitting toil and anxiety; yet she refused to leave her post, and on her recovery remained at Scutari till Turkey was evacuated by the British, July 28, 1856. She, to whom many a soldier owes life and health, had expended her own health in the physical and mental strain to which she had subjected herself. It is known that for years Miss N. has been an invalid. It is not so well known that her sick-room has been the scene of the most arduous and constant labour for the improvement of the health of the soldier. In 1857, she furnished the 'commissioners appointed to inquire into the regulations affecting the sanitary condition of the British army' with a paper of written evidence, in which she impresses, with the force and clearness which distinguish her mind, the great lesson of the Crimean War, which she characterises as a sanitary experiment on a colossal scale. Her experience in the Crimea, the results obtained by the labours of the sanitary commission, results accumulated under her own eyes, shewing that the rate of mortality among soldiers could be reduced to one-half of what it was in time of peace at home, turned the attention of Miss N. to the general question of army sanitary reform, and first to that of army hospitals. In 1858, she contributed two papers to the National Association for the Promotion of Social Science, on Hospital Construction and Arrangement, afterwards published, along with her evidence before the commissioners, by J. W. Parker and Son. The *Notes on Hospitals*, from their clearness of arrangement and minuteness of detail, are most valuable to the architect, the engineer, and the medical officer. In 1858, she published her *Notes on Nursing*, a little volume which is already among the treasured text-books of many a household. At the close of the Crimean War a fund was subscribed for the purpose of enabling her to form an institution for the training of nurses. The interest of the fund amounts to £1400 per annum; and though no separate institution has been formed, it is spent in training a superior order of nurses in connection with St Thomas's and King's College Hospitals. Last year (1863) was issued the Report of the Commission on the Sanitary Condition of the Army in India. The complete Report, with evidence, occupies two folio volumes of nearly 1000 pages each. The second of these huge folios is filled with reports from every station in India, occupied by British and native troops. These reports were sent in manuscript to Miss N., and at page 347 of vol. i. are inserted her observations upon this immense mass of evidence. In these observations, the facts are brought together in an order, and with an incisive force of statement, which render it one of the most remarkable public papers ever penned. That Report is likely to inaugurate a new era in the government of India; for the views of Miss N. extend not only to the sanitary reform of the British army, but to that of the towns of India. It is no mere impulse of benevolence that has claimed the devotion of one of the most remarkable minds of this age. It is the recognition of the divine laws of life for which she labours; and in her life and work we see, united in the service of humanity, the devotedness which animated the saints of heroic ages and the science which enlightens our own.

NIGHTINGALE (*Philomela*), a genus of birds of the family *Sylviadae*, approaching in character to the *Merulidae*, the young having their first plumage mottled, as in the thrushes, and the legs being longer than in the fauvelles and other *Sylviadae*, with which they are commonly classed. The bill is straight, slender, not quite as long as the head; the wings do not much pass beyond the base of the tail;

the first quill is very short, the third is the longest; the tail is slightly rounded.—The COMMON N. (*Ph. luscinia*) is well known as the finest of songsters. It is rather larger than the hedge-sparrow, with about the same proportionate length of wings and tail. It is of a rich brown colour above, the rump and tail reddish, the lower parts grayish-white. The sexes are alike. It is a native of many parts of Europe and Asia, and of the north of Africa; and is a bird of passage, extending its summer migrations on the continent of Europe as far north as the south of Sweden, but in Britain it has scarcely ever been seen further north than Yorkshire. It is plentiful in some parts of the south and east of England, but does not extend to the western counties, and never appears in Ireland. It frequents thickets and hedges, and low damp meadows near streams. The extensive market-gardens near London are among its favourite haunts. It feeds very much on caterpillars and other larvæ. It arrives in England about



Nightingale (*Phylomela luscinia*).

the middle of April, the males ten or fourteen days before the females. It is at this season, and before pairing has taken place, that bird-catchers generally procure nightingales for cage-birds, as they then become easily reconciled to confinement, whilst, if taken after pairing, they fret and pine till they die. The N. makes its nest generally on the ground, but sometimes on a low fork of a bush. The nest is loosely constructed of dead leaves, rushes, and stalks of grass, with a lining of fibrous roots. The eggs are four or five in number, of a uniform olive-brown. The song of the male ceases to be heard as soon as incubation is over. In captivity, however, it is often continued through a more considerable period. The N. usually begins its song in the evening, and sings with brief intervals throughout the night. The variety, loudness, and richness of its notes are equally extraordinary; and its long quivering strains are full of plaintiveness as well as of passionate ecstasy. The N. has been a favourite from most ancient times; and is often mentioned in the poetry of India and Persia, as well as of Greece and Rome. The loves of the N. and the rose are a fanciful theme in which eastern poets delight. The N. much resembles the redbreast in manners, and is equally pugnacious. It has been known to breed with the redbreast in captivity.—There is another and rather larger species of N. in the east of Europe, faintly mottled on the breast.

NIGHT-JAR. See GOATSUCKER.

NIGHTMARE (*Incubus*, *Ephialtes*) consists in a horrible dream, the terror being inspired by a sense of weight or oppression referred to the pressure of mountains, giants, hags, serpents, upon the

breast. It is attributed to acceleration or irregularity of the circulation in the chest or in the brain. It has been traced backwards to plethora, posture, heavy suppers; and forwards as a prognostic of heart disease or hydrothorax. It differs from ordinary dreams in possessing always the same characteristic of fear of some object in contact with the body, in a recognised inability to move or speak while there is a strong desire to do both, and in the presence of a semi-consciousness of the real source of the apprehension. The affection is recorded to have been epidemic; and modern instances have occurred where large communities have been agitated by night panics. A regiment of French soldiers, quartered in a ruined monastery, were awakened, at the same hour in two successive nights, by a black dog leaping on the breast of each. These veteran warriors, inured to danger, inaccessible to superstition, could not be prevailed upon to make a third trial. Such frightful impressions occur during the day, and during mere somnolency or drowsiness, but more generally at the moment of awakening during the night. The time, the distinct recollection retained of the circumstance, and the bodily perturbation which remained when consciousness was re-established, all conspired to convert these visions into the objective hobgoblins, the omens and supernatural revelations of past ages; and which still linger as matter of belief where the temperament or situation of the individual resemble those of our ancestors. In a very large number of instances such dreams represent, or are continuations of, the previous waking thoughts and emotions. They are so far voluntary that indigestible food or excess may induce them. Fuseli, for artistic purposes, created 'chimeras dire' in sleep by supping on pork chops.

NIGHTSHADE, the English name of certain plants of the natural order *Solanaceæ* (q. v.), possessing the narcotic properties frequently developed in that order. Among them are some species of *Solanum* (q. v.), particularly the COMMON N., or BLACK N. (*S. nigrum*), an annual or biennial, with



Common or Black Nightshade (*Solanum nigrum*).

erect angular stem, ovate, sinuate-dentate leaves, drooping lateral umbels of white flowers, and globose black berries; a frequent weed in waste places in England and in most parts of the world. Few

NIJMEGEN—NIJNI-NOVGOROD.

plants are more widely diffused. It is only slightly narcotic. The leaves, in a fresh state, are said to be injurious to animals which eat them, but seem to lose almost all narcotic property by boiling, and are used as spinach, particularly in warm climates. The berries, although generally dreaded or suspected, may also, it is said, be eaten, at least in moderate quantity, without danger. They contain, however, the alkaloid *Solanine*, found also in the shoots of the potato.—For **WOODY N.**, see BITTERSWEET. For **DEADLY N.**, see BELLADONNA. For **ENCHANTER'S N.**, see CIRCEA.

NIJMEGEN, NIMEGUEN, the *Noviomagus* of the Romans (*magnum* or *magen* being a Celtic word for a fixed dwelling), called by Tacitus *Bataworum oppidum*, in the middle ages *Nemaga*, is the principal city of the district of Nijmegen, or the Betuwe, in the Netherlands province of Gelderland. Pop. 25,000, of whom three-fourths are Roman Catholic. It is pleasantly situated, 9 miles south of Arnheim, on several little hills, on the left bank of the Waal.—Several of the streets are steep and narrow, passing up the Hoenderberg (*Hunenberg*, or Hill of the Huns), on which the Romans had a permanent camp in order to keep in subjection the country of the Batavians, which lay between the Rhine and the Waal; others are broad and well built. On a height stood, till 1797, when it was demolished by the French, the Castle of Valkenburg, said to have been built by Julius Cæsar. Here Charlemagne built a palace, and made the castle his residence. The site is now planted with trees, and forms a pleasant public walk overlooking the river and quay. On the brow of the hill there is a little sixteen-sided chapel or baptistery, which some think was originally a heathen temple of the Batavians, and converted into a Christian church by Pope Leo III. in 799. On another eminence, where the chateau of the Duke of Alva once stood, is a modern tower called Belvidere, from the summit of which there is an extensive view, including the rivers which branch off at the delta of the Rhine—viz., the Rhine, the Waal, and the Yssel, with the Maas flowing in the south. N. is strongly fortified and well garrisoned. The town-house, founded in 1554, is beautifully and antiquesly fitted up within, and externally ornamented by several statues of emperors and kings of the Romans. St Stephen's, or the Great Church, standing on the highest part of the city, is a handsome Gothic edifice in the form of a Greek cross, and before the Reformation contained 30 altars. N. is a large market for cattle and agricultural produce, especially grain. Beer is extensively brewed, Eau de Cologne distilled, and there are factories for spinning and weaving linen, cotton, and silk.

N. is celebrated for the great peace congress of the European powers which was held here, and, 10th August 1678, concluded a treaty between Spain and France; on the 17th September, between France and the United Netherlands; and between the German Empire and France, and the same empire and Sweden, 5th February 1679.

NIJNI-NOVGOROD, an important government in the east of Great Russia, between the governments of Vladimir on the west and Kazan and Simbirsk on the east. Area (according to the *Almanach de Gotha*, 1864) 19,390 square miles; pop. 1,259,606. The surface is divided into two distinct portions by the Volga with its tributary the Oka. On the left, the northern bank of the river, the surface is flat; on the right bank it is hilly. As the soil is not very fertile, and there are few rich meadow-lands, neither agriculture nor cattle-breeding is pursued extensively. The inhabitants are

principally engaged in manufactures. The chief rivers are the Volga, Oka, and their numerous tributaries. There is communication by water with 24 governments, and with the Baltic, the White, and the Caspian Seas. The northern districts of the government abound in forests, and here wooden utensils and tools are manufactured for the adjoining governments. There are several large iron-works, and the town of Gorbatof is the Sheffield of its district. Leather, especially that variety called Russian leather, is largely manufactured, and sheep and lamb skin dressing is a staple employment. On the right bank of the Oka are several ship-building and dock-yards. The towns and villages are filled with an industrious and thriving manufacturing population. Capital, Nijni-Novgorod (q. v.).

NIJNI-NOVGOROD (Lower Novgorod), a famous commercial and manufacturing town in the east of Great Russia, capital of the government of the same name, is situated at the confluence of the Oka with the Volga, in lat. 56° 20' N., long. 44° 1' E., 715 miles east-south-east of St Petersburg, with which, since 1862, it has been connected by railway. The fortified portion of the town occupies a hill overlooking the Volga, and is surrounded with a wall. It contains the Kremlin or citadel, two cathedrals, the palaces of the governors, and an obelisk 76 feet high, in memory of Minin and Pojaraky, the deliverers of Moscow. The town possesses several rope-walks, dock-yards, ironworks for building steamers, three steel-cutlery works, &c. The commercial portion of N. is situated on a projecting point of land which forms the right bank of the Volga and the left bank of the Oka. It has an area of 350 acres, consists of 60 ranges of brick buildings, is surrounded by a canal, and contains 2520 shops, a Russian cathedral, an Armenian church, a mosque, a temporary branch of the state bank, counting-house, post-office, &c. Here the great annual fair is held; but the commerce of N. is not confined to this area. On the further side of the canal are ranges of wooden erections, containing 5000 shops, exclusive of taverns, baths, and other public establishments. The fair, which lasts over a month, is officially opened on the 27th July; but, owing to the tardy arrival of the Chinese and Siberian goods, a day or two generally intervenes before it actually commences. With the opening of the fair, the town becomes rapidly filled with merchants from every country and climate—Europeans, Bokharians, Khivans, Kirghizes, Tartars, Armenians, Persians, and even Chinese. The merchants are required to pay nothing in the way of taxes during their stay, except, indeed, the rent of the shops they occupy, and every one has the privilege of trading freely without any exaction from the crown. The fair of N. is of great commercial importance, especially with respect to the eastern and central provinces. The value of goods disposed of during the fair is great, and seems to be continually on the increase. In 1697, the value of the goods sold was £14,000; in 1741, £81,000; in 1790, £5,000,000; in 1857, £14,000,000; in 1861, £16,038,000; in 1863, £16,760,000. The articles gathered at the fair for sale may be divided into three groups as follows: 1. *Russian raw and manufactured goods*, consisting chiefly of cotton stuffs, linen and woollen goods, furs, metals, corn, drysalter's goods, chemicals, &c., the total value of which was 74,488,400 roubles. 2. *European and Colonial goods*, of which the manufactured goods amounted to 2,964,600 roubles; wines, 1,990,900 roubles; colonial goods, chemicals, &c., 6,294,800 roubles; total, 11,250,300 roubles. 3. *Asiatic goods*: Chinese (chiefly tea), 8,218,000 roubles; Bokharian and Khivan silks and cottons, 2,337,000 roubles;

Caucasian and Armenian, 4,199,200 roubles: total, 14,754,200 roubles. Grand total, 100,492,900 roubles.

N., an ancient town, was founded in 1221 by Prince Yury Vsevolodovitch as a stronghold against the invasions of the Bulgarians and the Mordva. It was devastated on several occasions by the Tartars; and in 1612, during the civil dissensions in Russia, when it was on the point of falling a prey to Poland, Minin, the famous butcher of N., collected an armed force here, which, under Prince Pojaraky, drove the invaders from the capital. See Moscov. The prosperity of this town dates from the year 1817, when the great fair was removed to N. from Makarief, on account of the destructive fire which broke out in the latter place, and destroyed the greater portion of the stores and magazines. The normal population of the town is (1864) 36,350; but it is increased to upwards of 200,000 during the fair. N., so favourably situated for purposes of commerce, carries on a brisk trade during the whole season of navigation, and especially in spring during full water.

NIJNI-TAGILSK, a town of Russia, in the government of Perm, situated on the river Tagil, amid the Ural Mountains, 150 miles east of the city of Perm. It is one of the most important mining towns in Russia, or in the world. The soil in the immediate vicinity is everywhere rich in iron, copper, gold, and platina; not far off is the famous magnetic mountain Blagodot, 1422 feet high. Akimfi Demidoff (q. v.) established the first foundry here in 1725. The yield both of iron and copper is immensely large. Pop. 25,000.

NIKOLAEV, a town of South Russia, in the government of Kherson, and 40 miles north-west of the town of that name, stands 25 miles above the mouth of the Bug, and at the confluence of that river with the Ingul. It was founded in 1790, and its situation was found so convenient for ship-building purposes, that it soon became the centre of the naval administration of the Black Sea. It has broad straight streets, contains several barracks, a cathedral, schools for pilots, hospitals, an observatory, and an arsenal. During the period of its greatest prosperity (from the beginning to the middle of the present c.), 10,000 men were employed at N. in ship-building and other naval operations. Since the treaty of Paris in 1856, N. has lost much of its former importance. Pop. 33,500.

NIKOLAEVSK, chief town of the Amur territory, in Eastern Siberia, situated on a well-wooded plateau on the left bank of the Amur, and 22 miles from its mouth, in lat. 53° 15' N., long. 140° 35' E., 6750 miles east from St Petersburg. It contains a wooden church with one large and five smaller steeples, the town residence of the governor, and the storehouse of the Amur Company. The approaches to the town are defended by four batteries, which command the upper as well as the lower part of the river. The Amur is here a mile and a quarter broad, but the landing-place is available only for small craft, all large vessels being compelled to lie in mid-stream. It was founded in 1851; in 1855, it consisted of 150 houses, and in 1858, of 249 houses. It is the seat of naval and civil administration, and the centre of the commercial activity of the district. Goods from the interior of Siberia and China are brought hither and shipped in foreign (chiefly American) vessels; and Siberian tradesmen now receive and despatch their goods by sea, as the land route formerly pursued was both tedious and expensive. Rich and extensive forests clothe the banks of the river, and the abundant pastures offer facilities for cattle-breeding. The chief hindrance to the rapid improvement of the

settlement is a want of hands and capital. A line of telegraph already extends from St Petersburg to beyond Irkutak, and is in process of extension to Nikolaevsk. Mean temperature throughout the year, 39° 42'. Pop. (1858) 2552.

NIKOLSBURG, or MIKULOV, a town of Austria, in the south of Moravia, 27 miles south of Brunn, lies at the foot of the Pollaver Hills, famous for their rich red wines. The town belongs to the princely family of Dietrichstein. It has several steam-mills, and cotton and silk factories. In the middle of the town, upon a rock, stands the Castle of the Dietrichsteins, with a library of 20,000 volumes, and a vat in the cellars capable of containing 2000 eimers. Pop. 9400, of whom more than a half are Jews.

NIKOPOL, a thriving town of Southern Russia, in the government of Ekaterinoslav, on the right bank of the Dnieper, about 200 miles from its mouth, in lat. 47° 33' N. N. is the centre of an extensive agricultural district, the produce of which is here shipped to Odessa. Between N. and the port of Odessa, there is regular communication by steam-boat. The natural advantages of N. promise to make it one of the principal commercial centres on the Dnieper. Pop. 7260.

NILE (*Nîlus*), called by the Egyptians, *Hapi Mu* (the genius of the waters), and by the Hebrews *Sihor* (the black), the river of North-eastern Africa formed by the union of the Bahr-el-Abiad (the White or True Nile) and the Bahr-el-Azrek (Blue Nile). The source of the first of these, the True Nile, or at least its great feeder, has at last been discovered by Captains Speke and Grant in the Victoria Nyanza Lake, which extends from about lat. 0° 20' N. to 2° 50' S., and from long. 31° 40' to 35° E., and is 3740 feet above the sea. The second has its source in Abyssinia, in lat. 10° 59' N., and long. 36° 55' E. From its outfall from Lake Victoria Nyanza at the 'Ripon Falls,' lat. 0° 20' N., long. 33° 30' E., the White Nile flows in a north-north-westerly direction as far as Gondokoro, which is in lat. 4° 55' N. and long. 31° 50' E., and 1900 feet above the sea. Several moderately-sized streams are supposed to flow out of the lake on each side of the main source. These are the Kafu and the Luajerré on the west, and the Asua on the east, the former joining the main stream in the Unyoro, the latter in the Madi country. After issuing from the lake, the Nile passes a range of sandstone hills, then rushes down due north with the beauty of a mountain torrent, running off at last into long flats, more like a lake than a river. In the Kidi country it is navigable as far as the Karuma Falls, where it rushes on with boisterous liveliness. In the Madi country the Nile has its well-known character of long flats and long rapids.

At the junction of the Asua River, in the Madi territory, lat. 4° 40' N., Captain Speke's discoveries terminated, for to this point the ivory-traders had ascended the Nile from Gondokoro. For about 500 miles after this, the river flows very tortuously, first in a north-westerly and then in a north-easterly direction, and is joined in about lat. 9° 15' N., long. 30° E., by its first great affluent, the Bahr-el-Gazal, which joins the Nile from the west with hardly any perceptible current. The second tributary is the Giraffe River, about one-third the volume of the Nile at its point of junction, long. 31° E. Its source is not known, but its character suggests the possibility of its coming from Lake Nyanza. From the Bahr-el-Gazal the Nile flows in a due easterly direction for about 80 miles, then south for 30 miles, when it is joined by its third tributary, the Sobat River, from the east.

The Sobat is full and navigable. Between this and the town of Khartoum, a distance of about 460 miles, the Nile runs in a northerly direction, with a width of from one to two miles, and is joined by several streams from the east side.

Khartoum, the capital of Nubia, is situated at the confluence of the Bahr-el-Azrek (Blue Nile) and the Bahr-el-Abiad (White Nile), 1188 feet above the sea-level, in lat. 15° 35' N. long., 32° 30' E. The Bahr-el-Azrek, long supposed to be the main branch of the True Nile, is formed by the junction of the Abai and the Blue River. The Abai has its source in Abyssinia, 50 miles from Lake Dembea, which it enters from the south-west; emerging on the south-east of the lake, it flows for about 90 miles in that direction, when it describes a semi-circle round the peninsula of Godjam, and continues north-westerly for about 150 miles. It is here joined by the Blue River from the south, and from this point the Blue Nile flows north-west to Khartoum, receiving from the east two large rivers running nearly parallel to each other, the Dender and the Rahad or Shimfa. From Khartoum, the united stream flows north for about 60 miles, passing the town of Halfais and the ruins of Meroë to the first cataract, and thence north-east past Shendy (q. v.) to its junction with the Atbara, which enters the Nile at El Damer, lat. 17° 45' N., long. 34° E.

The Atbara, also called Bahr-el-Aswad, or Black River, because it carries down with it the greatest amount of the black mud and slime that manures and fertilises Egypt, is the last tributary received by the Nile. The Goang seems to be the direct source of the Atbara. It rises in the heights to the north of Lake Dembea. About 150 miles from its source it receives the Basalam River, and about 30 miles further on, the Takazze and Setit River, both from the east. The Takazze has a far greater volume of water than either of the preceding rivers. It rises in the Samen Mountains, round which it flows first easterly, then north, till in about lat. 13° 30' N., long. 38° 50' E. it turns north-west, and then almost due west, joining the Atbara at right angles. It has many tributaries.

From its junction with the Atbara, the Nile continues to flow northerly through the populous and fertile district of Berber, full of villages, and then enters the desert. Turning westwards, in lat. 19° N., it forms the large island of Mograt, and makes a curve to the south-westward, known as the 'great bend,' in which there are two cataracts. Entering Nubia, the Nile resumes its north-westerly course, with narrow strips of cultivated land on each bank. Here it forms another cataract, and bends round to the north-east with a fifth cataract, in lat. 21° 40' N. After this the valley of the Nile narrows, and at Assouan, in lat. 24° 10' N., it forms the last cataract in descending.

From Assouan to the sea, the average fall of the Nile is two inches to a mile, and its mean velocity about three miles an hour. It waters and fertilises the whole length of the land of Egypt. The delta of the Nile extends from lat. 30° 10' N. to 31° 30' N., and has a base on the Mediterranean of about 150 miles. In it the Nile spreads out into numerous streams, the two principal being those of Rosetta and Damietta. The total length of the Nile, from its exit from the lake to the sea, is about 3300 miles, measured along its course, or 2200 miles direct distance.

A feature peculiar to the river of Egypt is, that from its junction with the Atbara, to its mouth, a distance of upwards of 1500 miles, it receives no affluent whatever, and yet it is able to contend with the burning sun, and scarcely less burning sands of Nubia. With the ancient Egyptians

the river was held sacred: the god Nilus was one of the lesser divinities. Its annual overflow is one of the greatest marvels in the physical geography of the globe, for it has risen to within a few hours of the same time, and to within a few inches of the same height, year after year for unknown ages. At Khartoum it begins to increase early in April, but in lower Egypt the inundation usually begins about the 25th of June, and attains its height in three months. It remains stationary about twelve days, and then subsides. The cultivable soil of Egypt is wholly dependent on the rise of the Nile, and its failure causes a dearth; for, virtually, the country has no rain. Continuous south-wind brings a good, and north-wind a bad year. During a good inundation, the rise is about 40 feet on the Tropic of Capricorn, 36 feet at Thebes, and 4 feet at the Damietta and Rosetta mouths in the Delta. If at Cairo the rise is only 18 or 20 feet, there is a scarcity; up to 24 feet, a deficiency; 25 to 27 feet is good: more than that causes a flood, and fosters plague and murrain. During the inundation, the whole valley is covered with water, from which the villages rise like islands, protected by dykes. Of late years the overflow has been greater than the average of many centuries. The rise and fall of the trunk stream of the lower Nile is owing to the periodicity of the rains on the mountains of Abyssinia and in the basin of Lake Nyanza, where, on the equator, it rains, more or less, all the year round, most copiously during the equinoxes. The banks of the Nile swarm with birds, among which are vultures, cormorants, geese, pelicans, quails, and the white ibis; and its sweet, soft waters teem with fish. The average amount of alluvium brought down by the river is estimated at a deposit of 4½ inches in a century—by some, it is made as high as 6 inches; the greater part of it is brought down by the Atbara.

The question of the source of the Nile is at once the oldest and the most recent of geography. It was a puzzle in the time of Moses, and long before his time. That the sources of a river, at whose mouth one of the earliest and most civilised peoples was established, should have been so long veiled in obscurity, is unparalleled in geographical research. The want of success in exploring the upper basin of the Nile may be attributed to the great length of the river, to the difficulties which beset the traveller in the physical nature of the countries he must pass through, the climate, and the jealousy, ignorance, and barbarism of the native tribes. This problem of centuries has now been in so far satisfactorily solved, for the question remains, whether there may not yet be found feeders of the White Nile carrying back its source to a still greater distance in the interior; a question which further research alone can answer. The journeys of Krapf and Rebmann to the foot of Kilimandjaro and the other snowy mountains in the east of Africa, believed by them to be the ancient and almost fabled 'Mountains of the Moon,' and the explorations of travellers up the White Nile, pointed to the conclusion that it was among these that the sources of the great Egyptian river would ultimately be discovered.

There was, however, another theory. Rumours gathered from the natives pointed to lakes in the regions south of the equator, as the true sources of the Nile. To explore this country, the distinguished traveller Captain Richard Burton, accompanied by Captain Speke, started from the Zanzibar coast in 1857. Their enterprise was so far successful that they discovered Lake Tanganyika, in lat. 5° S., long. 36° E., and a large crescent-shaped mass of mountains, overhanging the northern half of the lake, and 10,000 feet high, considered by Captain

NILE—NILOMETER.

Speke to be the true Mountains of the Moon. On the shores of Lake Tanganyika, Burton was laid up by illness, and his companion, after surveying the northern portion of the lake, left him there to recruit his health, while he (Speke) proceeded northwards to discover another huge 'nyanza' or lake, of the existence of which he was informed by the natives. This he accomplished on the 3d of August 1858, when he discovered the southern end

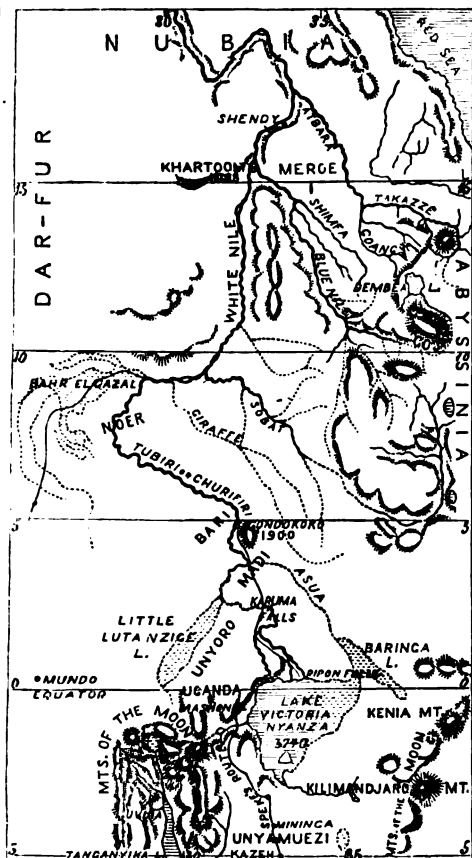

The Upper Course of the Nile.

of the Victoria Nyanza (q. v.). In his journal he says of this immense sheet of water: 'I no longer felt any doubt that the lake at my feet gave birth to that interesting river, the source of which has been the subject of so much speculation, and the object of so many explorers.' The idea of descending the Nile from the Nyanza seems at once to have struck him; but as at that time his preparations were quite insufficient, he was reluctantly compelled to return to Europe.

Judging that he was in a fair way to solve the great African problem, Captain Speke, taking with him Captain Grant, returned to the lake region in 1861. The expedition approached the Victoria Nyanza again from the coast of Zanzibar; and the first place from which they obtained a view of it during the second expedition, was the town of Mashonde on its western side. Thence they pursued their way along the shore northwards. The land above the lake was found to be composed of low sandstone hills, covered with gigantic grass of unsurpassed verdure, and by dells of trees as tall

and straight as the blue gums of Australia. Crossing the equator, they reached streams which are said to flow out of the lake, and further on, in the centre of its northern coast, the parent stream of the Nile, 150 yards in breadth, flowing over rocks of an igneous character, and forming falls 12 feet high, which Captain Speke christened the 'Ripon Falls,' in honour of the president of the Royal Geographical Society at the time of his starting on the expedition. It is from the west that the lake receives its largest supplies of water through the medium of smaller lakes. These derive their moisture from the so-called 'Mountains of the Moon,' which are situated in the middle of the rainy zone, where Captain Speke observed that no fewer than 233 days in the year were more or less wet days.

In the kingdom of Karagwé, Captain Speke found a very superior negro race, much better disposed to strangers than any of the tribes he had formerly passed through. The country occupied by this race, and that of Uganda, stretches along the Nyanza, and covers half of its western and northern shores, the Uganda being bounded on the east by the main stream of the Nile. The sultan of Uganda exercises an absolute power over his people. He (the sultan) had a knowledge of the navigation of the N. by white men, and was desirous of establishing a commercial intercourse with Gondokoro, but was prevented by the hostility of the tribes to the north of his own. Speke was detained a prisoner for five months in this kingdom, but was treated with the greatest hospitality, though his movements were closely watched until he got into the neighbouring kingdom of Unyoro.

North of Unyoro, the dialects belonging to the language of South Africa, and which up to this point are used by the various tribes, suddenly cease, and give place to those of the language of North Africa.

With regard to the civilisation of these three kingdoms of Karagwé, Uganda, and Unyoro, Speke does not hesitate to give the preference to the first, and represents the king, Rumanika, as an intelligent, honest man. Mtéaa, the sovereign of Uganda, is an amiable youth, taking pleasure in field exercises; but one rule of his court requires that a human sacrifice be offered daily for the good of the state. The king of Unyoro, Kamrasi by name, is represented as a harsh, suspicious, and pitiless creature, his principal occupation being the exercise of his unbridled authority.

The travellers spent a whole year in making their way through these three kingdoms, into which no white man had ever before penetrated, and only succeeded in getting away by making numerous presents, and still more numerous promises. Besides ascertaining the latitude and longitude of all the important points on the route, the travellers made numerous meteorological observations.

NILOMETER (the measurer of the Nile), the name of two buildings existing in Egypt, one in the island of Rhoda, opposite to Cairo, the other at Elephantine, close to Assouan, in 24° 5' 23" N. lat. The first consists of a square well, in which is placed a graduated pillar of marble, and is called a *mekkiar* or measure; the pillar contains 24 *devakhs* or cubits, each of which measure 21·386 inches, or according to Greaves, 1·824 feet, and contains 24 digits; but in its present state, it does not appear to have been intended to mark a rise of more than 16 cubits. This pillar is exceedingly slender. The building formerly had a dome, bearing a Cufic inscription, dated 847 A.D., and is said to have been erected by the Calif Mamun, or his successor Wathek Billáh. The first-mentioned monarch is said to have erected another nilometer at the village

of Banbenouda, in the Saeed, and to have repaired an old one at Ekhnin. The Calif El Motawukkel built the present one. The mode of calculating the increase at the nilometer is rather complex, and to a certain extent arbitrary, political and financial reasons rendering the process a mystery even to the natives. At the present day the Nile is supposed to have risen to 18 cubits when the canals are cut; this is the height of the lowest inundation; 19 cubits are considered tolerable, 20 excellent, 21 adequate, and 22 complete, 24 are ruinous. In the time of Edrisi, however, 16 cubits were considered sufficient. The object of these nilometers was to measure the amount of taxation to be imposed on the country. The nilometer at Cairo is, however, much more recent than that existing at Elephantine, which consists of a staircase between two walls descending to the Nile. One of these walls has engraved on it a series of lines at proper intervals marking the different elevations to which the river rose under the Cæsars. The cubits here are divided into 14ths or double digits, and measure 1 foot 8.625 inches. This nilometer is described by Strabo. The probability is, that many nilometers existed in the days of the Pharaohs, probably one in each city. In the days of Meris, 8 cubits were sufficient, but 15 or 16 were required in the time of Herodotus, 456 B.C., and this was the mean under the Romans. According to Pliny, if the inundation did not exceed 12 cubits it produced a famine, 13 starved the country, 14 rejoiced it, 15 was safety, and 16 delight, and this number is symbolically represented by the number of children playing round the river god on statues of the Roman period. The oldest nilometer appears to have been erected at Memphis, and it was transferred by Constantine to a church in the vicinity of the Serapeum; but Julian sent it back to this temple, where it remained till its destruction by Theodosius. At the present day, the rise is watched for with anxiety, and proclaimed by four criers.—Herodotus, ii. 13; Strabo, lib. xvii.; Wilkinson, *Topogr. of Thebes*, pp. 311—317. Hekekyan Bey, *Siriadic Monuments* (Lon. 1863), p. 145.

NIMBUS, in Art, especially in Sacred Art, is the name given to the disc or halo which encircles the head of the sacred personage who is represented. Its use is almost universal in those religions of which we possess any artistic remains—the Indian, the Egyptian, the Etruscan, the Greek, and the Roman. In the Hebrew scriptures, we trace, in the absence of representations, the same symbolised idea in the light which shone upon the face of Moses at his return from Sinai (Exod. xxxiv. 29—35), and in the light with which the Lord is clothed as with a garment, Pa. ciii. 1, Vulg. (civ. 1, auth. vers.); and in the New Testament in the transfiguration of our Lord (Luke ix. 31), and in the 'crowns' of the just, to which allusion is so often made (2 Tim. iv. 8; 1 Peter v. 4; Apoc. iv. 4). Nevertheless, the nimbus, strictly so called, is comparatively recent in Christian art, appearing first towards the end of the 5th century. Later in Christian art, it became almost a necessary appendage of all representations of God or of the saints. Its ordinary form is the circular or semi-circular; a form, indeed, in which later symbolists discover an emblem of perfection, and of eternity; but the nimbus of the Eternal Father is often in the form of a triangle, and that of the Trinity an emanation of light, the rays of which form the three arms of a cross. The nimbus of the Virgin is sometimes a simple ring, and sometimes a crown or diadems; occasionally it is encircled by an ornamental border, on which twelve stars are sometimes represented. Her nimbus, as well as that of

the Divine Persons, is commonly of gold; but that of the Virgin Mary is occasionally in colours, as blue, red, purple, or white. The nimbus of the saints is ordinarily the semicircle or lunula. Dedron mentions the curious instance of a picture of the traitor Judas *with a black nimbus!* In later art, the nimbus became lighter and more ærial, melting, as it were, into the picture; and in Raphael's saints it occasionally fades into the very faintest indication of a golden tinge around the head. In connection with the nimbus may also be mentioned two analogous forms—the *Aureole* and the *Glory*. The former is an illumination surrounding, not the head only, but the entire figure. If the figure be upright, the aureole is commonly oval, when it is called the *vesica piscis*, and is supposed to contain an allusion to the *ictyus*. With a seated figure it becomes circular, and is occasionally divided by radiating bands, in the form of a wheel; sometimes it takes a quatrefoil form. It is commonly of gold, but occasionally also is in colours. The *Glory* is a combination of the nimbus and the aureole, and is chiefly seen in Byzantine pictures, and those of the early South German school.

NIMEGUEN. See NĪMEGEN.

NĪMES (anc. *Nemausus*), a town of France, capital of the department of Gard, stands in a fertile plain surrounded by vine-clad hills, 30 miles north-east of Montpellier, with which it is connected by railway. It consists of the town proper (ill built and dirty), and of three handsome suburbs. In the vicinity are the beautiful remains of the Roman aqueduct called the *Pont du Gard*. The chief of the modern edifices are the *Palais-de-Justice*, the theatre, and the hospitals. The *Grande Place* is embellished with one of the most magnificent fountains in France. N. contains numerous and variously-constituted educational institutions, an important public library, Maria Theresa's Museum (in the *Maison Carrée*), a museum of natural history, &c. It is the general entrepôt for the silks produced in the south of France, and its manufactures are principally silk and cotton fabrics. More than 10,000 looms are constantly in operation in the city, and about 6000 in the immediate vicinity. Shawls, handkerchiefs, lace, brandy, wines, &c., are made. Within the town are numerous and beautiful Roman remains, the chief of which are the amphitheatre; the *Maison Carrée* (Square House), a fine specimen of Corinthian architecture; a temple and fountain consecrated to Diana; *La Tour Magne* (Great Tower); the baths, and two Roman gates. See Menard's *Histoire des Antiquités de la Ville de N. et de ses Environs* (1838). Pop. 50,882.

Previously to the Roman invasion, N.—which is supposed to have been founded by a colony from Massilia (Marseille)—was the chief city of the Volcæ Arecomici. It flourished under the Romans, and was one of the great cities of Gaul. It surrendered to the rule of the Visigoths between 465 and 535, and afterwards to that of the Franks. Subsequently, it became a possession of Aragon; but was finally restored to France in 1259 by the treaty of Corbeil. The inhabitants adopted Calvinism in the 16th c., and on many occasions suffered severely for their religious principles. In 1791 and 1815, bloody religious and political reactions took place here.

NĪMROD. See BABYLON.

NINEVEH, or NINUS, a very ancient and famous city, the capital of the great Assyrian empire, said in Scripture (Gen. x. 11) to have been founded by Ninus or Nimrod. It was situated on the east bank of the Tigris, opposite to the present

Mosul. According to the accounts of the classic writers, the city was of vast extent, 480 stadia, or more than 60 miles in circumference. Its walls were 100 feet high, broad enough for three chariots, and furnished with 1600 towers, each 200 feet in height. In the *Book of Jonah* it is described as an 'exceeding great city of three days' journey,' and one 'wherein are more than sixscore thousand persons that cannot discern between their right hand and their left hand' (children or infants are probably meant). After having been for many centuries the seat of empire, it was taken after a siege of several years and destroyed by the united armies of the Medes under Cyaxares, and the Babylonians under Nabopolassar, about 625 B. C. When Herodotus, not quite 200 years afterwards, and Xenophon visited the spot, there remained only ruins. Tradition continued to point pretty accurately to the site of N.; but it is only of late years that actual explorations have been made. For an account of these, see ASSYRIA.

NINGPO, a department in the province of Chekiang, China, comprising the city of that name, the Chusan group of islands, and the cities of Tsike, Fungwa, Chinhai, and Tsangshan. The port of N. is situated at the confluence of two small streams, in lat. 29° 55' N., long. 121° 22' E., 12 miles from the sea, on an alluvial flat of extreme fertility, intersected by a net-work of rivulets and canals. Its walls are five miles in circumference, about 25 feet high, 22 feet wide at the base, and 15 at the top, with six double gates. As is the case with all the cities in this part of China, N. is permeated by canals communicating with a moat nearly surrounding the walls, and with the adjacent country. In one part of the city they expand into basins, and receive the name of lakes—the Sun Lake and Moon Lake. In the former, is an island devoted to temples, and accessible by bridges. These bridges—good specimens of those aerial stone edifices which adorn this part of China—are required to sustain little more than their own weight, as the roads here are all mere footpaths, and no wheeled vehicles are found. One of the rivers is crossed by a bridge of boats, 200 yards long. The entire city is well paved; the streets are wider than those of most Chinese cities, and the display of shops is indicative of wealth and luxury. Nowhere, save at Hanchau, are such extensive and beautiful temples to be found. The most elegant and costly of these is dedicated to the Queen of Heaven; the goddess being the daughter of a Fuhkien fisherman, the people of that maritime province are her more special votaries. Elaborate stone sculpture, exquisitely fine wood carving, and a profusion of gilt and tinsel, shew that no expense has been spared to honour the popular goddess.

The centre of the city is ornamented with an elegant seven-storied hexagonal tower—the heaven-bestowed pagoda, 160 feet in height. A spiral flight of steps within the walls of the tower lead to the summit, from which the gazer beholds a splendid scene; innumerable villages dot the plain, which is reticulated by silvery water-courses, replete with evidence of successful commerce and agriculture. The population of the city is about 300,000; that of the plain, about 2,000,000. On many of the hills which environ these cities, green tea is successfully cultivated; while the mulberry, the tallow-tree, and numerous other stimulants of industry abound. Two crops of rice are procured annually from the fields; while the fisheries of the rivers and adjacent coast give employment to a numerous class of the population. Ice-houses close to the river give the banks a picturesque appearance; the ice is used for curing fish. N. has an extensive coasting trade;

but no considerable foreign trade has been developed, owing mainly to portrages on the inland water-communications, and to the proximity of Shanghai, where no such obstructions exist. The district city of Chinhai, at the mouth of the Ningpo River, is also a port. A walled town, containing about 30,000 inhabitants, 10 miles to the east of Chinhai, is Kingtang, the nearest of the Chusan archipelago. Tinghai is the district city of the island of Chusan, which is 20 miles long, from 6 to 10 wide, and 51 in circumference. It is mountainous, with fertile valleys in a high state of cultivation. It has an excellent harbour. Tinghai was garrisoned several years by Her Majesty's forces from 1841, and was again temporarily occupied by the allied forces in 1860.—Dr Macgowan's *Lectures*.

NINIAN, St, the apostle of the Picts, lived in the latter half of the 4th and the beginning of the 5th century. Whether Christianity had been introduced among the Picts before the time of N. has been a subject of controversy; but although the details of the legendary account are uncertain, it seems, beyond all question, that some Christians were to be found, at least among the Southern Picts, in what is now known as the Lowlands of Scotland, from the end of the 2d century. Nevertheless, either their number was originally very small, or the rising church had fallen away under adverse circumstances; and it is certain that when N. appeared among them, the Picts were in the main a pagan people. He was a Briton, and of noble birth; but had been educated at Rome, and there ordained a bishop. The exact time of his preaching in Scotland is unknown. His labours appear to have commenced in Cumbria, and to have extended over the greater part of the district as far north as the Grampian Hills, his see being fixed at Candida Casa, or Whithorn in the modern Wigtonshire. His death is placed by the Bollandists in 432; his festival is the 16th September.

NINON DE LENCLOS, a celebrated French-woman, one of those characters that could have appeared only in the French Society of the 17th c., was born of good family at Paris in 1615. Her mother tried to imbue her mind with a love of the principles of religion and morality, but her father, more successfully, with a taste for pleasure. Even as a child she was remarkable for her beauty and the exquisite grace of her person. She was carefully educated, spoke several foreign languages, excelled in music and dancing, and had a great fund of sharp and lively wit. At the age of ten she read Montaigne's *Essays*. Six years later, she commenced her long career of licentious gallantry by an amour with Gaspard de Coligny, then Comte de Chatillon. To Coligny succeeded innumerable favourites, but never more than one at a time. Among N.'s lovers we may mention the Marquis de Villarceaux, the Marquis de Sevigné, the Marquis de Gersay, the great Condé, the Duc de la Rochefoucauld, Marshal d'Albret, Marshal d'Estrées, the Abbé d'Effiat, Gourville, and La Châtre. She had two sons, but never shewed in regard to them the slightest instinct of maternity. The fate of one was horrible. Brought up in ignorance of his mother, he followed the rest of the world, and conceived a passion for her. When she informed him of the relation that subsisted between them, the unhappy youth was seized with horror, and blew out his brains in a frenzy of remorse. Even this calamity did not seriously affect N.; she was too well-bred to allow it to do that. N. was nearly as celebrated for her manners as for her beauty. The most respectable and virtuous women sent their

children to her house to acquire taste, style, politeness. So great was her reputation, that when Queen Christina of Sweden came to Paris, she said she wished particularly to visit the French Academy and Ninon de Lenclos. We may gather some idea of her wit and sense from the fact that La Rochefoucauld consulted her upon his maxims, Molière upon his comedies, and Scarron upon his romances. She died 17th October 1706, at the age of 90, having preserved some remains of her beauty almost to the last.—See Guyon de Sardière's *Vie de Ninon de Lenclos*; Saint-Evremond's *Œuvres*; Douxmesnil's *Mémoires pour servir à l'Histoire de Mlle de Lenclos*.

NINTH, in Music, the next interval above the octave, being the same interval which an octave lower is termed the second. See INTERVAL.

NIOBÉ, in Greek mythology, the daughter of Tantalus and (according to the most popular version of the story) the sister of Pelops. She was the wife of Amphion, king of Thebes, and bore him six sons and six daughters. Proud of her children, she despised Leto or Latona, who had only two children, Apollo and Diana, and prevented the people from the worship of these divinities; whereupon Latona, enraged, moved her children to destroy all the children of N. with their arrows. They lay nine days in their blood unburied, when Jupiter changed them into stone, and on the tenth day they were buried by the gods themselves. N. wandered about in distress, and at last was changed into stone on Mount Sipylus, between Lydia and Phrygia, retaining, however, even as stone a sense of her woe. Such is the Homeric legend, which, however, was afterwards much varied and enlarged. N. was a favourite subject of the ancient artists. A group representing N. and her children was discovered at Rome in 1583, and is now in Florence. Some of the ancient Romans were in doubts whether the work proceeded from Scopas or Praxiteles.

NIOBIUM (symbol, Nb) is a rare metal discovered by H. Rose in the mineral *Tantalite*. It is obtained by reducing the double fluoride of niobium and potassium with sodium; and forms a black powder insoluble in nitric acid, but readily soluble in a mixture of nitric and hydrofluoric acids. With oxygen it forms two compounds, niobous acid, NbO, and niobic acid, NbO₃; and chlorine, bromine, fluorine, and sulphur compounds corresponding to these acids have been prepared and examined. Neither the metal itself nor any of its compounds are of any practical importance.

NIORT, a town of France, capital of the department of Deux-Sèvres, on the Sèvre-Niortaise, is situated in an agreeable country, occupying the slope of two hills and the valley which intervenes, 110 miles north of Bourdeaux. Its principal edifices are the Church of Notre-Dame, the town-hall, the theatre, and the old castle. Besides these, the beautiful Fountain du Vivier, the promenades, the library, and the college are worthy of notice. The dressing of chamois and the manufacture of gloves are the principal branches of industry. Dyeworks and tanneries are also in operation. Pop. 18,454.

N. is an ancient town. In the 14th c. it was taken by the English, and held by them for 18 years.

NIPA, a genus of endogenous plants referred by some botanists to the order *Pandanaceæ*, and by others to palms. *N. fruticans* is very common in the Eastern Archipelago, and northwards as far as the Mergui River, but becomes rare further north. It flourishes with the mangrove in places inundated when the tide rises. It abounds in saccharine sap, from which a kind of *Palm Wine* is made, and also

excellent sugar. The leaves are much employed for roofing houses, and large quantities are sent from the Tenasserim provinces northwards for this use.

NIPADITES, a genus of fossil palm fruits found in the Eocene clays of the island of Sheppey, in Kent. They are referred to *Nipa* as their nearest living ally, and are considered to have resembled in habit that genus, and to have grown on the banks of an immense river which flowed from the tropical regions of a continent lying to the southward, and entered the sea at Sheppey, where it deposited the fruits and leaves borne down with the current, by the side of the starfishes and mollusca which inhabited the estuary. Some 13 different kinds have been described.

NIPON, or NIPHON, the largest by far of the group of islands forming the empire of Japan (q. v.). It is the mainland—the England and Wales—of *Dai Nipon*, or Great Nipon, the Japanese name for the empire as a whole. N. is included between 33° 30'—41° 30' N. lat., and 130° 50'—142° 20' E. long. The inland sea of Suonada separates it from the islands of Kiusiu and Sikopf, and the Strait of Matsumai on the north-east from the island of Yesso. On the N. it is bounded by the Sea of Japan, and on the S. and E. by the Pacific Ocean. The length of N. is 900 miles, and its breadth 240; and it has an estimated area of 42,000 square miles. Yeddo (q. v.), the capital of the empire, where the Tycoon holds his court, and Miaco, the residence of the Mikado, or spiritual emperor, are the chief cities of Nipon. Important meteorological observations, which give a good idea of the climate of the country generally, have recently been made by Dr Hepburn at Kanagawa. These are exhibited in a condensed form in the following table:

1860.	Highest.	Lowest.	Rain in Inches.	Snow in Inches.	Number of Earthquakes.
January, . . .	59° F.	18° F.			1
February, . . .	58	19	½	2	1
March, . . .	69	30	3½	1½	2
April, . . .	76	36	3½		
May, . . .	80	44	16½		2
June, . . .	87	54	18½		11
July, . . .	92	63	8½		4
August, . . .	92	69	1 1-16th		2
September, . . .	89	62	2½		2
October, . . .	84	50	7½		2
November, . . .	68	36	5		4
December, . . .	71	22	3½	1	1

July and August are, therefore, the two hottest months in the year, while January and February are the coldest. Bracing sea-breezes make the heat of summer very endurable. The spring and autumn months are delightful. During the latter season, the sun for days, and even weeks together, runs his course in a sky undimmed by a cloud.—*Yeddo and Peking, a Narrative of a Journey to the Capitals of Japan and China*, by Robert Fortune (Lond. 1863, &c.).

NIRUKTA, or 'Explanation,' is the name of one of the six *Vedāngas* (see VEDA) which explains difficult Vedic words. That there have been several works engaged in such a task, even at a very remote period of Hindu antiquity, and that they bore the name of Nirukta is probable, for 'Nirukta authors' are quoted either generally or by name in several Sanskrit authors; but the work which is emphatically called *Nirukta*, and which, for the present, is the only surviving representative of this important Vedānga, is that of *Yāska*, who was a predecessor of Pāṇini (q. v.). His work consists of three parts—the *Naighanṭuka*, where, for the most part, synonymous words are taught; the *Naigama*, which contains

words that usually occur in the Vedas only; and the *Daiyata*, which contains words chiefly relating to deities and sacrificial acts. A Commentary on this work has been composed by the same Yāska, and it likewise bears the name of Nirukta. In the latter, Vedic passages are quoted in illustration of the words to be explained, and the comment given by Yāska on these passages is the oldest instance, known at present to Sanskrit philology, of a Vedic gloss. Besides the great importance which Yāska's *Nirukta* thus possesses for a proper understanding of the Vedic texts, it is valuable also on account of several discussions which it raises on grammatical and other questions, and on account of the insight it affords us into the scientific and religious condition of its time.—Text and Commentary of *Yāska's Nirukta* have been edited by Professor R. Roth (Göttingen, 1852).

NIRVĀNA (from the Sanscrit *nir*, out, and *vāna*, blown; hence, literally, that which is blown out or extinguished) is, in Buddhistic doctrine, the term denoting the final deliverance of the soul from transmigration. It implies, consequently, the last aim of Buddhistic existence, since transmigration is tantamount to a relapse into the evils or miseries of *Sansāra*, or the world. But as Hinduism, or the Brahmanical doctrine, professes to lead to the same end, the difference between *Nirvāna* and *Moksha*, *Apavarga*, or the other terms of Brahmaism designating eternal bliss, and consequent liberation from metempsychosis, rests on the difference of the ideas which both doctrines connect with the condition of the soul after that liberation. *Brahman*, according to the Brahmanical doctrine, being the existing and everlasting cause of the universe, eternal happiness is, to the Brahmanical Hindu, the absorption of the human soul into that cause whence it emanated, never to depart from it again. According to this doctrine, therefore, the liberation of the human soul from transmigration is equivalent to that state of felicity which religion and philosophy attribute to that Entity (see INDIA—Religion). As, however, the ultimate cause of the universe, according to Buddhism, is the Void or Non-entity, the deliverance from transmigration is, to the Buddhists, the return to non-entity, or the absolute extinction of the soul. However much, then, the pious phraseology of their *oldest* works may embellish the state of Nirvāna, and apparently deceive the believer on its real character, it cannot alter this fundamental idea inherent in it. We are told, for instance, that Nirvāna is quietude and identity, whereas *Sansāra* is turmoil and variety; that Nirvāna is freedom from all conditions of existence, whereas *Sansāra* is birth, disease, decrepitude and death, sin and pain, merit and demerit, virtue and vice; that Nirvāna is the shore of salvation for those who are in danger of being drowned in the sea of *Sansāra*; that it is the free port ready to receive those who have escaped the dungeon of existence, the medicine which cures all diseases, the water which quenches the thirst of all desires, &c.; but to the mind of the orthodox Buddhist, all these definitions convey but the one idea, that the blessings promised in the condition of Nirvāna are tantamount to the absolute 'extinction of the human soul,' after it has obeyed, in this life, all the injunctions of Buddhism, and become convinced of all its tenets on the nature of the world and the final destination of the soul.

Although this is the orthodox view of Nirvāna, according to the oldest Buddhistic doctrine, it is necessary to point out two categories of different views which have obscured the original idea of Nirvāna, and even induced some modern writers to believe that the final beatitude of the oldest

Buddhistic doctrine is not equivalent to the absolute annihilation of the soul.

The first category of these latter, or, as we may call them, heterodox views, is that which confounds with Nirvāna the preparatory labour of the mind to arrive at that end, and therefore assumes that Nirvāna is the extinction of thought, or the cessation, to thought, of all difference between subject and object, virtue and vice, &c., or certain speculations on a creative cause, the conditions of the universe, and so on. All these views the Buddha himself rejects, as appears from the work *Lankāvatāra* (q. v.), where relating his discourse on the real meaning of Nirvāna, before the Bodhisattwa Mahāmāti. The erroneousness of those views is obviously based on the fact, that the mind, even though in a state of unconsciousness, as when ceasing to think, or when speculating, is still within the pale of existence. Thus, to obviate the mistaken notion that such a state is the real Nirvāna, Buddhistic works sometimes use the term *Nirupadhis'esha Nirvāna*, or 'the Nirvāna without a remainder of substratum' (i. e., without a rest of existence), in contradistinction to the 'Nirvāna with a remainder,' meaning by the latter expression that condition of a saint which, in consequence of his bodily and mental austerities, immediately precedes his real Nirvāna, but in which, nevertheless, he is still an occupant of the material world.

The second category of heterodox views on the Nirvāna is that which, though acknowledging in principle the original notion of Buddhistic salvation, represents, as it were, a compromise with the popular mind. It belongs to a later period of Buddhism, when this religion, in extending its conquests over Asia, had to encounter creeds which abhorred the idea of an absolute nihilism. This compromise coincides with the creation of a Buddhistic pantheon, and with the classification of Buddhist saints into three classes, each of which has its own Nirvāna; that of the two lower degrees consisting of a vast number of years, at the end of which, however, these saints are born again; while the absolute Nirvāna is reserved for the highest class of saints. Hence Buddhistic salvation is then spoken of, either simply as *Nirvāna*, or the lowest, or as *Parinirvāna*, the middle, or as *Mahāparinirvāna*, or the highest extinction of the soul; and as those who have not yet attained to the highest Nirvāna must live in the heavens of the two inferior classes of saints until they reappear in this world, their condition of Nirvāna is assimilated to that state of more or less material happiness which is also held out to the Brahmanical Hindu before he is completely absorbed into Brahman.

When, in its last stage, Buddhism is driven to the assumption of an *Adi*, or primitive, Buddha, as the creator of the universe, Nirvāna, then meaning the absorption into him, ceases to have any real affinity with the original Buddhistic term. See BUDDHISM and LAMAISM.

NISHAPU'R, or NÜSHAPUR, a town of Persia, province of Khorassan, 53 miles west-south-west of Meahid, is situated in a most beautiful and fertile valley. Pop. about 8000. It is surrounded by a rampart and trench, and has a considerable trade in *turquoises*, which are obtained from mines in its vicinity.

NISI PRIUS is the name (borrowed from the first two words of the old writ which summoned juries) usually given in England to the sittings of juries in civil cases. Thus a judge sitting at *nisi prius*, means a judge presiding at a jury trial in a civil cause, and the *nisi prius* sittings are the jury sittings.

NISIBIS, the capital of ancient Mygdonia, the north-eastern part of Mesopotamia. It was situated in a fertile district, and was of importance, both as a place of strength and as an emporium of the trade between the east and west. N. was a city of very great antiquity, but of its remoter history nothing is known. In the time of the Macedonio-Syrian kings, it was also called *Antiochea Mygdonia*. It was twice taken by the Romans (under Lucullus and Trajan), and again given up by them to the Armenians; but being a third time taken by Lucius Verus, 165 A.D., it remained the chief bulwark of the Roman empire against the Persians, till it was surrendered to them by Jovian after the death of Julian in 363. The name *Nisibin* is retained by a small village in the Turkish ejalet of Diarbekr, round which are numerous remains of the ancient city.

NITRATE OF POTASH. See NITRE.

NITRATE OF SODA. See NITRE.

NITRE, or **SALTPETRE**, as it is frequently called, is the nitrate of potash (KO,NO_3). It usually occurs in long, colourless, striated, six-sided prisms; its taste is cooling, and very saline; it is soluble in seven times its weight of water at 60° , and in less than one-third of its weight of boiling water, but is insoluble in alcohol. When heated to about 660° , it fuses without decomposition into a thin liquid, which, when cast in moulds, solidifies into a white, fibrous, translucent mass, known as *sal prunelle*. At a higher temperature, part of the oxygen is evolved, and nitrate of potash is formed. Owing to the facility with which nitre parts with its oxygen, it is much employed as an oxidising agent. Mixtures of nitre and carbon, or of nitre and sulphur, or of nitre, carbon, and sulphur, deflagrate on the application of heat with great energy; and if nitre be thrown on glowing coals, it produces a briak scintillation. *Touch-paper* is formed by dipping paper in a solution of nitre, and drying it.

Nitre occurs as a natural product in the East Indies, Egypt, Persia, where it is found sometimes as an efflorescence upon the soil, and sometimes disseminated through its upper stratum. The crude salt is obtained by lixiviating the soil, and allowing the solution to crystallise. A large quantity of nitre is artificially formed in many countries of Europe, by imitating the conditions under which it is naturally produced. The most essential of these conditions seem to be the presence of decaying organic matter whose nitrogen is oxidised by the action of the atmosphere into nitric acid, which combines with the bases (potash and lime) contained in the soil. 'The method employed in the artificial production of nitre consists in placing animal matters, mingled with ashes and lime rubbish, in loosely aggregated heaps, exposed to the air, but sheltered from rain. The heaps are watered from time to time with urine or stable runnings; at suitable intervals, the earth is lixiviated, and the salt crystallised. Three years usually elapse before the nitre bed is washed; after this interval, a cubic foot of the debris should yield between four and five ounces of nitre. As there is always a considerable quantity of the nitrates of lime and magnesia present, which will not crystallise, carbonate of potash, in the shape of wood-ashes, is added so long as any precipitate occurs. The nitrate of lime is decomposed, and the insoluble carbonate of lime separated:

Carbonate of Potash. Nitrate of Lime. Carbonate of Lime. Nitrate of Potash.

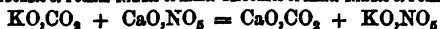

The clear liquor is then evaporated and crystallised. It has been found that the earth in which nitre has once been formed furnishes fresh nitre more

readily than on the first occasion. Care is taken that the *nitre plantations*, as they are termed, shall rest upon an impervious flooring of clay, so that the liquid which drains away from them may be collected and preserved.—Miller's *Elements of Chemistry*, 2d ed. vol. ii. p. 359.

Nitre does not occur in any living members of the animal kingdom, but it is found in the juices of various plants, amongst which may be named the sunflower, nettle, goose-foot, borage, tobacco, barley, &c.

All the nitre used in this country comes from the East Indies. The common varieties, which have a dirty yellowish appearance, are termed *rough* or *crude saltpetre*, while the purer kinds are called *East India refined*. The purification or refining of nitre is effected by dissolving it in water, boiling the solution, removing the scum, straining it while hot, and setting it aside to crystallise. The most common impurities are sulphate of potash, chloride of sodium and potassium, and nitrate of lime. Chloride of barium will detect the first of these impurities, nitrate of silver the second, and oxalate of ammonia the third.

Nitre is employed in the manufacture of sulphuric acid, in the preparation of nitric acid, as an oxidising agent in numerous chemical processes, as an ingredient of fireworks, and especially in the manufacture of gunpowder. It is extensively used in medicine. In moderate doses (from ten grains to a scruple) it acts as a refrigerent, diuretic, and diaphoretic, and hence its use is indicated when we wish to diminish abnormal heat, and to reduce the action of the pulse, as in febrile disorders and hemorrhages. In acute rheumatism, it is given in large doses with great benefit. Some physicians prescribe as much as one, two, or three ounces, largely diluted with water, to be given in the course of twenty hours; but as in several cases a single ounce has proved fatal in a few hours, the effects of such large doses should be carefully watched. It is a popular remedy in sore throat, either in the form of nitre balls, or powdered and mixed with white sugar. In either case, the remedy should be retained in the mouth till it melts, and the saliva impregnated with it gently swallowed. The inhalation of the fumes produced by the ignition of *touch-paper* often gives speedy relief in cases of spasmodic asthma.

Nitrate of potash is sometimes called *Prismatic Nitre* or *Potash Saltpetre*, to distinguish it from nitrate of soda, which is known in commerce as *Cubic Nitre* or *Soda Saltpetre*.

Cubic Nitre, or *Nitrate of Soda* (NaO,NO_3), occurs abundantly on the surface of the soil in Chili and Peru. It derives its name from its crystallising in cube-like rhombohedrons. In most of its properties it resembles ordinary nitre, but in consequence of its greater deliquescence, it cannot be substituted for that salt in the preparation of gunpowder. Being considerably cheaper than the potash-salt, cubic nitre is often substituted for it in the manufacture of nitric and sulphuric acids; and it is used in agriculture as a top-dressing for wheat and oats. In several experiments it has been found that one cwt. per acre has produced an increase of twelve bushels in the wheat crop, and of four or five sacks in the oat crop.

NITRIC ACID is the most important of the five compounds which oxygen forms with Nitrogen (q. v.). Until 1849, it was only known in the hydrated form (the *aqua fortis* of the older chemists), but in that year Deville shewed that *Anhydrous Nitric Acid*, or *Nitric Anhydride* (NO_2), might be obtained in transparent colourless crystals by the action of perfectly dry chlorine gas on well-dried

NITRIC ACID—NITRO-BENZOL.

crystals of nitrate of silver, the reaction being exhibited in the equation :

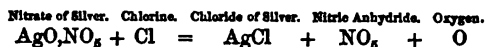

It is a very unstable compound, and sometimes explodes spontaneously. It dissolves in water with evolution of much heat, and forms hydrated nitric acid.

Hydrated Nitric Acid (symb. HO, NO_3 , equiv. 63, sp. gr. 1.521), when perfectly pure, is a colourless limpid, fuming, powerfully caustic fluid, possessing an intensely acid reaction, as shewn by its action on litmus. It boils at 184° , and freezes at about -40° . It parts very readily with a portion of its oxygen to most of the metals, and hence is much used in the laboratory as an oxidising agent. Its mode of action on the metals requires a few remarks. In order that a metal should unite with nitric, or any other acid, it is necessary that it should be in the form of an oxide. This oxidation is, however, effected at the same time that the metal and nitric acid are brought in contact, by one portion of the latter becoming decomposed and converting the metal into an oxide, while the remaining portion combines with the oxide thus formed, to produce a nitrate. The exact nature of the decomposition varies in the case of different metals.

Nitric acid, whether in the concentrated or in a more dilute form, acts energetically on organic matters. As examples of such actions we may refer to its power of decolorising indigo; of staining the skin and all albuminous tissues of a bright-yellow colour; of coagulating fluid albumen; and of converting cotton fibre into an explosive substance. See GUN COTTON.

The monohydrated acid (HO, NO_3) is by no means a stable compound. If it be exposed to the action of light it is decomposed into hyponitric acid (NO_2) (the peroxide of nitrogen of Graham) and oxygen; and mere distillation produces a similar effect. When it is mixed with water it emits a sensible amount of heat, owing to the formation of a much more stable hydrate, $\text{HO}, \text{NO}_3 + 3\text{Aq}$, which distils at 250° without change, and is unaffected by exposure to light. Its specific gravity is 1.424; and it is found that a weaker acid when heated parts with its water, and a stronger acid with its acid, till each arrives at this density. The existence of this hydrate has, however, been recently called in question by Roscoe.

The so-called *Fuming Nitric Acid* is merely a mixture of the pure acid with hyponitric acid.

Nitric acid does not occur naturally in a free state; but it is found tolerably abundant in combination with potash, soda, lime, and magnesia; and after thunderstorms traces of it, in combination with ammonia, are found in rain water. It may be formed in small quantity by passing a series of electric sparks through a mixture of its component gases in the presence of water, which is a mere imitation, on a small scale, of the mode in which it is produced in the atmosphere by a storm. It is usually prepared in the laboratory by the application of heat to a mixture of equal weights of powdered nitre (nitrate of potash) and oil of vitriol (hydrated sulphuric acid) placed in a retort. A combination of sulphuric acid and potash remains in the retort, while the nitric acid distils over, and is condensed in the receiver, which is kept cool by the application of a wet cloth. The reaction is explained by the equation :

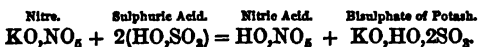

During distillation red fumes appear, arising from the decomposition of a portion of the nitric acid and

a formation of some of the lower oxides of nitrogen. In this operation *two* equivalents of oil of vitriol are taken for *one* of nitre, these being the proportions found by experience to be most suitable. If they are taken, equivalent for equivalent, a very impure red fuming acid is the result. In the manufacture of nitric acid on the large scale, the glass retort is replaced by a cast-iron cylinder coated with fire-clay, and the receiver by a series of earthen condensing vessels connected by tubes; and nitrate of soda, found native in Peru, is substituted for nitre, in consequence of its being a cheaper salt, and of its containing 9 per cent. more nitric acid.

Nitric acid combines with bases to form *nitrates*, some of which, as those of potash, soda, oxide of ammonium, silver, &c., are anhydrous, while others combine with a certain number (often six) equivalents of water of crystallisation. Most of them are soluble in water, crystallisable, and readily fusible by heat; and at an elevated temperature they are all decomposed, usually leaving only the oxide of the metal. If paper be soaked in a solution of a nitrate, allowed to dry, and ignited, it burns in the smouldering mode characteristic of *touch-paper*. This property is, however, shared by a few other salts.

The tests for this acid when it is present in small quantities are less satisfactory than those for the other ordinary mineral acids. All its compounds are so soluble that no *precipitant* for this acid is known. The best method for its detection is mixing the fluid to be tested with a little concentrated sulphuric acid, and then pouring a strong solution of protosulphate of iron upon it, so as to form a separate layer. If much nitric acid be present, a black colour is produced; if only a small quantity is present, the liquid becomes reddish-brown or purple; the dark colour being due to the formation of nitric oxide by the deoxidising action of a portion of the iron salt on the nitric acid.

The applications of this acid in the arts, in manufactures, and in chemical processes are very extensive.

NITRIC ACID, THE MEDICINAL USES OF. In the British pharmacopoeia there is both a strong and a dilute acid. The strong acid has a specific gravity of 1.5, and is represented by the formula $3\text{HO}, 2\text{NO}_3$, while the diluted acid is prepared by mixing two ounces of the former with thirteen of distilled water, and has a specific gravity of 1.101.

The dilute acid is used internally as a tonic in conjunction with bitter infusions. In many cases of chronic inflammation of the liver, and in syphilitic cases in which the employment of mercurials is inadmissible, it may be prescribed with great benefit, either alone or in conjunction with hydrochloric acid, externally as a bath or lotion, or internally in doses of about 20 minims properly diluted. The strong acid is useful as an escharotic; as to destroy warts, some kinds of polypi, the unhealthy tissue in sloughing ulcers, &c., and as an application to parts bitten by rabid or venomous animals. Largely diluted, as 50 or 60 drops of the strong acid to a pint or more of water, it forms an excellent stimulative application to torpid ulcers.

NITRO-BENZOL, or NITRO-BENZIDE ($\text{C}_7\text{H}_5\text{NO}_2$), is a yellow oily fluid, of specific gravity 1.2, which may be distilled without decomposition, crystallises in needles at 37° , and boils at 315° . It has a sweet taste, is insoluble in water, but dissolves freely in alcohol and ether. Its odour is very similar to that of oil of bitter almonds, which has led to its use in perfumery, under the name of *Essence of Nirbane*. It is obtained by treating benzol (C_6H_6) with warm fuming nitric acid, when

NITROGEN.

1 equivalent of the hydrogen is replaced by 1 of hyponitric acid, so that the benzol (C_6H_6) becomes converted into nitro-benzol ($C_6H_5NO_2$).

NITROGEN (symbol, N; equivalent, 14; specific gravity, 0.9713) derives its name from the Greek words *nitron*, nitre, and *gen-*, to produce, in consequence of its being an essential constituent of that salt. It is frequently termed *azote* (Gr. *a*, priv., *zoe*, life), especially by the French chemists, in consequence of its being a gas incapable of supporting life, and, for the same reason, the German chemists term it *stickstoff*, which may be translated *choking substance*. It was discovered by Rutherford in 1772; but for its name, nitrogen, we are indebted to Chaptal.

Nitrogen is a colourless, tasteless, inodorous, permanent gas, which in its appearance in no way differs from the atmospheric air, of which it is the main ingredient. It is somewhat lighter than atmospheric air, 100 cubic inches at 60° F., and barometer 30 inches, weighing 30.119 grains, while the same volume of air weighs 30.935 inches. It is characterised rather by negative than by positive properties. It is not combustible, nor is it a supporter of combustion (a lighted taper being immediately extinguished if immersed in this gas); it is not respirable, although it is not positively poisonous; for when it is mixed with respirable gases (as with oxygen in atmospheric air) it may be breathed without injury. It is very slightly soluble in water, and hence may be collected over that fluid. Its combining powers are very slight, and although it unites with oxygen, hydrogen, chlorine, and many other substances, the union is never effected by the direct action of the elements on one another, but only by complicated processes, and many of the resulting compounds are of an exceedingly unstable nature.

Nitrogen is one of the most widely diffused elementary substances. It forms about four-fifths of the bulk of the atmosphere; for air, after having been freed from the small quantities of carbonic acid and aqueous vapour which it contains, consists, according to the experiments of Dumas and Boussingault, of 20.31 per cent. of oxygen and 79.19 per cent. of nitrogen by volume, or 23.01 of oxygen and 76.99 of nitrogen by weight; the two gases in this case being uniformly mixed, but not in chemical combination with one another. It occurs, however, in combination with oxygen in the form of nitric acid (HO,NO_3) in various nitrates, which are found as natural products in many parts of the globe. In combination with hydrogen, it is abundantly found as ammonia, and combined with oxygen, hydrogen, and carbon, and sometimes additionally with sulphur and phosphorus, it forms the most important constituents of the solids and fluids of the animal body, and occurs in many vegetable products, especially in the alkaloids, such as morphia, strychnia, quinia, &c.

The ordinary methods of preparing and exhibiting this gas, are based upon the removal of the oxygen from atmospheric air. This may be done (1) By setting fire to a small piece of phosphorus placed in a capsule, that floats on the water of the pneumatic trough, and by inverting a glass-receiver filled with air over it. The phosphorus combines with the oxygen of the air to form phosphoric acid, which dissolves in the water, while the nitrogen is left, and must be transferred to another vessel. (2) By placing a stick of phosphorus in a jar of air which is standing over water. In two or three days there will be the same results as in the former experiment—viz, phosphoric acid and nitrogen; (3) Or by passing air through a tube containing heated copper filings, which absorb the oxygen. In the above cases, a little carbonic acid is present, which may be removed by passing the gas through a

solution of potash. Pure nitrogen may be directly obtained by the action of chlorine gas on a solution of the nitrogenous substance, ammonia.

Nitrogen forms with oxygen no less than five distinct compounds, containing, respectively, 1, 2, 3, 4, and 5 equivalents of oxygen, with 1 equivalent of nitrogen. These compounds are thus named and constituted: Protoxide of Nitrogen (known also as Nitrous Oxide and Laughing Gas), NO ; Bin oxide (or Deutoxide) of Nitrogen (known also as Nitric Oxide), NO_2 ; Nitrous Acid, NO_2 ; Hyponitric Acid (known also as Peroxide of Nitrogen), NO_4 ; Nitric Acid, NO_5 .

Protoxide of Nitrogen is a transparent, colourless gas, with a sweetish taste and smell. It is much more soluble in cold than in hot water, and therefore should be collected over the latter. Under a pressure of 50 atmospheres at 45° it is reduced to a colourless liquid, and it may be frozen into a transparent solid at about -150° . This gas is about half as heavy again as atmospheric air, its specific gravity being 1.527. It supports the combustion of many bodies, such as carbon, sulphur, phosphorus, and iron, with a brilliancy similar to that which they exhibit in oxygen; and, like oxygen, when mixed with hydrogen, it forms a mixture which explodes on the application of a flame. The most remarkable property of the gas is its intoxicating power on the animal system. It may be respired for a short time if quite pure, or if only mixed with atmospheric air, without danger or serious inconvenience. The intoxication is frequently accompanied with an irresistible propensity to muscular exertion, and usually with uncontrollable bursts of laughter, and hence the gas has received the name of *laughing gas*. It is best obtained by heating solid nitrate of ammonia in a glass retort, when it is converted into protoxide of nitrogen and water, as shewn in the equation:

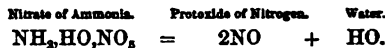

Bin oxide of Nitrogen is a colourless gas, very slightly soluble in water, and having a specific gravity of 1.039. Its taste and smell (if any) are unknown, since, in the presence of atmospheric air, it instantly becomes more highly oxidised, and forms yellowish-red fumes of hyponitric acid. As it is of little importance, it is unnecessary here to describe the mode of obtaining it.

Nitrous Acid, or Nitrous Anhydride, is a substance of which, in its uncombined state, very little is yet known further than that it is a dark-blue, very volatile fluid, which boils at 32° , and is then converted into an orange-red gas.

Hyponitric Acid presents a remarkable example of a body within comparatively small limits of temperature occurring in a solid, a fluid, and a gaseous form. At a temperature of -4° it occurs in the form of colourless prismatic crystals, which are converted at about 9° into a fluid which, till the temperature reaches about 30° , is colourless; but at a higher temperature becomes yellow and orange, and at about 82° boils, and is converted into a brownish-red vapour. It is chiefly the vapour of hyponitric acid that forms the orange fumes that are produced when bin oxide of nitrogen comes in contact with the air. It possesses a very disagreeable suffocating odour, and a caustic action, and colours the skin yellow, like nitric acid. It does not enter into combination with bases, but is immediately decomposed by them into nitric and nitrous acids; and it is in consequence of its not possessing this essential character of an acid that Graham has given it the name of *peroxide of nitrogen*, a term that has since been adopted by Miller and other chemists.

Nitric Acid is described in a special article.

Nitrogen combines with hydrogen in four proportions, but none of these compounds can be formed by the direct union of the component elements, and only one of them, viz., ammonia, has been obtained in the isolated form. They are—*Imidogen* (NH), *Amidogen* (NH₂), *Ammonia* (NH₃), and *Ammonium* (NH₄). Of these, the first two will be noticed in the article ORGANIC BASES, while the two last are sufficiently described in the article AMMONIA.

Nitrogen combines with chlorine, bromine, and iodine. The *chloride of nitrogen* is a heavy, oily, orange-coloured fluid, insoluble in water, and evolving a vapour of a highly irritating nature. It is one of the most dangerous compounds known in chemistry, as it explodes with extreme violence when brought in contact with phosphorus, arsenic, potash, ammonia, caoutchouc, numerous oily matters, &c., at ordinary temperatures, and spontaneously when heated to above 200°. It has occasioned so many serious accidents that we shall omit all details regarding its mode of preparation. Its exact formula is unknown. *Bromide of Nitrogen* is an oily-looking detonating liquid, resembling the chloride in appearance and properties. *Iodide of Nitrogen* occurs as a black powder, which when dry explodes upon the slightest touch, and often without any assignable cause.

Nitrogen enters into combination with various metals, as mercury, copper, titanium, molybdenum, and vanadium, forming a class of compounds to which the term *Nitrides* is applied. Their most marked characteristic is, that, like the preceding set of compounds, they are highly explosive, resolving themselves when struck, or at a high temperature, into their constituent elements.

NITROUS ETHER, or NITRITE OF OXIDE OF ETHYL, is represented by the formula C₂H₅O₂NO, or AeO₂NO, Ae being the symbol for ethyl (C₂H₅). It is a pale yellow fluid, having a specific gravity of 0.947, and evolving an agreeable odour of apples. On evaporation, it produces a great degree of cold, it boils at 62°, and it is very inflammable. It does not mix with water, but is readily miscible with alcohol. When kept in contact with water it soon decomposes, and an acid mixture of a very complicated character is formed. It may be obtained by mixing 1 part of starch and 10 of nitric acid in a capacious retort, which must be gently heated. The vapour of nitrous acid, which is evolved by the action of the starch on the nitric acid, is conducted into alcohol, mixed with half its weight of water, contained in a two-necked bottle, which is to be plunged into cold water. The second neck of this bottle is connected with a good cooling apparatus; and the vapour combining in its passage through the alcohol with the oxide of ethyl, forms nitrous ether, which distils in a continuous stream. This, which is known as *Liebig's method*, is the best process, but it is usually prepared by the direct action of nitric acid on alcohol, in which case the nitric acid is deoxidised by the hydrogen and carbon of the ethyl of part of the alcohol.

The *Spirit of Nitrous Ether, or Sweet Spirit of Nitre*, used in medicine, is a mixture of nitrous ether with about four times its volume of rectified spirit. Its specific gravity should not exceed 0.85. It is used, in conjunction with other medicines, as a diuretic, especially in the dropsy which follows scarlatina; and it is employed, in combination with acetate of ammonia and tartarised antimony, in febrile affections. The dose in febrile cases is from half a drachm to a couple of drachms, and if we wish it to act as a diuretic, two or three drachms should be given. It is a rather expensive medicine,

and consequently is extremely liable to adulteration. In the new British Pharmacopœia, it is recommended that this substance should be directly obtained by the distillation of nitrite of soda (five ounces), sulphuric acid (four fluid ounces), and rectified spirit (two pints)—a process open to many practical objections.

NITZSCH, KARL IMMANUEL, one of the most distinguished theologians that modern Germany has produced, was born September 21, 1787, at Borna. He studied for the church at Wittenberg, where he took his degree in 1810, and where, in 1813, he became parish minister. Here his religious opinions underwent a great modification, through the influence of Schleiermacher and Daub, and he awoke to a clearer perception of the essence of religion. From this time forward N. is to be regarded as one of that new school—of which Neander is the greatest representative—who endeavoured to reconcile faith and science, not by forced and unnatural methods, but by pointing out their distinctive spheres, and by exhibiting in their own spiritual life that union of reason and reverence for which they argued in their writings. In 1822, N. was called to Bonn as ordinary professor of theology and university preacher, where he laboured with great diligence for more than twenty years, not only in theology, but in all matters affecting the welfare of the Prussian church. In 1847, he succeeded Marheineke at Berlin, and as professor, university preacher, and upper consistorial councillor, he has exercised with prudence and moderation a wide ecclesiastical influence. In his political (perhaps also in his religious) views he may be classed with the late Chevalier Bunsen. The High Lutheran party having denounced liberal politics as irreligious, N. and Bunsen and others have vindicated them on the ground of Christianity, not without success. In theology, his position will be best understood when we say that he subordinates dogma to ethics, or rather that he believes the only dogmas which can hope to permanently maintain themselves are those that result from an ethical apprehension of Christianity. Besides numerous smaller treatises on Dogmatics, the History of Dogmas and Liturgies, three larger works call for special mention. These are his *System der Christlichen Lehre* (Bonn, 1829; 6th edit. 1851); his *Praktische Theologie* (Bonn, 1847—1848); and his *Predigten, or Sermons*, of which several collections have appeared, and which are remarkable for their extraordinary richness of thought.—**NITZSCH, GREGOR WILHELM** (born in 1790), brother of the preceding, has acquired a high reputation as a philologist, and is now professor of archaeology at Leipsic. He is considered one of the ablest opponents of Wolf's Homeric theories. His chief work is *Die Sagenpoesie der Griechen* (Brunswick, 1852).

NIVELLES (Flem. *Nyvel*), a town of Belgium, in the province of South Brabant, 18 miles south of Brussels. It has a fine church, called the Church of St Gertrude (built in the Romanesque style of architecture, 1048 A.D.), which claims to contain the relics of St Gertrude, daughter of Pepin, Maire du Palais. They are deposited in a shrine placed over the high-altar. N. has manufactures of linen, cotton, lace, &c. Pop. 8000.

NIVERNAIS, formerly a province in the middle of France, nearly corresponding to the present department of Nièvre. It was divided into eight territorial districts, and its towns enjoyed municipal privileges at a very early period. The principal landowners were the counts, afterwards dukes, of Nevers, who held under their vassalage more than 1800 fiefs.

NIX, in the masculine, and *nixe* in the feminine (Old High Ger. *nihlus*; Anglo-Saxon, *nicor*; Dutch, *nikker*; Old Norse, *nir*; Swed. *nåk*, *nek*; Dan. *nøk*, *nok*—whence our name for the devil, *Nick*, not as some absurdly suppose, from *Nicholas* Machiavelli), the common name for all water spirits in the Teutonic mythology. They are represented as of human form, or sometimes as passing into that of a fish or of a horse. They love music and dances, and possess the gift of prophecy, like the Greek Muses, Sirens, and other water gods. The *nix* taught, in return for a good gift, the art of playing on a stringed instrument; and often in the evening sunshine the *nixes*, combing their long hair, were wont to mingle in the dances of mortals; but their company was dangerous, for though sometimes wearing a mild appearance, they were more frequently cruel and malignant.—The *water-helpie* of Scotland must be reckoned a member of the genus *Nix*, but in him the evil element alone exists. He generally, if not always, assumed the form of a water-horse; frequented fords and ferries, especially during storms; allured travellers to mount him, and then dashed furiously with them into the stream which he had flooded by his devilish power, and submerged them in the roaring currents.

NIZAM'S DOMINIONS, an extensive territory in the interior of Southern India, lying to the north-west of the Presidency of Madras, in lat. 15° 10'—21° 42' N., and long. 74° 40'—81° 32' E. Length from south-west to north-east, 480 miles; extreme breadth, 340 miles. Area, 95,000 square miles, and pop. estimated at upwards of 10,000,000. The surface is a slightly-elevated table-land. The principal rivers are the Godavari (Godavery), with its tributaries the Dudhna, Manjera, and Pranhits; and the Kistna (Krishna), with its tributaries the Bimah and Tungabhadro. The soil is naturally very fertile, but poorly cultivated; yet, wherever it receives moderate attention, it yields harvests all the year round. The products are rice, wheat, maize, mustard, castor-oil, sugar-cane, cotton, indigo, fruits (including grapes and melons), and all kinds of kitchen vegetables. The pasturages are extensive, and sheep and horned cattle are numerous. Marsh and jungle, however, occupy a great space, and originate fevers, agues, diseases of the spleen, &c., though the climate is quite healthy where these do not abound. The mean temperature of the capital, Hyderabad, in January is 74° 30', and in May 93°. The inhabitants manufacture for home use woollen and cotton fabrics, and export silk, dressed hides, dye-stuffs, gums, and resins. Good military roads traverse the territory. The revenue of the Nizam is reckoned at £1,550,000 yearly. The ruler is a Mohammedan, but his subjects are mostly Hindus.

In 1687, the territory, now known as the Nizam's Dominions, became a province of the Mogul empire; but in 1719, the governor or viceroy of the Deccan, Azof Jah, made himself independent, and took the title of *Nizam-ul-Mulk* (Regulator of the State). After his death, in 1748, two claimants appeared for the throne, his son Nazir Jung, and his grandson Mirzapha Jung. The cause of the former was espoused by the East India Company, and that of the latter by a body of French adventurers under General Duplex. Then followed a period of strife and anarchy. In 1761, Nizam Ali obtained the supreme power, and after some vacillation signed a treaty of alliance with the English in 1768. He aided them in the war with Tipoo, sultan of Mysore, and at the termination of that war, in 1799, a new treaty was formed, by which, in return for certain territorial concessions, the East India

Company bound itself to maintain a subsidiary force of 8000 men for the defence of the Nizam's dominions. The present Nizam or ruler, *Afzul-ul-Dowlah*, who succeeded to the government on the death of his father, May 19, 1857, remained faithful to the British during the mutiny of 1857—1858.

NOBILÉ OFFICIUM, the term used in the Law of Scotland to denote the high prerogative right of the Court of Session to exercise jurisdiction in certain cases—as, for example, to appoint a judicial factor to young children or to lunatics.

NOBILITY, that distinction of rank in civil society which raises a man above the condition of the mass of the people. Society has a tendency to inequality of condition, arising from the natural inequality, physical, moral, and intellectual, of those who compose it, aided by the diversity of external advantages, and of the principles and habits imbibed at an early age. This inequality is apt to increase; the son, inheriting the faculties of his father, is more favourably situated than his father was for making use of them; and hence, in almost every nation in even the very early stages of civilisation we find something like a hereditary nobility. Privileges originally acquired by wealth or political power, are secured to the family of the possessor of them; and the privileged class come to constitute an order, admission into which requires the consent of society or of the order itself.

The ancient Romans were divided into *nobiles* and *ignobiles*, a distinction at first corresponding to that of patricians and plebeians. A new nobility afterwards sprung out of the plebeian order, and obtained (336 B. C.) the right to rise to high offices in the state; and in course of time the descendants of those who had filled curule magistracies inherited the *ius imaginum*, or right of having images of their ancestors—a privilege which, like the coat-of-arms in later ages, was considered the criterion of nobility. The man entitled to have his own image was a *novus homo*, while the *ignobilis* could neither have his ancestor's image nor his own.

The origin of the feudal aristocracy of Europe is in part connected with the accidents which influenced the division of conquered lands among the leaders and warriors of the nations that overthrew the Roman empire. Those who had acquired a large share of territorial possession, and their posterity to whom it was transmitted, were naturally looked on as the fittest persons to occupy the great offices of state and wield political power. The Frankish kingdom in Gaul was divided into governments, each under the authority of a chieftain called a Count or *Comes*—a designation derived from the *comes* of the Roman empire—whose Teutonic equivalent was *Graf*. A higher dignity, and more extensive jurisdiction, was conferred on the *Dux* or Duke, a term also of Roman origin, and implying the duty of leading the armies of the country. In the Lombard Kingdom of Italy, the same term was applied to the great officers who were intrusted with the military and civil administration of cities and their surrounding provinces. The Marquises were guardians of the frontier marches. In the subinfeudations of the greater nobility originated a secondary sort of nobility, under the name of Vavasours, Castellans, and lesser barons; and a third order below them comprised vassals, whose tenure, by the military obligation known in England as knight's service, admitted them within the ranks of the aristocracy. In France, the allegiance of the lesser nobles to their intermediary lord long continued a reality; in England, on the other hand, William the Conqueror obliged not only his barons who held in chief of the crown, but their vassals also, to take an

oath of fealty to himself; and his successors altogether abolished subinfeudation.

The military tenant, who held but a portion of a knight's fee, participated in all the privileges of nobility, and an impassable barrier existed between his order and the common people. Over continental Europe in general, the nobles, greater and lesser, were in use, after the 10th c., to assume a territorial name from their castles or the principal town or village on their demesne; hence the prefix 'de,' or its German equivalent 'von,' still considered over a great part of the continent as the criterion of nobility or gentility. Britain was, to a great extent, an exception to this rule, many of the most distinguished family names of the aristocracy not having a territorial origin. See NAME.

Under the feeble successors of Charlemagne, the dukes, marquises, and counts of the empire encroached more and more on the royal authority; and in course of time, many of them openly asserted an independence and sovereignty with little more than a nominal reservation of superiority to the king. By the end of the 9th c., the Carolingian empire had been parcelled into separate and independent principalities, under the dominion of powerful nobles, against whom, in Germany, the crown never recovered its power. In France, however, the royal authority gradually revived under the Capetian race, the great fiefs of the higher nobility being one by one absorbed by the crown. In England, where the subjection of the feudal aristocracy to the crown always was, and continued to be a reality, the resistance of the nobles to the royal encroachments was the means of rearing the great fabric of constitutional liberty. All those who, after the Conquest, held *in capite* from William belonged to the nobility. Such of them as held by barony (the highest form of tenure) are enumerated in *Domesday*. Their dignity was territorial, not personal, having no existence apart from baronial possession. The *comes* was a baron of superior dignity and greater estates; and these were in England the only names of dignity till the time of Henry III. The rest of the landholders, who held by other tenures than barony, also belonged to the nobility or gentry.

After the introduction of Heraldry, and its reduction to a system, the possession of a coat-of-arms was a recognised distinction between the noble and the plebeian. In the words of Sir James Lawrence (*Nobility of the British Gentry*): 'Any individual who distinguishes himself may be said to ennoble himself. A prince judging an individual worthy of notice, gave him patent letters of nobility. In these letters were blazoned the arms that were to distinguish his shield. By this shield he was to be known or *nobilis*. A plebeian had no blazonry on his shield, because he was *ignobilis*, or unworthy of notice. Hence arms are the criterion of nobility. Every nobleman must have a shield of arms. Whoever has a shield of arms is a nobleman. In every country of Europe without exception, a grant of arms, or letters of nobility, is conferred on all the descendants.' On the continent, the term noble is still generally used in this sense; in England, it is now more common to restrict the words noble and nobility to the five ranks of the peerage constituting the greater nobility, and to the head of the family, to whom alone the title belongs. Gentility, in its more strict sense, corresponds to the nobility of Sir J. Lawrence and of continental countries. This difference of usage is a frequent source of misapprehension on both sides of the Channel; at some of the minor German courts, the untitled member of an English family of ancient and distinguished blood and lineage has

sometimes been postponed to a recently-created baron or 'Herr von,' who has received that title, and the gentility accompanying it, along with his commission in the army. It has been taken for granted that the latter belongs to the 'Adel' or nobility, and not the former.

The original higher nobility of Germany consisted of the dynasty nobles, i. e. the electoral and princely houses of the realm, with those counts and barons who had a seat in the diet or estates of the realm. These last have, since 1815, all been elevated to higher titles; most of the counts, in recompense for their acquiescence in the abolition of the German empire, receiving the diploma of prince, a title to which our dukes, marquises, and earls have also an undoubted right. The lower German nobility, corresponding to our gentry, were the merely titular Counts and Barons (i. e., those who had no seat in the Diet), the Edel-herren and Banner-herren (something like our Bannerets), the Knights of the Holy Roman Empire, the 'Edlen von' (who now take the style of baron), and the common nobles distinguished only by the prefix 'von.' Throughout the middle ages, the lesser nobility of Britain preserved a position above that of most continental countries, being, unlike the corresponding class in Germany, allowed to intermarry with the high nobility, and even with the blood-royal of their country.

The higher nobility, or nobility in the exclusive sense, of England, consist of the five temporal ranks of the peerage—Duke, Marquis, Earl, Viscount, and Baron (in the restricted signification of the word), who are members of the Upper House of Parliament. Formerly, all the barons or tenants-in-chief of the sovereign were bound to attend his councils; but after the reign of Edward I., only a select number of them were summoned, the rest appeared by representatives—the former were considered the greater, the latter the lesser barons. See MINOR BARONS. In Scotland, the whole barons continued to sit in parliament till a much later period; and after the minor barons attended only by representatives from their body, these representatives sat in the same house with the greater nobility, and up to the Union, their votes were recorded as those of the 'small barrounis.' By the Act of Union between England and Scotland, the Scotch peers elect 16 of their number to represent their body in the House of Lords in each parliament. The peers of Ireland, in virtue of the Irish Act of Union, elect 28 of their number to sit in the House of Lords for life. The Act of Union with Scotland has been understood to debar the sovereign from creating any new Scotch peerages; all peers created in either England or Scotland between that date and the union with Ireland are peers of Great Britain; and peers created in any of the three kingdoms subsequently to the union with Ireland are peers of the United Kingdom, with this exception that one new peerage of Ireland may be created on the extinction of three existing peerages. When the Irish peers are reduced to 100, then, on the extinction of one peerage another may be created. All peers of Great Britain or of the United Kingdom have a seat in the House of Lords. A Scotch peer, though not one of the sixteen representative peers, is debarred from sitting in the House of Commons, a disability which does not attach to Irish peers. The peerage is, from time to time, recruited by new additions, the persons selected being in general peers of Scotland or Ireland; younger members of the families of peers; persons distinguished for naval, military, political, or diplomatic services; eminent lawyers promoted to high judicial appointments; persons of large property and ancient family,

NOBILITY.

noble in the more extended sense; and occasionally, but rarely, persons who have by commerce acquired large fortunes and social importance. At present, the peerage comprehends 548 individuals—the number of peerage titles being much greater, as several titles often merge in one person. Three royal dukes are included in this enumeration, as also 81 peers of Scotland, and 190 of Ireland. Only 25 of the present Scotch, and 87 Irish peers, are without seats in the House of Lords, in consequence of there being, besides the representative peers, 40 peers of Scotland, and 75 of Ireland, who are at the same time peers either of England, Great Britain, or of the United Kingdom. The privileges belonging to peers as members of parliament will be explained under PARLIAMENT; as peers, they also possess the following immunities: They can only be tried by their peers for felony, treason, or misprision of treason, when the whole members of the peerage are summoned, and the accused is acquitted or condemned by the voice of the majority, given not on oath, but 'on honour.' This privilege, which extends to peeresses, either in their own right or by marriage, is in Scotland further regulated by Act 6 Geo. IV. c. 66. A peer answers to bills in Chancery upon his honour, and not on oath; but when examined as a witness in civil or criminal cases, or in parliament, he must be sworn. He cannot be bound over to keep the peace elsewhere than in the Court of Queen's Bench or of Chancery. Scandal against a peer is '*scandalum magnatum*,' a more heinous offence than slander against another person, and subjects the offender by various English acts to statutory punishments. All the privileges belonging to the English peers, except the right of sitting in the House of Lords, were extended to the peers of Scotland by the Treaty of Union. A peer who has different titles in the peerage, takes in ordinary parlance his highest title, one of the inferior titles being given by courtesy to his eldest son. Certain Courtesy Titles (q. v.) belong also to the daughters and younger sons of a peer, but do not extend to their children.

In France, a limited body of the higher nobility, styled the peers, were in the enjoyment of privileges not possessed by the rest. The title of Duke was subject to strict rule, but many titles of Marquis and Count, believed to be pure assumptions, were recognised by the courtesy of society. The head of a noble family often assumed at his own hand the title of marquis; and if an estate was purchased which had belonged to a titled family, the purchaser was in the habit of transferring to himself the honours possessed by his predecessor—a practice to which Louis XV. put a stop. Immediately before the Revolution, 80,000 families claimed nobility, many of them of obscure station, and less than 3000 of ancient lineage. Nobles and clergy together possessed two-thirds of the land. Practically, the estimation in which a member of the French nobility was held depended not so much on the degree of his title as on its antiquity, and the distinction of those who had borne it. The higher titles of nobility were not borne by all members of a family; each son assumed a title from one of the family estates—a custom productive of no small confusion. Unlike 'roturier' lands, which divided among all the children equally, noble fiefs went to the eldest son. The Revolution overthrew all distinction of ranks. On 18th June 1790, the National Assembly decreed that hereditary nobility was an institution incompatible with a free state, and that titles, arms, and liveries should be abolished. Two years later, the records of the nobility were burned. A new nobility was created by the Emperor Napoleon I. in 1808, with titles descending to the eldest son. The

old nobility was again revived at the Restoration. All marquises and viscounts are of pre-revolution titles, none having been created in later times.

Commercial pursuits have more or less in different countries been considered incompatible with nobility. In England, this was less the case than in France and Germany, where for long a gentleman could not engage in any trade without losing his rank. A sort of commercial 'Bürger-Adel,' or half-gentleman class, was constituted out of the patrician families of some of the great German cities, particularly Augsburg, Nürnberg, and Frankfurt, on whom the emperors bestowed coats-of-arms. In semi-feudal Italy, there was on the whole less antagonism between nobility and trade than north of the Alps. The aristocracy of Venice had its origin in commerce; and though untitled, they were among the most distinguished class of nobles in Europe. On the other hand, in Florence, in the 14th c., under a constitution purely mercantile, nobility became a disqualification from holding any office of the state. In order to the enjoyment of civil right, the nobleman had to be struck off the rolls of nobility; and an unpopular plebeian was sometimes ennobled, in order to disfranchise him. A little later, there grew up, side by side with the old nobility, a race of plebeian nobles—as the Ricci, the Medici—whose pretensions were originally derived from wealth, and who eventually came to be regarded as aristocrats by the democratic party.

Italian nobility has this peculiarity, that it does not, for the most part, flow from the sovereign, but from the municipal authorities of the towns acting in entire independence of him. The municipalities can confer nobility on whom they please, by inscribing his name in their respective *Libri d'oro*. The registers of nobility of most of the Tuscan towns are deposited in the *Archivio della Nobiltà*, or Herald's Office, at Florence—an institution created by the first sovereign of the House of Lorraine. The municipalities have, however, no power to confer titles, though at one time several persons, a few Englishmen included, on the strength of their names being in the *Libro d'oro* of Fiesole, assumed the titles of marquis, count, and baron—an abuse put a stop to by the late grand duke of Tuscany. In Rome, there is a small number of nobles—as the Colonnas, Caetania, and Orsini—who hold their fiefs as sovereign princes; the rest of the nobility, many of them of very ancient lineage, are municipal, the power of creation being vested in the senator, himself a nominee of the pontiff, and the *Conservatori*, chosen by lot from the Capitoline nobles. In last century, so many undistinguished persons had been added to the roll of nobility, that Pope Benedict XIV. found it necessary to prohibit by a bull the admission of any one whose ancestors had not filled certain high offices in the state. The same decree limited the number of noble families to 187, designed the *Patriziato Romano*, out of whom 60 of the oldest and most illustrious were chosen as *Nobili Conscritti*, otherwise called the Capitoline nobles, and restricted the admission to the patriziato for the future to persons who had rendered important services to the city, and whose names were approved by the *Congregazione araldica*, an exception being made in favour of members of the reigning pontiff's family. As the families of the conscritti became extinct, other patrician families, designated *Nobili Ascritti*, were added by the municipality to make up the number. The titles at present borne by the Roman nobility are: 1. Prince or Duke, generally so called, but officially designed 'Barone Romano'—a title acquired by the Borghesi, Rospigliosi, and others from popes of their respective families; in the case of the

Colonnas, Dorias, Odescalchi, &c., from royal or imperial erection; and in other instances—as the Caetani and Massimi—from investiture by the pope as a temporal sovereign. 2. Marquis and Count; many of these are provincial nobles, with titles generally derived from small feudal tenures, of which, in some instances, it would be difficult to shew the diploma, or point out the period of creation. In some parts of the Papal States it is understood that every head of a noble house is a marquis; and in the March of Ancona, Sixtus V. conferred the right to bear the title of count on all who were of noble blood at the period. 3. Knights (*Cavalieri*), a designation given to all who wear a Roman order, to Knights of Malta, and generally to younger sons of the titled nobility. 4. Princes, who, with the sanction of the pope, have purchased honours along with ancient fiefs, that carried with them ducal or princely titles, most of them *novi homines*, as the Torlonias. Titles do not descend to the younger members of the family; it is the general usage for the head of the house to bear the most ancient title, while the eldest son, on his marriage, assumes the second in point of antiquity. The title is sometimes the family name, sometimes the name of a feudal possession. The proper designation of the younger branches of titled families is 'dei Principi,' 'dei Duchi,' 'dei Marchesi,' &c.

The nobility of Spain boasts of a special antiquity and purity of blood, a descent from warriors and conquerors alone, without the infusion of any of the elements derived from the church, law, and commerce that are to be found in other countries. 'Hidalgo' (*hijo d'algo*, son of somebody, not *filius nullius*) is a term which implies gentility or nobility. The hidalgo alone has in strictness a right to the title 'Don,' which, like 'Sir' of our knights and baronets, requires the adjunct of the Christian name. When the Christian name is omitted, the title 'Señor' instead is prefixed with the addition of 'de.' 'Don' has latterly been used by persons who have no proper claim to it about as extensively as 'Esquire' in England. Hidalguia, till recently, conferred important privileges and immunities. The higher nobility are styled Grandees; formerly, the title was 'rico ombria,' and the ceremonial of creation consisted in granting the right of assuming the pennon and caldrón (*peñon y caldera*)—the one the rallying ensign of command, the other of maintenance of followers. In contradistinction from the grandees, the class of nobility below them are called 'los Titulados de Castilla.' Red blood is said to flow in the veins of the hidalgo, blue in that of the grandee. Formerly, there were three classes of grandees, whose mark of distinction was this—that a grandee of the first class was entitled to put on his hat in the royal presence before the king spoke to him; the second, after the king spoke to him; the third, after the king had spoken and he had replied. The second and third classes are now absorbed into the first. Of the grandees, some bear the title of duke, some of marquis, some of count; but it is the ambition of every grandee to unite in himself as many grandeeships, or have as many hats, as the phrase is, as he can. This is effected by the marriage of heiresses through whom *grandezza* descends, and whose names and titles are assumed by their husbands. An enormous accumulation of titles is sometimes found in the person of one grandee. Titles as well as estates go only to heirs of entail. The titulars of Castile are designed 'vuestra señoría;' in common parlance, 'ucía.' The title of Baron is little used in Spain. Physically and mentally, the grandees have degenerated from their ancestors, and they have not the influence at court and in the country which landed property

ought to give them. Most of them reside at Madrid, clinging to their nominal rank and real nullity, while they are practically excluded from all the functions of state.

In Russia, what nobility existed before Peter the Great was of a patriarchal not a feudal kind; but in his anxiety to assimilate everything to a western standard, the czar took the existing aristocracies of states quite differently situated as the model to which to approximate the fortunate of his own subjects. The Russian nobles have ever since been enlarging their privileges by encroachments on those under them. Before Moscow was burned, the mass of the nobles connected with the court lived there in great splendour, and along with their domestic serfs constituted half the population of that city.

The preservation of noble blood, untainted by plebeian intermixture, has often been reckoned a matter of much moment. In Spain most of all, this purity of lineage has been jealously guarded. In the German empire, no succession was allowed to feus holding immediately of the emperor, unless both parents belonged to the higher nobility. In France, the offspring of a gentleman by a plebeian mother was noble in a question of inheritance or exemption from tribute, but could not be received into any order of chivalry. Letters of nobility were sometimes granted to reinstate persons in this position. It is in Germany still important for many purposes to possess eight or sixteen quarterings, i. e., to be able to shew purity of blood for four or five generations, the father and mother, the two grandmothers, the four great-grandmothers; and also, in case of the sixteen quarterings, the eight great-great-grandmothers, having all been entitled to coat-armour. Among the higher grades of the peerage in England, a considerable number may be pointed out who do not possess this complete nobility. It is in Scotland more usual and more regarded, both among peers and untitled gentry, where the eight or sixteen quarterings are still in use to be displayed on the funeral escutcheon. At some of the minor German courts, the sixteen quarterings are not unfrequently an illusion, diplomas being granted in the absence of a full pedigree, to declare the parties as noble as if they had sixteen ancestors.

NOCERA, or NOCERA DEI PAGANI, a small town of Naples, in the province of Principato Citeriore, eight miles north-west of Salerno, and on the highway from that town to Naples. It carries on important woollen manufactures. Pop. 7400.

NOCTURN (Lat. *nocturnum*, recited 'by night'). Under the head BREVIARY (q. v.) has been explained the general order of the services of the canonical hours, in the Roman Catholic Church. The service of MATINS on Sundays and festivals is divided into three nocturns, each of which consists of three (or more) psalms and three *lessons*. The lessons are either from the Scriptures, from the life of a saint, or from a homily of some Father. The name is derived from the recitation of the service 'by night.'

NODAL POINTS, LINES, AND SECTIONS. When a string or metallic cord, under strong tension, is made to vibrate, we hear, besides the principal sound, several secondary and shriller sounds; these are denominated harmonic sounds, and are produced each by a certain portion of the chord which vibrates independently. Further investigation has shewn that every vibrating string is divided into a number of portions alternately vibrating in opposite directions, and that the points which separate these portions from each other are at rest. These points are

known as *nodal points*, and their situation may be found by placing small pieces of paper on an extended string, and causing it to vibrate; the points from which the pieces of paper have not been displaced are the nodal points. If a plate of glass or metal be held in the hand, and a well-roined fiddle-bow be drawn across the edge, particles of fine dust, previously placed on the plate, will arrange themselves in lines, shewing that along these lines no vibration has taken place; these lines are *nodal lines*, and are

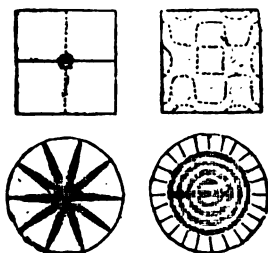

Nodal Points.

found in most cases to group themselves together into geometrical figures, and occasionally to present the most beautiful designs. The wood-cut represents a few specimens. The arrangement of the nodal lines depends on the point by which the plate is held, and on the form of the plate itself. Similarly, if a column of air in a wholly or partially closed tube be acted upon by the force of the breath applied through a hole at any point in its length, the column will divide itself into cylindrical portions each in a state of vibration, and separated from one another by transverse sectional portions in which the air is at rest; these latter sections are known as *nodal sections*.

NODDY (*Megalopterus* or *Anous*), a genus of birds of the family *Laridae*, differing from terns in having the bill slightly angular, thus exhibiting an approach to gulls, and the tail not forked but somewhat wedge-shaped. Only one species is known (*M.* or *A. stolidus*), a bird widely diffused



Noddy (*Megalopterus stolidus*).

both in the northern and southern hemispheres, and familiar to sailors, not only as often seen skimming over the water in quest of fishes, but also as not unfrequently alighting on vessels, and, particularly during the night, suffering itself to be taken by the hand. At its breeding-places also, where not accustomed to the visits of man, it scarcely gets

out of the way, and the female sits undisturbed on the nest. Hence it commonly shares with the Booby the reputation of unusual stupidity. It is about fifteen or sixteen inches long, from the tip of the bill to the end of the tail, the general colour being a brownish-black. The N. is a rare visitant of the British shores, but is very abundant in warmer latitudes; and on some of the *keys* of the West Indies, and other islets of different parts of the world, it breeds in immense numbers. Particular islets seem to be specially selected as the breeding-places of noddies; and there their nests are sometimes so closely placed that it is not easy to walk among them. Each nest generally contains three eggs, about two inches long, which are very good to eat, and are in some places collected in great numbers.

NODES, in Astronomy, are the two points in which the orbit of a planet intersects the plane of the ecliptic, the one through which the planet passes from the south to the north side of the ecliptic being called the *ascending node* (Ω), and the other the *descending node* (ϑ). As all the bodies of the solar system, whether planets or comets, move in orbits variously inclined to the ecliptic, the orbit of each possesses two nodes, and a line drawn joining these two points is called the *line of nodes* of each body. It is scarcely necessary to add, that as the earth moves in the plane of the ecliptic she has no nodes. The places of the nodes are not fixed points on the plane of the ecliptic, but are in a constant state of fluctuation, sometimes *advancing* (eastward), and at other times *receding* (moving westward). This motion is produced by the mutual attractions of the planets, which tend to draw each of them out of the plane of its orbit; and it depends upon the relative positions of the planets with respect to another planet whether that planet's nodes shall advance or recede. On the whole, however, the majority of possible 'relative positions,' or *configurations*, as they are called, is in favour of a retrograde motion; and we find by observation, that in an average of many revolutions round the sun a constant retrogradation of the node takes place. The determination of this retrogradation in the case of the planets is a most complicated problem, as the separate action of each on the others has to be taken into account; but in the case of the moon's nodes, the immensely preponderating attraction of the earth, and its great relative magnitude as compared with the moon, enable us to throw out of account any other disturbing influence, and at the same time to exhibit clearly the cause of this motion of the nodes. Suppose the moon to have attained her greatest north latitude, and to be descending towards the ecliptic, and the earth to be in longitude between her and her previous descending node, then the earth's attraction will tend to *depress* the moon's orbit, and cause her to descend to the plane of the ecliptic sooner than she would otherwise have done; in this case we have a retrogradation of the node. Again, supposing the moon placed as before, but the earth in advance of the line of nodes, then the earth's attraction will tend to draw the moon forward in her orbit so as to meet the ecliptic in a point beyond the previous descending node; in this case, the moon's node has advanced. As in the case of the planets, however, the retrograding tendency preponderates. The average annual retrogradation of the nodes is very small in the case of the planets, but considerable in that of the moon. See MOON. In calculating the courses of the planets, the 'length' of the ascending node, or its distance in longitude from the vernal equinox is a most important element. See ORBIT.

NODES, in Botany. See STEM.

NODES are swellings, most commonly of an oblong form, which occur on superficial bones, such as the tibia, ulna, clavicle, and frontal bone, and are due to a syphilitic taint, to scrofula, or to rheumatism. Their immediate cause is the infiltration of lymph or serum into the periosteum, or between it and the bone. The treatment depends so essentially on the constitution of the patient, and the primary cause of the swelling, that it would be inexpedient to enter into any detail regarding it.

NODIER, CHARLES E., an eminent French litterateur, was born at Besançon, 29th April 1783; other authorities give 1780 and 1781. His father was a distinguished lawyer, who warmly embraced the side of the revolution, and brought up his son in the same principles. At the age of 12, he was a member of the famous society of *Amis de la Constitution*, and hated tyranny with a most ideal and classical hatred; but he soon afterwards became a royalist; then, again under Napoleon, a republican; and indeed during his whole career shewed a want of that robust opinionativeness, without which it is impossible for a man to become a genuine politician. He died—after a life of the hardest literary work, in which time, and even admirable talents were wasted on inferior subjects—27th January 1844. Besides editions of the French classics, grammatical, lexicographical, and poetical works, he wrote numerous tales and memoirs. A portion of his writings was collected and published in 12 vols. at Paris, 1832—1834, under the incorrect title of *Œuvres Complètes*.

NOETIANS. See **PATRIASSIANS**.

NOGENT LE ROTROU, a town of France, in the department of Eure-et-Loir, is situated in a pretty vale on the Huisne, 32 miles west-south-west of Chartres. It is a station on the Great Western Railway from Paris to Rennes in Brittany. Pop. (1861) 5877. N. is a long, well-built town, with a ruined castle in the Gothic style, the residence of the great Sully.

NOGGING. Brickwork built in the panels of a timber-framed house. Noggings are horizontal timbers, introduced to strengthen the brickwork.

NOILS, a technical term employed for the short and broken hairs which are removed from wool in the process of combing and preparing it for worsted manufactures. The *noils* are used for making inferior yarns, and are valuable for *felting* purposes, in which they are largely employed.

NOLA, an episcopal city of Italy, in the province of Terra di Lavoro, 16 miles east-north-east of Naples, is built on the site of one of the oldest cities of Campania. The ancient N. was founded by the Ausonians, and fell into the hands of the Romans in the Samnite war, 313 B. C. For its protection, Marcellus in the second Punic war fought in its vicinity the first battles in which the Romans were victorious over Hannibal. Augustus died at Nola, 14 A. D. The first bells for Christian churches are said to have been cast here in the 5th century. See **BELL**. Numerous coins, and beautiful vases made of a pale-yellow clay, with figures painted in crimson and maroon, and supposed to have been manufactured here by potters from Corinth, have been found in the vicinity. N. was a flourishing city in the middle ages, and has at present 9000 inhabitants.

NOLI ME TANGERÉ, a popular name for one form of the disease which has been already described under the term *Lupus* (q. v.).

NOLLÉ PROSEQUI, a term used in English Law to denote that the plaintiff does not intend to

go further with the action, or part of the action, in which case he enters or files a memorandum, called a *nolle prosequi*, after which the action, or part of the action, is at an end on that point, and the defendant is entitled to his costs thereon.

NOLLEKENS, JOSEPH, was born in London in 1737. His father, who was from Antwerp, and by profession a painter, died when he was young, and his mother, a Frenchwoman, not remaining long a widow, he received but little education. Being placed in the studio of Scheemakers the sculptor, in Vine Street, Piccadilly, he worked hard, and made such progress, that, in 1759, the Society of Arts awarded him fifteen guineas for a group in clay; in 1760, thirty guineas for a bas-relief; and during the same year, ten guineas for a model in clay of a dancing faun. Soon after this, N. set out for Rome. He was then in his twenty-third year; his purse was light, he had no patron to support him; but he was independent in spirit, and had been trained to habits of economy. A bas-relief he carved in stone brought him ten guineas from England, and the Society of Arts voted him fifty guineas for his group in marble of Timoclea before Alexander. But one of the most important events for him, after settling in Rome, was his meeting Garrick in the Vatican, who immediately recognised his countryman as the young sculptor to whom the prizes had been awarded by the Society of Arts, sat to him for his bust, and paid him handsomely for it. This was the first bust he had been commissioned to model, and it gave him the opportunity of proving where his strength lay. He also executed in Rome a bust of Sterne in terra cotta, which added greatly to his reputation. After residing ten years in Rome, he returned to London, took a lease of extensive premises in Mortimer Street, where he set up his studio; and the reputation he had acquired in Rome was such, that he immediately had full employment, and within a year after (in 1771) was elected an Associate of the Academy, and a Royal Academician the following year. His forte was in modelling busts. Into these he infused much truth and character, and he has handed down the likenesses of most of the important personages who figured in this country in the end of the last and at the commencement of this c.—of Samuel Johnson, who was his friend and frequent visitor—of Fox, Pitt, and other political characters. George III. also sat to him; and his manner, which exhibited pretty strongly what is popularly set down as blunt and manly English character, made him a great favourite with the king. Besides busts, N. executed numerous commissions for public monuments and statues. He was selected by the Academy, with whom the choice lay, to execute the government commission of a monument to the three captains, Manners, Bayne, and Blair, who fell in Rodney's great battle of April 12, 1782; but in this he did not rise above the allegories of Neptune and his Sea-horse, and Britannia and her Lion. His statue of Pitt for Cambridge was much praised at the time. He also executed, either in the course of his studies, or to meet the views of those connoisseurs who advocate high art, a considerable number of classical and mythological statues and groups, a faun, a Bacchus, five Venuses, Cupid and Psyche, Pegasus and Arria, &c. He died in London, 23d April 1823. His wife, to whom he had been long married, and who had brought him some fortune, died a few years before him. He had no children, and his great wealth, upwards of £200,000, was left to certain friends, burdened with some legacies and annuities to his old assistants and servants.—See *Cunningham's Lives of British Artists, &c.*

NOMADS—NON-COMMISSIONED OFFICERS.

NOMADS (Gr. *nemcin*, to tend or feed), the name given (originally by the Greeks) to those tribes which, depending chiefly on their flocks and herds, have no fixed habitation, but move about for convenience of pasture. The nomad tribes are of a higher grade of civilisation than those that live by hunting and fishing, but much inferior to those engaged in agriculture and manufactures. They are very generally addicted to robbery, and readily engage in aggressive war, so that they have frequently become conquerors of extensive cultivated countries, as in the instances of the Huns, Arabs, and Tartars. There are now few nomads in Europe, and these only in the steppes near the Black Sea, and the regions of the utmost north, where cultivation is impossible. Almost all the Finnish, Mongolian, and Turkish tribes, and the tribes formed by mixture of these races, in the steppes and deserts of Central and Northern Asia are nomads, also the Kurds and the Bedouins, many of the tribes of Africa, and the Gauchos and some of the other Indian tribes in North and South America.

NOMBRIL POINT, in Heraldry. See **ESCURCHEON**.

NOME, a term used in the ancient Greek music to denote any melody determined by inviolable rules.

NOMINALISM. This word refers to a celebrated controversy of the middle ages, respecting the nature of our general or abstract ideas. It was contended by some that abstractions—as a circle in the abstract, beauty, right—had a real existence apart from round things, beautiful objects, right actions. This was called Realism. Those that held the opposite view were called Nominalists, because they maintained that there is nothing general but names; the name 'circle' is applied to everything that is round, and is a general name; but no independent fact or property exists corresponding to the name. There is nothing in a general name, they say, but a declaration of resemblance among a number of things; all things that the name is applied to, resemble one another in some point, which point of resemblance the mind can consider apart from the points of difference; this act of isolated consideration being what is called the power of abstraction. We can be engaged in thinking of the smell of a rose, we can compare it with other sweet odours, and speculate as to the nature of the material that gives the odour, or as to the pleasure that we derive from it; all this is a process of abstract thinking, but it would not of itself suffice to prove that the odour has a separate existence. We might also confine our attention to the mere form, or outline of the rose, and compare it with other forms; but we should be still less able to affirm the independent existence of this particular form.

Realism must be traced back to Plato's system of Ideas, or the eternal and independent existence of general attributes, from which the concrete embodiments were derived. There existed in the Divine Mind, according to Plato, patterns, models, or archetypes, according to which individuals were formed. The archetype circle was the origin of all actual round things. Aristotle denied the separate existence of these general forms, and held that they existed only in connection with matter, or with objects in the concrete. The Stoics repudiated universals in both senses. The Aristotelian view constituted the Scholastic Realism, and prevailed until the 11th c., when a re-action took place in favour of the Stoical doctrine, headed by Roscelin of Compiègne and John the Sophist. This was the

commencement of Nominalism. The celebrated Abelard was a disciple of Roscelin, and induced large numbers to depart from the Realistic notions, which were identified at the time with religious orthodoxy. The controversy raged with great violence through the 12th century. Thomas Aquinas and Duns Scotus, in the following century, gave their powerful adhesion to Realism. In the 14th c., William Occam, an English Franciscan friar, and a pupil of Scotus, revived the advocacy of Nominalism, which was once more maintained by a number of eminent men, in spite of the hostility of the church, carried the length of persecution. The controversy subsided at the Reformation.

A middle view between Nominalism and Realism was held by a few persons when the contest was at its height; which was, that although general properties have no separate existence in nature, they can be conceived in the mind apart from any concrete embodiment. Thus we may form an idea of a circle, irrespective of any individual round body. This view is specious, and is tacitly implied in many opinions that have never ceased to be held. See **GENERALISATION**.

NOMINATIVE. See **DECLENSION**.

NON-APPEARANCE, the term used in the Law of England to denote that a party against whom an action or suit has been commenced has not entered an appearance, which is the way by which he comes before the court to defend his right. In many cases, if he does not appear, the suit will go on in his absence, provided he was duly served with the writ of summons or bill.

NON-ASSUMPSIT, is in English Law the usual plea or defence to an action for breach of a contract not by deed, and means that the defendant denies that he broke the contract, or that there was any contract.

NON-COMMISSIONED OFFICERS, in the British army, constitute a numerous and very important class in the regimental system between the commissioned officers and the men. As the former are not permitted to mix with the private soldiers, lest familiarity should diminish the sway of absolute discipline, it is necessary to have an intermediate class to overlook the men in their barracks and at all times when off the parade. None are so suited for this duty as the best conducted of the men themselves, who are promoted by selection to non-commissioned rank, and hold many privileges and powers unattainable by the private. The non-commissioned officers comprise the serjeants-major, all the serjeants, the trumpeters, drummers, and buglers, and, in the Life Guards and Royal Horse Guards only, the corporals. They can be reduced to the ranks by sentence of a court-martial, or by their colonel-commandant; but not by a lieutenant-colonel nor by any junior officer. Non-commissioned officers are entitled to quarters for their wives, or lodging-money in lieu of quarters. Accustomed themselves to obey, the non-commissioned officers are admirable assistants in preserving discipline; veterans, to whom military life is a second nature, they are looked up to by their comrades as examples, to lead in battle or to teach in drill. The non-commissioned officers have a Mess (q. v.) to themselves. In a battalion of infantry, there at present are 81 non-commissioned officers to 800 rank and file; but the proportion varies, as the latter may be greatly augmented without affecting the number of the former; and in the whole British army (European) for the year 1864—1865, there are 19,363 non-commissioned officers. This intermediate rank is a necessity in all armies; in France, the non-commissioned

officers are termed *sous-officiers*; in Germany, *unter-offizieren*.

NONCONFORMISTS, a name sometimes given generally to all sectaries who, at any period in English history since the establishment of Protestantism, have refused to conform to the doctrine and practices of the Episcopal Church. It is, however, more frequently used in a restricted sense to denote the 2000 clergymen who in 1662—two years after the Restoration—left the Church of England, rather than submit to the conditions of the Act of Uniformity, which required of every beneficed minister, every fellow of a college, and even every schoolmaster, unfeigned assent to all and everything contained in the Book of Common Prayer. The ejected ministers swelled the ranks of the Presbyterians and Independents, the latter of whom are sometimes called Nonconformists.

NON-EFFECTIVE (Fr. *non-activité*), is the term applied to the portion of the personnel of the army or navy not on active service or in immediate readiness for active service. It thus comprises all officers on retired or half-pay, pensioners, and superannuated officers. In a force liable to frequent augmentations and reductions, the non-effective charge will necessarily be considerable; and the great French war, with the extensive reductions following it, bequeathed to the British an annual non-effective charge of several millions, which is only now beginning to be satisfactorily expunged. At present (1864—1865), the non-effective charges are £2,106,157 for the army, and £1,381,974 for the navy, being 13·8 per cent. on the gross cost of the two services.

NON-ENTRY, in the Law of Scotland, means that state of a feudal estate when the last vassal has died, and his successor has not been invested or seised of the land. On such an occasion, the superior is entitled to what is called a casualty of non-entry, which consists of the rent of the feu.

NON EST INVENTUS, a technical term used in that part of the law where, after judgment, the sheriff endeavours to arrest a party. If after a reasonable search he cannot find the debtor, he makes a return to the court that he has not been able to find the debtor, which is shortly called a return of *non est inventus*, and his duty is then discharged until a fresh writ is issued to him.

NONE (Lat. *nona*, 'ninth'), one of the lesser Canonical Hours (q. v.), so called from its recitation being primitively fixed at the ninth hour.

NONES. See **CALENDS**.

NONFEASANCE, in certain parts of the Law of England, means the not doing what one is bound to do.

NONJOINER, in English Law, is the omitting to join all the parties to the action or suit.

NONJURORS, the name given to that portion of the Episcopal clergy of England who at the coronation of William and Mary refused to take the oath of allegiance to these sovereigns, believing that they had unlawfully possessed themselves of the throne abdicated by James II. They were great champions of the doctrine of passive obedience on the part of subjects towards kings; and as the triumph of the Prince of Orange was obtained at the expense of that doctrine, it was impossible that they could, consistently with their antecedents, acknowledge him as their rightful king. The House of Commons allowed them six months longer than laymen to make up their minds, but declined to adopt the amendment of the Lords, viz., that the oath should not be imposed on the clergy. They refused, and were consequently deprived of their

sees and benefices. The nonjurors comprised Archbishop Sancroft, 8 bishops, and about 400 of the inferior clergy.

NON-RESIDENCE, the name given in Church Law to the offence of a person holding a Spiritual Benefice who absents himself without legal justification from the local precincts within which the duties attached to the benefice are prescribed to be performed. The obligation of residence follows clearly from every principle of law, and from the constant tendency to relaxation on the part of the clergy, has been an unailing subject of legislation, ecclesiastical and civil, from the very earliest times. The Council of Nice in 325, of Antioch in 332, and of Carthage in 401; the constitutions of the popes from the earliest genuine document of that class, the novels of Justinian, the capitularies of Charlemagne—all speak the same language, and enforce it by the same penalties. During the medieval period, and especially during the unhappy contests of the western schism, great abuses prevailed. The whole substance of the legislation of the Roman Church on the subject, however, is compressed in the decrees of the Council of Trent, which are mainly contained in the decrees of the XXII and following sessions, 'On Reformation.' The decrees of the council regard all church dignitaries, and others charged with the cure of souls. Without entering into the details, it will suffice to say, that for all the penalty of absence without just cause, and due permission, consists in the forfeiture of revenues, in a proportion partly varying with the nature of the benefice, partly adjusted according to the duration of the absence. For each class, moreover, a certain time is fixed, beyond which, during twelve months, absence cannot be permitted. The duty is imposed on persons named in the law of reporting to the ecclesiastical superiors cases of prolonged absence. The same legislation has been confirmed by most of the recent concordats, and is enforced by the civil law of each country. In England, the penalties for non-residence are regulated by 1 and 2 Vict. c. 106. Under this act, an incumbent absenting himself without the bishop's licence for a period exceeding three, and not exceeding six months, forfeits one-third of the annual income; if the absence exceed six, and does not exceed eight months, one-half is forfeited; and if it be of the whole year, three-fourths of the income are forfeited. The persons excused from the obligation of residence by the canon law are sick persons, persons engaged in teaching the theological sciences in approved places of study, and canons in immediate attendance upon the bishop ('*canonici a latere*'), who ought not to exceed two in number. By the act 1 and 2 Vict. c. 106, heads of colleges at Oxford and Cambridge, the wardens of Durham University, and the head-masters of Eton, Westminster, and Winchester Schools are generally exempted, and temporary exemptions from residence are recognised in other cases, which it would be tedious to detail. In the Roman Catholic Church, besides the general legislation, most of the provincial and diocesan statutes contain special provisions on the subject of non-residence.

NON-SUIT is a legal term in England, which means, that where a plaintiff in a jury trial finds he will lose his case owing to some defect or accident, he is allowed to be non-suited, instead of allowing a verdict and judgment to go for the defendant. The consequence is, that the plaintiff has to pay the defendant's costs; but he can bring a fresh action, if he can get over the difficulty that rendered a non-suit necessary or expedient.

NOOSSA. See **MOLUCCAS**.

NOOTKA DOG—NORFOLK.

NOOTKA DOG, a large kind of dog, common in a domesticated state among the natives of the vicinity of Nootka Sound. It has erect, pointed ears. It is chiefly remarkable for the extreme abundance of its long woolly hair, which, when shorn off, holds together as a fleece, and is spun and woven into garments. The introduction of this wool-bearing dog into other countries has been suggested, but not yet attempted.

NOOTKA SOUND, an inlet on the west coast of Vancouver's Island, British North America, in lat. 49° 35' N., long. 126° 35' W. Its entrance is protected by an island of the same name, and the Sound can be entered on both sides of the island. It extends inland for 10 miles in a north-north-east direction; but the greatest breadth of water is not more than 500 yards. Numerous small coves and inlets are found around the rocky shores. It affords good anchorage.

NORD, the most northerly department in France (whence its name), corresponding with the former province of French Flanders, and bordering on Belgium and the Straits of Dover. Area, 1,420,000 acres; pop. (1861) 1,303,380. It is composed of two parts, or at least narrows near the middle at Armentières, on the Lys, almost to a line. It is watered by the Scheldt and the Sambre, with their affluents, and by numerous canals. It is the most densely peopled department in France. The soil is fertile, well cultivated, and yields more abundant harvests than any other part of the country. Of the whole area, 853,606 acres are arable land. The principal products are wheat, hemp, beet-root, vegetables, tobacco, and fruits. Manufactures of lace, cambric, linens, and beet-root sugar are extensively carried on. It has twice the average proportion of railways and roads, and four times that of canals, as well as the most important coal and iron mines. No other department has so many populous towns and strong fortresses; none adds so much to the national revenue; in none are the people so intelligent, so susceptible of culture, or so industrious. In respect of its educational and benevolent institutions, as well as of its learned societies, it ranks next to the department of the Seine. The arrondissements are Lille, Douai, Cambrai, Valenciennes, Avesnes, Hazebrouck, and Dunkerque. The chief town is Lille.

NORDERNEY, a small island belonging to the kingdom of Hanover, lies three miles off the coast of East Friesland, and forms one of a string of islands that line that coast. Area about 4 square miles; permanent pop. 800. It has enjoyed, since 1797, a great reputation as a place for sea-bathing, and in the summer season has from 1600 to 2000 visitors. The little village at the west end of the island has a very tastefully-built *Conversations-Haus*, 130 feet long. Trees do not grow here.

NORDHAUSEN, a flourishing town of Prussian Saxony, pleasantly situated at the southern base of the Harz Mountains, on the Zorge, 38 miles north-north-west of Erfurt. The surrounding country is very fertile in corn, and in the vicinity commences the *Goldene Aue* (Golden Plain), a fertile valley watered by the Helme. It contains a gymnasium, numerous churches, one of which, St Blasius, contains two pictures by Luke Cranach. It carries on a thriving general trade, is the dépôt from which the Harz Mountains are supplied with necessaries, and has most extensive distilleries and considerable manufactures of tobacco, suocory, chemicals, cloth, leather, &c. Its spirit distilleries, of which there are fifty in almost constant operation, produce annually for export from 60,000 to 70,000 hogsheads of 180 quarts each. Pop. 15,649.

NÖRDLINGEN, a town in the west of Bavaria, is situated on the river Eger, 44 miles north-west of Augsburg by the Munich and Nürnberg railway. It has a Gothic church, with a high tower and fine organ, and manufactures of Tyrolese carpets, linens, and woollens, besides a large trade in feathers. Pop. 6920. N. is historically interesting as the scene of several battles, the most famous of which was fought, 6th September 1634, between 24,000 Swedes, under Count Horn and Duke Bernhard of Saxe-Weimar, and 45,000 imperialists under King Ferdinand. The former were defeated with the loss of 12,000 killed and wounded, 300 banners and standards, 80 cannons, and several thousand prisoners, among whom was Horn himself.

NORE is a sand-bank in the estuary of the river Thames, 4 miles north-east of Sheerness, on which there is a floating light, called the Nore light, in lat. 51° 29' N., long. 0° 48' W. The name, however, is more commonly applied to the portion of the estuary in the vicinity of the Nore light and sand-bank.

NORFOLK, a large and important maritime county of England, bounded on the north and north-east by the North Sea, and on the south by the county of Suffolk. Area, 1,354,301 acres; pop. (1861) 434,798. Its coast-line, extending from Yarmouth, on the east, to the mouth of the Nen in the Wash, is about 100 miles in length. From Yarmouth to Happisburgh, the coast is low and sandy; from Happisburgh to Weybourne, it is skirted by low cliffs; and west of Weybourne to the entrance to the Wash, where the banks are in great part dry at low-water, and where a considerable extent of land has been reclaimed from the sea (see WASH), it is low, and covered with sand or shingle. The surface of the county is level, or nearly so, none of the rising-grounds being considered worthy of being called hills. The principal rivers are the Ouse, the Yare, with its affluents the Wensum and the Waveney, and the Bura. Communication is kept up by the navigable rivers, and by the Great Eastern Railway. The climate is affected in spring particularly by cold north-east winds, but the air is in general dry and healthy. The soil consists chiefly of light sands and loams, and comprises a great extent of land, which though naturally not fertile, has been made so by judicious management. The agriculture of the county is in an advanced condition, and all the usual crops are extensively grown; while that of barley is especially celebrated. Half the acreage is devoted to rearing food for cattle, and thus the necessary supply of manure is secured. Geese and turkeys are extensively reared for the London market. The county, which forms two divisions, East and West N., returns four members to the House of Commons. The capital is Norwich.

NORFOLK, a city and port of entry of Virginia, U. S., 106 miles south-east of Richmond, and 32 miles from the ocean. The city is irregularly built on low ground, and contains a city hall, military academy, mechanics' hall, court-house, jail, custom-house, 3 banks, 14 churches. Its large deep harbour is defended by Fort Calhoun and Fortress Monroe, the largest fortress in America. A government navy yard, dry dock, and marine hospital are in the suburb of Gosport. N. was built in 1736; in 1776, it was burned by order of Lord Dunmore, the British colonial governor. In 1855, a large number of the inhabitants died of yellow fever; in 1861, at the secession of Virginia, the navy yard, attacked by the Confederate troops, was hastily set on fire and deserted by the Federals, who sank and burned several of the largest vessels in the American navy. Pop. in 1860, 14,609.

NORFOLK ISLAND—NORMAN ARCHITECTURE.

NORFOLK ISLAND lies in the Pacific Ocean, 1100 miles east-north-east of Sydney in Australia, in lat. 29° 10' S., and long. 167° 58' E. Length, 5 miles; breadth, 2½ miles; area, 8960 acres. It is the largest of a small cluster of islands, comprising N., Nepean, and Philip Islands, together with several rocky islets. The coasts are high and steep, and the surface generally uneven, rising in Mount Pitt to upwards of 1000 feet in height. The soil is fertile and well watered, and the climate healthy. In 1825, N. I. was made a penal settlement by the British government for the worst class of convicts sent out to New South Wales; but the experiment was a failure, and the establishment was broken up in 1855. In 1856, the inhabitants of Pitcairn Island (q. v.)—194 in number, descendants of the mutineers of the *Bounty*—were transferred hither by the British government; but after a few years a part of them returned to their old abode.

NORIC ALPS. See **ALPS.**

NORIUM is the name assigned by Svanberg to a metal, whose earth (or oxide) is associated with zirconia in certain varieties of the mineral zircon. Its existence is not as yet definitely established.

NORMAL SCHOOLS, institutions where teachers are instructed in the principles of their profession and trained in the practice of it. The name of Normal School is of French origin (*École Normale*, from Lat. *norma*, a rule or model), and is that generally used in Scotland; such institutions, in England, are oftener called 'Training Colleges'; and in Germany 'Seminaries.' That in acquiring knowledge the mind follows certain processes, and that any one imparting knowledge should do so in harmony with these processes, are truths which seem sufficiently obvious. It is only recently, however, that they have secured much attention; and they are even at this day deliberately denied by some men of thought, and of the highest educational position. The recognition of these truths has, however, been sufficiently extensive to secure the institution, in Great Britain, America, France, Germany, and Switzerland, of schools in which the principles of teaching form the subject of study, and in which model specimens of the art are given. Italy, and even Russia, are following in the wake of the countries named. These schools also afford a thorough course of instruction in the subjects which are taught in elementary schools. The only normal school for training the higher class of teachers for colleges and academies exists in Paris.

One of the earliest, if not the earliest, normal school in Great Britain was the Sessional School of Edinburgh (1830), afterwards developed into the 'General Assembly's Normal Institution.' The first attempt of a similar kind in England was that of the Battersea Training College, instituted by Mr. now Sir J. P. Kay Shuttleworth, and Mr Tuffnell. Sir J. P. K. Shuttleworth afterwards, acting as secretary to the Committee of Privy Council on Education, suggested measures which have resulted in the institution of 36 colleges for the training of teachers in Great Britain in connection with the Established and Dissenting Churches. These turn out hundreds of male and female teachers annually, who having, after a two years' course of training, received government certificates of merit, become teachers of elementary schools.

There has been for some years a reaction against the necessity of normal schools, and their maintenance at the public expense. But this reaction can only be temporary, and the great facts will survive, that every subject of instruction is best taught according to a certain method, and that all methods are based on the study of the human

mind. This is a position which it is impossible permanently to shake. The real founders of normal schools are those men who, with more or less clearness and width of view, have brought prominently forward these principles. Such were Plato and Quintilian, in ancient times; in more recent years, the most prominent names have been Comenius, Pestalozzi, Rousseau; and, in our own country, Ascham, Milton, Locke, Professor Pillans, and Dr Arnold.

NORMAN ARCHITECTURE. As its name implies, this style was originated and chiefly used by the Normans. Soon after their conquest of the north of France, they began to erect churches and cathedrals in memory of their victories. Their conquests supplied them with the means for making these large edifices. They were not contented with the small churches then common in France, but desired to erect monuments worthy of their great conquests. They accordingly expanded the dimensions, while to a great extent retaining the style of the buildings they found in France. They seem also to have borrowed some of their ideas from the Rhine. See **GOTHIC ARCHITECTURE.**

The leading characteristics of their style were size and massiveness. They adopted the old Latin plan (derived from the Basilica) of central and side aisles; and at the east end, they invariably placed a semicircular apse. They seized on the tower as a distinguishing feature, and developed it as their style progressed. The ornaments are simple and of great variety; but the most common and distinctive are the zigzag, billet, chevron, nail-head, &c. The windows and doors are simple, with semicircular arched heads—the former without tracery. The tympanum of the door-arch is occasionally filled with sculpture.

The nave arches are carried sometimes on single pillars, but more frequently, especially as the style advanced, on piers with shafts. The shafts are almost always recessed in nooks (or 'nook shafts'). Owing to the great size of the buildings, the architects were unable at first to vault the main aisle, which, accordingly, had usually a wooden roof, the side aisles only being vaulted.

The masonry is rude; the joints being large, and the stones generally unhewn. The style prevailed from about the beginning of the 10th c. till the death of William the Conqueror, near the end of the 11th century. There are many examples in Normandy, the churches at Caen being well-known buildings of the date of William.

This style of architecture was brought into England by the Normans at the Conquest, 1066. They there extended the scale of the buildings, as they had done in Normandy, preserving, however, many local peculiarities of the Saxon style, which they found in the country. The chapel in the White Tower of the Tower of London is the earliest example of pure Norman work in England. There are, however, many buildings, both in England and Scotland, which date from before the end of the 12th c., when the pointed style began to be used. Durham, Lindisfarne, Canterbury, Dunfermline are partially Norman, besides many other churches and castles. The Anglo-Norman is heavier than the French-Norman, the cylindrical nave piers of the above buildings being much more massive than those of French works. To relieve this heaviness, the chevron, spiral, and other groovings were cut in the piers. The mouldings and forms of doors, windows, &c., are the same as those of Normandy. There is one remarkable difference in the plans of the Early Norman churches in the two countries: in France, the apse at the east end is always semicircular; in England, this form was gradually given up; and

towards the end of the style, the square east end was universally adopted.

NORMANDY (Fr. *Normandie*), formerly a province in the north of France, bordering on the English Channel; now divided into the departments of Seine Inferieure, Eure, Orne, Calvados, and Manche. It is in general a very fertile, richly-cultivated land, resembling a garden in many districts. Its chief agricultural products are corn, flax, and fruits (from which cider is largely made); its fisheries and manufactures of great importance, and its horses the best in the kingdom. The inhabitants are for the most part descendants of the old Normans, and bear the stamp of their splendid ancestors. They are intelligent, strongly built, and of a noble and energetic character; warm-hearted and patriotic, they produce the boldest sailors, the most skilful fishermen, agriculturists, cattle-rearers, and gardeners in all France. In the north-eastern and more level part (formerly *Upper Normandy*), the principal towns are Rouen, Dieppe, Havre-de-Grace, Harfleur, Honfleur, Lisieux, Evreux, Yvetot; in the south-western and hilly part (*Lower Normandy*), the principal towns are Caen, Falaise, St-Lo, Bayeux, Coutances, Avranches, Balonne, Alençon, Cherbourg, and Mont-St-Michel.

In the time of the Romans, the country bore the name of *Gallia Lugdunensis II.* Under the Frankish monarchs it formed a part of Neustria, and was first called N. after Charles the Simple, in 912, had given it to Rolf or Rollo, the leader of a band of Norse rovers (see **NORMANS**), to be held by him and his posterity as a fief of the French crown. From Rolf (baptized into Christianity under the name of Robert) and Gisela, the daughter of Charles, sprung the later Dukes of N., of whom Richard I., grandson of Rolf, vigorously maintained his authority against his liege lords, Louis IV. and Lothaire. William II., son of Robert II., became Duke of N. in 1036; and in 1066, established a Norman dynasty on the throne of England (see **WILLIAM THE CONQUEROR**), thereby politically uniting N. with the latter country. In 1077, his eldest son, Robert, wrested N. from him, but it was again united to England under Henry I. in 1105. With this monarch, Rolf's male line became extinct. Henry II., the son of Henry I.'s daughter, Matilda, after the death of Stephen of Blois, obtained in 1154 the government of England and N.; but in the reign of his son, John Lackland, it was conquered by Philippe Auguste (1203—1204). It remained a portion of the French monarchy for more than 200 years; but after the battle of Agincourt (1415) it was reconquered by the English, who held it till 1449, when it was finally wrested from them by Charles VII. See Liquez's *Histoire de la Normandie* (2 vols. Paris, 1835).

NORMANDY, CUSTOMARY LAW OF (Fr. *Coutumier de Normandie*). The ancient provinces of France were governed principally by a system of laws called *Coutumes*, which had originated in local usages, and been in the course of time reduced to writing and formally sanctioned by the sovereign. *Coutume* was distinguished both from *loi*, which originated with the king, and from *us*, or usage not reduced to writing. Of the codes of customary law, one of the oldest and most famous was the *Coutumier de Normandie*. It was divided into the ancient and modern custom. The former was first reduced to a written form, in 1229, under St Louis; the latter was the ancient *coutumier*, modified and reformed in 1585 by commissioners appointed by Henry III., with the concurrence of the three estates of the nobility, clergy, and people of Normandy. The ancient *coutumier* treats principally

of the duties of the judicial officers, the proceedings in the different courts, and the rights and obligations of the kings of France, the Dukes of Normandy, the feudal lords, and the people. In the modern *coutumier* are minute regulations regarding the transmission of property by will and inheritance. Each of the twenty-two vicomtés, into which N. was divided, had a different mode of devising real property. The law by which the Channel Islands are still governed is based on the customary law of Normandy. The chief judge in Jersey, Guernsey, and Alderney retains the Norman name of bailli or bailiff, and his authority is much the same as that officer possessed under the Norman law. One of the most remarkable remnants of the *coutumier* still subsisting in the Channel Islands is the *Clameur de Haro*. Any one who considers that his rights of property are infringed, protests in the presence of two witnesses, and calling out three times 'Haro' (said to be a way of invoking Duke Rollo, noted for his justice), summons the trespasser to desist. He then applies to the authorities, relating what he has done, and proceeds to the Record Office, where note is taken of the circumstances; all which ceremonial must be gone through before bringing an action of trespass. The decision is generally referred to *une vue de justice*, and the losing party is subjected to a fine, and liable in costs: he had formerly also to undergo *un regard de château*, or twenty-four hours' imprisonment, for having implored the aid of the prince without cause.

NORMANS (i. e., Northmen), a name generally limited in its application to those sea rovers who established themselves in that part of France called after them, Normandy; but sometimes embracing also the early inhabitants of Norway. During the middle ages, the name Northmen, or Norsemen, was often used in a broader sense, to denote the entire population of Scandinavia, and still more frequently, perhaps, to designate the Danes and Norwegians, exclusive of the Swedes. The Germans and French called the piratical hordes who ravaged their shores Normans or Northmen; the Saxons, usually Danes or Eastmen. They were also distinguished by the latter as *Mark-* or *March-men* (from *Den-mark*), as *Ask-men* (i. e., men of the *ashen-ships*), and as the *Heathen*. The primary cause of the plundering expeditions southward and westward across the seas, undertaken by the Norse Vikings (*Vikingar*, meaning either 'warriors,' or more probably dwellers on the *vics*, i. e., bays or fiords), as they called themselves, under leaders, who took the name of 'Sea-Kings,' was doubtless the over-population and consequent scarcity of food in their native homes; besides, the relish for a life of warlike adventure, conjoined with the hope of rich booty, strongly attracted them; while—at least as long as the old Scandinavian religion lasted (i. e., till about the end of the 10th c.)—death in battle was not a thing to be dreaded, for the slain hero passed into a region of eternal strife in the Walhalla of Odin. Finally, discontent with the ever-increasing power of the greater chiefs or kings, induced many of the nobles with their followers to seek new homes.

The first Danish Norsemen made their appearance on the eastern and southern coasts of England in 787. After 832, their invasions were repeated almost every year. To one of these belongs the legend of Ragnar Lodbrok (i. e., Ragnar of the 'Shaggy Brogues'), who is said to have been taken prisoner by Ella, king of Northumbria, and thrown into a dungeon filled with vipers, where, while expiring amid horrible torments, he sung with heroic exultation the story of his life. The very existence, however, of such a person as Ragnar Lodbrok is questioned by many Scandinavian

NORMANS.

scholars. In 851, the Norsemen wintered for the first time in the island, and after 866 obtained firm footing there. The Anglo-Saxon Ethelred I. fell in battle against them in 871. His brother Alfred, known as Alfred the Great (q. v.), after a long and doubtful struggle, partially reduced them to subjection; nevertheless, he was compelled to leave them in possession of Northumbria and East Anglia; and had not only to defend himself against a new and fierce invasion led by the famous rover Hastings (q. v.), but like his immediate successors, to contend against the revolts of his Dano-Norman subjects. A period of external peace now ensued; but in 991 the invasions of the Danes and Norwegians began anew. The Saxon king, Ethelred II., at first sought to buy them off by paying a sort of tribute-money, called *Danegelt* (q. v.); but the massacre of the Danes living in England, by command of that monarch, 13th November 1002, was avenged by four expeditions under the Danish king, Swen, who frightfully wasted the country, and finally conquered it in 1013, dying the following year. His son Knut, or Canute (q. v.), after carrying on a struggle for the supreme power with Ethelred and his successor Edmund Ironside (q. v.), at length, on the death of the latter, became sole monarch of England, which now remained under Danish or Norse rulers till 1042. The government of the country then reverted into the Saxon hands of Edward the Confessor (q. v.), who was succeeded in 1066 by Harold II. (q. v.), son of the powerful Godwin, Earl of Wessex (q. v.); but in October of the same year, Harold lost his life and crown at the battle of Hastings, and William the Conqueror, a descendant of a Norwegian chief who had settled in Normandy, once more established a Norse dynasty on the throne of England, but one greatly refined and improved by long residence in a comparatively civilised region.

It was also Danish Norsemen, in particular, who ravaged the western coasts of the European mainland, from the Elbe to the Garonne. As early as 810, the Danish king, Gottfried, had overrun Friesland; but the power of the great Charlemagne was too much for these undisciplined barbarians, and they were overawed and subdued for a time. Soon after his death, however, they recommenced (circa 820) their piratical expeditions, and favoured by the weaknesses and dissensions of the Carolingian rulers, became, during the 9th c., the terror and scourge of North-western Germany and France. They plundered Hamburg several times, ravaged the coasts of the Frisians (which then extended as far as the Scheldt), and in 843 firmly planted themselves at the mouth of the Loire. But ere long they ceased to be satisfied with making descents and settlements on the coasts, and in their small piratical craft they swarmed up the great rivers into the interior of the country, which they devastated far and wide. Thus, in 845, they ascended the Seine and plundered Paris—an exploit which was frequently repeated. In 885, not less than 40,000 of these Vikings are said to have ascended the river from Rouen under the leadership of one Siegfried in 700 vessels, and besieged the capital for ten months. It was only saved at the expense of Burgundy, which was abandoned to their ravages. In 881, Louis or Ludwig III., king of the West Franks, inflicted a severe defeat on the invaders at Vimeu, near Abbeville in Picardy, the memory of which has been preserved in a song still popular among the country-people; but neither that, nor the repulse which they sustained from the brave German monarch Arnulf, near Louvain in 891, could hinder them from making fresh irruptions. In 892, they appeared before Bonn, and tradition says that bands of Danish rovers penetrated even into Swit-

zerland, and established themselves in the canton of Schweiz and the vale of Hasli. From their settlements in Aquitania they proceeded at an early period to Spain, plundered the coasts of Galicia in 844, and subsequently landed in Andalusia, but were defeated near Seville by the Moorish prince Abd-ur-Rahman. During 859—860, they forced their way into the Mediterranean, wasted the shores of Spain, Africa, and the Balearic Isles, penetrated up the Rhone as far as Valence; then turning their piratical prow in the direction of Italy, entered the Tyrrhene Sea, burned Pisa and Lucca, and actually touched the distant isles of Greece before their passion for destruction was satiated, or before they dreamed of returning west.

Doubtless Norwegian rovers also took part in these so-called Danish expeditions. We know that as early as the beginning of the 9th c. they made voyages to the north of Ireland, Scotland, the Hebrides, the Orkney and Shetland Isles; and the increasing power of Harald Haarfager in the 9th and 10th centuries, exciting great discontent among the smaller chiefs, great emigrations took place, and these islands became the new homes of these Norwegian Vikings. About the same period, colonies were settled in the Farø Isles and Iceland, from which some Vikings proceeded westwards across the North Atlantic to Greenland in 982, and thence, in 1002, south to a region which they called *Vinland*, now universally believed to be the coast of New England, thus anticipating the discovery of America by Columbus by nearly 500 years. From Norway also issued the last and most important expedition against the coast of France. It was led by Rolf or Rollo, who had been banished by Harald Haarfager on account of his piracies. Rolf forced Charles the Simple to grant him possession of all the land in the valley of the Seine, from the Epte and Eure to the sea. By the time of Charles the Bald the invaders had firmly planted themselves in the country, which then went by the name of Normandy (q. v.). They and their descendants are, strictly speaking, the Normans of history—warlike, vigorous, and a most brilliant race. They rapidly adopted the more civilised form of life that prevailed in the Frankish kingdom—its religion, language, and manners, but inspired everything they borrowed with their own splendid vitality. At a later period (the 12th c.), they even developed a great school of narrative poetry, whose cultivators, the *Trouveurs*, or *Trouvères*, rivalled in celebrity the lyrical Troubadours of Southern France. Their conquest of England, in 1066, gave that country an energetic race of kings and nobles, on the whole well fit to rule a brave, sturdy, but somewhat torpid people like the Anglo-Saxons. But though the Normans had acquired comparatively settled habits in France, the old passion for adventure was still strong in their blood; and in the course of the 11th c., many nobles with their followers betook themselves to Southern Italy, where the strifes of the native princes, Greeks and Arabs, opened up a fine prospect for ambitious designs. In 1059, Robert Guiscard, one of the ten sons of the Norman count, Tancred de Hauteville, all of whom had gone thither, was recognised by Pope Nicholas II. as Duke of Apulia and Calabria, and in 1071 as lord of all Lower Italy. His brother and liegman, Roger, conquered Sicily, 1060—1089. Roger II. of Sicily united the two dominions in 1127; but in the person of his grandson, William II., the Norman dynasty became extinct, and the kingdom passed into the hands of the Hohenstauffen family.

The Swedish Norsemen directed their expeditions chiefly against the eastern coasts of the Baltic—Courland, Esthonia, and Finland, where they made their appearance in the 9th c.—the very time when

their Danish and Norwegian brethren were roving over the North Sea, the English Channel, the Bay of Biscay, and were establishing themselves on the shores of England and France. According to the narrative of the Russian annalist, Nestor, they appear to have penetrated into the interior as far as Novgorod, whence they were quickly banished by the native Slavic and Finnish inhabitants, but were as quickly solicited to return and assume the reins of government. Hither, consequently, in 862, accompanied by other noted warriors, came three Swedish chiefs, Rurik, Sineus, and Truvor, sons of the same father, and belonging to the tribe of *Ros* (whence *Russ* and *Russians*). Rurik founded one kingdom at Novgorod, which stretched northwards as far as the White Sea. His successor, Oleg, united with that a second established by other Swedish adventurers at Kiev, which town now became the capital of the wide-extended Russo-Swedish kingdom. See **RUSSIA**. For a long period these Norsemen, who, it appears, became completely identified with their Slavic-speaking subjects in the 10th c., were dangerous enemies of the Byzantine empire, whose coasts they reached by way of the Black Sea, and whose capital, Constantinople, they frequently menaced, as, for instance, in 941, when Igor is said to have appeared before the city with upwards of 1000 ships or boats. Earlier in the same century, these Swedo-Russian warriors had found their way into the Caspian Sea, and actually penetrated to the coasts of Tartary and Persia. Partly from them, and partly from native Scandinavians, came those soldiers who from the 9th to the 12th c. formed the body-guard of the Byzantine emperors.—See *Deppings's Histoire des Expéditions Maritimes des Normands et de leur Etablissement en France au 10me Siècle* (2 vols. 2d edit. 1843); *Wheaton's History of the Northmen from the Earliest Times to the Conquest of England* (Lond. 1831); and *Worsaae's Minder om de Danske og Normændene i England, Skotland, og Irland* (Copenh. 1851).

NORNÆ, the *Parcs* of the northern mythology. They were three young women, by name *Úrd*, *Verdandi*, and *Skuld*—i. e., Past, Present, and Future. They sit by the *Urdar-wells* under the world-tree *Yggdrasil*, and there determine the fate both of gods and men. Every day they draw water from the spring, and with it and the clay that lies around the wells, sprinkle the ash-tree *Yggdrasil*, that its branches may not rot and wither away. Besides these three great norns, there are also many inferior ones, both good and bad; for, says the *Prose Edda*, when a man is born there is a norn to determine his fate; and the same authority tells us that the unequal destinies of men in the world are attributable to the different dispositions of the norns. These lesser norns corresponded to the *genii* of classic mythology. Women who possessed the power of prediction or magic also bore this name.

NORRISTOWN, a borough of Pennsylvania, U. S., on the north bank of the river Schuylkill, 16 miles north-west of Philadelphia, containing cotton and woollen factories, iron rolling-mills and foundries, machine-shops, court-house, jail, public library, bank, 13 churches, 3 academies, 1 German and 4 English newspapers, and about 10,000 inhabitants.

NORRKÖPING, the first manufacturing town of Sweden after Stockholm, is the chief town of *Linköping-Län*, in East Gotland, and is situated at the junction of the *Motala* with the Gulf of *Bravike*, in 58° 30' N. lat., and 16° 15' E. long. Pop. in 1860, 19,950. It is a fine, well-built town, with broad streets, large squares, and numerous churches

and charitable institutions. The rapid river *Motala*, which is spanned by several substantial bridges and lined with commodious wharfs, affords very considerable water-power, by which numerous systems of machinery are worked. The manufactures are cloths, stockings, starch, tobacco, soap, &c., while in the neighbourhood are the extensive ironworks and cannon foundries of *Finspång*. N. is a good salmon station, and is the principal Swedish port for the importation of wines and foreign spirits.

NORTH, FREDERIC, LORD, English minister, was born April 13, 1732, and educated at Eton, and Trinity College, Oxford. His father, Baron Guilford, a descendant of Roger, Baron North (*temp.* Henry VIII.), was created an earl in 1752. N. entered the House of Commons at an early age, was made a Lord of the Treasury in 1763, and inherited the Tory politics which, in the days of Charles II., had placed his ancestor in the highest ranks of the law and the state. It was his boast in the House of Commons, that 'since he had had a seat there he had voted against all popular, and in favour of all unpopular measures.' On the death of Charles Townshend, in 1769, he was made Chancellor of the Exchequer and leader of the House of Commons, a post for which he was well qualified by his eloquence, good humour, wit, and readiness of resource. His folly was, however, one of the immediate causes of the American War. Earl Russell, in his *Life and Times of C. J. Fox*, says that 'for £100,000 a year of revenue George Grenville provoked America, and that for £16,000 a year of revenue Lord North lost America.' In 1770, he succeeded the Duke of Grafton as prime-minister. As a minister he was too ready to surrender his own judgment to that of George III., who, with a narrower understanding, had a stronger will, and was determined to subdue America. N. was called by Horace Walpole the ostensible minister; the real minister was the king. N. had to encounter an ardent and powerful opposition, led by C. J. Fox and supported by Burke. It has since been proved that N. 'so early as 1778 was of opinion that the system he was pursuing would end in ruin to the king and to the country.' In 1778, he renounced the right of taxing the colonies. In 1782, it being impossible to carry on the war with America any longer, N. resigned. 'A more amiable man never lived,' says Earl Russell; 'a worse minister never since the Revolution governed this country.' With N.'s retirement came to an end George III.'s scheme of governing the country by his own will, and ruling the House of Commons by court favour and thinly disguised corruption. N. was succeeded by the Marquis of Rockingham, on whose death Lord Shelburne became premier. Fox's dislike of the terms of peace with America led him to enter into a coalition with N., whom he had for so many years inveighed against as a minister without foresight, treacherous, vacillating, and incapable. N. and Fox took office under the Duke of Portland in 1783, but the coalition destroyed Fox's popularity, and the Portland administration only lasted a few months. N. was afflicted by blindness during the last five years of his life. He succeeded to the earldom of Guilford, in 1790, on the death of his father, and died in August 1792.

NORTH BERWICK. See **BERWICK, NORTH**.

NORTH CAPE. See **MAGEBORG**.

NORTH CAROLINA. See **CAROLINA**.

NORTH-EAST AND NORTH-WEST PASSAGES. The numerous and important discoveries made by the Portuguese and Spaniards in the southern latitudes of Asia, and the reports which, on their return, they spread of the fabulous wealth of those regions, excited the attention of the other

NORTH-EAST AND NORTH-WEST PASSAGES.

maritime nations of Europe, and prompted them to send out expeditions to the East Indies for the purpose of obtaining a share in the lucrative traffic of which Spain had hitherto possessed the monopoly. But the latter power, then at the height of her prosperity, was not disposed to admit other nations as sharers of her good-fortune, and dealt so summarily with all intruders, having at that time the complete command of the Atlantic and Indian Oceans, that her rivals were reluctantly compelled to abandon all thoughts of trading in those seas. Unwilling, however, to lay aside their designs of opening a trade with the far-famed India and Cathay (as China was then called), they resolved to attempt to reach those regions by some other route. Two plans appeared most feasible—the one to reach Eastern Asia by coasting along the north of Europe and Asia, the *North-East Passage*; the other by sailing westward across the Atlantic. The latter was first attempted by John Cabot in 1497, but he found his progress barred by the American continent, or, at least, those parts of it known as Newfoundland and Labrador. Three years afterwards, Gaspard Cortereal and his brother made three several voyages in the same direction; and on reaching Newfoundland, sailed northwards, but were stopped on the coast of Labrador, in lat. 60° N. Both brothers afterwards perished, with all their followers. Several voyages were soon after made to discover if a passage for ships existed to the north of America (the *North-West Passage*), but without success; and the hardships which navigators were subjected to in these inhospitable climes, caused the abandonment for the time of all further investigations in that direction.

North-East Passage.—The search for a North-East Passage was now vigorously prosecuted, and England had the honour of sending out the first expedition for this purpose in 1553. It consisted of three ships, commanded by Sir Hugh Willoughby, and was fitted out under the direction of the celebrated Sebastian Cabot; but on rounding the North Cape, one of the ships was separated from the others during a violent storm, and subsequently entered the White Sea, then unknown to western Europeans. The other two, under Willoughby, drifted hither and thither in the vast waste of water surrounding the pole, till the navigators sighted Nova Zembla. Being unable to land, they sailed back along the north of Russia, and took up their winter quarters on the coast of Russian Lapland, where they were subsequently found frozen to death. Several other expeditions were, at different times, sent out by the English and Dutch, but none of them ever succeeded in penetrating further than the east coast of Nova Zembla, though they rendered good service to geography by making accurate surveys of Northern Europe and the adjacent islands of Spitzbergen, Nova Zembla, Waygat, &c. It was for a long time believed that the promontory which forms the eastern boundary of the Gulf of Obi was the *Tabis* of Pliny, and formed the north-east corner of Asia; and this opinion, which received the assent of the celebrated Gerard Mercator, tended greatly to encourage renewed explorations, as, according to it, the eastern coast of Asia was not more than 400 miles from Nova Zembla. The following is a list of the chief expeditions for the discovery of the North-East Passage:

Willoughby and Chancellor,	English,	1553
Burroughs,	"	1556
Pet and Jackman,	"	1580
Barents, William (three expeditions),	Dutch,	1594—1596
Hudson, Henry, (first expedition),	English,	1608
Hudson, Henry, (second expedition),	Dutch,	1609
Wood,	"	1678

In his third expedition Barentz nearly reached Icy Cape, about long. 100° E., but was, with his crew, imprisoned by the ice, and died before the return of spring. Various important discoveries were made during this expedition, which proved that in favourable seasons a passage could be found to the eastward, but after the subsequent failures of Hudson and Wood, the attempt was abandoned in despair. The Russian government now took up the search, and both by overland expeditions, and by vessels starting from various points on the north and east coasts of Siberia, sought to discover a practicable passage. The chief of these expeditions were those of Behring in 1741, which started from Petropaulovski, and was stopped at the East Cape; of Shaloroff, who with his crew perished of starvation; and of Billings, which started from the mouth of the river Kolyma, in Siberia. A final attempt was made by the Russian government by means of sledge expeditions in 1820—1823, which resulted in establishing the impracticability of any passage through these seas, on account of the constant alternation of open sea with fields of ice.

North-West Passage.—As was formerly mentioned, Sebastian Cabot and the brothers Cortereal were the first who attempted to double the north coast of America; Cabot had reached as far north as lat. 67° 30', in the strait between Greenland and America, but the courage of his crew failing, he was compelled to return. Notwithstanding his urgent representations, he was unable to prevail upon the English monarch to send out another expedition, and it was not till after several unsuccessful attempts had been made to find a North-East Passage that investigations of the north coast of America were resumed. As these investigations were carried on till within the last few years solely by the English, their prosecution till a definite result was arrived at came to be looked upon as a point of national honour, and repeated expeditions were sent out long after it had been clearly shewn that a North-West Passage, when found, would be useless in a mercantile point of view. In all, more than 200 voyages were made in search of the North-West Passage, so that only the most important of them can be even mentioned. The first expedition, after that of Cabot, was sent out in 1576, under James Frobisher, who made a second and third voyage in the two following years, but without any important discovery. In 1585—1588, northern enterprise received an impetus from the successful expeditions of Captain John Davis. This navigator sailed up the strait which bears his name, as far as lat. 72° north, and reported open sea still further north; he then surveyed the east and west sides of the strait, but without further important results. Henry Hudson (q. v.), who had previously attempted the North-East Passage, followed in 1610, and discovered the Hudson Strait and Bay, believing the latter to be none other than an inlet of the Pacific Ocean, an opinion which was proved erroneous by the investigations of Button in 1612; the latter, however, disseminated on his return the equally erroneous opinion that the bay was closed in on all sides, with the exception of the two eastern entrances. Button's account was not universally credited, and accordingly in 1615, Captain Bylot, who had been one of Hudson's company, was sent out, accompanied by Baffin, the most skillful navigator and scientific observer of the time; but their first expedition, which was to Hudson's Bay, was devoid of results. In their next voyage (1616), they sailed up Davis' Strait, reaching lat. 78° N., and satisfying themselves by a very superficial investigation that there was no northern outlet, the bay (as it was then believed to be) was named in honour of its explorer Baffin's Bay. On their

return southwards, they coasted along the west side, and discovered an opening to the west which they named Lancaster Sound, but believing it to be only an inlet, did not explore further. On his return, Baffin gave it as his decided opinion that no outlet to the west existed from Baffin's Bay, and the attention of explorers was again directed to discover an outlet from Hudson's Bay. In 1619, the solitary attempt by foreign powers to aid in the search was undertaken by Jens Munk, a Dane, but he made no discoveries, and the attempt was not renewed. The expedition of Fox and James, in 1631, led to the partial exploration of the channel since known as the Fox Channel, which forms the northern outlet to Hudson's Bay, and from this time the spirit of discovery alumbered till 1741. Between this date and 1746, several expeditions were sent out to discover an outlet from the north-west corner of Hudson's Bay, but their united researches satisfactorily proved that no such outlet existed. Owing to these disappointments, the search for a North-West Passage was discontinued for more than half a century, notwithstanding the fact of the British parliament having promised a reward of £20,000 to the fortunate discoverer. In 1818, the Admiralty took up the search, and sent out Captain John Ross and Lieutenant Parry, who sailed up Davis' Strait, and ascended Lancaster Sound for thirty miles; here Captain Ross gave up the search, considering it to be hopeless. But this opinion was by no means coincided in by Parry, who was accordingly sent out in the following year, and succeeded in far outstripping all his predecessors in the career of northern discovery. He entered Lancaster Sound on 30th July, and a few days afterwards discovered a large inlet, thirty miles broad, which he named Prince Regent Inlet. After exploring this inlet for some distance, he returned, and continued his course westward, as the ice allowed him, passing through a strait which he named after Sir John Barrow, the promoter of the expedition. Continuing his westward course, he reached long. 110° W., in Melville Sound, where he was stopped by the ice; and after wintering here, and giving names to the numerous islands, seas, and straits he had discovered, returned to Britain, with the glory of having advanced 30° of longitude further west than any previous explorer. On his arrival, he was welcomed with the utmost enthusiasm, and his discoveries imparted renewed energy to the half-dormant maritime enterprise of the British. There was now no doubt in what direction the North-West Passage was to be sought, but Parry's second expedition (1821—1823) was for the purpose of determining whether the Fox Channel was connected with the Arctic Sea of his previous voyage; it was, however, unsuccessful. A little before this time, the coast-line of North America from Behring's Strait to Point Turnagain, in long. 109° W., had been fully traced, so that it only remained to find some navigable passage from Regent Inlet to this point, and the long-wished-for result would be attained. For this purpose, Captain John Ross was sent out with an expedition in 1829, and after a laborious and difficult voyage up Prince Regent Inlet, reached a point only 200 miles from Point Turnagain. It was during this voyage that he discovered the magnetic pole. Dease and Simpson, in 1838, extended the survey of the American coast from Point Turnagain to within 90 miles of the magnetic pole, but the hopes of a channel between these points were dashed by the discovery made by Dr John Rae, in 1847, that Boothia (the land which bounds Regent Inlet on the west) is a peninsula of the American continent. We now come to the unfortunate expedition of Sir John Franklin, which, it was fondly hoped, would settle the question of a

North-West Passage. It sailed from England, May 19, 1845, and was last seen in Baffin's Bay. Franklin is believed to have sailed through Lancaster Sound, and ascended Wellington Channel to lat. 77° N., and thence returned southwards, crossing Barrow Strait, and sailing down the channel (now called Franklin Channel) which separates North Somerset and Boothia Felix from Prince of Wales Island to the west, where, in lat. 70° N., long. 98° 30' W., his ships were beset with ice, 12th September 1846, and Franklin died 11th June 1847. The survivors abandoned the vessels 20 miles south-west of this point, and perished in the attempt to reach the American mainland. Many expeditions were sent out to search for the missing voyagers, and one of these expeditions, under Collinson and M'Clure, sailed from Plymouth, 20th January 1850, and reached Behring's Strait in August the same year. Sailing eastward the following spring, M'Clure's ship became fixed in the ice, about 60 miles west of Barrow Strait, and the crew were picked up by Sir Edward Belcher, who had been sent out in April 1852 to their assistance. Belcher, who had reached Melville Sound by the eastern passage through Lancaster Sound and Barrow Strait, returned the same way; and thus M'Clure and his company enjoyed the envied honour of being the only ship's crew who had ever penetrated from Behring's Strait to Baffin's Bay. To M'Clure, then, belongs the honour of having finally set at rest all doubts as to the existence of a North-West Passage. By the various English and American expeditions which were sent out to search for Sir John Franklin, the whole region to the north of the American mainland as far as lat. 77° N., and long. 106° W., has been thoroughly explored, and various channels of communication between Davis' and Behring's Straits have been discovered, such as the route by Hudson's Bay, Fox Channel, Fury and Hecla Strait and Bellot Strait, into Franklin Channel, and thence by either the M'Clintock or the Victoria Channel, or the routes by Lancaster Sound, and the M'Clintock Channel, Prince Regent Inlet, or Prince of Wales Strait, to the open sea north of Russian America, but all these routes are utterly useless in a mercantile point of view.

NORTH SEA (ancient *Germanicum Mare*; Ger. *Nord See*), that arm of the Atlantic Ocean which separates the British Islands on the west from the continent on the east. It is 700 miles in extreme length (from north to south), about 400 miles in greatest breadth, and has an area of not less than 140,000 square miles. The great commercial highways from the N. S. to the Atlantic are by the Pentland Firth and the Straits of Dover; while on the east it communicates with the Baltic by the Skagerrack, the Cattegat, Sound, and Great and Little Belts. Along its south-eastern and southern coasts the shores are low, and are skirted by sand-banks, formed by the sand deposits carried to the sea by the waters of the Elbe, Weser, Rhine, and Scheldt, which are the principal rivers that flow into this sea from the east. The shores of England, especially in the south, are also low, and here sand has also accumulated, though not nearly to the same extent as on the continental coasts. The chief British rivers that fall into the N. S. are the Thames, Ouse, Humber, Tyne, Tweed, Forth, and Tay. Besides the sand-banks on the coast already referred to, there are others extending to the middle of the sea-bed, similar in their origin to those on the coasts, and occupying altogether about three-fourths of the entire area. Of these, the principal are the bank running north-east from the mouth of the Firth of Forth for 110 miles; the one extending north-west from the mouth of the

NORTH WALSHAM—NORTHUMBERLAND.

Elbe for about the same distance; the Dogger-bank (q. v.), &c. These sand-banks, combined with the storms and fogs so common in the N. S., render its navigation unusually dangerous. Another peculiarity of the bed of this sea is, the number of extraordinary 'holes' which have been found in it. Of these the most remarkable are the Little Silver Pit off Holderness in Yorkshire, and the North-north-east Hole, 8 leagues further east. Little Silver Pit is 25 miles in length, and from half a mile to two miles in width. At its edges there is a depth of from 50 to 80 feet of water, but the 'hole' has a depth of 330 feet. In the north, along the Norwegian coasts, the shores are steep and rocky, and there is a depth of about 190 fathoms. The depth (31 fathoms on an average) increases from south to north. The currents of this ocean are extremely various, and demand the greatest caution on the part of the navigator. Owing to the prevalence of south-west winds, the currents shew a general tendency towards the north-east. On the south-western coast of Ireland, the great tidal wave of the Atlantic is broken into two portions, one of which, coursing up the Channel, passes through the Straits of Dover; while the other, sweeping north, passes round the north of Scotland, and then southward along the east coast of Britain, and meets the southern wave off the coast of Essex. The northern portion of the tidal wave spreads over the whole of the German Ocean, and though on its entrance into the N. S. it is only 12 feet in height, it rises in its progress southward, as the sea becomes narrower, in the same way as the *bore* (q. v.) is formed in a contracting estuary. In the estuary of the Humber it rises to the height of 20 feet. This sea yields immense quantities of fish, the most important kinds being cod, hake, ling, turbot, sole, mackerel, and herring, also lobsters. The fisheries employ many thousand people. On all available points of the coasts, light-houses have been erected, and there are numerous floating-light vessels moored to detached banks. The traffic on the N. S. is enormous. It is surrounded by countries whose inhabitants have from the earliest times been famous on the seas, and the enterprise and national bias that formerly covered the Scandinavian waters with conquering fleets, may now be traced in the vast commercial intercourse carried on on the North Sea.

NORTH WALSHAM, a small market-town of England, in the county of Norfolk, on an acclivity on the right bank of the Ant, 14 miles north-north-east of Norwich. Its market-cross, repaired after the great fire in 1600, by which the town was almost entirely burned down, dates from the reign of Edward III. Pop. (1861) 2396.

NORTH-WEST PROVINCES, a great political division of British India (see INDIA), between Kumaon and Nepal on the north-east, and Rajpootana on the south-west, consisting of the following six subordinate divisions: Delhi, Meerut, Rohilcund, Agra, Allahabad, and Benares. Each of these divisions comprises five districts, with the exception of Benares, which comprises six. They are treated separately. The area of the North-West Provinces is 116,493 square miles; and the pop. (1859—1860) 30,110,497.

NORTHALLERTON, capital of the North Riding of Yorkshire, a market-town and parliamentary borough, 250 miles north-north-west of London, and 30 miles north-north-west of York by railway. It stands near the left bank of the Wiske. It contains a large number of public schools and other institutions. Manufactures of linen and leather, brick-making, and malting are

carried on on a limited scale. Pop. (1861) of parliamentary borough, 4755, who send a member to the House of Commons. The battle of the 'Standard,' so called from a huge standard erected on a car by the English, was fought here, August 22, 1138, between the English under the Earls of Albemarle and Ferrers, and the Scotch under King David. The latter were defeated, and forced to retreat with great loss.

NORTHAMPTON, a village of Massachusetts, U. S., 1 mile west of the Connecticut River, 95 miles west of Boston, on the Connecticut River Railway. It is celebrated for its beautiful scenery, Mounts Tom and Holyoke rising from a picturesque valley. It contains many elegant residences, the county buildings, 2 banks, several academies, 7 churches, 1 cotton factory, 2 silk factories, 3 paper-mills. A bridge, 1230 feet long, connects it with Hadley. Pop. (1860) 6788.

NORTHAMPTON, capital of the county of the same name, a market-town, and parliamentary and municipal borough, on a rising-ground on the left bank of the Nen, 67 miles north-west of London by railway. In the centre of the town is a spacious market-square. The principal edifices are the shire-hall, the new and handsome town-hall, the corn exchange, the numerous churches, several of which are unusually interesting, as St Peter's, a recently restored and beautiful specimen of enriched Norman, and St Sepulchre's, one of the very few round churches in the empire, and supposed to have been built in the 12th century. The hospitals of St John and St Thomas were religious houses prior to the Reformation. Boot and shoemaking, which affords employment to about 3000 persons, is the principal branch of trade carried on here. Leather is made, and hosiery and lace are manufactured. Iron and brass foundries are in operation, and brewing is carried on. Races, called the Pythley Hunt Races, take place here every year in March. Pop. (1861) of municipal and parliamentary borough, 32,813, who return two members to parliament.

N., a very ancient town, was held by the Danes at the beginning of the 10th c., and was burned by them in 1010. After the Conquest, it was bestowed on Simon de St Liz. Its castle was besieged by the barons in 1215, during the civil wars of King John. It was the scene of a great battle fought (July 10, 1460) during the Wars of the Roses, between the rival houses, in which the Earls of March and Warwick defeated the Lancastrians.

NORTHAMPTONSHIRE, a central county of England, bounded on the W. by the counties of Warwick, Leicester, and Rutland, and on the S.-W. by Oxfordshire. Area, 630,358 acres; pop. (1861) 227,704. Its surface is marked by gently undulating hills, alternating with well-watered vales. The chief rivers are the Nen and the Welland, both of which flow north-east, and fall into the estuary of the Wash. The county is traversed by the London and North-Western, the Great Northern, the Eastern Counties, and other lines of railway, and communication by water is maintained by the Union, Grand Junction, and other canals, as well as by the rivers. The climate of the county is mild and healthy; the soil, a black mould in the fen districts in the north-east, and a brown loam on the uplands, is very productive. White and green crops are abundantly produced, and on the rich pastures cattle are extensively reared for the London market. Four members are returned to the House of Commons for the county. The county town is Northampton (q. v.).

NORTHUMBERLAND, the most northern county of England, is bounded on the E. by the

North Sea, and on the N.-W. by the Scottish counties of Roxburgh and Berwick. Area, 1,249,299 statute acres; pop. (1861) 343,025. The surface of the county has a rugged, and especially in the west and south-west a naked and barren aspect. The Cheviots run along the western border of the county, and send out spurs toward the east, which, gradually declining, are separated by fertile valleys, that widen as they approach the coast. About one-third of the area of the county is occupied by moorland, and along the Cumberland border the broken and bleak-looking hills are valuable for their lead-mines. Allenheads, the centre of the lead mining district, is the highest inhabited spot in England, being 1400 feet above sea-level. The inclination of the surface toward the east is indicated by the direction of the rivers Alne, Coquet, and North Tyne, which with the Tyne and Till are the principal rivers of the county. The Tweed forms the boundary of the county on the north for about 5 miles, and the south boundary is formed in part by the Derwent and Tyne. The climate is cold, but is milder on the coast than amid the hills, which, however, produce sufficient herbage for the maintenance of large flocks of 'Cheviot' sheep. The principal agricultural tracts occur along the coast, and inland along the river valleys for several miles. In these districts, the soil, for the most part, is a strong fertile clayey loam, productive in wheat, barley, beans, and clover. Agriculture is pursued on the most improved methods, and cattle, chiefly short-horned, are extensively reared. The south-east portion of the county forms a part of the great Northumberland and Durham coal-field, which was estimated to have produced, in 1862, upwards of 20,000,000 tons. The county is traversed by the Newcastle and Carlisle, North-Eastern and Border Counties Railways. The county returns four members to the House of Commons; the county town is Alnwick (q. v.).

NORTON, ANDREWS, REV., American scholar and theologian, was born at Hingham, Massachusetts, December 31, 1786. Having graduated at Harvard College in 1804, he was appointed, in 1809, a tutor of Bowdoin College, and in 1811 mathematical tutor at Harvard, and in 1813 librarian of the university, and succeeded Dr Channing as lecturer on biblical criticism and interpretation. In 1819, he was appointed Dexter Professor of Sacred Literature, which office he retained until failing health compelled his retirement in 1830. Dr Norton was, after Dr Channing, the most distinguished exponent of Unitarian theology, a clear and perspicuous lecturer, an able and conservative critic, and a voluminous writer. Rejecting the doctrine of the Trinity, and protesting against Calvinism, he also opposed the school of Theodore Parker and the naturalistic theology. Besides his contributions to the *General Repository and Review*, the *North American Review*, *Christian Examiner*, he published (1833) *A Statement of Reasons for not believing in the Doctrine of the Trinity*; (1837) *The Genuineness of the Gospels*; (1839) *On the Latest Forms of Infidelity*; and left some poems and a translation of the gospels. He died at Newport, Rhode Island, September 18, 1863.

NORTON, THE HON. CAROLINE ELIZABETH SARAH, a poetess and novelist of some reputation, the daughter of Thomas, and the granddaughter of Richard Brindsley Sheridan, was born in 1808. Her father died while she was still a child, and her education, which embraced an unusually varied course of studies, was superintended by her mother. In 1827, she married the Hon. George Chappel Norton. In 1831, she first met Lord Melbourne,

then prime-minister, and the intimacy which succeeded having given rise to some scandalous rumours, Mr Norton brought an action against Lord Melbourne, which, however, resulted in a verdict for the defendant. From her childhood, Mrs N. had practised the art of verse-making. Her principal works are *The Sorrows of Rosalie* (1829); *The Undying One* (1830); *The Child of the Islands* (1845); *Stuart of Dunleath*, a novel (1847); *English Laws for Women in the Nineteenth Century* (1854); *The Lady of Garaye* (1862); *Lost and Saved*, a novel (1863).

Her prose works, several of which depict the wrongs incident to the position of women, are written with considerable cleverness and vigour; and her verse, though overstrained and stogy in sentiment, has numerous admirers, and manifests some degree of that brilliancy for which the Sheridans have been so famous.

NORWALK, a township of Connecticut, U. S., on both sides of the mouth of Norwalk River and Long Island Sound, on the New York and New Haven Railway, 45 miles north-east of New York, and 31 south-west of New Haven. It has manufactories of iron, machinery, hats, felt-cloth (of which two companies make 500,000 yards per annum), 9 churches, &c. Pop. (1860) 7582.

NORWAY (Norweg. *Norge*), the western portion of the Scandinavian peninsula, which, together with Sweden, forms one joint kingdom, is situated between 57° 56' and 71° 10' N. lat., and between 5° and 28° E. long. It is bounded to the E. by Sweden and Russia, and on every other side is surrounded by water, having the Skagerrak to the S., the German Ocean to the W., and the Arctic Sea to the N. Its length is about 1100 miles, and its greatest width about 250 miles; but between the lat. of 67° and 68°, it measures little more than 25 miles in breadth. The area is given as 121,779 square miles, and the population (in 1860) as 1,600,000. The whole of the Scandinavian peninsula consists of a connected mountain mass, which, in the southern and western parts of N., constitutes one continuous tract of rocky highlands, with steep declivities dipping into the sea, and only here and there broken by narrow tracts of arable land. South of Trondjem (63° N. lat.), the rocky ridge expands nearly the entire breadth of Norway. The northern portions of the range, known as the *Kiöllen Fjelle*,* occupy a space of about 25 miles in width, and form as far north as 69° the boundary-line between Sweden and Norway. In those high latitudes the range rises rapidly on the western side, forming elevations of 4000 feet, at a distance of only 4 or 5 miles inland. Of the numerous summits which lie along the watershed, and which rise above the line of perpetual snow, the highest, known as the *Sulitelma*, has an elevation of 6200 feet. The mean level of the range, which seldom rises more than 4000 feet above the sea, is occupied by extensive snow-fields, from which glaciers descend to the edge of the sea, while here and there the vast snow plain is broken by *fjords* (i. e., friths), some of which, as the *Folden Fjord*, penetrate upwards of 70 miles through the rocky masses. These inlets run, in many cases, through the middle of long and broad finely wooded valleys, enclosed by rocky walls, which are either quite bare, or covered with lichens and mosses or stunted brushwood, among which falls of water pour perpendicularly down the mountain-side. South of 63° N. lat., the range of the Scandinavian mountains is known as the *Norska*, or *Dovre Fjelle*, although the latter name belongs properly only

* *Fjelle* is the plural of *fjeld*, a mountain-side.

NORWAY.

to the part immediately in contact with the Kiöllen. This range, about 360 miles in length, attains its greatest elevation at the Sogne Fjord, where it is known as the Hurungerna. Here the highest summits are 8000 and 8400 feet above the sea, while the contiguous snow-fields of Justedal, the largest in Europe, and covering an area of 600 square miles, have probably an elevation of nearly 7000 feet. From these and other vast snow-fields, averaging more than 10 miles in width, vast glaciers descend to within 2000 feet above the sea, where they often terminate in deep lakes, some of which are very extensive. This range is famed for the beauty of its numerous fjords, fringed with lofty pines, which skirt the base of the rocky walls, whose rugged sides are washed by precipitous waterfalls, some of which, as the Keel Foss on the Sogne Fjord, are 2000 feet in height. The upper valleys of this range, although generally too high for cultivation, contain the best timber that is exported from N., and afford good pasturage in the height of the summer, when the flocks and herds are driven thither from the low lands near the entrance of the fjords. The general elevation of the Norska Fielle does not rise above the line of perpetual snow, whose average height in these latitudes is 5000 feet, but it ranges above that of the growth of trees, which may be stated to lie 1000 feet lower. The most northern part of the Norska Fielle, which is known as the Dovrefield, and includes Sneehätten, nearly 7500 feet above the sea, presents a broken surface, rent with ravines and narrow valleys, which admit of cultivation, but are difficult of access from the configuration of the land around them. Only two carriage-roads traverse the Norska Fielle, the one connecting Christiania with Bergen, and the other with Trondjem. The Scandinavian range consists principally of primitive and transition rock, and exhibits almost everywhere the effect of glacial action, the glaciers and moraines presenting the same appearances as in the Swiss alpine district. The numerous islands which skirt the coast of N., and must be regarded as portions of the range, present the same characters as the continental mass. Some of these, as the islands of Alsten and Dunnoe, rise perpendicularly from the sea with peaks penetrating beyond the snow-line, which lies here at an elevation of 4000 feet. N. abounds in lakes and streams; according to some topographers, there are upwards of 30,000 of the former, of which the majority are small, while none have an area exceeding 400 square miles. The chief rivers of N. are the Glommen, Lougen, Louven, Drammen, Otter, and Wormen. The first of these has a course of 400 miles, but the majority of the Norwegian streams, all of which rise at great elevations, have a comparatively short course, and are unfit for navigation, although they are extensively used to float down timber to the fjords, whence the wood is exported in native ships to foreign ports. These fjords, or inlets of the sea, which form so characteristic a feature of Norwegian scenery, and give with their various sinuities a coast-line of upwards of 8000 miles, form the outlet to numerous rapid streams and waterfalls, which leap or trickle down the edges of the treeless fields or mountain flats above. The greatest number of fjords occur in the northern parts of the land near Trondjem, where the narrow Sogne Fjord penetrates through the Norska Fiellen to a length of 120 miles, while near this the Porsanger Fjord runs a sinuous course of 100 miles, with the exceptionally large width of 20 miles.

Climate, Soil, &c.—The peculiar physical character of N. necessarily gives rise to great varieties of climate in different parts of the country. The influence of the sea and of the Gulf Stream, and

the penetration into the interior of deep inlets, greatly modify the severity of the climate on the western shores, and render it far superior to that of the other Scandinavian countries in the same latitude. On the coast generally, rain and fogs prevail; while in the regions near the North Cape, storms are almost incessant, and rage with extraordinary violence. In the interior, the air is clear and dry. The longest day, which in the south is 18 hours, may be said to be nearly three months in the high latitudes of the northern districts, where the longest night lasts almost an equal length of time. In Norway Proper, the winters as a rule are long and cold, and the summers, which rapidly follow the melting of the snows in April and May, are warm and pleasant. On the islands, however, the heats of summer are often insufficient to ripen corn. The protracted winter of the northern regions follows almost suddenly on the disappearance of the sun, when the absence of solar light is compensated for by the frequent appearance of the aurora borealis, which shines with sufficient intensity to allow of the prosecution of ordinary occupations.

It is estimated that $\frac{1}{4}$ th of the area of N. lies within the region of perpetual snow, while a large extent of the mountain districts yield no produce beyond scanty grasses, mosses, lichens, and a few hardy berry-yielding plants. Only birch and juniper grow north of 67°, which is the boundary of the pine. The Scotch Fir, *Pinus sylvestris* (Norwegian, *Fura*) and Spruce, *P. abies* (Norwegian, *Gran*) cover extensive tracts, and with birch, constitute the principal wealth of N.; the value of these articles of export amounting in some years to upwards of 10 million thalers. The hardier fruits, as strawberries, gooseberries, cherries, and raspberries, are abundant and excellent of their kind. Hemp, flax, rye, oats, and barley are grown as far north as 66°; but although agriculture has been more systematically pursued of late years, the crops are not always sufficient for home consumption, and hence it is found absolutely necessary annually to import considerable quantities of corn and potatoes. The frugal peasantry do not, however, rely wholly upon importation, but prepare a species of cake or bread from the bark of the pine when corn is scarce, and in plentiful years store away some of the produce of the harvest in the national corn-magazines, which are established in every part of N. by way of a provision for an unfavourable season. Agriculture is most successfully prosecuted in the ams or administrative districts of Jarlsberg and Laurvik, Akershus, Budakerud, and in the south generally; while in the northern parts, in the upper valleys, the rearing of cattle constitutes an important branch of industry. The herds and flocks are driven from the distant farms to the pasture-lands in these high mountain valleys, known as Saeterdale, where they remain till the approach of cold weather obliges the herdsmen to return with their charges to the shelter of the farms. Although the cattle and horses are small, they are generally strong and capable of bearing much hard labour.

Products, &c.—The fisheries of N. are of great importance, and not only yield one of the most important articles of home consumption, but at the same time constitute one of the most profitable sources of foreign export. Fish is caught in almost every stream and lake of the interior, as well as in the fjords of the coast, and in the bays and channels which encircle the numerous islands skirting the long sea-line of Norway. Salmon, herring, and cod are of the greatest importance, the latter alone giving employment to some 16,000 or 18,000 men, who proceed in upwards of 3000 boats to the

NORWAY.

Loffoden Islands, in whose waters they fish from February till May, and often obtain a return of 16 millions of fish, having an average value of more than a million and a quarter of dollars.* In some years the herring fishery of the south-west coast is even more remunerative; from 500,000 to 600,000 tons of fish being not unfrequently taken in the season, and hence the collective fisheries of N. may be estimated to bring an annual return of 3 or 4 million dollars.

The fauna of N. includes the bear, wolf, lynx, elk, otter, reindeer, red-deer, seal, the eider-duck, and many other kinds of sea-fowl, blackcock, capercaillie, and a great variety of small game.

The mineral products, which comprise silver, copper, cobalt, iron, chrome ironstone, &c., yield an annual return of nearly 800,000 dollars. The richest mines are situated in the south, and chiefly in the district of the Glommen, as the celebrated and ancient silver works of Kongensberg, the copper-mines of Røraas, and the numerous iron shafts on the southern declivities of the mountains between Kongensberg and the Glommen. Latterly, however, some productive copper-works have been opened in the northern districts of Kaafjord in Finmark.

Ship-building in all its branches is almost the only industrial art that is extensively and actively prosecuted. In many parts of the country there are absolutely no special trades, the inhabitants of the small fishing-ports, no less than the inmates of the widely separated farms, employing their compulsory leisure during the long winter in weaving, spinning, and making the articles of clothing and the domestic implements required in their households.

Trade, &c.—The principal seats of trade are Christiania, Drammen, Bergen, Stavanger, and Trondjem. The merchant fleet numbered, in 1860, 5300 ships, with a tonnage of upwards of 260,000 lasts, and carrying nearly 33,000 men. The exports, which consist mainly of timber, fish, minerals, furs, feathers, and down, amounted in 1860 to 10,742,217 dollars; while the imports were valued in the same year at 15,597,750 dollars, and consisted not only of the ordinary colonial goods, and objects of luxury, but in a large proportion of the most necessary articles of consumption, as corn to the annual amount of 800,000 tons, salt in nearly half that quantity, fresh and salted meat, butter, soap, hemp and flax, sailcloth, tow, oil, wine, tobacco, and manufactured goods of all descriptions. The most important commercial relations of N. now centre in Hamburg, which of late years has supplied it with colonial, English, and French wares. Holland, Russia, and Denmark stand next in order as importers to N., while the Catholic countries of the Mediterranean are the principal purchasers of the smoked and dried Norwegian fish.

Receipts, &c.—According to the budget for 1860—1863, the receipts for the three inclusive years were 14,266,050 dollars; while the expenditure was estimated at about the same sum, which would give 4,755,350 dollars annually. Prior to 1848, a very great reduction had been effected in the amount of the national debt through the rigid economy of the Storting; but the expenses incurred by the equipment of troops to aid Denmark in the Slesvig-Holstein war of 1848 have again augmented the sum, and at the close of 1859 it amounted to 7,600,000 dollars. This sum includes, however, the old unliquidated debt remaining from the time of the union of N. with Denmark, and the various loans made for the construction of railways.

Administration, &c.—N. is divided into 17 Ams, or administrative circles—viz., Smalehnenes, Agerhuus, Hedemarken, Christians, Buskerud, Jarlsberg and Laurvig, Bradsbergs, Nedenes, Lister and Mandala, Stavanger, South Bergenhuus, North Bergenhuus, Romsdal, South Trondjem, North Trondjem, Nordland, Finmarken. These circles are subdivided into 46 bailiwicks, each presided over by a rural magistrate. N. has a representative government, based on the constitution which was established in 1814, and ratified at Eidsvold. Once in three years the Storting, or legislative chamber, meets, and is composed of representatives who are elected by the freehold voters of their several districts. The number of city representatives depends upon that of the rural representatives, to whom they stand in the relation of 1 to 2. The Storting votes the taxes, which are collected by officers of the king of Sweden and N.; it proposes laws, which must be ratified by the king; but if they pass the Storting three times, they acquire validity even without the king's sanction. Although N. constitutes one joint kingdom with Sweden in regard to succession, external policy, and diplomacy, it is in all other respects an independent state, having its own government, legislative machinery, finances, army and navy. The king is indeed commander-in-chief of all the forces of the country, whether military or naval; but he can neither augment or decrease their number, nor proclaim peace or war, without the assent of the Norwegian Council of State, which must consist of natives of the country; nor, excepting in time of war, can he bring foreign soldiers within the frontiers, or send native troops out of Norway. He must visit N. once every year, and in his absence affairs are administered in the name of his representative, who may be a Swede, and who is entitled viceroy if he be of royal birth. In accordance with the constitution, no title can be conferred independently of the tenure of office, and no one can be raised to the rank of a noble, while with the death of the members of the fifteen still surviving noble families who were born before 1821, all personal honours, privileges, and distinctions belonging to nobility will cease. The constitution may therefore be regarded as purely democratic in its character. The Council of State constitutes the highest court of justice, under whose jurisdiction the provincial magistrates or 'amtmaner' administer justice, in conjunction with the bailiffs and sorenskriver or advocates, who preside over petty rural courts. These lower courts are controlled by the *Stift-Oberrette*, or Diocesan Courts of Justice, while the latter are, in their turn, under the High Court of Appeal, or *Hoieste Rett*, which is located at Christiania.

Religion, &c.—The Lutheran is the predominant, and almost the exclusive church, although freedom is allowed to all other Christian denominations. Jews are not tolerated. The church is under the administration of five bishops, whose sees are Christiania or Agerhuus, Christiansand, Trondjem, Nordland and Finmark conjoined, and Bergen. There are 341 parishes, some of which extend over enormous tracts of land, and include from 5000 to 10,000 parishioners scattered in widely-separated farmsteads. The clergy, who receive tithes, exercise considerable influence in remote country districts, where they frequently are called upon to settle disputes, and exercise various judicial functions. Much has been done of late years in N. for the diffusion of knowledge, and provision is now made to extend education to the inhabitants of the most inaccessible districts by means of itinerant teachers, a certain number of whom, corresponding to the

* The specie dollar is worth about 4s. 6d.

number of farms in each parish, are nominated to the office of schoolmaster. These men proceed from house to house, being supplied with a school-room, and fed and entertained by each householder in succession for the number of days at which the farm is mulcted. In 1853, there were 419 fixed schools in 263 parishes; and by the aid of these, and the system of itinerant teaching, education is so universally diffused that it is rare to meet with Norwegians who cannot read and write. The university of Christiania (q. v.), which was founded in 1811, is well attended, and numbers amongst its students the sons of many of the peasant land-owners, who receive a university education without intending to follow the learned professions.

Army, &c.—The army of N. is composed of regular troops and militia, the former numbered for 1860—1863, 19,511 men, and the latter 15,604, making a total of 35,115. There is, besides, a special arm, known as the Skielbern, or Skaters, which consist of a company of light infantry, carrying muskets, and ice-poles eight feet long. The fleet numbers 146 vessels, including 15 steamers, and 125 gun-boats; and there are 46,000 seamen on the rolls. Horten, in Christianiafjord, is the principal naval port. The only fortified spots are Frederickssteen at Fredericksfald, Frederickstad, Akershuus, Bergenhuus, Munholm, and Wardoehuus, near the Russian frontier.

The population of N. is chiefly rural, only about 11 per cent living in towns. Christiania, the principal city, has not more than 40,000 inhabitants, while Bergen and Trondjem have respectively only 26,000 and 16,000. The physical character, and consequent climatic relations of N., leave a very small proportion (according to some writers, only about 2 per cent.) of the area capable of being cultivated; for it may be stated generally, that the valleys are the only habitable and agriculturally productive parts of the country, the mountain-ridges which separate the low-lying lands being covered with bare masses of gneiss and mica schists, in the fissures of which the only vegetation is juniper, fir, aspen, birch, and stunted beech trees. There are few villages, and the isolated farmsteads are often separated from one another by many miles. The cultivators of the land are in most instances also the proprietors, less than one-third of the whole number being tenants only. Allodial land, known as *Udal* or *Odel*, does not descend to the eldest son unconditionally, since all his relatives have a claim upon it, and if it should be sold, have the right of buying it back within the term of five years at the sale-price. The holders of allodial lands have in recent times adopted surnames, which are generally taken from their hereditary property, but the small proprietors, who cultivate their own land, and are known as *Bonder*, or peasants, still, for the most part, retain the old Scandinavian custom of merely affixing *son* and *datter* to the father's name; thus, for instance, the children of a man known as Hans Jorgenson, and who had been christened Jorgen and Kirsten, would become Jorgen Hanson and Kirsten Hansdatter, while the children of Hanson would in their turn assume his Christian name as their patronymic.

Race—Language, &c.—With the exception of some 20,000 Lapps and Finns, living in the most remote northern regions, the inhabitants of N. are generally a pure Scandinavian race, akin to the North Germanic nations of Aryan descent. The genuine Norwegians are of middle height, with strong, well-knit, muscular frames, of fair skin, with light flaxen or yellow hair, and blue eyes. In character, they may be said to be frank, yet cautious and reserved, honest, moderate, religious, and super-

stitious, more from an inveterate love of clinging to the forms, thoughts, and creed of their ancestors, than from fanaticism. Their love of country, and the irrepressible fondness for the sea, by the very anomaly which these apparently contradictory propensities exhibit, shew them to be the true descendants of the sea-roving Northmen of old. Of late years, emigration has continued steadily to increase at a rate which threatens to be a serious evil to so badly populated a country as N., but which is easily explained by the small portion of land capable of cultivation. The general diffusion of education, and the perfect equality and practical independence which they have known how to secure and retain for themselves, notwithstanding their nominal incorporation with the other Scandinavian kingdoms, give to the poorest Norwegians a sense of self-respect and self-reliance which distinguish them favourably from those of the same class in other countries. Want of cleanliness, too ready a use of oaths, and a liking for strong drinks, are the failings to which the people are said to be most inclined; it should be observed, however, that great diversities of character and habits are observable in different districts. The peasants, more especially in the ams remote from towns, retain their ancient provincial costumes, which are, for the most part, highly picturesque, consisting, among the women, of ample woollen skirts and brightly-coloured knit bodices, fastened and adorned with silver or brass clasps and buckles. Music is much cultivated by all classes of the people, and the national songs and melodies which are the favourites, are for the most part of a melancholy character.

Danish is the language in ordinary use both in writing and speaking, although dialects nearer akin to the old Norse are spoken by the dalesmen and mountaineers of special districts. Since the separation of the country from Denmark, a strongly national tendency has been manifested by some of the best Norwegian writers, and attempts have been made to reorganise these dialects into one general Norwegian language, and thus, in fact, to revive the ancient Norse, or Icelandic, which has been preserved in Iceland in almost perfect purity since its first introduction to the island in the 9th c. by colonists from the Scandinavian mother-lands. Among the most zealous cultivators of the ancient and modern literature and history of N., we may instance Professor P. A. Munch, whose able expositions of the laws and social conditions of his country have thrown new light on its history; Keyser, Unger, and Hohnboe, who have done much to elucidate the Norse tongue and literature; A. Munch and Monsen, successful cultivators of the national lyric; and J. Moe and Asbjørnsen, the critical collectors and annotators of native sagas. In the more abstruse departments of mathematical and physical science, Norwegians have gained for themselves a foremost place, as is sufficiently testified by the mention of names such as N. H. Abel, renowned for his discoveries in definite integrals; C. Hansteen, the astronomer; and Keilhau, the geologist.

History.—The early history of N. is comprised in that of the other Scandinavian countries, and is, like theirs, for the most part fabulous. It is only towards the close of the 10th c., when Christianity was introduced under the rule of Olaf I., that the mythical obscurity in which the annals of the kingdom had been previously plunged begins to give place to the light of historical truth.

The introduction of Christianity, which was the result of the intercourse which the Norwegians had with the more civilised parts of Europe through their maritime expeditions, destroyed much of the old nationality of the people with the heathenism

which they had hitherto cherished, although the sanguinary feuds which had raged among the rival chiefs of the land can scarcely be said to have lost their ferocity under the sway of a milder religion. Olaf II., or the Saint (1015—1030), who zealously prosecuted the conversion of his countrymen, raised himself to supreme power in the land by the subjection of the small kings or chieftains, who in the times of heathenism had subdivided the kingdom among them. The war between Olaf and King Knut the Great of Denmark, which terminated in 1030 with the battle of Sticklestad, in which the former was slain, brought N. under the sway of the Danish conqueror; but at his death in 1036, Olaf's son, Magnus I., recovered possession of the throne, and thenceforth, till 1319, N. continued to be governed by native kings. The death in that year of Hakon VII. without male-heirs, threw the election of a new king into the hands of the national assembly, who, after many discussions, made choice of Magnus VIII. of Sweden, the son of Hakon's daughter. He was in turn succeeded by his son Hakon, and his grandson Olaf IV., who having been elected king of Denmark in 1376, became ruler of the sister Scandinavian kingdoms on the death of his father in 1380. This young king, who exercised only a nominal sway under the guidance of his mother Queen Margaret, the only child of Valdemar III. of Denmark, died without heirs in 1387. Margaret's love of power and capacity for government brought about her election to the triple throne of the Scandinavian lands, and from this period till 1814, N. continued united with Denmark; but while it shared in the general fortunes of the latter state, it retained its own constitutional mode of government, and exercised its right of electing to the throne, until, like the sister-kingdom, it agreed of its own free will to relinquish this privilege in favour of hereditary succession to the throne. See DENMARK, HISTORY OF. The Napoleonic crisis may be said to have severed this union, which had existed for more than 400 years, for Denmark, after having given unequivocal proofs of adhesion to the cause of Bonaparte, was compelled, after the disastrous war of 1813, to purchase peace at the cost of this long united partner of her state. Crippled in her resources, and almost a bankrupt, she saw herself constrained to sign the treaty of Kiel in 1814, by which it was stipulated by the allied powers that she should resign N. to Sweden, receiving in return, by way of indemnity, some portion of Swedish Pomerania and the island of Rügen, which were subsequently exchanged with Prussia for Lauenburg on the payment by that state of two million rix-dollars. The Norwegians, having refused to admit the validity of the treaty of Kiel, nominated Prince Christian, the heir-presumptive to the throne of Denmark, regent and subsequently king of Norway. This nomination was made by the national diet, or Storting, which met at Eidsvold, where they drew up a constitution based on the French constitution of 1791. These measures found, however, neither supporters nor sympathisers among the other nations; and with the sanction of the great allied powers, Charles John Bernadotte, Crown-Prince of Sweden, led an army into N., and after taking Frederickstad and Fredericks-hald, threatened Christiania. Denmark being unable to support the cause of Prince Christian, and N. being utterly destitute of the means necessary for prosecuting a war, resistance was of no avail, and the Norwegians in this untoward conjuncture of affairs, were glad to accept the proposals made to them by the Swedish king for a union with Sweden, on the understanding that they should retain the newly promulgated constitution, and enjoy full

liberty and independence within their own boundaries. These conditions were agreed to, and strictly maintained; a few unimportant alterations in the constitution, necessitated by the altered conditions of the new union, being the only changes introduced in the machinery of government. Charles XIII. was declared joint king of Sweden and N. in 1818, and while the latter has become an almost independent state, it is questionable whether the former has found in its nominal acquisition an equivalent for the loss of Finland, which was the price exacted for it by the allied powers, and made over to Russia. Since the union, N. has firmly resisted every attempt on the part of the Swedish monarchs to infringe upon the constitutional prerogatives of the nation; and during the reign of the first of the Bernadotte dynasty, the relations between him and his Norwegian subjects were marked by jealousy and distrust on both sides, but since the accession of his son, Oscar I., in 1844, perfect harmony and good-will have existed, and N. has continued to make rapid progress towards a state of political security and material prosperity far greater than it ever enjoyed under the Danish dominion.—See T. Thorlak, *Historia rerum Norvegicarum* (Copenh. 1711); Schöning, *Norges Riges Historie* (Soroe, 1771); Munch, *Det Norske Folks Historie*, Bd. 1—6 (Christ. 1852—1859).

NORWAY HADDOCK. See BERGTYL.

NORWICH, a city of England, capital of the county of Norfolk, and a county in itself, on the Wensum, immediately above its confluence with the Yare, 20 miles west of Yarmouth, and 98 miles north-north-east of London. It covers an area about five miles in circumference, is skirted on its north and east sides by the river, and on the west and south it was formerly surrounded by walls, of which there are still remains. In the town and immediate vicinity there are as many as ten bridges. The market-place (600 feet long by 340 feet wide) and its vicinity contain many large shops and good houses. The castle, finely situated on an elevation near the centre of the town, originally covered, with its works, an area of about 23 acres. The bridge (150 feet long) over the ditch has one of the largest and most perfect Anglo-Norman arches remaining. The massive quadrangular Norman keep is now used as a prison. The cathedral, almost wholly Norman in plan, was founded in 1094 by Bishop Herbert Losinga. It is 411 feet long, 191 feet broad at the transepts, and is surmounted by a spire 315 feet high. Near the cathedral are a number of ancient and interesting structures now more or less in ruins, among which may be mentioned St Ethelbert's and the Erpingham Gate, the former in Decorated English, the latter in late Perpendicular, and both valuable and rich specimens of their styles. Besides a large number of dissenting chapels and other places of worship, there are about 40 churches, of which St Peter's, Mancroft, a handsome cruciform edifice of the 15th c., with a remarkably fine peal of 12 bells; St Andrew's, St Clement's, St George's, St Giles, St Michael's, and others, are worthy of mention. The Free Grammar School, with an endowment of about £200 a year, was founded by Edward VI., and the other educational establishments are numerous and various in character. The public library contains 20,000 volumes, and the library of the Norwich Literary Institution, 15,000 volumes. N. is the seat of extensive and flourishing manufactures, the chief of which are bandanas, bombazines, shawls, crapes, gauzes, damasks, camlets, and muslins; shoemaking is extensively carried on; yarn and silk mills are in operation, and employ many hands. Iron-founding,

tanning, dyeing, malting, &c., and agricultural implement-making, are also carried on. The trade, which is facilitated by a canal and river system of communication with the sea, is chiefly in agricultural produce and coal. N. is the see of a bishop, and returns two members to parliament. Pop. of municipal and parliamentary borough in 1861, 74,891.

About three miles south of N. is Castor St Edmunds, which, prior to the Roman era, was called Caister, and under the Romans received the name of *Venta Icenorum*. N., which occupies a place in history from the time of the earlier Danish invasions, had its origin in the castle erected as a stronghold by the East Anglian kings, and resorted to as a place of safety by the inhabitants of *Venta Icenorum*, who gave it the name of North-wic, or northern station or town, on account of its relative position with respect to their own town. The bishopric of the East Angles was removed hither in 1094. About 4000 Flemings settled at N. in the reign of Elizabeth, and greatly increased the prosperity of the town by the branches of manufacture which they introduced.

NORWICH, a city of Connecticut, U. S., at the head of navigation of the Thames River, 13 miles north of New London, and 38 south-east of Hartford. The town consists of three large villages, one composed of beautiful and finely-situated residences; the others of nearly 90 manufactories of cotton, wool, paper, &c., which are supplied with water-power by falls of 50 feet on the Yantic River. N. contains county buildings, 8 banks, 1 daily and 2 weekly papers, 17 churches, 39 public and 5 private schools, a free academy, settled in 1659, when 9 square miles were bought of Uncas, an Indian chief, whose grave is in the village, for £70. Pop. in 1860, 14,047.

NORWICH or **MAMMALIFEROUS CRAG**, a series of highly fossiliferous beds of sand, loam, and gravel, of Pleistocene age, occurring at several places within a few miles of Norwich, where they are popularly named 'Crag.' They contain a mixture of marine and fresh-water mollusca, with ichthyolites and bones of mammalia. They are evidently estuary beds, the most common shells being the very species now abundant in such situations around the coasts of Britain; but with them are associated a few extinct species. The beds rest on the white chalk, the surface of which is frequently perforated by *Pholas crispata*, the shell still remaining at the bottom of the cavity. The mammalian bones belong to species of elephant, horse, pig, deer, and field-mouse. With them are occasionally found the bones of *Mastodon angustidens* and some mollusca, which belong to the Red Crag. Their occurrence here is believed to have arisen from their having been washed out of the Red into this, the Norwich Crag.

NORWOOD, **UPPER** and **LOWER**, are two villages in Surrey, England, with a station on the London and Croydon Railway, 6 miles south of London. The public pleasure-ground, called the Beulah Spa, is prettily laid out around a mineral spring. The villages are worthy of mention, however, chiefly on account of their schools, among which are a district school for the pauper children of Lambeth parish, and a very large and important educational establishment for the pauper children of London. The district parish of N. had, in 1861, a population of 7462.

NOSE, AND THE SENSE OF SMELL. The nose is not only the organ of smell, but is likewise a part of the apparatus of respiration and voice. Considered anatomically, it may be divided into an

external part—the projecting portion, to which the term *nose* is popularly restricted; and an internal part, consisting of two chief cavities, or *nasal fossæ*, separated from one another by a vertical septum, and subdivided by spongy or turbinated bones projecting from the outer wall into three passages or *meatuses*, with which various cells or *sinuses* in the ethmoid, sphenoid, frontal, and superior maxillary bones communicate by narrow apertures.

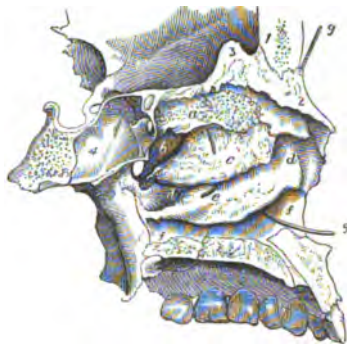

Fig. 1.—A Longitudinal Section of the Nasal Fossæ of the Left Side, the Central Septum being removed:

1, the frontal bone; 2, the nasal bone; 3, part of the ethmoid bone; 4, the sphenoidal sinus. a, the superior turbinate bone; b, the superior meatus; c, the middle turbinate bone; d, the middle meatus; e, the inferior turbinate bone; f, the inferior meatus; g, a probe passed into the nasal duct.

The external portion of this organ may be described as a triangular pyramid which projects from the centre of the face, immediately above the upper lip. Its summit or root is connected with the forehead by means of a narrow bridge, formed on either side by the nasal bone and the nasal process of the superior maxillary bone. Its lower part presents two horizontal elliptical openings, the *nostrils*, which overhang the mouth, and are separated from one another by a vertical septum. The margins of the nostrils are usually provided with a number of stiff hairs (*vibrissæ*), which project across the openings, and serve to arrest the passage of foreign substances, such as dust, small insects, &c., which might otherwise be drawn up with the current of air intended for respiration. The skeleton, or framework of the nose, is partly composed of the bones forming the top and sides of the bridge and partly of cartilages, there being on either side an upper lateral and a lower lateral cartilage, to the latter of which are attached three or four small cartilaginous plates, termed *sesamoid cartilages*; there is also the cartilage of the septum which separates the nostrils, and in association posteriorly with the perpendicular plate of the ethmoid, and with the vomer, forms a complete partition between the right and left nasal fossæ. It is the lower lateral, termed by some writers the *alar cartilage*, which by its flexibility and curved shape forms the dilatible chamber just within the nostril. The nasal cartilages are capable of being slightly moved, and the nostrils of being dilated or contracted by various small muscles, which it is unnecessary to describe. The integument of the nose is studded with the openings of sebaceous follicles, which are extremely large and abundant in this region. The oleaginous secretion of these follicles often becomes of a dark colour near the surface; and hence the spotted appearance which the tip and lower parts of the sides, or *ala*, of the nose frequently present. On firmly compressing or pinching the skin of these parts, the inspissated

NOSE, AND THE SENSE OF SMELL.

secretion is forced out of the follicles in the form of minute white worms with black heads.

The *nasal fossae*, which constitute the internal part of the nose, are lofty, and of considerable depth. They open in front by the nostrils, and behind they terminate by a vertical slit on either side in the upper part of the pharynx, above the soft palate, and near the orifices of the eustachian tubes, which proceed to the tympanic cavity of the ear.

The mucous membrane lining the nose and its cavities is called *pituitary* (Lat. *pituita*, slime, rheum), from the nature of its secretion; or *Schneiderian*, from Schneider, the first anatomist who shewed that the secretion proceeded from the mucous membrane, and not, as was previously imagined, from the brain; it is continuous with the skin of the face at the nostrils, with the mucous covering of the eye through the lachrymal duct (see *EYE*), and with that of the pharynx and middle ear posteriorly. This membrane varies in its structure in different parts of the organ. On the septum and spongy bones bounding the direct passage from the nostrils to the throat, the lining membrane is comparatively thick, partly in consequence of a multitude of glands being disseminated beneath it, and opening upon it, but chiefly, perhaps, from the presence of ample and capacious submucous plexuses of both arteries and veins, of which the latter are by far the more large and tortuous. These plexuses, lying as they do in a region exposed more than any other to external cooling influences, appear to be designed to promote the warmth of the part, and to elevate the temperature of the air on its passage to the lungs. They also serve to explain the tendency to hemorrhage from the nose in cases of general or local plethora. In the vicinity of the nostrils, the mucous membrane exhibits papillæ and a scaly epithelium, like the corresponding parts of the skin. In the sinuses, and in all the lower region of the nose, the epithelium is of extreme delicacy, being of the columnar variety, and clothed with cilia. In the upper third of the nose—which, as the proper seat of the sense of smell, may be termed the *olfactory region*—the epithelium ceases to be ciliated, assumes a more or less rich sienna-brown tint, and increases remarkably in thickness, so that it forms an opaque soft pulp upon the surface. It is composed of an aggregation of nucleated particles, of nearly uniform appearance throughout, except that the lowest ones are of a darker colour than the rest, from their containing a brown pigment in their interior. Dr Todd and Mr Bowman remark, in their *Physiological Anatomy*, from which we have condensed the above account of the nasal mucous membrane, that the olfactory region abounds in glands, apparently identical with sweat glands, which dip down in the recesses of the submucous tissue among the ramifications of the olfactory nerve.

The nerves of the nose are the first pair or olfactory which are specially connected with the sense of smell, branches of the fifth pair which confer ordinary sensibility on its skin and mucous membrane, and motor filaments, from the facial nerve to the nasal muscles. The olfactory nerve on each side is connected with the inferior surface of the Brain (q. v.) by an external, a middle, and an internal root, which unite and form a flat band (or, more correctly, a prism), which, on reaching the cribriform plate of the ethmoid bone, expands into an oblong mass of grayish-white substance, the *olfactory bulb*. From the lower surface of this bulb are given off the *olfactory filaments*, fifteen or twenty in number, which pass through the cribriform foramina, and are distributed to the mucous membrane of the olfactory

region. These filaments differ essentially from the ordinary cerebral nerves. They contain no white substance of Schwann, are not divisible into

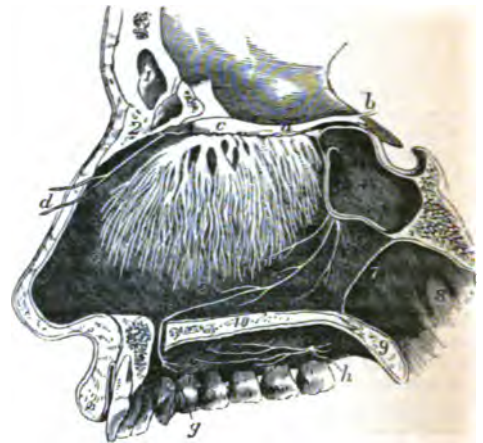

Fig. 2.—The Distribution of the Olfactory Nerve on the Septum of the Nose :

1, the frontal sinus; 2, the nasal bone; 4, the sphenoidal sinus of left side; 7, the posterior opening of the left nostril; 8, the opening of the Eustachian tube; 9, a section of the soft palate; 10, a section of the hard palate. a, the olfactory nerve; b, its three roots; c, its bulb, from which filaments proceed downwards through the cribriform plate of the ethmoid; d, the nasal branch from the ophthalmic division of the fifth nerve; e, the naso-palatine nerve from the sphenopalatine ganglion; g, A, its branches; t, the septum of the nose.

elementary fibrils, and resemble the gelatinous fibres in being nucleated, and of a finely granular texture. The branches of the fifth pair (or trifacial) given to the nose are the nasal nerve (derived from the ophthalmic division), which supplies the skin and mucous membrane in the vicinity of the nostrils, and the naso-palatine nerve (derived from Meckel's ganglion, which is connected with the superior maxillary division), which supplies the mucous membrane on the spongy bones and on the septum. The peculiar sensation that precedes sneezing is an affection of the nasal nerve, and the flow of tears that accompanies a severe fit of sneezing is explained by the common source of this and the lachrymal nerve; while the common sensibility of the nose, generally, is due to the branches of this and of the naso-palatine nerve.

The nature of odorous emanations is so little known, that it is impossible to give a definite account of the mode in which they produce sensory impressions. From the fact that most odorous substances are volatile, and *vice versa*, it may be presumed that they consist of particles of extreme minuteness dissolved in the air; yet the most delicate experiments have failed to discover any loss of weight in musk, and other strongly odorous substances, after they have been freely evolving their effluvia for several years. But whatever may be the nature of the odorous matter, it is necessary that it should be transmitted by a respiratory current through the nostrils to the true olfactory region, whose membrane must be in a healthy condition. If it is too dry, or if there is an inordinate excretion of fluid from its surface (both of which conditions occur in catarrh or cold in the head), smell is impaired or lost, in consequence of the necessary penetration of the stimulating odour to the nervous filaments being prevented.

The acuteness of the sense of smell is far greater

in many of the lower animals (dogs, for example) than in man, and they employ it in guiding them to their food, in warning them of approaching danger, and for other purposes. To civilised man its utility is comparatively small; but it is occasionally much increased when other senses are deficient. In the well-known case of James Mitchell, who was deaf and blind from his birth, it was the principal means of distinguishing persons, and enabled him at once to perceive the approach of a stranger. Amongst many savage tribes the sense is almost as acute as in many of the lower mammals. For example, the Peruvian Indians are able, according to Humboldt, to distinguish, in the middle of the night, whether an approaching stranger is a European, American Indian, or Negro.

Although all poisonous gases are not odorous, and all bad odours may not be positively deleterious to health, there can be no doubt that one of the principal objects for which the sense of smell is given to us is to enable us to detect atmospheric impurities, many of which are of a most noxious character, and give rise to the most serious forms of fever.

NOSE-RING. See RING.

NOSING, the projecting edge of a moulding, such as the bead or bottle used on the edge of steps, to which the term is most frequently applied.

NOSOLOGY (Gr. *nóōs*, disease) is that branch of the science of medicine which treats of the distribution and arrangement of diseases into classes, orders, &c. Many systems of nosology have at different times been adopted; some of which have been based upon the nature of the ascertained causes of diseases; others on the pathological states or conditions which attend diseases; others on the differences between structural and functional diseases, &c. It is hard to say which is the most perfect method; but that of Dr Farr, one of the most distinguished living medical statisticians, is adopted by the Registrar-General in the Reports on the mortality of London and England, and is becoming more generally adopted than any other. It has the advantage over the antiquated but once popular system of Cullen (1792) of meeting the requirements of modern science, and (by illustrating great questions connected with public health) of shewing those causes that are injurious or fatal to life, and of thus contributing to the removal of those evils (bad drainage, imperfect ventilation, &c.) which tend to shorten human existence.

We append Dr Farr's system of nosology, which is arranged in four primary classes, each of which includes various orders:

CLASS I. ZYMOTIC DISEASES (Gr. *zýmē*, a ferment).—Diseases that are either epidemic, endemic, or contagious, and that are induced by some specific body, or by want of food or by its bad quality. In this class there are four orders—viz., Order I. *Miasmatic Diseases* (Gr. *miasma*, a stain), such as small-pox, measles, scarlet-fever, diphtheria, typhus and typhoid fevers, cholera, ague, &c. Order II. *Enthetic Diseases* (Gr. *enthēōs*, put in or implanted), such as syphilis, gonorrhœa, glanders, hydrophobia, malignant pustule, &c. Order III. *Dietic Diseases* (Gr. *diēta*, way of life or diet), such as famine, fever, scurvy, purpura, rickets, bronchocele, delirium tremens, &c. Order IV. *Parasitic Diseases*, such as scabies (or itch), and worm disorders from animal parasites, and ring-worm, scald-head, &c., from vegetable parasites or fungi.

CLASS II. CONSTITUTIONAL DISEASES.—Diseases affecting several organs, in which new morbid products are often deposited; sometimes hereditary.

This class contains two orders. Order I. *Diathetic Diseases* (Gr. *diathēsis*, condition or constitution), including gout, anæmia, cancer, melanosis, lupus, &c. Order II. *Tubercular Diseases*, such as scrofula, phthisis, mesenteric disease, tubercular meningitis, &c.

CLASS III. LOCAL DISEASES.—Diseases in which the functions of particular organs or systems are disturbed or obliterated with or without inflammation; sometimes hereditary. This class includes eight orders. Order I. *Brain Diseases* (or more correctly, *Diseases of the Nervous System*), such as apoplexy, paralysis, epilepsy, chorea, hysteria, mania, &c. Order II. *Heart Diseases* (or more correctly, *Diseases of the Circulatory System*), such as pericarditis, endocarditis, aneurism, angina pectoris, atheroma, phlebitis, varicose veins, &c. Order III. *Lung Diseases* (or more correctly, *Diseases of the Respiratory System*), such as bronchitis, pneumonia, pleurisy, asthma, empyema, laryngitis, &c. Order IV. *Bowel Diseases* (or more correctly, *Diseases of the Digestive System*), such as stomatitis, gastritis, enteritis, peritonitis, jaundice, &c. Order V. *Kidney Diseases*, such as Bright's disease, nephritis, ischuria, diabetes, stone, gravel, &c. Order VI. *Genetic Diseases* (or *Diseases of the Generative System*), such as hydrocele, ovarian dropsy, &c. Order VII. *Bone and Muscle Diseases*, such as caries, necrosis, exostosis, synovitis, muscular atrophy, &c. Order VIII. *Skin Diseases*, such as urticaria, eczema, herpes, impetigo, acne, lichen, prurigo, &c.

CLASS IV. DEVELOPMENTAL DISEASES.—Special diseases, the incidental result of the formative, reproductive, and nutritive processes. It contains four orders. Order I. *Developmental Diseases of Children*, such as malformations, idiocy, teething, &c. Order II. *Developmental Diseases of Women*, such as amenorrhœa, childbirth, change of life, &c. Order III. *Developmental Diseases of Old People*, such as old age, and its concomitant affections. Order IV. *Diseases of Nutrition*, such as atrophy, debility, &c.

NO'STOC, a genus of plants of the natural order *Alga*, suborder *Confervaceae*, found upon moist ground, rocks near streams, &c., and consisting of a somewhat gelatinous hollow tumid frond, filled with simple filaments resembling strings of beads. *N. commune* is frequent in Britain, springing up suddenly on gravel-walks and pasture-grounds after rain. It is a trembling gelatinous mass, often called **STAR JELLY**, and vulgarly regarded, owing to the suddenness with which it makes its appearance, as having fallen from the skies, and as possessed of important medicinal virtues. *N. edule* is employed in China as an article of food.

NOSTRADAMUS, a celebrated astrologer of the 16th c., born 14th December 1503, at St Remi, in Provence. His proper name was Michel Notre-Dame, and he was of Jewish descent. He studied first at the Collège d'Avignon, where he exhibited remarkable scientific powers, and subsequently attended the celebrated school of medicine at Montpellier. Here he first acquired distinction during an epidemic that desolated the south of France, by his humane attentions to those stricken by the pestilence. After taking his degree, he acted for some time as professor, but was induced by his friend J. C. Scaliger to settle in Agen as a medical practitioner. After travelling for some time, he finally settled at Salon, a little town situated in the environs of Aix, about 1544. Already he must have been reckoned a man of note, for in the following year, when an epidemic was raging at Lyon, he was solemnly invited thither by the civic authorities, and is said to have rendered immense services. He first fell upon his prophetic vein about the year

1547, but in what light he himself regarded his pretensions, it is now impossible to say. At any rate, he commenced to write his famous predictions (*Prophéties*) which first appeared at Lyon in 1555. These predictions were in rhymed quatrains, divided into centuries, of which there were seven; the 2d ed., published in 1558, contained ten. Astrology was then the fashion, and these quatrains, expressed generally in obscure and enigmatical terms, had a great success. Some, indeed, regarded the author as a quack, but the great majority as a genuine seer or predictor of the future. He was, consequently, much sought after by all sorts of people, high and low. Catherine de Médicis invited him to visit her at Blois, to draw the horoscope of her sons, and on his departure loaded him with presents. The Duke and Duchess of Savoy went to Salon expressly to see him; and when Charles IX. became king, he appointed N. his physician-in-ordinary (1564). He died at Salon, 2d July 1566. N.'s predictions have been the subject of an immense amount of illustrative and controversial literature. He also wrote an Almanac, which served as the model of all subsequent ones, containing predictions about the weather.—See Jaubert's *Vie de M. Nostradamus, Apologie et Histoire* (Amst. 1656); Astruc's *Memoirs pour Servir à l'Histoire de la Faculté de Montpellier* (Paris, 1767); *Apologie pour les Grands Hommes Soupçonnés de Magie* (Paris, 1825); and E. Barest's *Nostradamus* (Paris, 1842).

NOSTRILS, DISEASES OF THE. Acute inflammation of the nasal mucous membrane is a very common and well-known affection, which has been already described under the title of CATARRH (q. v.), or Cold in the Head; while the chronic form of inflammation is described in the article OZENA. Hemorrhage from the nostrils, or *Epistaxis* (Gr. a dropping), is by far the commonest form of bleeding from a mucous membrane. It may be produced (1) by direct injury, as by a blow on the nose, or a scratch in the interior of the nostrils; or (2) it may be an *active* hemorrhage, in which case it is often preceded by a feeling of tension and heat in the nostrils, pain in the forehead, giddiness, buzzing in the ears, and flushing of the face (these symptoms are, however, seldom all present in the same case, and not unfrequently the flow of blood is preceded by no apparent disorder); or (3) it may be of a *passive* character, and may be due either to a morbid condition of the blood, as in malignant scarlatina, typhoid and typhus fevers, scurvy, purpura, &c., or to obstruction of the circulation by disease of the liver and heart.

If the hemorrhage occur in a flushed plethoric subject, and is obviously of an active character, it may be regarded as a salutary effort of nature, and may be left alone till it ceases spontaneously; but if it continues so long as materially to weaken the patient, or if it be of the passive character, or if it arise from injury, then means should be taken to stop it with as little delay as possible. The patient should be placed in the sitting posture at an open window, with the head erect or slightly inclined backwards; and amongst the simpler means to be first tried, are compression of the nostrils by the fingers, the application of a key or other piece of cold metal to the back of the neck, and the occasional immersion of the face or whole head in cold water, especially if accompanied by a drawing-up of the water into the nostrils; or Dr Negrier's plan of causing the patient, in a standing position, suddenly to raise his arms straight upwards, and to retain them for a short time in this position—a remedy which he states to have always succeeded, even in very bad cases, when other means had failed. Should these means fail, recourse must be had to astringent

injections (for example, twenty grains of alum dissolved in an ounce of water) thrown up the nostrils by a syringe, or to astringent powders (as finely-powdered galls, kino, maticao, alum, &c.) blown up the nostrils by means of a quill or other tube, or snuffed up by the patient. As a final resource, direct compression must be applied. Abernethy never failed in stopping the bleeding by winding a piece of moistened lint around a probe, so as to form a cylindrical plug, passing this along the floor of the nose for its entire length, then carefully withdrawing the probe, and allowing the lint to remain for three or four days. Cases occasionally occur in which it is necessary also to plug the posterior orifices of the nostrils by an operation, into the details of which it is not necessary to enter.

Polypus, which is an old term employed to signify any sort of pedunculated tumour firmly adhering (literally, 'by many feet') to a mucous surface, is of common occurrence in the nostrils; its most usual seat of attachment being one of the turbinated bones. The ordinary kind is of the consistence of jelly, yellowish, streaked with blood-vessels, and of a pear-shaped form. The patient has a constant feeling of fullness in the nostril (as if he had a cold in the head); he cannot effectually blow his nose; and his voice is sometimes rendered more or less thick and indistinct. If he force his breath strongly through the affected nostril, and at the same time compress the other, and close the mouth, the polypus may generally be brought in view. The best treatment is to seize the neck or pedicle with the forceps, and twist it off. The consequent hemorrhage may be readily checked by the means already described.

Foreign bodies are often inserted into the nostrils by children, and become impacted. They may usually be extracted by a small scoop or a bent probe. If they cannot be removed by these means, they must be pushed back into the throat through the posterior nares.

Children are occasionally born with imperforated nostrils. This congenital malformation may, however, usually be remedied by surgical assistance.

NOT GUILTY is the form of verdict in a criminal prosecution, and also in some civil actions, when the jury find in favour of the defendant or accused party. The verdict is conclusive, and the accused cannot, in criminal cases, be tried a second time.

NOT PROVEN is a form of verdict used in Scotland in criminal prosecutions when the jury think there is some foundation for the charge, but the evidence is not strong enough against the prisoner to warrant a verdict of guilty. In such a case, a verdict of 'Not Proven' is substantially a verdict of acquittal. The prisoner cannot be tried afterwards, even though new and conclusive evidence come to light after the verdict.

NOTABLES, the name formerly given in France to persons of distinction and political importance. As the States General were inconvenient to the despotism of the monarchy, the kings of the House of Valois adopted the expedient of calling in their stead *Assemblies of the Notables*, the time of calling them and the composition of them being entirely dependent on the pleasure of the crown, by which also their whole proceedings were guided, so that they generally consented at once to whatever was proposed to them. They shewed a particular readiness in granting subsidies, to which they themselves, as belonging to the privileged classes, were not to contribute. An Assembly of Notables, convened in Paris by Richelieu in 1626, and presided over by Gaston, brother of Louis XIII., consisted of only

35 members. For more than a century and a half even this poor acknowledgment of any other mind or will in the nation than that of the sovereign ceased to be made; but when the state of the finances brought the monarchy into difficulties and perils, Louis XVI., at the instigation of the minister Calonne, had recourse again to an Assembly of Notables, which met 22d February 1787, and was dissolved 25th May. It consisted of 137 members, among whom were 7 princes of the blood, 9 dukes and peers, 8 marshals, 11 archbishops, 22 nobles, 8 councillors of state, 4 masters of requests, 37 judges, 12 deputies of the Pays d'Etats, the civil lieutenant, and 25 persons belonging to the magistracy of different cities of the kingdom. Calonne's representations of the state of the finances induced the Notables to adopt many reforms in the matter of taxation; but no sooner was the assembly dissolved, than many of them joined the parliaments in opposition to resolutions adverse to their private interests, so that the king was compelled to determine upon assembling the States General. Necker, who had meanwhile been placed at the head of affairs, assembled the Notables again, 6th November 1788, to consult them concerning the form in which the States General should be convened, and particularly concerning the number of members of the third estate and the manner of voting. The Notables declared against every innovation, and so compelled the court to half measures, which helped to prepare the way for the Revolution.

NOTARY-PUBLIC is an officer of the law, whose chief function is to act as a witness of any solemn or formal act, and to give a certificate of the same; which certificate, if duly authenticated, is accepted all the world over as good evidence of the act done in his presence, and attested by him. The services of a N. are chiefly available where his evidence is to be used in a foreign country. Solicitors are sometimes notaries-public, but in England there are fewer notaries, comparatively, than in Scotland, where notarial acts and certificates are more largely used.

NOTATION, the method of representing numbers and quantities by marks or signs. The representation of numbers is known as 'arithmetical,' and that of quantities as 'symbolical' notation.

I. ARITHMETICAL NOTATION.—The invention of arithmetical notation must have been coeval with the earliest use of writing, whether hieroglyphic or otherwise, and must have come into use about the time when it was felt that a mound, pile of stones, or huge misshapen pillar, was insufficient as a record of great events, and required to be supplemented by some means which would suffice to hand down to posterity the requisite information. The most natural method undoubtedly was to signify 'unity' by one stroke, thus : |; 'two' by two strokes, ||; 'three' by three strokes, |||, &c.; and, as far as we know, this was the method adopted by most of those nations who invented systems of notation for themselves. It is shewn on the earliest Latin and Greek records, and is the basis of the Roman, Chinese, and other systems. We have thus a convenient division of the different notational systems into the *natural* and *artificial* groups, the latter including the systems of those nations who adopted distinct and separate symbols for at least each of the nine digits. The Roman and Chinese systems are the most important of the former, and the Hebrew, later Greek, and 'decimal' systems of the latter group.

Roman System.—The system adopted by the Romans was most probably borrowed at first from the Greeks, and was distinguished equally by its simplicity and its cumbrousness. The following

seems to be the most probable theory of its development. A simple series of strokes was the basis of the system; but the labour of writing and reading large numbers in this way would soon suggest methods of abbreviation. The first and most natural step was the division of the strokes into parcels of tens, thus, [|||||] [|||||], a plan which produced great facility in the reading of numbers. The next step was to discard these parcels of ten strokes each, retaining only the two cross strokes, thus, X, as the symbol for 10. Continuing the same method as larger numbers came to be used, they invented a second new symbol for 100, thus, C (which was at first probably the cancelling stroke for ten X's in the same way as X was originally the cancelling stroke for ten units); and for the sake of facility in writing, subsequently employed the letter C, which resembled it, in its place. The circumstance that C was the initial letter of the word *centum*, 'a hundred,' was doubtless an additional reason for its substitution in place of the original symbol for 100. An extension of the same process produced M, the symbol for 1000, which was also written Λ , Γ , and very frequently CIQ. This symbol was probably suggested by the circumstance that M was the initial letter of the Latin word *mille*, signifying a thousand. The early Roman system went no higher. But though the invention of these three symbols had greatly facilitated the labour of writing down and reading off numbers, further improvements were urgently required. The plan of 'bisection of symbols' was now adopted; X was divided into two parts, and either half, V or Λ , used as the symbol for 5; C was similarly divided, Γ or L standing for 50; and Λ , CI, or IQ, was obtained in the same manner, and made the representative of 500. The resemblance of these three new symbols to the letters V, L, and D, caused the substitution of the latter as the numerical symbols for 5, 50, and 500. A final improvement was the substitution of IV for 4 (in place of IIII), IX for 9 (in place of VIIII), XC for 90 (instead of LXXXX), and similarly XL for 40, CD for 400, CM for 900, &c.; the smaller number, when in front, being always understood as subtractive from the larger one after it. This last improvement is the sole departure from the purely additional mode of expressing numbers; and if the symbols for 4, 9, 90, &c., be considered as single symbols, which they practically are, the deviation may be looked upon as merely one of form. In later times, the Roman notation was extended by a multiplication of the symbol for 1000, thus CCIQQ represented 10,000; CCCIQQQ represented 100,000, &c.; and the bisection of these symbols gave them IQQ and IQQQ as representative of 5000 and 50,000 respectively. This, in all probability, is the mode according to which the Roman system of notation was constructed. To found a system of arithmetic upon this notation would have been well-nigh impossible; and so little inventive were the Romans, that the attempt seems never to have been made. They performed what few calculations they required by the aid of the *Abacus* (q. v.).

Chinese System.—This system presents a strong resemblance to the former, but is, in facility of expression, much superior to it. Like the Roman, it retains the primitive symbols for the first three digits, and like it also expresses the last four by prefixing a new symbol to the symbols for the first four, and the analogy is continued up to 'twenty.' From this point onwards, the Chinese system departs from the 'additive' principle, as 20, 30, &c., are represented not as in the Roman system by a repetition of the symbol for 10, but by affixing to the symbol for 10, on its

NOTATION.

left side, the symbols for 2, 3, &c., as multiples. The same method is adopted with the numbers 200, 300, &c.; and should the number contain units, they are annexed on the right-hand side. For small numbers up to 20, the Roman notation is more expeditious, on account of the greater simplicity of its characters; but for very large numbers, the Chinese is scarcely more cumbersome than our own. Some numbers which are expressed by the Chinese with 14 characters, require more than 100 symbols when expressed in the Roman notation.

Previous to the intercourse of the Western European nations with China, their notation was much more cumbersome than it is at present; but the changes since made have affected merely the form of the characters, without altering the principle of the system.

Artificial Systems.—The first of these, in point of date, is the Hebrew; but as the knowledge we possess of it is very meagre, and as its principle was adopted by the Greeks in the construction of their improved system, it will be sufficient to describe the latter.

Greek System.—The Greeks at first used a method similar to the Romans, though at the same time they appear to have employed the letters of the alphabet to denote the first 24 numbers. Such a cumbersome system was naturally distasteful to so fastidious a race, and they hit upon the happy expedient of dividing their alphabet into three portions—using the first to symbolise the 9 digits, the second the 9 tens, and the third the 9 hundreds. But as they possessed only 24 letters, they had to use three additional symbols; their list of symbols of notation then stood as follows:

Units.	Tens.	Hundreds.
α represents 1	ι represents 10	Ϟ represents 100
β 2	κ 20	ϟ 200
γ 3	λ 30	Ϡ 300
δ 4	μ 40	ϡ 400
ε 5	ν 50	Ϣ 500
ζ (Introduced) 6	ξ 60	ϣ 600
η 7	ο 70	Ϥ 700
θ 8	π 80	ϥ 800
θ or ϑ 9	Ϡ or ϣ (Introduced) 90	Ϟ, ϟ, Ϡ (Introduced) 900

By these symbols, only numbers under 1000 could be expressed, but by putting a mark, called *cola*, under any symbol, its value was increased a thousandfold, thus Ϟ = 1000, ϟ = 20,000; or by subscinding the letter M, the value of a symbol was raised ten-thousandfold, thus Ϟ = 80,000. For these two marks, single and double dots placed over the symbols were afterwards substituted. This improvement enabled them to express with facility all numbers as high as 9,990,000, a range amply sufficient for all ordinary purposes. Further improvements were made upon this system by Apollonius, who also by making 10,000 the root of the system, and thus dividing the symbols into tetrads, greatly simplified the expression of very large numbers. Both Apollonius and Archimedes had to a certain extent discovered and employed the principle of giving to symbols values depending on their position and multiplicative of their real value, but this principle was applied to tetrads or periods of four figures only, and the multitude of symbols seems to have stood in the way of further improvement. Had Apollonius, who was the chief improver of the system, discarded all but the first nine symbols, and applied the same principle to the single symbols which he applied to the 'tetrad' groups, he would have anticipated the decimal notation.

The Greek arithmetic, founded upon such a system of notation, was necessarily lengthy and complicated in its operations, each number in the multiplicand forming with each number in the multiplier a separate product (not as in our system, where one product blends with another by the process of 'carrying'), though by arranging these products in separate columns, according as they amounted to units, tens, hundreds, &c., the process was somewhat simplified. But when fractions formed part of the multiplier and multiplicand, the Greek arithmetic became almost unmanageable, till the invention of *SEXAGESIMALS* (q. v.) by Ptolemy superseded it. After Ptolemy's death, all improvement was arrested.

Decimal System.—The decimal system, which was introduced into Europe from the East (see *NUMERALS*), was first employed by the Spaniards, and was from them transmitted to the French and Germans, through whom its use was extended over Europe. The modern arithmetic was not practised in England till about the middle of the 16th c., and for a long time after its introduction was taught only in the universities. The decimal system, possessing only 9 symbols—viz., 1, 2, 3, 4, 5, 6, 7, 8, 9 (called the nine digits)—adopts the principle of giving to each symbol or 'figure' two values, one the absolute value, and the other a value depending upon its position. The numbers from 'one' to 'nine' inclusive are expressed by the nine digits; ten is expressed by writing a cipher or zero after 1 (10), thus throwing it into the second place, and giving it a positional value ten times its absolute value. From the principle that a figure thus moved one place to the left is held to be increased in value ten times, this method of notation is called *decimal notation* (Lat. *decem*, ten), and *ten* is said to be the 'radix' of the system. The numbers from 'eleven' to 'nineteen' inclusive are expressed by taking the symbol 10 and putting the digits from 'one' to 'nine' inclusive in place of the zero—e. g., twelve is written 12, 1 in *position* signifying ten units, and 2, two additional units. On the same principle, twenty is expressed by putting 2 in the second position (20), and so on to 99. To express a hundred, 1 is put in the third place (100), thus making its value ten times what it is in the second place, or ten times ten units; two hundred is similarly expressed by 200, &c.; and should a number of tens and units amounting to less than a hundred exist in the number, the symbols expressing them are substituted for the two zeros. This process can be similarly continued without limit.

There is another way of looking at this notation, which is perhaps simpler and clearer. In such a number, e. g., as 333, instead of attributing different values to the figure 3 in the different positions, we may consider it as symbolising the same number throughout, namely, *three*; but *three what?* In the first place, it signifies three ones or units (e. g., three single pounds or sovereigns); in the second place, it still signifies three, but now it is three 'tens' or decades (three parcels of ten sovereigns each); and in the third place, it still signifies three, but now three hundreds (three parcels of a hundred each). It is from this point of view that the first place to the right is called the *place of units*, or the *units' place*; the second, the *place of tens*, and so on. When such a number as 6473 is analysed on this principle, it is seen to mean 6×1000 (6 times 1000) + 4×100 + 7×10 + 3×1 ; and 6004 becomes $6 \times 1000 + 4 \times 1$. In this latter instance the peculiar importance of the figure 0 is seen (see *NOTHING*). Following out the method, the general formula for all numbers is $a \times 10^m + b \times 10^{m-1} + c \times 10^{m-2} + \dots + m \times 10^2 + n \times 10^1 + p \times 10^0$

+ g , where $a, b, c, \dots, m, n, p, q$, stand for any of the nine digits or zero.

The special advantages of such a system are manifold. It enables us to express small numbers with the greatest ease, and as the smaller numbers are those most commonly used, this is a great point in favour of the system. It also gives to computation a unity which could never under any circumstances have existed in the systems of notation above described, and the most ordinary, and at the same time effective, illustration of this is the process of 'carrying' in multiplication, whereby one product is blended with another, and much time and trouble in the subsequent addition is saved. This simplification, however, is chiefly due to the introduction of the symbol 0, which, supplying the place of an absent digit, preserves to those figures on the left of it their true positional value. Another advantage of this system is the ease with which computations involving fractions are performed (see FRACTIONS, DECIMAL). The use of the number 10 as *radix*, is universal in all systems of notation; but it has been often doubted, and in some respects with good reason, whether it is the number best fitted for this position, and many have proposed to substitute 12 for it. This question will be referred to under SCALES OF NOTATION.

2. SYMBOLICAL NOTATION, the general designation of those symbols which are used by mathematicians to express indefinite quantities. The symbols are generally taken from the English, Roman, and Greek alphabets, and are apportioned as follows: Algebraic quantities are expressed by the English alphabet; those which are known, by the earlier letters a, b, c, \dots , and those which are unknown, by the later ones, u, v, w, x, y, \dots . In Trigonometry, the letters a, b, c, \dots denote measures of length, and A, B, C, \dots are used to express angles. In Mechanics and Astronomy, the Greek letters are generally used to express angles. When different sets of quantities are similarly related among themselves, the sets are, for convenience, expressed by the same letters; and to prevent confusion, each set has a peculiar mark attached to each symbol, thus, a, b, c, \dots denote one class; a', b', c', \dots another class; a'', b'', c'', \dots a third class; and so on; or, $a_1, b_1, c_1, \dots, a_2, b_2, c_2, \dots$ &c.

NOTE, in Music, a character which by the degree it occupies on the staff represents a sound, and by its form the period of time or duration of that sound. The notes commonly in use in modern music are the semibreve, \circ ; minim, η ; crotchet,

ρ ; quaver, ρ ; semiquaver, ρ ; demisemiquaver, ρ ;

and semi-demisemiquaver, ρ . Taking the semibreve

as unity, the minim is $\frac{1}{2}$ its duration, the crotchet $\frac{1}{4}$, the quaver $\frac{1}{8}$, the semiquaver $\frac{1}{16}$, the demisemiquaver $\frac{1}{32}$, and the semi-demisemiquaver $\frac{1}{64}$. Notes of greater length than the semibreve were formerly in use—viz., the breve, twice the duration of the semibreve; the long, four times; and the large, eight times the semibreve. Of these the breve, || or || , is still sometimes met with in ecclesiastical music.—The term note is often used as synonymous with musical sound.

NOTHING, in Mathematical language, denotes the total absence of quantity or number, as when equals are subtracted from equals, but it is often employed (see LIMITS) to indicate the limit to which a constantly decreasing positive quantity approaches. The absence of number or quantity could be equally well signified by the absence of

any symbol whatever, but the presence of '0' shews that in its place some number or quantity might, and under other circumstances would, exist.

In Physics, the symbol '0' is generally denominated zero, and has a different meaning. Like the former, it is the starting-point from which magnitude is reckoned; but while the starting-point in the former case was absolute, in this case it is conventional, and by no means denotes the absence of all quantity or magnitude. Thus the zero-point of the thermometer must not be interpreted to signify that when the mercury has fallen to this point atmospheric heat has totally vanished, but must be understood as a mere conventional starting-point for graduation, chosen for convenience, and not even necessarily representing any fixed natural degree of temperature.

NOTICE TO QUIT, is the formal notice given by a landlord to a tenant, or by a tenant to a landlord, that the tenant ought or intends to quit at a future day named. See LANDLORD AND TENANT.

NOTO, a town of Sicily, in the province of Syracuse, and 16 miles south-west of the city of that name, 3 miles from the sea. It is of the highest antiquity, was a place of great strength under the Saracens, and held out against the invading Northmen longer than any other town of Sicily. It is a very handsome town, contains rich churches, beautiful palaces, and broad and straight streets. Its academy has a library attached, and a collection of antiquities. A good trade is carried on in corn, wine, oil, and the other produce of the vicinity. Pop. 10,950. N. was destroyed by an earthquake in 1693, and rebuilt about $\frac{1}{4}$ miles from its former site.

NOTRE DAME, i. e., *Our Lady*; the old French appellation of the Virgin Mary, and therefore the name of a number of churches dedicated to the Virgin Mary in different parts of France, and particularly of the great cathedral of Paris.

NOTTINGHAM, a municipal and parliamentary borough of England, capital of the county of the same name, and a county in itself, on the Leen at its junction with the Trent, 130 miles north-north-west of London. It is built principally on the slope and at the foot of a rocky eminence, and in an architectural sense it has within recent years been much improved. The market-place is $5\frac{1}{2}$ acres in extent, and is surrounded by lofty buildings. The Trent, which passes about a mile south of the town, and is here about 200 feet wide, is crossed by railway bridges, and by an ancient bridge of 19 arches. The exchange, the town and county halls, the House of Correction, St Mary's Church, and the Roman Catholic Chapel are edifices worthy of special mention. The Free Grammar School, with an income from endowment of about £1000 a year, was founded in 1513, and had about 100 scholars in 1863. There are numerous hospitals for the poor and infirm. Of the manufactures, which are various and important, the principal are bobbin-net and lace, and cotton and silk hosiery. Cotton, silk, and flax mills, machine-shops, bleaching-works, and wire, iron, and brass works are in operation. N., which sends two members to the House of Commons, is a station on the Derby and Lincoln Railway. Pop. (1861) 74,693.

The original castle of N. was built by William the Conqueror; it was dismantled during the Protectorate, and replaced by the present edifice—a castle only in name.

NOTTINGHAM, an inland county of England, between Lincolnshire on the east, and Yorkshire and Derbyshire on the west. Area, 526,076 acres; pop. 293,867. It is 50 miles in length from north

to south, and 20 miles in average breadth. The meridian of 1° west falls along the middle of the county, and may be said to divide it into two nearly equal portions, of which the eastern, comprising the vale of the Trent, is level, and the western is occupied by hills of no great elevation. In the south of the county are the wolds, consisting of upland moors and pasture-lands, broken up by many fertile hollows. In the west are the remains of the royal forest of Sherwood, famous as the chief haunt of Robin Hood. The principal rivers are the Trent, and its tributaries the Erewash, Mann, and Idle. The Nottingham and Grantham Canal in the south connects the Trent with the Witham, and these two rivers are also connected by the Fosse Dyke Canal, which, running north-west from the city of Lincoln, joins the Trent on the north-eastern boundary of the county. By the rivers, canals, and the North Midland, Sheffield and Lincoln, and Great Northern Railways, there is direct communication in every direction. The climate, especially in the east, is remarkably dry. The soil is various; and, with regard to productiveness, the land is not above mediocrity. The usual crops are raised; there are many hop-plantations, and much land is laid out in market-gardens. Extensive tracts have been planted within recent years. Four members of parliament are returned for the county.

NOUKHA, a town of Russia, in Trans-Caucasia, is built on the southern slope of the Caucasus Mountains, 80 miles south-west of Derbend, in lat. 41° 12' N., long. 47° 13' E. Pop. 21,113, consisting of native Tartars belonging to the Mohammedan creed, of Armenians, and a few Russians, chiefly officials. Breeding the silk-worm is the staple branch of industry. The native breed of silk-worms is somewhat coarse, and is now being supplanted by the Italian breed.

NOUN (Lat. *nomen*, a name), in Grammar, is the term applied to that class of words that 'name' or designate the persons and things spoken about. In a wide sense, such words as *rich*, *tall*, are nouns, as well as *John*, *man*, *tree*; for they are names applicable to all objects possessing these attributes. But as words like *John*, *man*, *tree*, suffice of themselves to mark out or designate an object or a definite class of objects, while words expressive of a single attribute, like *rich*, *tall*, can be used only in conjunction with such a word as *man* or *tree*, the one class are called Adjective Nouns, or simply Adjectives (q. v.), while the other are called Substantive Nouns, or simply Substantives or Nouns. Nouns or Names, in this narrower sense, may be divided into classes in a variety of ways, according to the ground we take for our division. One of the distinctions commonly made by grammarians is into Proper Nouns and Common Nouns. A proper noun is usually defined to be 'the name of any individual person, or place,' as *John*, *London*; while a common noun is applicable to every individual of a class of objects, as *prince*, *city*. But this definition fails to point out the real difference; for there are several *Londons*, and there are more *Johns* than *princes*; other things also have proper names, besides persons and places, as ships (the *Minotaur*), and bells (Big Ben). Providence, again, although applicable to only One Being in the universe, is not a proper noun. Wherein, then, lies the difference? In order to answer this question, we must advert to an important distinction made by logicians with regard to the import of names. A word is said to denote all the objects to which it is applicable as a name; thus, the word *man* is a name for all the objects known individually as James, John, Adam, Caesar, &c., and therefore denotes the whole human race;

but while thus denoting or naming them, it also implies something concerning them; in the language of logic, it connotes that they possess certain attributes, namely (1) a certain corporeal form, known as the human form; (2) animal life; (3) rationality. All this, at least, is included in the meaning or connotation of the word 'man.' Now, if we consider any noun of the class called common, we find that while it denotes, or names, or points out a certain object, or class of objects, it also conveys or implies some qualities or facts concerning them; in other words, all such names are connotative, or have a meaning. Not so with proper nouns. To say that a man is called John Butler, informs us of no quality he possesses, or of any fact except that such is his name. The name itself conveys no meaning; it is non-connotative. And this is what really constitutes a proper name; it is affixed to an object, not to convey any fact concerning it, but merely to enable you to speak about it. Proper names, indeed, are often given at first on account of the object possessing certain attributes; but once given, they do not continue to connote those attributes. The first John Baker was probably so called because he exercised the trade of baking; but his ceasing to bake would not have made him lose the name; and his descendants were called Baker, regardless of their occupation.

Proper names are thus *meaningless marks*, to distinguish one individual from another; and the A, B, C, &c., which a geometrician affixes to the several angles of a figure, are as much proper names as Tom, Lawrie, &c., applied to the individual bells of a chime. The proper contrast, then, to a Proper Noun is not a Common Noun—meaning by that a name common to a class of objects—but a Significant Noun.

Of Significant Nouns, by far the greater number are General or Class Names; that is, they can be applied to any individual of a class of objects, implying that all these individuals have certain attributes in common—as *quadruped*, *book*. The quadruped spoken of may perhaps be a *horse*, and here we have another class-name, applicable to the same object, but of less generality than 'quadruped.' *Animal*, again, is more general than quadruped, being applicable to a far wider class. But it is important to observe, that as the number of objects that the terms are applied to, or denote, increases, the number of attributes they imply—in other words, the amount of their meaning—diminishes. To call an object an 'animal,' merely implies that it is organised and is alive (with that kind of life called animal life); to call it a 'quadruped,' implies all this and a number of attributes in addition; and to call it a 'horse,' implies a still further addition.

It is to this class of words that the term Common Nouns is properly applicable; and the contrast to them is not Proper Nouns, but what might be called Singular Nouns, such as 'God,' 'providence,' 'universe.'

Collective Names are such as *regiment*, *fleet*, *senate*, *shoal*. They form a subdivision of Class Names or Common Nouns; for *regiment* is applicable to all collections of men organised in a particular way.

Names of Materials are such as *iron*, *water*, *sugar*, *wheat*. These two classes appear in many cases to merge into each other. In both, the objects named consist of an aggregation; but in collective names, the parts forming the collection are thought of as individual objects; as the *soldiers* of a regiment, the *fishes* composing a shoal. Substances, again, like iron, gold, water, are not made up of definite individual parts (at least to our senses); and in such as wheat, sand, the name of the individual visible part (*grain of wheat*, *grain of sand*) is

derived from the name of the mass, shewing that the idea of the individual is swallowed up in that of the mass.

A convenient term for names of materials or substances is that used by German grammarians—*Stuff-nouns*. Sometimes the same word is used as a *stuff-noun*, and also as a *class-noun*. Thus: 'The cow eats *grass*' (*stuff-noun*); 'The botanist studies the *grasses*, and has found a new *grass*' (*class-noun*); 'They had *fish* (*stuff-noun*) for dinner, and consumed four large *fishes*' (*class-noun*).

Names of materials are not, like collective nouns, a subdivision of common nouns; they belong to the contrasted class of singular nouns; and, when the substance is simple or invariable in composition, cannot be used in the plural; as *gold, water, beef*.

Abstract Nouns.—In the expression 'hard steel,' or 'the steel is hard,' the word *hard* implies a certain quality or attribute as belonging to the steel. This quality has no existence apart from steel or some other substance; but I can withdraw (*abstract*) my thoughts from the steel in other respects, and think of this quality as if it had an independent existence. The name of this imaginary existence or abstraction is *hardness*. All words expressive of the qualities, actions, or states of objects, have abstract nouns corresponding to them; as *brave*—*bravery*; *strike*—*stroke*; *well*—*health*. In opposition to abstract nouns, all others are *concrete nouns*—that is, the attributes implied in them are considered as embodied in (*concrete*, Lat. growing together) the actual existences named.

NOUREDDIN-MAHMÛD, MALEK-AL-ADEL, one of the most illustrious men of his time, and the scourge of the Christians who had settled in Syria and Palestine, was born at Damascus, 21st February 1116. His father, Omad-ed-din Zengui, originally governor of Mosul and Diarbekir on behalf of the Seljuk sultans, had established his independence, and extended his authority over Northern Syria, including Hems, Edessa, Hamah, and Aleppo. N. succeeded him in 1145, and the better to carry out his ambitious designs, changed the seat of government from Mosul to Aleppo. Count Joscelin of Edessa, thinking the accession of a young and inexperienced sovereign afforded him a favourable opportunity of regaining his territories, made an inroad at the head of a large force, but was signally discomfited under the walls of Edessa, his army, with the exception of 10,000 men, being completely annihilated. The report of N.'s success being conveyed to Western Europe, gave rise to the second Crusade: The Crusaders were, however, foiled by N. before Damascus, and being defeated in a number of partial conflicts, abandoned their enterprise in despair. N. next conquered Tripolis and Antioch, the prince of the latter territory being defeated and slain in a bloody conflict near Rugia (29th June 1149), and before 1151 all the Christian strongholds in Syria were in his possession. He next cast his eyes on Egypt, which was in a state of almost complete anarchy under the feeble sway of the now effeminate Fatimites, and, as a preliminary step, he took possession of Damascus (which till this time had been ruled by an independent Seljuk prince) in 1156; but a terrible earthquake which at this time devastated Syria, levelling large portions of Antioch, Tripolis, Hamah, Hems, and other towns, put a stop to his scheme for the present, and compelled him to devote all his energies to the removal of the traces of this destructive visitation. An illness which prostrated him in 1159, enabled the Christians to recover some of their lost territories, and N., in attempting their re-subjugation, was totally defeated near the Lake of Gennesareth by Baldwin III., king of Jerusalem;

but undismayed by this reverse, he resumed the offensive, defeated the Christian princes of Tripolis and Antioch, making prisoners of both, and again invaded Palestine. Meanwhile, he had obtained the sanction of the calif of Bagdad to his projects concerning Egypt, and the true believers flocking to his standard from all quarters, a large army was soon raised, which, under his lieutenant Shirkoh, speedily overran Egypt. Shirkoh dying soon after, was succeeded by his nephew, the celebrated Salah-ed-din (q. v.), who completed the conquest of the country. N., becoming jealous of his able young lieutenant, was preparing to march into Egypt in person, when he died at Damascus, 15th May 1174. N. is one of the great heroes of Moslem history. Brought up among warriors who were sworn to shed their blood for the cause of the Prophet, he retained in his exalted station all the austere simplicity of the first califs. He was not, like the majority of his co-religionists, a mere conqueror, but zealously promoted the cultivation of the sciences, arts, and literature, and established a strict administration of justice throughout his extensive dominions. He was revered by his subjects, both Moslem and Christian, for his moderation and clemency, and even his most bitter enemies among the Christian princes extolled his chivalrous heroism and good faith. He possessed in an eminent degree the faculty of impressing his own fiery zeal for the supremacy of Islam upon his subjects, and their descendants at the present day have faithfully preserved both his name and principles.

NOVA SCOTIA, a province of British North America, is bounded on the N.-W. by New Brunswick and the Bay of Fundy, on the N. by the Straits of Northumberland and the Gulf of St Lawrence, and on the other sides by the Atlantic Ocean. It consists of two portions, N. S. proper, a large peninsula connected with New Brunswick by an isthmus about 15 miles in width, and the island of Cape Breton (q. v.). The peninsula, about 280 miles in length, and from 50 to 100 miles broad, extends in an east-north-east and west-south-west direction. Cape Breton lies north-east of N. S. proper, separated from it by a narrow strait, called the Gut of Canso, 16 miles long, and from half a mile to 2 miles wide. Sable Island, which is 25 miles in length by $1\frac{1}{2}$ in breadth, and is surrounded by a dangerous, widely-extended sand-bank, is situated about 90 miles from the nearest coast of N. S., in lat. 44° N., and long. 60° W. It is formed of sand-hills thrown up by the sea, some of them being about 80 feet in height. The island is covered with wild grasses, which support herds of wild horses, known as Sable Island ponies. It is in the track of vessels trading between America and Britain, and owing to the number of wrecks that take place on its shores, a superintendent and several men are stationed here for the purpose of rescuing and aiding shipwrecked mariners. The area of the province is 18,600 square miles; pop. (1861) 330,857. The coast-line is about 1000 miles in length, and the shores, which are much indented, abound in excellent bays and harbours, of which the chief are Chedabucto Bay, Halifax Harbour, St Margaret's, Mahon, and St Mary's Bays, Annapolis, Mines, and Chignecto Basins, and Pictou Harbour. There are numerous rivers, but few of them are over 50 miles in length; the most important are the Avon, the Annapolis, and the Shubenacadie. N. S. contains about 400 lakes, of which the Bras d'Or, in Cape Breton, covers an area of 500 square miles, or about one-sixth of the entire area of the island. Stretching along the Atlantic sea-board, and extending inland from it for about 20

NOVA ZEMBLA—NOVATIAN.

miles, is a range of highlands, and about 60 miles from the Atlantic coast are the Cobequid Mountains, 1100 feet in height; which traverse the peninsula from the Bay of Fundy to the Straits of Canso. The soil in the valleys is rich and fertile, producing all the fruits of temperate climates; and, especially in the north, the uplands also are fertile. The climate is remarkably healthy, its rigour being modified by the insular character of the province, and by the influence of the Gulf Stream. The mean temperature for the year is 42.09° at Pictou, and 43.6° at Windsor. The extreme limits of the thermometer may be stated at - 15° Fahr. in winter, and 95° in the shade in summer. The province abounds in mineral riches, including gold, coal, and iron. No official statement of the quantity of gold obtained in any given time has been published, but it is now notorious that large quantities of the precious metal are locked up in the geological strata of the island, chiefly in bands of quartz. Gold was first discovered in the colony in March 1861, on Tangier River, about 40 miles east of Halifax. The chief diggings are along the Atlantic coast, and gold has been found in nearly 100 different localities. An act of the legislature regulating the disposal of claims and the collection of revenue from the gold-fields was passed in March 1862. In 1860, 213,400 tons of coal were raised from certain specified mines of the province, while large quantities were also raised in other localities. In 1851, the quantity of iron smelted was 400 tons; in 1861, 1200 tons. Of the entire area of the colony, 10,000,000 acres are considered good land, and of these 1,023,032 acres were under cultivation. Three-fourths of the whole area are comprised in the peninsula of N. S., and the remainder in the island of Cape Breton. The principal agricultural products in 1861 were hay, wheat, barley, buckwheat, oats, rye, Indian corn, potatoes, and turnips. The waters around the colony abound in fish, as mackerel, shad, herring, salmon, &c., and the fisheries are pursued with ardour and with ever-increasing success. In 1860, 900 vessels, 8816 boats, and 14,322 men were employed in the fisheries, and the value of the fish exported in that year was 2,072,081 dollars. In 1861, the imports amounted to 7,613,227 dollars, the exports to 5,774,334 dollars, receipts 892,324, expenditure 1,017,502. There are in the colony 1150 miles of telegraph, and 94 miles of railway. It is provided with 10 colleges and academies, and 1123 grammar, normal, and other schools.

N. S. is supposed to have been visited and 'discovered' by the Cabots in 1497. Its first colonists were a number of Frenchmen, who established themselves here in 1604, but were afterwards expelled by settlers from Virginia, who claimed the country by right of discovery. Under the French settlers it bore the name of Acadia (Acadie); but its name was changed for its present one in 1621, when a grant of the peninsula was obtained from James I. by Sir William Alexander, whose intention was to colonise the whole country. Having found, however, that the localities they had fixed upon as suitable for settlement were already occupied, the colonists returned to the mother-country. In 1654, the French, who had regained a footing in the colony, were subdued by a force sent out by Cromwell. By the treaty of Breda, the country was ceded to the French in 1667, but it was restored to the English in 1713. After the middle of the 18th c., strenuous efforts were made to advance the interests of the colony. Settlers were sent out at the expense of the British government. The French, who had joined the Indians in hostilities against the English, were either expelled or completely mastered, and Cape Breton, which at an earlier period had been

disunited from N. S., was re-united to it under the same provincial government in 1819. The province is administered by a lieutenant-governor, assisted by an executive council of 9 members, a legislative council of 21 members appointed by the crown; and a House of Assembly, consisting of 55 members elected quadrennially by the inhabitants of the counties—which are 18 in number—and of the cities, the chief of which are Halifax, Annapolis, Liverpool, Pictou, and Windsor.

NOVA ZEMBLA (Russ. *Novaja Zemlja*, 'New Land'), the name given to a chain of islands lying in the Arctic Ocean (lat. between 70° 30' and 76° 30' N., and long. between 52° and 66° E.), and included within the government of Archangel. Length of the chain, 470 miles; average breadth, 56 miles. The most southern island is specially called Nova Zembla; of the others, the principal are Matthew's Land and Lütke's Land. They were discovered in 1553, and are wild, rocky, and desolate—the vegetation being chiefly moss, lichens, and a few shrubs. The highest point in the chain is 3475 feet above the level of the sea. Mean temperature in summer, at the southern extremity, 35.51°; in winter, 3.21°. N. Z. has no permanent inhabitants, but as the coasts swarm with whales and walrus, and the interior with bears, reindeers, and foxes, they are periodically frequented by fishermen and hunters.

NOVALIS. See HARDENBERG.

NOVARA, a town of Northern Italy, and capital of province of same name, is situated in a fertile district about 60 miles east-north-east of Turin. Pop. about 20,000. It commands fine Alpine views from its ancient dismantled fortifications, and contains several notable churches, especially the cathedral, with its fine frescoes and sculptures, and grand high-altar. On the 23d of March 1849, N. was the scene of a great battle between the Sardinian forces and an Austrian army commanded by Radetzky, which resulted in the complete defeat of the Italians, and ultimately led to the abdication of Charles Albert in favour of his son, Victor Emmanuel.

NOVATIAN, a priest of the Roman Church in the 3d c., and the leader of a sect called after his name. The place and time of his birth are not known with certainty. N. had been a stoic philosopher, but after his arrival in Rome was converted to Christianity, and being seized with sudden illness while still a catechumen, received what was called *clinical baptism*; that is, baptism administered on a sick-bed, and without the solemn ceremonial. Such baptism was, in ordinary circumstances, an impediment to holy orders. Notwithstanding this irregular baptism, N. was promoted to orders by Fabian the Roman bishop; and soon afterwards shewed his weakness by flying during a persecution. At this time a controversy arose about the manner of dealing with the lapsed; that is, those who fell away in persecution. N. at first inclined to the milder side, but on the election of Cornelius to the Roman bishopric to which N. had aspired, and on Cornelius taking the indulgent course towards the lapsed, N., together with Novatus and some other discontented priests of Carthage, opposed his authority, and eventually N. was chosen by a small party, and actually ordained bishop, in opposition to Cornelius. The party who espoused his cause was called by his name. They were confined mainly, in the first instance, to Rome and to Carthage, where a kindred conflict had arisen. They held that in the grievous crime of idolatry through fear of persecution, the church had no power to absolve the penitent; and therefore, although it does not appear that they

excluded such sinners from all hope of heaven, yet they denied the lawfulness of re-admitting them to the communion of the church. This doctrine they extended at a later period to all grievous sins, of whatever character. N. may thus be regarded as the first antipope. The churches throughout Italy, Africa, and the East adhered to Cornelius; but the N. party set up bishops and established churches not only at Carthage, but at Constantinople, Alexandria, Nicomedia, Phrygia, Gaul, Spain, and elsewhere. They claimed for themselves a character of especial purity, and assumed the appellation of Cathari (Puritans). The time and manner of the death of N. is uncertain. According to Socrates (*Hist. Ecc.* iv. 28; v. 21; vii. 5, 12, 25), he died a martyr in the persecution of Valerian, but this is improbable. He was a man of considerable learning, and the work recently discovered in one of the monasteries of Mount Athos, and published by Mr Miller at Oxford in 1851, under the title of *Origenis Philosophumena*, is by some ascribed to him. His sect survived long after his death. An unsuccessful effort was made in the council of Nice to re-unite them to the church; and traces of them are still discoverable in the end of the 6th century.

NOVELLÆ. See JUSTINIAN.

NOVELS. The novel and the so-called romance, inasmuch as they constantly merge in one another, and are only superficially distinguished by the preponderance in the one of ordinary and familiar incidents, in the other of incident more or less remote and marvellous, may conveniently be included here under the common definition of prose narrative fiction. Between the legendary epic, the drama into which portions of its available material from fluent become crystallised, and the wider prose fiction or novel, into which this again expands itself, there are obvious affinities, the distinctions being rather of form than of essence. It is of the later development, the novel, that we purpose to give here a historical sketch, omitting, however, any consideration of the remoter and but slightly known specimens produced in Hindustan and China.

1. *Ancient Classical Prose Fiction*.—The earliest Greek compositions of a fictitious character, of which we possess any knowledge, are the *Milesiaca*, or *Milesian Tales*, said to have been written chiefly by one Aristides. The Milesians were a colony of Ionic Greeks who settled in Asia Minor, and fell under the dominion of the Persians, 494 B.C. They were a voluptuous, brilliant, and inventive race, and are supposed to have caught from their eastern masters, whom they somewhat resembled, a liking for that particularly oriental species of literature—the imaginary story or narrative. None of the Milesian Tales are extant, either in the original Greek or in the Latin version made by Sisenna, the Roman historian, about the time of Marius and Sulla; but we have some forty stories by Parthenius Niceæ, which are considered to be to a certain extent adaptations from them. The collection of Parthenius is entitled *Peri Erotikôn Pathêmatôn*, and is dedicated to Cornelius Gallus, the Latin poet, and the contemporary and friend of Virgil. If we may judge from this later set of fictions, which are mainly concerned with the description of all sorts of seduction, of criminal and incestuous passions, and of deplorable terminations to wretched lives, we have little cause, either morally or æsthetically, to regret the loss of their more famous prototypes. In Greece Proper, nothing was done, so far as we know, in the way of novel or romance, until after the age of Alexander the Great. It has been conjectured, not improbably,

that his Eastern conquests had a potent effect in giving this new bent to the fancy of his countrymen. Clearchus, a disciple of Aristotle, wrote a history of fictitious love-adventures, and is thus, perhaps, to be considered the first European Greek novelist, and the first of the long series of *Erotikoi*, who reach down to the 13th c. after Christ. Not long after came Antonius Diogenes, whose romance, in 24 books, entitled *Ta hyper Thoulên Apista* (Of the Incredible Things beyond Thule), was founded on the wanderings, adventures, and loves of Dinias and Dercyllis. It appears to have been held in high esteem, and was at least useful as a store-house, whence later writers, such as Achilles Tatius, derived materials for their more artistic fictions. The work has not been preserved, but Photius gives an outline of its contents in his *Bibliotheca Cod.*

A long interval, embracing, indeed, several centuries, now elapses before we come upon another Greek novelist or romancist. Be the cause of this what it may, the ever-increasing luxury and depravity of the pagan imperial world, combined to develop and intensify that morbid craving for horrible, magical, and supernatural incidents, which in general fill the pages of the romancists of the empire. The first names that occur in the new series are Lucius of Patra (*Patrensis*) and Lucian (q. v.), who flourished in the 2d c. A.D., during the reign of Marcus Antoninus; but as the former simply collected accounts of magical transformations (*Metamorphoses*), he is perhaps not to be regarded as a novelist proper at all; while the latter was really a humorist, satirist, and moralist in the guise of a story-teller—in a word, a classic Rabelais and Heine, and as far as possible from being a member of the wonder-loving school of Erotics, with whom he has only an accidental connection by the external form of some of his writings. The first of the new series of romance writers, strictly so called, is properly Iamblichus (not the Neo-Platonic philosopher), whose *Babylonica* is, indeed, no longer extant; but we are able to form a pretty just estimate of it from the epitome of Photius. The next notable name is that of Heliodorus (q. v.), Bishop of Trikka, who flourished in the 4th c. A.D. This Christian writer, whose *Loves of Theagenes and Charicleia* is really the oldest extant erotic romance, has far excelled all his predecessors in everything that can render a story interesting or excellent, and his charming fiction obtained a great popularity among such as could read. Some imagine that they see in Heliodorus a resemblance to the minutely descriptive style of novel introduced into England by Richardson; but without adopting this rather extreme notion, it can at least be safely asserted, that Achilles Tatius and all the subsequent *Erotikoi* deliberately imitated his style and manner, while he was not less certainly used as a model by that once celebrated but dreadfully tedious school of heroic romance which flourished in France during the 17th c., and whose best-remembered representative is Mademoiselle de Scudéri. Tasso, Guarini, D'Urfé, and several other modern writers, have drawn many particulars—sometimes almost *verbatim*—from the stories in the *Theagenes and Charicleia*. Achilles Tatius (q. v.), probably belonging to the 5th c., ranks next to, but at some distance from, Heliodorus in point of merit. His romance, entitled *Ta kata Leukippon kai Kleitophonia*, and consisting of eight books, has supplied incidents to more than one Italian and French writer.

The next work that invites our attention in point of time, the *Daphnis and Chloe* of Longus, is of a totally different character. It is a simple and

picturesque prose-pastoral, with no poisonings, murders, magic, supernaturalism, and impossible exploits. Over the whole story rest a rural peace and a smile of cheerful sunshine; and, in spite of some singularly polluted passages, it was, for its time, a pure and wholesome fiction. *Daphnis and Chloë* is the only pastoral romance produced by any Byzantine author. Whether or not it exercised any influence on the development of the modern pastoral of Italy and France, cannot be proved, but it has been noticed that there is no slight resemblance between it and the story of the *Gentle Shepherd*, which we know was suggested to Allan Ramsay by a classical friend, who may have borrowed from the Greek the sketch which he gave to the poet. It has also been very closely imitated by Gesner in his idyll of *Daphnia*.

After Longus comes Chariton (flor. sometime between the 6th and 9th centuries), whose romance, in eight books, on the *Loves of Chareas and Callirrhoe*, is not quite complete, but nearly so. It contains, like the other erotic fictions, plenty of stirring and startling adventures, but on the whole these are less improbable than what we encounter in the writings of his predecessors. Of three Xenophons, also noted among the *Erotikoi*, and of uncertain date, the best is Xenophon of Ephesus, whose romance, entitled *Ephesiaca*, or the *Loves of Anthia and Abrocomas*, is in ten books, and has all the sensational characteristics of the school to which it belongs. It is, however, perhaps worth mentioning, that in the romance of Xenophon we meet for the first time with the story of the love-potion, the pretended death, and the mock-entombment of the heroine, which forms the leading incident in Shakspeare's *Romeo and Juliet*, and which, it is thought, reached the great English dramatist at second or third hand, through the Italian novelist, Luigi da Porta.

Again, a long interval elapses before we meet with another love-fiction of the old pagan sort. During this period, however, a work made its appearance, which was essentially a romance, and was composed expressly for the purpose of recommending that form of Christian life which was the favourite in early times—the ascetic and recluse form. This was the *Barlaam and Josephat* (q. v.), the author of which is unknown, but whose popularity, during the middle ages, may be estimated from the fact, that it was translated into every language of Christendom from Norway to Spain. In the 12th c., another erotic Eustathius or Eumathius, who was properly the last of the series, published his *Ismene and Ismenias*, in eleven books. This romance is, in truth, a feeble performance; the expiring flicker of a lamp whose oil is about done. It is puerile in its delineation of character, and full of plagiarisms; yet many of its details have been copied by later occidental writers, such as D'Urfé and Montemayor.

In all the erotic romances, the adventures, which in fact constitute the story, have certain common characteristics. The hero and heroine are generally carried off by robbers or pirates; or they flee from home, and are accidentally separated. They resolve to seek each other throughout the world, and in the course of their loving quest, they visit the remotest regions, encounter the most frightful perils, make hairbreadth escapes from tragic ends, meet again in most unexpected and miraculous ways, and generally close their career in happiness and splendid prosperity—often turning out to be the offspring of far greater people than they fancied. Copious use is made of poisons, love-potions, improbable tricks, magic instruments, &c.; and one can easily see that the stories were meant to tickle

and stimulate a languid, corrupt, sensual, and credulous people, such as the Greeks of the Lower Empire undoubtedly were.

Before touching on the mediæval romance of Western Europe, we may in a few words notice such specimens of classical fiction as exist, or are known to have existed in Latin. We have already stated that the Milesian Tales were translated into that tongue by Sisenna, who derived his knowledge of them from the Sybarites, a Greek colony of Lower Italy. The taste for similar stories increased during the empire, but the writers in general cannot have displayed much genius in their compositions, if we may judge from the contemptuous language used by the Emperor Severus against Clodius Albinus, whose fictions he designates *ludicra literaria*, and *avilia* (old wives' tales). But higher praise must be assigned to the work commonly attributed to Petronius Arbitr (q. v.), who flourished in the time of Nero, and whose *Satyricon*—incomplete—is a comic novel or romance, and (although the dirtiest work even in pagan literature) is executed with skill, vigour, and at times with beauty. In the 2d c. A. D., Appuleius (q. v.) wrote his *Ass* (called from its excellence the *Golden Ass*), which relates the adventures of a young man who had the misfortune to be accidentally metamorphosed into that animal, while sojourning in Thessaly, retaining, however, his human consciousness. The miseries which he suffers at the hands of robbers, eunuchs, magistrates, and other persons into whose hands he falls, until the period when he is enabled to resume his former figure, are portrayed with a wit, humour, and fancy hardly inferior to Lucian. The work is also believed to have had, like the writings of his Greek contemporary, a moral and satirical aim. It was immensely popular in the middle ages, has supplied Boccaccio with some of his stories, and the author of *Gil Blas* with the picturesque incidents of the robbers' cave in the early part of his romance, and contains in the episode of *Cupid and Psyche* one of the loveliest allegories of classical antiquity.

2. *Romantic Fiction in Western Europe.*—The first thing to be clearly understood in connection with this branch of literature is, that it is not a continuation of the Græco-Byzantine or classical fiction, though, curiously enough, it began to spring up in the West just as the other was dying out in the East. It is a completely new growth, the product of new historical circumstances, which were but very slightly affected by Byzantine influences of any kind; and it transports us into a world of ideas, sentiments, beliefs, and actions, as different from what we find in the *Erotikoi* as could well be imagined. In the latter, the principal characters are mere lovers forced into adventures by the ministers of fate; in the former, they are real heroes, of the old Homeric type, and seek dangers greedily and joyously. When we read the *Erotikoi*, we are reminded in many ways that we are in the midst of a corrupt and decaying civilisation; when we turn to the romances of chivalry, in spite of certain superficial and barbarous vices, such as the prevalence of bastardy, and the indifference displayed to bloodshed, we feel that we are in the presence of a youthful, healthy, vigorous and growing social life. That these romances, generally from beginning to end, consist of a series of extraordinary and utterly impossible exploits, in which the magic, the mystery, and the enchantments of the *Arabian Nights* are rivalled or outdone, is unquestionable; but this proves no more than that the races of Western Europe, who slowly, during the dark ages, rose, by the help of the church, out of barbarism into feudalism—the first step towards the

civilisation of the modern world—were boundlessly ignorant, credulous, and wonder-loving. Their prodigious vigour and vehemence of character having no proper intellectual *patulum*, was forced to supply its craving for a knowledge which was beyond its immediate attainment, by the exaggerations of a fancy that was without law or limit. We need not go so far as to assert that, in the mediæval romance, everything is of native or 'Gothic' origin; the fact is very much the reverse. This extreme theory, propounded by Mallet, and supported by Biahop Percy and other writers, is totally inadequate to account for all that is contained in these romances. Not less inadequate is another theory, first suggested by Salmasius, and afterwards elaborated by Warton, that the mediæval romance is mainly of Saracenic origin, and was probably introduced by the Moorish conquerors into Spain, and thence propagated into France and Britain; while a third theory, which has also found supporters, viz. that it was derived from the classical mythology of ancient Greece, is the most inadequate of all. The true explanation of the matter appears to be, that mediæval romances had its root and foundation in Chivalry (q. v.)—a genuine product of Western Europe—and although the machinery, so to speak, the exploits and the marvels, may have often been derived from the foreign sources we have mentioned, yet the spirit, scenery, sentiment, and life of the legends thoroughly reflect the characteristics of the earlier ages of feudalism. The notions of dragons, giants, magic rings, enchanted castles, are probably of Saracenic origin, and may have been introduced into Europe by the horde of pilgrims who visited the East in the time of the Crusades; such incidents as the detaining of a knight from his quest by the enchantments of a sorceress, may have been a tradition of the *Odyssey* of Homer; but the gallantry, the courtesy, the romantic valour, the tournaments, the noble friendships of brother-knights—all that distinguishes the romances of chivalry from Runic legends or the *Arabian Nights*, cannot be traced to any other source than the newborn chivalry of Europe.

The mediæval romances are divisible into three great series: 1. Those relating to Arthur and the Knights of the Round Table; 2. Those relating to Charlemagne and his Paladins; 3. Those relating to Amadis de Gaul and his descendants.

The Arthurian series is, in its essence, of Welsh and Armorio origin. Its genesis is as follows. First came the legendary chronicles composed in Wales or Brittany, such as the *De Excidio Britannia* of Gildas (q. v.); the chronicle of Nennius, belonging to the 9th c.; the Armorio collections of Walter Calenius or Gualtier, Archdeacon of Oxford; and the famous *Chronicon sive Historia Britonum* of Geoffrey of Monmouth (q. v.)—from these, and from the multitude of floating unrecorded traditions, sprung the *metrical*, which in turn gave birth to, and were ultimately superseded by, the *prose* romances. It is with the latter alone we have here to do. They, like the *metrical* romances, were composed by Anglo-Norman authors (whose names are unknown) during the 13th, 14th, and 15th centuries, who took all the more willingly to the old British legends, that in these the 'Saxons' were the objects of the authors' hatred and detestation. The principal romances of the Arthurian cycle are those of *Mélin* (q. v.), the enchanter; of *Arthur* (q. v.); of the Sangreal (see GRAAL); of *Perceval*; of *Lancelot du Lac*; of the princes of Lyonesse, *Meliadus* and his son *Tristan*; and of *Isie le Triste*, the son of Tristan. They relate the marvellous adventures, exploits, loves, and gallantries of the Knights of the Round Table, and are probably in substance the

oldest of the mediæval prose romances. The scenes are generally laid in Wales, Cornwall, Brittany, Ireland, or Scotland; only in one or two of the series are we taken as far as Egypt or India; and though Arthur is slain by 'Saracens' who supported his nephew, Mordred, and a general eastern colouring is present in the cycle, yet it is 'Saxons' who are his principal foes.

The series of Charlemagne and his Paladins is of purely French origin, and originated in a somewhat similar fashion to the Arthurian cycle; that is to say, there was first a legendary chronicle (in verse, however), entitled *Historia de Vita Caroli Magni et Rolandi*, erroneously attributed to Turpin or Tilpin, Archbishop of Rheims, and contemporary of Charlemagne, but probably executed in the 11th or 12th c.; then came a series of *metrical* romances, strictly so called, which were gradually supplanted by their *prose* counterparts, the authors of which last, however, appear to have diverged more from the *metrical* originals, and to have been more free and fanciful than their predecessors of the Arthurian cycle. The principal are *Huon of Bordeaux* (the incidents of which are followed by Wieland in his *Oberon*), *Guerin de Monglave*, *Gaylen Rhetors* (in which Charlemagne and his Paladins proceed *incognito* to the Holy Land), *Miles and Ames*, *Jourdain de Blaves*, *Doolin de Mayence*, *Ogier le Danois*, and *Maugis the Enchanter*. In these romances we are, in some respects, on totally different ground from that on which we find ourselves in the Arthurian series. We are transferred to the East—to Africa, Palestine, Arabia, Bagdad, Constantinople, India, Persia, the Caspian Sea, &c. We are introduced to the courts of Saracen 'princes,' 'sultans,' and 'emirs;' and see Mohammedan maidens of peerless beauty falling in love with Christian knights, and for their sakes abandoning, or even betraying father, mother, brethren, and kinsmen. Fairies, who figure but slightly in the Arthurian romances, play a frequent and an important part in these; demons, dervishes, apes, talismans, palaces with cupolas and gilded roofs, splendid jewels, diamonds, &c.—everything, in fact, shews the influence exercised on the imagination of Western Europe by the glowing scenery, the brilliant life, and the gorgeously fanciful superstitions of oriental lands.

The series relating to Amadis de Gaul and his descendants is sufficiently characterised under the head of AMADIS (q. v.). We may only observe, as a proof of the comparative lateness of their composition, that the 'Saracens' of the French romances here give place to 'Turks;' and as the eyes of Europe were turned towards the tottering Greek empire, many of the scenes of warfare are laid at Constantinople.

Besides the three distinct series of romance above mentioned, a fourth perhaps deserves mention, in which the heroes of antiquity are grotesquely tricked out in the costume of mediæval knights. The exact date of their composition cannot be ascertained, but they were probably later in general than any of the other three series; and, at any rate, were for the most part not published till the end of the 16th and the beginning of the 17th centuries. The principal are the romance of *Jason and Medea*, of *Hercules*, of *Edipus*, and of *Alexander*. They are all written in French, and the first two profess to be the work of a Raul le Febre. An attempt is made to adhere, in the general outline of the stories, to the ancient myths, but most marvellous embellishments are added, such as only the middle ages could have conceived; while the transformations that the classical personages undergo are exceedingly ludicrous. Jove becomes a 'king;' Mercury, his 'squire;' the

Fates, 'duennas;' Cerberus and the Sphinx, 'giants;' &c.

Before leaving this division of our subject, we would observe that, though the romances of chivalry may appear infinitely tedious and absurd to a modern reader, they were immensely relished and admired during the ages in which they were produced, were widely disseminated, in different forms, throughout all Christendom, and were highly popular with later poets. The influence which they exercised on Pulci, Boiardo, Tasso, Spenser, &c., shews the strong hold that they must have had on the imagination of Europe; but with the decline of chivalry, the spread of the more rational and artistic fictions of the Italian novelists, the revival of letters, and the general advancement in civilisation of Christendom, the taste for the romances of chivalry also declined, until finally Cervantes laughed them out of literature, and well-nigh out of memory, in the beginning of the 17th century.

3. *Development and Influence of Fiction in Italy.*—The Italians originated no romances of the kind described above. This resulted from various causes, the principal of which perhaps are: 1st, that they were really not a Gothic, but at least a semi-classic people; 2d, that they were more polished than the northern nations; and 3d, that instead of feudal chivalric institutions, the most characteristic political features of Italy, during the middle ages, were mercantile and lettered republics. There was that which may be roughly called a *middle class*—of merchants—in Italy, when England and France, and Spain, contained really little more than nobles and serfs; and these were really the best instructed and the most enlightened portion of the community. Hence it is but natural that we should find a style of fiction mirroring to some extent this more civilised and sober form of social life. That the classical romances had some influence on the development of Italian fiction, is probable; several of the tales recorded in the love-letters of Aristænetus, and in the *Golden Ass* of Apuleius, are quite like what we read in Boccaccio and others. The fables of Pilpai or Bidpai (q. v.), translated into Latin as early as the 13th c., were also not without a certain effect; but it is to the Arabico-Indian book of the seven counsellors (better known as *The Tales of the Seven Wise Masters*), still more to the stories of Petrus Alphonsus (whose work is entitled *De Clericali Disciplinâ*), and the *Gesta Romanorum* (q. v.), a grotesque jumble of classical stories, Arabian apologues, and monkish legends, in the disguise of romantic fiction; but most of all perhaps to the *Contes* and *Fabliaux* (q. v.) of the French poets, that we must look for the first sources of those almost innumerable *novellets* which mark the earlier literary history of Italy.

The earliest Italian work of this sort is the *Cento Novelle Antiche*, commonly called *Il Novellino*. It is a compilation by different hands—all unknown—of stories floating about, or taken with modifications from the sources above mentioned, with one or two of the more graceful episodes in the romances of chivalry, and was executed towards the close of the 13th century. It was followed in 1353 by the *Decameron* of Boccaccio (q. v.)—the finest, in point of humour, sentiment, and style, of the whole set, but not more original in the matter of story than *Il Novellino*. Its influence on early European literature was prodigious. Chaucer and Shakspeare in England have been in particular greatly indebted to it for incidents and plots; while in France—from those Trouvères he had himself derived so much—Boccaccio had a number of distinguished imitators. In his own country, his influence was so overwhelming, that for some centuries Italian novelists could

do nothing more than attempt to copy him; principal of these imitators are Franco Saffi (1335—1410), Ser Giovanni (who began to write his *novellets* in 1378, from which Molière got the plot of his *Ecole des Femmes*, and Shakspeare probably part of his story of the *Merchant of Venice*—though the story of the bond is far older, and is of Persian origin—Chaucer is also indebted to this Italian); Massuccio di Salerno (flor. about 1470), more original than most of the post-Boccaccian novelists; Sabadino delli Arienti (flor. about 1483); Agnolo Firenzuolo; Luigi da Porta; Molza, and Giovanni Brevio (flor. at the close of the 15th, and in the first half of the 16th c.); Girolamo Parabosco (flor. 1550); Marco Cademoste da Lodi (1644); and Giovanni Giraldi Cinthio (died 1573), noted particularly for his extravagant employment of sanguinary incidents, and the introduction of scenes of incredible atrocity and accumulated horrors. The seventh of his third decade of stories contains the story of Othello, the Moor of Venice; the plot of *Measure for Measure* was also derived indirectly from him. Cinthio was, in fact, the greatest favourite of all the Italian novelists with the Elizabethan dramatists. Besides these, we may further mention Antonio Francesco Grazzini (died 1583); Straparolo (wrote: 1554 *et seq.*), from whom Molière, and also the French writers of fairy tales, derived numerous hints; while the ludicrous incident embodied in the Scottish song of *The barrin' o' our door*, forms one of the stories of this writer; Bandello (died 1555), the most widely known and read (out of Italy) of all the Italian novelists next to Boccaccio, and in whom we find the original of Massinger's play of *The Picture*, and of Shakspeare's *Twelfth Night*; Granucci (published 1574); Malespini (published 1609); and Campeggi (early part of 17th century).—The best French imitations of these Italian tales are the *Cent Nouvelles Nouvelles* (printed 1456, and translated into English under the title of the *Hundredth Mery Tayles*, 1557). They are full of life, gaiety, and imagination, and are written in a most naive and agreeable manner; and the *Heptameron* of Margaret, Queen of Navarre, from which Shirley, the English dramatist, has taken the plots of two of his comedies.

A few words may also be devoted here in passing to a very different class of fiction—the *Spiritual Romance*. It originated, without doubt, in the bosom of the church, and from the desire to edify, by stories of religious knight-errantry, a rude and ignorant community, incapable of understanding or relishing abstract doctrines. The first of the series is *Barlaam and Josaphat*, already alluded to; but by far the greatest work of the kind produced during the middle ages is the *Legenda Aurea*, or Golden Legend (q. v.)—itself believed to be drawn from different and now partly forgotten sources. Besides these, may be mentioned a species of spiritual tale—the *Contes Dévots*, prevalent in France during the 12th and 13th centuries, and which were written by monks, probably with the view of counteracting the witty and licentious stories of the Trouvères; but curiously enough, in these pious fictions, the lives of monks and nuns are represented as far more immoral than in those of the secular satirists. The things, too, which the Virgin Mary is represented as doing are most astounding, and throw a strange but valuable light upon the religious notions of the age. In one story, she conceals the shame of a favourite nun; in another, she performs the part of a procurer; in a third, she officiates as midwife to an abbess who had been frail and imprudent; and in general, she

were the most degrading offices for the most less characters.

Romances of the 16th and 17th Centuries.—During the middle ages, the universal sway of the church and the institutions of feudalism gave a certain character of uniformity to the modes of life, and thereby to the social literature of Western Europe; but after the epoch of the Reformation, and even earlier, this uniformity disappears, and we find in every direction a tendency to the opposite extreme of individualism. This tendency manifests itself especially in the fiction of the period, which, vastly increasing in quantity and varying in quality, becomes difficult to classify. We shall, however, endeavour to group the products of modern prose-fiction works under what appears to us a convenient chronological heading.

During the 16th and 17th centuries, four different kinds of romance or novel were cultivated—1. *The Comic Romance*; 2. *The Political Romance*; 3. *The Pastoral Romance*; 4. *The Heroic Romance*.

Comic Romance substantially begins in modern times with Rabelais (q. v.), styled by Sir William Temple the *Father of Ridicule*. Others, indeed, had preceded him in the same path, but they had acquired no celebrity. In him we see unmistakably one form of the modern spirit—its daring freedom of speculation, criticism, and satire, also that lack of reverence exhibited by those who, at the period of the Reformation, clearly discerned the abuses of the church, but had not faith in the possibility or efficacy of reforms. Thus, Rabelais, in his inimitable burlesque romance, scoffs (with the tone of a sceptic, however) at the vices of the clergy, the crooked ways of politicians, the jargon of philosophers, and the absurdities of the *contes dévots*, and of the medieval tales generally. The next remarkable romance of a comic nature is the *Vita di Bertoldo* of Julio Cesare Croce (flor. at the close of the 16th c.), a work recounting the humorous and successful exploits of a clever but ugly peasant, and regarding which we are told that for two centuries it was as popular in Italy as *Robinson Crusoe* or the *Pilgrim's Progress* in England. The substance of the story can be traced back to an oriental source. A few years later appeared *Don Quixote* (see CERVANTES), in which 'war to the knife' was proclaimed against the romances of chivalry, and in which, perhaps, we see, more distinctly than in any other fiction of the period, the new turn that the mind of Western Europe had taken. Almost contemporaneous with *Don Quixote* was another Spanish romance—Matteo Aleman's *Life of Guzman Alfarache*, successively beggar, swindler, pander, student, and galley-slave. In this work, as in others of the same sort, we find several indications of the influence of the Italian novelists. It has been supposed that *Guzman Alfarache* suggested to Le Sage the idea of *Gil Blas*, and there is some resemblance between the two; but, at any rate, it gave birth to a host of Spanish romances with beggars and scamps for heroes, of which the best is the *Lazarillo de Tormes*, by Diego de Mendoza (1586). In the following century, France produced, among others, Scarron's *Roman Comique*, and Furetiere's *Roman Bourgeois*. England and Germany have nothing to shew in this department.

Political Romance was manifestly suggested partly by the great politico-ecclesiastical changes that took place in Europe in the first half of the 16th c., and partly by the immense increase in the knowledge of the manners and customs of remote nations, occasioned by geographical discoveries and mercantile adventure. The earliest of the series is the *Utopia* of Sir Thomas More; next comes the *Argenis* of Barclay, published in 1621; and to the

same class belong a variety of French romances produced about the close of the 17th and the beginning of the 18th c., of which by far the most famous is the *Télémaque* of Fénelon.

Pastoral Romance.—All through the middle ages, the fame of Virgil kept up a certain interest in compositions devoted to the delineation of rustic or shepherd life. We even find in the poems of the Troubadours several specimens of the erotic pastoral; and the *Ameto* of Boccaccio furnishes us with a prose illustration of the same. But it was after the revival of letters that this branch of fiction, so essentially classical, was most assiduously cultivated by men of scholarly genius; and though their works have not retained the popularity they originally enjoyed, they are still interesting and valuable from an historical point of view, and abound in descriptive passages of great beauty and sweetness. The pastoral life which they portray, however, never existed either in Greece or elsewhere. Their shepherds and shepherdesses are as unreal and unhistorical beings as the knights of medieval romance. The first important work of the kind is the *Arcadia* of Sannazzaro, written in Italian, about the end of the 15th century. It was followed by the *Diana* of Montemayor, written in Spanish, about the middle of the 16th c., several of the episodes of which are borrowed from the Italian novelists; while Shakspeare has in turn directly taken from it the plot of the *Two Gentlemen of Verona*, copying occasionally the very language, as well as some of the most amusing incidents in his *Midsommer Night's Dream*. The *Diana* was imitated in French by Honore d'Urfé, whose *Astrée* (1610—1625) was for a long while held in the highest esteem, and is really, in spite of its tediousness, a work of great learning and considerable merit. Twenty years before the appearance of *Astrée*, Sir Philip Sidney wrote and published his *Arcadia*, as tiresome, and in its substance as unreal, as any production of the same school, but in stateliness and melody of language, in luxury of fancy, in nobility and purity of sentiment, far exceeding them all.

Heroic Romance owed its origin partly to the immediate antecedent pastoral romance, partly to an increased acquaintance with classic history, produced by the translation of such books as *Plutarch's Lives*, and partly to the interest excited in the Moors of Granada by a splendid romance in Spanish (professing, however, to be a *history*), entitled *The Dissensions of the Zegriss and the Abencerrages*, and was printed at Alcalá in 1604, and which soon became extremely popular, especially in France. It was in the latter country alone that the *Romans de Longue Haine* (Long-winded Romances), as they have been happily nicknamed, were cultivated. The first of this heavy series was the *Polexandre* of Gomberville, published in 1632, in which the influence of the early Greek romances is visible. His successor, Calprenede, the best of a bad lot, wrote *Cleopatra*, *Cassandra*, and *Pharamond*. But the most prolific, and consequently the most intolerable of the school, is Madame de Scudéri, whose principal romances are *Ibrahim ou l'illustre Bassa*, *Clelie*, *Histoire Romaine*, *Artamenes ou le Grand Cyrus*, and *Almahide*. The pompous dignity, the hyper-polite address, the dreadful dullness, and the hollow ceremonialism of these ridiculous performances, admirably (if unintentionally) mirror the features of French court-life during the time of the *Grand Monarque*. The heroic romances did not long retain their meretricious reputation. Molière, and still more, Boileau in his satire *Les Héros de Roman*, *Dialogue*, ridiculed them to death, and in consequence, Madame de Scudéri had no successor.

NOVELS AND ROMANCES OF THE 18TH CENTURY.—The two European nations that most brilliantly distinguished themselves in the department of fiction during this century were England and France, and to these we shall chiefly confine our attention.

1. *English Prose Fiction*.—During the age of Elizabeth and her immediate successors, the imaginative genius of England, from various causes, had taken an almost exclusively poetical direction, and with the exception of Sidney's pastoral of *Arcadia*, and Bunyan's *Pilgrim's Progress*, we meet with nothing in the shape of a novel or a romance for a hundred years. The 17th c. has nothing to shew till it approaches its close. This is doubtless owing, in part at least, to the intensity of the great political struggle that agitated and rent England during the first half of that century, and gave an austere theological bias to society. The Puritans, in their day of triumph, would not tolerate either comic or heroic romances. They set their faces 'like flint' against all imaginative fiction, which they considered as little better than lying; and even to this day that class of people commonly described as 'the religious portion of the community,' in some sense the representatives of the Puritans, betray the legitimacy of their spiritual descent by their aversion to all sorts of secular tales. After the Restoration, however, an extraordinary change came over the English nation, or at least over the upper and wealthier classes. These rioted in the excess of a coarse and licentious reaction against the rigorous piety and fanaticism of the Commonwealth. This turbid viciousness by and by calmed down, but it left a certain taint of sensualism and materialism in the habits and life of the people, which, in the opinion of some competent critics, marks them to this day. It is certain that at the beginning of the 18th c. England was entering on the most prosaic, unimaginative, and unheroical period of her history. Its characteristics are faithfully reflected in most of her novels, which, as pictures of the gross dull life, the paltry thoughts, the low sentiments, the modish manners, and the loose morality that prevailed, possess a great historical value apart altogether from their literary merits. The first name that occurs is that of the notorious *Aphra Behn* (q. v.), the greater number of whose novels, of which *Oroonoko* is the best known, appeared towards the close of the reign of Charles II., but are included here in the literature of the 18th c., as they belong to it by the nature of their contents, and not to the 17th c. types of fiction. She was imitated by Mrs Heywood (born 1696, died 1758), of whose *Love in Excess*, *The British Recluse*, and *The Injured Husband*, it has been remarked, that 'the male characters are in the highest degree licentious, and the females as impassioned as the Saracen princesses in the Spanish romances of chivalry.' A later work, however, *The History of Miss Betsy Thoughtless*, is of a higher stamp, and is supposed to have suggested the plan of Miss Burney's *Evelina*. But the first novelist of great genius belonging to the new era is Daniel De Foe (q. v.), the father of modern English prose fiction, in whose writings—*The Adventures of Captain Singleton*, *The Fortunes of Moll Flanders*, *The History of Colonel Jack*, &c.—the coarse, homely, unpoetical, but vigorous realism of the time is strikingly apparent. Perhaps the Spanish ragamuffin romances may have furnished him with some hints. *Robinson Crusoe* is the finest and the most famous of all that class of fiction which was extensively cultivated both in France and England during the earlier part of the 18th c., and which received, in the former country, the name of *Voyages Imaginaires*. To the same class (outwardly at least) belong Swift's *Gulliver's Travels*,

though at bottom this is a satirical romance, like the works of Rabelais, and the *Gaudenzio di Lucca*, a sort of politico-geographical fiction, generally attributed to Bishop Berkeley. After De Foe comes Richardson (q. v.), very unlike any of the novelists of his age—to appearance! His Muse is a most decorous prude, and never utters anything rude, or vulgar, or licentious; but though she was inspired with the best intentions, her notions of how virtue should be rewarded indicate the coarseness of the time, hardly less than the debaucheries and seductions of Fielding and Smollett. The principal novels of Richardson are, *Pamela*, *Sir Charles Grandison*, and *Clarissa Harlowe*. Fielding (q. v.) thought Richardson untrue to nature, and wrote his first novel of *Joseph Andrews* as a burlesque on the style of his predecessor. Like his subsequent performances, *Tom Jones* and *Amelia*, it represents society as Fielding's sharper eyes saw it, on the whole, gross, vulgar, and impure. Smollett (q. v.), with a different style of genius, continues to paint in the same spirit. His chief works are, *Roderick Random*, *Peverine Pickle*, *The Adventures of Ferdinand Count Fathom*, and *Humphrey Clinker*. Sterne (q. v.), belonging to the same period, exhibits a genius so whimsical, peculiar, and original, that it is almost impossible to class him with any of his contemporaries. His *Tristram Shandy* is a work *en genere*, but nowhere is the coarse impurity and indelicacy of the age more conspicuous. Four years later, appeared Goldsmith's *Vicar of Wakefield*, in which a change for the better, in a moral point of view, is first noticeable. With the exception of Richardson, all the novelists above mentioned are usually, and we may add correctly, described as *humorists*. Other qualities they have besides, but this is the most common and predominant. When this school was passing away about 1760—1770, another was on the eve of being born. The publication of Percy's *Reliques* had re-awakened an interest in the age of chivalry and romance. Readers had become tired of the long prevalence of prosaic fiction, in spite of the splendid genius devoted to its illustration. It had done its work, and could create no more. The first of the modern romantic school was Horace Walpole, whose *Castle of Otranto* appeared in 1769. It was followed by Clara Reeve, the authoress of the *Old English Baron*, a romance that every school-boy, we hope, remembers with the deepest gratitude; but the greatest genius in this line was undoubtedly Mrs Radcliffe (q. v.), whose *Mysteries of Udolpho* and other works, though now almost forgotten, were once greedily devoured and abundantly imitated. The ablest of her successors were Matthew Gregory Lewis, author of *The Monk* (1796), and Maturin, author of *Montorio* (1803). In all the romances of this school, the incidents are of the most startling, terrible, and often supernatural character, and the scenery is in keeping with the incidents. Fierce barons, mysterious bandits, persecuted maidens, gloomy castles, secret passages, deep forests, murders, ghosts, haunted chambers, &c.; everything that could charm, by way of contrast, and pleasantly horrify the languid, matter-of-fact, sceptical 18th c., is to be found in their exaggerated pages.

A few novelists remain to be mentioned who are incapable of particular classification. These are Dr John Moore (q. v.), author of *Zeluca*, &c.; Godwin (q. v.), author of *Caleb Williams*, *St Leon*, &c., in whom the free-thinking and revolutionary spirit that seized many minds after 1789 is conspicuous; Mrs Inchbald (*Nature and Art*, *A Simple Story*, &c.); Charlotte Smith (*Old Manor House*, &c.); Miss Austen (*Pride and Prejudice*, *Emma*, *Persuasion*); and Maria Edgeworth, whose sketches of Irish character first suggested to Walter Scott

the idea of attempting for Scotland a series of like illustrations.

2. *French Prose Fiction in the 18th Century.*—It is not easy—perhaps not possible—to trace the causes that led to the cultivation of the different kinds of fiction which flourished in France during this century, and particularly during the first half of it. The natural love of change—of novelty; the accidental influences of foreign literature; the disposition, so peculiarly French, to satirise prevalent follies and vices; the wish, on the other hand, to amuse the leisure moments of a luxurious, superstitious, and profligate society: all these and many other causes unquestionably assisted in determining its diverse development. Four kinds have been distinguished: 1. *Pseudo-historical Romance*, the literature in which department, although copious enough, neither deserves nor requires special notice; 2. *Romance in which the incidents, though natural, are purely imaginary*; 3. *Satirico-moral Romance*; 4. *Fairy Tales*, to which may be associated the imitations of *Oriental Tales*, and the *Voyages Imaginaires*.

2. *Romance in which the incidents, though natural, are purely imaginary.*—This class more nearly corresponds with the modern conception of the novel than any of its predecessors, and probably had its prototype in *La Princesse de Oleves* and *Zayde*, by Madame La Fayette, who flourished in the latter half of the 17th c.; but the first great name that adorns it is that of Marivaux (1688—1763), whose *Vie de Marianne* and *Payson Parvenu* were long in high favour. They have this in common with the contemporary English fiction, that everything in them is produced by ordinary means, and the interest of the reader is sought to be awakened by the vivid and powerful portraiture of natural feelings, while the incidents, if often highly romantic, are always sufficiently probable to insure the credence of the imagination. Next to Marivaux comes the Abbé Prevot, q. v. (1697—1763), who first 'carried the terrors of tragedy into the novel.' He was a most voluninous writer, but the work by which he is now chiefly remembered is *Manon L'Escant*, recounting the adventures of a kept-mistress and swindler, the purpose of which appears to be similar to that of *La Dame aux Camelias* of Dumas fils—viz., to shew how noble, true-hearted, and self-sacrificing a prostitute may be! Other writers belonging more or less strictly to the same division are Madame Riccoboni (flor. 1750) and Rousseau (q. v.), in whose *Heloise* we begin to see the dawn of that fierce natural impure passion, and that extravagant scorn of conventional life, that culminated in the sanguinary paroxysms of the Revolution.

3. *Humorous and Satirical Romance.*—By far the most celebrated specimens of this kind of fiction produced in France during the 18th c. are the *Gil Blas*, the *Diabte Boiteux*, and *Le Bachelier de Salamanca* of Le Sage, q. v. (1668—1746), all of which were suggested by the prolific comic romancists of Spain, Juan de Luna, Quevedo, Cervantes, Espinel, from some of whom he has borrowed, with hardly any variation, whole scenes and stories, as well as from more ancient sources. The best parts, however, are his own, and the spirit of the work is thoroughly French in the gay and lightsome vivacity of its humour. It is with some hesitation that we place the younger Crebillon (q. v.) in the same category, for the licentiousness of his *Egarements du Cœur et de l'Esprit*, and other novels, is far more apparent than their satire or humour. Bastide and Diderot (q. v.) hold an equally doubtful position as satirists or humorists; but Voltaire (q. v.) may fairly claim to rank among the former, in virtue

of his *Candide*, *Zadig*, *L'Ingénu*, *La Princesse de Babylone*, &c., most of which contain covert attacks on superstition and despotism, under the forms in which Voltaire best knew them. Voltaire, however, had not a rich imagination, and, in consequence, has been obliged to help himself liberally in the matter of incident from older writers.

4. *Fairy Tales, &c.*—A very careful inquiry might probably succeed in tracing back this kind of literature to the early intercourse of Christian and Moorish nations, but the first work in which we find definite examples of fairy tales is the *Nights* of the Italian novelist Straparola, translated into French in 1586. In this collection are found at least the outlines of some of the best-known stories of the sort, such as *Le Chat Botté* (Puss in Boots), *Prince Marcassin*, *Blanchebelle*, and *Fortunatus*. The immediate forerunner and prototype, however, of the French fairy tales was the *Pentameron* of Signor Basile, written in the Neapolitan *patois*, and published in 1672. This work attracted and stimulated the fancy of M. Charles Perrault (q. v.), whose *Histoires ou Contes du Temps passé* appeared in 1697, and is incomparably the most naive and charming of all the collections of fairy tales. The titles of some of his *contes* will recall many a literary feast of our childhood—*La Barbe Bleue* (Bluebeard), *La Belle au Bois Dormant* (The Sleeping Beauty, to which, by the by, Tennyson has given a poetic immortality), *Le Chat Botté* (Puss in Boots), *Riquet à la Houppe* (Riquet with the Tuft), and *Le Petit Chaperon Rouge* (Little Red Riding Hood). The principal successors of Perrault were the Comtesse d'Aunoy (see AUNOY), Madame Murat, and Made-moiselle de la Force; but their stories are much more extravagant and forced than those of the illustrious academicians. The same censure, however, is not applicable to *Les Contes Marins* (1740), by Madame Villeneuve, among which occurs the tale entitled *La Belle et la Bête* (Beauty and the Beast), perhaps the most beautiful creation in the whole circle of this fantastic form of fiction.

Meanwhile, the translation of the *Arabian Nights' Entertainments* (q. v.) by Galland, 1704—1717, and of numerous other Arabic and Persian works, the great encouragement extended to the literature of the East in the 17th and 18th centuries, the publication of the *Bibliothèque Orientale* of D'Herbelot, &c., created a taste for the brilliant exaggerations of oriental fiction, and a variety of works were soon in the field, swarming with necromancers, dervishes, califs, bashaws, viziers, cadis, eunuchs, slaves. The most notable of these are—*Les Mille et un Quart d'Heure*, *Contes Tartares*; *Les Contes Chinois, ou les Aventures Merveilleuses du Mandarin Fum-hoam*; and *Les Sultanes de Gessaratte*, *Contes Mongols*, of M. Gueulette.—Of the class of fictions known as *Voyages Imaginaires*, the principal are the *Histoire Comique des Etats et Empires de la Lune*, and the *Etats et Empires du Soleil* of Cyrano Bergerac, which materially influenced the genius of Swift, who has, in fact, borrowed not a little from the first of these in his *Gulliver's Travels*, and which were themselves partly suggested by the Spanish romance of Dominico Gonzales, entitled *The Man in the Moon*. Such novels as the *Paul et Virginie* of Bernardin St Pierre, which appeared towards the end of the 18th c., do not come under any of the four heads, but may most conveniently be mentioned here.

Prose Fiction of Germany during the 18th and 19th Centuries.—The limits of our space will not permit us to do more than superficially indicate the development of this branch of literature in Germany, which, however, is the less to be regretted, as, during the greater part of the 18th c., it did not attain much distinction. Towards the close

of the century, however, writers became more numerous, and as the literary activity of many of them continued on till the first or second quarter of the 19th c., it will be most convenient and natural to treat both centuries together, as they, properly speaking, form only one era in the literary history of that nation.

The first eminent German novelist of this period was Wieland (q. v.), whose Greek romances, *Agathon*, *Aristippus*, *Socrates*, &c., are of that didactic and sceptical character which was beginning to mark the reflective genius of the continent, and which has since produced such immense changes in all departments of thought. Wieland was followed by a crowd of writers, in whose productions is more or less distinctly apparent the influence of the English novelists, particularly of Richardson and Fielding, who had been translated and carefully studied in Germany, where, however, the 'novel of manners,' whether serious or comic, dealt more largely in the representation of 'family life.' The principal names are August la Fontaine, Wetzel, Müller (whose *Steffried von Lindenberg* is still remembered and read), Scholz, and Hippel. Almost contemporary with these quiet and somewhat prosaic novelists, there flourished for a brief period (1790—1800) a school of an entirely opposite character, whose works, fiercely and outrageously romantic, had their poetic counterpart in Schiller's *Robbers*. They resemble, in their style of handling the feudal ages, the English romances of Mrs Radcliffe and others, which probably suggested them. The chief writers of this 'turbulent school of fiction,' as it has been called, are Cramer, Spiers, Schlenker, and Veit Weber.

Alone, and far above all others in redundancy and originality of fancy, humour, and pathos, towers Jean Paul Richter (q. v.), who is incapable of classification, and to whom, therefore, his countrymen have affixed the epithet of *Der Einsige* (The Unique). Apart from all schools—in this respect, but in this only, like Richter—stands Johann Wolfgang Goethe (q. v.), whose novels, as well as his poems, are poetic-philosophic efforts to represent, perhaps to solve, the great facts and problems of human life and destiny.

The reaction from the materialism and irreligious levity of French thought, first shewed itself in Germany towards the close of the 18th c., in a certain earnest love and study of the old, simple, superstitious, and poetical beliefs of the middle ages. Hence originated the exquisite class of fictions called *Volkmährchen* (popular legends or tales), in which the Germans have never been equalled. The most illustrious cultivator of this species of fiction is Ludwig Tieck (q. v.), for Musseus (q. v.), though gifted with admirable powers of narration, is marked by a sceptical humour and irony, not altogether compatible with an imaginative conception of his subject. Other distinguished names are those of De la Motte Fouqué (q. v.), Chamisso (q. v.), Heinrich Staffens, Achim von Arnim (q. v.), Clemens Brentano (q. v.), Zschokke, and Hoffmann (q. v.). The most recent German novel of mark is *Sollen und Haben* (Debit and Credit), by Gustav Freytag (q. v.), in which the influence of Dickens is very conspicuous.

NOVELS AND ROMANCES OF THE 19TH CENTURY.
—These have been produced in such overwhelming quantity, that volumes would be required merely to classify and characterise them. The vast and rapid increase in the material facilities of intercourse among European nations, which has taken place during the last forty years, has, among other results, tended to diffuse through each country the literary products of all the others, especially those of an

entertaining kind; and these have in turn more or less stimulated the imagination of native genius, so that at present there is hardly a people in Europe, not even excluding Turkey, which has not contributed something to the enormous stock of fiction belonging to the 19th century. It would be altogether out of the question to attempt, in a compendious work like the present, a notice, however brief, of the principal novels and romances of every European nation; we can only refer to the historical surveys of literature, to be found under such heads as BELGIUM, BOHEMIA, HUNGARY, NETHERLANDS, NORWAY, POLAND, SWEDEN, TURKEY, &c., and to individual biographies of eminent continental novelists. Even in regard to England and France, we can do little more than catalogue a few prominent names.

1. *English Fiction*.—Almost the first novelist that we encounter in the 19th c., Sir Walter Scott (q. v.), is probably the greatest that England, or even the world, has ever seen. Here, however, we have less to do with his personal rank in literature than with the kind of fiction that he cultivated. In a qualified sense, he may be regarded as a continuation of the romantic school, but it must be observed that he is free from all their monstrosities, spasms, tricks, and horrible machinery. Possessed at once of far greater antiquarian learning, imaginative genius, sound sense, and instinctive taste, than any of his 'romantic' predecessors, he knew precisely what to shun and what to choose; and though his Feudal Age, as depicted in *Ivanhoe*, *The Fair Maid of Perth*, &c., is a considerably idealised portrait of the rugged facts, it is a portrait, and not like Horace Walpole and Mrs Radcliffe's performances, a furious caricature. The political reaction that took place in Britain, after the sanguinary excesses of the French Revolution, assuming the form of a new and passionate attachment to venerable and time-honoured traditions, shewed itself in literature too, and Sir Walter Scott was its grandest representative. He strove to delineate the Past, as it seemed in the eyes of men who were dubious of the Present, and afraid of the Future—noble, stately, glittering, and gay, with the pulse of life ever beating to heroic measures. The overpowering genius of Scott necessarily but unhappily (for the comfort of readers) led to 'endless imitation,' but the only one of his followers that holds a tolerably decent position in literature is G. P. R. James (q. v.). Galt (q. v.) and Wilson (q. v.), the former with vulgarly comic humour, the latter with a highly sentimental and overdone yet without poetical pathos, portrayed aspects of Scottish life which the author of *Waverley* has passed over. Other novelists, such as Lockhart (q. v.), Miss Ferrier (q. v.), and Mrs Johnstone, do not call for special notice; neither does Hope (q. v.), though his *Memoirs of Anastasius* is a most brilliant and powerful book; nor Moore (q. v.), though his *Epicurean* has all the sparkling and superficial splendours of his verse. After Scott, the next novelist who distinctly marks a new stage in the development of fiction, is Sir Edward Bulwer-Lytton (q. v.), in whose earlier works at least we find something like a reflection of the cold, sneering, selfish, and sensual spirit that marked the upper classes during the period of the Regency; but the versatile genius of this author, and the different fields in which he has won renown, would make it quite unfair to define him as a merely 'fashionable' novelist, though his first and least meritorious distinctions were acquired in that capacity, and students of *Sartor Resartus* are apt to so remember him. Of fashionable novelists, strictly so called, the best known are Mrs Gore (q. v.) and Theodore Hook (q. v.). This class was succeeded by another

infinitely worse than itself—the *Newgate novelists*, as they have been well termed, who sought for their heroes among highwaymen, thieves, desperadoes, and murderers, like Jack Sheppard, Blueskin, Dick Turpin, Claude Duval, &c., and, flagitiously indifferent alike to fact and morality, laboured with pernicious success to invest the lives of these scoundrels with a halo of romantic interest and dignity. The chief of this school, 'by merit raised to that bad eminence,' is William Harrison Ainsworth (q. v.). Its admirers are mainly to be found among the most ignorant sections of the community, and it is almost questionable if it even deserves mention in a literary point of view. During the last thirty years, novels have been multiplied to a degree which is almost alarming, and literally incalculable. The greatest names are unquestionably those of Dickens (q. v.), Thackeray (q. v.), and Miss Evans; but besides these might be mentioned a host of others, who have attained either celebrity or popularity, or both. Every mode of life, and every kind of opinion, social, artistic, scientific, philosophical, and religious, has sought to recommend itself by adopting this fascinating garb. We have the nautical novels of Marryat (q. v.), smelling, like Dibdin's songs, of the briny deep; the political novels of Benjamin Disraeli (q. v.); the sporting and military novels of Lever (q. v.); the brilliant 'muscular Christian' novels of Kingsley (q. v.); the 'governess-novels,' as they have been aptly denominated, of Miss Brontë (q. v.); the 'school' novels of Hughes and Farrar; and the 'sensational' novels of Wilkie Collins, Miss Braddon, and others, the power of which last is undeniable, but the wholesomeness dubious. Other authors not less eminent, but not so easily classified, are Mrs Oliphant (q. v.) and Charles Reade (q. v.). The extraordinary increase of this potent, and therefore perilous branch of literature cannot fail to excite much curious reflection in thoughtful minds, but it is not within our province to 'moralise the theme.'

2. *French Fiction during the 19th Century.*—A few words are all that we can devote to this part of our subject, though it is far from uninteresting either in a literary or a moral point of view. The effect of the Revolution of 1789 on literature was not immediately beneficial, but the reverse, though it planted the germs of a multitude of new thoughts and aspirations in the mind of Christendom, which have since yielded, both in France and elsewhere, a prolific harvest of wheat and—tares. The iron despotism of Napoleon crushed nearly all literary expression whatever. His hatred of 'idealogue' is well known, but the novel was that species of idealogic composition that came least into collision with the principles of imperialism. Even *it*, however, could hardly be said to flourish; and the only tolerably gifted writer of fiction who figures during the First Empire is Le Brun, and he was reduced to the necessity of caricaturing the *bourgeoisie*, to which Napoleon had no particular objection, as they were by no means his warmest admirers. Chateaubriand (q. v.) and Madame de Staël (q. v.) are insignificant in this department, and Charles Nodier, though voluminous, was not an original novelist. After the return of the Bourbons, and especially after the revolution of 1830, France began to display a wonderful literary activity, and in particular, its long-repressed faculty of imagination burst into a sudden blossom of poetry and fiction. Even Napoleon, now that he was dead, received a peculiar homage from the class to whom he had never shewn favour or regard, of which the songs of Béranger and *Les Misérables* of Victor Hugo afford us specimens. Unhappily for the purity of its literature, the *régime* of the Resto-

ration, which followed the deliverance of France from a military despotism, was itself a base, corrupt, and profligate thing. The Bourbons came back only to re-enact the follies of their ancestors in the previous century, and the nation soon came to despise, detest, and disbelieve them, and the church which supported them. Hence, a certain reckless levity, and hollow mocking laughter, as of heartless scepticism, pervading those fictions which profess to delineate the realities of current life. The religious sanctions that give force and efficacy to moral obligations having disappeared, novelists have fallen back upon unassisted human nature, and have apparently justified all sorts of imprudences, indecencies, and even pollutions, in the lives of their heroes and heroines, on the ground of these springing from the excitements of 'natural' passion. The sparkling wit, the sunny humour, the pathos, often exquisitely tender and refined, the delicate or deep delineation of character, the occasional fine flush of sentimental enthusiasm, and the poetic witchery of a religious mysticism, cannot blind us to the fact, that the substance of most of the recent French fictions is incurably immoral. Paul de Kock (q. v.), Balzac (q. v.), Dumas (q. v.), father and son, Sue (q. v.), Madame Dudevant (q. v.), though wholly dissimilar to each other in the quality of their genius, are wofully alike in the baser element of the national fiction. Victor Hugo (q. v.) and Lamartine (q. v.) are indeed morally far above the rest of the French contemporaries, but they are perhaps the only great exceptions that can be mentioned. The 'Second Empire' has not improved the tone of the French novel, any more than it has improved the tone of society; but if it be true that when things have reached their worst they begin to mend, the country that has produced *La Dame aux Camélias* is perhaps, as regards the literature of fiction, in a hopeful condition.

The prose fiction of Spain and Italy during the 19th c. scarcely requires notice, as the former country has not produced a single work that has forced its way into the general European market, while the latter can boast of only one that has attained that dignity, the *Promessi Sposi* of Manzoni (q. v.); but in a comprehensive sketch like the present, it would be a blemish to omit at least the names of the more eminent Transatlantic novelists, as they have contributed not a little of late years to the stock of English prose fiction. The most notable are Brockden Brown (q. v.), the American Godwin; Fennimore Cooper (q. v.), from whom Europe has been content, on the whole not unwisely, to take its notions of the forests, the prairies, and the red men of the West; Washington Irving (q. v.), Edgar Allan Poe (q. v.), Nathaniel Hawthorne (q. v.), and Oliver Wendell Holmes (q. v.), in all of whose writings, except in the tales of Poe, is visible the influence of the life, traditions, scenery, and other salient characteristics of the New World. See Dunlop's *History of Fiction* (Lond. 1814).

NOVEMBER (Lat. *novem*, nine) was among the Romans the 9th month of the year, at the time when the year consisted of 10 months; and then contained 30 days. It subsequently was made to contain only 29, but Julius Cæsar gave it 31; and in the reign of Augustus the number was restored to 30, which number it has since retained. November was one of the most important months in connection with the religious ritual of the Romans, and continues in the same position, though for other reasons, in the Roman Catholic ritual. It was known among the Saxons as *Blot-monath*, 'blood-month,' on account of the general slaughter of cattle at this time, for winter provision (known for a long time afterwards as *Martinmas beef*) and for sacrifice. This custom

was not confined to the Saxons, but prevailed in Northern Germany, and even as far south as Spain.

NOVGOROD, an important town of European Russia, capital of the government of the same name, is situated on the Volkhof, near where it issues from Lake Ilmen, 122 miles south-south-east of St Petersburg. It is the cradle of Russian history. In 862, the Norman prince Rurik, of the tribe of Variago-Ross (whence the name *Russia*), was invited hither by the neighbouring tribes, and from him begins the history of the country, and the line of its sovereigns. A monument, commemorative of this event, was erected here, with great pomp, in September 1862. In the 9th c., Oleg, the successor of Rurik, transported the capital to Kief; but bestowed many privileges and liberties upon N., and from that time it began to prosper. The greatness of N. provoked the jealousy of the princes of Moscow, and in 1471, the czar Ivan III. nearly destroyed the town, bereft it of its liberties, and exiled the most influential citizens. During the time of its prosperity, the town was called Novgorod the Great; and had 400,000 inhabitants, and extended its sway to the White Sea and the river Petchora. Its government was a sort of republic, the prince being less a sovereign than the chief commander of the troops. Its greatness was due to its vast foreign trade alone, and when Archangel was opened for English trading vessels, but especially after the foundation of St Petersburg, its trade fell away, and the town rapidly declined. Of the existing ancient buildings, the most remarkable are the Church of St Sophia, founded in the 11th c., possessing a fine old library, as well as some remarkable paintings and tombs; and the Kreml, in the steeple of which hung the famous bell used to summon the citizens for the deliberation of state affairs. Pop. 18,768.

NOVGORO'D, a government of Great Russia, extends immediately south-east of the government of St Petersburg. Area, 48,780 square miles; pop. 975,200. The surface is gently undulating, with the Valdai Hills in the south, which rise to about 300 feet, and may be said to form the water-shed between the Baltic, Caspian, and White Seas. The government contains many lakes and rivers; of the former, the lakes Ilmen and Bieloe are the largest; and of the latter, the Wolchof, Msta, Szekma, and Mologa are the most important. The rivers are connected by canals, which are of great service to trade. The soil, especially in the north-east, is not fertile, and the climate is severe; agriculture and cattle-rearing are carried on only to a limited extent. Forests and pasture-lands are numerous and extensive, and the timber and hay sent to the capital realize a considerable income. Quarries of the best stone for paving occur on the river Toana, and near Stara-Russa there are mineral and saline springs.

NO'VI, a town of northern Italy, in the division of Genoa, is a station on the railway from Turin to Genoa, and is 33 miles north-north-west of the latter city. It presents few attractions, with the exception of a number of picturesque old houses. It carries on a considerable transit-trade; and the silk produced in the vicinity is amongst the most celebrated in Italy. Pop. 10,800.

NO'VIBAZA'R, also **JENIBAZAR**, a town of Bosnia, European Turkey, situated on the river Rashka, an affluent of the Morava, 180 miles south-east of Boma-Serai. Several of the great roads of the country cross each other here. N. has celebrated fairs, important trade, and considerable wealth, but the houses are mostly of mud. It is the chief point of communication between Bosnia and the rest of Turkey. Pop. 15,000.

NOVITIATE, the time of probation, as well as of preparatory training, which in all religious orders precedes the solemn *Profession* (q. v.). Under the head of *MONACHUS* will be found the general principles by which the training for the 'religious' life is regulated. It will be enough to say here, that the novitiate in all orders must continue (Conc. Trid. Sess. xxv. c. 85, *De Regul. and Mon.*) at least one year. In most orders it is of two, and in several of three. Any attempt to solemnise the profession before the expiration of the novitiate, without a dispensation, is invalid. During the novitiate, the novices are immediately subject to a superior, called Master (or Mistress) of Novices. They are not permitted to engage in systematic study, their whole time being devoted to prayer, and to ascetic and liturgical training. During the novitiate, the novice continues free to withdraw, nor is he or she admitted to profession at the close of the novitiate, except after proof given of fitness, and of proper dispositions for the particular institute aspired to.

NOVOARKHANGHEL'SK (New Archangel), a seaport of Russian America, and centre of the administration of the Russo-American Company, situated on the island of Sitka, on the north-west coast of the American continent, in lat. 57° 3' N., long. about 135° W. It has a good port, and is the entrepôt of all the stores for the other Russo-American colonies, and of their produce, of which furs are the principal item. There are at N. only 66 clear days in the year. Mean temperature throughout the year 43° 48' F. Pop. 1000, mostly servants of the company.

NOVOMOSKO'VSK, an important market-town of South Russia, in the government of Ekaterinoslav, and 20 miles north-north-east of the town of that name, on the Samara, an affluent of the Dnieper. Three extensive fairs, chiefly for the sale of cattle and horses, are held here annually. The 'remounting' officers attend these fairs for the purpose of supplying their regiments with horses. Tanning and tallow-melting are carried on. Pop. 10,138.

NOVOTCHEBKA'SK, a town of Southern Russia, capital of the territory of the Cossacks of the Don, on the Aksai, a tributary of the Don, at a distance of 12 miles from its right bank, and about 70 miles east-north-east of Taganrog. The central administration of the territory was transferred hither from Toherkaak in 1804 by Count Platof, commander-in-chief of the Cossacks. The choice was not a happy one, the distance of the town from the Don, the great commercial artery, being much felt. In 1853, a statue was erected in memory of Count Platof, who achieved an illustrious name by his military exploits from 1770 till 1816, and especially during the French invasion in 1812. Pop. 19,500, who carry on trade and manufactures, agriculture, cattle-breeding, fishing, and wine-growing.

NOYADES (i. e., 'Drownings,' from Fr. *noyer*, to drown), the execution of political offenders in great numbers at once by drowning them, one of the atrocities of the French Revolution, practised at Nantes by Carrier, the deputy of the Convention. See **CARRIER**. This mode of execution was also called, in cruel sport, *Vertical Deportation*.

NOYAU. See **LIQUEUR**.

NOYON, a town of France in the department of Oise, 78 miles north-north-east of Paris by the northern railway. It has a fine cathedral of the 12th and 13th centuries, in the Romanesque style of architecture; an episcopal palace, and some linen

and cotton manufactures. Pop. 5593. N. was a residence of Charlemagne, and the place where Hugo Capet was crowned king of France in 987. It is also noted as the birthplace of John Calvin.

NU'BIA, the modern appellation of a country subject to the pasha of Egypt, extending from Philæ to the Sennaar, lat. 18° S., bounded on the E. by the Arabian Gulf, N. by Egypt, S. by Abyssinia, and on the W. by the Desert. It appears to have been anciently known as Ethiopia. The ancients gave the name of Ethiopia to the west bank of the Nile from Meroe to the bend of the river. The name seems to have been derived from the Egyptian and Coptic *Noub*, or Gold, a name still retained in *Wady Nouba*, which extends from the frontier of Dongola, north of the *Wady Seboua*, above Derri. The tract between Seboua and Assouan is called the *Wady Kenous*. Diocletian removed hither a Lybian tribe, called *Nobata*, to the district above Syene to oppose the *Blemmyes*, who inhabited the western desert, now held by the *Ababde* and *Bisharein* Arabs. The dominion of the Pharaohs, when most extended, reached to the Isle of Argo, the last place where the monuments of the Egyptians have been found. Under these monarchs it was called *Cush*, and was governed by a royal scribe, entitled Prince of *Cush* or *Ethiopia*, till the twentieth dynasty, when it appears to have been recovered by a series of native rulers, who ultimately conquered Egypt; and although driven back, finally extended their rule from Meroe to Syene, the most southern city held by the Egyptian monarchs, the Ptolemies, and the Romans. These Ethiopians adopted the civilisation of the Egyptians, and the names of some of their monarchs have been preserved. The subsequent fortunes of this country will be seen under ETHIOPIA. The modern inhabitants consist principally of Arabs, who invaded the country after the rise of Mohammed, the principal tribes being the *Djowabere* and *El Gharbye*, who inhabit from Assouan to the *Wady Halfa*; the *Kenous*, *Djaafere*, and others, a branch of the *Koreish*, who occupied the land from *Ene* to *Assouan*. By the aid of *Boesian* soldiers, the *Djowabere* were driven into *Dongola* in the reign of *Selim*, and their descendants still flourish at *Ibrim*, *Assouan*, and *Sai*. Lower down, inhabit a race called the *Berbers* or *Barabras*; south of *Cosseir* are the *Ababde*. From *Dongola* and *Sennaar*, a negro state, the people are called *Noubas*, a hardy race, differing from the pure blacks; but the country throughout is inhabited by mixed races of Arabian and *Nigritic* blood. Another tribe, the *Sheyya*, east of *Dongola*—a fine black race, addicted to horsemanship and war—are still more interesting. The *Ababde* Arabs are renowned as guides and camel drivers; the *Bisharein* are supposed by some to be the ancient *Blemmyes*, a tribe living on flesh and milk, but without the oriental jealousy of the Arabs; the *Takas*, supposed to be the ancient *Bojahs*, dwell in the mountains. Three principal languages are spoken by these various tribes—the *Nuba* by the *Berbers*, who entered from the south-west; the *Kungara*, a *Nigritic* dialect, by the negroes of *Dafur*; and the *Bisharia*, said to exhibit *Aryan* affinities. The inhabitants, although less in stature than the Egyptians, are in the better parts of the country a fine muscular race; the women are pleasing, but not beautiful; and the climate is remarkably healthy. In their political government they were governed by their own chiefs, *maks* or *malechs*, till they were subdued by *Ismael Pasha*, in 1820, to the sway of Egypt, and the civil government is now administered by the Turks. The country is arid, in many places only cultivable at the

sides of the Nile, and consists of granite and sandstone. The soil raises *durra*, cotton, and date palms. It is traversed by the *Bahr el Azeq*, or Blue Nile, and the *Bahr el Abiad*, or White Nile. The products are numerous, comprising maize, dates, tamarinds, gums, aloes, civet, musk, wax, myrrh, frankincense, senna, black wool, hides both of the elephant and rhinoceros, and their ivory, ostrich feathers, ebony, gold dust, saltpetre, salt, tobacco, coffee, cotton, which are carried by way of commerce to Egypt. The taxes are rated by the number of water-wheels for the irrigation of the land. There being no native currency, the coins of Egypt and Europe, especially the Spanish dollar, are received, but glass-beads, coral, cloth, *tobe* or shirts, and cloth (*samoor*) also pass as money. In *Kordofan*, value is reckoned by cows. The most primitive modes of measurement are in use, maize being sold by the handful (*selga*), 18 of which go to a *moud*; and cloth being measured from the elbow to the fingers. Polygamy is general, and a wife at *Kenous* is purchased of her parents for 30 piastres; amongst the Arabs for 6 camels, 3 of which are returned to the bridegroom. Some of the tribes are jealous of their women, who are celebrated by travellers on account of their virtue. In their costume, they use turbans, linen, and woollen garments, and are armed with lance and shield, the latter made of the hide of the hippopotamus. No looms exist, but they plait neatly. Their chief musical instrument is a guitar of five strings, with sounding-board of a gazelle's hide. They are generally averse to commerce, eat little animal food, and are *Mohammedans*. Their houses are low huts of mud or stone. The chief attraction of this country to travellers is the numerous temples and other ancient remains of the Egyptians, extending from *Philæ* to the island of *Argo*. These consist of the temple of *Isis*, in the island of *Philæ*, founded by *Nectanebo I.*, and continued by the *Ptolemies*; the temple of *Deboud*, built in honour of *Amen Ra*, by *Ataramen*, and continued by the *Romans*; *Tafa* or *Taphis*, the modern *Kalabaha*, built by *Rameses II.*; the rock temple of *Beit e Welly*, recording the conquests of the same monarch; *Wady Halfa*, built by *Osertesen I.*; the rock temple of *Ibsamboul*, built by *Rameses II.*; *Gebel Addeb*, built by *Horus* of the eighteenth dynasty; *Ibrim*, built by *Amenophes II.*; *Amada*, founded by *Thothmes III.*; *Gherahch*, *Seboua*, and *Derri*, built by *Rameses II.*; *Dakkeh*, the ancient *Paelcis*, built by *Ergamenes*; and the *Colossus* of the island of *Argo*; the *Pyramids* of *Meroe* and *Tanquasi*.—*Burckhardt, Travels*; *Champollion le Jeune, Lettres Ecrites*, p. 107, and foll.; *Lepsius, Reise*, p. 107, and foll.).

NUCLEOBANCHIATA, or HETEROPODA, an order of gasteropods having the sexes distinct; the locomotive organ fin-like, single, and ventral; the gills packed in small compass along with the heart. They are all marine, and usually swim with the back downwards and the fin-shaped foot upwards. They adhere to sea-weeds by a small sucker placed on the fin. Some of them, as *Atlanta*, have a shell large enough to protect the body; some, as *Carinaria*, have a small shell covering the gills and heart only; and some, as *Fwola*, have no shell at all.

NU'CLEUS. See CELLA.

NUDIBRANCHIATA (Naked-gilled), an order of gasteropods, hermaphrodite, destitute of shell, and having the gills exposed on the surface of the body. The gills are differently situated in different genera. The genus *Doris* (q. v.) is an example of this order.

NUECES, a river of Texas, United States of America, rises in South-western Texas, lat. 30° long. 101° W., and after a south-easterly course of 300 miles, flows into Corpus Christi Bay, and through the Pass of the same name into the Gulf of Mexico.

NUISANCE is a legal term used to denote whatever is an annoyance to one's neighbours, or in a general sense to the public at large, in the exercise of their rights of property. The whole doctrine of nuisance is founded on the theory that every person is entitled to have the full use and enjoyment of his property, and of the right of passing to and fro on the highway without being interfered with or impeded by others, and whatever so impedes this full enjoyment of one's property and right of passage on the highway is a nuisance. Nuisances are thus capable of being divided into two kinds—private and public. Thus, if a neighbour leave a heap of rubbish emitting noxious smells close to A's windows, or make loud noises in his house, these may be said to be private nuisances, for they annoy A in the enjoyment of the fresh air and quiet which are part of his right of property. On the other hand, if something is put of the same kind on a public highway, or so as to annoy divers people equally and in the same manner, then it is called a public nuisance. One of the leading incidents of a nuisance is, that the party annoyed by it can in many cases, especially where the nuisance is injurious to health or life, take the law into his own hands and abate the nuisance without resorting to a court of law. The reason is, that the matter is of too urgent importance to await the slow progress of a suit at law, and mischief may be done in the meantime which would be often irreparable owing to the delay. Another important qualification of the right of abating a nuisance is, that the nuisance must be such that unless it is abated at once the party cannot exercise his legal rights; and hence if the nuisance is of such a kind that it does not directly interfere with the comfort or enjoyment of one's legal rights at the time, he has no right to abate it, but in that case is bound to resort to a court of law. This is best illustrated in the case of a nuisance on the highway, which is the class of cases in which the phrase a common nuisance is most familiarly known. Thus, if while A is riding or driving along the highway his progress is interrupted by a fence or gate which nobody has a legal right to put there, it is obvious that unless A can knock down or demolish at once this obstruction, he cannot proceed in the exercise of his legal right of using the highway. In such a case he has a right to demolish the gate and abate the nuisance, for it directly interferes with his own legal right. But if instead, a gate, a booth, or tent had been erected, not across the highway, but merely on one side of it, so as to leave room for passengers to pass, then though such tent or booth would be as undoubted a nuisance as in the other case, yet inasmuch as A can pass without direct interference, he has no right to abate the nuisance by destroying the tent. He must, in this latter case, resort to the legal remedy only. The same rule applies to all kinds of nuisances.

Another rule is, that in abating a nuisance the party is not to do unnecessary damage to property, i.e., more than simply abate the nuisance to such an extent as to enable himself to exercise his legal right, and no further. If he go beyond the immediate occasion, and cause unnecessary destruction to property, then he subjects himself to an action of damages. Hence it is often a difficult thing to know when one is justified in abating a nuisance and taking the law into his own hands.

Where the nuisance is sought to be removed by

legal means, then the remedy is in some cases two-fold, and in some cases not so. Where the nuisance is of a private nature, an action of damages is in general the only remedy given by the common law. But where the nuisance is public, and affects all the public equally, or nearly so, then in general either an action may be brought, or an indictment will lie. Thus in case of a nuisance on a highway, as this affects all the lieges alike, an indictment is the proper remedy, though if an individual suffered special damage over and above what he suffers as one of the public, then he may bring an action. In Scotland, instead of an indictment, an action in the nature of a public action is raised, which is substantially similar in its results to an indictment.

As will be seen from what has preceded, the legal remedy in cases of nuisances has long been felt to be insufficient. To add to the other defects, there is great difficulty in determining whether a particular mode of using one's premises is in the nature of a nuisance or not; for if the line is drawn too narrowly, the rights of property and the natural freedom of the subject may be interfered with. On the other hand, things which formerly were considered no nuisances are now treated as such, owing to the spread of more enlightened views of public health and habits of cleanliness. These considerations recently induced the legislature to alter the common law in an important degree, and substitute a new code under the name of the Public Health and Nuisances Removal Acts, 11 and 12 Vict. c. 63; 18 and 19 Vict. c. 116; 23 and 24 Vict. c. 77. The general scheme of these acts is to enable districts to appoint local boards, with extensive powers of self-government, and to undertake and execute sanitary improvements, such as drainage and water-supply on a large scale, paying for the expense thereof by a local rate or assessment.

As regards the power of removing nuisances, a statute was passed in 1855 for England, called the Nuisances Removal Act, which has been amended by two subsequent acts. By these acts, some local board or local officers, and failing them the overseers of the parish, are appointed the local authority for carrying out the provisions of the act, and these are of an extensive kind. The act defines a nuisance to include any premises in such a state as to be a nuisance or injurious to health; any pool, ditch, gutter, water-course, privy, urinal, cess-pool, drain, or ash-pit, so foul as to be a nuisance or injurious to health; any animal so kept as to be a nuisance, or injurious to health; and any accumulation or deposit which is a nuisance or injurious to health. The local authority is to appoint a sanitary inspector at a proper salary. Any person aggrieved may give notice to the local board, or the sanitary inspector may do so. The local board has extensive powers; it can authorise its inspector, on reasonable complaint, to demand an entrance into any private premises so as to inspect their condition, and may order the removal of nuisances found to exist there. The local board, on finding a nuisance exists, direct their officer to go before a justice of the peace and procure an order directing the private party to abate the nuisance. If he refuse to do so, the local board may remove the nuisance at the expense of the party on whose premises it exists, and sue him for such expenses. If any candle-house, melting-house, soap-house, slaughter-house, or place for boiling offal, blood, bones, &c., be certified by the medical officer, or any two medical practitioners, to be a nuisance, or injurious to the health of the inhabitants of the neighbourhood, the local board may cause the person carrying on such trade to appear before a justice of the peace, and if it is not satisfactorily

proved that he does not use the best practicable means for preventing or counteracting the effluvia, he is fined. So if houses are overcrowded, this may be stopped. Provisions are also enacted with a view to prevent the spread of diseases in times of epidemics, and to prevent common lodging-houses being kept in a foul state. Another important provision relates to the seizure of diseased meat and provisions exposed to sale, and the medical officer of health, or inspector of nuisances, has at all times power to inspect any animal, carcase, meat, poultry, game, flesh, fish, fruit, vegetables, corn, bread, or flour; and if found unfit for food, or diseased, or unsound, they may be carried away then and there and destroyed, and the shopkeeper fined. The local authority may also order owners of houses to supply proper water-closets, and to cleanse gutters and cess-pools which are foul. Besides the above provisions as to nuisances generally, there are separate statutes which prohibit smoke nuisance in the English metropolis and the river Thames. Thus all the furnaces in mills, factories, printing-houses, dye-houses, distilleries, glass-houses, bakehouses, &c., within the metropolis, must be so constructed as to consume their own smoke, and also any noxious or offensive effluvia arising from any trade is prohibited. These statutes are the 16 and 17 Vict. c. 128, and 19 and 20 Vict. c. 107.

In Scotland, a Nuisances Removal Statute was passed the year following the English act, viz., 19 and 20 Vict. c. 103. By that act the town council, or police commissioners of the place, were constituted the local authority for enforcing the act, and in other places the parochial board. Besides dealing with the same class of nuisances as the English act, the Scotch act provided for checking all trades and businesses offensive and injurious to the health of the neighbourhood. Similar powers were given to the local board to enter private houses and explore the causes of nuisances. Diseased and unwholesome meat and provisions may also be seized. Common lodging-houses were to be registered, and to be subject to rules and regulations to be made by the local authority. With regard to towns in Scotland, an extensive code of police laws was enacted in a general statute, the General Police and Improvement Scotland Act 1862, 25 and 26 Vict. c. 101. That act may be adopted by burghs; and villages above 700 of population may, by vote of householders, be converted into burghs for this purpose. A Smoke Nuisance Act for Scotland was passed applicable to all burghs, 20 and 21 Vict. c. 13; 24 Vict. c. 17.

The above is the usual legal acceptation of the term nuisance, but the word is sometimes used popularly to denote that class of nuisances, caused by disorderly houses or brothels, which are familiarly described as common nuisances. In the law of England those who keep a brothel are liable to be indicted for a misdemeanour, but as there was often a difficulty in setting the law in motion in such cases, a statute of 25 Geo. II. c. 36, enacted that if any two inhabitants should give notice to a constable of such a house being kept, it should then be the duty of the constable under a penalty, to go with such inhabitants before a justice and engage to prosecute the keeper, and their expenses are paid by the parish out of the poor-rates. The same act provided that whoever in point of fact acted as the master or mistress of the house, should be taken to be the keeper of the house. The punishment is fine and imprisonment. Of late an attempt has been made to convict a landlord under this statute when he knows of the character of his tenants, and refuses to give them notice to quit; but the courts have held that the mere fact of the

landlord refusing to give notice to quit, and so to eject such tenants, was not enough to make him liable in any criminal punishment. In Scotland, the offence of keeping a brothel is punishable in a similar manner. But apart from the keeping of a brothel, there is no criminal offence committed in this country by those who frequent such houses for the purposes of prostitution unless where the circumstances amount to Rape (q. v.) or Abduction (q. v.), or an aggravated assault.

NULLA BONA, a legal phrase in England, descriptive of the return made to a sheriff, who in executing process against a debtor finds he has no goods.

NUMA POMPILIUS, in the mythic history of Rome, was the successor of Romulus, the founder of the city. He was a native of Cures in the Sabine country, and was universally revered for his wisdom and piety. Unanimously elected king by the Roman people, he soon justified by his conduct the wisdom of their choice. After dividing the lands which Romulus had conquered, he proceeded, with the assistance of the sacred nymph Egeria, to draw up religious institutions for his subjects, and thus stands out in the primitive legend as the author of the Roman ceremonial law. His reign lasted for 39 years, and was a golden age of peace and happiness. The only feature in the myth of N. P. which we can regard as probably historical, is that which indicates the infusion of a Sabine religious element into Roman history at some remote period.

NUMANTIA, the chief town of the Celtiberian people called Arevaci in ancient Spain, was situated on the Douro (Durius), in the neighbourhood of the present Soria in Old Castile. The site is probably marked by the present Puente de Guarray. N. is celebrated for the heroic resistance which it made to the Romans, from 153 B.C., when its citizens first met a Roman army in battle, to 134 B.C., when it was taken and destroyed by Scipio the younger, after a siege of 15 months, in the course of which famine and the sword had left alive very few of its 8000 brave defenders. The besieging force under Scipio amounted to 60,000 men.

NUMBERS, THEORY OF, the most subtle and intricate, and at the same time one of the most extensive, branches of mathematical analysis. It treats primarily of the forms of numbers, and of the properties at once deducible from these forms; but its principal field is the theory of equations, in as far as equations are soluble in whole numbers or rational fractions, and more particularly that branch known as Indeterminate Equations. Closely allied to this branch are those problems which are usually grouped under the Diophantine Analysis (q. v.), a class of problems alike interesting and difficult; and of which the following are examples: 1. Find the members the sum of whose squares shall be a square number; a condition satisfied by 5 and 12, 9 and 15, 9 and 40, &c. 2. Find three square numbers in arithmetical progression; Answer, 1, 25, and 49; 4, 100, 196, &c.

Forms of Numbers are certain algebraic formulas, which, by assigning to the letters successive numerical values from 0 upwards, are capable of producing all numbers without exception, e.g., by giving to m the successive values 0, 1, 2, 3, &c., in any of the following groups of formulas: $2m$, $2m + 1$; $3m$, $3m + 1$, $3m + 2$; $4m$, $4m + 1$, $4m + 2$, $4m + 3$, we can produce the natural series of numbers. These formulas are based on the self-evident principle, that the remainder after division is less than the divisor, and that, consequently, every number can be represented in the form of the product of two factors + a number less than the smaller factor.

By means of these formulas, many properties of numbers can be demonstrated without difficulty. We give a few examples. (1) *The product of two consecutive numbers is divisible by 2*: Let $2m$ be one number, then the other is either $2m + 1$ or $2m - 1$, and the product $2m(2m \pm 1)$ contains 2 as a factor, and is thus divisible by 2. (2) *The product of three consecutive numbers is divisible by 6*: Let $3m$ be one of the numbers (as in every triad of consecutive numbers one must be a multiple of 3), then the others are either $3m - 2, 3m - 1; 3m - 1, 3m + 1; 3m + 1, 3m + 2$. In the first and third cases, the proposition is manifest, as $(3m - 2)(3m - 1)$, and $m + 1)(3m + 2)$, are each divisible by 2, and therefore their product into $3m$ is divisible by $(= 1.2.3)$. In the second case the product is $m(3m - 1)(3m + 1)$, or $3m(9m^2 - 1)$, where 3 is a factor, and it is necessary to show that $m(9m^2 - 1)$ is divisible by 2; if m be even, the thing is proved; if m be odd, then m^2 is odd, $9m^2$ is odd, and $9m^2 - 1$ is even; hence, in this case also the proposition is true. It can similarly be proved that the product of four consecutive numbers is divisible by $24 (= 1.2.3.4)$, of 5 consecutive numbers by $20 (= 1.2.3.4.5)$, and so on generally. These propositions form the basis for proof of many properties of numbers, such as that the difference of the squares of any two odd numbers is divisible by 8, the difference between a number and its cube is the product of three consecutive numbers, and is consequently (see above) always divisible by 6. Any prime number which, when divided by 4, leaves a remainder unity, is the sum of two square numbers: thus, $41 = 25 + 16 = 5^2 + 4^2$, $223 = 169 + 64 = 13^2 + 8^2$, &c.

Besides these, there are a great many interesting properties of numbers which defy classification; such as, that the sum of the odd numbers beginning with unity is a square number (the square of the number of terms added), i. e., $1 + 3 + 5 = 9 = 3^2$, $1 + 3 + 5 + 7 + 9 = 25 = 5^2$, &c.; and, the sum of the cubes of the natural numbers is the square of the sum of the numbers, i. e., $1^3 + 2^3 + 3^3 + 4^3 + 5^3 + 6^3 = (1 + 2 + 3 + 4 + 5 + 6)^2 = 21^2 = 441$, &c.

We shall close this article with a few general remarks on numbers themselves. Numbers are divided into *primes* and *composite*—prime numbers being those which contain no factor greater than unity; composite numbers, those which are the product of two (not reckoning unity) or more factors. The number of primes is unlimited, and so consequently are the others. The product of any number of consecutive numbers is even, as also are the squares of all even numbers; while the product of two odd numbers, or the squares of odd numbers, are odd. Every composite number can be put under the form of a product of powers of primes; thus, $144 = 2^4 \times 3^2$, or generally, $n = a^p \cdot b^q \cdot c^r$, where $a, b,$ and c are prime numbers, and the number of the divisors of such a composite number is equal to the product $(p + 1)(q + 1)(r + 1)$, unity and the number itself being included. In the case of 144, the number of divisors would be $(4 + 1)(2 + 1)$, or 5×3 , or 15, which we find by trial to be the case. *Perfect numbers* are those which are equal to the sum of their divisors (the number itself being of course excepted); thus, $6 = 1 + 2 + 3$, $28 = 1 + 2 + 4 + 7 + 14$, and 496, are perfect numbers. *Amicable numbers* are pairs of numbers, either one of the pair being equal to the sum of the divisors of the other; thus, $220 (= 1 + 2 + 4 + 5 + 10 + 11 + 20 + 22 + 44 + 55 + 110 = 284)$, and $284 (= 1 + 2 + 4 + 71 + 142 = 220)$, are amicable numbers. For other series of numbers, see FIGURATE NUMBERS.

The most ancient writer on the theory of numbers was Diophantus, who flourished in the 3d c., and the subject received no further development till the time of Vieta and Fermat (the latter being the author of several celebrated theorems, a discussion of which, however, is quite unsuited to this work), who greatly extended it. Euler next added his quota, and was followed by Lagrange, Legendre, and Gauss, who in turn successfully applied themselves to the study of numbers, and brought the theory to its present state. Cauchy, Libri, and Gill (in America), have also devoted themselves to it with success. The chief authorities down to the present century are Barlow's *Theory of Numbers* (1811), Legendre's *Essai sur le Theorie des Nombres* (third ed. Paris, 1830), and Gauss's *Disquisitiones Arithmeticae* (Brunswick, 1801; Fr. translation, 1807); and for the latest discoveries, the transactions of the various learned societies may be consulted.

NUMBERS (LXX. *Arithmoi*; Heb. *Bamidbar*), the fourth book of the Pentateuch, consists of 36 chapters, embracing the history of the march of the Israelites through the Desert, together with the special laws given during this period as complementary to the Sinaitic legislation. Beginning with the census of the people (whence the name of the book), and the assigning of the special places to each tribe with reference to the sanctuary, the whole people is classified, and the tribe of Levi specially singled out. Ordinances on the purity to be maintained in the camp, the functions of the priests, and a description of the passover, follow. The second portion of the book describes the journey from Sinai to the borders of Canaan, the miraculous sustenance of the people, their dissatisfaction and consequent rejection, together with various special laws respecting sacrifices, &c., and the episode of Korah. The third part embraces the first ten months of the fortieth year of the wandering—an epoch hurried over with remarkable swiftness by the historian. In quick succession, the renewed strife of the people with their leaders, the message to the king of Moab, the death of Aaron, the defeat of the king of Arad, the punishment of the people by serpents, the march from Hor to Pisga, and the victorious battle against the kings of Sihon and Og, are recounted, and the extraordinary episode of Balaam follows. The further wiles employed by the alarmed Moabites and Midianites to avert the threatening invasion, and their result, together with the second census, are narrated. Moses is warned of his death, and the vital question of his succession is settled. Further laws and ordinances respecting sacrifices and vows, the conquest of the Midianites, and the partition of the country east of the Jordan among certain tribes, a recapitulation of the encampments in the Desert, a detailed specification of the manner in which the promised land should be divided after its conquest, and the final ordinance of the marriages of heiresses among their own tribe only, so as to preserve the integrity of landed property, make up the remainder of the book.

The Book of Numbers is, like the rest of the Pentateuch, supposed by the greater part of modern critics to consist of several documents written by *Elohist*s and *Jehovist*s respectively. See GENESIS, PENTATEUCH.

NUMERALS, the general name given to figures or symbols by means of which numbers are expressed (for Roman and Greek numerals, see NOTATION); the distinctive name of *Arabic Numerals* being given to the nine figures or digits and the zero, that are now in almost universal use among civilized nations for this purpose. Both the origin of

NUMERATION—NUMIDIA.

these figures, and the period at which they became known in Europe, have been made subjects of laborious investigation; and it seems to be now proved beyond a doubt that they are of Indian not Arabic origin, and were invented by the Brahmans some time B. C. But the more important inquiry as to the time of their introduction into Europe has hitherto baffled all research. The simple and convenient theory, that they were introduced into Spain by the conquering Arabs, and from that country, then a great seat of learning, a knowledge of them was disseminated throughout Europe, is contradicted by the fact that the eastern Arabs themselves had no knowledge of them previous to the time of the Calif Al-Mamun (813—833), while a knowledge of them existed in Europe from a considerably earlier date. The most probable theory is, that they were brought from India, probably by the Neo-Pythagoreans, and introduced into Italy, whence they became known to a few of the learned men of Eastern Europe. We have, however, every reason to suppose that the figures then known were totally different in form from those now used. These latter, called *Gobar* by the Arabs, may have been brought to Bagdad during the reign of Al-Mansor (760), or his immediate successors, and certainly not later than the time of Al-Mamun. During the latter reign we know the present system of arithmetic was introduced into Persia from India, and most probably a knowledge of the Gobar figures at the same time. Thence the system of arithmetic was brought to north-western Africa and Spain, and doubtless the figures along with it, about the end of the 10th or beginning of the 11th century, and from Spain a knowledge of both was speedily communicated to the rest of Europe, the Gobar figures superseding those forms of Eastern figures which had previously been employed. The knowledge of the figures however spread, as was natural, much more rapidly than the notation and arithmetic of which they were the foundation, and we consequently find in writings and inscriptions of the middle ages the Gobar figures partly substituted for, and mixed up with, the Roman numerals; as, for instance, XXX2, for 32; X4, for 14, &c.; and occasionally such expressions as 302, 303, for 32 and 33. The earliest work on modern arithmetic was published in Germany in 1390; it explained the decimal notation, and exemplified the elementary rules. The Arabic numerals were not generally introduced into England till the commencement of the 17th c., and it was long after that time before the decimal arithmetic became general. See a dissertation *Sur les Chiffres Indiens*, by M. Woepke, in the Asiatic journal.

NUMERATION, the reading off of numbers that are expressed by figures. As shewn in Notation (q. v.), the first figure on the right hand expresses units; the next, tens; the third, hundreds; and following the same nomenclature with the next three figures, we have the fourth expressing units of thousands; the fifth, tens of thousands; the sixth, hundreds of thousands. The seventh figure, in like manner, expresses units of millions; the eighth, tens of millions; and the ninth, hundreds of millions. When this method is consistently followed out, as is the case with French and other continental arithmeticians, the fourth period, or group of three figures, is denominated billions, the first figure of it

(the tenth from the extreme right) being, units of billions; the next, tens of billions; &c. Read in this way, the figures 56,084,763,204,504 express fifty-six trillions, eighty-four billions, seven-hundred-and-sixty-three millions, two-hundred-and-four thousands, five-hundred-and-four units. In Britain, there is a slight variation in the mode, the only effect of which is to render it a little more complicated: thus, after units of millions, come tens and hundreds of millions, but then instead of billions we have, according to the current usage, thousands of millions; after this, tens of thousands of millions and hundreds of thousands of millions, and then billions, which occupy the 13th figure from the right, and are reckoned in the same way as millions, so that the next unit or *trillions* does not come in till the 19th figure. The above number, according to the British mode, would be read fifty-six billions, eighty-four thousand-seven-hundred-and-sixty-three millions, two hundred-and-four thousands, five-hundred-and-four units. The first method is perfectly symmetrical, keeping throughout to divisions of three figures; the second only keeps to this division up to hundreds of millions, when it changes it for a division into parcels of six figures, which are named from units up to hundreds of thousands of units. The latter mode is, however, gradually falling into disuse.

NUMIDIA (Gr. *Nomadia*, the land of Nomads), the name given by the Romans to a part of the north coast of Africa, corresponding to some extent with the modern Algiers. It was bounded on the W. by the river Mulucha (now *Moluya*), which separated it from Mauritania; on the E. by the river Tusca (now *Wadi-el-Berber*), which separated it from the territory of Carthage, the *Africa Propria* of the Romans; on the south, it reached to the chains of Mount Atlas and the *Lacus Tritonis*, which separated it from the land of the Gætulians and Interior Libya. The chief rivers were the Rubricatus and the Ampsaga. The inhabitants of N., as of Mauritania, belonged to the race from which the modern Berber are descended. They were a warlike race, and excelled as horsemen; but, like most barbarians, were faithless and unscrupulous. Of their tribes, the *Massyli* in the east, and the *Massylyli* in the west, were the most powerful. In the grand struggle between the Carthaginians and the Romans, they at first fought on the side of the former, but subsequently the king of the Eastern Numidians, Massinissa, joined the Romans, and rendered them effectual service in the war with Hannibal. Favoured by the conquerors, he united all N. under his sway. Of his successors in this kingdom, Jugurtha and Juba are the most famous. After the victory of Cæsar over Juba I., in the African war, N. became a Roman province (46 B. C.); but Augustus afterwards gave the western part—from the river Ampsaga, now *Wadi-el-Kibbir*—with Mauritania, to Juba II., and the name N. became limited to the eastern part; and when Mauritania became a Roman province, the western part was called Mauritania Cesariensis. Among the Roman *coloniæ* were Hippo Regius, near the mouth of the river Rubricatus; Cirta (the residence of the Numidian kings), afterwards called Constantina, a name still preserved in Constantine; Sicca, and Rusicada. For the modern history of N. see ALGIERA.

END OF VOL. VI.

Edinburgh:
Printed by W. and R. Chambers.

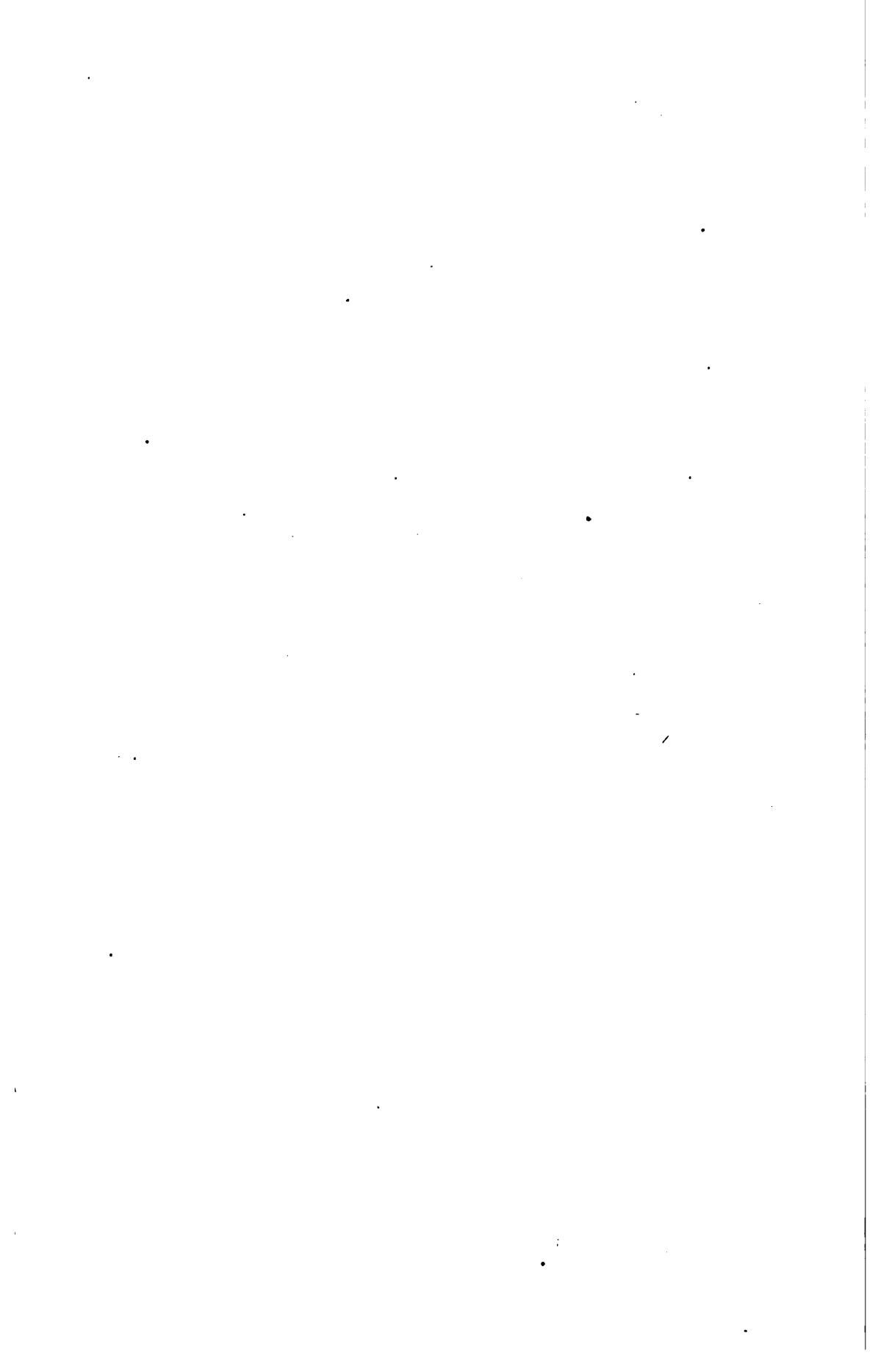

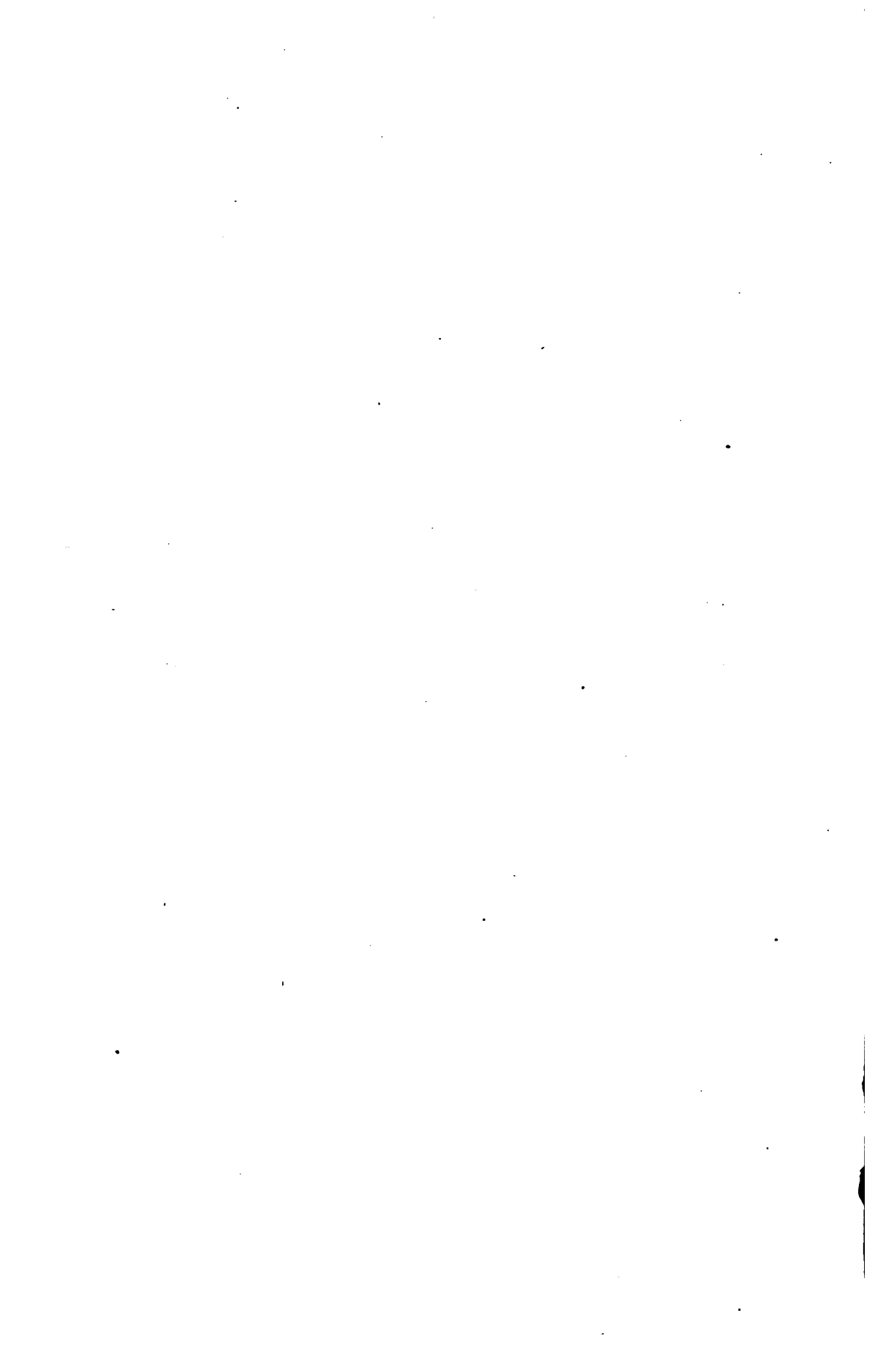



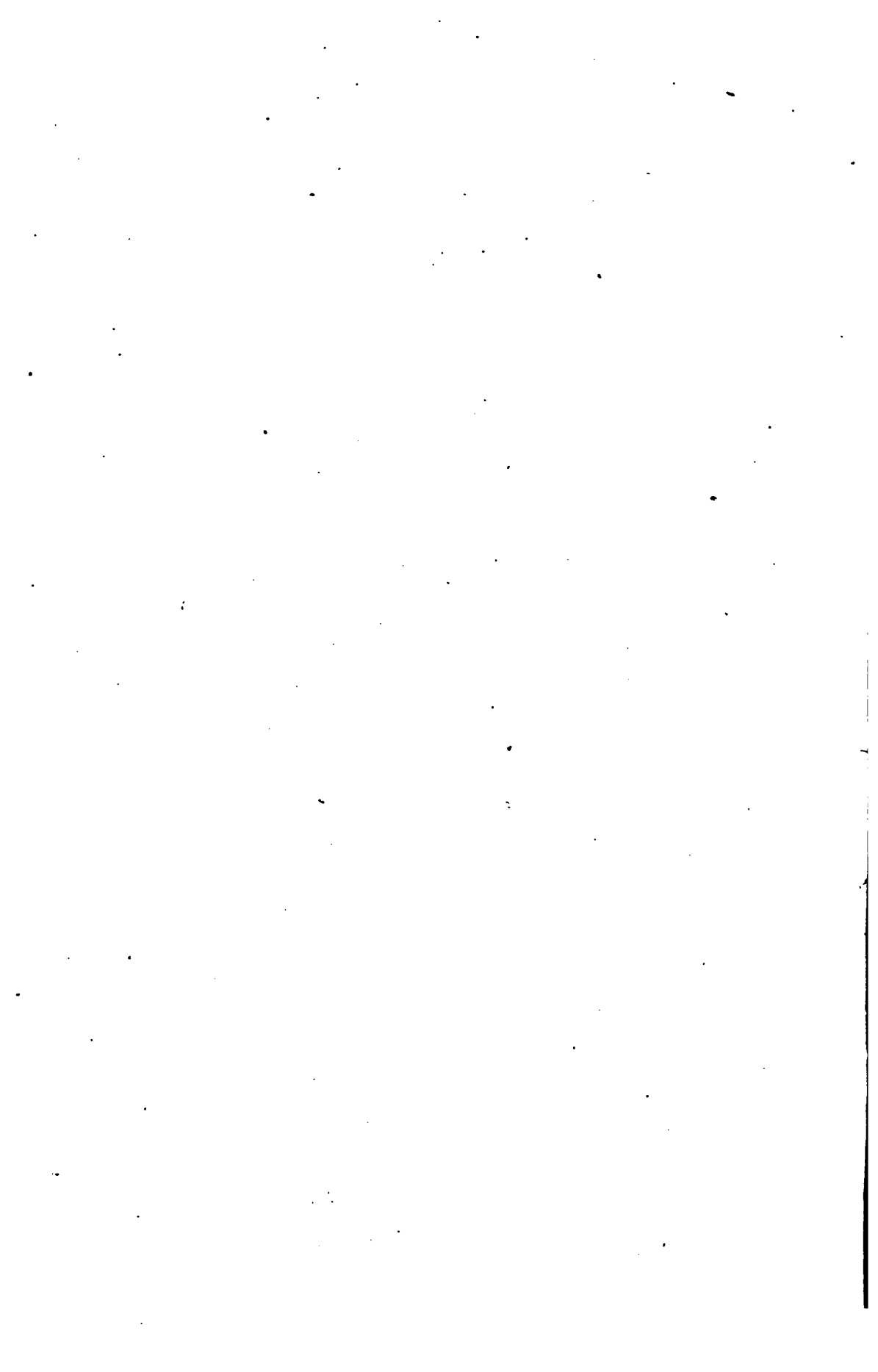

89094371754



B89094371754A

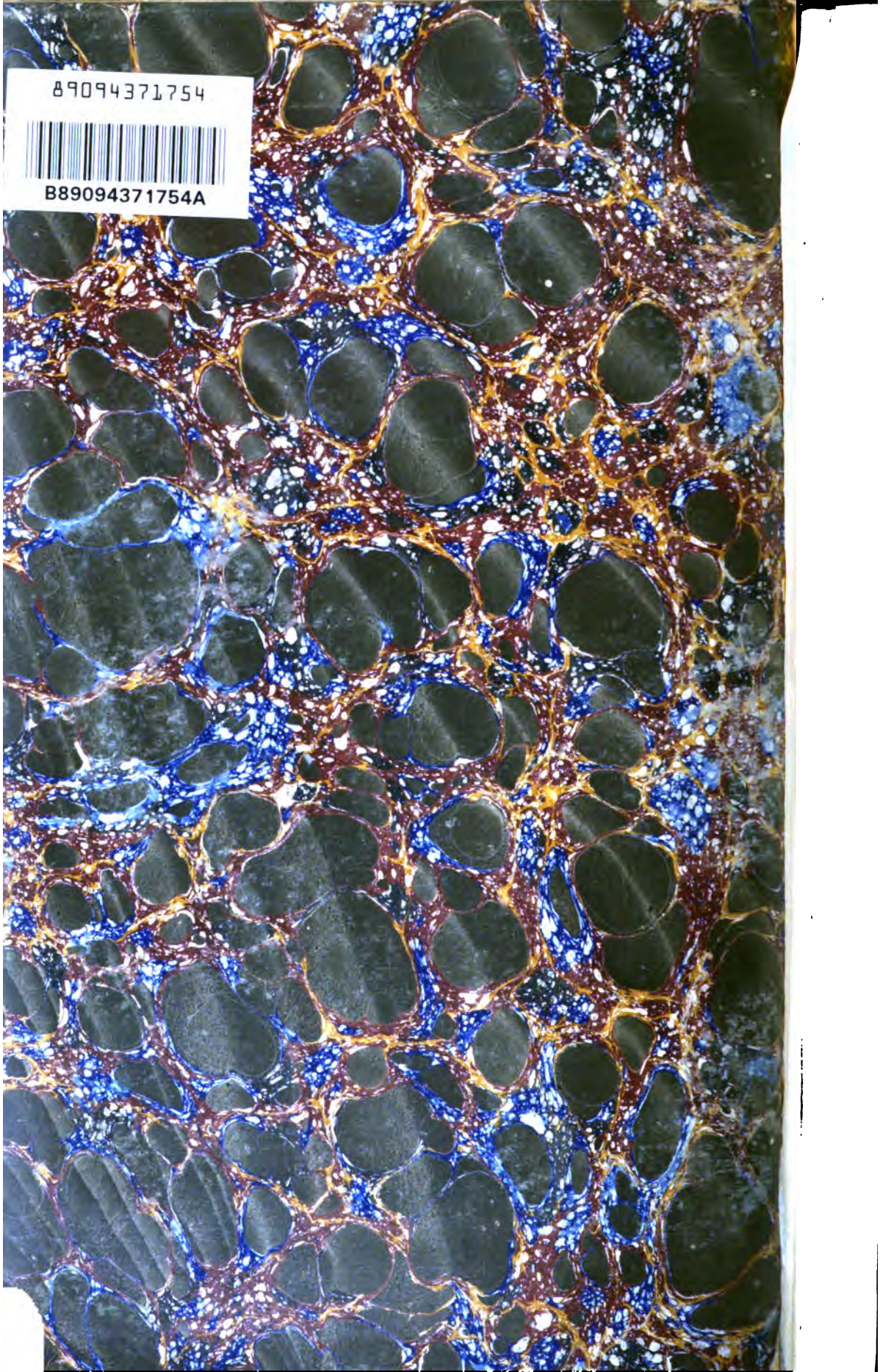

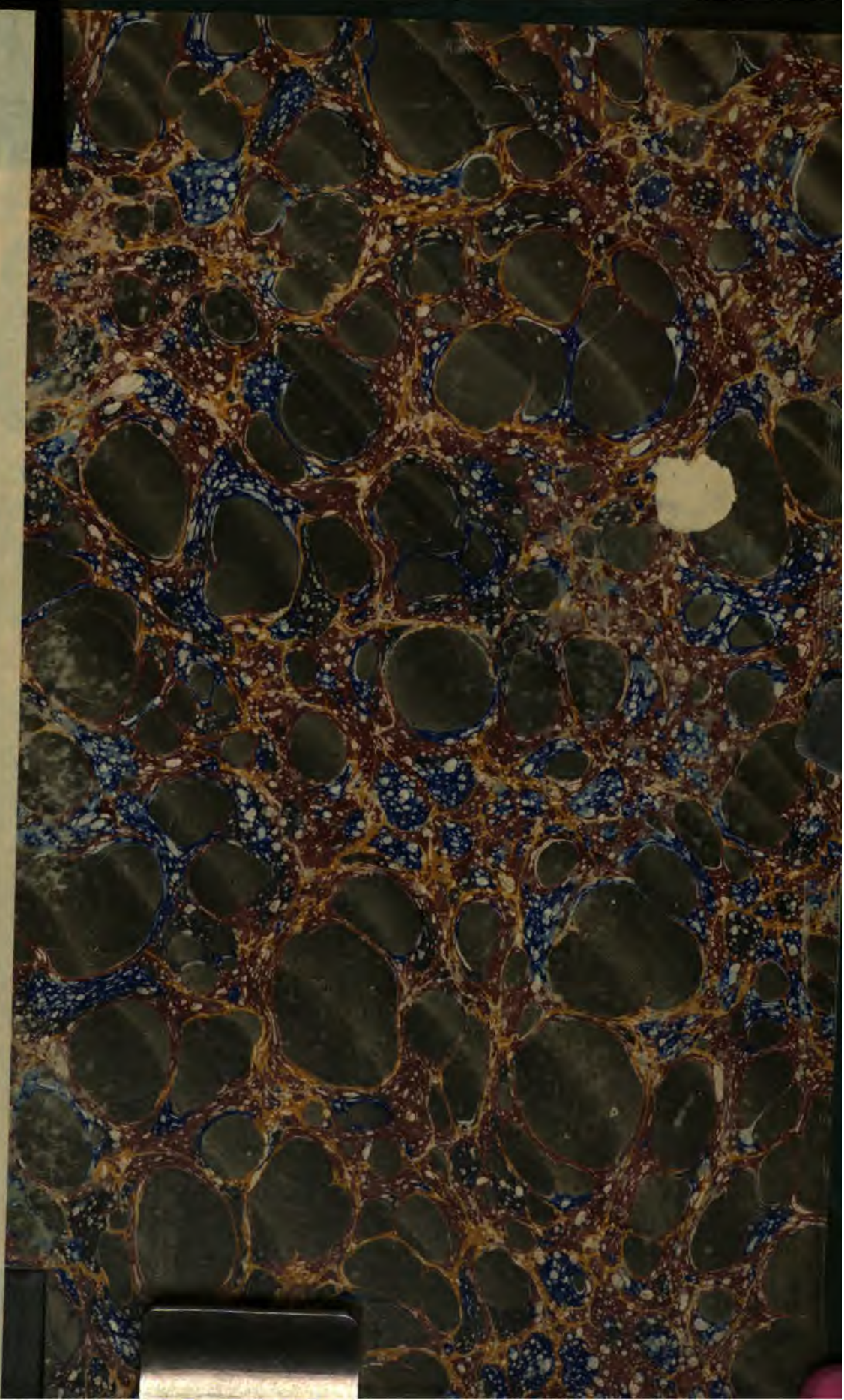

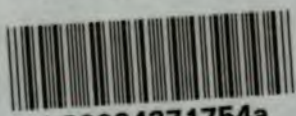

b89094371754a