

EX LIBRIS

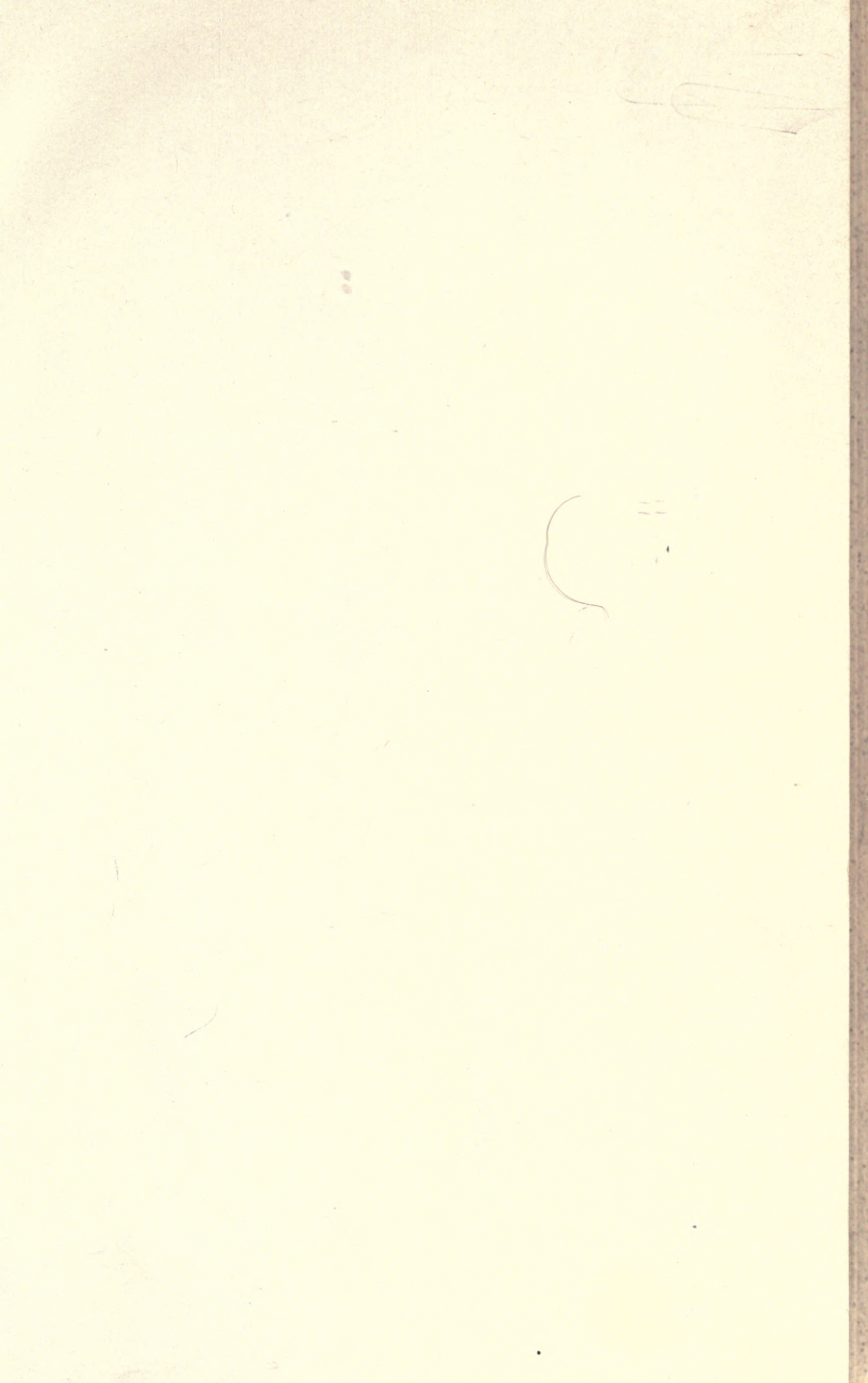





CHEMISTRY OF PULP AND PAPER MAKING

BY
EDWIN SUTERMEISTER, S. B.

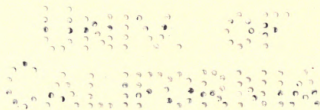

NEW YORK
JOHN WILEY & SONS, INC.
LONDON: CHAPMAN & HALL, LIMITED
1920

2/2/21

TS 1105
S85

COPYRIGHT, 1920
BY
EDWIN SUTERMEISTER *

TO YVU
AIRBORNE

Manufactured in the U. S. A.

PREFACE

The preparation of this book was undertaken because it was felt that there was need of a work dealing primarily with the chemical aspects of the pulp and paper industry and embodying under one cover the results of recent investigations along this line. The endeavor has been to include all details which the chemist should have to enable him to grasp the methods of manufacture, but it is not intended to be a treatise on paper making in all its mechanical phases, and in fact the mechanical features of the industry are discussed only in so far as they are necessary for a satisfactory understanding of the chemistry involved. It has been written chiefly with the idea of helping the young technical man, whether chemist or chemical engineer, and it has therefore been assumed that the reader has a fair knowledge of the elements of chemistry. At the same time it has been attempted to write as simply and plainly as possible and it is believed that any one connected with the pulp and paper industry will find it helpful and suggestive.

The subject matter has been collected from personal notes and experiences during the author's twenty years' service as chemist in the industry, as well as from a careful review of the literature relating to the subject. The latter is often contradictory in the extreme and in certain cases it has proved almost impossible to reconcile conflicting statements. In such cases both sides of the argument have been presented as fairly as possible. It is peculiar to the industry that there are usually a large number of variable factors which influence any one operation, and since it is practically impossible to control all of these variables it necessarily follows that results in different mills will not be in harmony. For this reason it is expected that the observant reader will find statements to which he

will take exceptions, but such differences of opinion are often desirable since they indicate lines of investigation which will lead to a better understanding of many things which are at present obscure.

Regarding the methods of analysis and testing which are given it may be said that the attempt has been made to include all which are necessary for routine work in controlling operations. There are many occasional analyses which it is necessary to make during special investigations, but it is impractical to include all of these and for such methods reference must be made to the numerous standard text-books of analytical procedure.

Acknowledgment is made of the assistance of Mr. J. L. Merrill on the subject of "Straw" and also of that of my associates at the mills of S. D. Warren Company, whose encouragement has helped to overcome many difficulties.

I am also indebted to the publishers of Van Nostrand's Chemical Annual for a number of the tables which will be found in the appendix.

CONTENTS

	PAGE
CHAPTER I	
CELLULOSE.....	I
Physiological and Physical. Composition and Constitution. Cellulose and Water. Solvents. Cellulose and Salts. Decomposition by Acids, Alkalis, Oxidants, Ferments and Heat. Compounds, Nitrates, Gun-Cotton, Nitrites, Acetates, Sulphuric Esters. Mixed Esters, Benzoates, Formates, Alkali-Cellulose. Sulpho-Carbonates. Groups of Celluloses. Compound Celluloses. Methods of Determination.	
CHAPTER II	
FIBROUS RAW MATERIALS.....	34
The Vegetable Cell. Seed Hairs. Bast Fibres. Fibres from Whole Stems. Woods. Length of Fibres. Densities and Composition of Woods. Bark and Knots. Decay. Woods used in Pulp Making. Bulk of Raw Materials.	
CHAPTER III	
RAGS, ESPARTO, STRAW, BAMBOO.....	68
Grades of Rags. Dusting. Boiling. Boilers. Losses. Esparto. Cleaning. Boilers. Cooking. Bleaching. Alkali Recovery. Straw. Composition. Cooking with Lime. Soda Cooks. Bamboo. Sources. Analyses. Cooking. Fibres from Old Papers.	
CHAPTER IV	
THE SODA PROCESS.....	93
Raw Materials. Digesters. Causticizing. Lime Mud. Cooking Liquor. Boiling. Effect of varying Steam Pressure, Strength of Cooking Liquor, Alkali Added, and Time of Cooking, Speed of Reaction. Soda Consumption. Yields. Modified Processes. Relief gases. Blow Tanks. Wash Pits and Washing. Black Liquor. Recovery of Soda. Evaporators. Incinerators. Black Ash Waste. Losses. Tests and Analyses.	
CHAPTER V	
THE SULPHATE PROCESS.....	141
Kraft Fibre. Cooking. Liquor Composition. Yields. Odors. Blow-off Gases. Black Liquor. Soda Recovery. Smelting. Composition of Melt. Tests and Analyses.	

	PAGE
CHAPTER VI	
THE SULPHITE PROCESS	156
Theory. Wood and its Preparation. Liquor Making. Sulphur Burning. Burning Pyrites. Absorption Apparatus. Quality of Lime Desired. Losses. Composition of Acid. Storage. Digesters and Linings. Boiling. Mitscherlich Process. Ritter-Kellner Process. Records and Charts. Relieving Gas. Following the Progress of a Cook. Recovery of Gas. Blowing the Charge. Washing. Composition of Products. Modified Processes. By-products and Waste Liquor. Tests and Analyses.	
CHAPTER VII	
GROUND WOOD OR MECHANICAL PULP	212
Outline of Process. Grinders. Factors Influencing Results. Steamed Wood. Woods Available. Enge Process. Examination of Product. Bleaching.	
CHAPTER VIII	
BLEACHING	225
Properties of Chlorine. Gas Bleaching. Hypochlorites. Bleaching Powder and its Solutions. Electrolytic Bleach. Principles of Bleaching. Weight of Fibre Lost on Bleaching. Change in Color on Bleaching. Use of Backwater. Bleaching Systems. Ground Wood. Antichlors. Washing Bleached Pulp. Permanganate Bleaching. Effect on Strength and Chemical Properties of Stock. Testing Bleaching Powder.	
CHAPTER IX	
SIZING	257
Necessity for Sizing. Surface Sizing. Gelatine and its Testing. Starch. Rosin. Source and Properties. Size Making. Reactions of Sizing. Rosin Required. Defects in Rosin Sizing. Testing Rosin and Sizes. Alum. Preparation. Composition. Testing. Casein Sizing. Glue Sizing. Rubber Resins. Mitscherlich Process.	
CHAPTER X	
LOADING AND FILLING MATERIALS	290
Reason for Using. Effect on Sizing. Qualities Desired. Retention. Clay. Gypsum. Pearl Hardening. Precipitated Chalk. Talc. Asbestine. Heavy Spar. Testing.	
CHAPTER XI	
COLORING	306
Importance. Pigments. Natural Mineral Colors. Artificial Mineral Colors. Natural Organic Colors. Artificial Organic Colors. Union of Dye and Filler. Effect of Water on Dyes. Direct Cotton Colors. Basic Colors. Eosines and Rhodamines. Acid Colors. Organic Pigments. Calender Staining. Testing Colors.	

CHAPTER XII

	PAGE
COATED PAPERS.....	325
Advantages and Disadvantages. Body Stock. Applying the Coating. Influence of Adhesives. Finishing Coated Papers. Glue Requirements for Coating. Casein, Source and Composition. Solvents. Preservation of Solutions. Testing. Albumen. Starch. Modified Starches. Clay. Blanc Fixe and Barytes. Satin White. Accessories.	

CHAPTER XIII

WATER.....	351
Importance in Paper Making. Classification and Sources. Color. Boiler Scale Formation. Water Softening. Filtration. Methods of Sampling and Analysis.	

CHAPTER XIV

TESTING WOOD PULPS.....	368
Moisture in Baled Pulps. Lap Pulp. Strength or Beating Test. Color Comparison. Bleaching Properties. Loss in Weight on Bleaching. Sedimentation Test.	

CHAPTER XV

PAPER TESTING.....	386
Microscopic Examination. Fibre Content. Unbleached Sulphite. Physical Tests. Machine Direction. Wire Side. Weight per Ream. Thickness. Bulk. Opacity. Gloss. Tensile Strength. Stretch. Bursting Strength. Folding Endurance. Tearing Test. Absorbency. Volume Composition. Air Permeability. Grease-proof Properties. Degree of Sizing. Chemical Tests. Ash. Retention. Sizing Materials. Rosin Determination. Paraffin. Chlorine. Free Acid. Sulphur. Amount of Coating. Glue or Casein Determination. Unbleached Fibers. Ground Wood.	

CHAPTER XVI

PRINTING.....	429
Definition. Half-tone Plates. Lithography. Paper for Different Types of Printing. Choice of Inks. Defects and their Causes.	

APPENDIX.....	444
---------------	-----

CHEMISTRY OF PULP AND PAPER MAKING

CHAPTER 1

CELLULOSE

Even at the present day the chemistry of cellulose cannot be said to be well understood though much energy has been expended in the attempt to discover its secrets and several comprehensive books have been written on the subject.¹ This state of affairs is due largely to its colloidal characteristics which make it very difficult to prepare and isolate pure compounds, and render it practically impossible to determine its molecular weight or to ascertain its structural formula. For these reasons the matter in the present chapter is confined largely to statements of facts and any extended discussion of theoretical considerations is intentionally avoided.

Physiological and Physical. Cellulose is the chief product of vegetable life and forms so large and important a part of all plant structures that its formation in the vegetable world is said to be synonymous with growth. It is practically the non-nitrogenous skeleton of all plants, but it never occurs in the plant in the free state, being associated or combined with fats and waxes, coloring matters, tannins, etc.. Because of its physical properties and its relative inertness toward the attack of chemicals cellulose is of enormous commercial importance, form-

¹ Cross and Bevan: Cellulose, London, 1918; Researches on Cellulose, 1895-1900, London, 1901; Researches on Cellulose, 1900-1905, London, 1906; Researches on Cellulose, 1905-1910, London, 1912. Schwalbe: Die Chemie der Cellulose, Berlin, 1911.

ing, as it does, the basis of the paper making and textile industries, and being used in modified forms in the manufacture of high explosives, artificial silk, and celluloid products.

In the industrial world the term "cellulose" is generally understood to mean the portion remaining after vegetable tissues have undergone thorough alternate treatments with alkaline solvents and oxidizing agents, and our knowledge of the chemical nature of cellulose is based upon a study of materials isolated by more or less drastic treatment of this nature from fibrous raw materials. The typical cellulose is that obtained from cotton by the textile bleaching processes, which remove the non-cellulose substances with which it is associated in the plant. When thus prepared it is a white substance, with a specific gravity of about 1.45, and with the general shape and characteristics of the fibres from which it was prepared. The individual fibres are translucent when seen under the microscope but masses of them are more or less opaque.

Composition and Constitution. The elementary composition of purified cotton cellulose is

	Per cent
Carbon.....	44.4
Hydrogen.....	6.2
Oxygen.....	49.4

which corresponds to the empirical formula $C_6H_{10}O_5$. This does not take into account the mineral constituents which are always present to a greater or less extent even in the most highly purified material. The ash in cotton cellulose is usually 0.1 to 0.2 per cent but this may be reduced to as little as 0.05 per cent by digestion in hydrofluoric and hydrochloric acids and washing very thoroughly in pure water. Ash constituents, on the other hand, may be taken up by cellulose from solutions with which it is in contact and various observers have shown that it is capable of removing from solution small amounts of the oxides of aluminum, iron, chromium, tin and lead. Materials taken up in this manner must not be confounded with the normal mineral matter.

As already mentioned the constitutional or structural formula for cellulose has not yet been definitely established although many investigators have attempted to solve the problem and have proposed various formulæ based upon its known reactions and their products. Among those proposed that of Green¹ is as follows:

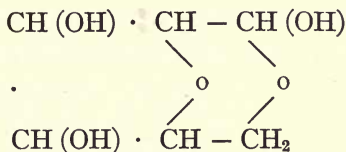

This is intended to represent cellulose only in its simplest or unpolymerized form, as, for instance, in ammoniacal copper solution. The cellulose of fibres may be composed of a number of these groups, joined by means of their oxygen atoms, or merely a physical aggregate of a number of molecules of the above composition.

By other authorities cellulose is regarded as a polycyclohexane derivative or as an essentially labile aggregate which assumes various configurations according to the action of the reagents employed. It is closely related to the sugars, starches, glucose and other members of the carbohydrate family.

Cellulose and Water. Water at ordinary temperatures, or even at a temperature corresponding to 60 lbs. steam pressure, has no action on cotton if air is excluded, but a mixture of air and steam causes rapid disintegration of the fibre.²

Air dry cellulose retains variable amounts of water of constitution according to the humidity and temperature of the surrounding atmosphere. With normal cotton this constitutional moisture amounts to 6 to 8 per cent, but if the cotton has been hydrated by mercerization, by dissolving and reprecipitating, or by prolonged abrasive action in the presence of water, its capacity for retaining moisture is increased and such air

¹ A. G. Green: Z. Farben- u Textil-Chem., 1904, 3, 97-98.

² Hebden: J. Ind. Eng. Chem., 1914, 6, 714-720.

dry fibre may retain 9 to 10 per cent of water. Acids which cause condensation (HCl, HBr), influence this change in the opposite direction and the resulting product has a lower moisture capacity — 3 to 5 per cent — than the normal cellulose. Since the atmospheric humidity affects the moisture content of cellulose it is obviously essential to have some fixed standard for commercial transactions and for the paper industry it is the practically universal custom to consider that air dry wood pulp contains 10 per cent of moisture, *i.e.*, 100 parts of air dry pulp will yield 90 parts of bone dry fibre when dried at 100° C.

A knowledge of the normal moisture content of cellulose, and of the products made therefrom, is of importance in the finishing and commercial handling of textile goods, while in the paper industry the hydration effect of the beating process determines very largely the character of the paper made. In the latter industry it is possible to make from the same raw materials, by varying the beating process, such widely different products as blotting paper and grease-proof parchment. Ignorance of the relation of cellulose and atmospheric humidity is also one of the chief causes of trouble in printing plants where the paper-maker's product becomes the publisher's raw material.

The difference between cellulose hydrates and hydrocellulose is one which is often not well understood and about which much confusion is likely to arise. Hydrocelluloses are formed by hydrolytic action, — as by acids, — and are characterized by the presence of free carbonyl groups which reduce Fehling's solution. They are also distinguished by an abnormally low moisture content, as noted above, and are soluble to a considerable extent in sodium hydroxide solutions at the boiling temperature. Cellulose hydrates may be formed, either with or without simultaneous hydrolysis, if cellulose is acted upon by alkalis or other chemicals which exert a swelling action in the presence of water. They are widely different in their properties but possess the common characteristics of a high moisture content, and a decreased resistance to hydrolysis by acids. Ost and

Westhoff¹ do not recognize the existence of "water of hydration" as distinct from hygroscopic moisture and believe that the latter can be accurately determined at 125° C. They find that, after drying at 120° to 125° C., mercerized cotton, normal cotton, and regenerated cellulose from viscose all have the same elementary composition.

Cellulose and Solvents. Cellulose is insoluble in all neutral solvent liquids; it is, however, dissolved by:

1. Concentrated zinc chloride solutions (40 to 50 per cent $ZnCl_2$), when heated to 80 to 100 degs., or at lower temperatures if the cellulose has previously been hydrated.
2. Zinc chloride dissolved in twice its weight of hydrochloric acid (35 per cent HCl).
3. Solutions of cuprammonium hydrate.²

These three solvents dissolve cellulose without transforming it into other compounds, except those formed by the action of water, and from solvents 1 and 3 the cellulose may be quantitatively regenerated although in the hydrated condition. When fibrous celluloses are dissolved by these reagents they pass through various stages of swelling and hydration until finally a uniform structureless solution is obtained. One characteristic of these solutions is their high viscosity which limits the amount of cellulose which can be dissolved to a filterable solution to about 7 to 9 per cent. When the solution of cellulose in zinc chloride is forced through a small orifice into alcohol the cellulose is precipitated in the form of a continuous thread of transparent, solid matter containing zinc oxide which can be removed by treating with hydrochloric acid. Water also causes

¹ Ost and Westhoff: Chem. Ztg., 1909, 33, 197.

² These may be prepared conveniently by precipitating cupric hydrate by adding caustic soda to a cold solution of copper sulphate, washing the precipitate thoroughly, and then dissolving it in strong ammonia (sp. gr. 0.90). The solution should contain 2.5 to 3.5 per cent of copper (as $CuO \cdot nH_2O$), and 15 per cent of NH_3 (as NH_4OH).

the precipitation of cellulose but in an even more hydrated state. The solution in cuprammonium is not at all stable, the cellulose being readily precipitated by alcohol, sodium chloride and other salts of the alkalis, and even by sugar.

Solutions of cellulose find technical application in making threads, which are carbonized for use in incandescent lamps, and in the manufacture of artificial silk, etc. The action of solvents is also utilized in making "vulcanized fibre" or "press-board" where a web of fibre is passed through a zinc chloride solution and then wound up on a mandrel or drum. After removal from the drum the chemicals are thoroughly washed out and the sheets are dried and used as insulating material or in structural work. The superficial action of cuprammonium solutions may be utilized in water-proofing fabrics, as in the case of the "Willesden" products, but if, as in the case of these goods, no attempt is made to remove the hydrated copper, the products will have a greenish color.

Cellulose is hydrated and dissolved by sulphuric acid of a strength of 67.0 to 78.0 per cent H_2SO_4 ,—approximately $\text{H}_2\text{SO}_4 \cdot 2 \text{H}_2\text{O} - \text{H}_2\text{SO}_4 \cdot 3 \text{H}_2\text{O}$. The solution is syrupy and nearly colorless and if diluted at once the cellulose is precipitated as a gelatinous hydrate. This reaction is the basis for the production of "parchment paper" or "vegetable parchment" in which a continuous web of pure cellulose paper is passed first through a bath of acid and then at once into water which stops the action of the acid and reprecipitates the cellulose which has been superficially dissolved. After washing out the last traces of acid the parchmentized web is treated with a solution of glucose or glycerine and dried. The glycerine serves to retain moisture and make the paper less brittle than it would be if entirely dried out. Paper treated by this parchmentizing process suffers considerable linear shrinkage, sometimes as much as 20 per cent, and also loses somewhat in weight.

Deming¹ has shown that cellulose is also soluble in concentrated aqueous solutions of certain salts, such as antimony tri-

¹ H. G. Deming: J. Am. Chem. Soc., 1911, 33, 1515-1525.

chloride, stannous chloride and zinc bromide. Solutions of these salts, and many others, in aqueous hydrochloric acid dissolve cellulose with still greater ease. From such acid solutions there are obtained by reprecipitation "modified celluloses," amorphous products which have distinct reducing properties and are readily hydrolyzed.

Although ordinary hydrochloric acid, and even that of sp. gr. 1.196, are incapable of dissolving cellulose, it has been shown by Willstätter and Zechmeister¹ that complete solution rapidly takes place on treating cellulose with fuming hydrochloric acid of a specific gravity of 1.2 or over. Cotton or filter paper may be dissolved in acid of sp. gr. 1.209 in about 10 seconds. Immersing the cotton and kneading with the acid enables solutions of 7 to 15 per cent strength to be obtained according to the strength of the acid. Such solutions are colorless and clear and if diluted within 30 to 45 minutes after preparation a form of cellulose is quantitatively precipitated and the solution has no cupric reducing power.

Cellulose and Salts. Because of its colloidal properties cellulose forms characteristic combinations with inorganic oxides, particularly those of aluminum, chromium, iron, tin and lead. These oxides are taken up by cellulose from solutions of their salts and the fibres which are thus mordanted possess increased affinity for coloring matters. In the case of iron salts sufficient ferric oxide may be taken up by the fibre to seriously injure its color.

This ability to absorb oxides doubtless plays some part in the sizing of paper, for Schwalbe and Robsahm² found that unbleached sulphite wood pulp was capable of absorbing all the alumina present in 3 per cent of its weight of aluminum sulphate. This corresponds to an absorption of about 0.46 per cent of Al_2O_3 on the weight of the fibre. A similar investigation by Sutermeister,³ working on bleached fibres, showed

¹ R. Willstätter and L. Zechmeister: Ber., 1913, 46, 2401-2412.

² C. G. Schwalbe and H. Robsahm: Wochbl. Papierfabr., 1912, 43, 1454-1457.

³ E. Sutermeister: Pulp Paper Mag. Can., 1913, 11, 803.

that the weight of Al_2O_3 absorbed, based on the bone dry fibre, was 0.23 to 0.29 per cent for soda poplar, 0.00 to 0.17 per cent for sulphite spruce, and 0.10 to 0.13 per cent for rag fibres (cotton).

Rassow¹ finds that cotton cellulose is capable of absorbing small quantities of copper from dilute solutions of copper salts and that the absorbed metal cannot be removed by washing. The amount absorbed was independent of the time of contact, the strength of the solution or its temperature. Similar results were obtained with solutions of nickel sulphate, aluminum sulphate and potassium chloride.

Decompositions of Cellulose. Cellulose is broken down in a number of different ways according to the nature of the attacking substance, its concentration and the physical conditions accompanying the reaction, yet the study of these decompositions and their products has done but little to explain the constitution of the cellulose molecule.

Acids. Dilute sulphuric and hydrochloric acids, and acids in general, attack cellulose with varying degrees of rapidity depending on the temperature and the concentration of the acid. The products of such action are either soluble substances, chiefly dextrins and dextrose, or insoluble bodies generally termed hydrocelluloses. These are disintegrated residues, more or less retaining the form of the original fibres, and they differ from cellulose in the presence of free aldehydic groups and in the ease with which they are acted on by alkalis. According to Griffin and Little² hydrocellulose absorbs oxygen when heated, even at so low a temperature as 50 degs., and after being kept for some hours at 80 to 100 degs. in contact with air is converted into dark colored compounds which are soluble in water. Hydrocellulose, unlike oxycellulose, does not attract basic dyes.

Ville and Mestrezat³ found that dilute hydrofluoric acid had

¹ B. Rassow: *Z. angew. Chem.*, 1911, **24**, 1127.

² Griffin and Little: *Chemistry of Paper Making*, 114.

³ Ville and Mestrezat: *Compt. rend.*, 1910, **150**, 783.

little effect on cellulose but that at 40 to 50 per cent strength considerable dextrose was formed. Ost and Wilkening¹ have confirmed Flechsig's claim that 98 per cent of the cellulose may be converted into dextrose by suitable treatment with acid. This result cannot be reached by the action of dilute acids at high temperatures because the dextrose formed is destroyed either by reverse condensation or by conversion into acids. According to Willstätter and Zechmeister² cellulose may be completely hydrolyzed by hydrochloric acid acting in the cold for a period of 1 to 2 days and a yield of 95 to 96 per cent of the theoretical amount of dextrose may be obtained. Cunningham³ has reinvestigated the relationship of cellulose to dextrose and has failed to confirm the results of Ost and Wilkening or Willstätter and Zechmeister; he considers their conclusions based on insufficient data and thinks that the investigations have thrown very little light on the structure of the cellulose complex.

The formation of friable hydrocelluloses by acids is of great importance industrially for upon it is based the carbonization process for separating cotton from wool in which the mixed goods are immersed in acid and allowed to dry without washing. This converts the cotton into hydrocellulose which can be removed by dusting, leaving the wool behind in suitable condition for future use.

Alkalis. In the presence of air caustic soda solutions of a strength of 10 to 20 grams per liter rapidly disintegrate cotton fibre at a temperature corresponding to 10 lbs. steam pressure. When air is excluded cellulose is only slightly acted on by dilute solutions of alkalis even at high temperatures. Caustic soda solutions of 12 per cent strength, and over, combine with cellulose at ordinary temperatures, causing marked changes in physical structure but not breaking up the molecular grouping. Still stronger solutions, at temperatures as high as 180 degs., form

¹ Ost and Wilkening: Chem. Ztg., 1910, 34, 461.

² Willstätter and Zechmeister: Ber., 1913, 46, 2401.

³ Cunningham: Chem. Soc. Trans., 1918, 113, 173-181.

merely soluble modifications which on diluting and acidifying are precipitated in colloidal form. At still higher temperatures (250 degs.) and with larger proportions of alkaline hydroxides cellulose is broken down largely into acetic and oxalic acids.

Oxidants. From the condition of papers and textiles which have for centuries been exposed to all ordinary atmospheric conditions, it seems fair to assume that oxidation due to the surrounding atmosphere is extremely slight, a fact which is of the utmost importance technically. Cellulose is also quite resistant to oxidizing agents in dilute solutions, a circumstance which makes it possible to remove impurities of a colored nature without at the same time destroying the fibres. If, however, the concentration of the oxidant exceeds the limit of resistance of the cellulose destructive oxidation takes place with the formation of products of low molecular weight, principally oxalic and carbonic acid. Not all of the products are soluble, however, as a portion remains undissolved and retains more or less of the original form of the fibres. These insoluble residues are known as oxycelluloses. They contain free aldehydic groups, are easily hydrolyzed, and yield some furfural, $C_4H_3O \cdot COH$, on boiling with hydrochloric acid of sp. gr. 1.06. They are white, friable substances and contain less carbon and more oxygen than cellulose. No method is known of restoring to its original condition fibre which has been converted to oxycellulose.

The results of the oxidation of cellulose are not always the same, as they depend on the nature of the oxidant, its concentration, the temperature at which it acts and on accompanying reactions of a hydrolytic nature. With concentrated solutions of hypochlorites or hypobromites there is some formation of chloroform and carbon tetrachloride or the corresponding bromine compounds. The action of nitric acid (sp. gr. 1.1 to 1.3) at elevated temperatures results in the formation of a series of oxycelluloses which are characterized by yielding less furfural than those formed by the action of chromic acid. With chromic acid the degree of action depends on the proportion of the reagent and on the hydrolytic action of the associated mineral

acid. The oxycelluloses produced yield comparatively large amounts of furfural. The ultimate result of the action of chromic acid in the presence of sulphuric acid is complete combustion to CO_2 and H_2O , a reaction upon which are based quantitative analytical methods.

After a study of the results obtained in bleaching Cross and Bevan¹ suggested the possibility of the formation of a cellulose peroxide. Similar phenomena were observed by Ditz² in the case of cellulose which had been gradually heated to 80°C . in an acid solution of a persulphate and then slowly cooled, while according to Cunningham and Doree,³ ozone rapidly attacks cotton with the formation of cellulose peroxide which is decomposed by water at 80°C .

Oxycelluloses reduce Fehling's solution and on this property is based Schwalbe's method for determining the degree of bleaching of fibres; as hydrocelluloses reduce Fehling's solution, the method also shows the effects of any coincident hydrolytic action. The determination of the degree of bleaching, or, as it is frequently called, the "copper number," has proved of considerable assistance in technical investigations and the procedure employed by Schwalbe⁴ is about as follows: Two portions of about three grams each are weighed out, of which one is used for the determination of the percentage of moisture. The other is reduced to a finely divided condition and mixed with 300 c.c. of water and 100 c.c. of Fehling's solution. This is boiled in a flask for exactly 15 minutes, using a reflux condenser to keep the volume constant and a stirrer to maintain continuous agitation. Precautions must be taken to prevent overheating the walls of the flask as drops of the liquid or portions of the moist fibre which spatter onto them may be decomposed with formation of products affecting the results. After boiling, the

¹ Cross and Bevan: *Z. angew. Chem.*, 1906, **19**, 2101.

² Ditz: *Chem. Ztg.*, 1907, **31**, 833.

³ Cunningham and Doree: *Chem. Soc. Proc.*, 1912, **28**, 38.

⁴ Schwalbe: *Ber.*, 1907, **40**, 1347-1351; *Z. angew. Chem.*, 1910, **23**, 924-928; *Z. angew. Chem.*, 1914, **27**, 567-568.

liquid is filtered while hot by means of the suction pump, and the fibrous residue is washed with hot water. The precipitated copper is dissolved from the fibre by nitric acid, the final traces being removed by digestion with ammonia, and the copper then determined by electrolysis.

As the presence of hydrated or modified celluloses causes the precipitation of copper hydroxide by adsorption the "copper number" obtained as above must be corrected by deducting the "hydrate copper value" which is determined by immersing a fresh portion of the cellulose in cold Fehling's solution for 45 minutes and determining the copper as before.

Ferments. Certain organisms affect the complete disruption of the cellulose molecule, or aggregate, the chief products being hydrogen, methane, carbon dioxide and fatty acids. Such bacterial fermentation on a large scale in the soil is one of the chief processes by which the cellulosic portion of plant remains is resolved into simpler products. In the digestive organs of herbivorous animals cellulose is broken down by similar fermentative processes, apparently with the formation of simpler substances of high nutritive value, which are readily assimilated. In addition to these, gaseous products are also formed, carbon dioxide, methane, and sometimes hydrogen being produced.

Omelianski concluded that the organisms causing decomposition of cellulose were anaërobic, but Kellerman and McBeth¹ have succeeded in isolating three cellulose-destroying organisms which act most rapidly under aërobic conditions. None of these causes evolution of gas. In addition they have isolated eleven other species of cellulose-destroying bacteria all of which were facultative anaërobes fermenting cellulose most rapidly under aërobic conditions.

Heat. When cellulose is heated above 250° C. very complex decompositions take place and among the products are charcoal, acetic acid, methyl alcohol, acetone, furfural, carbon monoxide and carbon dioxide. The proportions of these substances vary with the temperature and the rate and duration of heating.

¹ Kellerman and McBeth: *Centr. Bakt. Parasitenk.*, II, 34, 485-494.

When cellulose was distilled destructively in such a way that a temperature of 100 degs. was reached in $1\frac{1}{2}$ hours and 500 degs. in 7 to 8 hours, Bantlin¹ found the following products, the percentages being given on the weight of the dry substance used:

	Per cent
Coke.....	32.9
Water.....	31.7
Tar.....	3.25
Acetic acid.....	3.28
Aldehydes.....	5.82
Ketones.....	0.11
Carbon dioxide.....	11.26
Carbon monoxide.....	4.78
Ethylene.....	0.24
Hydrogen.....	0.02
Ethane.....	0.35
Methane.....	0.68
Undetermined.....	5.23

During the course of this distillation there was an exothermic reaction at 250 to 300 degs. which was complete at 320 degs.

Compounds of Cellulose. Cellulose is not a substance of great reactivity yet there are a number of its compounds which are of very great commercial importance. Most of these, it is true, do not vitally concern the paper maker, yet a discussion of the properties of cellulose, no matter how concise, would be quite incomplete unless they were at least briefly mentioned. Moreover, a knowledge of how they are formed and of their characteristics is of distinct assistance in enabling the student to secure a better perspective of paper making processes in their relation to those of other industries.

Nitrates. These esters are formed by direct reaction with nitric acid, usually mixed with sulphuric acid, and the composition and properties of the resulting nitrate depend largely on the proportions of the two acids and on the amount of water with which they are mixed. Crane and Joyce,² using a mixture

¹ G. Bantlin: J. Gasbel., 1914, 57, 32 and 55.

² Crane and Joyce: J. Soc. Chem. Ind., 1910, 29, 540.

containing 57 to 67 per cent of sulphuric acid, 16 to 6 per cent of nitric acid and 25 to 27 per cent of water, and nitrating for short times have prepared products with as little as 3.5 to 4.5 per cent of nitrogen. These are pasty, gelatinous masses, insoluble in all nitrocellulose solvents, but readily soluble in solutions of caustic alkalis.

When stronger acids are employed the nitrates formed contain more nitrogen up to a limit of about 14 per cent which corresponds to the trinitrate, $C_6H_7O_5(NO_3)_3$. This nitrate, which is the most explosive gun-cotton, may be prepared by treating cotton with a mixture of 3 parts of nitric acid (sp. gr. 1.5) and 1 part of sulphuric acid for about 24 hours at $10^\circ C$. The unstable mixed esters, containing both nitric and sulphuric groups, are formed as an intermediate stage in the reaction and the NO_3 groups finally replace the HSO_4 groups. It is considered that traces of the mixed ester remaining in the finished product are often responsible for its instability. In this reaction 100 parts of cellulose yield about 170 parts of the nitrate. Nitration under these conditions does not visibly alter the physical structure of the cellulose. The trinitrate is insoluble in alcohol, ether, mixtures of the two, glacial acetic acid or methyl alcohol; it is very slowly soluble in acetone. The next lower members, corresponding approximately to the dinitrate, $C_6H_8O_5(NO_3)_2$, are soluble in ether-alcohol, acetic ether, acetic acid and methyl alcohol, while the mononitrate, $C_6H_9O_5NO_3$ is very soluble in ether-alcohol, acetic ether and absolute alcohol. A considerable number of nitrates have been formed but it has proved very difficult to isolate any one of them in a pure condition and from a careful study of the work of G. Lunge,¹ Cross and Bevan have reached the conclusion that "the stages of nitration of cellulose are not molecular stages, but represent progressive increments of the esterifying groups in a mass-aggregate, which is the reacting unit."²

The general properties of the cellulose nitrates are: (1) nitric

¹ G. Lunge: J. Am. Chem. Soc., 1901, 23, 527.

² Cross and Bevan: Researches on Cellulose, II, 1900-1905, 44.

acid may be removed by warming with alkaline solutions, the amount removed depending on the concentration of the alkali; (2) nearly all of the nitric acid is expelled by treatment with cold concentrated sulphuric acid; (3) boiling with ferrous sulphate and hydrochloric acid drives off the nitrogen as nitric oxide; (4) alkaline sulphhydrates, ferrous acetate and numerous other substances convert the nitrate into ordinary cellulose.

The various cellulose nitrates find many very important commercial uses. Mixed with castor oil they are extensively used in the manufacture of artificial leather. In solution in ether-alcohol cellulose nitrate is employed in the manufacture of artificial silk by the Chardonnet process, the fibre being finally denitrated by treatment with ammonium sulphide to render it less inflammable. The fibrous nitrates may be reduced to plastic masses by kneading with solvents and in this condition may be formed into articles of any desired shape. As films they find use in photography, as the carrier for the emulsion; in the solid form, after the incorporation of camphor, they are spoken of as celluloid or xylonite and find innumerable uses.

The nitrogen content of the nitrates for various purposes is given by Mork¹ as follows: Celluloid and films for moving pictures about $10\frac{1}{2}$ to $11\frac{1}{4}$ per cent; varnishes and lacquers $11\frac{1}{2}$ to 12 per cent; for powder purposes 12 to $12\frac{1}{2}$ per cent; and for gun-cotton 13 to 14 per cent. In the higher nitrates the proportion of oxygen is such that upon decomposition the products are entirely gaseous and it is upon this property that their use as explosives depends.

Gun-cotton. Because of the similarity between many of the methods used in paper making and those in the manufacture of gun-cotton a very brief description of the methods used in the latter industry may be of interest.

Cotton is still practically the only cellulose used although it has apparently recently been demonstrated that certain grades of wood pulp will make acceptable substitutes. The cotton is obtained in the form of spinning wastes or of the short fibres

¹ Mork: J. Frank. Inst., Sept., 1917.

are used film

from the seeds known as linters. Where spinning wastes are used the fibres are first degreased by treatment with some solvent, then boiled with caustic soda, bleached with bleaching powder solution or with calcium sulphide, washed, neutralized with sulphuric or hydrochloric acid, again washed, and finally dried. It should contain no chlorides, sulphates, oxycellulose or hydrocellulose, but it often contains mechanical impurities such as wood, string, colored threads, metal, etc., and to remove these it is hand picked as it passes along a conveyor to a "willow" which opens out the lumps and knots. After leaving the "willow" it is again hand picked and then is dried by hot air, weighed in charges of the desired size and cooled in closed containers.

Various methods of nitration are in use but all depend on the immersion of small quantities of cotton in comparatively large volumes of mixed nitric and sulphuric acid. The time of nitration varies from 30 minutes to 24 hours according to the method employed. The speed of nitration increases rapidly with rise of temperature, but the yield decreases although the nitrogen content of the product remains practically constant. After nitration the excess acid is removed by centrifugal action and the fibrous nitrate is washed by rinsing and is then boiled either with water alone or with the addition of a very little alkali in order to remove traces of free acid and to decompose and dissolve unstable impurities. This boiling operation, with intermediate washings with cold water, sometimes lasts 4 to 5 days.

The next operation is that of pulping the washed nitrate; this is done in beaters very similar to those used in paper manufacture but slightly modified in order that thorough agitation and no settling may take place. During the pulping the fibre is reduced in length and is at the same time washed continuously with hot water in order to remove the last traces of acid. Further washing is given by agitation, settling and removing suspended impurities after which enough alkali is added to leave in the finished gun-cotton 1 to 2 per cent of alkaline matter

calculated as CaCO_3 . The pulp is then run into moulds with bottoms of fine wire gauze and the water removed by suction and by hydraulic pressure. The slabs thus formed are used wet or after drying according to the purpose for which they are desired.

For the manufacture of smokeless powder the washed pulp is screened and then dried by centrifugal action; it still contains much water and this is removed by treatment with ethyl alcohol. Finally a little ether, or other volatile solvent, is kneaded in which produces a paste ready for the blocking operations. The solvents are removed during drying so that very little remains in the finished product.

Nitrites. When viscose silk is treated with nitrous gases in the presence of nitric acid nitrites of cellulose are formed. They are not soluble in water, alcohol, acetone, ether, chloroform, or ethyl acetate. Nitrogen is given off slowly at ordinary temperatures and rapidly on heating. Nitrites are liable to occur in nitrocellulose and cause rapid deterioration.¹

Acetates. Cellulose acetates are formed when cellulose is treated with acetic anhydride under quite widely varying conditions. The monoacetate, which is formed at 110 degs., is insoluble in all neutral solvents and in the solvents of cellulose. At 140 to 160 degs. higher acetates are formed, accompanied by solution in the reaction mixture, while in the presence of catalytic agents—zinc chloride, sulphuric acid, or phosphoric acid, for instance—the reactions take place at much lower temperatures, due doubtless to the formation of hydrocellulose which acetylates more rapidly than the normal cellulose. Ost,² who has studied the formation of acetates by three different processes, finds that all yield the triacetate, $\text{C}_6\text{H}_7\text{O}_5(\text{C}_2\text{H}_3\text{O}_2)_3$, but at the same time he doubts the existence of a triacetate of normal cellulose and considers these compounds as derivatives of a series of hydrocelluloses. This feature of preliminary hydrolysis seems to be one of the essentials of acetate forma-

¹ Nicolardot and Chertier: *Compt. rend.*, 1910, **151**, 719-722.

² Ost: *Z. angew. Chem.*, 1906, **19**, 993.

tion. Acetylation of the fibrous celluloses without appreciable structural change may be accomplished by diluting the reagents with hydrocarbons.

The higher acetates are soluble in acetone, phenol and chloroform and the solutions are of high viscosity. Boiling the acetates with alkaline solutions splits off the acetyl groups and the cellulose is regenerated.

In contrast to the nitrates the acetates are non-explosive, and since they can be dissolved by appropriate volatile solvents to homogeneous solutions they are admirably adapted for use in the preparation of films, threads, etc. Commercial acetates are on the market in the fibrous, granular or powdered forms or in solutions of various viscosities. They are used for nearly all purposes for which the nitrate is used except for explosives and their use would be still more extended but for the fact that their cost of manufacture is appreciably greater than that of the nitrate. It is interesting to note that acetate silk is the only one in which the final product retains the ester composition, since in other cases reactions take place which leave the thread simply as hydrated cellulose. This is probably the reason why wetting reduces the strength of acetate silk so much less than it does the other kinds.

Cellulose-Sulphuric Esters. The action of concentrated sulphuric acid on cellulose causes the formation of a series of esters which have been described as cellulose sulphuric acids but which are more probably derivatives of resolution products. The first stage of the reaction is, according to Stern,¹ the formation of a disulphuric ester, $C_6H_8O_3(SO_4H)_2$, which is soluble in water while its calcium barium and lead salts are insoluble in alcohol. This reaction of cellulose and sulphuric acid is of great importance in processes of esterification, where the acid acts as a catalyst, first combining with the cellulose and then being replaced by the ester forming groups. In the case of nitrates and acetates this substitution is never quite complete, and traces of SO_4H remain fixed in both compounds. The

¹ Stern: J. Chem. Soc., 1895, I, 74-90.

presence of such residues in the nitrate renders it unstable and its removal is one of the chief reasons for the extended boiling and washing treatments which gun-cotton undergoes.

Mixed Esters. As may be concluded from the above the joint action of sulphuric acid with other esterifying agents can result in the formation of mixed esters containing SO_4H groups as well as other negative groups. In this way aceto-sulphates are formed by the action of acetic anhydride, glacial acetic acid and sulphuric acid.¹ These contain from 5 to 25 per cent of combined SO_4 and may be grouped in three classes according to their physical properties. Those with most SO_4 are soluble in water, the others in acetone or dilute alcohol. In a similar way aceto-nitro-sulphates and nitro-benzoates have been formed.

Benzoates. The action of benzoyl chloride in the presence of alkali hydroxides results in the formation of cellulose benzoates. The monobenzoate is formed with only slight structural changes when cellulose is treated with a 10 per cent solution of caustic soda and shaken with benzoyl chloride. The dibenzoate is formed in the presence of 15 per cent caustic soda solution, the fibrous celluloses being disintegrated, as the dibenzoate is an amorphous substance. This compound is soluble in acetic acid and chloroform.

Formates. Formylated cellulose may be made by treating hydrocellulose with formic acid in the presence of zinc chloride.² Its slight solubility in organic solvents and its lack of thread, and film-forming ability make it rather unpromising. According to German patents,³ solutions of the following compounds may be used as solvents of cellulose formate: iodides and bromides of the alkali metals, metallic nitrates as well as those of ammonia and the alkaline earths, cupric chloride, soluble bichromates, alkali xanthates, aniline salts and alkali salts of aromatic mono- and polysulphonic acids.

¹ Cross, Bevan and Briggs: Berl. Ber., 1905, 38 and 1859.

² Worden: J. Soc. Chem. Ind., 1912, 31, 1064.

³ Ger. Pats. 266,600 and 267,577, July 5, 1912, and Feb. 26, 1913.

Alkali-Cellulose. The action of solutions of sodium hydroxide of 12 to 15 per cent strength causes considerable change in the structure of fibrous celluloses, particularly cotton which is changed from a flattened twisted ribbon with a large central canal to a thickened cylinder in which the canal shows very little. When this action takes effect on cloth there is a considerable shrinkage both in length and width but at the same time the cloth gains in strength. The amount of shrinkage varies with the strength of solution employed; it is practically uniform for solutions of sp. gr. 1.00 to 1.10, while there is a sudden increase at sp. gr. 1.10 to 1.12. Between this point and sp. gr. 1.225 there is a relatively rapid increase in shrinkage but beyond the latter point the shrinkage again diminishes. If the goods are kept under tension during the reaction the physical changes give to the material a peculiar, silky lustre. This reaction is spoken of as mercerization from the name of Mercer by whom it was first discovered.

The effects thus obtained are due to a definite chemical combination of cellulose and caustic soda in the proportions $C_6H_{10}O_5$ to 2 NaOH, accompanied by combination with water. This compound is entirely dissociated by water, the alkali being recovered unchanged while the cellulose remains in the hydrated condition. When it is treated with alcohol equilibrium is reached when part of the alkali is removed, the residue being $C_{12}H_{20}O_{10} \cdot NaOH$.¹

Cellulose-Sulpho-Carbonates. The above mentioned alkali-cellulose-hydrate, containing 30 per cent cellulose, 15 per cent caustic soda and 55 per cent water, is the first step in the formation of cellulose-sulpho-carbonate which is also known as sodium-cellulose-xanthate and viscose. This compound is prepared by acting on the alkali cellulose with carbon disulphide at ordinary temperatures. In practice bleached cotton or wood pulp is treated with an excess of 15 to 18 per cent caustic soda solution and then pressed until it retains $2\frac{1}{2}$ to 3 times its weight of the solution. This is then treated in a closed vessel with carbon

¹ Cross and Bevan: Researches on Cellulose, II, p. 13.

disulphide amounting to about half the weight of the cellulose. At the end of about three hours at ordinary temperatures water is added and the mass allowed to stand for some hours to complete its hydration; on stirring a homogeneous solution results, which may be diluted to any desired degree.

The impure compound is yellow in color due to by-products of the reaction, but the pure material, which may be prepared by treating the crude solution with alcohol or saturated brine, is obtained in the form of greenish white flocculent masses. These redissolve in water to a faintly yellow solution and from such solutions the xanthates of the heavy metals may be precipitated by adding solutions of the corresponding heavy metal salts.

Viscose solutions may be evaporated at low temperatures to solids which are completely resolvable in water, but if the solutions are heated to 70 to 80 degs. they thicken and at 80 to 90 degs. coagulation takes place very rapidly. Mineral acids neutralize the total alkali in the viscose and cause precipitation of hydrated cellulose while organic acids are not sufficiently strong to decompose the sulpho-carbonate.

The most characteristic property of viscose is its spontaneous decomposition with formation of hydrated cellulose, caustic soda and carbon disulphide or its reaction products. With aqueous solutions of greater strength than 1 per cent cellulose this decomposition causes the formation of a jelly of the shape and volume of the containing vessel. This jelly gradually contracts with the expulsion of water. Observations on 100 c.c. of a 5 per cent solution kept in a stoppered vessel at ordinary temperatures showed the following rates of coagulation and shrinkage.¹ (See table on p. 22.)

The cellulose regenerated from viscose differs from the original in being more hygroscopic, as well as being hydrated, and in being more reactive toward bases but less so toward acid groups.

Viscose finds extensive use in the manufacture of artificial silk and in the preparation of films for transparent wrappings.

¹ Cross and Bevan: Text-Book of Paper Making, 3rd ed., p. 25.

These latter are very thin, 0.001 inch, and as compared with nitrate or acetate films are much more water-absorbent.

	Time in days	Vol. of cellulose hydrate	Diff. from 100 c.c. = vol. expressed
		c.c.	c.c.
Coagulation	8th day
First appearance of liquid	11th "
	16th "	98.0	2.0
	20th "	83.5	16.5
	25th "	72.0	28.0
	30th "	58.0	42.0
	40th "	42.8	57.2
	47th "	38.5	61.5

The Groups of Celluloses. Up to this point the remarks have applied chiefly to cotton, which may be considered as the typical cellulose, but there are also numerous other celluloses which differ more or less widely from this standard. The fibrous celluloses, for instance, are grouped, according to C. F. Cross, into three classes, depending upon their degree of resistance to hydrolytic and oxidizing actions, the amount of furfural which they yield when boiled with dilute hydrochloric acid, and their elementary composition as regards the ratio of carbon to oxygen. The characteristics of the three groups may be tabulated as follows:

	A Cotton group	B Wood cellulose group	C Cereal cellulose group
Hygroscopic moisture.....	6-8%	9-11%	10-12%
Elementary composition C : O	{ 44.0-44.4	{ 43.0-43.5	{ 41.5-42.5
	{ 50	{ 51	{ 53
Furfural.....	{ 0.1-0.4%	{ 3-6%	{ 12-15%
Other characteristics.....	{ No active CO groups	{ Some free CO groups	{ Considerable reactivity of CO groups

In group *A* are included cotton, flax, hemp, rhea (ramie), sunn hemp, etc. They are usually associated in the plant world with substances easily removed by digestion with alkalis.

The purified celluloses of this group are considered chemically identical with cotton.

Group *B* comprises celluloses obtained by the decomposition of compound celluloses, *i.e.*, those from woods and lignified tissues in general. They may be considered as oxidized and partially hydrolyzed products and are more readily attacked by hydrolyzing agents than are the celluloses of group *A*.

The fibres of group *C* are in most cases complex, both structurally and chemically. They are oxycelluloses and are still less resistant than the group *B* celluloses. They undergo gradual oxidation in dry air at a temperature of 100 degs. and become discolored.

In still a fourth group may be classed those cellular, rather than fibrous, celluloses which offer low resistance to hydrolysis. These are easily resolved by boiling with dilute acids and are also soluble to some extent in dilute alkaline solutions. As the celluloses of this group are not employed in paper making no further discussion of their properties is essential in this work.

Compound Celluloses. Passing from the consideration of the purified celluloses to what may be called their raw materials, it is found that plant physiologists recognize three modified or "compound" celluloses: cutocellulose, pectocellulose and lignocellulose.

Cutocelluloses contain, mixed with the tissues, various oily and waxy substances which render them quite water-resistant. The two principal types of these compound celluloses are cork and the cuticular tissues of leaves, stems, etc. Cork contains, in addition to oils and waxes, tannins, lignocelluloses and nitrogenous materials. No celluloses of this type are employed in paper manufacture, hence a knowledge of their properties is only of incidental interest.

The pectocelluloses may be considered either as compounds or intimate mixtures of cellulose and colloidal carbohydrates which are easily hydrolyzed by either acid or alkaline treatments to simpler, soluble materials. They are "saturated compounds" and therefore do not react with the halogens. Cel-

luloses of this kind are widely distributed in the plant world and are extremely varied in composition and structural character. Among the more important pectocelluloses are flax and such other non-lignified fibres as ramie, hemp, nettle fibres, sisal, esparto, bamboo, etc. Many of these are more or less associated with lignocelluloses. While many of the pectocelluloses enter into paper making operations, it is not as pectocelluloses, but only after the separation of the pectic constituents by means of alkaline hydrolysis.

Lignocelluloses form by far the most important group of compound celluloses, so far as paper making operations are concerned, both because they are employed directly, as in the case of ground wood and jute, and also because they are the basic raw materials from which the greater part of the paper making celluloses are prepared. They have been studied in considerable detail by Cross and Bevan, who worked on jute fibre, which they consider to be the typical lignocellulose.

One essential feature of lignification is the formation of methoxyl groups, $O \cdot CH_3$, while a second ketonic grouping, $CO \cdot CH_2$, is also a characteristic constitutional feature. This latter group doubtless plays an important part in the formation of acetic acid during hydrolysis. Woods are more pronounced lignocelluloses than jute, having more non-cellulose constituents and yielding more methoxyl and furfural. They are still further differentiated from jute by their behavior toward cellulose solvents, since they yield, as a whole, to no process of solution and are, moreover, almost totally resistant to the thiocarbonate (viscose) reaction. In all but these two characteristics the lignocelluloses of jute and wood are very much alike.

Jute lignocellulose is dissolved by cuprammonium and by zinc chloride either in aqueous or acid solution. Hydrolysis accompanies the solvent action, so that on precipitation the recovery of the lignocellulose is incomplete.

Alkalis at high temperature attack and dissolve the lignin and the less resistant cellulose but at the same time some of the more resistant cellulose is also dissolved. The residual cellulose,

in the case of jute, is very similar in composition to the normal cellulose. Acids, even in dilute solutions, rapidly disintegrate lignocelluloses at temperatures above 60 degs. Caustic soda and carbon disulphide dissolve only part of the lignocellulose, 50 to 75 per cent remaining undissolved but in such a hydrated and swollen condition that it has been known to occupy one hundred times the volume of the original fibre. This insoluble residue reacts with chlorine as does the original fibre. Oxidizing agents profoundly attack lignocelluloses with the formation at first of acid products and finally, on further oxidation, of carbon dioxide and water.

Because of the difficulty of separating lignin from cellulose without causing decomposition or structural changes, its composition is still regarded as uncertain. Klason ¹ assigns to lignin the empirical formula $C_{40}H_{42}O_{11}$ and believes the evidence goes to show that lignin is not in chemical union with the cellulose. Cross and Bevan,² on the other hand, have concluded "that the fibre substance is not merely a mixture of cellulose with non-cellulose constituents, but that these are compacted together into a homogeneous though complex molecule by bonds of union of a strictly atomic character." They submit the following constitutional formula ³ for the lignin (lignone) of the typical lignocellulose, as representing its quantitative reactions of chlorination, resolution by bisulphites, production of acetic acid and estimation of methoxyl.

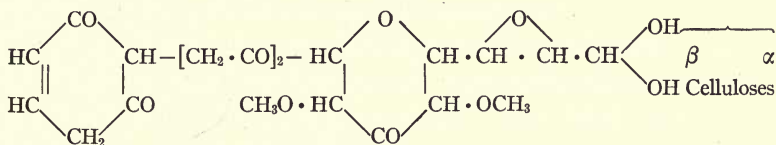

Lignin has been investigated by Heuser and Skiöldebrand ⁴

¹ Klason: Beitrage zur Kenntniss der chemischen Zusammensetzung des Fichtenholzes.

² Cross and Bevan: Cellulose, p. 134, London, 1895.

³ Cross and Bevan: Researches on Cellulose, III, 104.

⁴ Heuser and Skiöldebrand: Z. angew. Chem., 1919, 32, 41-45.

who prepared it from spruce wood sawdust by hydrolyzing with 42 per cent hydrochloric acid. The yield obtained was 33.12 per cent and the air dry lignin contained 9.25 per cent moisture and 0.485 per cent ash. It yielded no furfural but showed a copper number of 12.90 and a methyl value of 6.77 per cent. On destructive distillation it gave more charcoal and tar and less acetic acid than cotton or wood cellulose.

Lignin shows a number of color reactions which are of much value in detecting the presence of incrusting matters in paper or its raw materials. Nitric acid gives a yellowish brown color; a solution of aniline sulphate in water stains lignified tissues yellow; paranitroaniline in hydrochloric or sulphuric acid solution produces a bright yellowish orange color; while an alcoholic solution of phloroglucin acidified with hydrochloric acid develops an intense rose red or magenta color. This latter reagent has been used as a basis for a quantitative method for estimating ground wood in papers.¹ Schwalbe,² however, states that the color reaction with phloroglucin fails in many cases where lignified fibres are present and considers that the results should be confirmed in every case by Cross and Bevan's chlorination reaction.

One of the most characteristic reactions of lignin is that of direct combination with the halogens, and more especially with chlorine. In the presence of water, chlorine attacks lignin with the formation of a chloride, $C_{19}H_{18}Cl_4O_9$. This chloride is bright yellow in color and is soluble in sodium sulphite solution with the production of an intense magenta red color. With jute the chlorine combining with the lignin amounts to 8 per cent of the lignocellulose and an equal amount is combined as hydrochloric acid; with wood, on the other hand, the proportions are not equal, considerably more chlorine going to form hydrochloric acid than corresponds with that which is used in chlorinating the lignin. This reaction with chlorine is simple and there is no indirect oxidation as a result of the reaction $Cl_2 + H_2O = 2HCl + O$. The chlorinated material is homogeneous and as

¹ Cross, Bevan and Briggs: Chem. Ztg., 1907, 31, 725.

² Schwalbe: Z. angew. Chem., 1918, 31, pp. 50 and 57.

the cellulose is unattacked, maximum yields of the latter are obtained. This reaction forms the basis of Cross and Bevan's method for the quantitative determination of cellulose.

Determination of Cellulose. The amount of cellulose in any raw material determines the maximum yield of pure fibre which can be prepared by any of the chemical processes used in pulp making. Practically, however, the yield never reaches this theoretical maximum because of the hydrolytic action of the cooking liquors and the oxidizing and solvent action of the alkaline bleaching agents used. A method for accurately determining the cellulose in wood, or any fibrous raw material, is therefore of great value to the paper maker, in that it enables him, on the one hand, to detect variations in his supplies and, on the other, to see how nearly his processes are approaching the optimum.

A satisfactory method for the determination of cellulose must separate it in a form which is free from lignin and colored impurities and which is as pure as possible. Freedom from mineral matter is of secondary importance since it can be allowed for or removed by treatment with dilute acids. The formation of oxycellulose and hydrocellulose must especially be guarded against since in their formation part of the cellulose is converted to soluble products and moreover they are easily attacked by many of the reagents employed. Another consideration is that the process should involve no very complicated operations and that it should be capable of completion within a reasonably short time.

Many methods for determining cellulose have been proposed, of which some do not remove all non-cellulose matter, some destroy part of the cellulose itself, and some, which give pure products, are too long and complicated for practical work. It is unnecessary to give the full details of all the proposed methods, but a very brief description may prove of interest to those who wish to study into the subject. The following outlines, together with notes on the purity of the products, are taken from Renker's¹ work on methods of determining cellulose.

¹ Renker: *Über Bestimmungsmethoden der Cellulose*, Berlin, 1910.

König¹ heats 3 grams of the sample with 200 c.c. of glycerine (sp. gr. 1.230) and 4 grams of concentrated sulphuric acid. The flask is fitted with a reflux condenser and the heating is continued for just one hour at the boil (131 to 133 degs.); the residue is then washed with hot water, alcohol and ether, dried and weighed. This process strongly attacks the cellulose and the product is not pure cellulose though entirely free from pentosans.

Cross and Bevan's² method depends upon the chlorination of the lignin by treating the moist material with chlorine gas and the subsequent solution of the chlorinated products by boiling with dilute sodium sulphite solution. The cellulose obtained is pure white and free from lignin, but consists, according to the terminology of Cross and Bevan, of a mixture of α and β celluloses, the latter being of low resistance toward hydrolytic agents and yielding furfural on boiling with hydrochloric acid.

Modifications of Cross and Bevan's method in which chlorine water is used instead of the gas give lower yields and the product contains some oxycellulose.

In H. Müller's³ process the sample, after extraction of the resins and boiling in water, is treated with 5 to 10 c.c. of dilute bromine water diluted with 100 c.c. of water. When the color indicates that the bromine is all used up, more bromine water is added until an excess of the reagent remains; this takes from 12 to 24 hours. The residue is filtered off and washed. This process is repeated until the fibrous residue is pure white. This process yields highly pure cellulose which is free from oxycellulose but too long a time is required, especially with woods which may require twenty repetitions of the treatment. Klason's⁴ modification, involving preliminary treatment of the sample with calcium or magnesium bisulphite solution, gives lower yields than Müller's original method and, although the

¹ König: Z. Nahr. Genussm., 1, 8 (1898).

² Cross and Bevan: Cellulose, 95 (1895).

³ Hofmanns Ber. über die Entwickl. d. chem. Industrie, III, 27 (1877).

⁴ 5 Internationaler Kongress für angewandte Chemie, 1903, I, 309.

time required is less, the method is still unsatisfactory technically.

The Schulze-Henneberg¹ method consists in digesting the sample for 12 to 14 days at 15° C. with 0.8 part KClO₃ and 12 parts HNO₃ (1.10 sp. gr.). This is followed by dilution, filtering and washing and then by digestion with dilute ammonia for 45 minutes at 60° C. The residue is washed with ammonia and finally hot water. This process requires an excessive time and very careful control of the temperature, and the results obtained are low and irregular, especially with woods.

Hoffmeister² treats the sample with hydrochloric acid (1.05 sp. gr.) and as much potassium chlorate as will dissolve during the reaction. The digestion is conducted at ordinary temperature,—not over 17.5° C.,—with frequent shaking for 24 to 36 hours or until all parts of the fibre have become a clear yellow. The residue is then washed, digested on the water bath for 1 to 2 hours with dilute ammonia, washed, dried and weighed. This process yields a product which is free from lignin but is somewhat yellow; the cellulose is somewhat attacked and oxycellulose is present.

Digestion at 60 degs. with a large excess of nitric acid (10 per cent) has been proposed by Cross and Bevan.³ When the fibre has changed to a yellow color it is washed and treated with a solution of sodium sulphite. This treatment hydrolyzes and dissolves the β cellulose and leaves only the more resistant α cellulose; this results in low yields as compared with the chlorination process. The products are free from lignin but contain oxycellulose and apparently also hydrocellulose.

Lifschütz⁴ digests the material for 14 to 16 hours at a temperature of 45 to 60 degs. with 10 parts of a mixture of 32 per cent sulphuric acid, 18 to 20 per cent nitric acid and 48 to 50 per cent water. With wood, very low yields are obtained and the prod-

¹ Ann., 146, 130 (1868).

² Landw. Jahrb., 17, 240 (1888).

³ Cellulose, 97 (1895).

⁴ Ber., 24, 1188 (1891).

uct forms a brownish horny mass which is free from lignin but contains considerable oxycellulose.

Schwalbe¹ treats the moist material for several hours with gases containing oxides of nitrogen, washes and heats on the water bath with a 2 per cent Na_2SO_3 solution. The cellulose thus obtained is free from lignin but contains oxidation products and is brownish yellow. The results are very variable when woods are analyzed.

Zeisel and Stritar² suspend the sample in dilute nitric acid and add a 3 per cent solution of potassium permanganate a cubic centimeter at a time until the color persists for half an hour; during this treatment cooling and stirring are necessary. The manganese salts are removed by SO_2 -water or NaHSO_3 and after washing the residue is digested with dilute ammonia. It is claimed that hemicelluloses and about 4 per cent of the cellulose are dissolved. The method gives low and variable results, forms much oxycellulose and is unsatisfactory for woods.

Neutral permanganate does not remove all the lignin, while if it is used with acetic acid the product is free from lignin but contains oxycellulose. Permanganate with hydrochloric acid works fairly well with cotton, jute and sulphite, but with woods the treatment must be many times repeated and the results are low.

Sodium hypochlorite was found to give low results and though the product was free from lignin it was very high in oxycellulose.³

After a large number of experiments with the different methods, Renker concludes that there is no absolutely correct method for determining cellulose but that the method of Cross and Bevan using chlorine gas is the most satisfactory. König and Huhn,⁴ on the contrary, contend that Cross and Bevan's method gives too high results because it fails to remove pentosans and hemicelluloses which remain as impurities in the product. They

¹ D.R.P., 204,460.

² Ber., 35, 1252 (1902).

³ Renker: Bestimmungsmethoden der Cellulose, 79.

⁴ Z. Farben-Ind., 1911, 11, 297 *et seq.*

claim that only hydrolysis followed by oxidation can free the true cellulose from all impurities. This brings up the question of what constitutes pure cellulose, which has never been settled beyond dispute and about which there are probably as many opinions as there are methods for its determination.

The results obtained by Renker, in his investigation of the different methods for the determination of cellulose, are given in the accompanying table. The percentages are based on material free from ash, fat or rosin, and water-soluble substances.

Method of analysis	Material			
	Sulphite cellulose	Jute	Wood	Cotton
	Per cent	Per cent	Per cent	Per cent
Glycerine-sulphuric acid. — König.....	74.15
Chlorine gas. — Cross and Bevan.....	97.9	84.5	60.55	97.85
Concentrated chlorine water.....	97.65	83.4	57.1	94.7
Dilute chlorine water.....	98.0	81.1	96.8
Bromine water. — H. Müller.....	98.1	83.3	57.95	97.1
Bromine water. — Müller-Klason.....	96.6	80.8	51.85	95.45
Nitric acid and potassium chlorate. — Schulze.....	98.05	79.2	58.1	96.95
Muriatic acid and potassium chlorate. — Hoffmeister.....	98.25	82.5	57.15	96.15
Nitric acid. — Cross and Bevan.....	97.65	79.75	53.6	96.35
Nitrous acid. — German pat. 204,460.....	98.2	80.65	55.8	98.85
Nitric-sulphuric acids. — Lifschütz.....	43.35
Potassium permanganate and nitric acid. — Zeisel and Stritar.....	90.6	70.95	40.2*	93.25
Potassium permanganate, neutral.....	98.5*	87.4*
Potassium permanganate and acetic acid...	98.25	83.6	97.6
Potassium permanganate and hydrochloric acid.....	97.9	82.9	43.0	96.65
Hydrogen peroxide.....	96.05	96.55
Sodium hypochlorite.....	97.4	83.4	50.5	96.8
Phenol. — German pat. 94,467.....	90.75	79.4	51.9	94.2

* Inapplicable because lignin is not all removed.

All things considered the Cross and Bevan method, employing chlorine gas, is doubtless the best means of determining cellulose, especially where woods are under consideration, since it has been proved by Heuser and Sieber¹ that lignin can be completely removed by chlorination without any oxidation of the

¹ Z. angew. Chem., 26 (1913), 801.

cellulose, and because the color produced by sodium sulphite on chlorinated lignin is characteristic and forms a good indicator to show the degree of purification. If, however, the chlorine is allowed to act after the lignin is all removed the cellulose is gradually converted to oxycellulose, which is soluble in sodium sulphite, and lower yields result. According to one's understanding of pure cellulose it may or may not be advisable to accompany this treatment with one of acid hydrolysis.

Even where Cross and Bevan's method has been employed the different methods of operation render the figures of different observers hardly comparable. The wood must be very finely divided and of uniform particles. If coarse pieces are present the lignin chloride formed on the surface prevents further penetration of the gas and long exposure is of little use unless the lignin chloride is removed. Variation in the size of the wood particles also means that a portion will be over-treated in order to insure the complete removal of the lignin from the rest, and this results in lower yields. To avoid many of the manipulative variations Johnsen and Hovey¹ worked on wood reduced to a fine "sawdust" by rasping with a suitable wood rasp, and screened to pass an 80-mesh but not a 100-mesh sieve. This they chlorinated in a Gooch crucible, the small plate of which was carefully covered with fine bleached cloth sewn on with cotton thread. Their method, which includes a preliminary hydrolysis, is in detail as follows:

Two samples of about one gram each of air dry sawdust are weighed exactly, transferred to small flasks and heated for one-half hour with alcohol, on a water bath, filtered through the crucibles and washed with hot alcohol. The material is then transferred from the crucibles to 150 c.c. flasks and covered with about 75 c.c. of glycerine-acetic acid mixture (60 grams glacial acetic acid and 92 grams glycerine, 1.26 sp. gr.). The flasks are then heated in an oil bath at 135° C. for four hours, using glass tubes as reflux air condensers. The material is then collected in the crucibles, washed well with hot water and the

¹ Pulp and Paper Mag. Can., XVI (1918), 85.

crucibles, after cooling, are placed in an apparatus permitting washed chlorine gas to be passed directly through the crucible and its contents. After passing chlorine through continuously for 20 minutes the free gas is removed by washing once with a cold, weak solution of sulphurous acid in water, and the crucibles are placed in small beakers which are filled not quite to the top of the crucibles with a 3 per cent solution of sodium sulphite. After the beakers have been heated in a water bath for three-quarters of an hour the material in the crucibles is washed with hot water, using a filtering flask, and allowed to cool. The chlorination process is then repeated three times exactly as before except that the duration of gassing is 15, 15 and 10 minutes. After the last treatment with sodium sulphite the fibres are thoroughly washed, dried at 105° C. for four hours, or to constant weight, and weighed in closed weighing bottles. The moisture in a separate sample of the original sawdust having been determined, the per cent of cellulose can be calculated over to the basis of bone dry wood.

Working by this method the lignin may be completely removed from finely divided wood in four chlorinations totalling one hour's exposure to the gas. If the treatment with glycerine and acetic acid is omitted the results are 2 to 4 per cent higher, indicating the extent to which hydrolysis removes substances which are not dissolved by the straight chlorination process.

CHAPTER II

FIBROUS RAW MATERIALS

The Vegetable Cell. The structural unit of which the plant fabric is composed is the cell, and even those elements which are least cellular in appearance, as fibres, ducts, etc., are only transformed cells, or simple combinations of them. In all of the higher forms of plant life the living cell consists essentially of protoplasm surrounded by a wall of cellulose. The protoplasm is practically transparent and colorless but it is seldom found without an admixture of other matter which gives it a granular appearance. Chemically considered it is a very complex substance belonging to the group of albuminoid bodies and is quite similar in composition and appearance to the albumin which forms white of egg.

The cell wall is produced from the substances contained in the protoplasm and is formed in close contact with the limiting film of the latter. At first it is an even, homogeneous film showing no obvious structure but it soon becomes modified in appearance and composition according to its location in the plant; in some cases it becomes capable of absorbing a large amount of water with a consequent increase in volume and the formation, upon warming, of a thick mucilage. In other cases it becomes mineralized by the deposition of silica or calcium salts upon or within the cell wall, the effect being a hardening and stiffening of the structure as illustrated by many of the grasses and straws. A third modification of the cell wall is known as cutinization or suberification. Ordinary cell walls absorb water freely but in certain parts of the plant they are water-repellent due to the presence of cutin or suberin. This water-proofing of the cell wall may be superficial only or it may permeate the entire structure of the wall as in the case of cork.

A fourth change, which, from the point of view of the paper maker, is far more important than the others, is known as lignification and is caused by the deposition in and upon the cell-wall of a substance somewhat similar to cellulose and which is termed lignin. This material, although generally spoken of as a single substance, is in all probability made up of several closely related substances. It forms by far the greater part of the incrusting matters which are removed by the treatment with chemicals in preparing celluloses for paper making. The chemical properties of the lignocelluloses have already been described in the preceding chapter.

The thickening of the cell wall, which up to a certain age accompanies the deposition of lignin, seldom takes place uniformly over its entire surface. As a result the fibres may show ridges, depressions, pits, rings, spirals and other markings, which are often so characteristic as to be of great assistance in the identification of the fibres in which they occur. In some cases it is easy to see that the markings are pores or fissures running from one cell to the next. Such pores and the thinner portions of the cell walls aid in the transmission of sap.

In many plants gums and resins are formed by processes which are not well understood but which are probably in large part degradations of the cell walls. The products of such changes are often found as small, irregular drops either within the cells or in the spaces, known as resin ducts, arising from the confluence of a number of cells. The resins are soluble in alcohol or in solutions of the alkalis; they are colored reddish orange by a solution of Sudan III in diluted alcohol and when stained in this way may be readily recognized under the microscope.

It is only the living cells which contain protoplasm and these are found at the points where growth is taking place. The older cells, where growth has ceased, occasionally contain a little water but generally only air, more or less highly rarefied. They are still of value in the plant structure for it is from such lifeless cells that stiffness and strength are derived. Cells are present in different plants in an almost infinite diversity of form, but,

except for those cases which assist in the identification of the fibres which they accompany, the following discussions will be confined to the long, slender pointed elements of the bast or woody tissues, which, with the single exception of cotton, are the only ones of practical interest to the paper maker. Such fibres are derived from the ordinary cells simply by growth and change of form.

The paper making fibres may be divided, according to their source, into four classes.

1. Seed hairs, of which cotton is the only representative.
2. Bast fibres, as hemp, flax, manila, etc.
3. Those derived from whole stems, such as straw, esparto, or bamboo, and which are associated with various cells and vessels which are not properly fibres.
4. Fibres derived from wood.

Seed Hairs

Cotton (*Gossypium*). The cotton fibre consists of a single hair-like cell, which when fully ripe is flattened and twisted. This appearance is a characteristic of fully matured cotton and is not shown by unripe fibre or that which has been injured during growth. The fibres form the covering of the cotton seed and are removed from the seed by ginning. The length of the cotton fibre varies from 2 to 5.6 cm. and the diameter from 0.0163 to 0.0215 mm.; the longest fibres are found in the Sea Island cottons, followed by Egyptian, Brazilian, American and East Indian. The cell walls of the mature cotton are thin and often present a granulated appearance, or highly characteristic cross-markings.

Raw cotton has been examined by Schunck who found in it two coloring matters, both containing nitrogen; a wax similar to carnauba wax; albuminous matter and a solid crystalline fatty acid. Müller has analyzed raw cotton with the following results:

	Per cent
Water.....	7.00
Cellulose.....	91.35
Fat.....	0.40
Aqueous extract (containing nitrogeous substances).....	0.50
Ash.....	0.12
Cuticular substance (by difference).....	0.63

Cotton reaches the paper mill in the form of rags and spinning waste. The short fibres removed from the seed hulls by mechanical processes are also occasionally available and can be used in high-class papers.

Bast Fibres

Under this heading are included the fibres found in the inner bark of various plants. These are often present in the plant in the form of bundles of considerable length and it is these fibre bundles or filaments which are of particular interest in textile work, while the paper maker is concerned only with the ultimate fibres composing these filaments. The fibres are usually firmly attached to those above and below them, either by incrusting matters or by partial identity of their cell walls, so that a chemical treatment is generally necessary in separating them. The filaments, on the other hand, are isolated from the surrounding tissues by various mechanical or chemical processes, one of the commonest being retting as applied to flax and hemp.

The walls of bast fibres are usually of considerable thickness and the central canal varies greatly in the different species and even in different individuals of the same species. The irregularities of the cell walls are such as to cause thickenings or knots in some cases, projections into the cell cavity or outward from the walls, and various other characteristic appearances. Variations in the amount of lignification and in the nature of the materials deposited in and on the cell walls are frequently sufficiently characteristic to assist materially in their identification.

Linen. Linen is composed of the bast fibres of the flax plant *Linum usitatissimum*. The plant yields about 8 per cent of

fibre which is separated by retting and is then known as flax. The ultimate fibres are 6 to 60 mm. long and 0.012 to 0.026 mm. wide with an average ratio of length to width of about 1200. They are thick walled tubes with thickened places or knots at intervals. The ends are tapered, the walls rather transparent, and the canal is small. Müller gives the analyses of two samples of Belgian flax as follows:

	Per cent	Per cent
Water.....	8.60	10.56
Cellulose.....	81.99	70.55
Fat and wax.....	2.37	2.34
Aqueous extract.....	3.62	5.94
Ash.....	0.70	1.32
Pectous substances.....	2.72	9.29

Linen or flax reaches the paper mill in the form of scutching refuse, spinning waste, threads, rags, etc. It requires much the same treatment as given to cotton except that it is necessary to employ a rather more severe bleaching process.

Hemp (*Cannabis sativa*). The fibre is prepared by retting, from filaments which run the entire length of the stem. The ultimate fibres composing these filaments vary from 5 to 55 mm. and average about 22 mm. long by 0.022 mm. in diameter, the ratio of length to diameter being therefore about 1000. The fibres have very thick walls which are not very highly lignified. The ends are large and sometimes flattened and the central canal is almost obliterated. In microscopic appearance the fibres are very similar to those of flax; they show the same knots or thickenings and the same striæ, but they differ from linen in having more ability to break down into fibrillæ during the mechanical processes of paper making.

Müller gives the following as the analysis of a sample of raw Italian hemp.

	Per cent
Water.....	8.80
Cellulose.....	77.13
Fat and Wax.....	0.55

	Per cent
Aqueous extract.....	3.45
Ash.....	0.82
Pectous substances.....	9.25

Many other plants yield fibres to which the name hemp is given but they are generally distinguished as manila hemp, sisal hemp, sunn hemp, etc.

[Hemp comes to the paper mill in the shape of rags, rope and cordage, etc. It is used in high-grade papers, particularly very thin sorts, where its ability to split into fibrillæ makes it especially valuable.

Manila Hemp (*Musa textilis*). Manila is prepared from the outer sheath of the stems of the *Musa*, which is a species of banana, by stripping, scraping and drying. It is sometimes further purified by washing and beating.

The ultimate fibres are from 3 to 12 mm. long and average about 6 mm.; the width varies from 0.016 to 0.032 mm. with an average of 0.024 mm. The fibres taper very gradually toward the ends; the central canal is large and very prominent, while fine cross-markings are numerous.

The composition of raw manila is given by Müller as follows:

	Per cent
Water.....	11.73
Cellulose.....	64.07
Fat and wax.....	0.62
Aqueous extract.....	0.96
Ash.....	1.02
Lignin and pectous substances.....	21.60

The paper maker obtains manila fibre almost entirely in the form of old ropes and cordage. It is generally given a comparatively light alkaline treatment with lime and used in the unbleached condition for papers where strength is of far more importance than cleanliness or color. It is occasionally bleached to a light yellowish shade for some grades of paper.

Jute (*Corchorus capsularis* and *C. olitorius*). The filaments are obtained by a retting process, and are used in the manufacture of twine, cordage, and woven goods such as burlap.

It is in these forms and also as "butts" and "rejections" that it reaches the paper maker.

The fibres of jute are about 2 mm. long and 0.022 mm. in diameter. They are thick-walled and the central canal is very variable, at times being of considerable width and then narrowing to hardly more than a line. The surface is quite smooth and at intervals may be noticed radial canals and joints similar to those in linen though not so pronounced. As used in paper making the fibres are not completely separated, so that bundles of fibres are of frequent occurrence.

Jute has been carefully studied by Cross and Bevan who regard it as typical of lignified fibres. They consider it as a chemical unity, which they term lignocellulose, and which splits up into cellulose and other products on treatment with suitable reagents.

Müller gives the composition of the raw fibre as follows:

	First quality	Butts
	Per cent	Per cent
Water.....	9.86	12.40
Cellulose.....	63.76	60.89
Fat and wax.....	0.38	0.44
Aqueous extract.....	1.00	3.89
Ash.....	0.68	1.40
Lignin or non-cellulose.....	24.32	20.98

Adansonia (*Adansonia digitata*). This fibre, which is derived from the inner bark of the baobab, or monkey bread tree, of Africa, has been used to some extent in preparing papers where the very highest strength is a necessity. The composition of the bast as exported varies, as shown below:¹

	Per cent	Per cent
Water.....	10.90	13.18
Cellulose.....	49.35	58.82
Fat and wax.....	0.94	0.41
Aqueous extract.....	13.57	7.08
Ash.....	6.19	4.72
Pectous substances.....	19.05	15.19

¹ Griffin and Little: Chemistry of Paper Making, p. 128.

Paper Mulberry Tree (*Broussonetia papyrifera*). The fibres of the paper mulberry are used by the Japanese in the preparation of some of their peculiar papers. They are separated from the inner bark of the tree by scraping, soaking and maceration in water, and are sometimes purified still further by boiling in weak alkaline solutions. As used in Japanese papers the fibres are generally unbroken.

The fibres are long and slender, varying in length from 6 to 20 mm., with an average width of 0.030 mm. They are nearly transparent when viewed under the microscope, and show transverse jointings as well as longitudinal striæ. The central canal generally shows as a well-defined line and the ends are sometimes blunt and rounded, sometimes fringed.

Agave. Fibres are prepared from the leaves of various species of agave by maceration or scraping. The filaments thus obtained are light colored, lustrous and comparatively stiff. Among the most common of the fibres of this class is sisal hemp or heniquen, which is largely employed for cordage, bags, etc., in which forms it reaches the paper mill.

The ultimate fibres are long, of rather small diameter, tapering and pointed at the ends. The central canal is not prominent but can be seen as a narrow line in some of the fibres. The walls are thick and are characterized by many fine cross lines, close together, which are found on nearly every specimen. The fibres are harsher than paper mulberry and longer than manila.

Fibres Derived from Whole Stems

The fibres in this class, being produced by treatment of the entire stems, include the ultimate fibres from all structural elements of the stem proper, together with cells from the epidermis and other parts of the plant.

Straw. In straw pulp the bast cells or fibres form the greater part of the pulp. These are comparatively short and slender with sharp pointed ends; at quite regular intervals the walls appear to be thickened and drawn together to resemble joints.

The dimensions of straw fibres vary with the kind of straw and with the conditions of growth, nature of soil, etc. [They are longer than those from esparto but not so long as the fibres from spruce wood and would compare more nearly with poplar fibre in paper making value.]

Accompanying the bast fibres in straw pulp are numerous epidermal cells with toothed or serrated edges, and also smooth, thin-walled cells from the pithy portion of the stem. The latter vary in shape from nearly round to long, oval cells whose length is several times their width. Both types of cell aid materially in the identification of straw pulp.

Esparto (*Stipa tenacissima* and *Lygeum Spartum*). The bast fibres are grouped in bundles or filaments which are resolved into ultimate fibres by the chemical processes employed. [The fibres are shorter and more even than those from straw,] averaging about 1.5 mm. in length, and the central canal is nearly closed. Serrated cells are numerous but considerably smaller than those from straw, while the smooth, thin-walled cells are absent. The chief characteristic which distinguishes esparto from straw and other fibres is the presence of small tear-shaped cells derived from the hairs on the surface of the leaves.

The composition of esparto is given by Müller as follows:

	Spanish	African
	Per cent	Per cent
Water.....	9.38	8.80
Cellulose.....	48.25	34.80
Fat and wax.....	2.07	2.62
Aqueous extract.....	10.19	9.81
Ash.....	3.72	3.67
Pectous substances.....	26.39	29.30

Cross and Bevan¹ give the percentage of cellulose in air dry esparto as follows:

	Per cent
Spanish.....	58.0
Tripoli.....	46.3
Arzew.....	52.0
Oran.....	45.6

¹ Cross and Bevan: Text Book of Paper Making.

Bamboo. Bamboo fibres closely resemble those from the straws in many of their characteristics. According to Raitt¹ the average length of the ultimate fibres is from 2.20 mm. to 2.60 mm. according to the variety, and the diameters are from 0.018 to 0.027 mm. While not so long as spruce fibres they are much longer than those from any of the deciduous trees. Accompanying the true fibres are numerous serrated cells and ovoid pith cells of various sizes and shapes. Cells similar to the tear-shaped cells of esparto have also been noticed. Many of these different cells are very small and a good proportion of them would be lost during the preparation of the pulp.

The number of species of bamboo runs into the hundreds and not all of them are suited for paper making work because of the difficulties in reduction to pulp and bleaching to good color.

Rushes. In many districts there are large areas of swamp-land densely covered with rushes of various kinds. Investigation has shown that the fibres in these are very similar to esparto and that pith cells are also present though they are far smaller than those from straw and many would be lost during the washing and bleaching of the fibre.

Examination of rushes from South Carolina showed that they contained 35 per cent of cellulose and that of this about 30 per cent consisted of fine pith cells which would wash easily through a 100-mesh sieve.

Rushes appear to require a more drastic cooking treatment than straw or esparto and the fibres bleach a little harder. They are, however, potential sources of fibre which can be availed of when necessity arises.

Bagasse and Corn Stalks. These two materials are so similar in their fibrous characteristics and in the treatment necessary in cooking them that they may be considered as practically identical. Bagasse, the crushed stalks of the sugar cane, is produced in large quantities in the sugar industry and is generally burned as fuel, though its value for this purpose is com-

¹ Raitt: Indian Forest Records, Vol. III, Part III.

paratively low because of its wet condition. It is estimated that seven States in the "corn belt" produce annually about eighty million tons of corn stalks of which the greater part is practically a waste.

Both of these materials can be reduced to a pulp quite easily by the soda process and the pulp will bleach to a good white color with less than 10 per cent of bleach. The ash in the stalks is considerably lower than that in straw and contains much less silica, so that its effect on the recovery process is very slight.

The pulp from both raw materials consists of long thick-walled fibres mixed with shorter fibres of similar structure and cells of various shapes and sizes. These include serrated cells of comparatively large size, long thick cells with rounded ends and many pith cells which are so thin-walled that nearly all become flattened during the reduction process. These pith cells are much larger than those from straw and are therefore much more difficult to remove by washing. They impart to the paper made from this fibre a hardness and rattle which are undesirable in many products, and as their separation from the rest of the fibre has proved very difficult the presence of pith has proved one of the chief stumbling blocks in the way of using either bagasse or corn stalks.

Miscellaneous Materials. Among the many substances proposed as sources of fibre the following may be considered as falling in this class: papyrus¹ which grows in immense quantities along the Nile and which yields about 33 per cent of easy-bleaching pulp when cooked by the soda process; asparagus² waste from canning factories and dry stalks at the end of the season; pea and bean vines³ which according to Reinke yield better fibre than asparagus; cotton stalks, of which immense quantities are burned every year, but which so far have never been utilized successfully; zacaton, a Mexican grass, which has been carefully investigated by the Bureau of Plant Indus-

¹ Beam: Chem. Section Bull. No. 2, Welcome Tropical Research Lab. Sudan.

² Reinke: Chem. Ztg., 1913, 37, 81.

³ Reinke: J. Soc. Chem. Ind., 1913, 594.

try;¹ tropical grasses, numerous species of which have been tried on an experimental scale by Raitt,² Richmond³ and others. Many of these have been found to produce excellent fibre.

Peat also might possibly be considered in this class. Numerous attempts have been made to produce useful fibre from peat, the treatments given ranging from an entirely mechanical process, through treatment with alkalis and acids, to fermentation processes. All methods have thus far failed to produce a fibre which can be used in anything but the coarsest products.

Woods

The woody tissues of plants are made up of cells which exhibit great diversity of form, size, and markings as the accompanying drawings Figs. 1 and 2 show. Those in which the paper maker is particularly interested are the true wood fibres, or libriform cells, and the tracheids, but many of the other cells are of incidental interest as helping to identify the wood from which they were derived.

The wood fibres are always spindle or fibre-form and the walls are relatively strongly thickened. They never have true spiral striations; in only a few species do they show pits, which are generally elongated and oblique. Wood fibres are variable in length in different woods, ranging from 2.0 mm. to 0.14 mm., but in all cases they are the longest elements present. As an example of wood fibres may be cited the chemical pulp made from poplar wood; this contains in addition only the ducts and rarely a few of the small cells from the medullary rays.

Tracheids are elongated and tapering cells, more or less lignified and having peculiar markings known as bordered pits or discoid markings. Fig. 3 shows these as they appear on the surface of the fibre and illustrates how they are formed by the thin partition wall between two tracheids. These pits are so constant in number and mode of distribution that they may be

¹ Brand and Merrill: Bull. No. 309, U. S. Dept. of Agriculture.

² Raitt: Indian Forest Records, Vol. V, Part III.

³ Richmond: Philippine J. Sci., 1906, 1, 433-462.

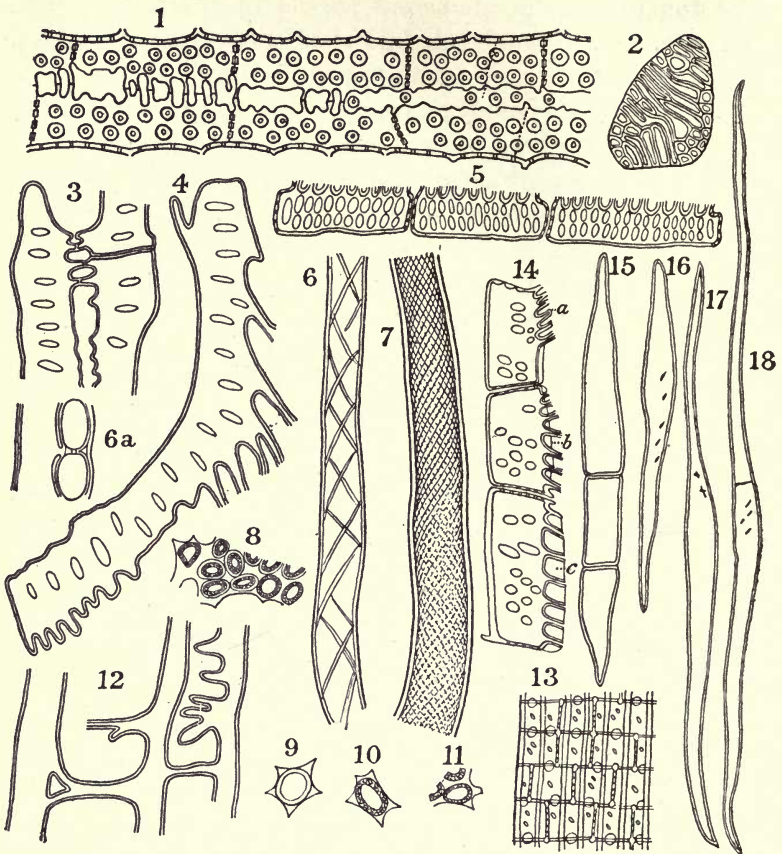

FIG. 1 DRAWINGS OF WOOD-ELEMENTS

1-7. *Avicennia* sp. 1. Wood-parenchyma cells; tangential section. 2. Septum of a duct. 3, 4, 5. Conjugate wood-parenchyma cells. 6, 7. Portions of spirally striated libriform fibres. 8-11. Bast cells of *Cytisus laburnum*. 8. Cross-section through young bast bundle acted on by chloriodide of zinc. 9, 10, 11. Cross-sections through young bast cells similarly treated. 12. *Porlieria hygrometrica*; radial section of conjugate substitute fibres. 13. *Jatropha manihot*, radial section through wood. 14-18. *Tectona grandis*; elements separated by maceration. 14. Conjugate wood-parenchyma cells. 15. Ordinary wood-parenchyma fibre. 16. Substitute fibre. 17. Libriform fibre. 18. Septate libriform fibre.

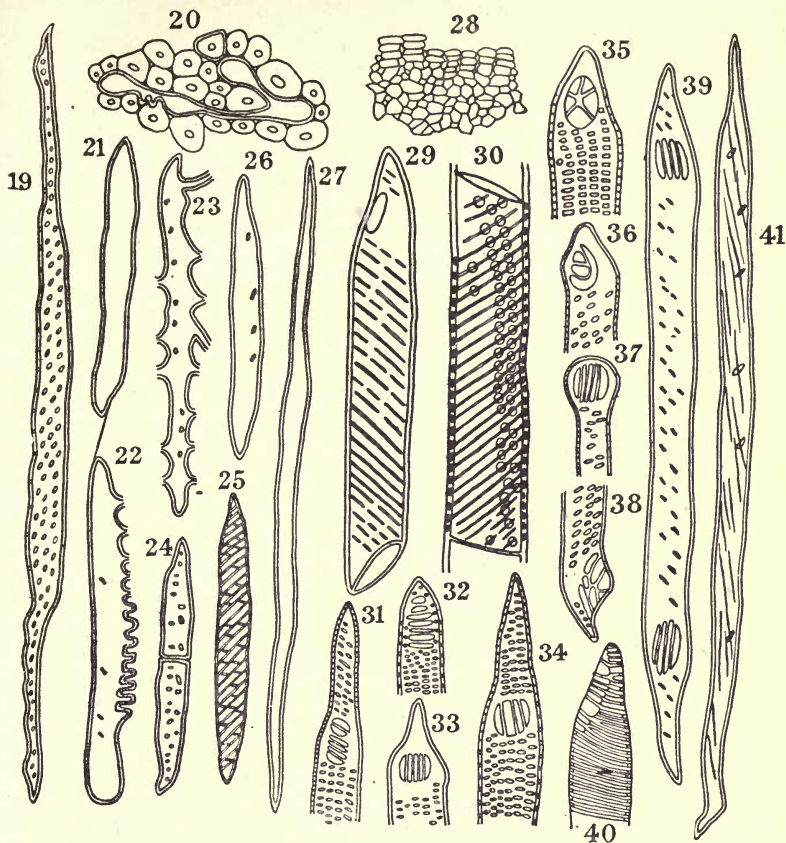

FIG. 2. DRAWINGS OF WOOD-ELEMENTS

19. Tracheid from *Tectona grandis*. 20-23. *Porlieria hygrometrica*. 20. Conjugate substitute fibres in cross section. 21. Ordinary substitute fibre after maceration. 22, 23. Conjugate substitute fibres after maceration. 24-27. *Cytisus laburnum*; elements after maceration. 24. Wood-parenchyma fibre. 25. Tracheid. 26. Substitute fibre. 27. Simple libriform fibre. 28. Cross-section through cambium and youngest wood of *Cytisus laburnum*. 29, 30. *Mahonia aquifolium*; ducts. 29. After maceration. 30. Longitudinal section. 31-36. Extremities of ducts separated by maceration from *Hieracium*. 37-39. Ducts from *Onopordon acanthium*. 40. Spirally marked duct from *Vitis vinifera*. 41. Libriform fibre from *Jatropha manihot*.

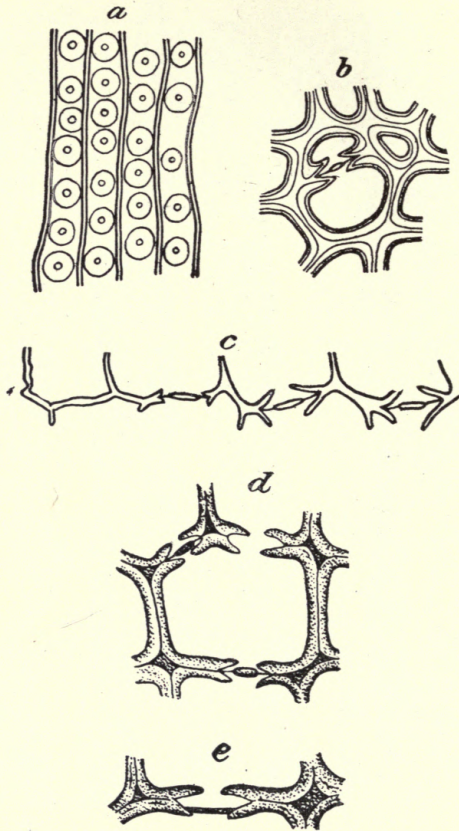

FIG. 3. DISCOID MARKINGS ON WOOD CELLS

Pinus laricio; *a*. Radial walls; *b*. A transverse section.

Pinus sylvestris; *c*. Development of markings; *d*, *e*. Transverse sections of nearly perfect and perfect discoid markings.

used as a distinguishing characteristic for some woods. In cone-bearing or coniferous trees, such as spruce, fir, hemlock, etc., the wood consists almost entirely of tracheids, and when sulphite fibre or ground wood from such trees is examined under the microscope the discoid markings may be very readily seen. These tracheids are generally much longer than the libriform

Residual
fibres from other woods and hence possess greater paper making value.

Sap and Heartwood. The sapwood, or that of comparatively recent growth, is usually lighter in color and contains more fermentable material than the older and denser heartwood. Each year a layer of sapwood goes over into heartwood which becomes darker and harder from infiltration of coloring matters, resins, etc. The sapwood is generally preferred for pulp because it is more easily reduced by either the mechanical or chemical processes. In some woods, as fir and buckeye, the difference in color and hardness between heartwood and sapwood is not in evidence.

Fibre Length. The length of the fibres or tracheids in a given tree is known to vary with the position from which the sample was taken. This has been very carefully investigated for coniferous woods by Mell,¹ who finds that the length of tracheids varies considerably not only in different parts of the same tree, but also within the same annual ring at the same distance above the ground. In both trunk and branches the average length increases from the center outward until the tree reaches its maximum height growth, after which it remains quite constant. The highest average length of tracheids in the branches is usually less than in the trunk. Tracheids also vary in length according to the character of the soil and the amount of moisture, those from trees growing in rich, moist soil being longer than those from trees grown in dry soil. Lee and Smith² have also made very careful studies along similar lines of one or two trees of Douglas spruce. Their observations are in general confirmatory of those of Mell, though in some respects their conclusions are different.

Because of these variable factors it is very difficult to determine the average length of tracheids or of the libriform cells of broad-leaved woods. The following table by Mell gives the length of tracheids of many of the coniferous woods of the United States;

¹ Mell, Paper Trade J., June 15, 1911.

² Forestry Quarterly, Dec., 1916.

the figures are the averages of many measurements of samples taken from different parts of the trunks and branches.

Names of trees	Length of fibres		
	Mm.* aver.	Mm. Max.	Mm. Min.
Amabilis fir (<i>Abies amabilis</i>)	3.11	5.62	1.49
Balsam fir (<i>Abies balsamea</i>)	3.10	4.21	1.98
White fir (<i>Abies concolor</i>)	4.63	6.03	2.73
Lowland fir (<i>Abies grandis</i>)	4.14	5.70	2.89
Alpine fir (<i>Abies lasiocarpa</i>)	3.16	4.13	2.07
Noble fir (<i>Abies nobilis</i>)	4.02	4.96	2.64
Port Orford cedar (<i>Chamaecyparis lawsoniana</i>)	3.63	4.38	2.56
Yellow cedar (<i>Chamaecyparis nootkatensis</i>)	2.47	3.02	1.93
White cedar (<i>Chamaecyparis thyoides</i>)	2.10	2.81	1.43
Western larch (<i>Larix occidentalis</i>)	2.59	3.80	1.73
Incense cedar (<i>Libocedrus decurrens</i>)	4.01	4.71	2.97
White spruce (<i>Picea canadensis</i>)	3.53	4.21	2.31
Engelmann spruce (<i>Picea engelmanni</i>)	5.71	6.94	3.06
Black spruce (<i>Picea mariana</i>)	3.48	4.13	2.89
Red spruce (<i>Picea rubens</i>)	2.97	3.63	2.48
Sitka spruce (<i>Picea sitchensis</i>)	2.87	3.72	2.31
Knobcone pine (<i>Pinus attenuata</i>)	2.06	2.40	1.24
Sand pine (<i>Pinus clausa</i>)	2.85	4.38	1.32
Jack pine (<i>Pinus divaricata</i>)	5.06	6.53	3.72
Shortleaf pine (<i>Pinus echinata</i>)	5.89	7.19	4.38
Piñon (<i>Pinus edulis</i>)	1.96	2.56	1.49
Limber pine (<i>Pinus flexilis</i>)	2.94	3.96	1.90
Spruce pine (<i>Pinus glabra</i>)	4.13	5.45	2.73
Sugar pine (<i>Pinus lambertiana</i>)	4.47	5.86	2.73
Silver pine (<i>Pinus monticola</i>)	4.39	5.45	2.73
Lodgepole pine (<i>Pinus murrayana</i>)	2.63	3.72	1.82
Longleaf pine (<i>Pinus palustris</i>)	5.53	6.69	2.97
Western yellow pine (<i>Pinus ponderosa</i>)	3.32	3.96	2.48
† Western yellow pine (<i>Pinus ponderosa</i>)	2.35	3.30	1.40
Parry piñon (<i>Pinus quadrifolia</i>)	2.10	2.89	1.49
Red pine (<i>Pinus resinosa</i>)	4.03	4.79	3.22
Pitch pine (<i>Pinus rigida</i>)	3.86	4.71	2.48
Pond pine (<i>Pinus serotina</i>)	4.20	6.36	2.64
White pine (<i>Pinus strobus</i>)	3.53	4.54	3.22
Loblolly pine (<i>Pinus taeda</i>)	3.10	3.88	2.56
Scrub pine (<i>Pinus virginiana</i>)	2.73	3.96	1.73
Red fir (<i>Pseudotsuga taxifolia</i>)	2.68	3.30	1.82
Redwood (<i>Sequoia sempervirens</i>)	6.99	9.25	4.05
Bigtree (<i>Sequoia washingtoniana</i>)	4.82	5.95	3.47
Bald cypress (<i>Taxodium distichum</i>)	4.69	5.78	3.63
Arborvitae (<i>Thuja occidentalis</i>)	2.02	2.39	1.39
Western red cedar (<i>Thuja plicata</i>)	3.87	4.54	3.14
Hemlock (<i>Tsuga canadensis</i>)	4.01	5.04	2.81
Western hemlock (<i>Tsuga heterophylla</i>)	3.04	3.63	1.73

* A millimetre is equal to about one-twenty-fifth of an inch.

† From a tree growing in dry soil.

Among broad-leaved woods the following have been examined by the author. The measurements are for the true wood fibres and the samples were prepared from wood of commercial size. All measurements are in millimetres.

Wood	Length			Width		
	Max.	Min.	Avg.	Max.	Min.	Avg.
Beech (<i>Fagus atropunicea</i>)	1.72	0.70	1.13	0.029	0.015	0.022
Poplar (<i>Populus grandidentata</i>)	1.62	0.71	1.08	0.044	0.020	0.028
Aspen (<i>Populus tremuloides</i>)	1.68	0.78	1.15	0.046	0.020	0.032
Cotton gum (<i>Nyssa aquatica</i>)	2.67	1.24	1.85	0.100	0.028	0.066
Red alder (<i>Alnus oregona</i>)	1.77	0.84	1.23	0.038	0.014	0.027
Sycamore (<i>Platanus occidentalis</i>)	2.21	0.94	1.57	0.033	0.016	0.024
Red maple (<i>Acer rubrum</i>)	1.19	0.67	0.93	0.028	0.014	0.020
Buckeye (<i>Aesculus flava</i>)	0.92	0.46	0.62	0.026	0.014	0.020
Cucumber tree (<i>Magnolia acuminata</i>)	1.30	0.55	0.86	0.036	0.020	0.029
Umbrella (<i>Magnolia fraseri</i>)	1.47	0.62	1.08	0.041	0.013	0.027
Tulip tree (<i>Liriodendron tulipifera</i>)	1.59	0.64	1.14	0.035	0.021	0.029
Sweet gum (<i>Liquidamber styraciflua</i>)	2.02	0.96	1.55	0.036	0.022	0.031
Black gum (<i>Nyssa sylvatica</i>)	2.32	1.18	1.68	0.035	0.015	0.026
Elm (<i>Ulmus americana</i>)	1.98	1.03	1.35	0.021	0.014	0.019
Birch (<i>Betula papyrifera</i>)	1.63	0.78	1.17	0.042	0.014	0.025

Moisture in Wood. The cell cavities of all wood contain large amounts of air and moisture. According to Sachs the volume percentage of freshly cut fir wood is

	Per cent
Cell walls	24.81
Water	58.63
Air cavities	16.56

The moisture in wood varies with the amount of seasoning it has had and also with the kind of wood, the position in the tree, and the time of cutting. Certain kinds of wood in the living tree, as for example, white ash, black locust and the white and red cedars are comparatively dry; black ash and the oaks have about twice as much, and chestnut and buckeye about three times as much moisture as white ash; cypress and white fir also contain large amounts of water. In the hard woods the variation in moisture with the different positions in

the tree is comparatively slight while the conifers show wide variations, the heartwood generally being very dry and the sapwood very wet.

Seasoning greatly reduces the amount of moisture present in wood but the rate of drying is not the same for all varieties, some losing moisture in one-tenth the time required by others. The term "air dry," therefore, is one which may denote almost any condition of moisture from 40 per cent down to 4 per cent of the total weight, according to the length of seasoning and the conditions to which exposed.

Weight per Cubic Foot. The figure for weight per cubic foot is one which is closely connected with the moisture content, since the shrinkage in volume due to loss of moisture is not at all proportional to the amount of such loss. For this reason it is best to base the weight per cubic foot on the absolutely dry material. Determinations made by the Forest Service¹ for a number of American woods gave the following results:

Kind of wood	Pounds per cubic foot (bone dry)	Kind of wood	Pounds per cubic foot (bone dry)
Balsam fir.....	21.50	Jack pine.....	24.00
Red fir.....	22.25	Loblolly pine, fall cut.....	28.86
White fir.....	21.40	White pine.....	20.25
Alpine fir.....	22.00	Engelmann spruce, Montana	24.40
Lowland fir.....	21.53	Engelmann spruce, Colorado	21.28
Eastern hemlock.....	24.60	Sitka spruce.....	23.60
Western hemlock.....	24.80	White spruce.....	26.40
Tamarack.....	32.00	White birch.....	34.20
Lodgepole pine, Montana..	25.15	Poplar.....	24.16
Lodgepole pine, California	23.20	Black gum.....	30.36

The following table of weights per cubic foot is also from data supplied by the Forest Service. In this case the weights are for kiln dried material and the bone dry weights would probably be about 4 per cent less. This table shows the variations which may be expected in wood of the same species when grown in different localities and under different conditions. It

¹ The Log of the Lab., Dec., 1916.

illustrates the impossibility of establishing a figure for any wood which will apply in all cases.

Kind of wood	Locality	Pounds per cubic foot (kiln dry)
Cypress, bald.....	Louisiana.....	33
Douglas fir.....	California, Oregon, Washington.	30-35
Longleaf pine.....	Florida, Mississippi.....	38-42
Norway pine.....	Wisconsin.....	32
Spruce, red.....	New Hampshire.....	28
Spruce, white.....	New Hampshire, Wisconsin.....	25-29
Red alder.....	Washington.....	27
Aspen.....	Wisconsin.....	26
Basswood.....	Wisconsin, Pennsylvania.....	24-26
Beech.....	Pennsylvania, Indiana.....	41-43
Paper birch.....	Wisconsin.....	37
Buckeye.....	Tennessee.....	24
Chestnut.....	Maryland.....	29
Black gum.....	Tennessee.....	35
Red maple.....	Pennsylvania, Wisconsin.....	34-37
Silver maple.....	Wisconsin.....	32
Sugar maple.....	Indiana, Pennsylvania.....	41-42
Sycamore.....	Indiana, Tennessee.....	34-35
Tulip tree.....	Tennessee.....	27
Tupelo.....	Louisiana.....	35

Resins. Many woods contain small amounts of volatile oils generally approaching terpene ($C_{10}H_{16}$) in chemical composition. Practically nothing is known regarding their formation. From these by oxidation are formed balsams and resins, the former being regarded as mixtures of resins with volatile oils. There are also in some cases resins which contain gum or mucilage and are hence termed gum resins.

The amount of resin in wood varies greatly with the different kinds and with the solvent used in its determination. With Canadian woods Richter¹ obtained the following results:

	Ether extract	Alcohol extract
	Per cent	Per cent
Fresh balsam.....	0.45-0.85	1.15-3.65
Fresh spruce.....	0.70-1.80	0.70-1.94

¹ Richter: Wochbl. Papierfabr., 44 (1913), 4507.

Examination of the resins obtained gave the following constants:

	Ether resin		Alcohol resin	
	Acid number	Saponification number	Acid number	Saponification number
White spruce.....	61	80	54	83
Black spruce.....	66	110	35	168

Richter claims that storage of the wood decreases the ether extract and increases the alcohol extract, while Schwalbe and Grimm¹ state that seasoning or passing air over the chips reduces both ether and alcohol soluble material.

The ether extract is usually lighter in color and more liquid and sticky than the alcohol extract. Part of each is soluble in petroleum ether and according to Johnsen² it is this portion which is responsible in large part for the trouble with pitch in sulphite pulp. The portion soluble in petroleum ether is a thick yellow liquid and appears to be of a fatty rather than a resinous nature; the insoluble part is brown and brittle.

The resin in Bohemian pine and its distribution in the sulphite cellulose made from it have been studied by Sieber,³ who found that cooking removed 4.2 per cent; the knotter, screens, sand traps, etc., took out 51.8 per cent, while bleaching removed 15 per cent.

Proximate Analysis of Wood. The following table gives the analysis of a number of European woods.⁴

¹ Schwalbe and Grimm: *Wochbl. Papierfabr.*, 44 (1913), 3247.

² Johnsen: *Pulp and Paper Mag. Can.*, 1917, 577.

³ *Papierfabr.*, 1915, June 18.

⁴ Müller: *Die Pflanzenfaser.*

Wood	Water	Soluble in water	Soluble in alcohol and benzine	Cellulose	Incrusting matter
Black poplar.....	12.10	2.88	1.37	62.77	20.88
Silver fir.....	13.87	1.26	0.97	56.99	26.91
Birch.....	12.48	2.65	1.14	55.52	28.21
Willow.....	11.66	2.65	1.23	55.72	28.74
Scotch pine.....	12.87	4.05	1.63	53.27	28.18
Chestnut.....	12.03	5.41	1.10	52.64	28.82
Linden.....	10.10	3.56	3.93	53.09	29.32
Beech.....	12.57	2.41	0.41	45.47	39.14

Still more complete analyses of seven American woods are given by Schorger,¹ all percentages being based on oven dry samples. Some of his results follow:

Wood	Ash	Solubility of wood in			Acetic acid by hydrolysis	Methoxyl groups	Pentosans	Cellulose
		Hot water	Ether	1 per cent NaOH				
Longleaf pine (<i>Pinus palustris</i>)..	0.37	7.15	6.32	22.36	0.76	5.05	7.46	58.48
Douglas fir (<i>Pseudotsuga taxifolia</i>).....	0.38	6.50	1.02	16.11	1.04	4.95	6.02	61.47
Western larch (<i>Larix occidentalis</i>).....	0.23	12.59	0.81	22.14	0.71	5.03	10.80	57.80
White spruce (<i>Picea canadensis</i>)..	0.31	2.14	1.36	11.57	1.59	5.30	10.39	61.85
Basswood (<i>Tilia americana</i>)....	0.86	4.07	1.96	23.76	5.79	6.00	19.93	61.24
Yellow birch (<i>Betula lutea</i>)....	0.52	3.97	0.60	19.85	4.30	6.07	24.63	61.31
Sugar maple (<i>Acer saccharum</i>)..	0.44	4.36	0.25	17.64	4.46	7.25	21.71	60.78

The percentages of cellulose given in this table by Schorger are considerably higher than the figures of most other analysts for the same, or similar, woods. They are doubtless more accurate because of the greater pains taken with the work and because of the more complete knowledge of the precautions necessary to prevent hydrolysis of the cellulose and its consequent loss during the analytical procedure.

Bark and Knots. The bark serves as a protective envelope for the stem and gradually increases in thickness, as a layer is added each year. It contains long bast fibres which give strength

¹ Schorger: J. Ind. and Eng. Chem., 1917, 9, 556.

to the bark, and cork cells which, because of their impermeability, are admirably suited to form a protective covering for the tissues beneath. Bark often contains coloring matters and tannins, sometimes in sufficient amounts to make extraction profitable. It is only slightly acted upon by the chemical processes of pulp manufacture and for this reason is of interest to the paper maker chiefly because of the necessity for its removal. Recent experiments have led to its use on a small scale as a substitute for better grades of material in making roofing felts and similar products and it will probably eventually be quite fully utilized.

The loss in barking varies greatly with the size and shape of the logs, with the care used by the men in charge of the barkers, and with the type of barker used. With disc barkers it may amount to 10 to 25 per cent of the rough wood.

Knots are formed at the points where the branches make out from the stem or trunk. They are usually very hard and dense and are frequently highly charged with resins and coloring matters. They are partially reduced by the soda process but are almost unaffected by the sulphite process which usually fails even to soften them.

Decay. The importance of decay is becoming greater every year because of the increasing cost of wood. Not only does the wood stored in the yard decay but ground wood stored in laps also suffers damage which is estimated by the Forest Service to amount to between five and fifteen million dollars a year. The decay of wood stored in piles depends on the size and form of the pile, upon temperature and humidity and upon the foundation upon which the pile is built. Small piles of evenly stacked wood will not decay because they are well ventilated and dry out readily. Neither will the wood in the interior of large piles because it is too wet; but between these two extremes is a condition where the moisture is just right and the fungi flourish wonderfully. The summer, with its high temperatures, is the time when most of the decay takes place and practically no loss is suffered in winter.

The following photomicrographs show the characteristic forms and markings of a number of the typical paper-making fibres. These photomicrographs, as well as those in Chapter X, were prepared by the Paper Section of the Bureau of Standards.

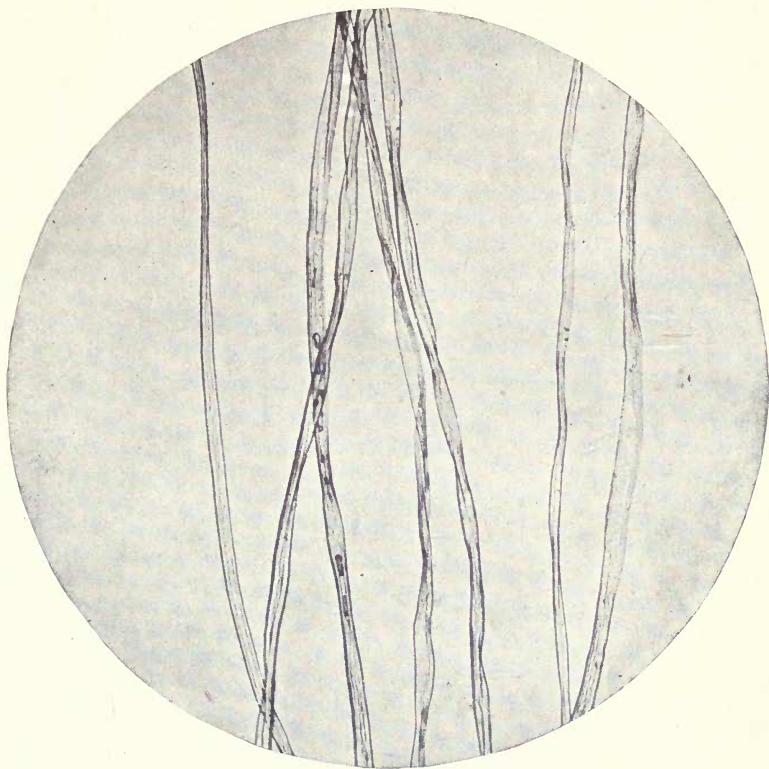

PLATE I

Cotton (*Gossypium*) Magnification 100 diameters. Photographed by
Bureau of Standards.

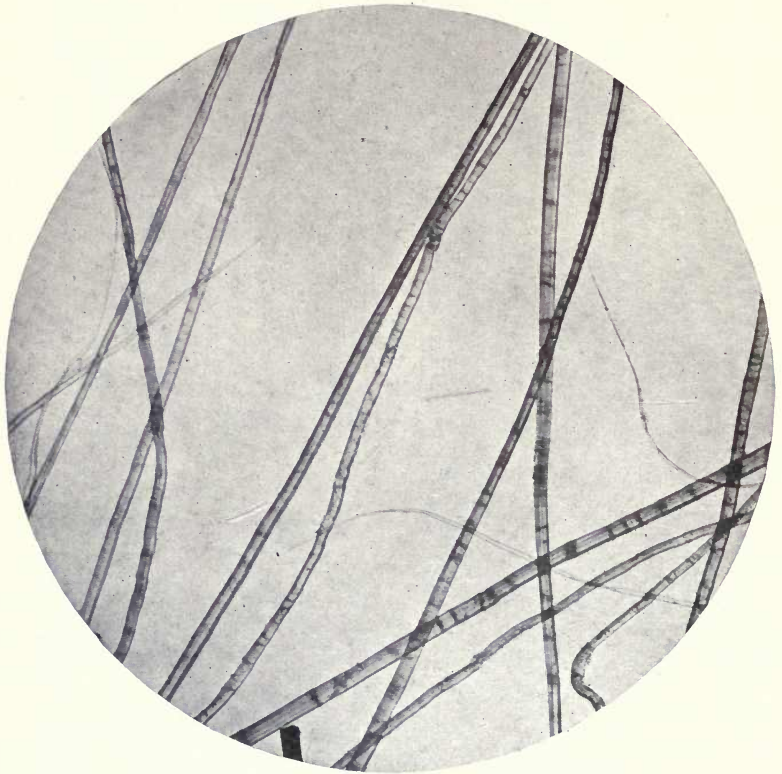

PLATE 2

Linen (*Linum usitatissimum*) Magnification 100 diameters. Photographed by
Bureau of Standards.

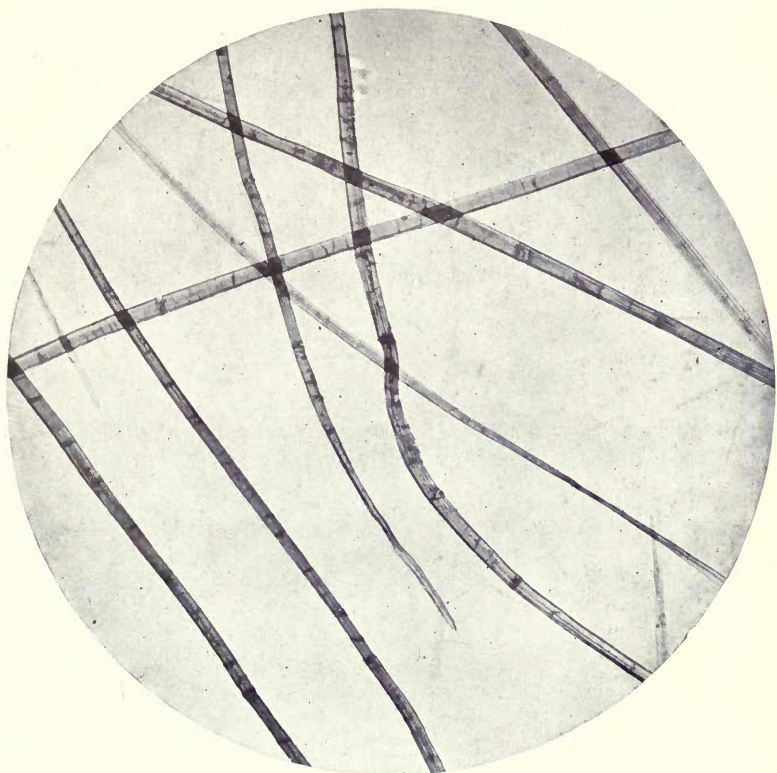

PLATE 3

Hemp (*Cannabis sativa*) Magnification 100 diameters. Photographed by
Bureau of Standards.

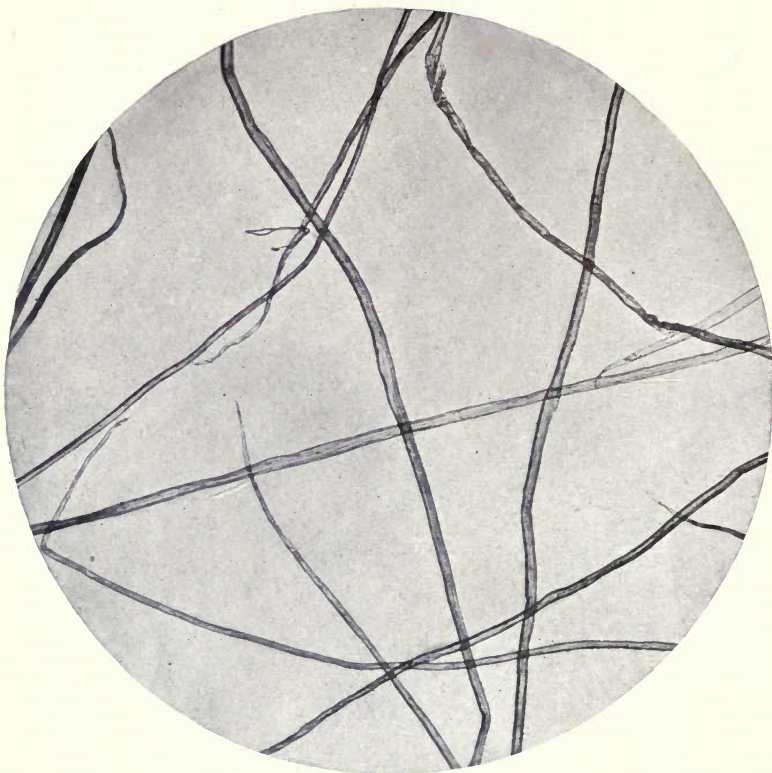

PLATE 4

Manila (*Musa textilis*) Magnification 100 diameters. Photographed by
Bureau of Standards.

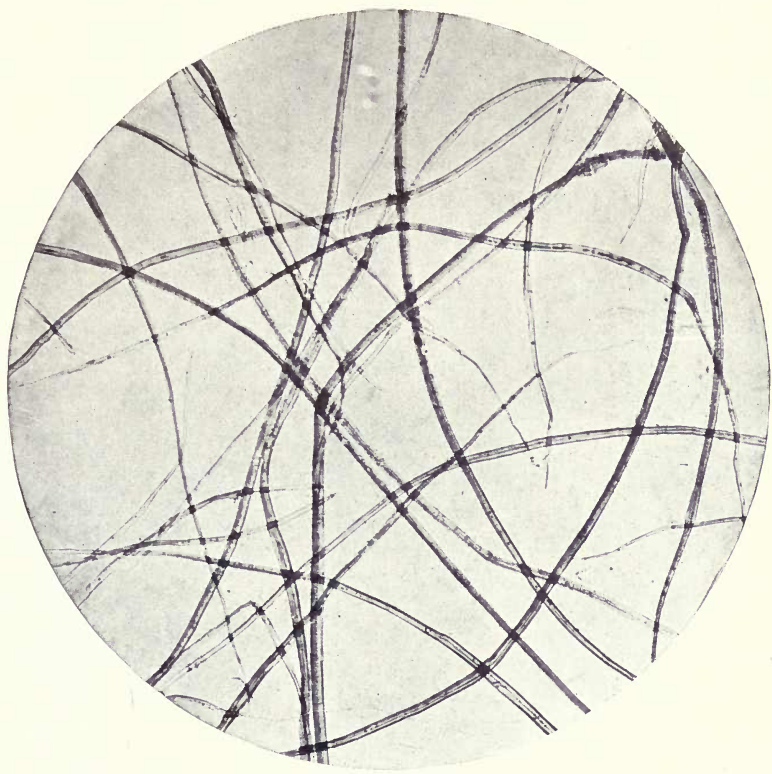

PLATE 5

Jute (*Corchorus capsularis*) Magnification 100 diameters. Photographed by
Bureau of Standards.

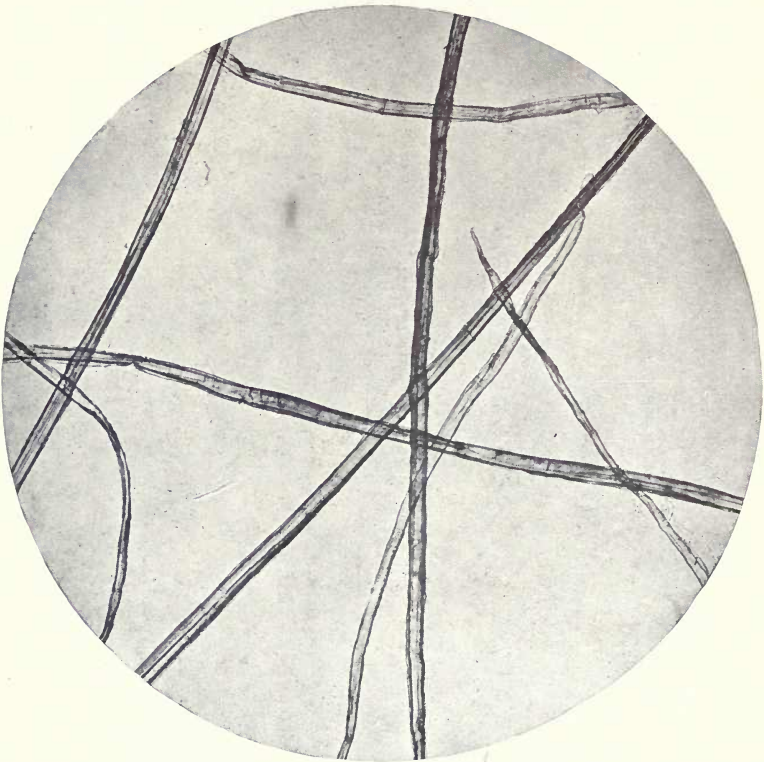

PLATE 6

Paper Mulberry (*Broussonetia papyrifera*) Magnification 100 diameters.
Photographed by Bureau of Standards.

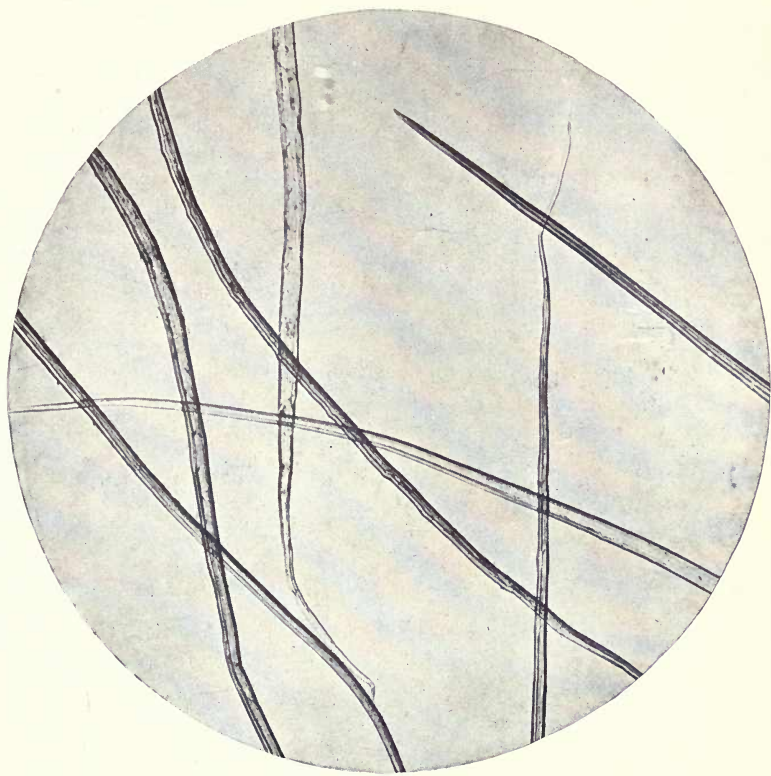

PLATE 7

Sisal (*Agave rigida*) Magnification 100 diameters. Photographed by
Bureau of Standards.

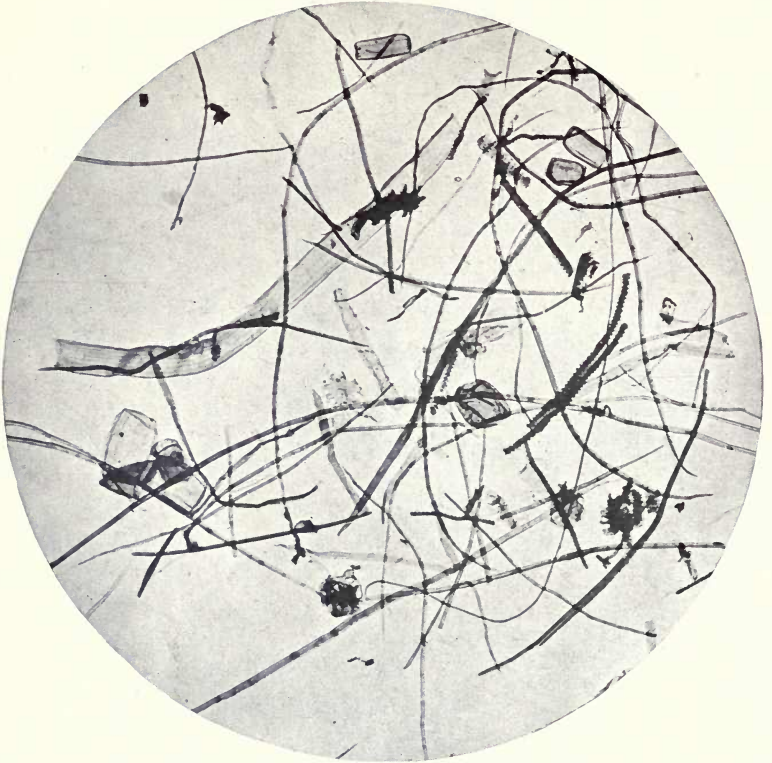

PLATE 8

Rice Straw (*Oryza sativa*) Magnification 100 diameters. Photographed by
Bureau of Standards.

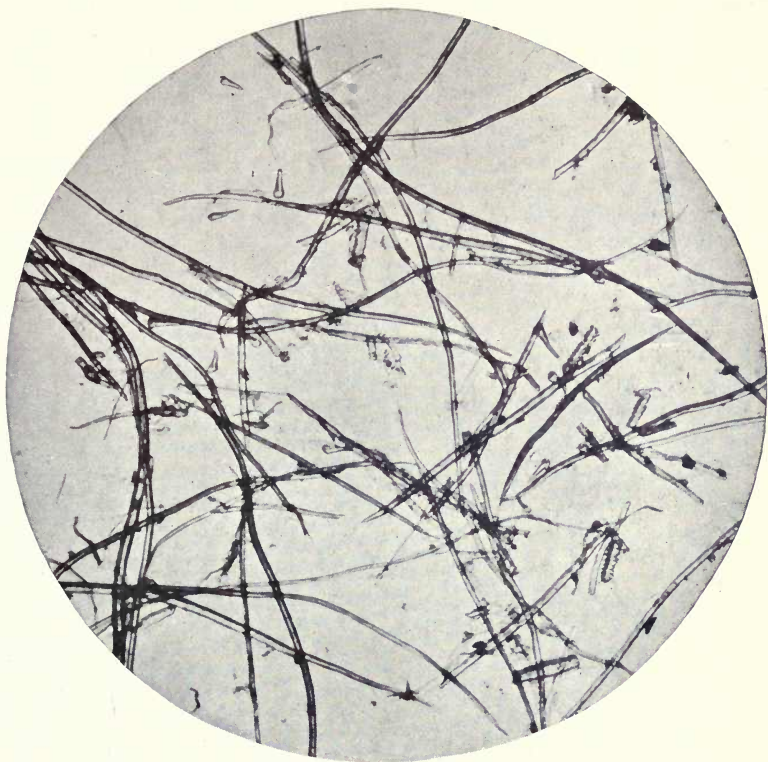

PLATE 9

Esparto (*Stipa tenacissima*) Magnification 100 diameters. Photographed by
Bureau of Standards.

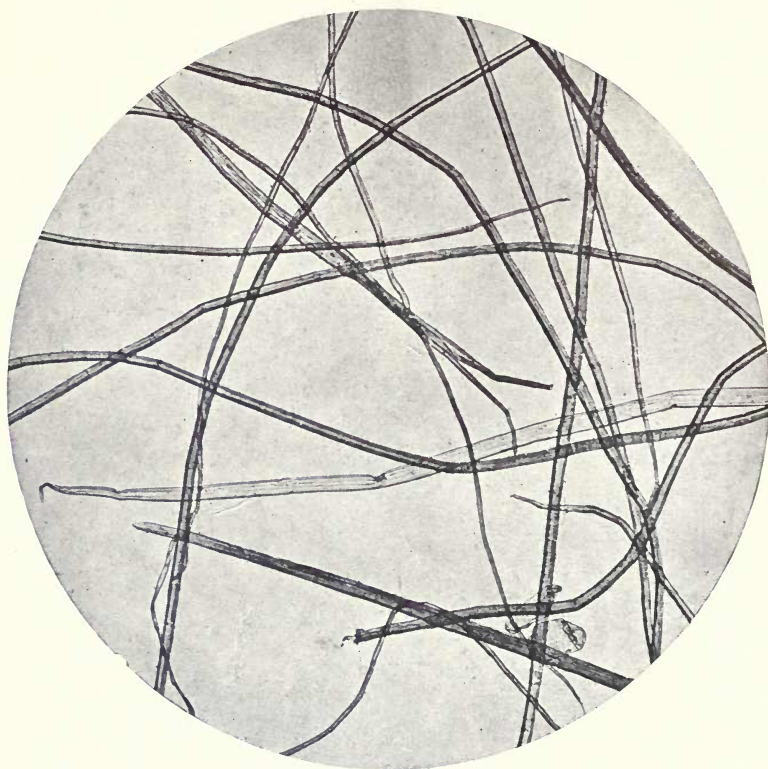

PLATE 10

Bamboo (*Bambusa arundinacea*) Magnification 100 diameters. Photographed by
Bureau of Standards.

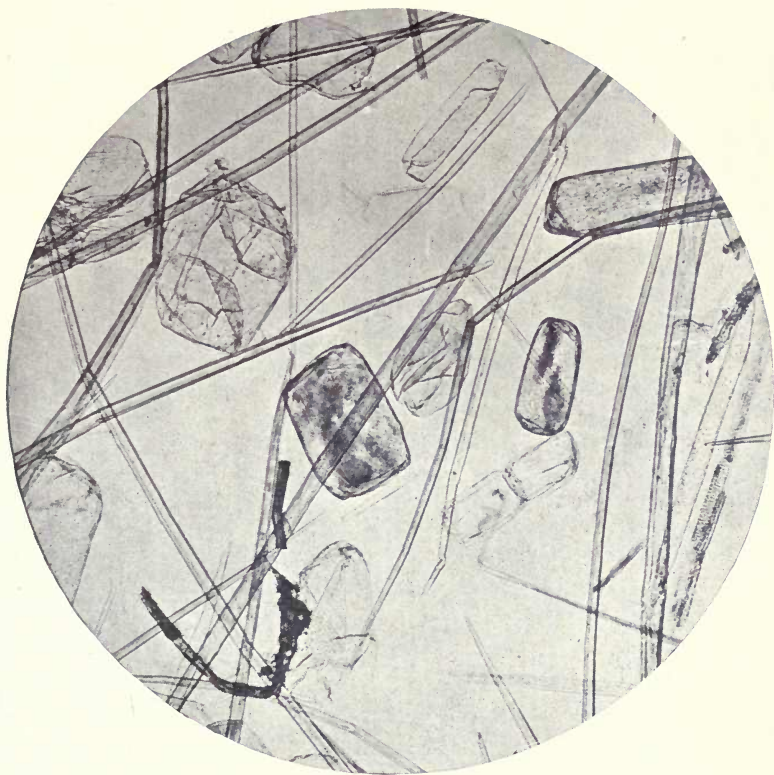

PLATE II

Corn (*Zea mays*) Magnification 100 diameters. Photographed by
Bureau of Standards.

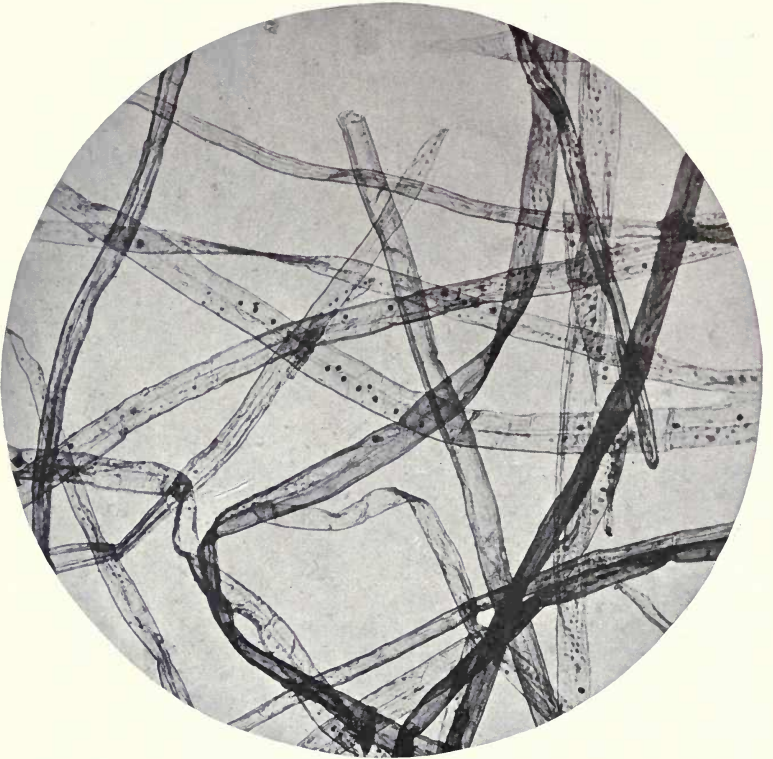

PLATE 12

Red Spruce (*Picea rubens*) Magnification 100 diameters. Photographed by
Bureau of Standards.

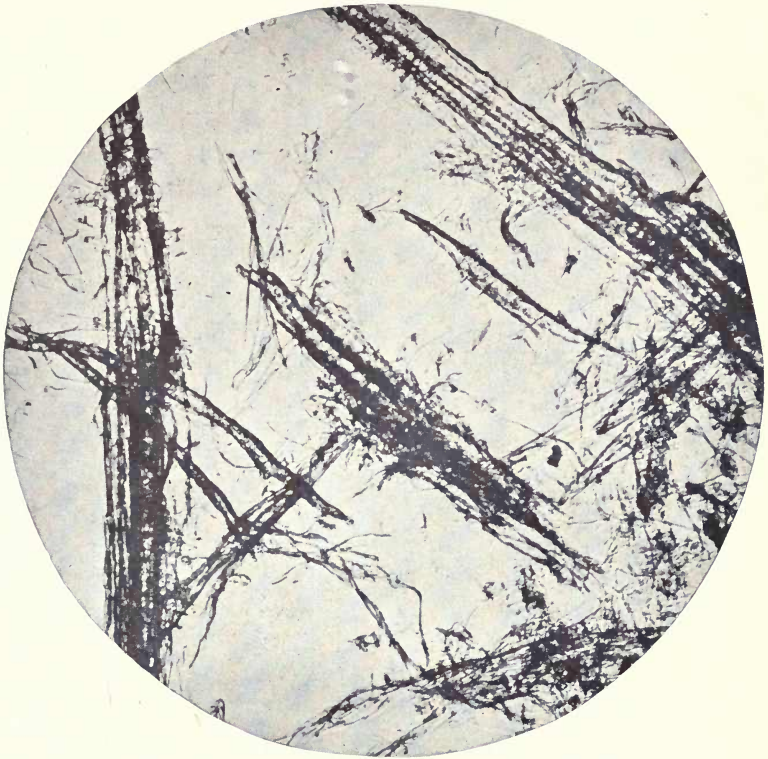

PLATE 13

Spruce Ground Wood (*Picea canadensis*) Magnification 100 diameters.
Photographed by Bureau of Standards.

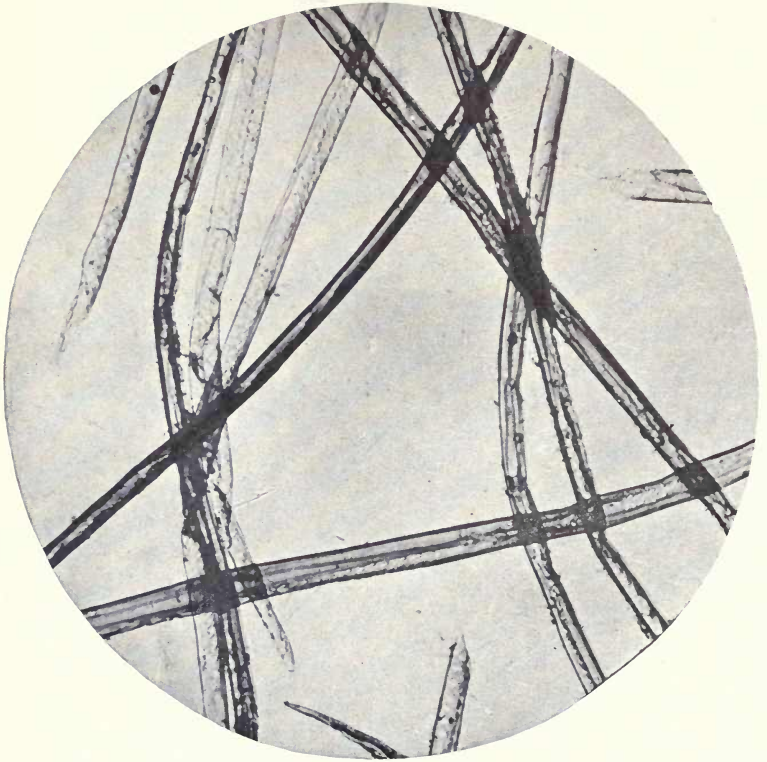

PLATE 14

Balsam Fir (*Abies balsamea*) Magnification 100 diameters. Photographed by
Bureau of Standards.

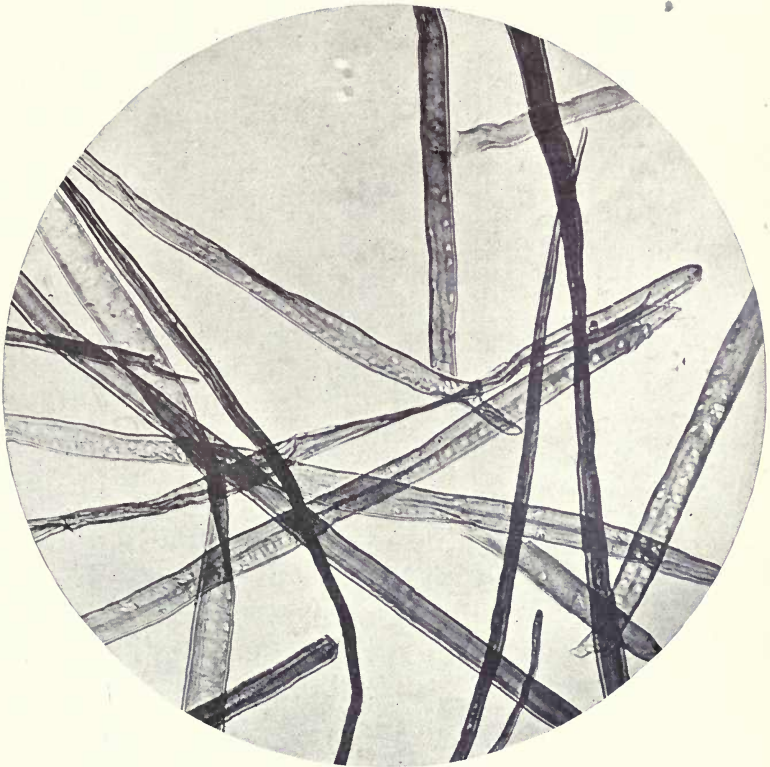

PLATE 15

Jack Pine (*Pinus divaricata*) Magnification 100 diameters. Photographed by
Bureau of Standards.

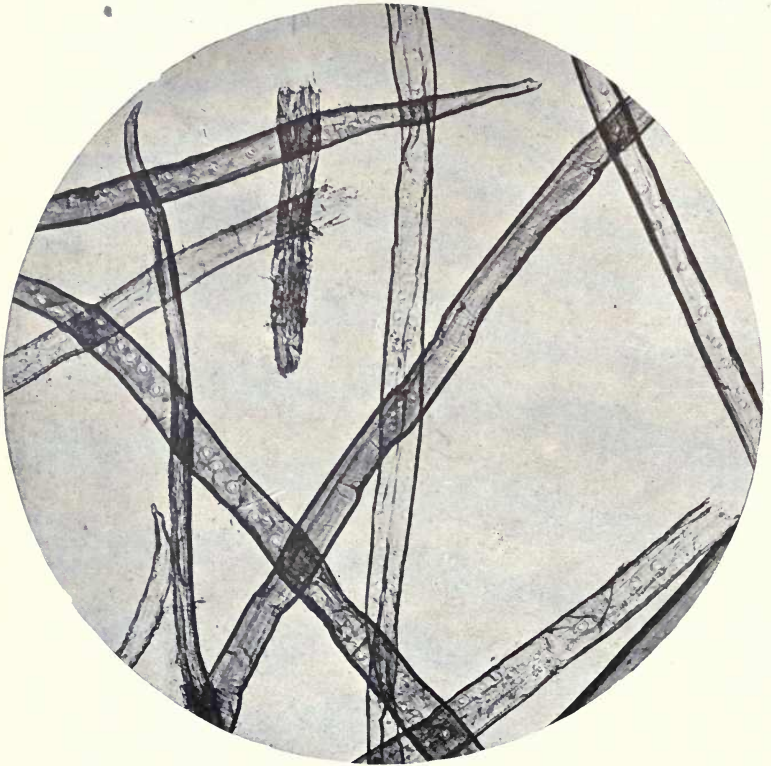

PLATE 16

Hemlock (*Tsuga canadensis*) Magnification 100 diameters. Photographed by
Bureau of Standards.

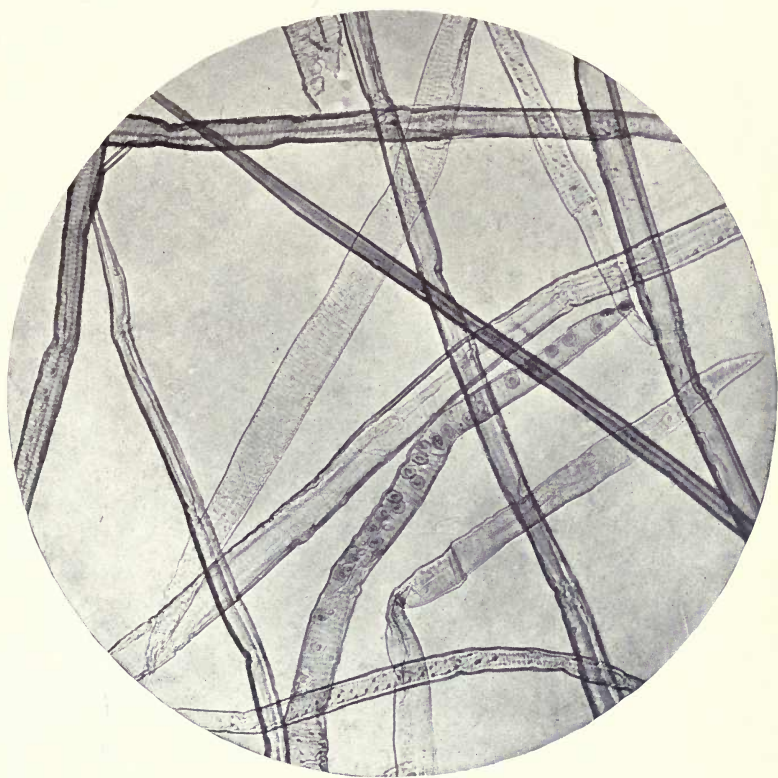

PLATE 17

Douglas Spruce (*Pseudotsuga taxifolia*) Magnification 100 diameters.
Photographed by Bureau of Standards.

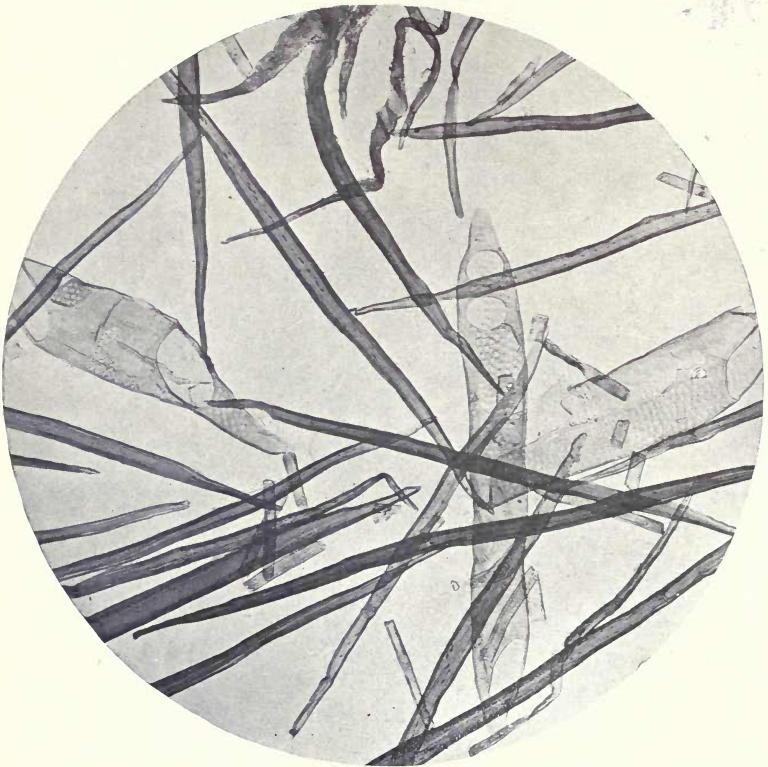

PLATE 18

Aspen (*Populus tremuloides*) Magnification 100 diameters. Photographed by
Bureau of Standards.

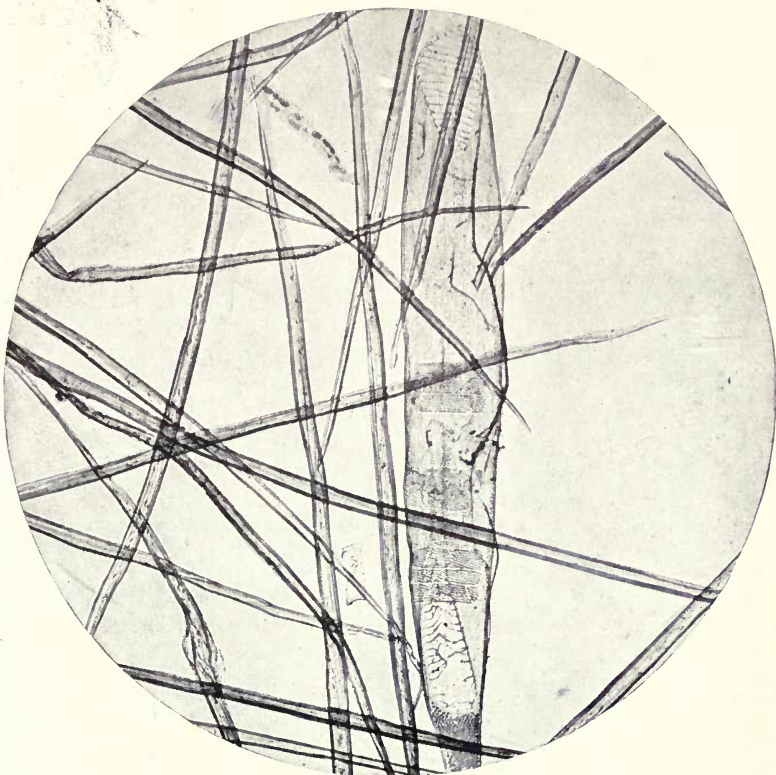

PLATE 19

Yellow Birch (*Betula lutea*) Magnification 100 diameters. Photographed by
Bureau of Standards.

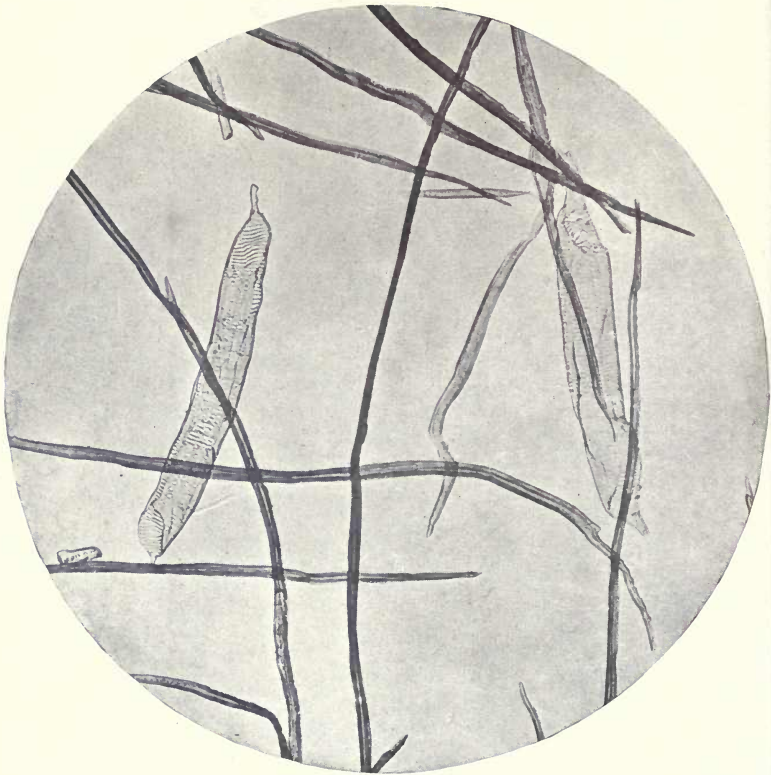

PLATE 20

Beech (*Fagus atropunicea*) Magnification 100 diameters. Photographed by
Bureau of Standards.

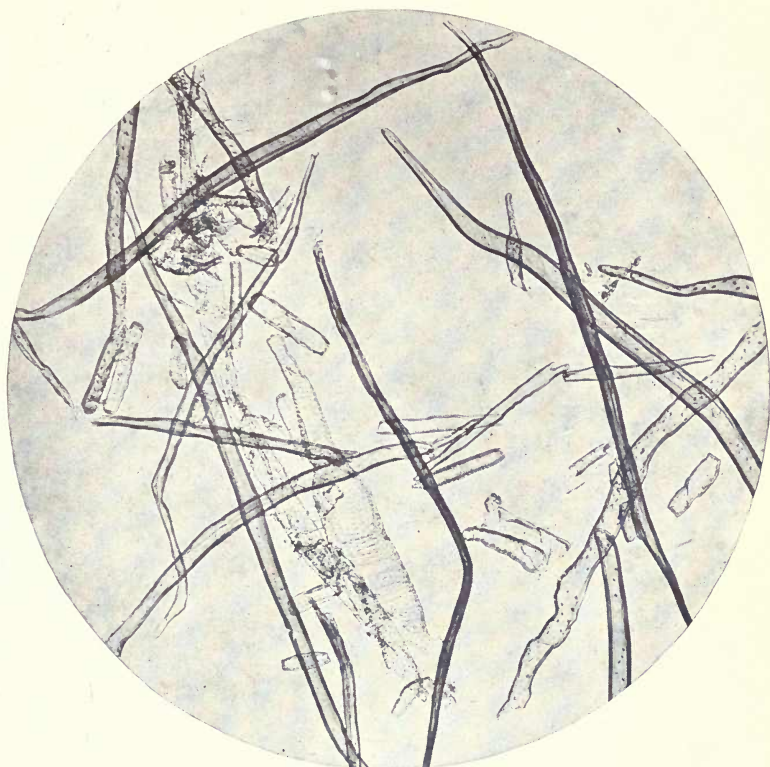

PLATE 21

Chestnut (*Castanea dentata*) Magnification 100 diameters. Photographed by
Bureau of Standards.

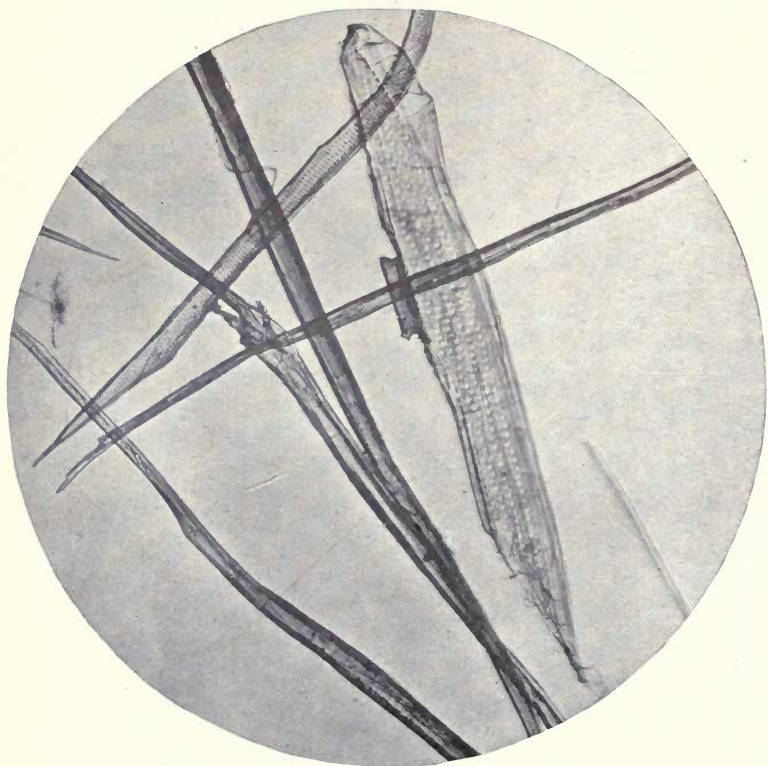

PLATE 22

Tulip-tree (*Liriodendron tulipifera*) Magnification 100 diameters. Photographed by Bureau of Standards.

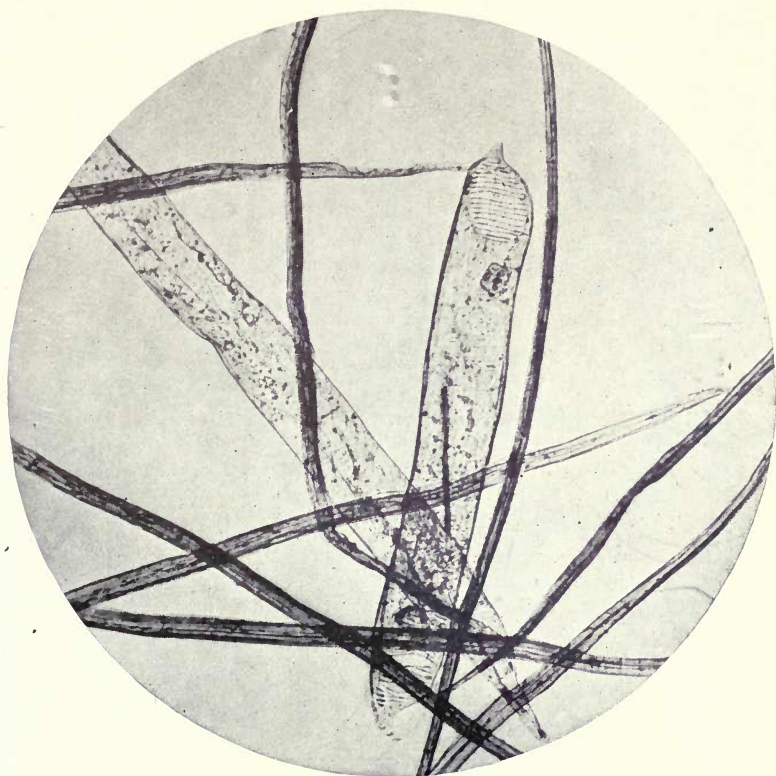

PLATE 23

Sweet Gum (*Liquidambar styraciflua*) Magnification 100 diameters.
Photographed by Bureau of Standards.

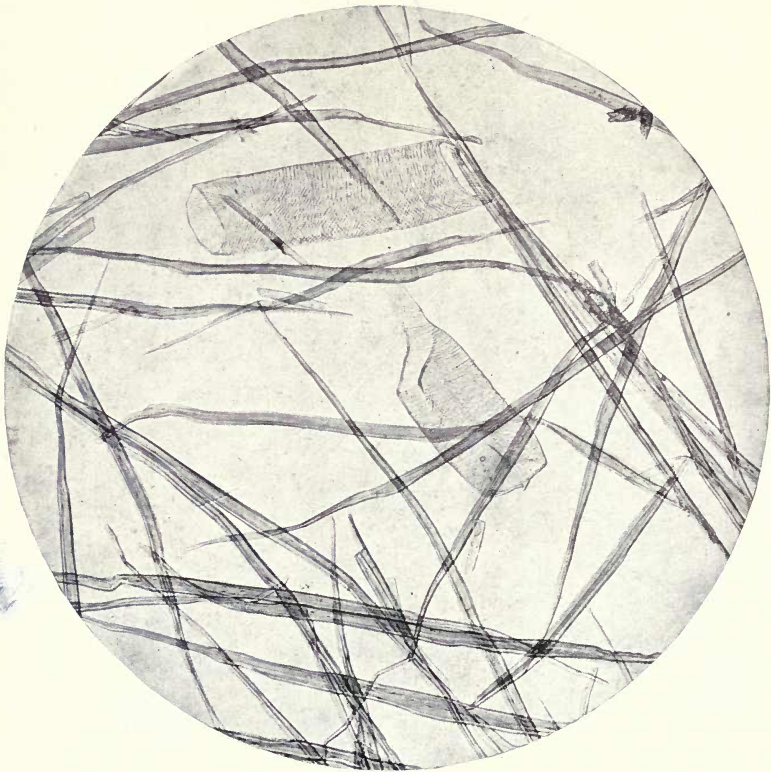

PLATE 24

Hard or Sugar Maple (*Acer saccharum*) Magnification 100 diameters.
Photographed by Bureau of Standards.

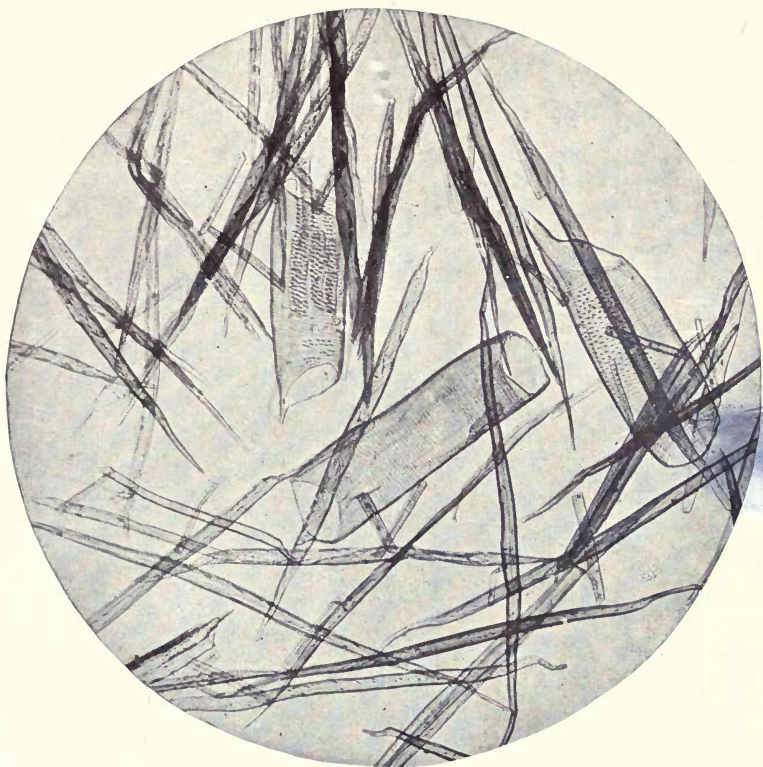

PLATE 25

Soft or Silver Maple (*Acer saccharinum*) Magnification 100 diameters.
Photographed by Bureau of Standards.

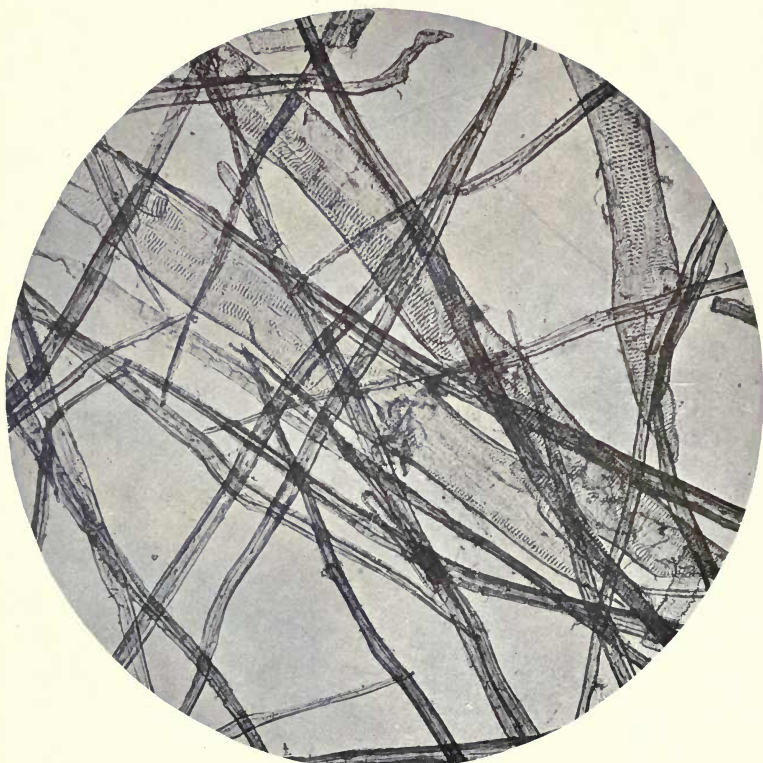

PLATE 26

Black Gum (*Nyssa sylvatica*) Magnification 100 diameters. Photographed by
Bureau of Standards.

The actual loss of the wood itself is not the only serious feature, for the handling of such materials is expensive because of the labor required to cut out the decayed portions. As it is never possible to make a complete separation some poor wood gets into the digester, cutting down its capacity, injuring the quality of the pulp, and using up the cooking liquors uselessly. Another serious feature is the fire risk involved by the tinder-like decayed portions. It takes but a spark to ignite such material and it is said to be responsible for most of the serious pulp wood fires.

The decay in wood yards can be greatly lessened by making small piles which will dry rapidly and by piling the wood on a foundation of crushed stone or gravel rather than on sod-land. Spraying the foundation with a disinfectant is also recommended by Haas.¹ Another point is the careful removal of old bark, decayed wood and the like; such materials should never be left to be covered by new wood.

Kinds of Wood. The woods most generally employed in the United States for the manufacture of both ground wood and chemical fibre are spruce and poplar, but the growing scarcity of these two species has led to the use of many other kinds. The quantities of such other woods depend on the factors of price, length of fibre, ease of reduction and the relative locations of the mill and the source of the wood supply. The questions of length of fibre and weight per cubic foot have already been treated and we shall now consider briefly some of the woods which are in actual use or which have been tried out sufficiently on an experimental scale to demonstrate their value. The names and ranges of the various species have been taken from Sudworth's "Check List of the Forest Trees of the United States," while the other data have been collected from widely scattered sources. The species mentioned comprise only a portion of those which will probably be found suitable for the manufacture of paper or pulp in some of its forms.

¹ Haas: J. Soc. Chem. Ind., 1910, 29, 415.

Spruces. Red spruce, *Picea rubens*, ranging from Nova Scotia to North Carolina and Tennessee, and white spruce, *Picea canadensis*, are the common pulp woods of the East. The range of the latter is from Newfoundland to Hudson Bay, and north-westward to Alaska; southward to Northern New York, Michigan, Wisconsin, Minnesota, South Dakota, Montana and British Columbia. Both woods are light, soft, straight grained and fairly free from resin. Very similar in quality are Engelmann spruce, *Picea engelmanni*, ranging from northern Arizona through the Rocky Mountain region to British Columbia, and Sitka spruce, *Picea sitchensis*, extending on the coast region from Alaska to northern California. This latter species is said to be the best pulp wood on the Pacific coast.

All the spruces are reduced easily by the sulphite or sulphate process but with considerably more difficulty by the soda process. The soda fibre is very hard to bleach. Because of the uniformly light color of the wood all are admirably adapted for the preparation of ground wood, Sitka spruce, however, being somewhat inferior to the others in color.

Firs. Balsam fir, *Abies balsamea*, occurs from Newfoundland and Labrador westward to the region of Great Bear Lake and southward to Pennsylvania.

Its wood is very light, soft, not strong, rather coarse grained, and not durable. It is frequently cut and used with spruce, sometimes to the extent of 20 per cent or more, in the manufacture of sulphite. The fibre is considered somewhat inferior to that from spruce and is likely to contain more pitch. Balsam fir can be successfully used in the preparation of ground wood of good color but its use is not favored because of the low yield per cord and its tendency to decay.

Other firs which are found largely on the Pacific coast and in the Rocky Mountain region are lowland fir, *Abies grandis*; white fir, *Abies concolor*; amabilis fir, *Abies amabilis*; noble fir, *Abies nobilis*, and red fir, *Abies magnifica*.

The wood of most of these is light, soft and straight grained; it varies in the different species from fine to moderately coarse

grained. All of these trees grow to comparatively large size and yield excellent pulp wood. With the proper treatment all can be satisfactorily reduced by the sulphite process with the production of long fibre similar to spruce in quality. White fir is already being so treated commercially and yields a long silky fibre of the highest quality. All of these firs can be used for preparing ground wood for news print work though the color of the product is in most cases rather inferior to that of spruce ground wood.

Pines. Longleaf pine, *Pinus palustris*, ranges from southern Virginia to Florida and eastern Texas and northward to northeastern Alabama and northwestern Georgia. Covering a considerable portion of the same territory is shortleaf pine, *Pinus echinata*. The wood of both is hard, strong, dense, durable and resinous and is much used for many grades of lumber. It cannot be cooked successfully by the sulphite process because of its resinous nature, but if treated by the soda or sulphate process it yields a very strong, long-fibred stock suitable for wrapping or kraft papers but not for bleaching.

Jack pine, *Pinus divaricata*, is found from New Brunswick to New Hampshire, westward through the Great Lake region to the Rocky Mountains and south into northern Maine, New York, Indiana, Illinois and central Michigan. It is not suitable for use in the sulphite process but is largely used for the production of kraft pulp by the sulphate process. This wood also yields a fair grade of ground wood.

Other pines which are either used commercially or which have been proved by semi-commercial tests to be suitable for use in the sulphate or ground wood processes are: white pine, *Pinus strobus*; western yellow pine, *Pinus ponderosa*; lodgepole pine, *Pinus murrayana*; loblolly pine, *Pinus taeda*; scrub pine, *Pinus virginiana* and red or Norway pine, *Pinus resinosa*. These pines may be reduced by the soda process but the treatment required is considerably more severe than that given poplar and the fibre is not easily bleached.

Hemlock (*Tsuga canadensis*). *Range*. — Nova Scotia to Minnesota, Wisconsin, Michigan and southward in the mountains of the Atlantic region to northern Alabama and Georgia.

The wood is light, soft, brittle, not strong, crooked grained, liable to wind-shake and splinter and is not durable; its color is light brown tinged with red, the sapwood usually somewhat darker.

This wood is used to a considerable extent in the sulphite process and yields a fibre very similar to spruce though the treatment has to be rather more severe than for spruce. It also yields a good grade of kraft fibre. In the ground wood process a fair grade of fibre can be produced, though it is considerably more difficult to handle than spruce.

A related species, western hemlock, *Tsuga heterophylla*, has fine-grained, pale yellowish brown, light, soft wood which works like white pine. It yields a good grade of sulphite fibre and for ground wood is far superior to eastern hemlock.

Larch or Tamarack, (*Larix laricina*). *Range*. — From Newfoundland and Labrador to northern Pennsylvania, Indiana, Illinois, central Minnesota and northwestward to Hudson Bay.

Wood very heavy, hard, strong, rather coarse grained, durable in contact with the soil; color light brown, the sapwood nearly white.

Larch is reduced by the sulphite process with some difficulty and if mixed with spruce or hemlock is likely to cause chips and shives. By the sulphate process it can be made into a good grade of kraft fibre; it also yields a good grade of ground wood except for color which is a decided grayish green.

Douglas Spruce (*Pseudotsuga taxifolia*). *Range*. — From the Rocky Mountain region and northward to central British Columbia.

The wood varies widely in character and grain which may be very coarse, medium or fine. The coarse-grained wood is usually reddish brown, while the fine-grained is clear yellowish brown. The wood is slightly resinous and resembles pine in many of its characteristics.

Douglas spruce has been found well suited for making kraft pulp and is already used commercially in the sulphite process, though it is not so easy to cook and bleach as spruce.

Poplar (*Populus grandidentata*). Ranges from Nova Scotia through New Brunswick, southern Quebec and Ontario to northern Minnesota; southward to Delaware, southern Indiana and Illinois.

The wood is light, soft, not strong, close grained, compact, decays rapidly; color light brown, the sapwood nearly white. This is the wood most commonly used in the soda process; it is almost never used in sulphite mills though it is readily reduced by that process. It yields a ground wood of fair color but of rather short fibre.

The three following species are very similar to poplar in character of wood and are of practically identical paper making value.

Aspen (*Populus tremuloides*). *Range.* — Southern Labrador to Hudson Bay and northwestward to the Mackenzie River and Alaska; southward to Pennsylvania, northeastern Missouri, southern Nebraska, and throughout the western mountains to northern New Mexico and Arizona and central California.

Balm of Gilead (*Populus balsamifera*). *Range.* — Coast of Alaska and valley of Mackenzie River to Hudson Bay and Newfoundland; southward to northern New England and New York, central Michigan and Minnesota, northwestern Nebraska, northern Montana, Idaho, Oregon and Nevada.

Cottonwood (*Populus deltoides*). *Range.* — From Quebec and Vermont through western New England and New York, Pennsylvania, Maryland, and Atlantic States to western Florida and west to the Rocky Mountains.

White Birch — **Gray Birch** (*Betula populifolia*). *Range.* — From Nova Scotia, New Brunswick, and Lower St. Lawrence River southward to Delaware and westward through northern New England and New York to Lake Ontario.

The wood is light, soft, not strong, close grained, not durable; color light brown with thick, nearly white sapwood.

This wood is easily reduced to pulp by the soda process and the fibre bleaches readily. The chief difficulty in its use is in the economical removal of the bark.

Paper Birch (*Betula papyrifera*). *Range.* — From Labrador to Hudson Bay, Great Bear Lake, Yukon River and coast of Alaska; southward to New York, northern Pennsylvania, central Michigan and Minnesota, northern Nebraska, Dakota, northern Montana and northwestern Washington.

The wood is light, strong, hard, tough and close grained; its color is light brown tinged with red and the sapwood is nearly white. The bark is removed from this wood with some difficulty and as even the inner bark causes dirt in the pulp it must be very completely removed.

Paper birch cooks by the soda process with a little more difficulty than poplar and the fibre requires slightly more bleach. It yields pulp similar to poplar and fully equal to it in quality.

Red Alder (*Alnus oregona*). *Range.* — From Sitka through the coast ranges of British Columbia, Washington and Oregon to California.

The wood is light, brittle, fine grained; color pale reddish-brown.

By the soda process this wood cooks readily, yielding a fibre very similar to poplar.

Beech (*Fagus atropunicea*). *Range.* — Nova Scotia to Lake Huron and Northern Wisconsin; south to western Florida and west to southeastern Missouri and Texas.

The wood is very hard, strong, tough, very close grained, not durable in contact with soil, inclined to check on drying; color dark or light red with nearly white sapwood.

Beech cooked by the soda process requires about the same, or possibly a little more severe treatment than poplar. The pulp is soft and easily bleached, though not quite so easily as poplar.

Chestnut (*Castanea dentata*). *Range.* — From southern Maine to northwestern Vermont, southern Ontario and the southern shores of Lake Ontario to southeastern Michigan; southward

to Delaware and southeastern Indiana and on the Allegheny Mountains to central Kentucky and Tennessee, central Alabama and Mississippi.

The wood is light, soft, not strong, coarse grained, liable to check and warp in drying, easily split, very durable in contact with soil. It is reddish brown in color.

Chestnut wood contains tannin which can be profitably extracted for use in tanning or other industries. The extracted chips can be reduced quite readily by the soda process and the fibre bleaches without much difficulty. If the tannin is not removed the fibre is hard to bleach. Chestnut fibre is short and is used as a substitute for poplar.

Cucumber Tree (*Magnolia acuminata*). *Range.* — From western New York through southern Ontario to Illinois and south in the Appalachian Mountains to southern Alabama and north-eastern Mississippi; central Kentucky and Tennessee.

The wood is soft, light, not strong, close grained and easily worked; color light yellow with nearly white sapwood.

This wood reduces easily by the soda process giving a fibre closely resembling poplar in its paper making value.

Tulip Tree (*Liriodendron tulipifera*). *Range.* — From Rhode Island to southwestern Vermont and west to Lake Michigan; south to Florida, southern Alabama and Mississippi.

The wood is light, soft, brittle, not strong, easily worked; its color is light yellow or brown with creamy white sapwood.

Tuliptree is readily reduced by the soda process, yielding a fibre which is similar in character to poplar though generally a trifle longer.

Sweet Gum (*Liquidamber styraciflua*). *Range.* — From Connecticut to southeastern Missouri and Arkansas; south to Florida and Texas.

The wood is heavy, hard, not strong, straight and close grained, inclined to shrink and warp badly in seasoning; color bright brown tinged with red, sapwood nearly white.

Sweet gum can be treated by the chemical processes about as easily as poplar: the fibre is considerably longer than poplar

but not long enough to bring it into the class with spruce and other coniferous woods.

Sycamore (*Platanus occidentalis*). *Range*. — From southeastern New Hampshire and southern Maine to northern Vermont and Lake Ontario; west to eastern Nebraska and Kansas, and south to northern Florida, central Alabama, Mississippi, and Texas.

The wood is rather light, hard, coarse grained, not very strong, very hard to split.

Sycamore cooks easily by the soda process and the fibre is longer and more slender than that from poplar; it is said, however, to give a rather "punky" paper.

Sugar Maple, Hard Maple (*Acer saccharum*). *Range*. — From southern Newfoundland to Lake of the Woods and Minnesota; south to northern Georgia and western Florida; west to eastern Nebraska, Kansas and Texas.

The wood is heavy, hard, strong, tough and close grained; in color it is light brown tinged with red.

By the soda process it is reduced by about the same treatment given poplar; the fibre is shorter than poplar but bleaches readily.

Silver Maple, White Maple (*Acer saccharinum*). *Range*. — From New Brunswick to western Florida; west to southern Ontario, through Michigan to eastern Dakota, Nebraska and Kansas.

The wood is moderately light, hard, strong, close grained, easily worked but rather brittle.

It is reduced by the soda process as readily as poplar and makes a paper of practically the same quality. The fibre is a little shorter than poplar and bleaches readily.

Red Maple (*Acer rubrum*). *Range*. — From New Brunswick, Quebec and Ontario to Florida; west to Lake of the Woods, eastern Dakota, Nebraska and Texas.

The wood is very heavy, close grained, not strong; its color is light brown slightly tinged with red, the thick sapwood is lighter colored.

Red maple is slightly more difficult to treat than poplar, the fibre is rather shorter than poplar and bleaches a little harder.

Basswood (*Tilia americana*). *Range*. — From New Brunswick to Virginia, Georgia and Alabama; west to Lake Superior, Lake Winnipeg, eastern Dakota, Nebraska, Kansas and Texas.

The wood is light, soft, not strong, very close grained, compact and easily worked; color, light brown tinged with red.

It is very easily reduced by the soda process and yields an easy bleaching pulp very similar to poplar.

Black Gum (*Nyssa sylvatica*). *Range*. — From Maine to Florida and west to southern Ontario, southern Michigan, southeastern Missouri and Texas.

The wood is heavy, soft, strong, fine grained, very difficult to split; in color it is light yellow or nearly white.

By the soda process it cooks nearly as easily as poplar and yields a fibre free from shives. It bleaches a little harder than poplar. Its fibre is longer than that from poplar and makes an excellent paper. A very white ground wood can be made from it but it has not sufficient strength for newspaper work.

Bulk of Raw Materials.

This is an important factor to be considered in the transportation, storage and cooking of the different materials yet very few figures have apparently been published. The following notes therefore make no claim to completeness but are merely an attempt to collect in one place what little information is available.

Rags. Bales of rags as received at the mill have been found to have the following weights:

	Lbs. per cu. ft.
Egyptian rags.	37.5
Blue cottons.	26.5
White cottons.	19.5-22.1

When dusted and dumped into bins, but not tamped, they weigh 15.6 lbs. per cu. ft. before cutting.

Straw. Weighings of rice straw gave the following results:

	Lbs. per cu. ft.
As baled for shipment.....	11
Chopped and tamped.....	4.7
Chopped and not tamped.....	3.3

Esparto. Beadle and Stevens¹ give the figures for esparto as 120 cu. ft. per ton when pressed as usual or 90 cu. ft. from hydraulic presses.

A boiler of 540 cu. ft. capacity (vomiting type) will hold 50 cwt. of esparto, which after cooking will occupy a volume of 300 cu. ft.

Wood. The number of cubic feet of solid wood per cord and the consequent weight per cord vary greatly with the different kinds of wood and the size of the logs. Graves² gives the following table for the number of solid cubic feet for sticks of various diameters.

Diameter of sticks	No. of sticks per cord	Solid cubic feet per cord of		
		Hardwoods	Softwoods	Mixed
Ins.				
6.8	94	102.40	102.40	102.40
6.0	126	94.72	98.56	96.00
4.75	205	88.32	97.28	92.16
3.5	378	79.36	90.88	84.48

Measurements by the author on carefully stacked poplar wood in four-foot lengths also illustrate the same point:

Average diameter of sticks	No. of sticks per cord	Weight per cord, air dry	Per cent moisture	Weight per cord, bone dry
Ins.		Lbs.		Lbs.
11.72	35.5	4295	34.2	2828
7.90	70.5	3610	29.3	2553
3.18	2625	19.7	2108

Sound poplar wood when chipped, blown into a bin and leveled off but not tamped occupied a space of 259 cu. ft. per

¹ Beadle and Stevens: Chem. News, 1914, 109, 302-304.

² Graves: Forest Mensuration, p. 105.

cord of wood for an average of three tests. The chips, when placed loosely into a measuring box, weighed 10.8 lbs. per cu. ft. and if thoroughly shaken down but not tamped 13.8 lbs. per cu. ft.

Spruce wood gave, in the case of one test, the following figures:

One cord air dry spruce with bark weighs.....	4500 lbs.
Same after disc barking weighs.....	3600 lbs.
Volume of chips from above is.....	260 cu. ft.
One cubic foot of chips weighs.....	13 lbs.

CHAPTER III

RAGS, ESPARTO, STRAW, BAMBOO

Treatment of Rags. It is generally conceded that about 70 per cent of the rags used in this country are imported, while the remaining 30 per cent are collected chiefly in the larger American cities where the conditions of sorting are not conducive to cheapness or good results because of the high rentals for buildings and the unskilled labor which must be employed. In Europe each family keeps a separate bag for linen, woolen and cotton rags. These are collected at frequent intervals and are sorted and packed in large sheds which are rented cheaply, thus securing less costly and more satisfactory grading.

The grades of rags differ in different countries and vary from time to time. Among those listed in current trade journals are the following, which may be taken as generally characteristic.

<i>Domestic</i>	<i>Foreign</i>
No. 1 New white shirt cuttings	New white cuttings
No. 2 New white shirt cuttings	Unbleached cottons
Fancy new shirt cuttings	Light flannelettes
New blue cottons	New mixed cuttings
New mixed cottons	New dark cuttings
New black cottons	White linens, Nos. 1, 2, 3, 4
New light second cottons	Old extra light prints
No. 1 Whites	Ordinary light prints
No. 2 Whites	Medium light prints
House standard whites	Dutch blue cottons
Soiled standard whites	German blue cottons
Thirds and blues	German blue linens
Black stockings	Checks and blues
	Dark cottons

The moisture in baled rags as received at the mill has been found from a long series of tests to vary from 7 to 16 per cent

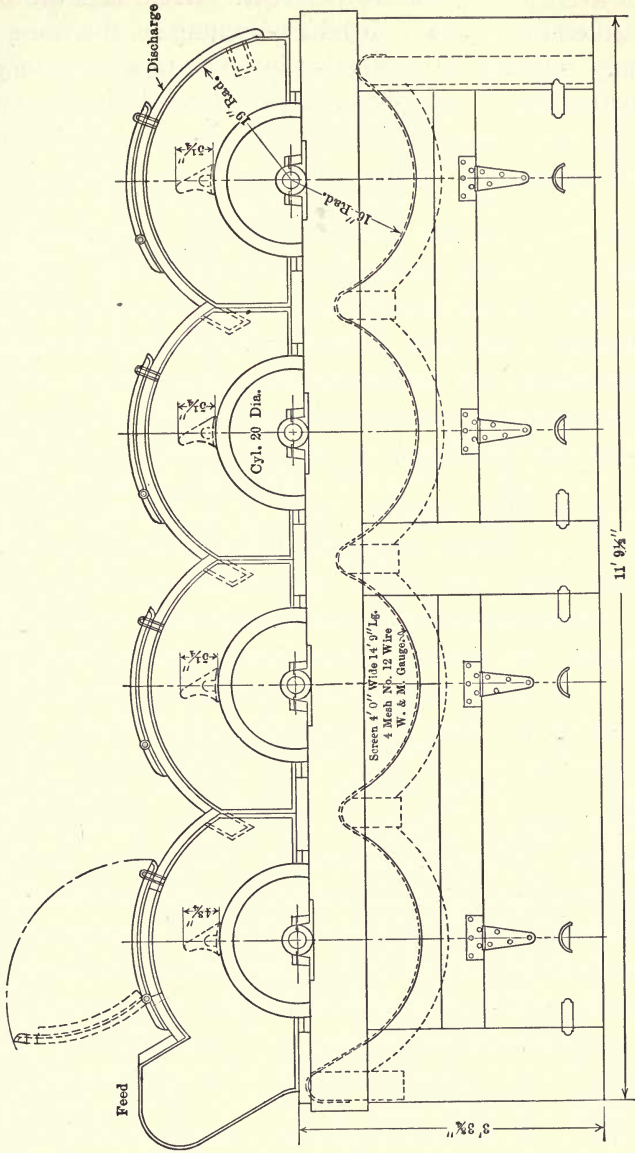

FIG. 4. RAILROAD RAG DUSTER

Courtesy of Norwood Engineering Co.

with an average of about 10 per cent. While rags are never purchased on the basis of a definite percentage of moisture, as is wood pulp, they should be tested at intervals to see that they are not intentionally wetted with the object of defrauding the buyer.

The first process in the mechanical treatment of rags is generally a dusting or thrashing. The bales are opened and the loosened-up rags thrown into the thrasher, which is usually a rapidly revolving cylinder covered with teeth or spikes enclosed in an outer cylindrical casing also fitted with teeth. There are various types of dusters but the object of all is to free the rags from loose dirt and deliver them sufficiently clean for the next operation, which is that of sorting into the numerous arbitrary grades maintained at the mill in question. This second grading is desirable, because they are frequently very imperfectly sorted before baling as is shown by tests on seven different lots of linens, which, when examined at an American mill, were found to contain from 10.5 to 45 per cent, by weight, of cottons. During this sorting the larger rags are usually cut into two or three pieces, the seams are opened and buckles, buttons, hooks, iron, rubber, etc., are removed. Considerable skill and judgment are required to sort and grade rags correctly and much of the success of subsequent operations depends on the care with which it is done. The next step in the process is that of cutting the sorted rags into pieces 2 to 4 inches square. This is generally done by machinery though for the very highest grades hand cutting is preferred because it gives cleaner stock. Machine cutting causes greater waste in the form of dust and many bits of rag are also lost; the rags are also more stringy and do not empty from the rotary as quickly as hand cut rags. After cutting, the rags are given a final dusting in some form of willow which permits the dust to pass through the wire covering while the cleaned rags are delivered into cars and are ready to be conveyed to the boilers.

The object of the boiling process is to dissolve or saponify the grease, loosen up the dirt and other impurities so that they may be easily washed out, and destroy or so modify the

coloring matters that they may be easily bleached. Another important duty is that of destroying any wool which was not removed during sorting. The agents used to effect these changes are caustic lime, caustic soda or a mixture of lime and soda ash. The question of which to use is largely one of personal preference and of the type of boiler used. Lime is only slightly soluble in water, one part dissolving in 1500 parts of water at 212° F. or in 728 parts at 68° F. It forms insoluble compounds with the grease and other impurities in the rags and is thus removed from solution, but as soon as it is precipitated a fresh portion dissolves to take its place so that the strength of the solution is practically constant throughout the boiling. This slight solubility of the lime limits the speed of reaction and the only way to make up for it is to increase the time of treatment. On the other hand, it prevents injury to the fibres from too great concentration of alkali and is therefore more likely to give good results when the usual, unscientific, hit-or-miss methods of control are employed.

Caustic soda acts in the same way as lime except that it is readily soluble in water and the compounds formed also remain in solution and are therefore more easily washed out. Because of the complete solubility of caustic soda its use subjects the rags at first to strong solutions which continually diminish in strength as the treatment continues. If the caustic soda used is the chemical equivalent of the lime generally employed the rags will probably be overcooked and tender and the yield low, but if the caustic soda is used in smaller amounts and the time of boiling properly regulated there is no reason to think that it will give inferior fibre or a lower yield than a lime cook on the same stock. Lime-boiled rags are brighter in color than those boiled with soda but this difference frequently disappears after bleaching. The rapidity with which the alkali is used up in a soda boil is shown by the following condensed data from large scale experiments by Beadle.¹

¹ Chem. News, 1901, 84, 257.

Rags	Gals. per cwt.	Liquor, per cent Na ₂ O	Per cent Na ₂ O on rags	Free Na ₂ O at hours below, start being 100 per cent				
				1	2	3	4	5
1 and 2 cottons . . .	24	0.33	0.697	38	15	8
2nd cottons	25.7	0.654	1.68	48	24	19
3rd cottons	22-22.5	0.55-0.90	1.22-1.78	31-70	21-43	13-26	10-23
Linens	23-25	0.91-1.36	1.91-2.45	25-80	16-24	9-19	7-13	.-13

The severity of the treatment given rags varies greatly in different mills and with the grade of rags and the kind of paper to be produced. The caustic soda necessary is given by different authorities as from 1 to 10 per cent, while the use of lime varies from 5 to 20 per cent on the weight of the rags. The steam pressure runs from 15 to 50 lbs., with 30 lbs. as probably a fair average, while the time of boiling ranges from 2 to 14 hours, and in some cases has been as much as 30 hours. Lime necessitates longer cooks than soda but the tendency in all cases is toward the shorter cooks since the steam consumption is less and the yields and the capacity of the plant are greater. Watt¹ gives the European practice as 12 hours at 30 lbs. steam pressure using 216 to 378 lbs. of lime and 114 to 190 lbs. of 48 per cent soda ash for 4000 lbs. of rags. In general it may be said that dark-colored or very dirty rags require much more severe treatment than new cuttings or clean, light-colored stock.

The presence of starch in new cuttings is said to interfere with the boiling by gelatinizing and preventing the penetration of the alkali. It has been proposed to get around this difficulty by the use of malt to hydrolyze and remove the starch. The rags are boiled with water to swell the starch, cooled to 60° C. by adding cold water, and an infusion of malt is then added. In one to two hours hydrolysis is sufficiently complete so that alkali may be added and the boiling completed in the usual way.

The lime used should slake rapidly and completely and should be as free as possible from iron. It is generally conceded that

¹ Watt: Art of Paper Making.

its value for this work is in proportion to its content of available calcium oxide. In preparing it for use it should be slaked and run into the boiler through wire sieves to take out any lumps. Griffin and Little¹ give the following analysis of lime as representing an excellent grade for rag boiling.

	Per cent
Silica, etc., insoluble in acid.....	0.01
Iron and alumina (Fe_2O_3 and Al_2O_3).....	0.28
Lime (CaO).....	92.81
Magnesia (MgO).....	2.28
Moisture, Carbonic Acid, etc. (by difference).....	4.62
	100.00

The volume of milk of lime added to a rotary boiler is generally enough to fill it from one-half to two-thirds full after the rags are in. If the rags are not covered by the milk of lime, but are exposed to the steam, they may become tender and brittle.

Several types of boilers are used for cooking rags; spherical or cylindrical rotary boilers and stationary boilers in which the circulation of the liquor is maintained either by a pump as in the Mather kier or by a vomiting pipe which is connected with a false bottom. In this case the steam enters under the false bottom and in passing up the pipe carries along the cooking liquor which is then distributed over the charge by baffle plates. The stationary type of boiler is fitted with a safety valve and there is therefore less danger of explosion than with the rotaries. It is claimed that there is less loss of fibre because the rags are not in motion and hence there is no rubbing off of the weaker fibres. On the other hand, they require more steam, are not suitable for use with lime cooks and take longer to discharge, since the cooked rags must all be removed by hand through manholes. Stationary boilers are largely used in Great Britain but seldom on the Continent or in this country.

Of the rotary boilers the cylindrical is more generally employed than the spherical, though the shape of the latter greatly assists in discharging its contents. The boilers are charged

¹ Griffin and Little: Chemistry of Paper Making, p. 152.

through manholes and with large boilers the men frequently enter them in order to pack the rags properly. The steam enters the boiler through the trunions and passes through gratings on the inside into the stock. The rotaries are also fitted with strainers through which much dirt passes in blowing off pressure. The rotaries usually turn at a speed of one revolu-

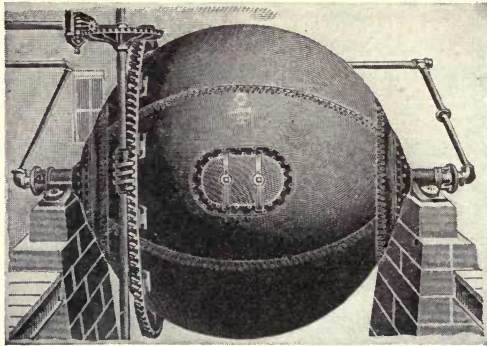

FIG. 5. SPHERICAL RAG BOILER

tion in two to five minutes. The consequent agitation and friction of the rags cause the detachment of the lime compounds formed and allow the action to continue on the remaining fatty materials. When the cook is completed the liquor and steam are blown off through the strainers and blow-off cocks, the manhole covers are removed and the contents are discharged by allowing the boiler to revolve. Even a large cylindrical boiler will empty itself clean in this way. With competent labor the operations on a cylindrical boiler holding a charge of 5000 to 5200 lbs. of rags occupy the following times:

	Hours
Charging rags.....	1½
Blowing off liquor.....	2
Discharging rags.....	3

During the cooking of rags a small amount of ammonia is given off. Tests on a large scale showed that the following amounts were discharged.

- o. 22 per cent ammonia (NH_3) from Japanese blues.
- o. 05 per cent ammonia (NH_3) from second white stock
- o. 14 per cent ammonia (NH_3) from clean white linen
- o. 33 per cent ammonia (NH_3) from German blues

The washing of the cooked rags is usually done in large engines similar to beating engines. One or more cylinder washers covered with perforated metal or wire cloth, frequently old Fourdrinier wire, serve to remove the dirty water which is constantly replaced by fresh water. If the rags are allowed to stand some time with the lime on them before washing they become softer and more absorbent and are better for blotting papers. On the other hand, if they are washed at once they are harder and the color is rather better. The lime compounds formed during cooking are friable and easily washed out in most cases but occasionally enough mineral oil is present so that they collect in sticky masses on the sides of the washer, fill up the meshes of the wire on the washing drum, and appear as small globules in the rag stock itself. When lime is used the washing should always be done with cold water because of the greater solubility of lime at low temperatures.

When the water from the cylinder washer comes away fairly clear the beater roll is lowered to loosen up the remaining dirt and gradually reduce the rags to half stuff. If this is done too soon the fibre loss is unduly great and the frayed out fibres catch and hold the dirt and the resulting stock is of poor color. After the rags are reduced to half stuff the bleach is added to the engine and the whole put into drainers to complete the bleaching.

The amount of water used in preparing rag stock is very considerable. Sindall¹ states that the water required to wash the rag stock for a ton of paper is 25,000 to 35,000 gals. Beadle² estimates the quantity used in preparing the rags for one ton of two grades of paper to be as follows, measurements being in Imperial gallons.

¹ Sindall: Paper Technology.

² Beadle: Chapters on Paper Making, Vol. IV.

	Bank paper	Rag paper
Boiling rags.....	1,500	1,100
Rinsing rags.....	1,500
Washing in engines.....	40,000	37,830
Washing out bleach.....	5,000	5,000
	48,000	43,930

The losses which rags undergo in making into paper vary enormously with the quality of the rags and the treatment they are given. The following table, condensed from data in Hofmann's "Papier Fabrikation" shows the losses in preparing half stuff from different materials.

Kind	Mois- ture	Cutting and dusting	Cook- ing and wash- ing	Beat- ing to half stuff	Bleach- ing	Total loss	Kilos bone dry half stuff per 100 kg. rags
	Per cent	Per cent	Per cent	Per cent	Per cent	Per cent	
White linens.....	5-7	4-5	7-12	4-9	3-6	26-33	67-74
Bagging.....	5-11	5-7	11-18	12-14	5-9	42-55	58-45
White cotton.....	4-5	5	11-13	8-9	4	34	66
Red and blue calico.....	6	6	12-13	12-13	4-5	40-42	58-60
Half wool and old rags..	6	6	38	10	4	64	36
Blue linen.....	6-7	6	10-13	9-14	4-5	35-45	55-65

Similar data from the records of an American book paper mill using rotary boilers are:

Kind	Sorting and tare	Thrashing	Cutting	Total loss to finished paper
	Per cent	Per cent	Per cent	Per cent
Japanese blues.....	3.1	2.4	3.6	34.6
New calico.....	5.9	4.0	0.4	26.2
Belgian blues.....	3.5	4.9	2.8	42.2
Whites.....	1.5	0.2	5.0	25.5
Muslins.....	7.8	1.8	3.1	41.7
Russian blue linens.....	3.7	2.5	6.7	45.8

Beadle¹ in recording English practice gives the following figures for the losses on boiling and bleaching.

¹ Beveridge: Paper Makers' Pocket Book.

	Percentage lost on	
	Boiling	Bleaching
	Per cent	Per cent
Best new cottons.....	8.71	3.29
Low grade cottons.....	12.20	7.70
No. 1 cotton rags.....	5.80	6.20
No. 3 cotton rags.....	12.50	4.30
New unbleached cottons.....	23.50	13.00

Esparto. Esparto, because of its high cost, has never come into competition in this country with soda fibre prepared from woods, but in Europe, and more particularly in Great Britain, it is one of the most important fibrous raw materials. Introduced into England in 1860 by Routledge, its use increased from 16 tons in 1861 to 184,000 tons in 1884, since which time about 200,000 tons have been used every year, not including what is used on the Continent.

The grass is imported in bales bound with iron or twisted bands of esparto. These bales are opened up and spread out on tables covered with iron netting to allow sand and dirt to pass through, and the grass is sorted by hand to remove roots, weeds, etc., which are more resistant to alkali than esparto and hence cause dirt and shives in the pulp. The loss in dusting and hand picking is 1 to 6 per cent. The dust contains sand and other mineral matter as well as fat or wax from the esparto itself. The analysis of fine dust is given by Beveridge¹ as follows:

	Per cent
Organic matter (by ignition).....	64.6
Water (loss at 212° F.).....	6.2
Mineral matter.....	29.2

Of the organic matter, about 90 per cent is of a waxy nature, while the mineral matter or ash gave the following analysis:

¹ Beveridge: Paper Makers' Pocket Book.

	Per cent
Silica (SiO ₂).....	56.43
Calcium carbonate (CaCO ₃).....	19.17
Magnesium carbonate (MgCO ₃).....	3.76
Alumina (Al ₂ O ₃).....	<u>20.57</u>
	99.93

Machine cleaning by willows is also resorted to and by some is considered superior to hand picking. The grass from the willows goes directly to the cookers without any further sorting, and sand and uncooked weeds, etc., are removed by sand traps and screens after cooking.

The boilers used for esparto may be merely open tubs since little or no pressure is necessary but the more general practice is to employ closed, stationary boilers with some device for circulating the liquor. Rotary boilers are almost never used as they cause the fibres to roll up into small balls which beat out with great difficulty and are apt to cause lumps in the paper. The capacity of esparto boilers is generally 2 to 3 tons of grass. The boiler is partly charged with lye and the esparto is fed in, steam being admitted at the same time to soften it and enable a greater quantity to be packed in. The grass, which is not cut as in the case of straw, is charged through the top and after cooking is removed through a side door near the bottom. The steam pressure carried varies in different mills from 5 to 50 lbs., and the time of cooking from 2 to 6 hours; the present tendency seems to be toward the higher steam pressures.

As compared with rags esparto requires a much greater amount of alkali, which is invariably soda, since lime is never used because of the formation of insoluble compounds. The amount of alkali recommended by Dunbar for different grades of grass is as follows:

Fine Spanish.	16.1-17.9 lbs. 70 per cent caustic per 100 lbs. grass
Medium Spanish..	14.3-16.1 lbs. 70 per cent caustic per 100 lbs. grass
Fine Oran.	16.1 lbs. 70 per cent caustic per 100 lbs. grass
Medium Oran.	14.3-15.2 lbs. 70 per cent caustic per 100 lbs. grass
Tripoli.	17.0-17.9 lbs. 70 per cent caustic per 100 lbs. grass

The liquor for boiling varies from 7 to 15 degs. Tw.

As typical examples of actual cooks made under fairly good working conditions Beveridge ¹ gives the following:

	Spanish	Tripoli
Weight of charge.....	5600 lbs.	5600 lbs.
Caustic liquor per charge, gals.....	1570	1570
Pounds of 60% caustic per charge.....	900	1020
Steam pressure, maximum.....	20 lbs.	20 lbs.
Time under pressure.....	2½ hrs.	3 hrs.
Yield, unbleached air dry fibre.....	44-45%	41-42%

When the cook is completed the pressure is blown down and the liquor run off to the recovery system; hot water is then run into the boiler and the pressure brought up to 20 to 30 lbs. This is again blown off, the stock drained as dry as possible, removed, and conveyed to the washing system which usually consists of engines similar to those used in treating rags. During washing much of the cellular matter (leaf hairs) is removed and some short fibres are lost.

The bleaching of esparto is generally carried out in engines. The bleach required varies from 7 to 12 per cent of the unbleached fibre and often a little sulphuric acid is added to the engine about half an hour after the bleach. When bleaching is completed the stock is run off on a press-pâte which serves the double purpose of removing the bleach residues and delivering the fibre in a convenient condition for further operations.

The recovery of alkali from the waste liquors is conducted along the same lines as with the liquors from wood. According to Griffin and Little ² the silica in the ash from esparto forms silicate of soda during furnacing and thus reduces the per cent of ash recovered. A recovery of 80 per cent is considered good while 85 per cent is the most that can be expected under the best conditions.

¹ Beveridge: Paper Makers' Pocket Book, p. 76.

² Griffin and Little: Chemistry of Paper Making, p. 158.

Straw. Straw as used in paper making includes the stems and leaves of the various cereals. The composition of straws, particularly with regard to the amount of ash and its constituents, varies greatly with the soil upon which they were grown. Wolff¹ gives the following analyses for different straws.

	Winter rye	Winter wheat	Summer barley	Winter barley	Oats	Corn
	Per cent	Per cent	Per cent	Per cent	Per cent	Per cent
Water.....	14.3	14.2	14.3	14.3	14.3	14.0
Ash.....	3.2	5.5	7.0	5.5	5.0	4.0
Fat and wax.....	1.3	1.5	1.4	1.4	2.0	1.1
Nitrogenous matter.....	1.5	2.0	3.0	2.0	2.5	3.0
Starch, sugar, gums, etc.....	25.7	28.7	31.3	28.4	36.2	37.9
Cellulose.....	54.0	48.0	43.0	48.4	40.0	40.0

Beveridge² considers the cellulose as determined by Müller's method too high and gives the following percentages obtained by digesting the straw with bisulphite of soda.

	Per cent
French wheat.....	41.5
Zealand wheat.....	40.9
Dutch wheat.....	41.6
Dutch oats.....	42.0
Dutch rye.....	44.7
Dutch barley.....	38.3

Cross and Bevan³ give the percentage of bone dry cellulose on bone dry straw as follows:

	Per cent
Oats.....	52.0 and 53.5
Oats, foreign.....	46.5
Wheat.....	49.6
Wheat, foreign.....	50.2
Rye, foreign.....	53.0

From analyses of rice straw by Takeuchi⁴ the following figures are taken:

¹ Wolff: Landwirtschaftl. Kalender, 1869, zitiert bei Hugo Müller, Die Pflanzfaser, p. 97.

² Beveridge: J. Soc. Chem. Ind., 1894, 101.

³ Cross and Bevan: Text Book of Paper Making, 1907, p. 136.

⁴ Takeuchi: Bull. Coll. Agric., Tokio, 1908, 7, 619-621.

	Good harvest	Poor harvest
	Per cent	Per cent
Hygroscopic moisture.....	12.31	9.85
Dry matter.....	87.69	90.15
Total nitrogen.....	0.97	1.48
Crude protein.....	6.05	8.82
Crude fat.....	1.36	1.65
Crude fibre.....	31.16	28.72
Crude ash.....	11.42	12.35
Silica.....	5.39	6.13
Dextrose.....	2.25	3.28
Sucrose.....	0.79	0.96
Starch and hemicelluloses.....	14.86	18.75
Pentosans.....	14.28	16.55

Analyses by the author of two samples of American grown rice straw of the "Carolina Gold" variety showed the presence of 14.5 and 12.4 per cent of ash of which silica constituted 81.6 and 79.7 per cent respectively.

The ash from various straws shows the following composition:¹

	Total mineral	K ₂ O	Na ₂ O	CaO	MgO	Fe ₂ O ₃	P ₂ O ₅	SO ₃	SiO ₂	Cl
	%	%	%	%	%	%	%	%	%	%
Barley, aver. of 4	8.10	23.75	1.92	7.53	2.62	2.19	3.94	3.91	51.43	3.75
Oat, aver. of 8....	7.77	38.37	3.99	4.23	2.53	1.79	2.66	3.06	35.68	7.99
Rye, aver. of 3....	4.32	26.28	0.74	11.10	4.45	3.19	8.97	5.57	36.86	3.68
Wheat, one test...	3.25	12.16	1.00	6.82	4.00	1.02	3.20	5.78	65.34	0.60

[Straw is used for the production of two quite dissimilar fibrous materials; a coarse, yellowish, halfstuff which is used for straw boards and cheap wrapping papers, and a bleached cellulose, similar to esparto in many of its properties, which enters into the composition of numerous high grade products.]

For the manufacture of straw boards, the straw, after dusting and cutting into short lengths, is treated with milk of lime in rotary boilers. The action of the lime is not vigorous, incrusting matters are not separated from the cellulose to any great extent and mineral matters originally present in the straw remain practically untouched in the finished product. According

¹ Wolff: Ashen analysen.

to Kirchner¹ it is the general practice in Germany to cook the chopped straw in rotary spherical boilers of 14 cubic metres (494 cu. ft.) capacity which hold 1100 kilos (2420 lbs.) or 1500 kilos (3300 lbs.) after tamping. The steam pressure varies from 45 to 75 lbs. and the time of cooking from 4 to 5 hours. A yield of 70 to 80 per cent is obtained.

In some plants the lime is slaked and strained into the boiler while in others the quicklime is added without slaking. If the lime is poor a little soda ash is sometimes added. Rye and wheat straw should not be boiled together since wheat needs more treatment than rye. For rye straw 8.5 per cent of quicklime is sufficient while for wheat 10 per cent is required. It is generally reckoned that there is a loss of 30 to 35 per cent of fibre substance from the dry straw to the finished paper.

According to B. Haas² the chopped straw and liquor are fed into the digester together and gently steamed at the same time, thus increasing the capacity of the digester fully 10 per cent. The digester should be rotated without steam to distribute the liquor, then steamed with the blow-off cock open to allow air to escape and finally steamed at 60 lbs. pressure for 2½ to 3 hours. If handled in this way it is claimed to be possible to cook wheat straw with 6 per cent of lime while under ordinary conditions it would require 13 to 15 per cent. If too much lime is used the resulting stock is "greasy," drains slowly and clogs wires and felts.

In France considerable straw is said to be treated by a cold process as follows: Rye straw is cut short and put into large rectangular brick wells where it is just covered with dilute milk of lime. Boards are put on, weighted down with stones and the whole left for two to four weeks. It is then taken out and worked in edge runners for at least an hour. This product is harder than straw pulp cooked by steaming at high temperatures and as the knots are not softened the grinding must be done with especial care. Straw pulp prepared in this way

¹ Kirchner: *Das Papier*, III, B and C.

² *Der Papier-Fabr.*, 12 (1914), 305-310.

possesses a natural self-sizing property which is lost if the milk of lime is heated and is absent in pulp cooked by the soda process. Hot cooked stuff requires much rosin size because of the presence of lime residues which it is impracticable to completely wash out.

The general American practice differs somewhat from the German in that the straw is not cut and sorted before cooking. The kind most generally used is winter wheat though some use rye and oat straw. It is always received at the mill in bales which are stored in large stacks near by; these stacks are frequently provided with roofs and sometimes with shelter on the sides. There appears to be little deterioration of the straw, except on the very outside of the bales or in those at the bottom of the pile, and even such straw, which has become very dark in color, is used by adding a little more lime to bring it to the right color. In filling the rotaries the bales are broken up and immediately fed in without sieving, cutting or any other method of preparation; in fact as much as a quarter of a bale is sometimes added without loosening up in any manner. This is done because it is believed a larger charge can be secured. As the rotary is filled about a gallon of water is added for every $2\frac{1}{2}$ lbs. of straw. The rotary is then revolved and steam admitted to raise the charge to 25 lbs. pressure which is maintained for half an hour or so. The head is removed, more straw added and the charge again steamed or "wilted" as before. This is repeated three or four times so that the final charge is about double that which was first added. At this point milk of lime is added, equivalent to 10 per cent calcium oxide (CaO) on the weight of the straw, after which it is rotated and brought up to 35 to 45 lbs. steam pressure where it is held for 8 to 10 hours. The liquor is drained off under pressure, the charge cooled till practically at atmospheric pressure, and then dumped onto the floor where it is allowed to season three to five days before being used. The straw is washed about four hours in washing engines, the washer taken up and the beating proceeded with.

The time required for one cook, including charging, cooking and cooling, is about 24 hours. The yield per ton of straw is generally figured as 1600 lbs. of board for rye, 1400 lbs. for wheat and 1200 lbs. for oat or rice straw.

The treatment of straw by the soda process for the production of a high grade bleached cellulose occupies an important place in the paper industry of Europe though it is practically never undertaken in this country. The kinds generally used are wheat, oat, rye and barley straws, and of these the first two are used most extensively in England. Since straw is more highly lignified than esparto it requires a more drastic treatment; even the knots must be so reduced that they will bleach readily. Because of this more severe treatment and because of the presence of cellular tissues which are lost during the washing process the yield from straw is less than that from esparto. Cross and Bevan¹ give the practical yield as about 35 per cent, while Beveridge² says that a mixture of equal quantities of barley, oat, wheat and rye straws will yield 40 to 41 per cent of air dry bleached cellulose.

The straw cellulose makes a weaker paper than esparto but it is suitable for mixing with rags or wood pulp for thin, hard, ratty papers. It tends to make the stock "wet" on the wire and imparts translucency to the papers in which it is used.

In modern plants the straw is cut by rotary cutters into pieces one to two inches long and freed from dust, grain, etc., by an air blast. It is then fed into the boilers, steam and alkali added at the same time assisting in packing the charge. Contrary to the practice with esparto rotary boilers are preferred for straw because the agitation of the charge permits a penetration of the liquor which cannot be obtained in a stationary cooker because of the close packing of the wet straw. The amount of alkali used varies greatly at the different mills and with the kind of straw; it may run as low as 10 per cent or as high as 20 per cent of the weight of the straw. Experiments conducted

¹ Cross and Bevan: Textbook of Paper Making.

² Beveridge: Paper Makers' Pocket Book.

by the author on rice straw proved that a simple extraction with water at 20 to 25 lbs. steam pressure removed so much material from the straw that well reduced and easily bleached fibre could be produced with 60 to 75 per cent of the caustic soda necessary for unextracted straw. Barley straw is said to require 20 per cent less soda than oat, wheat or rye straw. The time of cooking is variously given as $3\frac{1}{2}$ to 8 hours and the steam pressure as 10 to 90 lbs.; there seems to be a decided tendency toward the use of the higher pressures of from 75 to 90 lbs.

The cooked straw is run or blown from the boiler into wash tanks with false bottoms; these are preferred to drum washers because of the large loss of fine fibres and cellular matter which the latter cause. After washing, the straw is treated in edge-runners to crush the knots and it is then bleached in much the same way as esparto; the bleach required is from 7 to 10 per cent.

The recovery of alkali is carried out in the same way as with esparto or wood but the working of the process is rendered difficult in many instances by the silica in the straw. This combines with the alkali forming sodium silicate and when the recovered ash is causticized a bulky, gelatinous precipitate of calcium silicate results. This prevents settling in the causticizing tanks and very greatly reduces the amount of soda which can be recovered. A patented process by Sutherland and Kynaston proposes to precipitate the silica by adding bicarbonate to the solution of the recovered ash; carbon dioxide can also be used. They claim to obtain in this way a granular precipitate which can be easily handled, but the process has not been an entire success.

Beveridge¹ states that the soda lost varies with the amount of silica in the straw, with the composition of the silicate formed and with the amount of potash rendered soluble. He estimates that as much as 42 per cent of the total soda in the cooking liquor may be neutralized by the silica and claims that when the amount of silica in the straw approaches 3 to 4 per cent of its weight the recovered ash is of little value for further

¹ Beveridge: Paper Makers' Pocket Book.

digestions. The recovery in a Russian mill operating by the sulphate process is claimed to be 80 per cent.¹

Numerous other processes have been suggested for treating straw. Chlorination in stone chambers, of straw which has been partially cooked with caustic soda, followed by a treatment with bleach, gives a high yield of well-bleached, uniform stock, but the process is too costly and difficult to manage. Diess and Fournier² propose steeping the straw in acidulated water for three hours, retting by organisms cultivated from African esparto, and finally cooking with strong caustic soda solutions — 20° to 30° Bé. — at 45 to 75 lbs. steam pressure for three to five hours. Reichman³ treats the straw with caustic soda, washes, treats with hydrofluoric acid of 1° to 2° Bé. for about five hours and finally washes with dilute ammonia. Probably the only modification of the original soda process which has found any extensive use is the sulphate process and this has been applied to straw with notable success.

The sulphite process is not generally applied to straw, though in isolated cases good fibre has been prepared from it in this way and practical experience has shown that it can be employed with excellent results. The general assumption that the large proportion of silica in the straw would interfere with its treatment by the sulphite process is apparently not founded on fact.

Bamboo. Bamboo, while not of immediate interest in this country, seems destined to hold an increasingly important place as a source of fibre because of the rapidity of its growth and the high quality of the paper which can be made from it. Raitt⁴ estimates that with poor growth the annual yield of stems would be 11 tons, air dry, per acre while with luxuriant growth it may amount to as much as 44 tons. He states that in Lower Burma alone there is an area of about 20,000 square miles easily available.

¹ Altman: Chem. Ztg., 1911, 35, 979.

² French Pat. 403, 518.

³ English Pat. 12,059, May 21, 1909.

⁴ J. Soc. Chem. Ind., 1908, 27, p. 35.

Characteristic analyses of Philippine bamboos are given by Richmond as follows:¹

	Structural bamboo	Dwarf bamboo
	Per cent	Per cent
Cellulose.....	53.94	55.75
Fat and wax.....	0.96	1.03
Water extract.....	4.98	4.69
Non-cellulose or lignin.....	24.25	21.27
Water.....	12.40	11.20
Ash.....	3.47	6.03

Analyses of typical absolutely dry Indian bamboos are:²

	B. polymorpha	B. arundinacea	C. pergracile
	Per cent	Per cent	Per cent
Cellulose.....	54.71	50.32	52.73
Fat and wax.....	1.05	1.17	0.92
Water extract.....	8.95	8.48	7.96
Pectose.....	19.55	24.39	23.09
Lignin.....	15.74	15.64	15.30
	100.00	100.00	100.00
Ash...	3.97	1.60	2.57

By an extended research on the five most likely Indian bamboos, Raitt³ has shown that by the soda process yields of 41.0 to 43.0 per cent of bleached fibre may be obtained, but the bleach consumption is high. When the sulphate process is used the yields are 42 to 44 per cent and the bleach required is much lower — 15.5 to 18.0 per cent. He finds the sulphite process is unsuited to bamboo because of the difficulty of bleaching the fibre and of working with sulphite liquor in a tropical climate.

Raitt overcame the difficulties previously encountered with bamboo by adopting the following treatment:

(1) Culms not to be cut till the shoots of the year are full grown.

¹ Richmond: Philippine J. Sci., I, 1906, 1075-1084.

² Raitt: Indian Forest Records, Vol. III, Part III, p. 15.

³ Raitt: Indian Forest Records, Vol. III, Part III.

- (2) Seasoning for at least three months before use.
- (3) Crushing.
- (4) Extraction of starchy matter.
- (5) Digestion with sulphate liquor.

The limiting conditions of satisfactory digestion for the five species investigated were found to be 20 to 22 per cent caustic soda (including the sodium sulphide), temperatures of 162 to 177 degs., pressures of 80 to 120 lbs., and durations of 5 to 6 hours.

Old Papers. In the case of old printed papers of the higher grades, such as book and magazine papers, in which there is no ground wood, little difficulty is experienced in preparing them for use a second time. The removal of the printer's ink can be effected by cooking in digesters with a caustic soda solution followed by disintegration and washing of the pulp. The alkali removes the rosin sizing and saponifies the oily constituents of the ink thus rendering them soluble and loosening the pigments so that they may be detached from the surface of the fibres and washed out.

In this process, as applied to old magazines for instance, the staples are removed by mechanical means and the magazines fed into rotary digesters. The removal of the staples allows them to come to pieces sufficiently so that the alkali can penetrate enough to reach all parts of the paper and opening up by thrashers is therefore not necessary. About 3 to 4 per cent of caustic soda, on the weight of the papers, is then added together with enough water to insure thorough saturation of the charge and it is cooked at 40 to 50 lbs. steam pressure for a number of hours, sometimes as long as 13 hours. After blowing down pressure the rotary is dumped and the stock allowed to drain, after which it is transferred to washers and washed and bleached in practically the same manner as rag stock. The time required for washing varies greatly with the size and condition of the washing engine, it may even go as high as 15 hours although this is not usual if the stock has been well drained. The bleach required amounts to 3 to 4 per cent of the

papers used and the color obtained is usually a grayish white because of the impossibility of removing all traces of the carbon from the printer's ink. This process involves a considerable loss due first to the action of the soda and steam in the digester and second to the mechanical loss of fine fibres and the mineral fillers during the washing. The combined loss from these causes will frequently amount to 35 to 40 per cent of the absolutely dry papers used.

Similar results are obtained by tearing the papers up somewhat and heating in large boilers with an 8 to 10 per cent solution of soda ash. The temperature is maintained just below the boiling point as the object is merely a surface loosening of the ink and not complete disintegration of the paper to a fibrous stock.

It has also proved possible to eliminate the rotary digester and carry out the entire process in the beating engine or washer. The printed papers, either plain or coated, are fed into the engine with water and about 2 per cent of caustic soda based on the papers. When warmed to 120° F. they disintegrate readily and in a short time the washing can be started and carried out as usual. The color of the stock obtained is better than that of the material cooked in rotaries and the loss is probably slightly less. The chief objection to the process is that the old magazines which are largely used have to be thoroughly broken up before adding to the beater.

In either of these processes ground wood has to be carefully avoided because it is turned brown by the alkali, yet is not cooked enough so that it will bleach to a good color. Serious trouble has been caused at times by getting ground wood papers into the rotary and it is well to supply the sorters with phloroglucin or paranitro-aniline so that they may test suspected papers and throw aside all those found to contain ground wood. Stock which contains ground wood, after passing through the rotaries and bleachers, has the appearance of being contaminated with fine, brown hairs or fibres. These are very conspicuous when such print papers are used in a white sheet. It

is interesting to note that after cooking the ground wood is just enough changed so that it gives no test, or at most a very faint pink, with phloroglucin.

This explains why it has proved so difficult to recover the stock from old newspapers, which consist of approximately three-quarters ground wood. The problem has, however, proved very attractive to a large number of investigators and the patents taken out are very numerous. Among the reagents which it has been proposed to use are various alkalis and alkaline salts, silicates, borates, phosphates, etc., soaps, peroxides, hypochlorites, aluminum chloride, enzymes and inert materials, such as clay, talc, fuller's earth, etc. These latter seem to be added to serve as points about which the pigments from the ink may gather and thus facilitate their removal by the washers. Most inventors are not content with adding single reagents or even simple combinations of two or three, but in cases use as many as eight different substances at the same time. Any such combinations to be of value in treating ground wood papers must be only weakly alkaline and must be used at comparatively low temperatures. Among the materials which have been found best for this purpose are fatty soaps and similar materials used in conjunction with soda ash and sodium silicate.

Experiments have proved that the disintegration of the printed papers with the detergent in kneaders where comparatively dry conditions are maintained produces poor results. The pigment is set free under such conditions that it is ground into the pores of the fibres and it is then almost impossible to wash out enough of it so that a good color can be obtained. If the papers are disintegrated and then diluted in the washer before mixing with the detergent much better stock will result because the separated ink is then in such a state that it tends to rise to the surface and can be more readily removed by the washers. It is evident, then, that a method of disintegration which tends to pull the ink from the surface of the paper is superior to one which tends to grind it into the fibres.

Such a procedure has been embodied in the Winestock process

for the recovery of old papers. The apparatus used is shown in sectional view in Fig. 6 of a machine driven by a direct connected steam turbine, *M*. The essential features are a propeller tube *B* at the bottom of a cylindrical tank *A* which is mounted within a chamber *H*; through the horizontal part of the pro-

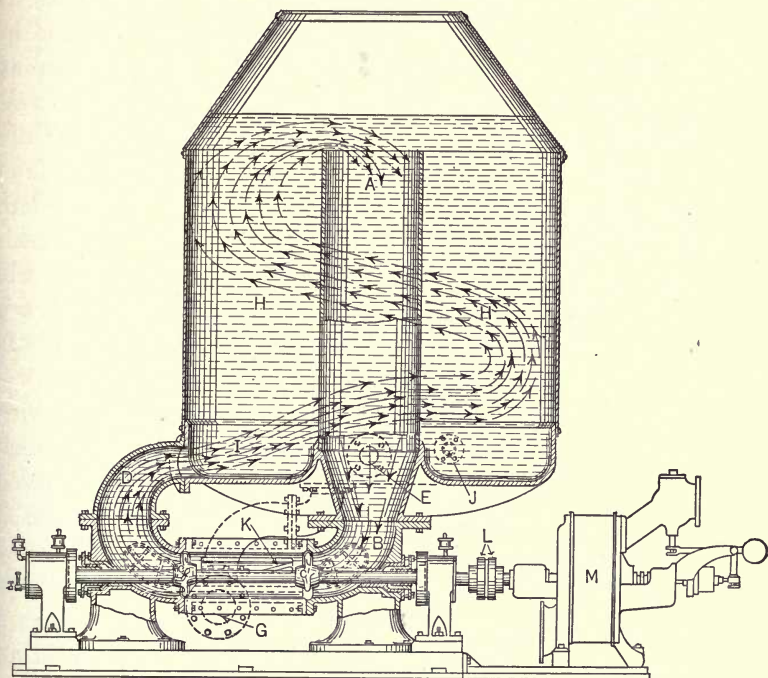

FIG. 6. WINESTOCK DEFIBERING MACHINE

Courtesy of Castle, Gottheil & Overton

PELLER tube extends a shaft which turns at 2000 revolutions per minute and upon which are mounted two propellers of different pitch. Between the propellers is a baffle plate *K* to stop any inclination toward a rotary motion of the stock in the tube.

The papers to be treated are opened up and dusted in a railroad duster or its equivalent and then soaked in a tank of water at about 160° F. either with or without the addition of soda ash or other detergent. They are then charged into the cham-

ber *H*, together with any other additional detergents desired, such as a mixture of soda ash, caustic soda or a soap composed of tallow, soda ash, caustic potash and silicate of soda. The chamber *H* being full the stock overflows into the cylinder *A* and is circulated by the propellers back to the chamber *H* which it enters tangentially and through which it circulates to again enter *A*. The basic idea is that the paper suspended in water or a weak alkaline solution is struck by the blades at such a speed that it is unable to take up the rapid motion and is therefore pulled out or defibred while at the same time the ink is loosened from the fibres by the violent agitation. The second propeller has a greater pitch than the first so that there is cavitation between the two or a pressure on one side of each propeller and a suction on the other. The speed at which the stock circulates is estimated at 1200 ft. per minute. Since there is no cutting or grinding action in this machine there is no shortening of the fibres.

The time of treatment necessary in this machine varies with the papers used and the products desired. Newspapers which are to be used for boards and from which the ink is not removed require only about fifteen minutes; if the product is to be used for white paper, and the ink must be washed out, about thirty minutes are required. Book and magazine papers need thirty-five to forty-five minutes' treatment and hard sized writings a somewhat longer time. The machine holds 700 to 900 lbs. of dry papers per charge and requires from 40 to 60 horse power.

Assuming that the papers have been sorted with reasonable care and strings, bags and foreign materials eliminated, the Winestock process is suitable for all classes of papers, since the low temperatures and mild chemicals do not cause any serious discoloration of ground wood. As the apparatus liberates the ink and color from the fibres but does not remove the loosened pigment a subsequent washing is necessary.

CHAPTER IV

THE SODA PROCESS

The principles upon which this process depends are the solvent power of the caustic soda for certain constituents of the wood and the hydrolysis of other constituents resulting, to a considerable extent, in the formation of products of an acid nature which are then brought into solution as salts of soda. Both of these processes neutralize the alkali and by diminishing its concentration and hydrolyzing power render it useless for further work until it is regenerated. The reactions and decompositions involved are of a very complicated nature and the products are numerous and for the most part ill-defined and little understood. The degradation of the woody constituents is in general far greater than for the same constituents when dissolved by the sulphite process.

Even at low temperatures alkali dissolves a very appreciable proportion of the non-cellulose constituents while if the temperature is raised the action is greatly intensified. Experiments on small poplar chips showed that a 3.3 per cent solution of caustic soda would dissolve 20.3 per cent of their weight by twenty-four hours' treatment at 25° C. while if the temperature were raised to 80° C. the wood lost 31.6 per cent of its weight in the same time. Higher temperatures, such as are obtained by steaming under pressure, still further enhance the solvent power of the alkali and the speed with which it acts.

In working with materials other than wood due consideration must be given to pectous substances. Working with bamboo Raitt¹ finds that pectose (matter soluble in 1 per cent NaOH solution at 100 degs.) is easily soluble in boiling NaOH solutions

¹ Indian Forest Records, Vol. III, part 3, "Bamboo as Material for Paper-pulp."

but that it gelatinizes at the temperatures employed in digestion and is therefore likely to become mechanically attached to the cellulose and is then very difficult to wash out. Pectose, fat and wax grouped together neutralize 0.32 per cent of NaOH on the raw material for each 1 per cent found on analysis. Lignin, unlike pectose, is not soluble in weak solutions nor at temperatures below 130 degs.

The wood most used in the soda process is poplar, at least in the northern part of the United States, but because of its increasing cost and scarcity other woods are frequently substituted. Among these may be mentioned basswood, maple, birch, cottonwood, tulip tree, sycamore, several kinds of gum, chestnut, beech, etc. The best results are obtained if the different kinds are treated separately but this is frequently impossible without an excessive amount of labor. If mixed woods are used it is desirable to employ those which require about the same degree of treatment and to keep the mixture as nearly constant as possible. The mixing of woods which require widely different cooking conditions invariably means diminished yield because of the overtreatment of at least one kind in order that the most difficult to reduce may be sufficiently cooked.

For long fibred stock, spruce, hemlock, pine and white fir are sometimes treated by the soda process. They require more alkali and longer cooking and yield less pulp than the broad-leaved woods. The soda pulp industry is, however, using pine in rapidly increasing quantities and in this way it is possible to use a number of woods which are too resinous to be treated by the sulphite process. According to the United States Department of Agriculture out of a total of 843,048 cords of wood used in the soda process during 1917, 379,466 cords were poplar, 11,069 cords were hemlock, and 116,267 cords were pines of various kinds.

On account of the vigorous action of the alkaline solutions less care is necessary in preparing the wood than for the sulphite process. Knots are either dissolved by the treatment or left in such condition that they are easily separated by the screens.

Contrary to the usual belief the inner bark, however, is a source of trouble and should be removed as completely as possible. It cooks with difficulty, uses up fully as much caustic soda as sound wood, and bleaches with far more difficulty than the fibre from the wood. If the two are cooked and bleached together the resulting product is liable to be contaminated with brown, stringy shives. The outer bark also uses up a large amount of caustic and in cooking breaks down into masses of cells which will not bleach to better than a yellowish brown color and hence cause dirt specks in the bleached pulp. These are not the only faults of bark, for its rough surface tends to catch dirt from outside sources, such as cinders, sand, etc., and transfer it to the pulp.

It is not necessary to remove decayed portions of the wood since they are completely resolved during the cooking and do no harm unless they are of a very black nature. Such decayed wood, however, gives a very low yield of fibre and if present in large amount greatly reduces the output of the digesters, so that for this reason, at least, its use is to be avoided. The cellulose in partly decayed poplar wood was found by us to be 24.9 and 27.0 per cent in two samples as compared with 63 per cent for sound wood.

The wood is chipped by running the logs diagonally against the face of a rapidly revolving disc from which project from two to four knives. The distance to which these extend determines the length of the chip, which for poplar is from three-quarters of an inch to an inch and a quarter. The chips go next to some form of screen which separates them into three grades, dirt and very fine material, good chips, and slivers and coarse pieces. The dirt and fine stuff is waste, so far as pulp making is concerned, though it is often used as fuel in the boiler house, while the slivers and coarse pieces are either crushed or rechipped and returned to the screens. Uniformity of cooking is greatly aided by a uniform size of chips but it is not so essential as in the sulphite process because of the greater penetrating power of the alkaline liquor.

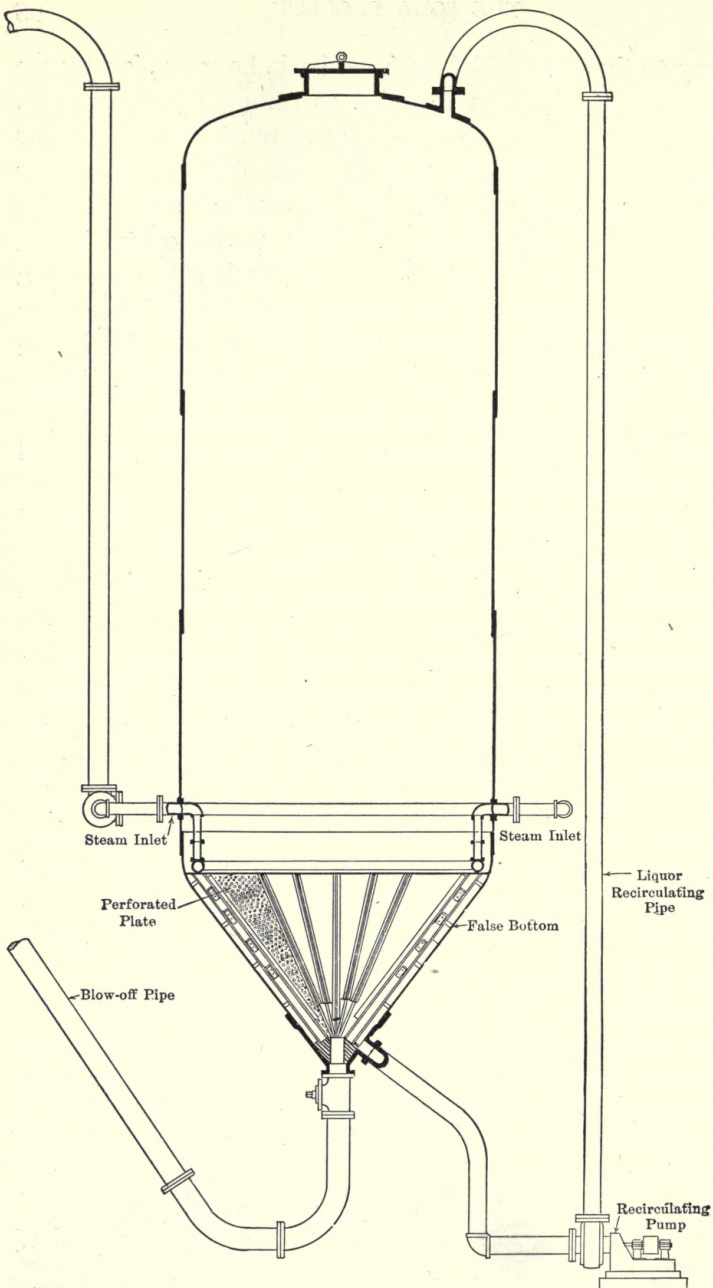

FIG. 7. VERTICAL DIGESTER, SECTION SHOWING INLETS, PUMP, AND PIPING (96)

The digesters used in this process are of the usual rotary or stationary types but vary greatly in size and capacity. The tendency is toward the vertical stationary type Fig. 7, and away from the rotaries since the former effect savings in floor space, power required and time of filling and emptying. The latter is a very appreciable item, as a rotary holding 3 to $3\frac{1}{2}$ cords requires three hours for blowing down pressure, discharging the contents and refilling with chips and liquor, while a vertical digester

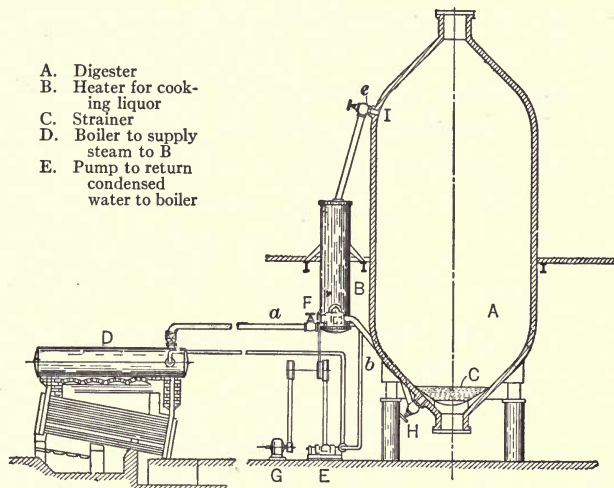

FIG. 8. MORTERUD DIGESTER

holding 14 to 15 cords of wood requires only one hour for the equivalent operations. The size of rotary digesters in American practice is generally about 20×7 ft., while the vertical digesters range from 27 to 49 ft. tall by 7 to 10 ft. in diameter; one 30×8 ft. will hold about 5.5 cords while one 49×10 ft. will hold nearly 15 cords of wood.

A modified type of digester is that used in the Morterud system of cooking with forced circulation and indirect heating. Such an outfit is shown in Fig. 8. The steam in this system is not blown directly into the charge but the liquor is circulated through an outside exchange heater in which steam is the source

of heat. The condensed steam is returned to the boiler as feed water under high pressure and at a high temperature. The claims for this process are savings in coal and alkali and an increased yield because of the more even temperature of the cooking liquor.

Another modification is that of the jacketed digester in which the steam for heating is between the two walls. Experience has proved that these are very hard to keep tight as the stays between the walls cause very frequent leaks. No insulating covering can therefore be used and the steam consumption is very high because of the great loss by radiation.

The material of the digesters is either iron or steel and they are made either riveted or welded. The latter is much to be preferred, since the alkaline solutions work their way through crevices which would be impervious to water and for this reason a riveted seam is very difficult to make perfectly tight. As the alkaline solutions are practically without action on the material of the digester no lining is necessary.

In filling the digester the chips and liquor are run in at the same time and in order to get in as large a charge as possible a tamping device is sometimes employed. This is especially necessary for horizontal rotaries. The time required for charging a rotary holding 3 to $3\frac{1}{2}$ cords is about one hour, while chips from 14 to 15 cords of wood can be run into a vertical digester in 15 to 20 minutes.

The cooking liquor for the soda process is merely a solution of caustic soda containing a small amount of sodium carbonate. It is generally made at the mill by causticizing soda ash with quick lime. The reaction on which the process depends is

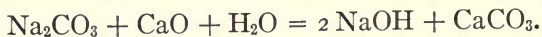

This is a reversible reaction and the extent to which the soda ash is causticized depends on the dilution of the liquor. Experiments by Lunge¹ illustrate the effect of concentration as follows:

¹ Lunge: Sulphuric Acid and Alkali, 2nd ed., Vol. II, p. 750.

Liquor before causticizing		After causticizing
Per cent Na_2CO_3	Specific gravity	Per cent causticity
2	1.022 at 15° C.	99.4
5	1.052 at 15° C.	99.0
10	1.107 at 15° C.	97.2
14	1.150 at 15° C.	94.5
20	1.215 at 30° C.	90.7

It is obvious that the lower the concentration the higher the causticity and that therefore a demand for a definite concentration sets a limit to the causticity attainable. Attempts to increase the causticity by boiling either under diminished or increased pressure have met with no success; practically all causticizing is therefore done in tanks under atmospheric pressure.

The type of equipment used for causticizing varies greatly in the different mills; it may be stated to consist generally of a wrought iron tank fitted with an agitator and frequently a perforated basket near the top for holding the lime. The tank is filled with soda ash solution until the bottom of the basket is just covered; it is then brought to a boil and the lime added to the basket very gradually. As the lime slakes it passes through the perforations while stones or unburned cores are retained and may be easily removed. If the tank is not fitted with a basket the lime is thrown directly into the hot soda ash solution and slaked in the bottom of the tank. It has been found best to boil with a steam coil rather than by blowing steam directly into the liquor. Agitation with compressed air is also not to be recommended as it reduces the causticity slightly. The time of boiling has a considerable influence on the causticity obtained as the latter increases with the duration of the boil. The size of the plant in relation to the necessary output frequently limits the time of boiling but if possible it should be continued for at least an hour; beyond this point it is doubtful if the gain in causticity will pay for the extra expense.

Greater causticity can also be obtained in many cases by increasing the agitation. This has been done in certain instances, where adding more wings to the agitator shaft, or increasing its speed, has enabled less lime to be used in obtaining the same amount of caustic soda. Tests on a small scale have proved that thorough agitation is to a large extent equivalent to boiling, and that if the agitation is complete enough the charge need not be boiled at all as a temperature of 85 degs. is ample.

The causticizing operation is generally carried out in about the following manner. The soda ash and lime are boiled and then allowed to settle in the same tank. The clear liquor is drawn off by an adjustable syphon, more soda ash and water are added and the sludge again boiled up and then pumped over into a second tank. The sludge from this is flooded with weak liquor and again boiled up and settled. Fourth and fifth boilings are made with clear water. The clear liquors from the first four boilings combined make the cooking liquor, while the fifth boiling produces the weak liquor for a subsequent third boil.

The Dorr Company have recently proposed to causticize and wash the lime mud in a continuous operation by machinery similar to that used in metallurgical work. The lime is crushed and continuously mixed in definite proportions with a soda ash solution; the mixture then passes through three reaction agitators which are furnished with steam coils and then goes to the first thickener. The clear liquor overflowing from this goes to the storage tank for cooking liquor, while the sludge is pumped to the second thickener where it is mixed with the overflow from a third thickener. The clear liquor from the second thickener flows to the reaction agitators, while the sludge goes to the third thickener and thence to waste or to a recovery plant for lime. A causticizing plant of this type is shown in plan in Fig. 9. A plant operated in this manner has been in operation for some time and is said to be giving good satisfaction. It seems doubtful if it is very much superior to a carefully supervised plant of the ordinary type.

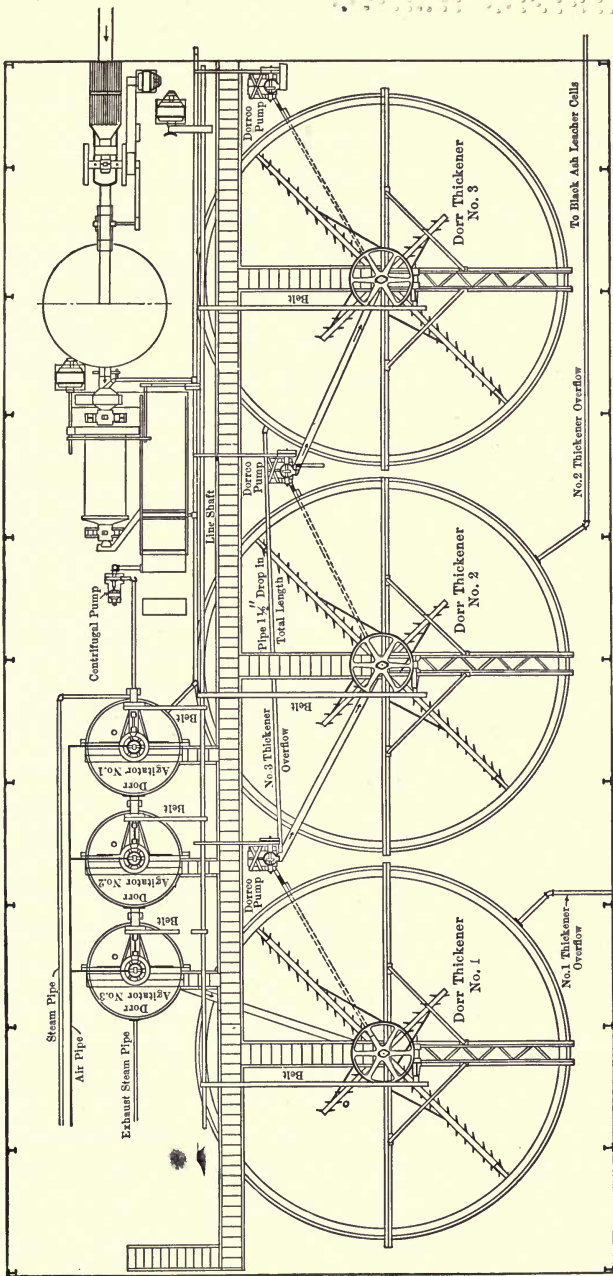

FIG. 9. PLAN OF CONTINUOUS CAUSTICIZING PLANT
Courtesy of The Dorr Company

The lime mud produced in causticizing is generally a waste product, though there is sometimes a small local demand for agricultural purposes. Attempts have been made to reburn the mud and use the lime over again and a number of plants are now operating with rotary kilns similar to those used in the cement industry. The lime mud is freed from water as much as possible by mechanical means and then enters the kiln, through which it passes in a direction opposite to the combustion gases. It is first dried and then heated to such a temperature that the carbon dioxide is driven off and the material delivered as burned lime. A kiln 7 ft. in diameter and 120 ft. long will burn 35 to 40 tons of lime per day, while for capacities between 20 and 30 tons a kiln 6 ft. by 100 ft. is sufficient. If the mud enters at 55 per cent dry, the fuel requirements will be about 9500 cu. ft. of natural gas or 675 lbs. of coal per ton of lime burned.

In order to keep the impurities down to a reasonable figure it has been found necessary to remove about 10 per cent from the circuit regularly. Where producer gas is used one passage through the kiln adds three pounds of impurities for every 100 lbs. of quick lime, but this only reduces the causticizing power of the lime 2 per cent because the impurities are held mechanically rather than chemically. When powdered coal is used instead of gas 6 per cent of impurity is added and this reduces the causticizing power of the reclaimed lime by fully 18 per cent. The lime mud and the reclaimed lime from a gas-fired kiln contain the following impurities for every 100 lbs. of available calcium oxide; as may be seen nearly all of the impurities added in reclaiming come from the fire brick lining.

	Lime mud	Reclaimed lime
	Per cent	Per cent
Magnesia, MgO.....	1.3	1.1
Oxides of iron and alumina, Fe ₂ O ₃ and Al ₂ O ₃	0.9	2.6
Sodium oxide, Na ₂ O.....	1.6	1.1
Sulphur trioxide, SO ₃	0.2	0.7
Silica, SiO ₂	0.7	2.2
	4.7	7.7

The following analyses show the composition of the new lime and the recovered lime from a plant using natural gas as a fuel.

	New lime	Recovered lime
	Per cent	Per cent
Calcium carbonate, CaCO_3	4.48	3.91
Iron and alumina, Fe_2O_3 and Al_2O_3	0.15	1.62
Silica, SiO_2	0.16	0.70
Calcium oxide, CaO	92.00	89.58
Magnesia, MgO	2.62	1.96
Undetermined.....	0.59	2.23

The recovered lime is in the form of rounded nodules ranging up to the size of a hen's egg. It is often slightly greenish or yellowish in color and slakes rather more slowly than good lime.

The strength of the caustic liquor used in cooking varies from 8° to 15° Bé. at 60° F. according to operating conditions. Stationary digesters require more dilute solutions than rotaries, while wet wood necessitates increasing the strength of solution to counterbalance the water contained in the chips. If digesters are heated by jackets or closed coils, weaker liquors may be used because they are not diluted by any condensed steam. With direct heat in rotaries about 700 to 900 gals. of liquor are used per cord of wood while in digesters the liquor amounts to about 800 to 1100 gals. per cord.

The boiling operation is a very simple one, the object being to reach full pressure as soon as possible and maintain it to the end of the cook. During this period the air which collects in the top of the digester is blown off several times through the "relief pipe" so that no false pressure may be recorded on the gauges. This "relief" is usually not necessary when cooking in rotary digesters. The uniformity of the cook depends on good circulation of the liquor and in practice this is obtained in several ways. Some digesters are fitted with internal circulating pipes on the same principle as the vomiting pipes in rag boilers, while another very successful and positive method of

circulating is to take the liquor from below the false bottom and pump it up into the top of the digester; as both sides of the pump are under the same pressure very little power is required.

The steam consumed in cooking depends on the form of the digester, on whether it is covered with an insulating covering or not, and on the size of the charge. Steaming may be considered as taking place in two stages, the period in which the charge is being brought up to pressure, during which the demand for steam is very great, and the period at full pressure when only enough steam is required to make up for the heat lost by radiation. Records obtained with steam flow meters on three sizes of digester gave the following results in pounds of steam required.

	3-cord rotary	6½-cord rotary	15-cord vertical digester
While coming up to pressure (lbs. per hr.)	7,500-7,800	10,800	20,000-22,100
During period at pressure (lbs. per hr.)	500	1,050	1,250*
Total required during cook (lbs.).....	12,125	19,360	37,750-44,250

* Calculated by radiation formula for steam pipes.

In spite of the apparent simplicity of the process there are a number of factors which greatly influence the results, and uniform and satisfactory cooking depends on the proper adjustment of these variables. Much study has been given to these factors by the author and at about the same time by the Forest Products Laboratory who published a bulletin¹ on their results. The following discussion of the individual variables is based on the author's experiments which were very carefully made in special apparatus which enabled very close control of all conditions to be maintained. The experiments were all made with poplar chips and all yields are figured as bone dry fibre on bone dry wood. Fig. 10 illustrates the effect of changes in steam pressure upon the yield and the bleaching properties of the fibre when all other cooking conditions are kept constant.

¹ U. S. Dept. of Agriculture, Bulletin No. 80.

In this and the succeeding charts the fibres were all bleached to a standard color so that the figures are directly comparable. It is at once evident that the yield is greatly influenced by the steam pressure employed and that the decrease in yield is at a nearly constant rate for pressures between 70 and 130 lbs. Throughout this range increasing the steam pressure 10 lbs.

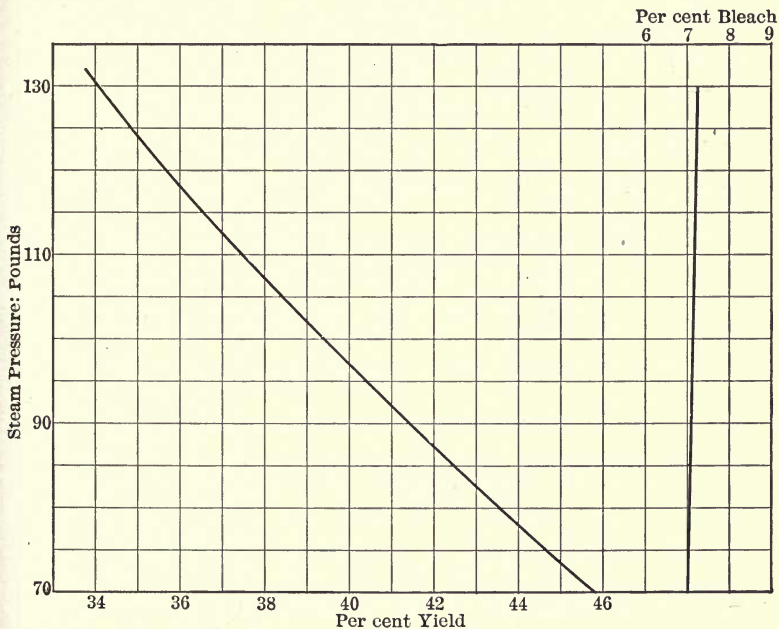

FIG. 10.

decreases the yield by about 2 per cent on the absolutely dry wood used. The bleach required is practically constant, proving that even 70 lbs. steam pressure will produce satisfactory pulp. This is contrary to the claims of Christiansen¹ who states that the minimum temperature for the production of soda pulp is 170° to 175° C. (100 to 115 lbs. steam pressure). Probably this discrepancy is to be accounted for by the difference in the woods used.

¹ Christiansen: Natronzellstoff, Berlin, 1913.

A study of the effect of steam pressure in semi-commercial cooks (400 lbs. chips) in a vertical, stationary digester gave results following very closely the form of curve of the small-scale cooks. The yields were, however, 8 to 9 per cent

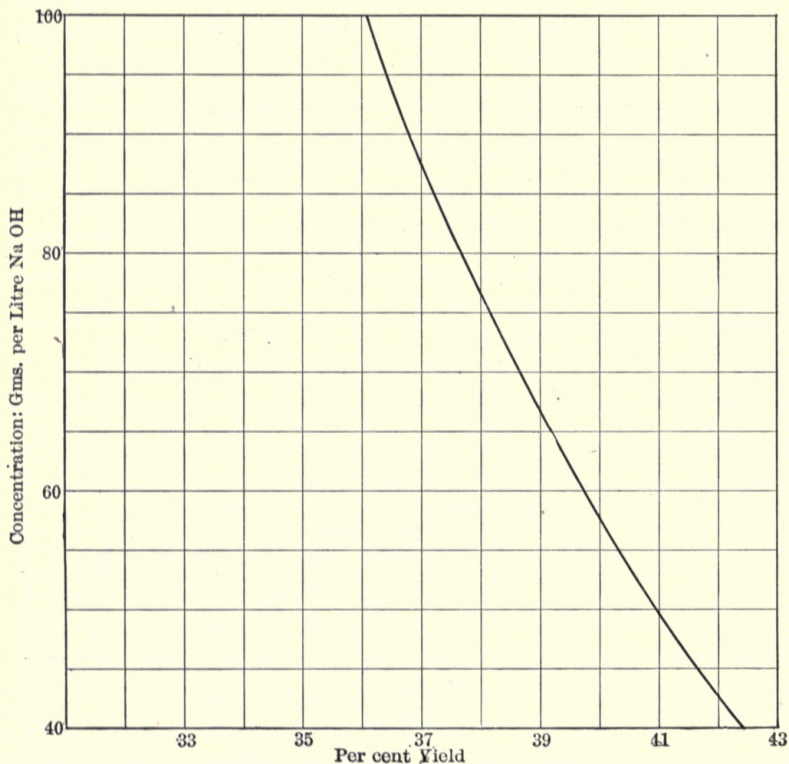

FIG. 11.

greater, which appears to be a characteristic difference between the vertical digester and the small rotary heated by a gas flame.

The influence of the initial concentration of caustic soda in the cooking liquor is shown in Fig. 11. Decreasing the concentration increases the yield slightly but this factor is evidently of less importance than the steam pressure since increasing

from 80 to 100 grams per liter reduces the yield only about 1.4 per cent.

Fig. 12 shows the variation in yield and bleach required with changes in the per cent of caustic soda added. With 22 per cent of caustic the yield was high but the fibre was unsatisfactory

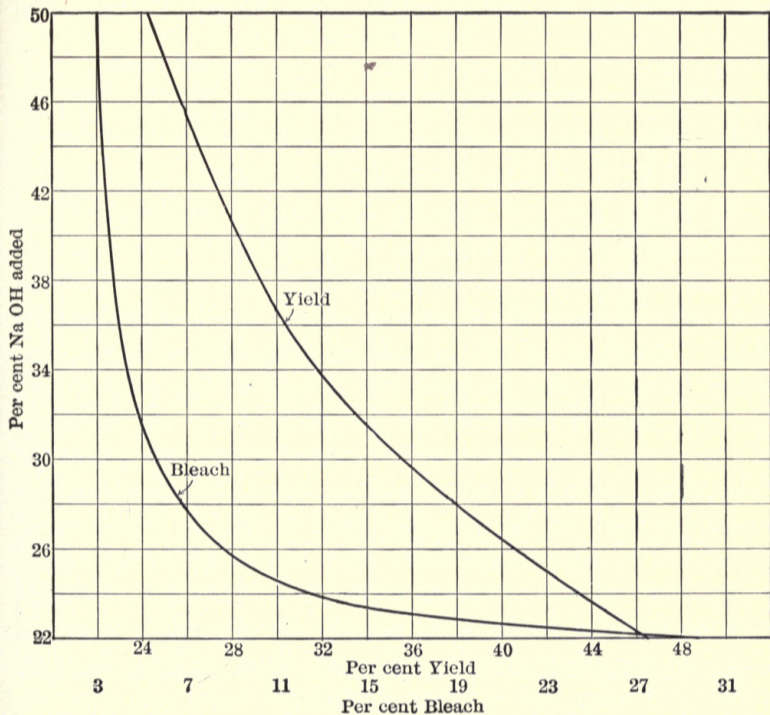

FIG. 12.

in that it was commercially unbleachable. Increasing the caustic to 28 per cent decreased the yield very greatly but produced easy bleaching fibre. When the caustic is brought up to 40 to 50 per cent of the weight of wood the form of curve suggests that its maximum cooking effect is nearly reached. This curve shows why 25 per cent of caustic soda is the most satisfactory for commercial work since if more is used the yield is too greatly reduced while if much less is employed the bleach required

increases to an excessive amount. Evidently the percentage of caustic soda is one of the most important points to watch in the control of the soda process.

The influence of time under pressure is shown in Fig. 13, where cooks ranging from three to nine hours are recorded. The rate of decrease in yield is not the same for equal intervals of

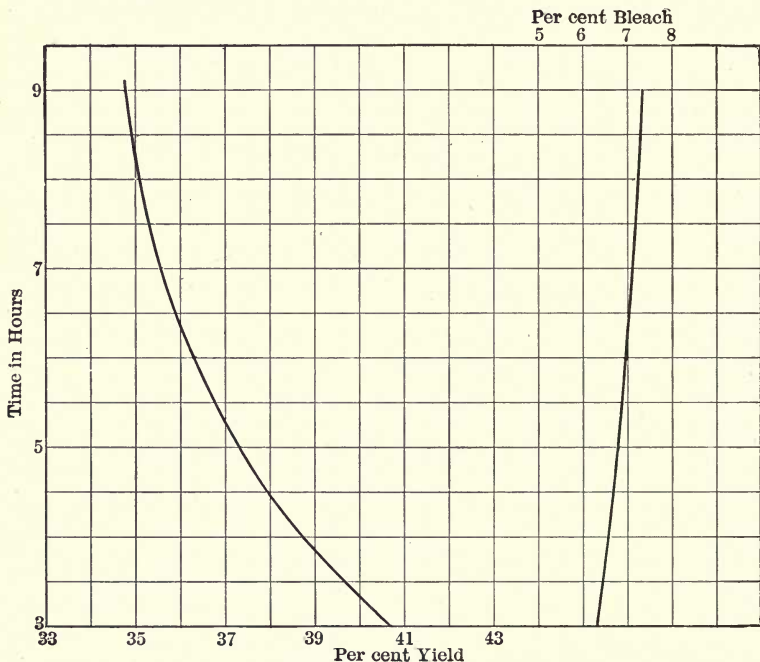

FIG. 13.

time for an increase from three to five hours causes a greater diminution in yield than an increase from seven to nine hours. Considering the questions of yield and bleach required the time factor is of much less importance than either the steam pressure or the amount of caustic added.

To bring these charts onto a common basis the table below has been calculated to show what changes in the variable cooking factors will cause a decrease of 1 per cent in the yield ob-

tained, considering in each case the entire range covered in the study of the particular variable. For comparison the results of experiments of the U. S. Forest Service ¹ are also given.

Decrease in yield of 1 per cent caused by	According to experiments by	
	The author	U. S. Forest Service
Increase of NaOH used by	1.3 per cent	2 per cent
Increase of time by	1.2 hours	1 hour
Increase of steam pressure by	5.0 lbs.	5 lbs.
Increase of concentration by	10.0 gms. per liter	13 gms. per liter

The condition of the wood, whether very wet or very dry, is of importance in adjusting the strength of the cooking liquor as already mentioned. The chief point to be watched is the final concentration of the caustic soda, taking into account the moisture in the wood as well as that in the liquor itself. Experiments have shown that if this ultimate concentration is kept constant the same yield will be obtained whether the chips contain 3 per cent or 22 per cent of moisture.

The causticity of the cooking liquor is another factor which is supposed to have a large influence on the cooking process. This is probably true in mills where the strength of the cooking liquor is regulated by the hydrometer test or by the titration for total alkali. If the volume to be added is based on either of these tests the actual caustic soda added may not be enough to cook the wood thoroughly and the low causticity will at once be blamed. As a matter of fact it makes no difference in the yield or bleaching properties of the fibre whether the causticity is 80 or 99 per cent provided liquor enough is present to supply the correct amount of actual caustic soda. This is also true of salt, which is sometimes present because of the use of electrolytic caustic, or may even be added intentionally with the idea of protecting the fibre and increasing the yield.

It is of course true that the causticity of the cooking liquor

¹ U. S. Dept. of Agriculture, Bulletin No. 80.

has a considerable effect upon the economy of the cooking and recovery processes since the carbonate is carried through the system as so much inert material which must be handled by the evaporators and black ash burners and is subjected to a loss of 10 to 20 per cent during each cycle. It has been estimated that in a plant making 70 tons of fibre per day, each increase of 1 per cent in causticity means an annual saving of about \$500.

In diluting the liquor to the proper strength for use it is the custom of some mills to add a certain proportion of black liquor. This is done with the idea of more completely utilizing the alkali in the black liquor and of obtaining a more concentrated liquor to go to the recovery system. As it is in direct line with the production of brown "kraft" fibre it is logical to expect that the bleaching properties of the fibre would suffer, and this has been found to be actually the case where black liquor has been added to the charge for cooking poplar. If 8 per cent of the total liquor consists of black liquor the bleach required is found to increase from 8.4 to 10.1 per cent, while if 17 per cent of black liquor is added the fibre requires 14.1 per cent of bleach. If no fresh liquor is used, but the entire charge is made up of black liquor brought to the correct strength by adding solid caustic soda, the fibre produced requires at least 22 per cent of bleach. While the bleaching properties of the fibre suffer, the yield of unbleached fibre is increased by about 3 to 4 per cent by the use of 8 to 17 per cent of black liquor.

The study of the time factor in cooking immediately brings up the question of how rapidly the reaction between the wood and the caustic soda takes place. Fortunately this reaction can be followed very readily by means of analyses of the black liquor. If the causticity of the liquor as added is known the consumption of caustic soda may be calculated at any time from the black liquor analysis by means of the following formula:

$$X = C - \frac{B \times C}{A},$$

where X = per cent NaOH used up, based on the bone dry wood,

A = per cent causticity at the start,

B = per cent causticity at time of sampling black liquor,

C = per cent NaOH added on bone dry wood.

Fig. 14 shows graphically the results of three such studies on poplar wood. Curve A was obtained from a vertical stationary digester holding 400 lbs. of wood, B is from a rotary digester holding about 3 cords, while C is from a vertical sta-

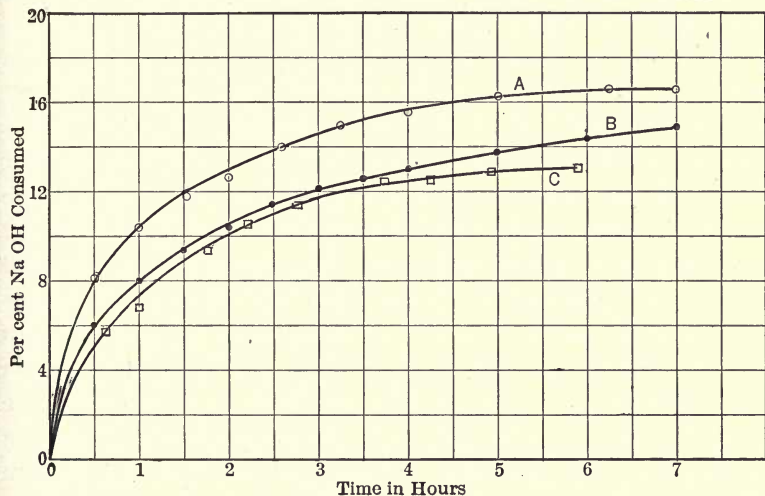

FIG. 14.

tionary digester of a capacity of 14.5 cords of wood. All three cooks were made at 110 lbs. steam pressure and the ratio of wood to alkali was the same for all. In each case the percentage of caustic soda consumed is based on the bone dry wood used. The weight of wood used in the largest digester was estimated from the average weight of a cord of poplar, but in the other two cooks the chips were accurately weighed; this may have introduced a slight error into curve C but this would merely alter its position on the chart and would not change its form.

These curves are characteristic of the soda process. The difference between small and large cooks is probably due to the difference in the speed with which they heat up, and in fact by forcing the steaming in the rotary digester it has been found possible to make the curve almost exactly duplicate curve *A* both in form and position. They also explain why the time factor is one of minor importance, for the reaction is one of such great rapidity that over half of the total alkali consumed in a seven-hour cook is used up during the first hour, in spite of the fact that during the whole, or a great part, of this time the charge is being brought up to full pressure.

Tests on Engelmann spruce and red alder have given results which practically duplicate the curves of Fig. 14, while Heuser¹ working on beech wood obtained very similar results. Christiansen,² on the other hand, claims to have established the fact that there are points at which the reaction ceases for a while and then begins again. These pauses are of different duration and take place sooner or later in the cook according to local conditions. Some of his cooks show two such pauses, some one and some not any, and a careful study of his work leads to the conclusion that they are probably due to inaccuracies in the methods which he used in sampling and analyzing the black liquors. It does not seem reasonable that the reaction should cease for a period of half an hour and then begin again and the author has been unable to find in the work on poplar any trace of such pause which was not readily explained by the difficulty of obtaining representative samples from the black liquor in the digester.

The methods of analysis used in determining the rate of reaction make possible also a study of the relationship between the caustic soda consumed and the yield of fibre produced. This was investigated by us and the results published³ in 1912 and from this paper the curves for spruce and poplar in Fig. 15 are repro-

¹ Heuser: *Wochbl. Papierfabr.*, **44**, 2209.

² Christiansen: *Über Natronzellstoff*.

³ *Communications: Eighth International Cong. of Appld. Chem.*, XIII, p. 265.

duced. It appears from this that up to the point where 14 per cent of caustic soda is consumed there is merely a softening of the chips and almost no separation into fibres; between 14 and 19.5 per cent consumption seems to be the critical stage, for between these points the transition from chips, through shives to commercially satisfactory fibre takes place. Beyond a consumption of 19 per cent the action appears to be almost en-

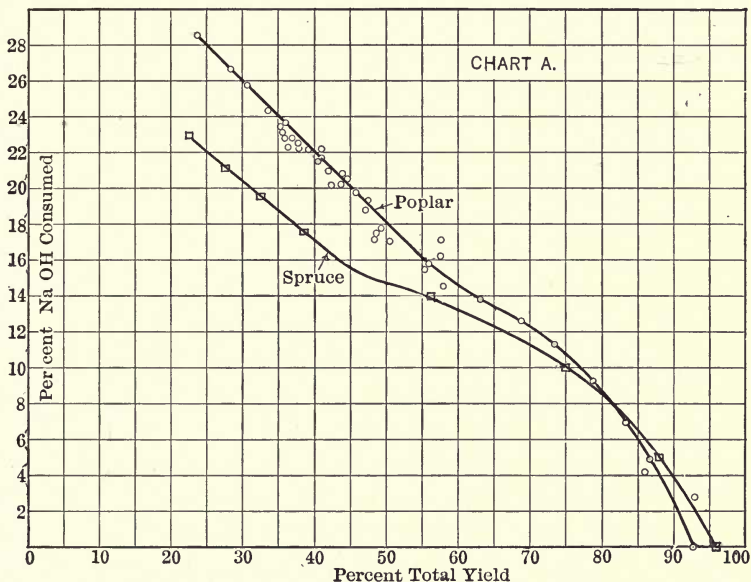

FIG. 15.

tirely a destruction of the cellulose and the decrease in yield bears a constant ratio to the increase in caustic consumption. The results from cooks of spruce chips give a very similar curve but the yield for a given consumption of caustic soda is considerably lower than for poplar as might be expected from a knowledge of the composition of the two woods. Studies along this same line by the U. S. Forest Service¹ gave results which seem to indicate that high consumption of caustic soda — 22

¹ U. S. Dept. of Agriculture, Bulletin No. 80.

per cent or more on the weight of the wood — may be obtained without much lowering of the yield. We believe that this difference may be due in small part to differences in the apparatus and wood used but that by far the greater part of it is caused by the analytical methods used by the Forest Service which take no account of the occlusion of caustic soda in the precipitate caused by barium chloride. It is highly probable that this method of investigation could be worked up into a good control test which would largely eliminate over- or under-cooked soda fibre and would tell with reasonable accuracy when the desired quality of fibre had been produced.

Actual mill results in the cooking of some Canadian woods are given by De Cew ¹ as follows:

Wood	Specific gravity	Weight per cord, lbs.	Soda as Na ₂ CO ₃	Yield	
				Per cent	Air dry fibre per cord, lbs.
Black spruce (<i>Picea nigra</i>).....	0.41	2250	900	40	1000
Hemlock (<i>Tsuga canadensis</i>).....	0.42	2300	950	38	970
Poplar (<i>P. grandidentata</i>).....	0.43	2350	800	44	1150
Bass (<i>Tilia americana</i>).....	0.425	2325	800	44	1135
Birch (<i>Betula alba</i>).....	0.58	3190	800	42	1490
Birch (<i>Betula lutea</i>).....	0.66	3630	850	40	1610
Maple (<i>Acer rubrum</i>).....	0.64	3520	850	40	1560

From other reliable sources the following data have been collected:

Wood used	Weight per cord bone dry	Alkali per cord as Na ₂ CO ₃	Yield air dry fibre per cord
White maple	2970	900	1520
White birch	3091-3218	1035-1120	1460-1592
Gum and poplar	3268	1022	1160
Poplar	2550	760	1250
Gum	2976-3040	920-1138	1215-1432

From soda mill records of the cords of wood cooked and the new soda ash added to replace losses it appears that 184 lbs. of

¹ De Cew: J. Soc. Chem. Ind., 1907, 561.

soda ash per cord suffices for poplar when the recovery is 76 per cent, or 153 lbs. with a recovery of 87.5 per cent. For a mixture of 60 per cent gum and 40 per cent poplar, used during a period of six months, 157 lbs. fresh soda ash per cord was found to be enough when the recovery was 85.7 per cent.

The best modern mills are able to cook deciduous woods in about four hours and coniferous woods in six hours. The success of these short cooks depends very largely on vigorous circulation and a rapid supply of steam. By removing air from the chips and using superheated steam quicker penetration of the liquor is obtained, which also hastens the cooking.

It has been proposed at various times to modify the regular soda process by the addition of small amounts of other chemicals such as salt, sodium nitrate, etc., and Schacht¹ even recommends cooking with a liquor consisting largely of sodium sulphite and thiosulphate and containing only enough caustic soda to dissolve silica and aluminates. Careful tests have failed to show that salt, even when used to the extent of 15 per cent of the weight of the wood, exerts any protective action and its presence does not appear to increase the yield. Another modification is that of Freeman who proposes to carry out the cooking in a reducing atmosphere obtained by passing hydrogen through the digester until all air is expelled. Still another variation consists in saturating the chips with cooking liquor under pressure, drawing off the excess and completing the cook by steaming as usual. This is claimed to give greater yield and better fibre because of the more uniform treatment of the chips.

The most recent proposal is to add a very small amount of sulphur — about 0.2 per cent on the weight of the wood — to the alkali during causticizing and it is claimed that this will materially increase the yield without causing a serious nuisance by its odor. Very careful small-scale tests of this modification have proved that woods vary in their response to the presence of

¹ Schacht: *Papier Ztg.*, 1901, 26, 3143.

sulphur; some give a larger yield while some do not, but in no case is the claim for 10 per cent greater yield justified. The fibre produced in the cooks containing sulphur bleaches more easily in every instance. The average yields for this series of tests are tabulated below:

Kind of wood	Percentage yield on bone dry basis	
	Without sulphur	With 0.2 per cent of sulphur
Poplar.....	38.9	41.9
Spruce.....	36.8	35.7
White birch.....	40.9	40.9
White maple.....	40.6	41.4
Tulip tree.....	41.7	42.6

It is evident that each kind of wood must be tested separately as the use of sulphur is not equally beneficial in all cases. It is probably due to this reason, as well as to the difficulty of determining yields in actual mill operations, that at least two mills where the use of sulphur has been tried out during a period of several months report that no increase in yield or other advantage can be noted and that it tends to produce bad odors even when used in such small amounts as 0.2 per cent on the weight of the wood.

Numerous other modifications of the soda process have been proposed from time to time, among which may be mentioned Drewsen's¹ plan for boiling wood chips in a liquor obtained by adding 10 per cent of quicklime and 2 to 4 per cent of sulphur to water; the fibre is finally boiled with sodium carbonate to remove all sulphur. Lee² proposes, in the case of flax waste, boiling in a 3 per cent solution of saccharate of lime. Burton³ combines a mechanical treatment with the soda process by cooking in drums furnished inside with loose rollers of steel or of steel filled with lead. This is somewhat similar to the Muntzing method of treatment⁴ in which the logs are placed

¹ U. S. Pat. 996,225, Jan. 27, 1911.

² U. S. Pat. 713, 116, Nov. 11, 1902.

³ Ger. Pat. 226,912, Apr. 1, 1909.

⁴ Paper, Jan. 20, 1915, p. 15.

in the rotary digester without chipping and by their rubbing action quickly separate the fibres. These are rapidly removed from the sphere of action of the liquor by pumping the latter through a filter press from which the clear liquor is returned to the digester to continue its work. Notably larger yields are claimed for this process.

In the case of woods rich in turpentine and rosin much study has been given to the possibility of recovering these, while at the same time utilizing the wood as a source of fibre. The turpentine can be obtained without difficulty in the blow-off from the digesters. By a partial cook, followed by a salting out of the liquor with more caustic soda, Bates¹ has shown that it is possible to recover much of the rosin in the form of sodium resinate. Similar investigations have been conducted by Veitch and Merrill² and the patents of Saylor,³ Aktchourine,⁴ and Williamson⁵ are based on practically the same principles. The importance of such problems is strongly emphasized by the estimate of the U. S. Government that there are 21,000,000 cords of waste resinous woods in the South annually.

The blow-off from the digesters also contains, besides turpentine, other materials of an easily volatile nature. From the relief of poplar cooks there have been condensed a small amount of oil and a liquid containing aldehydes, ketones, alcohol, acetone, etc. From small scale cooks Bergstrom has obtained the following yields of alcohol based on the dry wood used.

	Per cent
Fichte (<i>Picea excelsa</i>).....	0.67
Kiefer (<i>Pinus silvestris</i>).....	0.67
<i>Pinus palustris</i>	0.68
<i>Pinus echinata</i>	0.66
Aspen (<i>Populus tremuloides</i>).....	0.67
Birch (<i>Betula alba</i>).....	0.81
Gum (<i>Eucalyptus</i>).....	0.83

¹ Bates: Dissertation, Columbia University, 1914.

² Veitch and Merrill: Bureau of Chem., Bull. No. 159.

³ Saylor: Fr. Pat. 428,678, April 19, 1911.

⁴ Aktchourine: Fr. Pat. 433,424, Aug. 11, 1911.

⁵ Williamson: U. S. Pat. 1,025,356, May 7, 1912.

At the completion of a cook the contents of a rotary digester consists of material thoroughly reduced to the fibrous condition while that in the stationary digester still retains very largely the shape of the original chips. Rotary digesters are discharged by blowing off pressure until the heads can be re-

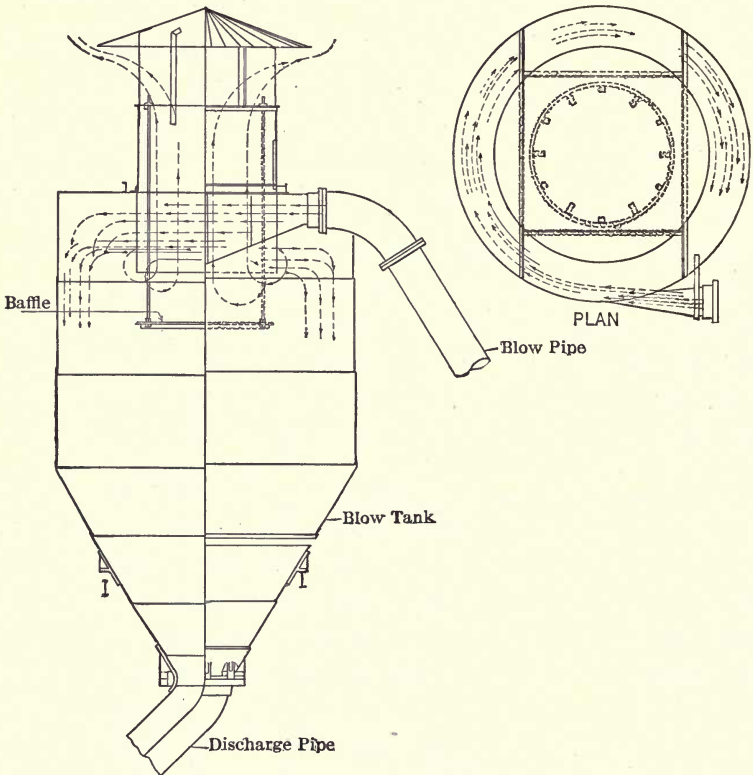

FIG. 16. BLOW TANK OR SEPARATOR

moved and then emptying the contents by revolving the digester. Vertical digesters are emptied by blowing the entire charge under full pressure through a pipe leading from the bottom of the digester to a blow pit or some form of steam separator. A very satisfactory device of this sort is shown in Fig. 16. The stock enters tangentially at such high speed that it hugs the

wall of the separator while the steam escapes to the center and out through the ventilator. On blowing the charge the sudden release of pressure causes violent evolution of steam from the moisture in the chips and this, together with the mechanical action of passing through the discharge pipe, causes complete disintegration into the fibrous state.

The blowing of a digester causes a very large waste of steam. It has been estimated that in blowing a 15.6-cord digester there escape into the atmosphere 34,400 lbs. of steam within a period of about 15 minutes. This represents about 41,200,000 British thermal units and at atmospheric pressure it would occupy a volume of 925,000 cu. ft. The cost of constructing an exchange heater which would handle this enormous volume of steam in such a short time has hitherto been considered prohibitive, and very few attempts have been made to stop this waste.

From the separator the stock drops by gravity to the wash pits. At this point it contains the fibre, all the alkali originally added, the organic matter dissolved during the cook and a large amount of water both from the liquor added and from the condensed steam. The composition of three samples taken during the entire time of discharge was found to be as follows:

	No. 1	No. 2	No. 3
	Per cent	Per cent	Per cent
Fibre (bone dry).....	11.38	8.15	7.32
Alkali as Na ₂ O.....	4.14	4.06	2.92
Organic matter and CO ₂	10.76	11.31	8.24
Water.....	73.72	76.48	81.51

The wash pits are iron tanks with perforated false bottoms; they are of various sizes and shapes but each should be of sufficient capacity to hold the entire charge of a digester with room above the stock to allow for flooding with water. The pits supplied in one mill for digesters of about 15 cords capacity are 19 ft. 6 ins. in diameter by about 13 ft. deep above the false bottom which has a 2-in. pitch toward the central outlet to aid in washing out the stock. One digester charge fills

one of these wash pits to a depth of about 9 to 10 ft. when leveled off. In another mill rectangular tanks are recommended, the size for 5200 to 5300 lbs. of pulp being $18 \times 16 \times 5$ ft. deep.

The charge is washed first by flooding with weak liquor from a previous wash; the liquor taken off during this period goes to the recovery plant. The next washing is with hot water, which produces the weak liquor used in the first flooding of a subsequent cook, and the final washing is with hot water which runs to the sewer as it is too weak to pay for evaporation. The approximate washing data for the 19½-ft. tanks mentioned above are as follows:

	First wash	Second wash	Third wash
Time of washing, hours.	4-7	5-8	2-3
Volume of liquor taken off, gals.	18,000-19,000	19,000-20,000
Baumé at end.	5° at 70° C.	0° at 50° C.

The net total washing time is thus eleven to eighteen hours per charge and the recovery of soda during the washing has been found to be about 98.5 per cent. The strong black liquor obtained by this method contains about 0.63 to 0.65 lb. of soda per gallon.

In some mills the weak liquor is collected in a tank before being pumped on to the next pit, while in other mills using the so-called "cycle system" it is pumped directly from one wash pit to another. The advantage of the cycle system is that it requires less space and produces stronger liquor, while its chief disadvantages are that it requires more time to complete a wash and it is often necessary to hold a pit with the black liquor on it to the detriment of its bleaching properties. Spence¹ states that with hardwoods the liquor discharged from the digesters tests 12° Bé. at 60° F., while that going to the evaporators tests 9° Bé. If the cycle system is used the liquor to the

¹ Spence: Paper, 25 (1919), 134.

evaporators would test $10\frac{1}{4}^{\circ}$ Bé. instead of 9 degs., this difference being equivalent to a saving in evaporation of 46,000 gals. per day for a plant with a daily capacity of 100 tons of pulp.

The washing time depends very largely on the depth of stock which the wash water has to penetrate. By dividing the digester charge between two wash pits the time of washing can be very greatly reduced, but a weaker liquor is obtained and the recovery is not so complete unless a much larger volume of liquor is collected. This is equivalent to saying that the greater the drainage area allowed per ton of fibre per day the more rapid will be the washing. Beveridge¹ mentions installations where this has varied from $7\frac{1}{2}$ to $10\frac{4}{10}$ sq. ft. but considers this far too little and recommends 35 sq. ft. for poplar and 45 to 50 for chestnut. The kind of wood used and the nature of the cook have an influence on the speed of draining; hardwoods drain slower than northern poplar and overcooking causes the fibre to be sufficiently gelatinous to drain slower than a normal cook.

The temperature of the water used also influences the speed of washing, hot water penetrating the stock very much faster than cold. Cold water, however, if given time enough, will remove impurities as completely as hot, the bleach required by the fibre being practically the same in both cases. If the fibre stands for any appreciable time in contact with the black liquor it appears to absorb coloring matter from the latter and becomes very hard to bleach. This is particularly true where the mixture of fibre and black liquor becomes cold, twenty-four hours' contact under such conditions being enough to increase the bleach required from 9 to 14 to 15 per cent. On general principles the stock should be washed as soon as possible after discharging from the digester and access of air or cooling of the stock should be avoided as far as can be done conveniently. It is particularly important that the last traces of black liquor

¹ Beveridge: Paper, 25 (1919), 198.

be removed before the stock reaches the bleaching system since even a very small amount renders bleaching quite difficult.

The results obtained in any washing system depend on the judgment of the workmen and upon the care which they use. Frequent tests are necessary and the accuracy of the hydrometer and the temperature at which it is used should be carefully looked to. A device which shows the progress of the washing by the color of the liquor can be installed at little expense by passing a small stream of the liquor continuously through a glass U-tube beside which is a gauge glass of the same diameter and color. The gauge is filled with black liquor of the minimum strength which it is desired to collect as strong or weak liquor, as the case may be, and when the color of the washings is the same as the standard the collection of washings of that grade is discontinued.

After washing the treatment of the pulp is largely mechanical until it reaches the bleaching system. It is sluiced out of the wash pits by a heavy stream of water and run through screens to remove shives, uncooked pieces, or knots. It goes next, while in a highly diluted condition, over sand settlers which are long, shallow troughs with crossbars at intervals in the bottom, and in which sand, dirt, cinders, shives and other impurities settle out. From the sand settlers it goes to a series of extractors which remove a large part of the water and deliver the pulp at a proper concentration for bleaching. During these processes the amount of water present per pound of bone dry fibre has been found to be about as follows:

	Lbs.
In wash pits	3.5
At knotters	87.7
At centrifugal screens and sand settlers	123-135
Entering bleaching system	24.5-27

Leaks and mechanical losses of fibre should be carefully looked for throughout this process. With extractors of a type similar to the washers used on beating engines such losses should not amount to more than 1 to 1.5 per cent of the total

fibre and the material lost will be found to consist largely of short fibres or broken fragments.

The pulp produced by the soda process from poplar will bleach to a good white color with 8 to 12 per cent of bleach, while that from coniferous woods requires a considerably greater amount. In some cases it is not possible to reach a high white color without a treatment so drastic as to seriously weaken the cellulose itself. For this reason much of the soda pulp from coniferous woods is used in grades of paper which do not require a very white fibre.

Black Liquor. It is claimed by Griffin¹ that the liquor in the digester at the end of the cook is light rose in color but that it immediately darkens on exposure to air. However this may be, the mass by the time it reaches the wash pits is a rich dark brown in color. This is due to the liquor and not to the fibre itself which when washed is of a light grayish brown shade.

The black liquor removed from the fibre during the washing contains nearly all the alkali originally employed, together with over half the weight of the wood used. Griffin² gives the following analytical data for black liquor derived from a soda cook of poplar wood, all figures being based on the weight of total solids dried at 100° C.

	Per cent
Silica (SiO ₂).....	0.11
Oxides of iron and alumina (Fe ₂ O ₃ and Al ₂ O ₃).....	0.02
Lime (CaO).....	0.05
Potash (K ₂ O).....	0.69
Soda (Na ₂ O).....	25.69
Carbon dioxide (CO ₂).....	3.43
Acetic acid.....	9.89
Organic matter extracted by naphtha boiling below 60° C.....	1.56
Organic matter extracted by ether.....	7.14
Organic matter extracted by absolute alcohol.....	28.26
Organic matter extracted by water.....	17.02
Total alkali by titration of incinerated residue.....	44.25

¹ J. Am. Chem. Soc., 1902, 24, 235-238.

² *Ibid.*

Other analyses of black liquor from poplar showed the presence of total alkali equivalent to 65.5 grams per liter of sodium carbonate. Of this total alkali

- 25.8 per cent was combined as acetate
- 8.0 per cent was combined as carbonate
- 13.3 per cent was combined as hydroxide
- 13.5 per cent was combined with insoluble organic acids
- 39.4 per cent was combined with soluble organic acids.

The proportion of caustic soda here present is much less than that necessary according to Klason¹ who states that 40 per cent of the total alkali must remain unused in the black liquor and that even if the wood is present in great excess at least 25 per cent of the original alkali will be found unconsumed. Even the difference between poplar and spruce seems hardly great enough to account for such differences as these. Moreover it has been proved that if less than 9 per cent of caustic soda is employed the wood uses it up completely, none being present in the black liquor. Even when 18 per cent on the weight of the wood is added fully 90 per cent of it is consumed and that remaining in the liquor is reduced to a strength of only about 1.4 grams per liter. Even under actual working conditions the proportion of caustic remaining unused is much less than that claimed by Klason, as the following analyses of black liquors from various woods will show:

Kind of wood	Black liquor		Caustic remaining. Per cent on bone dry wood
	Grams per liter NaOH	Per cent causticity	
White maple	13.1-14.3	21.1-21.4	5.0- 5.1
White birch	8.7-21.5	12.2-28.8	2.9- 7.7
Black gum	20.2-22.1	33.3-35.6	9.8-10.4
Beech	10.6-17.6	18.5-21.3	4.6- 4.8
Poplar	6.4-18.1	15.3-29.1	3.5- 8.0

According to Griffin and Little² sodium formate, oxalate and acetate together with dark colored products similar to ulmic

¹ Christiansen: Natronzellstoff, p. 51.

² Griffin and Little: Chemistry of Paper Making, p. 164 (1894).

acid have been recognized in the black liquor. Higgins¹ patented in 1891 a method for preparing acetates from black liquor by charring at not over 350 degs., but the process has never been practically adopted.

Among other processes for treating black liquor, Rinman² proposes to precipitate the humus substances with carbonic acid in the presence of salt and after drying the precipitate distilling it destructively to obtain acetone, alcohol, etc. Tests by the author on liquor from poplar wood show that only 9.2 per cent of the total organic matter present can be precipitated by carbonic acid and that after very slight washing this precipitate is again readily dissolved by hot water. Veitch and Merrill³ working with a black liquor from Southern pine which contained 11.1 per cent of organic matter in solution found that 4.9 per cent was precipitated by carbon dioxide and a further 1.2 per cent by acetic acid. Evidently the kind of wood used very greatly influences the amount of precipitate obtainable by means of carbon dioxide.

The problem of the commercial utilization of black liquor is a very attractive one and many attempts have been made to obtain from it useful by-products. The humic matter precipitated from it by acids can be used as a sizing agent for paper but the pinkish color which it imparts limits its use to colored papers. It has been proposed to make a stain for wood from this organic matter and it can also be utilized in the manufacture of brown sulphur dyes or nitrated to form brown to yellow dyes. None of these uses would make much of an impression on the vast quantities produced annually and in all of them the recovery value of the soda would be lost in the process of precipitating the organic matter. A more rational plan would be the destructive distillation of the black liquor in such a way that the volatile oils and other materials could be collected while the residual matter would still contain all the soda

¹ Higgins: Eng. Pat. 13,409, 1891.

² Rinman: Soda Recovery; Papier Ztg., 1911, 3489.

³ U. S. Dept. of Agriculture, Bureau of Chem., Bull. No. 159 (1913).

in available form for reuse. The products obtained from such a treatment are non-condensable gases, methyl alcohol, acetone, aldehydes, amines, phenolic oils, tar and the retort residue containing the alkali and carbon. Adding lime to the charge before distilling increases the amount of acetone in the distillate while if no alkali is added the methyl alcohol is present in much the greater amount.

Recovery of Soda. The regeneration of the soda was not attempted in the early days of the process but it was soon rendered necessary by the difficulty in disposing of large quantities of the waste liquors and by the expense of repeatedly replacing the entire amount of alkali. The character of the waste is such as to render recovery especially easy from a chemical standpoint, for about one-half of the fuel value of the wood is present in the liquor and it is in such form that its combustion furnishes a large part of the heat necessary to evaporate the liquors to the point where they may be ignited. After burning the soda remains as carbonate in the black ash. While the process of recovery is comparatively simple, the necessary equipment is the most expensive part of the soda mill and its efficiency has an important bearing on the cost of production.

According to Griffin and Little¹ the mixture of waste liquor and washings to be treated usually tests from 6° to 9° Bé. at 160° F. and in order to maintain continuous combustion it is necessary to concentrate to at least 30° Bé. at 130° F., and still better to bring it up to 40° Bé., or higher. Of the very large amount of water which it is necessary to evaporate during this process, part comes from the moisture in the chips and from the liquor originally added, part from the water used in washing and part from the steam condensed during the cooking. This latter item is greater during cold weather and would be somewhat less for stationary digesters because of the better heat insulation in this type of apparatus.

Recent examinations of black liquor from poplar wood produced the following data.

¹ Griffin and Little: Chemistry of Paper Making, p. 164 (1894).

Degrees Bé. at room temperature	Grams dry matter per 100 grams liquor	Boiling points in degrees C. at *				
		41 inches pressure	20 inches pressure	0 inches pressure	10 inches vacuum	25 inches vacuum
7	7.8	124.5	114.3	101	90.5	58.5
16	18.5
22	27.1	128.0	117.5	104	93.0	62.0
27	36.6
32	46.8
37	57.6	135.5	124.7	112	100.9	69.0

* Records for pressure and vacuum are in inches of mercury.

The proportions of organic and inorganic constituents in 'black liquor are indicated in the following analyses which were made on an average sample of the liquor first draining away from the stock; this liquor tested $12\frac{3}{4}$ ° Bé. at 70° F.

	Grams per liter	Per cent by weight	Per cent on total solids
Total solids	180.2	16.4
Water	917.3	83.6
Caustic soda	19.5	1.8	10.8
Total alkali as Na ₂ O	49.9	4.5	27.7
Organic matter precipitated by H ₂ SO ₄	27.3	2.6	15.2

In practice the evaporation of black liquor is performed either in open pans or vacuum apparatus. The Porion evaporator, which is representative of the first class, consists of a brick chamber, the lower part of which forms a shallow reservoir, and through which pass two cross shafts driven from the outside. These two shafts carry a series of paddles which when revolved at high speed throw the liquor into the upper part of the chamber in the form of a fine spray. At one end of this chamber is the calcining furnace where the final concentration and incineration of the black liquor take place. The burning is assisted by a coal fire at one end of this furnace and all products of combustion pass through the evaporating chamber on their way to the chimney, thus heating and evaporating the liquor and being themselves cooled in the process to 85° C. or

even lower. When the liquor in the chamber has reached a density of 26° to 29° Bé. it is removed to a storage tank over the calcining furnace from which it is gradually fed into the latter. This evaporator costs comparatively little for erection and operation and it is claimed will yield three-quarters of a ton of ash per ton of coal.

Enderlein's evaporator is similar in principle but the arms which produce the spray are replaced with wrought iron discs about six inches apart which revolve partly in the liquor and thus carry a thin film of liquid up into the gases which are obliged to pass between the discs before reaching the chimney. According to Beveridge¹ the fuel economy of this apparatus is nearly as good as that of multiple effect evaporators.

The vacuum or multiple effect evaporators depend on the fact that the boiling point of water, or other liquid, is lowered by reducing the pressure under which it boils. The boiling temperatures for black liquor already given in the accompanying table illustrate this, and these will be found to follow very closely the boiling points of water under similar conditions. Apparatus working on this principle is so constructed that the steam from the liquid evaporated in the first section, or "effect," is used to boil that in the second effect, this being kept under enough lower pressure so that active ebullition takes place. The steam from the second effect in turn boils the liquor in the third effect and so on through the system which may consist of three to five effects. The only necessity for heat from outside sources is therefore in the first effect in which the liquor is raised from the entering temperature to the temperature of ebullition at the pressure in this effect. The pressure in the first effect varies greatly in different mills and with different types of apparatus.

One of the evaporators most frequently used in soda pulp mills is the Yaryan in which the liquor passes back and forth through the tubes and finally is discharged against baffle plates in a separating chamber. The tubes are 3 ins. in diameter

¹ Beveridge: Paper Makers' Pocket Book, p. 106.

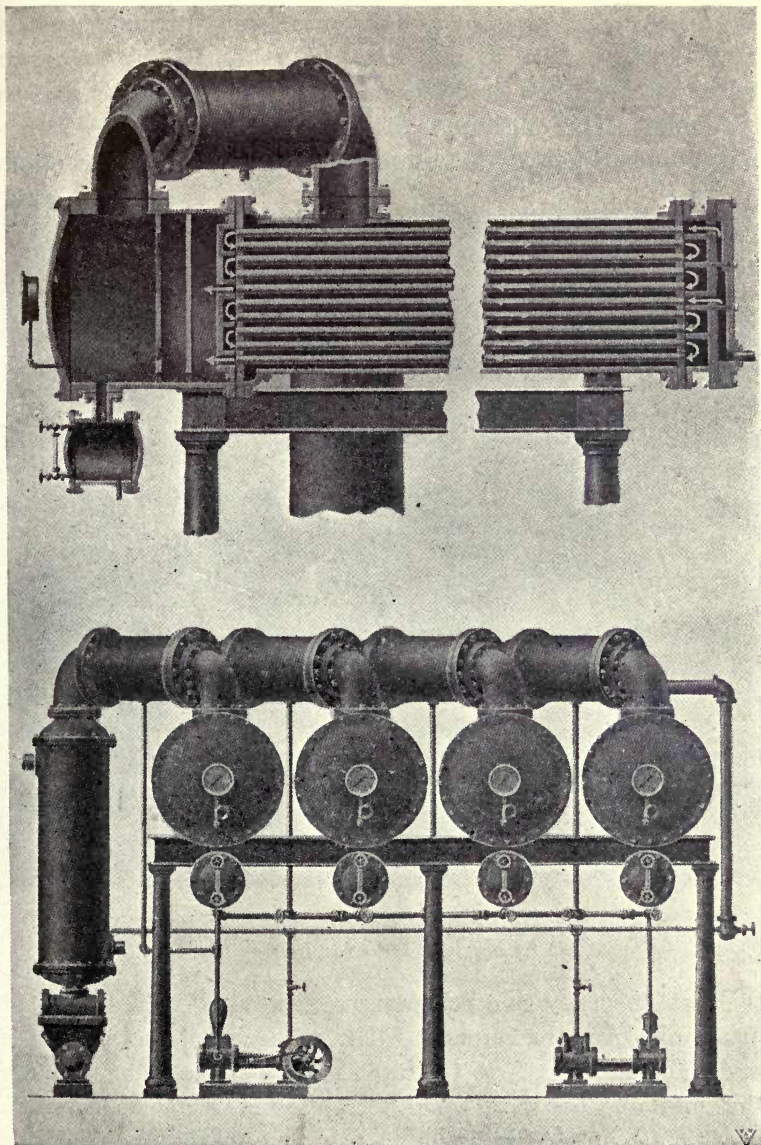

FIG. 17. YARYAN EVAPORATOR
Courtesy of Mr. Chas. Ordway

and 12 ft. long and as five tubes form a unit the liquor travels 60 ft. before it is discharged. From this chamber the steam passes into the shell of the next effect while the liquor goes to the tubes. The vacuum is maintained by means of a condenser and pump and the strong black liquor is removed from

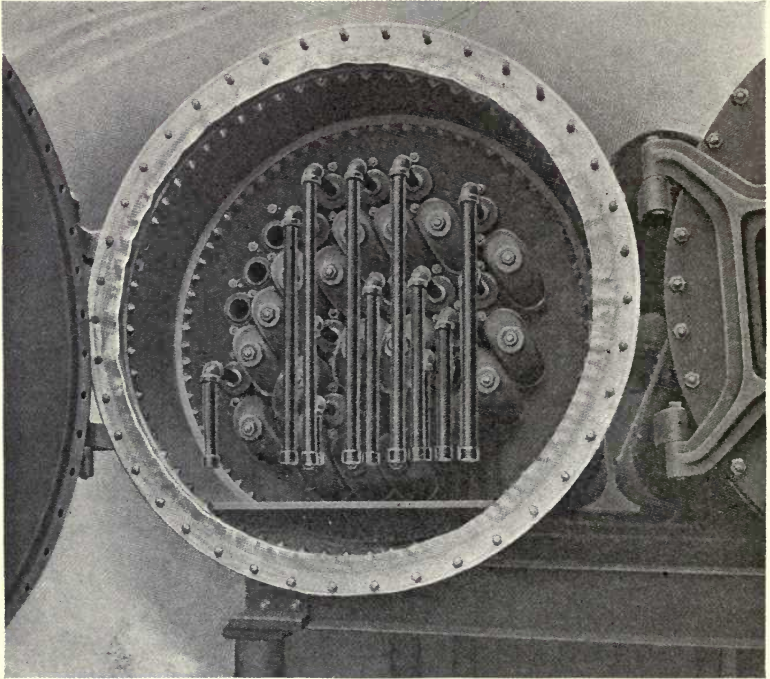

FIG. 18. YARYAN EVAPORATOR FEED END OF ONE EFFECT
Courtesy of Mr. Chas. Ordway

the last effect by another pump which usually discharges it into tanks over the furnaces. The efficiency of the Yaryan is said to be due in part to the rapid motion of the liquor through the tubes and the more rapid absorption of heat which results. The time required for liquor to pass through all the effects is but a few minutes, and as only a small amount of liquor is present at any one time the evaporator can be started and stopped very quickly.

Several types of Yaryan evaporators are on the market. Fig. 17 shows a horizontal evaporator in general view and a section of one effect, while Fig. 18 shows the feed pipes and the return bends of part of the coils. It is to be noted that uniform feed for all coils is insured by bringing the feed pipes all down to one level.

In other types of multiple evaporators the positions of the steam and liquor are reversed, the steam being in the tubes

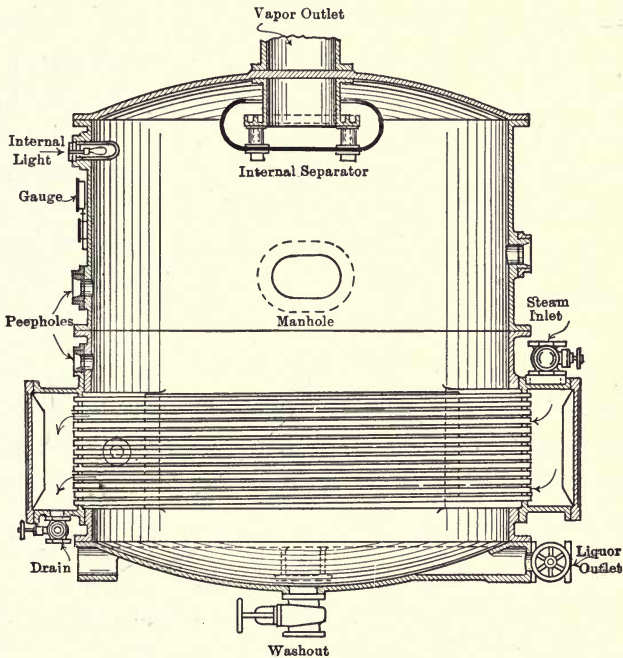

FIG. 19. ZAREMBO EVAPORATOR VERTICAL CROSS SECTION OF ONE EFFECT
Courtesy of Zarembo Company

while the liquor to be concentrated flows over them by gravity in a thin film. The Zarembo evaporator, a cross section of one effect of which is shown in Fig. 19, is of this type. This evaporator is giving good service on black liquor and in one installation a four-effect evaporator with bodies 14 ft. in diameter is handling 350,000 gals. daily.

Numerous tests on both types of evaporators have proved that an evaporation of 3 to $3\frac{1}{2}$ lbs. of water from and at 212° F. can be maintained under ordinary working conditions, while if the heat necessary to bring the liquor to the boiling point is considered the evaporation would be somewhat less, say 2.6 to 2.9 lbs. of water per pound of steam. Assuming an evaporation of $8\frac{1}{2}$ lbs. of water per pound of coal under the boilers the patentees of the Yaryan evaporator claim that a double effect will evaporate 16 lbs., a triple effect $23\frac{1}{2}$ lbs. and a quadruple effect $30\frac{1}{2}$ lbs. of water per pound of coal. Tests under ordinary running conditions have shown an evaporation, for a three-effect Yaryan, of 18 to 20 lbs. of water per pound of coal on the above assumption.

After evaporation the liquor goes to a storage tank and thence to the incinerating furnace. This furnace consists of a revolving, cylindrical shell lined in such a way that the interior is somewhat conical with the large end toward the fire box. Modern furnaces are quite generally about 20 ft. long and 9 ft. outside diameter, but some are built as much as 30 ft. long. The lining is of ordinary hard-burned red brick and is about 15 ins. thick at one end and 9 at the other. The placing of pieces of cast iron at intervals helps to resist wear; the links of old chain grates placed edgewise have proved very good for this purpose. The furnace is mounted on wheels and fitted with a gear by which it is caused to turn at a speed of one to three revolutions per minute according to the condition of the liquor supply.

At the discharge end of the furnace there is a fire box, mounted on wheels which rest upon rails so that the whole can be drawn back out of the way when the furnace proper needs repairs. This fire box is arranged to burn coal, wood waste, gas or oil according to local conditions. It is usually impossible to get a very accurate estimate of the fuel burned per ton of ash because the use of waste material is so general. In one mill where both wood and coal were burned the amount of the latter was only 120 lbs. per ton of ash produced. During a test on a 20-ft. furnace burning all coal with a moisture content of 2.33

per cent, and running liquor at 38° Bé., the coal burned per ton of ash produced was 117 lbs., while under similar conditions 325 lbs. of shavings with a moisture content of 39 per cent were required.

Fig. 20 shows diagrammatically the arrangement of a modern recovery plant with its rotary furnace, fire box and boiler setting for the recovery of waste heat from the incinerator. Such a boiler will produce a very considerable part of the steam necessary for the evaporation of the black liquor. In one plant the boiler over a furnace burning 21 tons of ash per day developed 150 to 160 horse power when it was in good condition.

The strong black liquor which enters the back end of the furnace is not yet concentrated enough to support its own combustion. As it works forward in the furnace it loses water and finally takes fire, the organic compounds are destroyed and it is finally discharged in a glowing condition containing practically only carbon and sodium carbonate. If it is well burned there is at most a slight blue flame to the discharged ash, but if the furnace is pushed a little too hard the ash may be under-burned in which case it may show considerable yellow flame even after it is dumped into the leaching tanks. Under ordinary conditions a 20-ft. furnace operated by experienced men will produce 30 to 33 tons of ash in twenty-four hours and under exceptionally favorable conditions the product may go as high as 42 to 43 tons. The lining of such a furnace will not last much over six months and if it is pushed harder than it should be it will need repairs rather sooner.

The recovered ash in the soda process will contain 65 to 80 per cent of sodium carbonate according to the care with which it has been burned. There are small amounts of iron, alumina, lime, sulphur and silica derived from various sources and about 18 to 22 per cent of carbon.

From the furnaces the ash goes to some form of leaching device, either open tanks or closed tanks to which pressure can be applied. In the open tanks it is first flooded with weak liquor from below in order to avoid causing explosions when

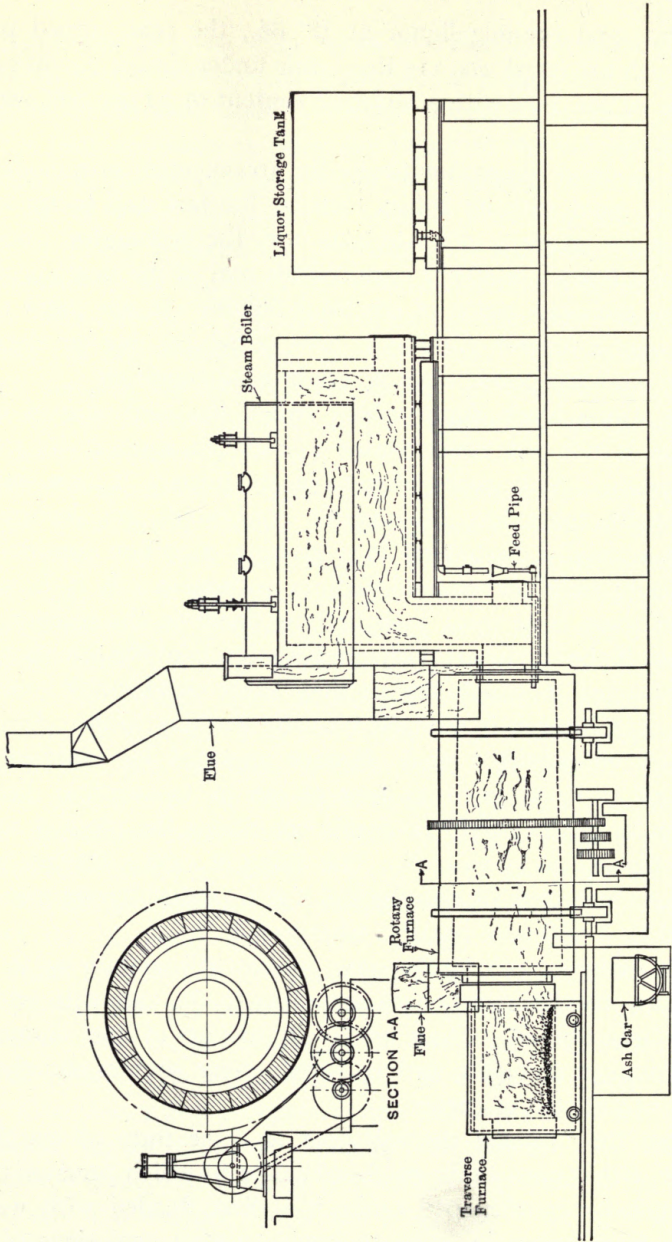

FIG. 20. SODA RECOVERY OR BLACK ASH FURNACE

water comes in contact with the glowing ash. The washing is carried out systematically in order to produce a leach liquor of good strength and at the same time lose as little soda as possible. The closed tank system saves floor space and time in leaching but much care is necessary in order to avoid explosions. There seems to be little to choose between the two systems so far as operating efficiency is concerned.

Black Ash Waste. This material, which remains in the leaching tanks at the end of the washing, consists of light porous carbon contaminated with small amounts of impurities. Because of its physical condition it is very difficult to remove the water it contains. When drained as much as possible in the leach tanks it still contains 80 to 85 per cent of water, even in the top layers which are driest. The use of a centrifugal machine will not reduce this moisture below 65 to 68 per cent and beyond this point it can be dried only by the application of heat.

The following analysis gives an idea of the composition of this waste. The sample had been thoroughly dried and then exposed to the air.

	Per cent
Moisture, H ₂ O.....	6.06
Sodium carbonate, Na ₂ CO ₃	2.51
Calcium carbonate, CaCO ₃	1.17
Sodium sulphide, Na ₂ S.....	0.37
Magnesia, MgO.....	0.34
Iron and alumina, Fe ₂ O ₃ and Al ₂ O ₃	0.26
Silica, SiO ₂	0.17
Calcium sulphate, CaSO ₄	0.07
Carbon by difference, C.....	89.05

No use for this material, which will even begin to take care of the amount made, has ever been developed. The most promising field seems to be as a fuel, since the heating value of the dried waste is 14,000 to 14,500 B.T.U.

Losses. The chief loss to which attention should be paid is that of soda. This occurs at numerous points, all of which should be subjected to careful scrutiny.

The loss in the lime mud should be checked by routine analyses. These will indicate whether the process is being run care-

fully and may prove that a different lime can be used which will permit better settling and cleaner washing. The loss in the waste lime sludge will be about 2.0 per cent of its dry weight under average conditions.

The loss in washing out the black liquor from the fibre may be studied by analyses and volume measurements of the final washings. Such studies indicate that under normal conditions this loss will amount to 1 to 1.5 per cent of the total soda used in the digesters. There is also a loss due to the presence of a small amount of soda in the washed fibre; this has been found to be about 1.5 per cent of the soda used. Under abnormal conditions, as when the recovery plant cannot keep up with the wash pits, there is likely to be a much greater loss in the final wash water.

The losses in burning the black ash are hard to determine because the process is a continuous one and reliable measurements of the materials going to and coming from the furnaces are seldom made. Moreover the loss is chiefly in material carried up the stack mechanically or because of a slight volatilization of soda. Spence¹ has studied the loss up the flues and gives the soda lost per twenty-four hours as follows for different sizes of incinerators.

	Lbs.
14-foot rotaries.	450-1000
16-foot rotaries.	650-1300
30-foot rotaries.	2500-4000

In the leaching of the black ash there is a loss of soda which may run from a few tenths of a per cent up to four or five per cent for unsatisfactory conditions. While it would seem an easy matter to determine this loss it has proved to be a very difficult proposition because the nature of the material and the way it is handled make it almost impossible to obtain a fair sample.

Tests and Analyses for the Soda Process. The analytical work necessary for the control of the soda process is of a comparatively simple nature. The materials which should be tested

¹ Spence: Paper, 1919, 619.

either regularly or at intervals are the cooking liquor and black liquor, soda ash, lime, lime mud, black ash and black ash waste. The cooking liquor contains caustic soda as the essential ingredient, but it also contains soda ash and in some cases salt, which renders its valuation by a simple hydrometer test somewhat misleading. The actual grams per liter of caustic soda should be determined by titrating 10 c.c. with normal acid using first phenolphthalein and finally methyl orange as indicator. The methyl orange shows the total alkali while the phenolphthalein shows all the caustic soda and half the carbonate. Twice the difference between the two, subtracted from the methyl orange reading, gives the acid to neutralize the caustic soda and this multiplied by 4 gives the grams per liter of NaOH. The causticity of the cooking liquor should also be recorded; this is obtained by dividing the cubic centimeters of acid required for the caustic soda by the volume necessary for the total alkali. Probably most practical mill men would say that the Baumé test is the only one necessary but for the reasons given above this test alone may lead to entirely incorrect conclusions.

Soda ash is ordinarily one of the purest of commercial chemicals yet it is desirable to test it occasionally when received and if it is stored in bulk it is sometimes necessary to determine the amount of moisture which it has taken up. For moisture a representative sample of 1 to 2 grams is accurately weighed into a platinum crucible and dried for three-quarters of an hour over a gas flame which is so adjusted that the bottom of the crucible just shows a faint redness when shielded from strong light. After cooling in a desiccator it is quickly reweighed, the loss being calculated as percentage of moisture. For the determination of alkali present the dried sample is dissolved in water and titrated with normal acid using methyl orange as indicator. The percentage of sodium carbonate in the original sample is calculated by the following formula

$$\frac{\text{C. C. acid} \times 0.053}{\text{Weight of sample before drying}} .$$

The lime used in causticizing should be regularly tested in order to see that its quality is kept up to a reasonable standard. A chemical analysis will not necessarily show what results it will give in practice but a simple causticizing test made under conditions similar to those of actual work will give very valuable information. From each car of lime received as fair a sample as possible should be taken by going all over the car and taking portions from the top, middle and bottom of the load. This should be selected to represent both the fine and the coarse material and as soon as the entire sample is taken it should be crushed and quartered down as rapidly as possible to avoid the absorption of moisture. From this final sample a weighed amount is taken and boiled for exactly one hour with water and a weighed amount of dry soda ash which is in excess of the amount the lime can causticize. The amount of water used is so taken that the final solution at the end of the test is about the strength of that used in practice. After the boiling is completed the sludge is allowed to settle and the clear liquor is titrated with both phenolphthalein and methyl orange as in the case of cooking liquor. Knowing the causticity from this titration and the weight of soda ash taken the amount of lime required to causticize 100 lbs. of dry soda ash may be calculated by this formula:

$$\frac{\text{Weight of lime used} \times 100}{\text{Per cent causticity} \times \text{weight of soda ash used}}$$

The settling quality of the lime may be ascertained in this same test by taking a sample of the rapidly boiling mixture just at the end of the test and, without giving it time to settle, filling a 100 c.c. graduate just to the upper mark. By noting the cubic centimeters of clear liquor at fixed time intervals the relative settling qualities of the various limes can be compared.

The lime mud which settles in the causticizing and washing tanks is generally a waste product and in order to see that too much caustic soda is not thrown away it should be tested at intervals for the amount of alkali present. A representative sample of the dried mud is weighed out, placed in a small por-

celain dish and moistened with strong ammonium carbonate solution. It is next evaporated to dryness, heated over a low flame until no odor of ammonia can be noticed, and finally leached out repeatedly with boiling distilled water until all the soluble alkali is removed. The combined leachings are then titrated with standard acid, using methyl orange as indicator, and the results calculated to percentage of alkali based on the dry lime mud.

In the case of black liquor it is at times desirable to know the strength both in total alkali and in free caustic soda. For total alkali evaporate a measured volume to dryness in a platinum dish and ignite over a flame till the organic matter is completely carbonized. Cool, extract several times with hot water and pour the extracts through a small platinum cone. Put the cone in the dish together with the residual wet carbon, cover with a filter paper which just fits inside the dish and quickly ignite over a gas flame. The filter paper prevents loss by spattering and enables the carbon to be burned off without waiting for it to be dried first. Again cool and extract with hot water, add the extract to the first and titrate with acid in the presence of methyl orange. Calculate the results to grams of sodium carbonate per liter or pounds per gallon.

For the determination of free caustic soda in black liquor add 25 c.c. of the latter to 400 c.c. of water and 15 c.c. of barium chloride solution (400 grams per liter) in a beaker. Titrate directly with standard acid using a dilute solution of phenolphthalein on a spot plate as an indicator. The acid should be added quite slowly and the end point may be considered as that point at which no pink color develops within two minutes after mixing one or two drops of the liquid with the indicator. Owing to the presence of soluble coloring matter and to the precipitate thrown down by the barium chloride the end point is not very sharp but with a little practice it is fairly easy to get concordant results. A sharper end point is obtained by filtering off or settling out the barium precipitate and using only the clear liquor, but this introduces a distinct error due

to the loss of the caustic soda occluded by the precipitate. In the method outlined above this is kept within the sphere of action of the acid and more accurate results are obtained.

Analyses of black ash and black ash waste are usually confined to simple determinations of the amount of soluble alkali present. In the case of black ash this may be leached out with hot water and titrated as usual in the presence of methyl orange. With black ash waste the volume of carbon is relatively so large that it is well to burn off most of it in a platinum dish before attempting to leach out the soda.

CHAPTER V

THE SULPHATE PROCESS

The sulphate process is similar to the soda process in that the cooking liquor is alkaline, but it differs from it by replacing the alkali lost with sodium sulphate instead of soda ash. In rare cases both are used but the sulphate is always in the greater amount and it is from the use of this material that the process gets its name. Actually it is a misnomer, and it would be better to call it the sulphide process because of the important part played by sodium sulphide in the cooking liquor. This sulphide is derived from the sulphate by reduction in the recovery of the alkali and it is this feature which introduces the greatest deviation from the soda process.

There is more or less confusion in the use of the terms "sulphate" and "kraft" as applied to the process and products. Sulphate may be considered as a general term applying to any cooking process in which the loss of alkali is made up by adding sodium sulphate, while kraft is that subdivision of the sulphate process in which the pulp is intentionally undercooked in order to produce very strong stock. The products of the sulphate process vary according to the cooking conditions from the dark brown, unbleachable kraft fibre to a soft, easy bleaching stock. The latter may be used in making white papers where it gives a soft, pliable sheet in comparison with the harder and more ratty paper from sulphite. The principal use of the sulphate process however is in the preparation of kraft stock.

✓ The sulphate process has two chief advantages over the sulphite process: the chemicals used can be recovered and the wood used may be of a highly resinous nature. It is this second fact which gives the process its widest application. As compared

with the soda process it gives somewhat higher yields and employs a cheaper source of alkali. Its one disadvantage lies in the extremely disagreeable odors due to the organic sulphur compounds formed during cooking and recovery. This has been found serious enough to limit its use to sparsely inhabited localities.

As the process is an alkaline one there is no appreciable action upon the digester plates and it is not necessary to use any lining. The equipment used is very similar to that for the soda process though the digesters are, as a rule, smaller, yielding from two to three tons of pulp per charge. There is a tendency in Europe towards the use of digesters which rotate on their short axes. The sizes of these are variously reported as 18 to 45 cubic meters capacity (635 to 1590 cu. ft.). The digesters should always be welded and not riveted, as the latter are bound to develop leaks from the continual expansion and contraction to which they are subjected.

The cooking process employed depends on whether kraft fibre or easy bleaching stock is to be produced. For kraft fibre in which a dark color is desired a portion of the cooking liquor is made up of black liquor containing practically no caustic soda. The proportion of this black liquor, as might be expected, varies considerably, some mills using as little as 27 per cent while in others it amounts to nearly 60 per cent of the total liquor. The volume of liquor used is about 45 to 50 per cent of the capacity of the digester and it tests 8° to 12° Bé. at 60° C. if indirect heating is employed or 18° to 23° Bé. when steam is blown into the charge. Beveridge¹ states that the total volume of liquor should not be less than 150 cu. ft. per 2000 lbs. of air-dried pulp produced, or per 1.60 cords of wood. The relative volumes of white and black liquor would then depend on the strength of the former as delivered by the causticizing system, any excess over the volume of white liquor necessary to give the required amount of alkali being made up by black liquor. The alkali required in making kraft fibre is said to be 640 lbs. per ton of pulp.

¹ Beveridge: Paper, 1918, 22, 21.

The cooking time is from $1\frac{1}{2}$ to 6 hours and the steam pressure employed varies from 110 lbs. to 135 lbs., the highest pressure being held for only $1\frac{1}{2}$ to 2 hours. In practice it is seldom necessary to cook at more than 110 lbs. pressure. For easy bleaching fibre no black liquor is used and if the cooking liquor has to be diluted water only is employed. The other cooking conditions are about the same as they are for kraft fibre.

A modification of the usual cooking process is that proposed by Ungerer¹ in which the cooking liquor is passed through a series of digesters until exhausted. The original installations were of small digesters and the process has never been very extensively used. The chief trouble seems to have been in keeping the liquor heaters in repair, while the advantages claimed were more uniform, stronger and easier bleaching fibre. The following figures² show the strength of the various constituents in a definite quantity of the liquor as it passes the digesters in series.

Digester	Total soda as Na ₂ O	Soda combined with organic matter	Soda as NaOH	Soda as Na ₂ CO ₃
2	874	251	298	325
3	729	543	31	155
4	657	579	22	56
5	611	552	9	50
6	605	558	3	44
7	598	582	0	16

From experiments in the Forest Products Laboratory³ it has been proved that increasing the amount of either the caustic soda or the sodium sulphide decreases the yield and that the former has about twice as much influence as the latter. The carbonate and sulphate of sodium are apparently without effect on the wood. This has been confirmed by observations under actual working conditions and Beveridge⁴ expresses the opinion

¹ Ungerer: Papier Ztg., 22 (94), 3360.

² Knösel: Papier Ztg., 22 (97), 3470.

³ Wells: Paper, Sept. 24, 1913, p. 15.

⁴ Beveridge: Paper, 1918, 22, 21.

that the caustic soda unites with the organic matter first and when exhausted, or nearly so, the sulphide comes into play.

The composition of sulphate cooking liquor, according to several different authorities, is given below in tabular form, the quantities of the various substances being expressed as grams per liter.

Authority	Na ₂ CO ₃	NaOH	Na ₂ S	Na ₂ SO ₃	Na ₂ SO ₄	Deg. Bé
M. Muller *	24.00	45.00	13.00	2.00	14.00
Schacht *	36.00	80.60	13.50	7.25	15.10	17.8
Schacht *	45.05	77.80	11.25	8.19	12.18	18.5
Heuser †	7.48	61.80	25.12	3.78	4.52
Klein ‡	15.00	62.00	22.00	3.00
	10.00	55.00	30.00	3.00	5.00

* Kirchner: Das Papier, p. 109.

† Heuser: Papier Ztg., 1910, p. 1511.

‡ Klein: Papier-Fabr., 1914, p. 628.

From the investigations of E. Heuser¹ on beechwood it appears that comparatively little sodium sulphide is used up during the process. The following table shows the strength of the cooking liquor used in three of his cooks and the percentages of the individual constituents consumed.

	1	2	3
Na ₂ S added in grams per liter	19.50	24.70	21.40
NaOH added in grams per liter	27.75	48.55	28.20
Na ₂ CO ₃ added in grams per liter	18.00	22.00	9.90
Percentage consumption of Na ₂ S	7.95	15.60	7.00
Percentage consumption of NaOH	69.80	51.20	63.80
Percentage consumption of Na ₂ CO ₃	39.00	6.40	2.80*

* Percentage Increase

In all three cooks the Na₂SO₄ present increased very slightly during the cook.

The materials necessary to produce one ton (2000 lbs.) of sulphate pulp vary quite widely in different mills; the following seem to be the limiting values:

¹ Heuser: Wochbl. Papier-Fabr., 1913, p. 2209.

Wood.....	177-247 cu. ft.
Coal.....	550-770 lbs.
Sodium sulphate.....	320-395 lbs.
Lime.....	530-660 lbs.

The washing, screening and bleaching of sulphate pulp differ in no essential detail from the treatment accorded soda pulp. It is most general to use diffusers to wash the black liquor from sulphate pulp but there is no reason why open pans could not be used and there is considerable difference of opinion as to the relative advantages of the two methods. It is claimed that the size of the plant influences the choice, diffusers being satisfactory for small installations and open pans for large ones. As it is desirable to have five or six diffusers to each digester the cost of installation is high in plants of large capacity. Moreover their life is comparatively short, — about ten years, — due to the pitting and eating away of the steel.

The yield of fibre by the sulphate process, as already stated, is greater than by the soda process. According to Kirchner¹ the yields for spruce (*Fichte*) and fir (*Kiefer*) are:

	Soda	Sulphate	Sulphite
	Per cent	Per cent	Per cent
Spruce.....	29.7-32.8	32.8-35.9	37-50
Fir.....	28.0-29.3	29.3-32.0

Experiments by the author gave the following yields per cord, assuming that there are 100 cu. ft. of solid wood per cord:

	Soda	Sulphate
	Pounds	Pounds
Poplar (<i>Populus sp</i>).....	1007	1130
White pine (<i>Pinus strobus</i>).....	699	773
Pitch pine (<i>Pinus rigida</i>).....	790	862
Spruce (<i>Picea sp</i>).....	786	956

¹ Kirchner: Das Papier, IV, 358.

In addition to the greater yield the sulphate fibre bleaches considerably easier than soda fibre from the same wood.

The blow-off gases from sulphate cooks have been the subject of much investigation in Sweden and Germany. Bergström and Fagerlind¹ have found in them methyl mercaptan, dimethyl sulphide, dimethyl disulphide, methyl alcohol, ammonia, turpentine, rosin oil, hydrogen sulphide, ammonium sulphide, and acetone. The evil odors of the process are due in large part to the first two compounds of which the mercaptan is far the worse. According to Klason and Segerfeld² about 100 grams of mercaptan are produced per ton of wood treated in making easy bleaching pulp while ten times as much may be obtained in kraft cooks. Pine yields about twice as much as spruce. According to Falk³ the condensed materials obtained per ton of cellulose from pine wood are as follows:

	In oily portion	In aqueous portion
	Kgs.	Kgs.
Mercaptan.....	0.062	0.06
Dimethyl sulphide.....	0.927	0.17
Dimethyl disulphide.....	0.103	0.05
Turpentine.....	8.487	0.92
Distillation residues.....	0.721
Methyl alcohol.....	5.00
Ammonia.....	0.18

From work done at the Billingsfors mill the condensed steam from the digesters was found to yield the following quantities for every ton of finished pulp made.

	Lbs.
Turpentine.....	17.6 (from fir)
Turpentine.....	2.2 (from pine)
Methyl alcohol.....	11.0
Methyl mercaptan.....	2.2
Methyl sulphide.....	6.6
Methyl bisulphide.....	0.2
Ammonia.....	0.4

¹ Papier-Fabr., 1909, 7, 7, 27, 78, 104, 129.

² Papier-Fabr., 1911, 9, 1093-1099.

³ Papier-Fabr., 1909, 7, 469-472.

Bergström¹ states that in 1912 five sulphate mills were recovering methyl alcohol. Pine and spruce yield about the same amount, 15 kgs. per 1,000 kgs. of cellulose, and of this 5 kgs. are collected in the condensed vapors while further amounts may be obtained from the vapors formed during evaporation of the black liquors. The cost of such recovery is slight and the process in no way interferes with regular operations of the mill.

Klason² has carried out extended investigations of the sulphate process in the attempt to eliminate the odors. He found that the gases could be almost entirely freed from mercaptan by passing through solutions of various metallic salts but that the only metallic mercaptides which were completely odorless were those of the noble metals. Caustic soda will also absorb mercaptan but not methyl sulphide. The gases, separated from entrained liquid, can be rendered harmless by passing them under a furnace grate but explosions must be guarded against. Oxidizing agents, as bleach or permanganate, will destroy the odors but they also oxidize the alcohol and the quantity necessary is therefore excessive.

The black liquor from the sulphate process has been investigated repeatedly. According to Klason and Segerfeld³ of the organic matter present 54.3 per cent is lignin; 2.5 per cent fatty and resin acids; 3.7 per cent formic acid; 5.2 per cent acetic acid and 30.3 per cent lactonic acids. Of the sulphur originally present as alkali sulphide 51.8 per cent was combined with lignin, 15 per cent expelled as volatile compounds, 16.8 per cent remained as alkali sulphide and 16.4 per cent was unaccounted for.

The committee appointed by the Finnish Government⁴ in 1908 gives the following composition for a black liquor with a specific gravity of 1.140 from a Swedish mill.

¹ Papier-Fabr., 1912, 10, 677.

² Papier Ztg., 1908, 33, 3577.

³ Papier-Fabr., 1911, 9, 1093-1099.

⁴ Papier Ztg., 1910, 35, 2744.

	Per cent
Sodium carbonate (Na_2CO_3).....	2.75
Sodium hydroxide (NaOH).....	0.45
Sodium sulphide (Na_2S).....	1.76
Sodium sulphate (Na_2SO_4).....	1.21
Sodium sulphite (Na_2SO_3).....	0.16
Sodium chloride (NaCl).....	0.17
Sodium thiosulphate ($\text{Na}_2\text{S}_2\text{O}_3$).....	0.14
Soda combined with organic acids.....	2.25
Organic acids.....	11.71
Water, etc.....	79.40
	100.00

An interesting proposal for handling the black liquor is that of Rinman.¹ He concentrates the liquor to about 90 grams per liter of Na_2O , adds salt (NaCl) to a strength of about 40 grams per liter and precipitates the humus matters with carbon dioxide at a temperature of 75°C . The humus matters may be washed with water, provided no sodium sulphide is present, and may then be subjected to destructive distillation. The solution, freed from humus, may be treated by the ammonia-soda process for the recovery of the alkali as bicarbonate. The original plan, to recausticize and use it over again several times before sending it to the reclaiming system, has not proved practical because of the accumulation of substances not precipitated by carbon dioxide.

As an alternative to this process Rinman suggested mixing the black liquor, after evaporation, with lime or caustic soda and distilling destructively in presence of steam at a temperature of 400°C . This would result in the formation of fuel gases, acetone, alcohol, ketones, hydrocarbons, cresols, etc., and the residual carbon would contain the alkali which could be leached out and recovered. An experimental plant at the Stora Kopparsberg mill gave the following yields per ton of pulp made from pine or fir:

	Lbs.
Pure acetone.....	39.6
Motor spirit.....	59.4
Motor oil.....	121.0

¹ Rinman: Papier-Fabr., 1912, 10, 39 and 101.

These proposed methods are rather complicated and have not been generally adopted, much the greater proportion of the alkali being recovered by the usual methods. These consist of evaporation by any of the well known multiple effect evaporators, by disc evaporators or combinations of the two. When both are used the multiple effect takes the weak liquor and brings it up to about 20° Bé., then it passes to the disc evaporator which concentrates it to about 35° Bé. According to Beveridge¹ in a well equipped mill the water which the recovery process must handle per 2000 lbs. of pulp is derived from the following sources:

	Cubic feet	Per cent
Water from chips.....	47.6	25.1
Water from steam.....	42.48	22.5
Water from white liquor.....	67.33	35.6
Water used for washing.....	<u>31.50</u>	16.6
	188.91	

After concentration to about 35° Bé. the liquor, which contains approximately equal weights of water and total solids, goes to the rotary furnaces. These are similar to the furnaces used in soda mills but are sometimes as long as 30 to 35 ft. As the liquor works forward in the furnace it becomes more concentrated and finally burns to a moist, black mass still containing a considerable amount of organic matter and water. In this form it is discharged in close proximity to the smelting furnace into which it is to be fed. During the passage of the liquor through the furnace rings are sometimes formed which hold it back while allowing the soda near the discharge end to become melted by the heat from the smelting furnace. When the ring finally breaks and the liquor runs into the melted mass explosions are very apt to occur.

After being discharged from the rotary furnace the mass is mixed with enough sodium sulphate to replace the alkali lost and is then shoveled by hand into the smelting furnace. This is a chamber about four feet square by seven feet high, lined with soapstone to which the molten alkali does not adhere, and so

¹ Beveridge: Paper, 1918, 22, 349.

constructed that oxidation of the sodium sulphide is reduced to a minimum. Combustion in the smelting chamber is provided for by an air blast entering through tubes which are water-cooled or sometimes made of platinum. The condition of the entering ash and the blast must be most carefully regulated to insure proper results. Moreover the furnace must be watched closely to see that the blast nozzles do not burn off, due to a temporary stoppage of the water, or that the furnace does not become clogged and allow a considerable quantity of the melt to collect. Either of these conditions is likely to result in severe explosions.

The reaction which takes place in the smelter is

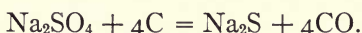

This is to a certain extent reversible as the oxygen supplied in the air blast oxidizes a small amount of the sulphide back to sulphate. For this reason it is not possible to produce a liquor entirely free from sulphate, the proportion depending on conditions in the smelter. The melt, if rich in sulphide, is of a reddish color. The composition of various samples is as follows:¹

Authority	Kgs. sulphate per 100 kgs. melt	Composition of melt in per cents					
		Na ₂ CO ₃	NaOH	Na ₂ S	Na ₂ SO ₃	Na ₂ SO ₄	Insoluble
M. Muller.....	23.7	56.60	0.40	22.60	2.80	12.70
".....	11.0	71.40	0.50	11.60	1.40	9.80
W. Schacht.....	8-10	80.26	1.04	7.15	5.36	1.89
".....	8-10	74.20	1.60	9.50	6.58	3.65
".....	20-22	59.42	0.20	14.00	13.31	8.14
".....	20-22	62.07	2.20	17.75	8.04	5.10
".....	20-22	68.37	13.75	11.40	1.60
Klason and Segerfelt*..	61.73	3.50	21.50	7.33	2.78	1.90

* Papier-Fabr., 1911, 9, 1093-1099.

Beveridge² gives the relationship between the melt, its solution, and the causticized liquor as follows:

¹ Kirchner: Das Papier, 105, 279.

² Beveridge: Paper, 1918, 22, 21.

	Melt, per cent	Solution of melt, grams per liter	Causticized liquor, grams per liter
Na ₂ CO ₃	62.44	212.85	13.8
Na ₂ S.....	26.96	104.17	28.7
Na ₂ SO ₄	4.26	15.84	7.92
NaOH.....	81.1
SiO ₂	2.35
Insol. in water.....	6.18

From the smelting furnace the melt flows in a red hot condition to dissolving tanks containing water or the dilute washings from the lime sludge in the causticizing room. When the solution has reached the desired density it is discharged into the causticizing system. This solution generally has a greenish tint from which it is termed "green liquor" to distinguish it from the "white liquor" obtained after causticizing. The dissolving tanks must be cleaned out occasionally because a certain amount of mud collects in them; this mud should be used in the causticizing system in order to utilize the soda which it contains.

The gases from the recovery furnaces have been analysed by Klason¹ and found to contain 13 mgs. of methyl mercaptan and 4 mgs. of hydrogen sulphide per cubic meter. Careful blowing off from the digester reduces this by about one-third by removing more from the black liquor. The gases from the calciners cannot be washed commercially on account of the great size of the scrubbers required and the slight solubility of the impurities in water. On account of their great dilution only a small part could be burned by passing under the grates of the boilers. In order to reduce the formation of bad odors to a minimum the digesters should be blown off until the condensed distillate has no odor, the black liquor should be evaporated to such a point that it will not cool the fires enough to cause distillation or incomplete combustion, and the calciner should be given plenty of air. Lead acetate paper may be used as a test in controlling the running of the calciner.

¹ Klason: Papier Ztg., 1908, 33, 3619.

The methods for the analysis of the liquors and the recovered ash in the sulphate process are more complicated than for similar products in the soda process. The following procedure for white liquor has been worked out in the Forest Products Laboratory¹ and found to be accurate except in the presence of polysulphide.

(a) Total Alkali.

Two c.c. of the liquor are titrated with half normal acid using methyl orange as an indicator. This gives the acid equivalent to the Na_2CO_3 , NaOH , Na_2S and $\frac{1}{2} \text{Na}_2\text{SO}_3$.

(b) NaOH and Na_2S .

To 2 c.c. of the solution contained in a 100 c.c. flask add 20 c.c. of a 10 per cent solution of BaCl_2 and make up to the mark with boiling distilled water; shake for a few minutes and allow to settle; cool and draw off 50 c.c. of the clear liquid and titrate with half normal acid, using methyl orange as indicator.

(c) Sodium sulphide + $\text{Na}_2\text{S}_2\text{O}_3$ + Na_2SO_3 .

Find by trial the approximate amount of standard iodine necessary to react with 2 c.c. of the liquor. Using about half a c.c. less than this amount of iodine in 200 c.c. of water add 2 c.c. of the liquor, acidify with acetic acid and complete the titration with iodine using starch as an indicator. This shows the iodine equivalent to the Na_2S , $\text{Na}_2\text{S}_2\text{O}_3$ and Na_2SO_3 .

(d) $\text{Na}_2\text{S}_2\text{O}_3$ + Na_2SO_3 .

To 5 c.c. of the solution in a 250 c.c. graduated flask add an excess of an alkaline solution of zinc chloride; make up to the mark, shake for a few minutes, and allow to settle; draw off 50 c.c. of the clear solution, and neutralize with sulphuric acid using methyl orange as an indicator. Titrate this solution with tenth normal iodine using starch as indicator; decolorize by adding one drop of sodium thiosulphate solution and titrate to neutrality with tenth normal sodium hydroxide. The number of c.c.

¹ Paper, Feb. 23, 1916, p. 30.

multiplied by 0.0042 gives the amount of Na_2SO_3 in the sample and this figure divided by 0.0063 gives the iodine value of the sodium sulphite. Subtract this from the iodine titration previously obtained, which will give the iodine equivalent to the sodium thiosulphate present.

Calculations.

$c - d$ gives the c.c. of iodine for sodium sulphide.

$a - b$ gives the c.c. for Na_2CO_3 and $\frac{1}{2} \text{Na}_2\text{SO}_3$.

The titration in (b) expressed as Na_2O , minus the sodium sulphide as Na_2O , gives the Na_2O equivalent to the NaOH present.

This same procedure may be employed for the examination of the recovered ash in which case 50 grams of the sample are dissolved in about 400 c.c. of freshly distilled water and after shaking repeatedly for two hours made up to 500 c.c.

This does not include the determination of Na_2SO_4 which may be accomplished by acidulating a measured volume of the solution with HCl , boiling till all H_2S is driven off and then precipitating the sulphate with BaCl_2 . The BaSO_4 is filtered off, washed, ignited and weighed and from this weight that of the Na_2SO_4 may be calculated.

For a quick method of analysis for the control of the cooking liquor Heuser¹ recommends the following:

Dilute 10 c.c. of the liquor to 100 c.c.

(1) Treat 10 c.c. of the dilute liquor with an excess of $\frac{N}{10}$ iodine solution and determine the excess with $\frac{N}{10}$ thiosulphate using starch as an indicator. Calculate to Na_2S .

(2) Heat 10 c.c. of the dilute liquor with an excess of $\frac{N}{10} \text{H}_2\text{SO}_4$ till the odor of H_2S is gone and then titrate back with $\frac{N}{10} \text{Ba}(\text{OH})_2$ using phenolphthalein as indicator. This gives Na_2S , NaOH and Na_2CO_3 .

¹ Private communication.

(3) Treat 10 c.c. of the dilute liquor with 10 per cent BaCl_2 solution and titrate with $\frac{N}{10}\text{H}_2\text{SO}_4$. This gives NaOH and Na_2S .

Calculations.

$$\begin{aligned} (3) - (1) &= \text{NaOH.} \\ (2) - (3) &= \text{Na}_2\text{CO}_3. \\ (1) &= \text{Na}_2\text{S.} \end{aligned}$$

Moe¹ uses a silver nitrate solution containing 87.89 gms. AgNO_3 per liter for determining sulphides. When 1 c.c. is titrated the c.c. of AgNO_3 used represent pounds of Na_2S per cubic foot of liquor. He gets the end point directly in the solution by shaking to coagulate the silver sulphide, and noting the point at which no further precipitate is formed by a drop of the silver nitrate.

Oliver² works in a somewhat similar way but uses an ammoniacal silver nitrate solution. The liquor to be tested is filtered, made ammoniacal and boiled. The end point is determined by filtering, adding more silver nitrate and repeating till a drop causes only a slight opacity.

The examination of black liquor for total alkali may be performed exactly as in the case of liquor from the soda process. The method for caustic soda, given under the soda process, if applied to sulphate black liquor will show both the caustic soda and the sodium sulphide present so that a correction for the latter is necessary.

For the determination of sodium sulphide in black liquor the Forest Products Laboratory recommends the following method:

Prepare a standard zinc solution by dissolving 16.746 grams of pure zinc in a small excess of nitric acid and adding ammonia till the precipitate formed is completely redissolved. The solution is diluted to 2000 c.c. and enough ammonia must be present to keep the zinc from precipitating at this dilution.

As indicator use a solution of nickel ammonium sulphate made alkaline with ammonia.

¹ Paper, Aug. 12, 1914, p. 19.

² Paper, July 22, 1914, p. 20.

For the determination 50 c.c. of black liquor are diluted to 1000 c.c. and 20 c.c. taken for the test. This is diluted to about 100 c.c. and the zinc solution run in from a burette. The end point is determined by noting whether a precipitate of black NiS is formed when a little of the solution being titrated is added to three drops of the ammoniacal NiSO_4 solution on a spot plate.

Each c.c. of the zinc solution equals 0.010 grams Na_2S .

CHAPTER VI

THE SULPHITE PROCESS

The first patent relating to the use of sulphurous acid in preparing pulp from wood was that granted to B. C. Tilghman in 1867.¹ This was followed in 1869 by a supplementary patent covering the treatment of fibrous materials at ordinary pressures, and it is upon these two patents that subsequent modifications of the process are based. The specifications of the original patent show that Tilghman had worked out his process in an experimental way with great care and thoroughness and that he fully understood all its possibilities. In its practical application, however, difficulties of an engineering nature arose which proved too serious for him to overcome.

After his failure the process was taken up by Ekman and Fry in Sweden, by Mitscherlich in Germany, by Francke, Graham, Ritter, Kellner and numerous other investigators and manufacturers and the engineering difficulties were gradually overcome so that finally the process was established on a firm footing.

Theory of the Sulphite Process. Probably the best explanation of the sulphite cooking process is that it is primarily a hydrolytic splitting of the cellulose-lignin esters followed by secondary decompositions of the lignin. Water alone at high temperatures will hydrolyze lignocellulose rendering part soluble, but in the presence of an acid, such as sulphurous acid, the reaction proceeds much more rapidly and at a lower temperature. Fortunately cellulose itself is comparatively stable under such conditions but that it is by no means unattacked has been shown by Tauss and others. When a substance is present which will combine with the products of hydrolysis and remove them from the

¹ U. S. Pat. 70,483, Nov. 5, 1867.

sphere of action the reaction will proceed to the limit fixed by the constitution of the lignocellulose. Such substances are the sulphites which during the reaction form true chemical compounds with the aldehydic products of decomposition. The organic acids formed during the decomposition of the lignin also combine with the sulphites and thereby set free an equivalent amount of sulphurous acid. During the latter part of a cook this causes a steady increase in the amount of gas which necessitates "blowing off" to prevent too great pressure.

According to Klason¹ lignin is a glucoside-like body of which a part is sugar-like or cellulose while the other part is of an aromatic nature. This contains an oxypropylene group,

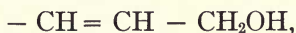

as well as methoxyl, hydroxyl and aldehyde groups. It is closely related to coniferyl alcohol. In the sulphite process sulphurous acid is taken into the double bond

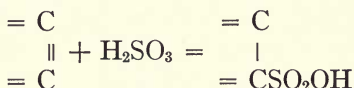

and forms the calcium salt of lignin sulphonic acid,

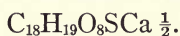

Secondary reactions may cause the formation of calcium sulphate, either from the decomposition of the calcium bisulphite according to the reaction:

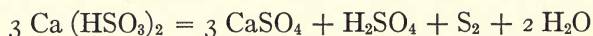

or from reduction of tannin with consequent oxidation of sulphurous acid. This latter reaction explains the difficulty in using wood rich in tannin. >

Wood and Its Preparation. One of the chief requisites for wood to be used in the sulphite process is freedom from any excessive amount of rosin, and of nearly equal importance is the even distribution of that which is present. If the rosin is localized at certain points the wood at those places will remain hard

¹ A. Klein: Papier Ztg., 1906, p. 474.

and will cause shives in the pulp from the portions which are easily reduced.

In the sulphite process the liquor has not nearly the solvent power of the alkali used in the soda process and any bark, decayed portions or knots which go into the digester are likely to appear as dirt in the finished pulp. This applies to the light-colored inner bark if the product is to be used unbleached, since it takes on a dark color and shows in the pulp as dark fibres. For bleached pulp, however, this inner bark is harmless, since it bleaches quite as readily as the rest.

The removal of the bark is accomplished practically in a number of ways. Hand peeling in the woods is not so usual for spruce though it is quite general for the poplar used in the soda process. Disc barkers of various types are most commonly used; in these the log is held by hand or machinery against knives fastened to a rapidly revolving disc. These knives remove much wood as well as bark, particularly where the sticks are crooked. The amount of such loss depends on the size of the logs as well as the care with which the work is done; the sound wood lost may amount to 8 to 20 per cent of the original weight of the logs, in addition to the 8 to 10 per cent of true bark; the total loss, therefore, amounts to 16 to 30 per cent of the logs as received. The drum barker, which is a device to remove the bark by rubbing the logs against one another and the sides of the drum, saves all this loss of wood. It is, however, expensive to install, requires more power than other barkers to do the same amount of work, and in winter the water used in it has to be heated, which adds to the expense. This type of barker is suitable only where very clean pulp is not essential or where bleached pulp is to be made as it does not remove all the thin inner bark. It is best applied to wood which has been in the water two or three months as the bark is then more readily removed. Of the drum barkers the intermittent give better results than the continuous.

With any system of barking the logs should be inspected on the conveyor as they go to the chipper, and any with bark remaining in cracks or around knots put at one side to be cleaned by

hand. Some operators clean very little by hand but put the defective wood at one side to be cooked separately into second grade stock. This necessitates a very thorough cleaning up of all apparatus afterwards.

The barked wood next goes to the chippers which should be run slowly enough to produce even chips. The length of chip

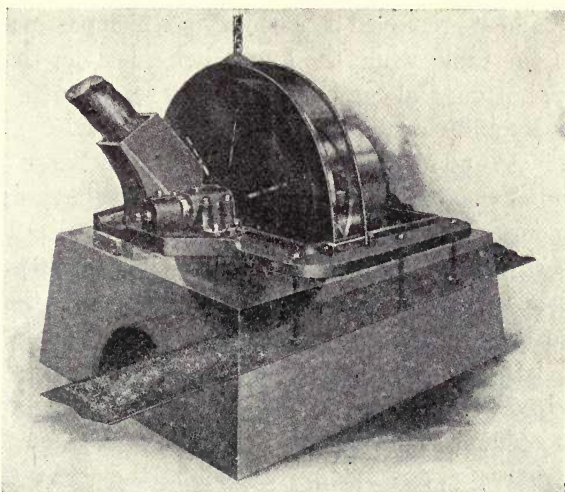

FIG. 21. ' PULP WOOD CHIPPER

depends on the method of cooking as well as the kind of wood. For hemlock they should be $\frac{1}{2}$ to $\frac{3}{4}$ inch long while spruce is chipped about as follows:

For Mitscherlich unbleachable $1\frac{1}{4}$ to $1\frac{3}{4}$ inches long.

For quick cook, newsprint stock $\frac{3}{4}$ to 1 inch long.

For easy bleaching $\frac{5}{8}$ to $\frac{3}{4}$ inch long.

The coarse chips are generally further reduced in size by some sort of crusher and are then screened to remove coarse pieces, which are rechipped, and sawdust, which goes to waste. The sawdust from chipping should not amount to more than 3 per cent.

The knots may be removed from the chips in several ways; one very successful process is to blow them against an inclined wire

screen through which the dust and fine material passes while the good chips slide down the screen and are collected on a conveyor. By proper adjustment of the air blast the knots, being heavier than the good chips, fall short of the screen and are collected by a separate conveyor. Another method, which also makes use of the difference in weight of the good chips and knots, is that of passing the dry chips through a trough of water. The good chips float and are removed by a conveyor which passes across the surface of the tank, while the knots, being heavier than water, sink to the bottom and can be removed by scrapers.

Uniformity and cleanliness of chips are essential to clean pulp and good yield and all chips cooked in the same charge should be of one kind of wood and as nearly as possible of the same age and moisture content. Much difference of opinion exists as to the relative desirability of wet or seasoned wood. Many prefer dry, well seasoned chips, claiming more rapid penetration of the liquor and better yield; others¹ state that green wood or that which has lain in the water for some time is reduced more easily than seasoned wood. Experiments by the author tend to confirm this latter opinion, as in certain cases woods which could not be successfully treated dry readily yielded to the acid if they were saturated with water before cooking.

The capacities of wood handling machinery vary enormously under the conditions of operation but they may be said to be approximately as follows.

Circular and band saws.	up to 50 cords per hour.
Drum barkers.	1-4 cords per hour.
Disc barkers.	1. 2-1. 4 cords per hour.
Chippers.	10-15 cords per hour.
Flat screens.	$\frac{1}{10}$ cord per sq. ft. per hour.

Liquor Making. The liquor or acid used in the sulphite process is an aqueous solution of sulphurous acid in which lime, or some other base, has been dissolved; the final result is therefore a solution of the bisulphite of the base containing an excess of sulphurous acid. In practice this is prepared in two different

¹ Griffin and Little: Chemistry of Paper Making, p. 189.

ways: by passing the gas through water in which the base is dissolved or suspended, or by bringing the gas into contact with comparatively large lumps of the carbonate of the base which are moistened by a continuous flow of water. The first effect of this treatment is the solution of the gas in water forming the true sulphurous acid:

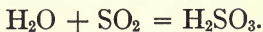

This then attacks the base according to one of the following reactions:

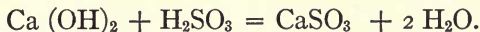

or



If the base is soda or magnesia the sulphites stay in solution but if lime is used calcium sulphite is precipitated as fast as it is formed since it is very insoluble, one part requiring about 800 parts of cold water for its solution. In the first method, working with milk of lime, the formation of sulphite continues until all the lime is precipitated; further passage of the gas then causes this to redissolve with formation of the bisulphite. When limestone or dolomite is used, as in the second method, its surface gradually crusts over with the sulphite which is again brought into solution as more gas is dissolved. Both of these reactions doubtless take place simultaneously when there is a liberal supply of gas.

Of the available bases for making sulphite liquor soda has the advantage of forming a stable bisulphite and the cellulose prepared with such liquor is very pure and easy to bleach. Magnesia possesses these qualities, but in a lesser degree, while lime is likely to make the fibre hard and harsh from formation of calcium monosulphite.

Preparation of Sulphur Dioxide. Sulphur dioxide for use in the absorption system is prepared by burning either sulphur or iron pyrites and with proper care good results can be obtained by either method. The choice of the two processes depends to a great extent on local conditions, such as the relative cost of the two materials, the possibility of disposing of the spent oxide from the pyrites, the floor space available, etc.; it is much more of a financial problem than a technical one.

Sulphur burning was formerly carried on very largely in the retort type of furnaces into which the sulphur was fed through a door at one end. This caused gas of irregular composition due to the sudden rush of cold air into the furnace and through the apparatus. This type of furnace was suitable for very pure sulphur, particularly Sicilian, but when there was a tendency for the sulphur to form an oily surface scum during burning good results were not obtained. This trouble can be overcome by

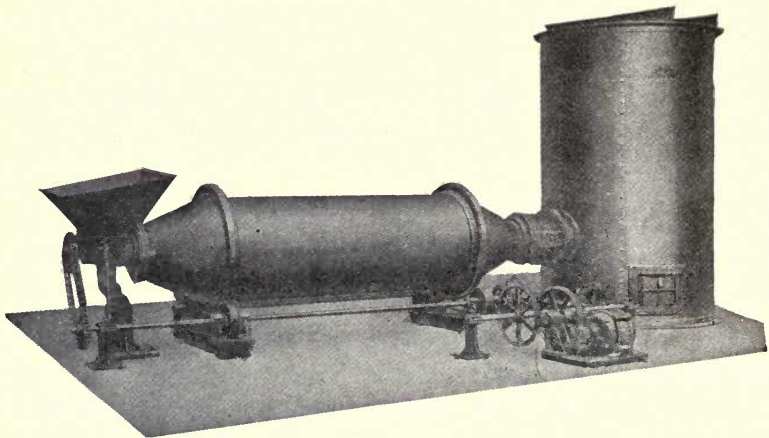

FIG. 22. ROTARY SULPHUR BURNER

installing rakes which travel slowly back and forth, breaking up the scum and presenting fresh surfaces for combustion. With this device the flat burners give excellent results.

Modern sulphur burners are of two quite dissimilar forms — one a horizontal rotary furnace and the other vertical and stationary. In the rotary burner, illustrated in Fig. 22, the sulphur enters from the hopper at the front end and gradually works toward the back. As the burner revolves the sulphur is carried up the sides and thus presents a large and continually renewed surface for combustion. A highly successful modification of the sulphur feed is to introduce it in the molten condition through a pipe entering at the axis of the burner. A continuous supply of

molten sulphur may be obtained by placing the crude sulphur in a steam jacketed tank and also surrounding the delivery pipe with a steam jacket so that the sulphur will not solidify before it

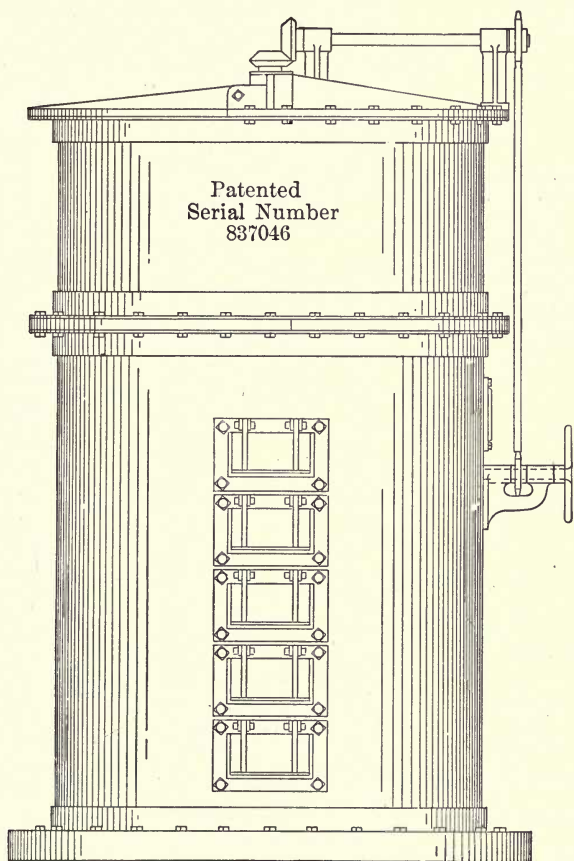

FIG. 23. VESUVIUS SULPHUR BURNER
Courtesy of Valley Iron Works Company

reaches the burner. Users of this type of burner claim that it is the best if it is fitted with self-feeding device and a large combustion chamber because it makes stronger and more uniform gas and starts and stops very quickly in case of shutdowns.

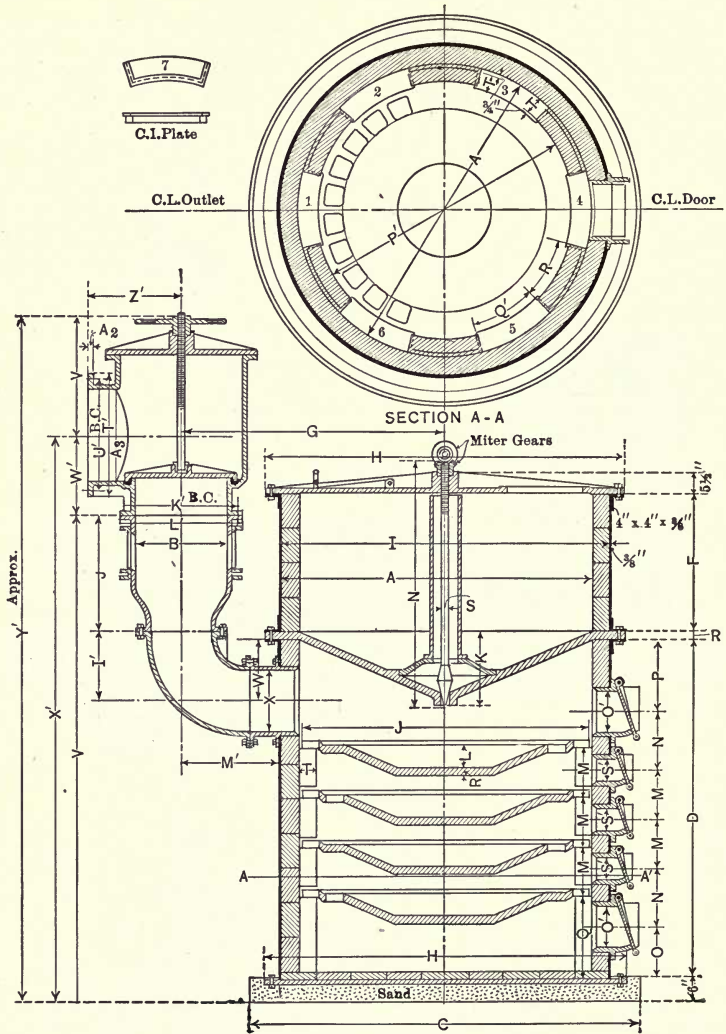

FIG. 24. VESUVIUS SULPHUR BURNER, SECTIONAL VIEW
Courtesy of Valley Iron Works Company

The stationary type of burner is illustrated in Figs. 23 and 24. It consists of a vertical cylinder lined with fire brick and fitted with four combustion trays or shelves. The sulphur is introduced through a melting chamber at the top and flows downward from

one tray to the next. The ash and residue from the sulphur collect at the bottom and if at any time they accumulate on the shelves they can be flushed downward by a sudden increase in the sulphur feed. This burner has no moving parts and therefore requires no power. The makers claim that a burner a little less than 7 ft. high over all and occupying a floor space 6 ft. square has a capacity of 9 tons per twenty-four hours. It is the experience of numerous operators that burners of this type are difficult to run satisfactorily.

The most important factor in sulphur burning is the regulation of the air supply. One pound of sulphur requires for its complete combustion just one pound of oxygen, which is the amount contained in 53.8 cu. ft. of air. If much more air is admitted, and particularly if it contains much moisture, there is a formation of SO_3 and sulphuric acid which causes loss of both lime and sulphur. According to Frohberg¹ the maximum formation of SO_3 takes place at 400° to 500° C. while at 900° to 1000° C. it is again broken up into sulphur dioxide and oxygen. He recommends running the furnaces as hot as possible to produce rich gas which should then be at once sprayed with cold water to reduce its temperature to 90° to 100° C. In one modern American mill the best temperature, measured at the outlet of the combustion chamber, is considered to be 620° C., while variations from 480° to 680° C. sometimes occur.

According to Cosler² poor cooling may be responsible for excessive formation of SO_3 , weak cooking acid and low free SO_2 . Acid saturated with CaSO_4 may carry into the digesters as much as 55 lbs. per ton of chips. This is largely precipitated at the temperature of cooking and may cause poor penetration and necessitate a high temperature to finish the cook. The elimination of SO_3 can be assured by employing the Cottrell electrical precipitation process or filtering the gas through sawdust as recommended by Paulson.³

¹ Chem. Ztg., 1914, 38, 126.

² Cosler: Paper, 1918, Feb. 13, p. 19.

³ Paper, 1917, 21, Oct. 3, p. 32.

Any overheating of the burner is likely to cause vaporization of unconsumed sulphur which passes along with the gases until it reaches the colder portions of the system where it condenses. Sublimation of sulphur also occurs when too little air is admitted after the burner has become thoroughly heated up since there is then too little oxygen present to combine with all the sulphur vapor. The sublimation of sulphur is likely to lead to the formation of thiosulphuric and polythionic acids which at the temperature of cooking again break down with the liberation of sulphur. Free sulphur may also appear in the acid from direct contamination with sublimed sulphur. Klason claims that a liquor may contain as much as 250 mgs. per liter of sulphur as thiosulphuric acid before sulphur is formed in the digester and as under normal conditions the fresh liquor contains only about 3 mgs. per liter of sulphur the danger from this source is not very great.

The conditions under which a burner is working may be judged from the appearance of the flame. When operating satisfactorily it is blue, sometimes tipped with white; if it shows brown fumes of unconsumed sulphur vapor it indicates that the furnace is too hot, probably from the use of too much air, and that there is danger of sublimation.

Attached to, or immediately adjoining, nearly every type of sulphur burner is a combustion chamber which the gas enters as soon as it leaves the burner proper. This is so arranged that more or less air can be admitted at will through appropriate dampers and in this way sublimed sulphur carried along from the burner can be completely burned to sulphur dioxide.

The burning of pyrites in the old type of burners was considerably more difficult to control than the burning of sulphur and it could be worked advantageously only where the burners could be grouped together in sufficient numbers to insure gas of even composition. Many of these difficulties have been overcome by modern mechanical furnaces of which the Herreshoff furnace is a type. These burners (see Fig. 25) usually have five shelves over which the pyrites is raked in succession by mechanically operated rakes. The shafts and arms are hollow and are

cooled by a current of air supplied by a fan; part of the hot air thus produced is used in the lower parts of the chamber and materially assists combustion. The heat produced by the oxidation of the sulphur and iron is sufficient for carrying on the operation and once the furnace is in good working condition no fuel is required. The spent pyrites or cinders leaves the furnace with $\frac{1}{2}$ per cent to 4 per cent of sulphur. The separation of dust is

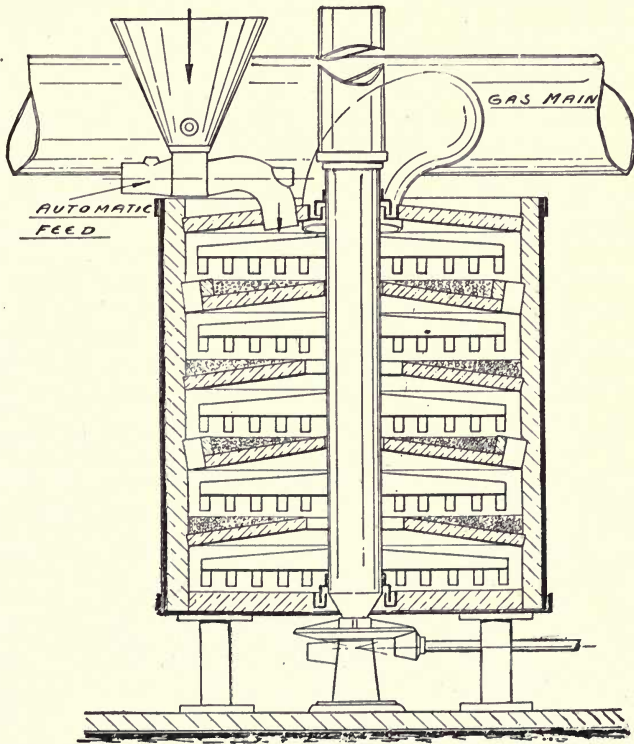

FIG. 25. HERRESHOFF PYRITES BURNER

particularly important where pyrites is used. This was formerly done by passing the gas through long chambers of large area so that the velocity of the gas should be slight. In modern practice it is more successfully accomplished by passing the gas through towers into which water is sprayed; this not only removes dust

but also takes out SO_3 and cools the gas. Provided the wash water is discharged at 175°F. (80°C.) the loss from dissolved SO_2 is very slight.

The gas from sulphur burners operating under satisfactory conditions generally contains 14 to 18 per cent of SO_2 by volume; the maximum which it can possibly contain is 21 per cent. In the case of pyrites the theoretical maximum is 16.2 per cent of SO_2 and it generally runs about 10 to 14 per cent. As a rule when burning sulphur about 2 to 3 per cent is converted into SO_3 while with pyrites as much as 13 per cent may be lost in that way.

After leaving the combustion chambers the gas is conveyed through iron pipes to the coolers. Up to this point the gas is hot and dry and has little action on iron but for the cooler and all pipes beyond lead should be used. The cooler generally consists of lead pipes through which the gas passes back and forth. These pipes are placed in a trough through which water flows, or are so arranged that a thin film of water trickles over them. The cooling surface should be about 15 sq. ft. per ton of daily production which is sufficient to bring the gas nearly to the temperature of the water in summer. In winter the gas should be cooled to about 55°F. (12.8°C.). Regular and uniform cooling of the gas is very important as the rate of absorption and the quantity of gas dissolved depend very largely upon the temperature. The following table ¹ shows how rapidly the quantity of gas absorbed decreases with rise in temperature.

Temperature	1 vol. of water dis- solves SO_2	1 vol. of solution contains SO_2
Degs. C.	Vols.	Vols.
0	79.79	68.86
10	56.65	51.38
20	39.37	36.21
30	27.16	25.82
40	18.77	17.01

Absorption Apparatus. The apparatus in which the bisulphite solution is prepared depends on whether the base is used

¹ Schönfeld: Ann., 95, 5.

in suspension or in lumps of considerable size. In the first class come the apparatus of Partington, McDougall, Frank, Burgess, Stebbins, Barker, etc., while in the second class are the systems of Flodquist, Mitscherlich, Kellner, Ekman, Jenssen, etc. As the tower is the oldest and in some ways the simplest form of absorption apparatus it will be considered first.

The essential feature of the Mitscherlich system is a high tower, usually circular in section and built of wood or of cement lined with acid resisting tile. They vary from 6 to 10 feet in diameter and from 100 to 150 feet in height and generally taper slightly toward the top. Frequently four or more towers are built together and the whole surrounded with a wooden structure with stairs, platforms and stone hoist. A water tank, supplied with cold water, surmounts each tower. The stone is supported on strong oak beams placed about 6 to 10 ft. from the bottom and below these, and about a foot above the acid outlet, are other beams set close together to catch pieces of stone which pass the upper timbers. Frequently the tower is divided into sections

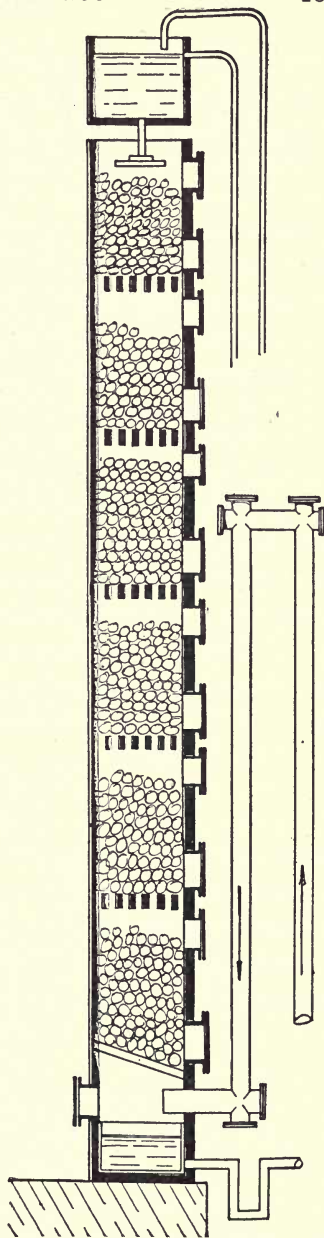

FIG. 26. MITSCHERLICH
ACID TOWER

by timber gratings to assist in the filling and the regulation of the absorption. Some towers act as chimneys and no artificial draft is necessary while with others it is desirable to place a fan between the burners and the towers and a steam exhaust at the top of the towers.

Ritter-Kellner towers are constructed in pairs; the acid from the bottom of one is pumped to the top of the second while the gas from the top of the second is led into the base of the first. These towers are smaller than the Mitscherlich towers and have the advantage of avoiding undue loss of gas.

Further development along this same line is in the direction of the multiple tower system where towers about 20 ft. high are worked in groups of six to eight. The acid passes through these in succession in one direction and the gas in the other. This system is easy to charge with stone, and permits regulation of the gas temperature between towers, which is important in maintaining a constant ratio of base to acid. Its disadvantage lies in the necessity for so many small acid pumps. Such a system is cheaper to install but more costly in repairs than the high tower system, and the latter is replacing all others in European plants.

In any of these systems the towers are filled with lumps of limestone or dolomite. In European works a special soft limestone is preferred but sufficiently pure material of this nature is not available in this country and ordinary dense stone is used. A stone low in magnesia and as free as possible from dirt, iron and silica is preferred. Since marble is practically all calcium carbonate and is of uniform structure it is highly satisfactory for use in towers. A typical analysis of a suitable stone is as follows:¹

	Per cent
Loss on ignition.....	43.63
Iron and alumina.....	0.74
Calcium oxide.....	54.10
Magnesium oxide.....	0.82
Silica.....	0.59
	<hr/> 99.88

¹ Cooper: Paper, 1918, 22, 721.

The water is discharged over the stone at the top by spray pipes or some similar device and in passing downward forms a thin film on the surface of the lumps. In order that it may be properly distributed the inside of the tower is fitted with wooden rings at intervals which prevent the water from running down the walls without moistening the stones. The gas from the burners enters the base of the tower under the grating and passing upward over the moist limestone is very rapidly absorbed by the downward flowing film of water.

In working with tower systems several difficulties are likely to be encountered. It is hard to secure a uniform distribution of the water as it descends the tower or a proper spread of the ascending gas. This tends to form channels which increase rapidly after their first appearance. The lower lumps of stone are in contact with the strongest gas and so dissolve more rapidly than those in the upper part of the tower; this tends to form arches which finally break, letting the stone above settle so compactly that it may impede the passage of the gas. This trouble is overcome in modern installations by tapering the tower toward the top, by dividing it into sections which are packed with stone separately and by proper periodical inspection. In the lower part of the tower crusts of sulphate or of monosulphite of lime sometimes almost stop the flow of gas; the latter is particularly apt to form if the gas is weak or insufficient water is used. Irregular acid is also likely to result if the temperature varies since, as already shown, the solubility of the gas decreases rapidly with rise of temperature while at the same time the base is much more quickly dissolved thus changing the proportion between free and combined acid.

Apparatus for use in acid making by the other system, where the base is in solution or suspension, generally consists of a series of tanks with accompanying piping or in other installations of towers divided into sections by partitions. A frequent arrangement consists of three tight tanks fitted with agitators and with pipes so arranged that the gas enters the bottom of the first tank and passes upward through the solution; from the

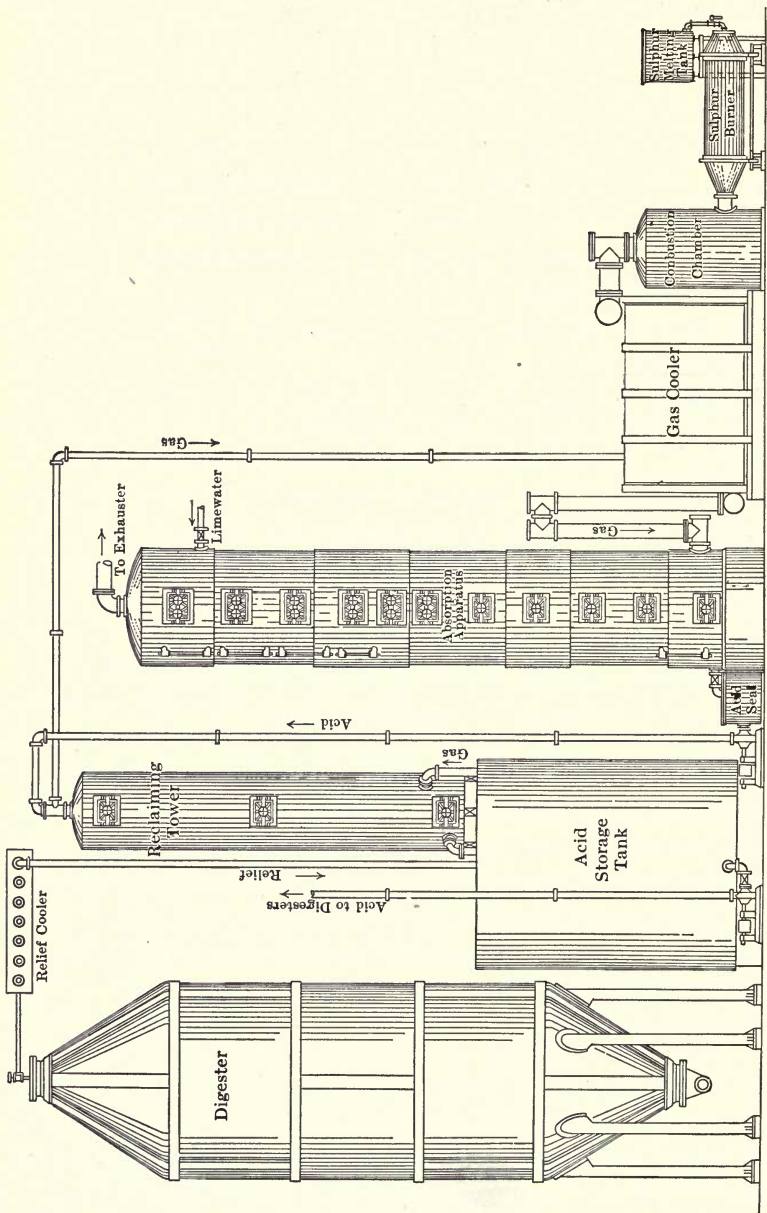

FIG. 27. BARKER ACID TOWER IN RELATION TO OTHER EQUIPMENT

upper part of this tank the un-absorbed gas passes to the bottom of the second and so on through the system. The gas may be either forced in under pressure or caused to pass through by an exhaust fan attached to the last tank. It is general to place the tanks at different levels so that after drawing off the finished acid from the first tank the contents of the second and third may each be run down one stage by gravity. Fresh milk of lime is charged into the third, or upper, tank, and the finished liquor leaving the lower tank should be quite clear.

The Burgess and the Barker systems are examples of the towerlike form of tank apparatus. The Burgess apparatus is generally one high tank divided into three parts by horizontal perforated partitions. It is fitted with a hollow shaft and arms through which the gas passes and is mixed with the milk of lime. The Barker apparatus illustrated in its relation to the other equipment in Fig. 27, is a high tank divided into three or more compartments by horizontal perforated partitions. The construction of the tower is shown in Fig. 28. The milk

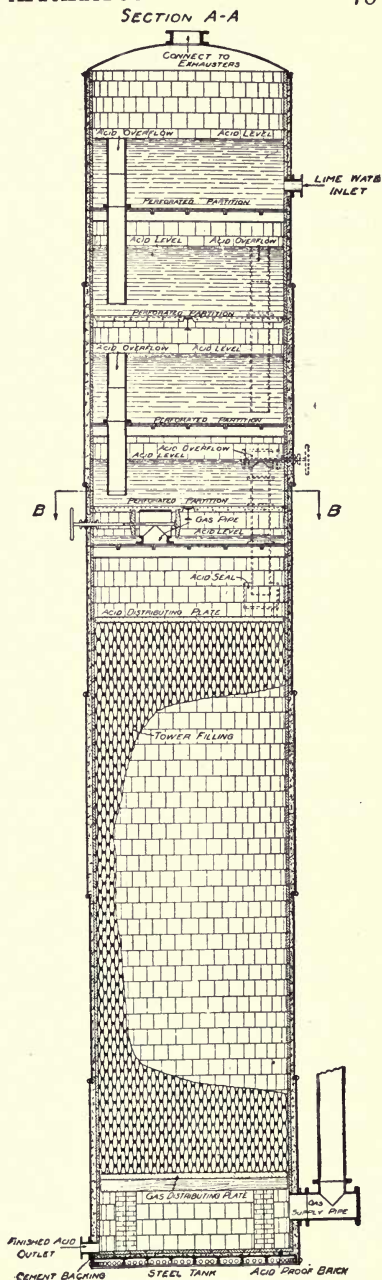

FIG. 28. BARKER TOWER, SECTIONAL VIEW

of lime enters the upper compartment in a continuous flow and meets the gas bubbling up through the perforated false bottom. The weak liquor passes through an overflow pipe to the next compartment where it absorbs more gas, and so on through the four sections. From the lowest one it flows onto a distributing plate which allows it to trickle down into the absorbing tower where it meets strong gas and is strengthened to the desired composition. The gas enters near the bottom under a perforated distributing plate above which is the absorption tower filled with stoneware filling to increase the surface exposed. This apparatus, as well as any good tower system, working in conjunction with a proper reclaiming system, will produce an acid with 1 per cent combined and up to 6 per cent total SO_2 .

The quality of the lime or dolomite used for liquor making is of the greatest importance and its value increases with the amount of magnesia which it contains. For use in milk of lime systems it should be well burned, should slake easily and should be as free as possible from silica and iron. Air slaked or poorly burned limes are not so readily acted on as those of good grade and they are likely to vary so in composition that it is almost impossible to keep the correct proportion of base to acid. The following analyses show the composition of several extensively used limes from different parts of the country.

	Massachu- setts	Ohio	New Brunswick
	Per cent	Per cent	Per cent
Calcium oxide, CaO	56.02	58.61	55.96
Magnesium oxide, MgO	40.10	40.25	37.98
Alumina and ferric oxide, Al_2O_3 and Fe_2O_3 ..	0.57	0.12	1.23
Sulphur trioxide, SO_3	0.11	0.15	0.16
Insoluble in HCl , sand, etc.....	0.94	0.07	1.51
Silica soluble in acid, SiO_2	0.47	0.15	1.81
Loss on ignition, H_2O , CO_2 , etc.....	1.43	0.51	1.00
	99.64	99.86	99.65

It frequently happens that lime of the above quality cannot be obtained on time so that it is necessary to use high calcium

lime for a certain period. It has been found by experience with the Barker system that this causes no serious inconvenience nor does it require any radical change in the cooking system. The opinion seems to be gaining ground that a high calcium lime can be used in the milk of lime system with practically the same results as with dolomitic lime.

Lime for use in the absorption system is first slaked either in tanks provided with agitators or in troughs. One authority recommends a tank with a perforated plate on which the lime is dumped after filling the tank with water to one inch above the surface of the plate. The lime is sprinkled on top with water and when it steams freely is quickly covered with water. The milk of lime produced is diluted sufficiently so that it can be strained through brass sieves of 60 meshes to the inch and the strained material run to storage tanks fitted with agitators where it is diluted to the proper consistency. The milk of lime must be cold when it goes to the absorption system. According to Beveridge¹ the finished milk of lime has a specific gravity of 1.0075 and contains 6.31 gms. per liter of CaO and 4.19 gms. per liter of MgO. This corresponds to about 91 lbs. of lime of the composition given to a thousand gallons of acid. As the lime is never entirely dissolved and some is lost as sulphate and monosulphite in cleaning the apparatus more than the above quantity has to be used, the amount depending on the quality of the lime, the type of apparatus, etc.

There is still much dispute as to the relative advantages of the tower and milk of lime systems. The latter are no longer common in Europe where towers are generally employed, but they are much used in America. The advocates of the tower systems claim that they are simpler to operate, require less power and cost less for upkeep. The cost of lime is also less as the unburned stone is cheaper than burned lime. Obermanns² states that towers require 50 to 60 horse power as compared with 225 horse power for a three tank system, and that the sulphur per ton of

¹ Beveridge: Paper Makers' Pocket Book, p. 99.

² Obermanns: Paper, 1918, Feb. 13, p. 100.

pulp is 240 lbs. as against 300 lbs. for the tank system. For a 100-ton mill these savings, together with that for the cheaper lime, would amount to \$42,000 to \$52,000 per year. Textor¹ compared the systems from a thermochemical standpoint and concludes that an acid of 2.00 per cent free and 1.60 per cent combined SO₂ will entail a rise of 6.4° C. if made in towers from calcite, and 16.1° C. if made in a milk of lime system from a high magnesia lime without the use of steam in slaking or of cooling water in making up the tanks. Considering the claim that towers produce stronger acid it is to be noted that they operate at nearly atmospheric pressure whether the gas is passed through by pressure or vacuum. Tank systems, such as the Barker, generally operate by means of a vacuum pump and if this were changed to force the gas through under pressure the strength of the acid would be increased by 15 to 20 per cent.

The losses which occur in making sulphite liquor are those due to dirt, ash and moisture in the sulphur, to sublimation, and to the formation of sulphuric acid. The loss from the first four causes should never exceed 5 per cent, but that from formation of sulphuric acid is likely to amount to very much more unless careful control is maintained. The formation of monosulphite, which is removed with the sediment in the storage tanks or in cleaning the absorption system, may also cause considerable loss. Such wastes should be examined before being thrown away as it often pays to work them over.

The acid made in either the tower or the tank system varies very widely in different mills according to the kind of fibre being made and the method of enriching the liquor with the relieved or recovered gas. There is no essential difference, however, between the two systems with regard to the liquor produced. Harpf² gives the composition of liquor of 4.5° Bé. from Mitscherlich towers as follows:

	Per cent
Total SO ₂	3.397
Free SO ₂	2.098
Combined SO ₂	1.299

¹ Textor: Paper, 1918, Feb. 13, p. 60.

² Harpf: Dissertation, 1892.

The acid from either tower or tank system is stated by Thorne¹ to have the following composition before being enriched by the recovered gas.

	Per cent
Total SO ₂	2.60
Free SO ₂	1.60
Combined SO ₂	1.00

The finished acid when ready for the digesters is also very variable in strength. From reports on a number of American mills the following figures have been selected as representative:

	1	2	3	4	5
	Per cent	Per cent	Per cent	Per cent	Per cent
Total SO ₂	4.30	4.09	5.50	3.80	6.24
Free SO ₂	3.10	2.46	4.50	2.40	5.22
Combined SO ₂	1.20	1.63	1.00	1.40	1.02

Acid of the strength of No. 5 can only be obtained during warm weather by employing artificial refrigeration; in this particular case the temperature of the acid ready for the digesters was 72° F. (22.2° C.).

Pumping and Storage. Where the liquor is to be discharged directly into the digester, a steam injector may be used for transferring it, but if nothing is to be gained by heating the liquor an injector is too expensive and it also causes considerable loss of sulphurous acid. The best method of handling is with rotary pumps of acid-resisting bronze, which should be so placed that the acid flows to them under a slight head. If a pump is so placed that a foot-valve is necessary on the suction pipe continual trouble will be caused by the crystallization of monosulphite in the working parts.

Storage tanks for liquor are generally of wood, either Southern pine or Douglas fir, without lining. They should be made tight with water or steam before any liquor is admitted so that no monosulphite may crystallize between the staves. The tanks

¹ Thorne: Pulp Paper Mag. Can., March 15, 1915, p. 173.

should be covered to prevent escape of gas but the covers need not be perfectly air-tight since there is little loss in strength, either through escape of gas or oxidation to sulphate, when the liquor is stored in quantity. The tanks should be fitted with gauge glasses to show the depth of liquid and the delivery pipes should draw from near the bottom but high enough to avoid sediment. The tanks should be so located that the sediment may be easily washed out when necessary.

Digesters and Digester Linings. The acid liquor used in the sulphite process acts so destructively on iron that some form of lining is necessary to protect the digester shell. According to Griffin and Little¹ wrought iron suffers most severely, steel resists somewhat better and cast iron suffers least of all. Even the modern acid-resistant cast irons, which are extensively used in concentrating acids, have proved to be too easily attacked to be safe for use in the sulphite industry. Tests by the author on a number of such cast irons gave the following results:

	Loss in grams per square inch		
	18 hours in cold	4 hours more at 90° C.	18 hours more in cold
Ordinary cast iron.....	0.6410
Acid resistant No. 1.....	0.2615	0.1096	0.2030
Acid resistant No. 2.....	0.2362	0.0990	0.1184
Acid resistant No. 3.....	0.3275	0.2138	0.1797
Acid resistant No. 4.....	0.5410

Lead is the only common metal which satisfactorily resists the action of the acid liquor and this is due very largely to the formation of a surface film of insoluble lead sulphate which acts as a protective coating for the metal beneath. Lead, however, has certain properties which have prevented its successful use in digester lining in spite of the immense amount of time and money which have been spent in the attempt. Its coefficient of expansion is 0.0000297 while that of iron is only 0.0000123, so that on

¹ Griffin and Little: Chemistry of Paper Making, p. 232.

heating the digester the lead lining tends to become too large for the shell. This trouble is still further increased by the fact that lead which has been expanded by heat does not quite return to its original size on cooling but remains permanently larger. This causes "crawling" and "buckling" and cracks are apt to appear wherever short turns are made. There is also in vertical digesters a gradual creeping downward of the lead due to its own weight; this causes the upper part to become thinner and finally give way. Even uniting the lead to the iron by melting it on over a flux of zinc chloride, a true soldering process, did not prove entirely satisfactory. Griffin¹ states that such linings remained clean until about two hundred cooks had been made, then star-shaped defects showing cracks and hard crystals appeared and multiplied so fast that they could not be cut out and repaired. Finally black scabs of lead sulphide formed in large masses and the whole lining became worthless. Many other very ingenious methods for controlling the lead were tried but the task was finally given up as hopeless.

Bronze digesters, built of cast sections, were tried at one time but were found to be more or less acted on by the liquor with the formation of black scales of oxide and sulphide of copper. Heating to the temperatures used in cooking considerably reduces the strength of bronze and after several disastrous explosions the use of such digesters was abandoned.

The Salomon-Brünger digester consisted of an inner shell of welded steel and an outer shell also of steel but riveted. The protective coating is obtained by admitting sulphite liquor into the digester which has been previously heated by steam in the jacket at about 40 lbs. pressure. This treatment causes the deposit of a hard, impervious crust of sulphite of lime which gradually increases in thickness with each succeeding cook. This coating did not prove to give adequate protection and the method was never in extensive use.

The Mitscherlich lining is interesting as being the first in

¹ M. L. Griffin: J. Soc. Chem. Ind., 1898, 216-220.

which bricks were used. It consists first of a coating of tar and pitch applied directly to the shell, then a thin lining of sheet lead with the edges burned together and finally two courses of dense vitrified bricks with tongues and grooves. These were sometimes laid in Portland cement.

The Preston lining consists of bricks of Scottish clay backed with a mixture containing clay and lead mixed to the consistency of bread dough with silicate of soda. This must be applied to a perfectly clean shell.

Modern digester linings are generally of acid-proof bricks backed with cement next to the shell. The bricks are 2 to 3 ins. thick while the cement backing is about an inch thick. In some cases a lead lining is applied next the shell and upon this the cement backing is laid. This is seldom done, however, as it is customary to pierce the digester shell with numerous small tell-tale holes so that the location of cracks in the lining may be approximately known. The cement for the backing and pointing the first layer of bricks varies more or less in different localities. Steffanson¹ gives its composition as one part of cement, and two parts of crushed and sifted acid-proof brick with enough asbestos added to render it non-brittle; this is mixed to the desired consistency with 4° Bé. silicate of soda. The last layer of bricks is pointed with litharge and glycerine and the bricks should be set half an inch apart to make repairs easy. Another formula² for pointing the inner layer of bricks is 5 parts litharge, 2 parts cement and 3 parts quartz sand, all measured by volume. After mixing these materials dry, they are moistened with glycerine to the right consistency for use. This should be mixed in small quantities only and used quickly as the mixture retains the proper consistency for only a short time. Digesters pointed with this mixture have been operated up to eighteen months without repairs and in some cases the pointing has proved more durable than the bricks so that the latter have worn down, leaving a raised network of cement exposed.

¹ Steffanson: Pulp Paper Mag. Can., May 20, 1914, *et seq.*

² Private communication.

The bricks used for digester lining should be very hard, dense and well annealed. If soft or under-burned they are apt to crack from changes in temperature and pieces then come away in the pulp. When tested by immersing in water for twenty-four hours they should not absorb more than 2 per cent of their weight.

In general the form of digester used is that of a vertical cylinder with conical top and bottom. The total length is about three times the diameter, and the lower cone is about 60 degs. while the upper is about 110 degs. Digesters of other forms are of course used in some of the older mills and horizontal digesters are sometimes used for the Mitscherlich process. The size of digesters has gradually increased; formerly a capacity of 4 tons of fibre per charge was considered large while now 18 tons or more is not uncommon. The following table by Corcoran¹ gives the approximate capacities of sulphite digesters of standard construction and lined with the usual brick and cement lining:

¹ Corcoran: Paper, 22, 1918, 406.

CAPACITY OF STANDARD SULPHITE DIGESTERS WITH STANDARD LININGS

Size of digester		Thickness of lining, ins.	Contents, cu. ft.	Capacity contents, tons fibre	Gallons of acid	Cords of wood
Diameter, ft.	Height, ft.					
8	24	8	610	1.33	3,000	2.48
8	30	8	840	1.75	3,787	3.24
10	28	8	1,319	2.66	6,000	4.96
10	30	8	1,397	2.90	6,525	5.34
10	37	8	1,850	3.85	8,663	7.16
10	40	8	2,024	4.50	9,450	7.81
11	30	8	1,672	3.48	7,330	6.47
11	37	8	2,896	4.60	10,125	8.37
11	40	8	2,416	5.00	11,250	9.30
11	42	8	2,563	5.33	12,000	9.92
11	45	8	2,784	5.75	12,937	10.69
12	30	9	2,015	4.13	9,282	7.67
12	35	9	2,457	5.10	11,470	9.48
12	40	9	2,879	6.00	13,500	11.16
12	45	9	3,272	6.80	15,300	11.64
12	48	9	3,572	7.40	16,650	13.76
14	38	9	3,819	7.90	17,775	14.64
14	42	9	4,320	9.00	20,250	16.74
14	45	9	4,678	9.75	21,934	18.13
14	47	9	4,924	10.50	22,950	18.97
14	48	9	5,046	10.64	23,625	19.53
14	50	9	5,392	11.20	25,000	20.83
15	40	10	4,682	9.75	21,934	18.13
15	42	10	4,964	10.33	23,250	19.22
15	45	10	5,388	11.20	25,200	20.83
15	47	10	5,671	11.80	26,550	21.31
15	50	10	6,096	12.40	27,900	22.06
15	54	10	6,652	13.75	30,937	25.57
16	45	10	6,146	12.80	28,800	24.80
16	48	10	6,680	13.75	30,937	25.57
16	50	10	6,952	14.40	32,400	26.78
16	54	10	7,598	15.80	35,550	29.38
16	60	10	8,565	17.80	40,050	33.10
16	64	10	9,210	19.00	42,750	35.34
17	56	10	9,074	18.80	42,300	34.96
17	60	10	9,814	20.25	45,900	37.94
17	64	10	10,552	21.80	49,050	40.44
17	70	10	11,660	23.00	51,750	42.78

The digester space required to produce 2000 lbs. of dry pulp is given by Steffanson as follows:

	Cu. ft.
Mitscherlich process.....	400-425
Quick cook process.....	450
For easy bleaching pulp.....	475-500

Boiling. The method of making a boil depends on whether the Mitscherlich or the quick cook process is being employed. The former is very generally used in Europe but in America is not nearly so common as the quick cook or Ritter-Kellner process.

In the Mitscherlich process the digesters are either horizontal or vertical stationary boilers. The cooking is all done by steam admitted to coils of hard lead or copper pipe placed in the bottom of the digester. The standard procedure is to fill the digester with chips and, then steam gently for several hours with direct steam, the water condensing being allowed to run to waste as a brownish liquid. Care must be used during this period to avoid steam pressure in the digester as temperatures much in excess of 100° C. are likely to burn the wood. After steaming all valves except that leading to the liquor tanks are closed and the partial vacuum formed by the cooling of the digester and the condensation of the steam draws the cold liquor in rapidly. The object of this steaming and subsequent admission of cold liquor is to obtain thorough penetration of the chips by the liquor and so prevent floating and burning. Steam is now admitted to the coils and the temperature raised to 110° C. as rapidly as possible, although this may require as much as twelve hours because of the large size of the digester. When pressure is reached it is relieved by opening a valve for a few minutes to get rid of air; this is repeated two or three times in the next hour. Since the relief from Mitscherlich cooks contains no liquor no separator is necessary and the relieved gas can go at once to the reclaiming system. The temperature in the digester is gradually raised to about 120° C. which is maintained throughout the cooking period; during this time the pressure should not exceed 80 lbs. About an hour before the end of the cook the steam is shut off and the pressure gradually reduced to 50 lbs. by relieving gas; this must not be done too rapidly or the pulp may not be thoroughly reduced by the time the sulphur dioxide is gone. The contents of the digester are then discharged as usual. The old method

of emptying horizontal digesters was to admit cold water as soon as the liquor had been discharged, the object being to cool and wash the pulp which was finally removed by shovelling.

The liquor used in the Mitscherlich process is about 3.5 to 4.5 per cent total SO_2 with 0.9 to 1.24 per cent combined. The steam used in the coils is at 60 to 100 lbs. pressure: 75 lbs. in the coils gives about 90 lbs. in the digester. The actual time of cooking varies enormously in different mills. It was originally about eighty hours, but this has been greatly reduced by raising the temperature of cooking and by using some direct steam to bring the charge up to pressure quickly. In this latter case space must be left in the digester to allow for condensation. In modern practice the total time is about twenty-five to forty-five hours. Steffanson¹ states that for bleached pulp the cook is usually not more than twenty-four hours, while Beveridge² subdivides the time as follows for a digester which has to be emptied by hand.

	Hours
Filling.....	2
Steaming.....	4
Filling with liquor.....	2
Boiling.....	35
Blowing off pressure.....	3
Washing twice.....	6
Emptying, etc.....	<u>5</u>
Total.....	57

The particular advantages of the Mitscherlich process are strong fibre and high yield because of the comparatively weak acid and the low temperature of cooking. It is stated by Bache-Wiig³ that temperatures over 135°C . cause the formation of hydrocellulose with consequent lower yield and loss of strength.

The Ritter-Kellner, or quick cook process, in which the steam is blown directly into the digester, is the one most generally

¹ Steffanson: Pulp Paper Mag. Can., May 20, 1914, *et seq.*

² Beveridge: Paper Makers' Pocket Book.

³ Private communication.

used in this country. The digester is usually charged with chips as fully as possible since the settling during the first part of the cook suffices to cover them completely with liquor. Steaming of the chips is seldom resorted to, though it is an advantage, as it drives out air, moistens the chips uniformly and makes better pulp. Moreover the partial vacuum formed in the digester when steam is shut off hastens the running in of the acid and makes it possible to perform this operation without removing the digester head. The most satisfactory point to admit the acid is at the bottom of the digester; if pumped in from below instead of on top of the chips it tends to loosen them up and helps the circulation. The steam inlet for cooking generally ends in a coil around the sides near the bottom and is perforated in such a way as to direct the steam up the sides, thus giving a downward current in the center and good circulation. There is also provided a small jet just at the bottom of the digester to cook the chips in the lower part of the bottom cone.

The steam used in cooking may be superheated or ordinary saturated steam, the latter being used in far the greater number of cases. Tests by Andrews¹ using superheated steam with a temperature of 500° F. at the digesters indicated that it gave a little more uniform product and that a somewhat stronger acid could be prepared. No difference in yield could be detected and the volume of liquor and the fuel required were the same as with saturated steam.

The steam required for cooking is much greater than for a soda cook of a corresponding number of cords. This is due to the continual relief of gas and steam through the coolers into the recovery system. Andrews calculates the saturated steam for a 14 × 47 ft. digester holding 16 cords of rossed wood as about 60,000 lbs. per cook. In another plant with digesters of about the same capacity steam flow meter records during a period of four months showed that the average steam consumption per cook was 75,940 lbs.

¹ Andrews: Paper, Feb. 20, 1918.

In steaming a cook it is very important that the pressure be brought up slowly as otherwise a high temperature may be reached before the liquor has had time to penetrate the chips and their centers will be found hard and of a red or brown color. The time from the start until 75 lbs. pressure is reached varies in different mills from two to four hours. The pressure, however, does not afford a reliable indication of conditions within the digester since the actual steam pressure is augmented by that of the gas set free during boiling and in some cases the indicated pressure may be almost wholly hydrostatic due to the filling of the digester by condensation. The temperature is therefore the real factor to be watched and this should be taken at a point about one-third of the way down the digester. The best method of keeping track of the temperature is by means of some form of recording thermometer as this gives a permanent record of each cook from start to finish.

No hard and fast rule for cooking can be given and each mill has its own particular method which is generally the result of gradual evolution rather than the application of scientific knowledge. As an example of the procedure in cooking easy bleaching pulp of high quality Steffanson¹ gives the following schedule: Steam in such a way as to reach 75 lbs. pressure in two to three hours; open relief and bring temperature to 240° F. (115.5° C.) in about an hour. Close both steam and relief valves for an hour and a half, then turn on steam and open relief very slightly. The maximum temperature of 300° F. (149° C.) should be reached in ten hours with the maximum pressure still 75 lbs. Now shut off steam but not relief, allow the pressure to drop to 50 lbs. in one to two hours and discharge into the blowpits. At the end of the cook the liquor should test 0.05 per cent total SO₂. If the cook is blown at a pressure much in excess of 50 lbs. some partially cooked chips will be blown to pieces and cause shives.

¹ Steffanson: Pulp Paper Mag. Can., May 20, 1914, *et seq.*

In another mill making an easy bleaching sulphite for use in writing papers the following schedule is in effect:

Bring to 78 lbs. pressure in three hours and then start relief.

Bring temperature to 228° F. at 4th hour.

Bring temperature to 246° F. at 5th hour.

Bring temperature to 262° F. at 6th hour.

Bring temperature to 278° F. at 7th hour.

Bring temperature to 290° F. at 8th hour.

Bring temperature to 298° F. at 9th hour.

Start to reduce pressure when 5 c.c. of liquor require 2.7 c.c. of iodine and lower to 50 lbs. at blow, which is when 5 c.c. of liquor require 0.7 c.c. of iodine.

Fig. 29 shows the general method of recording the conditions

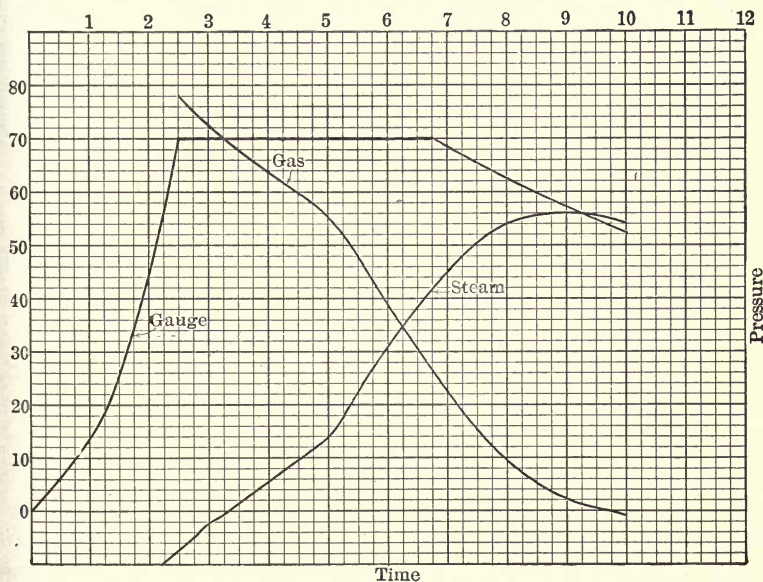

FIG. 29. SULPHITE COOKING CHART

within the digester during the cook. Observations are taken at frequent intervals and plotted on the chart in such a way as

to show the gauge, gas and steam pressures. This gives a graphic representation which can be followed easily by the workmen. The chart given is for a quick cook easy-bleaching sulphite. Fig. 30 is the temperature record taken during such a cook.

During the progress of a cook the heat and the chemical reactions taking place within the digester cause more or less gas

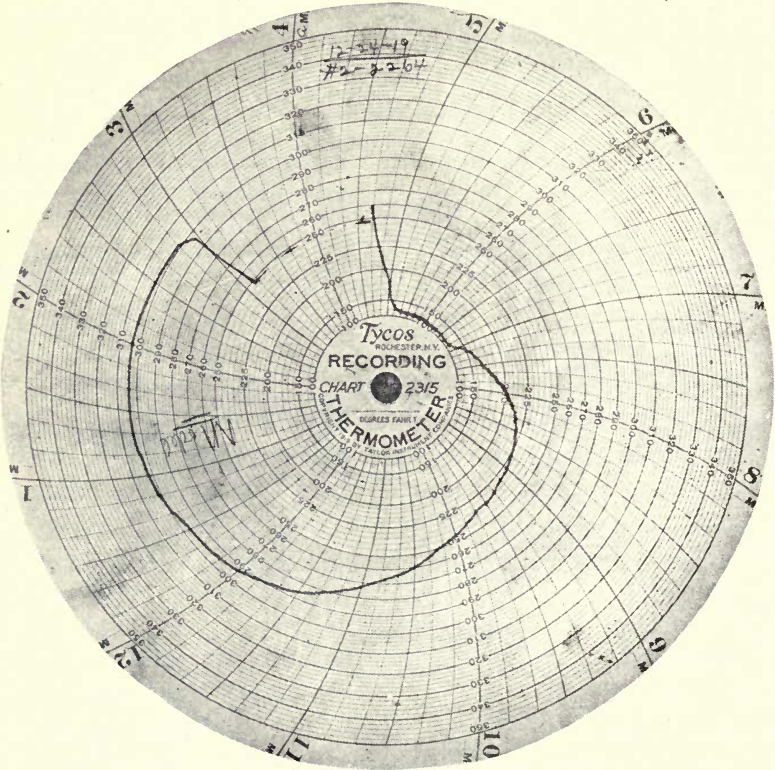

FIG. 30. TEMPERATURE RECORD OF A SULPHITE COOK

to be evolved which results in a gradual building up of the pressure. This gas pressure is not injurious to the fibre provided the temperature is carried at the right point, but it is the general custom to reduce it by "relieving" or blowing off some of the gas either at intervals or continuously. Study by Schwalbe¹ of

¹ Schwalbe: Wochbl. Papier-Fabr., 1913, 44, 2786.

the relieved gases shows that when blown off at 110° C. they contain no oxygen, indicating that all originally present in the digester has already been used up. He recommends relieving air when the temperature reaches 75° C. as the bisulphite is relatively stable at that temperature and the loss of gas will consequently be less. The relief at times also contains much liquor and for this reason it is sometimes passed through a separator of some kind so that the gaseous portion may be conveyed to the liquor tanks to bring up the strength of the raw acid to the proper cooking strength. This recovery process is of the first importance in reducing the consumption of sulphur per ton of pulp. The amount of relief depends partly on the strength of the acid used since the stronger the acid the greater will be the amount of gas evolved on heating. The kind of cook, direct or indirect steam, and the temperature of cooking also have much influence on the amount of relief. If too much gas is blown off the pulp will be burned and whenever burned pulp is obtained and the temperature has not risen above 320° F. (160° C.) it is an indication that the acid was originally too weak or that too much gas was blown off.¹ If it is discovered during a cook that the usual method of relief will allow too much SO₂ to escape before the cook is done it may be remedied by closing the relief, drawing off some of the liquor from the bottom of the digester, and then again steaming. Some mills use this method regularly, relieving only to get rid of air and to reduce pressure before blowing.²

In practice the relieving of a digester is done from one or both of two points, either through the top or through the side. It is claimed by Wimmer³ that side relief is a help in systematic cooking and also aids in the recovery of gas and the reduction of sulphur per ton of pulp. To use the side relief to the best advantage he recommends relieving from the top for about one and one-half to two hours, or until the temperature is 120° to

¹ Griffin and Little: Chemistry of Paper Making, p. 252.

² Steffanson: Paper, June 3, 1914, p. 19.

³ Wimmer: Paper, Jan. 19, 1916, 15.

130° C. (248° to 266° F.), then, closing the top entirely, relieve from the side for one and one-half to two hours. After this top relief can be started again and only dry gas will ordinarily be obtained to the end of the cook. On large digesters there should be from three to five hours of dry gas.

As already stated the composition of the acid liquor varies greatly in different mills and with the nature of the fibre being made. Schlick¹ states that the strength of the pulp produced is in indirect proportion to the strength of the acid used. Experiments by the Forest Products Laboratory² appear to indicate that with a total SO₂ content of 5 per cent, increasing the amount of combined SO₂ above 1.0 per cent, has very little influence on the time of cooking while decreasing the combined acid below 1.0 per cent increases the speed of cooking. As the combined SO₂ is decreased below 1 per cent there is an increase in the amount of screenings and in the bleach required. Other authorities place the lower limit for combined SO₂ at 0.75 per cent and agree that going below this point increases the bleach required. Decreasing the temperature of cooking between the limits of 146° C. and 110° C. tended to increase the yield and decrease the screenings and the bleach required due to the more even cooking. Froberg³ claims that the rapidity of the digestion, other things being equal, is dependent solely on the concentration of the free SO₂ and that in order to hasten the process dry wood and liquor rich in free SO₂ should be used. The present tendency is toward the use of acid of high strength, particularly in free SO₂. An increase in this factor enables the time of cooking and the final temperature to be reduced. The higher test for the digester acid means a higher blowing test at the end of the cook in order to obtain equal yields. It used to be stated that the best acid contained 75 per cent of its total SO₂ in the free state while now it is considered that 80 to 85 per cent is a better figure. Much difference of opinion exists

¹ Schlick: Paper Pulp Mag. Can., 1915, 13, 227.

² Private communication.

³ Wochbl. Papier-Fabr., 1910, 41, 1179-1182.

regarding the relative value of acids of different compositions and much more work will have to be done before the influence of all factors can be definitely established.

In the cooking process irregularities are likely to occur from very obscure causes. Overcooking may be caused according to Klason ¹ if too little lime is used. The minimum amount necessary to saturate the lignosulphonic acids is 22.5 grams per kilo of wood and if less than this amount is used the pulp is overcooked and charred. Overcooking may also result from decomposition of the liquor with formation of free sulphur according to the reaction

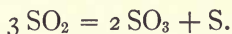

The sulphur acts catalytically, producing further decomposition of the calcium bisulphite, and the sulphuric acid combines with the lime as CaSO_4 so that not enough base is left to combine with the sulphonic acids which polymerize and eventually the fibre is attacked and darkened. Selenium in the cooking liquor will also act catalytically and with far greater power than free sulphur. Torgerson and Bay ² have proved that it is not the selenium directly but the simultaneous presence of dust that causes the trouble. This dust acts as an energetic contact substance promoting catalytic action of the selenium. This action is recognized by a sudden fall in the SO_2 and lime contents of the liquor after the digestion has proceeded for some time.

The best way to determine the progress of a cook is to titrate portions of the liquor with $\frac{N}{10}$ iodine solution which will show the

amount of total SO_2 . In taking samples from the digester for this test a cooler should be used, otherwise much of the SO_2 will be lost. Another test which is frequently employed is to remove samples of the liquor and treat them with a mixture of strong ammonia and water in equal parts in test tubes. This

¹ Klason: Wochbl. Papier-Fabr., 1910, 41, 464 *et seq.*

² Torgerson and Bay: Papier-Fabr., 1914, 12, 483.

causes the precipitation of calcium monosulphite which is at first light and voluminous but which decreases in quantity as the cooking proceeds. When a certain volume of precipitate is reached the cook is considered finished. This test is usually stated to show the amount of lime present as sulphite but according to Oman¹ it is virtually a test for SO_2 since if enough of the latter is present all of the lime will be precipitated. By taking the sample from the digester through a cooler and adding some calcium chloride to the ammonia used the test may be made to indicate the amount of SO_2 present. The cooks in charge of the digesters also judge of the condition of the cook, to a certain extent, by the color and odor of samples of the liquor removed from the digester at frequent intervals toward the end of the cook.

Recovery of Gas. The relief of gas and liquor from the digester during cooking causes a very large loss of sulphur dioxide and the recovery of this is an important item in keeping the cost for sulphur at a low point. This is accomplished by passing the relief through separators and coolers from which the gas is taken to the acid storage tanks where it is absorbed and brings the acid to the desired strength for cooking. The liquid portion from the separator is either allowed to go to waste or is mixed with the acid from the acid system previous to strengthening the latter with relieved gas. In Thorne's² recovery system the separated and cooled gas from the digester is passed into the bottom of a tower filled with wood blocks over which the acid from the acid system is passed, the strengthened acid thus formed goes to the storage tanks. The liquor from the separator contains about 1 per cent of SO_2 and after cooling it is sent to the acid system with the water or milk of lime as the case may be. This system is equally applicable to the limestone or milk of lime systems and by its use it is said to be possible to strengthen an acid of 2.60 per cent total and 1 per cent combined SO_2 up to 5.50 per cent total with no in-

¹ Oman: *Teknisk Tidskrift*, 1916, 46, 4.

² Thorne: *Pulp Paper Mag. Can.*, 1915, p. 173 (March 15).

crease in the amount of combined; moreover this is accomplished at a temperature of 35° C. (95° F.) with no loss of gas.

In blowing down pressure before discharging the digester, the gas can be recovered by passing the gas and steam under the false bottom of a tower in which there is a continuous shower of water. This absorbs the gas and soon becomes heated by the steam to such a temperature that it can no longer hold the gas in solution. This liberated gas, together with that coming from the digester, soon increases to such an extent that the water supplied can no longer absorb it and there is delivered from the top of the tower a constant stream of pure gas which can be used in the acid system.

In a few instances attempts have been made to recover the gas liberated when the digester is blown into the blow pits, but the volume of gas and steam which must be handled in a very short time is enormous and it is very doubtful if the results obtained pay for the expensive equipment and the cost of operating. In one installation where this is being tried there has been no reduction in the amount of sulphur used per ton, indicating that the recovery is not a paying proposition.

The sulphur consumption in practical work is generally figured from the weight of sulphur fed to the burners and the tons of pulp produced. Bryant¹ states that in commercial work the sulphur consumption varies from 235 to 400 lbs. per ton and that the amount theoretically necessary, not taking the formation of sulphuric acid into account, would be 184 lbs. Schwalbe² gives the sulphur consumption as 9 to 10 kgs. per 100 kgs. fibre (180 to 200 lbs. per 2000 lbs. fibre) and thinks that it should be possible to work with as little as 8 kgs. (160 lbs. per ton). Less sulphur per ton is used in the processes where indirect steam is used because less loss is incurred by dilution and relieving liquor.

Blowing and Washing. As already stated the contents of the digester are usually discharged into the blow pit under a pres-

¹ Bryant: Paper, Jan. 28, 1914.

² Schwalbe: *Chemie der Cellulose*, p. 530.

sure of about 50 lbs. or less. The pipe from the digester to the blow pit may be of copper or even cast iron since the pitch in the pulp covers the inside of the pipe and prevents corrosion. This pipe is so arranged that the stock is discharged against a target placed in one end of the blow pit, to prevent wear on the pit walls. This target may be of bronze or of hard cast iron; the latter is generally used as it is cheaper, and offers more resistance to mechanical wear than bronze. As the acid at this stage is comparatively weak and the blowing is immediately followed by washing the chemical resistance of the cast iron is sufficient for this purpose.

Blow pits are of various shapes but consist essentially of tanks with false bottoms through which the waste liquor may drain. Modern American mills often use perforated tiles in the pit bottoms. They are frequently of reënforced concrete lined with wood of a resinous nature such as Southern pine or Douglas fir. The washing is done by a stream of water from a hose, or by means of sprinkler pipes, and requires several hours. A novel wash pit arrangement is that proposed by Kuhn.¹ The entire floor is covered with drainer tiles and the wash water enters from below these tiles and is thoroughly mixed with the stock by air or steam forced through a series of perforated pipes laid on the surface of the tiles. After thorough mixing in this way the wash water is allowed to drain off by opening the appropriate valves. If desired this process can be repeated. The claim is made that the washing of 15 tons of dry fibre can be accomplished in 37 minutes as follows: 15 minutes for filling with hot water, 15 minutes for washing with air or steam and 7 minutes for draining.

The treatment of the pulp after washing is largely a mechanical one, to remove dirt, knots, slivers, and uncooked or partly cooked chips, by means of riffles, screens, etc. The screenings thus removed amount to 3 to 8 per cent of the pulp produced. During these mechanical purification processes the stock is very

¹ Kuhn: Papier-Fabr., 1915, 13, 725 and 744.

largely diluted; one authority gives the concentration of the stock as follows:

In riffles.....	250 parts water to 1 part pulp
In coarse screens.....	125 parts water to 1 part pulp
In fine screens.....	150 parts water to 1 part pulp

The unbleached sulphite fibre found on the market shows wide variations in color, strength and physical properties. Its chemical composition also varies more or less as is proved by the following table.

ANALYSIS OF UNBLEACHED SPRUCE SULPHITE FIBRE *

	Per cent	Per cent	Per cent	Per cent
Moisture, loss at 100° C.....	6.15	6.70	6.57	6.45
Mineral matter (ash).....	1.00	0.45	0.33	0.65
Hydrocellulose, etc., soluble in alkali..	2.53	2.26	4.25	1.52
Cellulose.....	85.32	89.74	88.12	81.51
Non-cellulose (lignin) by difference....	5.00	0.85	0.73	9.87

* Griffin and Little: Chemistry of Paper Making, p. 268.

The ash in sulphite spruce fibre has been given considerable study by Richter.¹ He finds that it rarely exceeds 1 per cent and is usually about 0.5 per cent. Silica, generally amounting to about one-third of the total ash, is probably fixed as calcium or magnesium silicate during boiling as the silica present in the wood is too little to account for so much in the fibre ash. The percentage of iron in the ash showed no constant relationship to the total ash nor to any characteristics of the pulp.

The rosin in sulphite has been given much attention because of its possible relation to rosin spots in the paper made from it. Herzberg gives the following percentages of rosin extracted by ether:

	Bleached	Unbleached
	Per cent	Per cent
Mitscherlich pulp.....	0.44	0.58
Ritter-Kellner pulp.....	0.43	0.59

Other investigators find considerably higher amounts as follows:

¹ Richter: Wochbl. Papier-Fabr., 1913, 44, 1776.

	Ether soluble	Alcohol soluble	Total
	Per cent	Per cent	Per cent
Foreign sulphites*.....	0.70-1.33	0.10-0.22	0.90-1.43
American sulphites*.....	0.65-1.21	0.15-0.62	0.86-1.52
Unbleached fibre†.....	0.82-0.98	0.18-0.82	1.05-1.67
Bleached fibre†.....	0.66-0.98	0.23-0.62	1.00-1.60

* Richter: Wochbl. Papier-Fabr., 1913, 44, 4507.

† Schwalbe: Wochbl. Papier-Fabr., 1913, 44, 3247.

Both Richter¹ and Schwalbe² claim that the ether soluble portion is responsible for trouble with rosin spots. The total material contains both a fatty and a resinous constituent and Schwalbe has shown experimentally that neither constituent alone will produce rosin spots but that both together will give distinct and characteristic spots. The best means of avoiding rosin troubles seems to be seasoning the wood, which reduces the rosin soluble in ether and alcohol. Changes in the character of the rosin extracted from the wood indicate that storage of chips for two to three weeks in the open air is as effective as storing the logs for two years. Richter³ gives the following figures for rosin in cellulose from the same wood wet and dry.

Moisture in wood	Rosin in cellulose		
	Ether soluble	Alcohol soluble	Total
Per cent	Per cent	Per cent	Per cent
49.0	1.00	0.11	1.11
0.5	0.38	0.26	0.64
35.0	1.31	0.31	1.62
5.0	0.88	0.36	1.24

Bleaching largely eliminates rosin troubles and with well-bleached pulp trouble from this source is seldom encountered.

For the demonstration of rosin in sulphite fibre, Klemm⁴ uses a strong solution of Sudan III in a mixture of three parts alcohol

¹ Richter: Wochbl. Papier-Fabr., 1913, 44, 2486.

² Schwalbe: Wochbl. Papier-Fabr., 1914, 45, 2926.

³ Richter: Wochbl. Papier-Fabr., 1913, 44, 4621.

⁴ Klemm: Wochbl. Papier-Fabr., 1911, 42, 967.

and one part water. The sample is reduced to a pulp with water, drained and the moist fibres treated with the dye. The excess is removed by blotting paper and the fibres mounted for observation in water. The rosin will be found stained orange red while the fibre is uncolored.

Modified Sulphite Processes. Numerous modifications of the sulphite process have been tried out and patented from time to time. It would be impossible to enumerate all of these but a few may be mentioned as showing the trend of modern investigations.

Eichmann ¹ first subjects the wood to the action of gaseous SO_2 and then boils with sulphite liquor as usual.

Moore and Wolf ² charge the digester with chips and liquor as usual, close the head and then inject gaseous SO_2 , air being allowed to escape. The charge is allowed to stand without heating to allow the SO_2 to penetrate and steam is then passed in until the cook is complete. The injection of SO_2 gas is repeated during the steaming to make up for the dilution by condensation.

Mortnerud ³ takes the liquor from under a false bottom in the digester, passes it through a heater and back into the top of the digester, thus maintaining good circulation and cooking with weaker liquors because there is no subsequent dilution by condensation. This process is giving excellent satisfaction in the sulphate pulp industry and is claimed to be equally applicable to the sulphite process.

Sammet and Merrill ⁴ have obtained a United States patent for cooking with gaseous ammonia, sulphur dioxide and steam instead of the usual liquor. Somewhat similar is the process of Tyborowski ⁵ who causes ammonia to react with sulphite liquor, thus precipitating calcium monosulphite, which is removed, and

¹ German Patent 184,991, May 31, 1906.

² U. S. Patent 1,119,977, Dec. 8, 1914.

³ German Patent: 286,074, Class 55b, Dec. 28, 1913.

⁴ Paper Trade J., March 14, 1912, p. 46.

⁵ U. S. Patent 621,692, June 16, 1914.

obtaining a cooking liquor containing ammonium sulphite and free ammonia.

The claims for nearly all of these modified processes are much alike, viz.: shorter time, lower temperature, lighter colored, stronger and easier bleaching fibre, greater yield, etc.

By-products and Waste Liquor. The sulphite process offers opportunities for the recovery of by-products which are now lost during the period of relieving or in the waste liquor. Bergström¹ states that the vapors condensed from the digesters yield an aqueous distillate containing methyl alcohol, acetone, aldehyde and traces of acetic and formic acids together with a brown oil floating on the surface. This oil contains 7 per cent boiling between 150° and 160° C., 55 per cent boiling from 160° to 190° C. and 17 per cent boiling between 190° and 210° C. The portion boiling between 160° and 190° C. consists largely of cymene. The specific gravity of the various fractions varies from 0.845 to 0.951. The same author² states that in the Ritter-Kellner process 8 to 10 kgs. of methyl alcohol are formed per ton of easy bleaching cellulose produced; of this about 3 kgs. may be obtained from the relieved gases. If the waste lyes are distilled in a continuous column apparatus the distillate contains methyl alcohol, acetaldehyde, acetone, oils and SO₂ as well as small quantities of formic and acetic acids.

The problem presented by the waste liquors of the sulphite process is one which is not only interesting from a chemical standpoint but has also attracted much attention because of its bearing on stream pollution. In some cases, particularly in Europe, mills have even been obliged to close because it has been found impossible to purify the waste liquors sufficiently to comply with the legal requirements. While the industry in the United States is not confronted with quite such serious conditions it is only a question of time before much more complete purification will be demanded, so that the desirability of an early

¹ Bergström: Papier-Fabr., 1912, 10, 359.

² Bergström: Papier-Fabr., 1912, 10, 677.

solution is very evident. The present method of purification, if it may be called such, is merely to separate the fibres and neutralize the free acid with lime. The material thus removed is comparatively small in amount considering that for every ton of fibre produced there is a ton of organic matter dissolved in the waste liquor. The total amount of this waste in the United States was estimated by the Geological Survey to be a billion pounds annually as long ago as 1913. The discharge of such vast quantities of waste into streams renders the water injurious to health and makes it unfit for boiler use. It aids in the development of algæ which may even grow in such quantities as to choke the streams. Under certain conditions it may cause the development of hydrogen sulphide with accompanying loss of oxygen in the water and consequent death of animal and vegetable life.

Considerations of the nature outlined above as well as the desire to obtain useful and valuable products from a waste of such enormous magnitude have led many investigators to take hold of the problem. Walker¹ describes the waste liquor as a dark, reddish brown fluid of a specific gravity of about 1.05, and having a peculiar, not unpleasant odor. Among the constituents present he mentions sulphur dioxide, sulphur trioxide, free sulphur, calcium and magnesium lignin sulphonates, pentoses and pentosans, mannose, dextrose, galactose, free furfural, traces of vanillin or vanillin-like body and small quantities of terpene-like substances. Waste liquors obtained in cooking hemlock wood have the following composition, according to Bryant:²

	Grams per liter	Pounds per ton of pulp
Total solids.....	115.00	2999
Loss on ignition.....	105.36	2748
Ash.....	9.64	251
Total sulphur.....	7.83	204
Sulphur as SO ₃	0.76	20

The specific gravity of this liquor was 1.0425.

¹ Walker: J. Soc. Chem. Ind., 32 (1913), 389.

² Bryant: Paper, 1914, Jan. 28.

Klason¹ calculates that for every ton (2202 lbs.) of dry fibre produced the waste liquor contains the following:

- 600 kgs. (1320 lbs.) lignin.
- 200 kgs. (441 lbs.) sulphur dioxide combined with lignin.
- 90 kgs. (198 lbs.) CaO combined with lignin sulphonic acid.
- 325 kgs. (717 lbs.) carbohydrates.
- 15 kgs. (33 lbs.) proteins.
- 30 kgs. (66 lbs.) rosin and fat.

According to Krause² the principal constituent in the waste liquor is the calcium salt of lignin-sulphonic acid. Ritter-Kellner liquor is darker and contains more furfural and generally more sugars than Mitscherlich liquor. Wood boiled in the autumn contained about twice as much sugar as wood obtained in the spring. >Very careful analyses of liquor from autumn cut wood gave the following figures:

	Mitscherlich process	Ritter-Kellner process
	Per cent	Per cent
Furfural.....	0.01	0.02
Pentosans.....	0.40	0.29
Hexosans.....	0.21	0.49
Total sugars.....	1.48	1.47
Pentoses.....	0.47	0.41
Mannose.....	0.48	0.48
Levulose.....	0.28	0.25
Galactose.....	0.01	0.01
Dextrose.....	Trace

According to Johnsen³ the volume of liquor which can be obtained without special apparatus is 740 to 800 gallons per ton of pulp, while Haegglund⁴ claims to obtain 960 gallons. Great differences of opinion also exist as to the rate of formation of fermentable sugar during the cook. Krieble⁵ states that most of the sugar is formed before the end of the seventh hour and that

¹ Klason: Papier-Fabr., 1909, 26, 627, 671, 703.

² Krause: Chem. Ind., 1906, 29, 217.

³ Johnsen: Pulp Paper Mag. Can., 16, 1918, 314.

⁴ Haegglund: Pulp Paper Mag. Can., 15, 1917, 1185.

⁵ Krieble: Paper, 23, 1919, 753.

part of the fermentable material is destroyed if the temperature rises above 145° C. after that time. Haeggund, on the other hand, claims that only a little sugar is formed during the first six or eight hours but that it increases rapidly on longer cooking, the rate depending on temperature and composition of the cooking acid.

Hoening¹ claims that no organic acids except formic and acetic are present and that the ratio of these is 1 : 1.56. He finds 2.15 to 9.08 grams of volatile acid per liter.

The waste liquor, according to Walker,² yields brominated and chlorinated products; it contains active carbonyl and methyl groups and is a strong reducing agent. On addition of alcohol the chief constituents are precipitated as a dark, gummy mass which becomes brittle on drying. This may also be obtained by salting out with sodium chloride or by treating with concentrated mineral acids or lead acetate. It is almost impossible to purify this substance because of its colloidal nature and its limited solubility in the usual organic solvents.

The attempts to utilize the materials in this waste liquor have been very numerous and many patents have been issued covering all kinds of industries. A complete enumeration of all the patents in detail would occupy too much space and moreover it has been well covered by Müller³ up to the year 1911 and also by Johnsen and Hovey.⁴ A brief outline of the more important uses, or proposed uses, is therefore all that will be attempted here.

As a binder the waste liquor, either in its original strength or concentrated by evaporation, has been tried for various purposes. As a road binder liquor at 1.13 sp. gr. has given very fair service when sprinkled upon the streets. While it is not water-resistant, the roads to which it has been applied appear to resist the action of rains fully as well as those to which crude oil has been applied. This use has only local interest because of the cost of transporting

¹ Hoening: Chem. Ztg., 1912, 36, 889.

² Walker: J. Soc. Chem. Ind., 32 (1913), 389.

³ Müller: Literatur der Sulfit-Ablauge.

⁴ Bulletin 66, Dept. of Interior, Canada, 1919.

the relatively dilute liquors. In preparing briquettes from waste coal it has met with some success, the briquettes being hard and making excellent fuel in ordinary grates or in smelting furnaces. An advantage which it possesses for this work is that the briquettes do not soften on heating and hence hold their shape well in use. On the other hand, the high percentages of ash and sulphur are detrimental in some cases. The briquetting of pyrites, wood waste, iron ores and other materials has also been successfully carried out by means of the concentrated waste liquor. Another use as a binder is in the iron foundry where it is mixed with the sand in preparing the moulds. Stutzer¹ gives the following as the composition of a sulphite waste liquor and two concentrated products made therefrom:

	Original waste liquor	Wood extract	Cell pitch
Dry matter.....	12.18	63.88	82.79
Ash constituents.....	1.44	2.64	14.90
Lime.....	0.87	0.50	8.50
Total sulphur.....	0.85	4.80	5.87
SO ₂	0.24	0.15	0.85

In the preparation of concentrated products either iron or copper apparatus may be used, but if the former is employed the acid in the liquor must be neutralized by lime. Direct evaporation in copper is preferable if the product is to be used in tanning. A multiple effect evaporator is generally employed to bring the liquor to 35° Bé. and the final concentration is performed on drums one of which will bring it up to 60° Bé. while a second will convert it to a solid. The pitch appears as a black opaque resin but is soluble in water. About 1 kg. of dry pitch is obtained from 10 kgs. of waste liquor and for each ton produced about a ton of coal is required.

It has been proposed by Knösel² to prepare a fertilizer from the waste liquor by evaporating to about 25° Bé. and mixing with

¹ Stutzer: Papier Ztg., 1911, 36, 5.

² Knösel: German Pat. 128,213.

about an equal weight of ground Thomas slag. Analyses of this product show that practically all the phosphoric acid is in the citrate soluble form.

The use of sulphite waste liquor in the sizing of paper has been proposed by Mitscherlich¹ who mixed the liquor with gelatin solution and separated the precipitate formed. This was then dissolved in weak alkali and added to the paper stock in which it was precipitated by alum. A sizing process of another kind is that of Klason² in which the waste liquor is used instead of alum as a precipitant for silicate of soda. Neither of these processes has ever come into extensive use.

Stutzer³ has investigated the possibilities of waste liquor in the preparation of cattle feed and asserts that in each kilo, containing 120 grams per liter of solids, there are 550 calories which can be made available by feeding. His proposed treatment is to evaporate 100 liters to 50 liters in a vacuum, mix with 0.5 kg. of formaldehyde and ground limestone and then filter. The filtrate, after further evaporation, is mixed with molasses and 6.25 kgs. of peat to give 45 kgs. of cattle food.

In the dyestuff industry it has been used as the basis for the manufacture of sulphur dyes, in the reduction of indigo and in the preparation of indanthrene and similar dyes. The sodium lignin sulphonate prepared from it has been employed to replace tartaric acid in mordanting wool.

Strehlenert⁴ has proposed the following method for the preparation of lignin and the recovery of sulphur dioxide. A little acid sodium sulphate is added to the fresh hot liquor and the calcium sulphate which precipitates is separated. The hot liquor is then run into digesters and heated to 100° C.; air is pumped in until the pressure reaches 18 atmospheres, when the temperature rises 20° because of the chemical reactions taking place. Heating is continued to 160° C. Between 160° and 170° C. is

¹ Mitscherlich: German Pat. 54,206, 1890.

² Klason: Z. angew. Chem., 22 (1909), 1423.

³ Stutzer: Z. angew. Chem., 22 (1909), 1999.

⁴ Strehlenert: Papier-Fabr., 1913, 11, 645, 666.

the critical point at which decomposition of the lignin sulphonic acid begins. This reaction causes the temperature to rise about 20° more and it is finally forced up to 200° C. The time after reaching 100° C. is about 40 to 60 minutes. If properly conducted this procedure causes the evolution of sulphur dioxide, which can be recovered, while the lignin is precipitated in granular form and can be used as fuel after partial drying. The sulphur recovery is claimed to be 25 to 30 kgs. (55 to 66 lbs.) per ton of pulp and the lignin enough to supply the entire fuel requirements of the pulp mill.

The use of the dried waste liquor as a fuel is suggested because of the large amount of combustible matter which it contains. The dry material is light, powdery and has a heating value of about 6000 B.t.u. per pound. Experiments in burning this in the same manner as powdered coal¹ gave excellent results and the ash formed in easily accessible places and showed no tendency to fuse.

Rinman² mixes the waste liquor with lime to make 22 to 25 grams per liter of calcium oxide and boils first for five hours at a low temperature and finally at 180° C. The precipitate of calcium sulphite and humus is filtered off and treated with sulphur dioxide to recover the calcium bisulphite. The alkaline filtrate is evaporated to 40° Bé., more lime is added, the mass evaporated to dryness and finally destructively distilled in presence of steam. The products of this latter process include acetone and low and high boiling oils.

The preparation of a material for use in making insulating substances or artificial leather is patented by Trainer.³ The waste liquor is evaporated to 30° Bé. and then heated with an acid, preferably after adding an aldehyde such as formaldehyde.

Extracts for use in tanning leather are prepared in considerable quantities by processes involving neutralization with lime, concentration, and subsequent separation of the organic and

¹ Paper, Dec. 19, 1917.

² Papier Ztg., Apr. 4, 1915.

³ Trainer: German Pat. 197,195, Feb. 20, 1906.

inorganic materials. The extracts obtained contain practically no true tannins but do contain materials which are taken up by the skins and act as fillers. While these extracts are not suitable for tanning alone they find a legitimate use as additions to other true tanning substances.

The preparation of alcohol¹ from waste lyes has probably attracted more attention than any other method of utilization and a number of commercial plants are already in successful operation. The two principal processes now in use are the Swedish, which is a combination of the Wallin and Ekström processes, and the Norwegian or Landmark method. The principle of all processes is the fermentation of the sugars present followed by the distillation of the alcohol formed, and one of the principal difficulties encountered has been due to the poisoning of the yeast by traces of sulphur dioxide. The Swedish process uses a tempered yeast which is capable of resisting this action. The liquor is first neutralized by calcium carbonate and the last traces of acidity by calcium hydroxide, it is then cooled, settled and run to the fermentation vats where the yeast is added. It is fermented at 27° C. for four or five days and then distilled. The raw alcohol contains 92 to 93 per cent of ethyl alcohol, 3 to 4 per cent methyl alcohol and small amounts of cymol, acetone and aldehyde. The yield of 100 per cent alcohol by this process is said to be 74 liters per ton of dry sulphite, and the cost about 12 cents per U. S. gallon 180 proof.

In the Norwegian process the fermentation is aided by a nutrient and easily fermentable medium prepared from milk or whey. To the milk an equal volume of sulphite liquor is added and a small amount of muriatic acid and the precipitated ligno-casein filtered off. The filtrate is then added to the waste liquor and the mixture evaporated to a concentration of about 15 per cent. It is next neutralized by powdered limestone, cooled to 27° C. and the yeast added; in this case ordinary

¹ Tartar: J. Ind. and Eng. Chem., 1916, 226; Hedalen: Pulp Paper Mag. Can., 1916, 176; Kiby: Chem. Ztg., 1915, 39, 212 *et seq.*; Segerfelt: Papier. Ztg., 53, 2518, 2558.

brewers' yeast has proved entirely satisfactory. After four or five days' fermentation it is ready to be distilled. The yield by this process is claimed to be 91.2 liters of 100 per cent alcohol per ton of dry sulphite, and the cost about 9 cents per U. S. gallon 180 proof.

According to McKee¹ the so-called poisoning of the yeast is not due to sulphur dioxide but to the lack of oxygen. He has patented a process in which the hot waste liquor is cooled by blowing air through it and then placed in closed fermentation tanks where it is kept agitated during the fermentation period by a slow current of air. Under these conditions fermentation proceeds satisfactorily with ordinary yeast even in the presence of very considerable amounts of sulphur dioxide. Loss of alcohol is prevented by scrubbing the exit gases from the fermentation tanks with unfermented liquor.

According to Stalnacke² three mills in Sweden were producing in 1916 about 660,000 gals. of 100 per cent alcohol annually, while the total possible production was about 6,868,000 gals. Considering the equipment necessary he states that for a mill making 55 tons of cellulose the fermentation vats should hold 264,000 gals. and the distilling apparatus should be capable of handling about 2400 gals. per hour.

While the preparation of alcohol from the waste liquor is a profitable undertaking it does not solve the problem of the disposal of the liquor since the spent fermentation residues are nearly as objectionable as the original waste.

Other substances which it has been proposed to recover from the waste liquor are antiseptic materials, calcium sulphite, calcium sulphate, coniferin, cymol, acetic acid, furfural, levulinic acid, oxalic acid, sulphur, turpentine, lignorosin, vanillin, etc. Many of these can be obtained only in small amounts and the demand and the prices obtainable are not such as to make the undertaking attractive.

¹ McKee: Paper Trade J., 1918, Aug. 22, p. 42.

² Stalnacke: Paper, Apr. 5, 1916.

While much progress has been made there is still a tremendous amount of work to be done before the utilization of this enormous amount of waste can be considered satisfactory. The quantity of material to be handled would seem to indicate that such investigations should be directed towards the production of large amounts of products at small profits rather than the preparation of small quantities of substances of relatively high value per pound.

Tests and Analyses for the Sulphite Process — Sulphur.

Sulphur as obtained at present on the American market is of a very high degree of purity but it is nevertheless well to examine it occasionally.

Moisture may be determined by weighing a 3 to 5 gram portion into a weighing bottle, drying to constant weight at 70° to 80° C., cooling and again weighing. The heating should not be prolonged beyond the time necessary to reach constant weight and the temperature must not be allowed to rise too high.

To determine non-volatile substances a 10 gram sample is cautiously heated in a porcelain crucible on a sand bath until nearly all of the sulphur has volatilized (ignition of the sulphur must not take place). Cover the crucible with a perforated lid and pass into it pure, dry hydrogen gas until all sulphur has escaped; cool and weigh as non-volatile matter.

The inorganic ash may be determined by igniting the non-volatile matter with access of air and reweighing after cooling.

Selenium may be determined according to the method of W. Smith¹ as follows: Weigh 30 to 50 grams of the finely ground sulphur into an Erlenmeyer flask, add a few cubic centimeters more bromine than the grams of sulphur used and allow it to stand 15 minutes. Transfer to a 100 c.c. separatory funnel and shake vigorously with 40 c.c. of bromine water for one minute. Separate the sulphur bromide from the aqueous solution and pour the latter through a wetted filter paper. Add

¹ W. Smith: J. Ind. Eng. Chem., 1915, 7, 849.

about 2 c.c. of bromine and 40 c.c. of bromine water to the sulphur bromide, and repeat the extraction four times, keeping the last extract separate. Treat the last extract in the same way as the combined extracts, using proportionate parts of potassium iodide and hydrochloric acid and if the presence of selenium is proved repeat the extraction as often as necessary. The combined extracts are boiled till clear and any remaining free bromine is removed by careful additions of powdered potassium metabisulphite or sulphite until the solution just becomes colorless. Dilute to about 250 c.c., add 15 c.c. of hydrochloric acid and about 5 grams of potassium iodide and boil; this completes the precipitation of the selenium, and gradually converts the red to the black form. The free iodine is removed by a few cubic centimeters of potassium sulphite solution; the solution is boiled for 20 minutes, filtered through a tared Gooch crucible, the selenium washed with hot water, and dried at 100° C. until constant in weight.

Burner Gases. In order to control the burners properly the gases should be tested once an hour, or oftener if the burners are not working satisfactorily. The sulphur dioxide may be determined by means of an Orsat apparatus using caustic soda in the absorption pipette. The gas is measured in the burette over water which soon becomes saturated with SO_2 and then introduces only a very slight error.

Excess air may be estimated by determining the oxygen by means of alkaline pyrogallate after first absorbing the SO_2 in caustic soda. This test gives valuable information regarding leaks in the apparatus between the combustion chamber and the absorption system.

Sulphur trioxide in the gases is very difficult to determine with accuracy. Richter¹ passes the gas, at a rate of 1000 c.c. in 20 to 25 minutes, first through a hard glass sampling tube surrounded with an iron jacket and then through a tube 30 cms. long which is filled with garnets and bits of porcelain and cooled

¹ Papier-Fabr., **II**, 1913, p. 610.

with ice. The gas is measured by the amount of water delivered by the syphon bottle which is used to induce its flow. After passing 2 to 5 liters of gas the tube is washed out by drawing pure air through it and finally is washed into a beaker with water to remove the SO_3 . This is then determined gravimetrically by precipitation as BaSO_4 .

The generally accepted place to sample the gases is in the main pipe between the cooler and the absorption apparatus.

Besides these chemical tests it is customary to record the temperature of the gases as they leave the combustion chamber and again after passing the cooler. Some form of recording pyrometer is desirable for the former work while an ordinary chemical thermometer is satisfactory for the latter.

“Acid” or Bisulphite Liquor. Samples of the liquor delivered by the absorption apparatus are generally tested once an hour and the liquor in the storage tanks whenever a digester is filled.

For total SO_2 a 1 c.c. sample is taken by means of a pipette and diluted with 200 to 300 c.c. of water in a white porcelain bowl. A few drops of starch solution are added and then $\frac{N}{10}$ iodine solution is run in until a blue color appears.

For free, or available, SO_2 a 1 c.c. sample is titrated with $\frac{N}{10}$ caustic soda, using phenolphthalein as an indicator.

The combined SO_2 is the difference between the total and free SO_2 .

The tests given are those generally made by the mill foremen and are intended to give comparative rather than absolute results. They are subject to errors because of the small size of the sample, and because the pipette is not usually washed out and hence a little of the liquor always remains adhering to the glass. It is customary to read from a chart the amount of either free or total SO_2 corresponding to the volume of caustic soda or iodine used. This is generally spoken of as per cent, but it is not exactly that as the test made in this way takes no account of the specific gravity of the liquor.

For accurate analyses of the liquor a sample of 10 c.c. should be diluted with recently boiled and cooled water to 100 c.c. and 10 c.c. of this used in the tests.

Sulphates in the liquor may be determined by placing 10 c.c. in a covered beaker, adding an excess of strong hydrochloric acid and boiling for some time until the odor of SO_2 is no longer noticeable. The sample is then diluted and the SO_3 determined gravimetrically as BaSO_4 .

Bases may be determined by the following method given by Griffin and Little.¹ Ten to twenty cubic centimeters of the acid are treated with H_2SO_4 in slight excess in a platinum dish, and evaporated to dryness. The dry mass is cautiously ignited until no more fumes come off, and the residue cooled and weighed as sulphates of calcium and magnesium.

Treat the sulphates with 5 c.c. of water and one or two drops of hydrochloric acid and break up all lumps with a stirring rod. Rinse into a beaker with as little water as possible, add one or two drops of strong sulphuric acid and alcohol equivalent to twice the volume in the beaker. Allow it to stand with occasional stirring for an hour or more, then filter off and wash the precipitate first two or three times with 60 per cent alcohol and finally with 40 per cent alcohol as long as anything is removed by the treatment. The residue on the filter is dried, ignited, and weighed as pure calcium sulphate.

Selenium. As a practical test for the presence of selenium in injurious quantities, Klason and Mellquist² seal up some of the liquor in glass tubes, from which air has been expelled by carbon dioxide, and heat for 15 hours at 137°C . in a bath of boiling xylene. If appreciable amounts of selenium are present, the composition of the liquor will be changed by this procedure.

Waste Liquor. At the end of the cook the liquor in the digester is tested for total SO_2 by means of $\frac{N}{10}$ iodine. The

¹ Chemistry of Paper Making, p. 414.

² Klason and Mellquist: Papier-Fabr., 1913, 145.

sample is generally drawn from about one-third the way down the digester and no attempt is made to retain the SO_2 by cooling the liquor as drawn. Of this hot liquor a 5 c.c. sample is generally tested.

For the determination of free SO_2 in waste liquor, Stutzer¹ recommends the following: Place 25 c.c. of the liquor in an Erlenmeyer flask, add 25 c.c. of standard alkali, then 1 gram of ammonium chloride or nitrate and immediately connect with a condenser. Boil for just 20 minutes and catch condensate in 25 c.c. of standard acid. The acid not neutralized by this treatment is equivalent to the free acid in the waste liquor.

¹ Stutzer: Papier Ztg., 1911, 36, 5.

CHAPTER VII

GROUND WOOD OR MECHANICAL PULP

The preparation of ground wood pulp brings in comparatively little of a chemical nature yet its close relationship to the rest of the industry makes it desirable to include a discussion of the methods and general principles involved. The commercial manufacture of ground wood is generally not conducted according to any fixed standards of practice, each superintendent or manager having his own theories about the best methods of operating. For this reason little reliable information was available until the Forest Service undertook the collection of data and it is upon their results¹ that much of the present chapter is based.

The present method of manufacture has been in use for a long time and except for increased size and capacity of grinders it has changed but little since its introduction in 1867. The process consists briefly in pressing blocks of wood against the surface of a grindstone which is also supplied with water to remove the pulp as fast as it is made. The stones are usually about 54 ins. in diameter by 27 ins. face, but in some recent installations have been as large as 60 ins. in diameter by 48 ins. face. Up to a few years ago natural quarried stones only were used, but many mills are now experimenting with artificial stones. The wood to be ground is placed in pockets in the housing of the stone in such a way that the logs are parallel with the shaft on which the stone is mounted. Pistons operated by hydraulic pressure then force the wood against the stone until it is reduced to pulp. The pockets are then recharged and the process re-

¹ Forest Service Bulletin, Experiments with Jack Pine and Hemlock. Forest Service Bulletin 127, Grinding Spruce for Mechanical Pulp. Forest Service Bulletin 343, Ground-Wood Pulp.

peated. There are generally three or four pockets for each grinder and as they seldom become empty all at once they are filled as necessary and the process is thus continuous.

There is now on the market a magazine grinder equipped with two pockets into which the wood is fed automatically. The Voith Magazine Grinder, shown in part sectional elevation

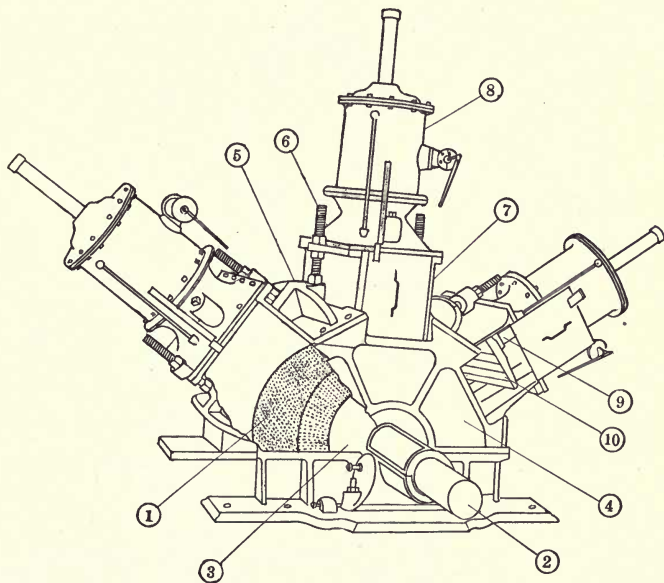

FIG. 31. THREE-POCKET GRINDER

- (1) Grindstone (2) Shaft (3) Steel flanges (4) Casings or side frames
 (5) Bridge-trees (6) Studs to support (7) Pockets (8) Hydraulic cylinders
 (9) Piston rods (10) Pressure foot

in Fig. 33 is of this type. The advantages of this grinder are said to be (1) increased capacity, (2) charging is automatic and not subject to the irregularities of manual feeding, (3) constant load on motor or turbine and (4) decreased cost of attendance.

The pulp coming away from the stones collects in pits under the grinders and from these pits it flows to screens with one-fourth to three-fourths inch perforations which remove slabs, knots, large splinters, etc. For satisfactory operation of these

screens the stock should be diluted to at least 1 per cent dry matter. The stock passing these coarse screens goes next to the regular screens of centrifugal or diaphragm type, and for this operation it should be still further diluted to about 0.25

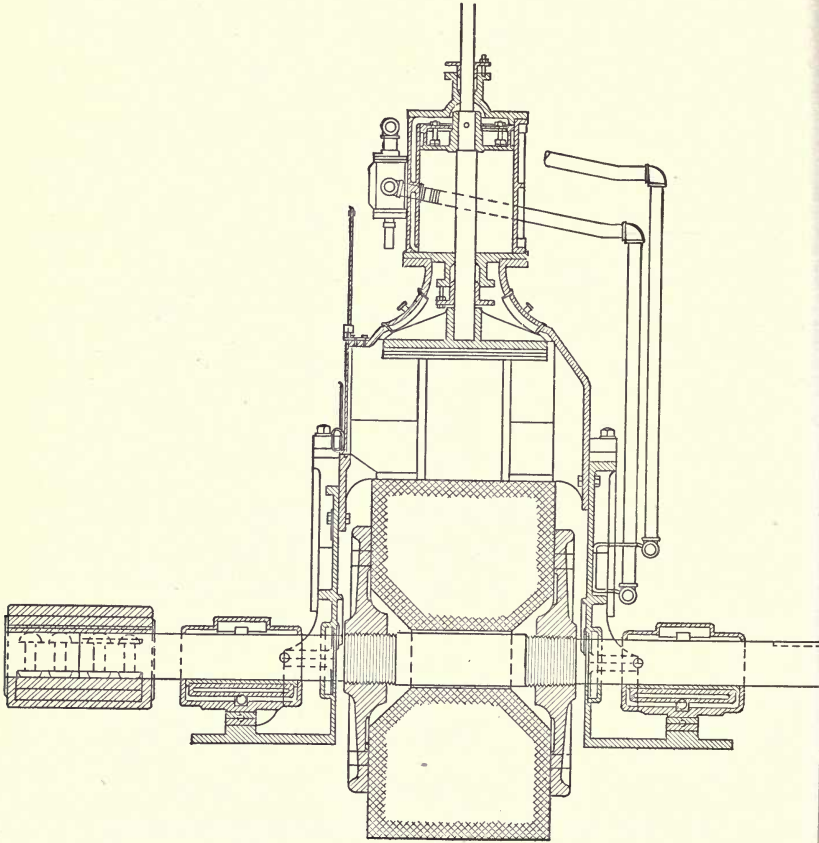

FIG. 32. THREE-POCKET GRINDER SECTIONAL ELEVATION

per cent dry. It is desirable that the diluted stock be passed through a riffler or over a sand settler before going to the screens as much wear on the latter is thus avoided. The screened stock is then thickened to the proper consistency for use in the beaters by means of filters, wet machines, or some other equiva-

lent device, or if it is to be sold in the form of "laps" these are made on a wet press.

The chief factors which enter into the production of mechanical pulp from any species of wood are:

(1) Surface of stone; whether rough or smooth, sharp or dull, or of coarse or fine grit.

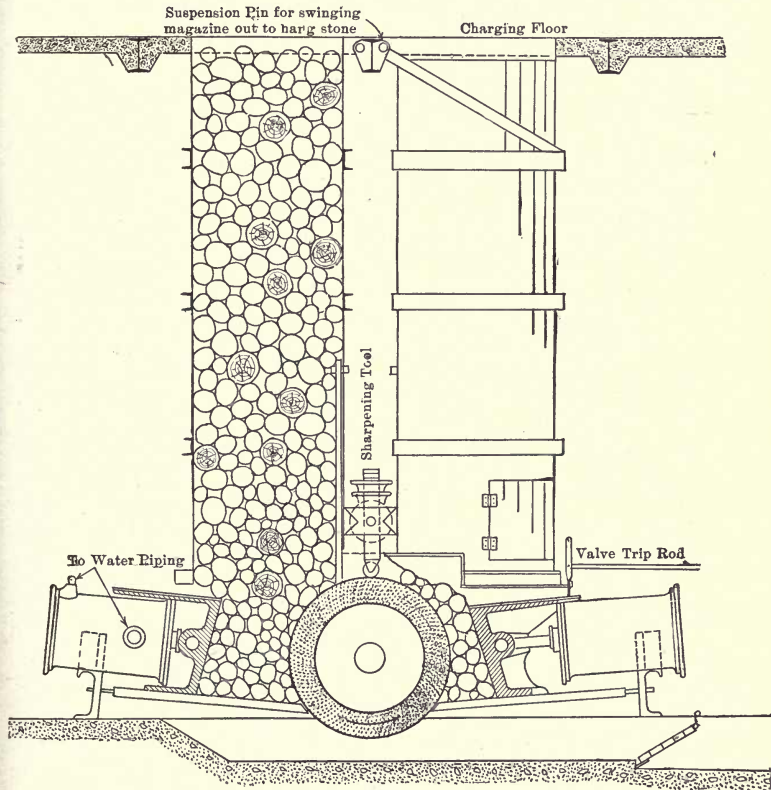

FIG. 33. VOITH MAGAZINE GRINDER

(2) Pressure employed in forcing the wood against the revolving stone.

(3) Peripheral speed of the stone.

(4) Temperature of grinding and thickness of stock in the grinder pit.

(5) Physical condition of the wood.

The condition of the surface of the stone depends on several factors among them being the size and sharpness of the individual particles of grit, the ease with which the binding material wears away and the manner of dressing the stone. This latter operation is performed by working across the face of the stone small steel rolls or burrs of various designs which roughen the surface and form depressions through which the ground wood can escape. A great deal of attention has been given to the designing of these burrs but it appears that practically the same quality of pulp can be obtained under like conditions of pressure, speed and temperature if the surface is brought to the same condition of sharpness of grit, regardless of whether the design of the markings is straight cut, spiral or diamond point. The important thing, so far as quality is concerned, is to give the particles of grit the correct treatment, rather than to form a deeply grooved surface.

The horsepower per ton of pulp varies inversely with the sharpness of the stone, while the production varies directly with the sharpness. Immediately after sharpening a stone, therefore, the rate of production is high and the power consumed low, while as the stone becomes dull the former decreases and the latter increases. The condition of the surface of the stone appears to have very little influence upon the yield per cord unless it has been made so extremely sharp that more screenings are formed and possibly more fine fibre lost in the white water. With such a surface the fibres are actually ground to pieces and in some instances they are so short and fine that it is almost impossible to remove the lap from the wet machine press roll. Deep grooving of the surface of the stone causes more rapid production of pulp but at the expense of quality, while better pulp is produced by a less sharp stone and a greater application of power. Paper prepared from this latter pulp has greater strength than that from pulp ground on very sharp stones.

Next to the surface condition of the stone the factor most influencing quality is the pressure at which the wood is forced

against the stone. For any given cylinder pressure this varies greatly with the length and diameter of the logs, and further variations are caused by the binding of the wood in the pockets and by fluctuations in the water pressure when the pistons are raised or lowered. The result of increasing the pressure is to increase the power required by the grinder and decrease the power consumption per ton of pulp made. This latter effect is less noticeable on sharp than on dull stones. This result is interesting because it suggests that by carrying a high pressure and using only part of the pockets the power consumption per ton can be reduced, or in other words these conditions permit the production of a larger quantity of pulp during times of low water, without sharpening the stone to an unusual degree.

It has been found that the yield of pulp per 100 cu. ft. of solid wood increases with increase of pressure. The screenings also increase, but not so fast as the total yield so that there is a net gain of good fibre. The strength factor, or the bursting strength per square inch divided by the weight per ream, which indicates the quality of the pulp, decreases quite rapidly with increasing pressure.

The peripheral speed of the stone is given little attention in most commercial plants. When the pressure on a pocket of the grinder is removed the speed increases greatly, which counteracts to a certain extent the decreased production due to the smaller number of pockets in use. While this is rather beneficial than otherwise there are conditions of operation which require a fairly constant speed, and the use of a governor is therefore desirable. As would be expected the power to the grinder varies directly with the speed; this is also true, and to an even greater extent, of the production in twenty-four hours. With constant power to the grinder the production in twenty-four hours is practically constant, regardless of whether the pulp is produced at low pressure and high speed or at high pressure and low speed. The strength of the paper is greater with pulp produced at high pressure and low speed than with that made at low pressure and high

speed. The yield per cord and the quality of the pulp are only slightly influenced by the speed.

The effect of the temperature at which mechanical pulp is produced has long been a controversial point between European and American manufacturers. The general American practice is to operate at high temperature and it is claimed that pulp so produced has longer and stronger fibres, is considerably tougher than cold-ground pulp and works "freer" on the paper machine. Cold-ground pulp, on the other hand, is said to be finer, more free from shives and to give a better closed sheet of greater opacity than hot ground pulp.

Another factor which is claimed to have an important influence on the paper produced is the thickness of the pulp in the grinder pit, and in actual operations this varies from extremely thick to comparatively thin.

Investigation of these two points shows that varying the temperature from hot to cold has little effect upon the power consumption or power to grinder, but the production in twenty-four hours is somewhat higher when grinding hot. With thick stock in the grinder pit the power required to rotate the grinder without load is greater than with thin stock, but the difference, when calculated to the basis of power consumption per ton of pulp, becomes negligible. Neither of these two factors of temperature and thickness of stock influences the yield per cord of wood. The quality of pulp, however, is affected, that produced at high temperature being long-fibred, while a fine-fibred stock is more easily secured by the cold grinding process.

The physical condition of the wood, apart from any changes induced by boiling or steaming, has a very appreciable influence on the results obtained. For green wood the average power consumption is lower than for seasoned wood while the rate of production is higher. The diameter of the bolts used and the rate of growth of the wood have very little effect upon either the power consumption or the rate of production. Rapidly grown wood, as compared with that which has grown slowly, yields considerably less pulp which is softer though of about the same

strength as that from slowly grown trees. It is generally recognized that green or freshly cut wood gives a better product than seasoned wood, and in the case of white fir McNaughton¹ has shown that pulp from young trees 18 ins. or less in diameter is whiter and stronger than that from old trees of about 40 ins. diameter.

The commercial efficiency in converting rossed wood to pulp under ordinary conditions averages about 88 per cent. Of the remaining 12 per cent about 2 to 7 per cent is lost as screenings and in the white water as wood fibre, while the remaining 5 to 10 per cent must be in the white water as water soluble organic or inorganic materials.

The changes induced by boiling or steaming the wood before grinding very profoundly influence the product obtained. The color of the pulp is darker than that from unsteamed wood and the fibres are much longer and better separated, resulting in a stronger product. The changes in color and physical character of the pulp are practically identical, provided the temperature and duration of the cooking are the same, whether the logs are steamed or boiled while immersed in water. Steaming has the advantage over boiling in that less heat is necessary and the condensed liquors are drawn off in concentrated form which is a benefit where recovery of by-products is attempted. As soon as steaming starts the formation of acid commences and increases up to the end of eight hours treatment. Both acetic and formic acids are produced, in the ratio of six acetic to one formic. Spruce gives 0.213 per cent of acetic acid and pine yields similar amounts. After two hours steaming reducing sugars appear and eventually amount to about 0.25 per cent of the dry wood.

The pressure and duration of steaming are important factors to control since they have a great influence on the color, strength and yield of pulp. Increasing both time and steam pressure increases the strength of the pulp but makes it much darker in color while at the same time the yield is much decreased because of the greater solvent power of the water.

¹ Paper, Nov. 1, 1916, p. 13.

A study of the various factors in the grinding of steamed spruce wood has brought out a number of very interesting facts. The power required per ton of pulp is at least 25 per cent greater than that used in grinding untreated wood, and the maximum power per ton is reached when the wood is cooked for six hours. This holds true for cooking pressures between 0 and 75 lbs. gauge pressure. With the same length of cooking, wood which is treated at high pressure requires more power per ton of pulp than that which has been cooked at lower pressures, while with a fixed amount of power to the grinder the amount of pulp produced is less at high pressure and low speed than it is at low pressure and high speed.

The pulp made by grinding steamed wood can be used for different purposes, depending on the nature of the grinding process. If a sharp and coarse stone is used a large number of shives will be present and the pulp will serve for the manufacture of box boards or similar products. When ground to a finer state, and mixed with a small amount of chemical fibre a bogus kraft paper can be produced which will serve for a cheap wrapping paper. Tests on papers made from steamed and unsteamed woods show that the steamed pulps give a higher percentage of stretch than the unsteamed even though the latter are mixed with 20 per cent of sulphite spruce fibre. Like chemical pulps steamed ground wood is considerably influenced by beating treatments and variations in the latter cause marked variations in the strength of the paper. With prolonged beating the paper becomes more brittle but gives higher strength tests.

The boiling or steaming of wood results in the formation of a natural size from some of its constituents and this sizing action is particularly noticeable in the production of pulps from the hardwoods — birch and aspen — which are not naturally pitchy. All paper produced from cooked woods, pulped by the mechanical process, shows the characteristic water-resistant qualities and hardness of hard sized papers.

While spruce is the standard wood for the manufacture of mechanical pulp the supply of this wood is decreasing so rapidly

that some substitute must be found. With this end in view a long series of tests has been made on a practical scale by the Forest Service ¹ and the pulps made run into paper and tested for printing qualities on newsprint presses. The following table gives the common and scientific names of the woods used, the yield of bone dry fibre from 100 cu. ft. of solid rossed wood and the color rating, No. 1 being the best color and No. 23 the poorest.

Common name	Scientific name	Bone dry fibre per 100 cu. ft.	Color rating
		Lbs.	
Balsam fir.....	<i>Abies balsamea</i>	1910	9
Red fir.....	" <i>magnifica</i>	1915	20
White fir.....	" <i>concolor</i>	2000	10
Alpine fir.....	" <i>lasiocarpa</i>	2060	1
Amabilis fir.....	" <i>amabilis</i>	1870	13
Grand fir.....	" <i>grandis</i>	1950	5
Noble fir.....	" <i>nobilis</i>	1920	15
Eastern hemlock.....	<i>Tsuga canadensis</i>	2030	19
Western hemlock.....	" <i>heterophylla</i>	2160	22
Tamarack.....	<i>Larix laricina</i>	2620	21
Western larch.....	" <i>occidentalis</i>	2100	23
Lodgepole pine.....	<i>Pinus murrayana</i> ¹	1920	12
Lodgepole pine.....	" <i>murrayana</i> ²	2140	6
Western yellow pine.....	" <i>ponderosa</i>	2060	11
Jack pine.....	" <i>divaricata</i>	2200	14
Loblolly pine.....	" <i>taeda</i>	2500	7
White pine.....	" <i>strobus</i>	1885	8
Engelmann spruce.....	<i>Picea engelmanni</i>	2000-2250	3
Sitka spruce.....	" <i>sitchensis</i>	2100	18
White spruce.....	" <i>canadensis</i>	2400	2
Aspen.....	<i>Populus tremuloides</i>	2200	16
White birch.....	<i>Betula papyrifera</i>	2950	17
Black gum.....	<i>Nyssa sylvatica</i>	2600	4

¹ Wood from California.

² Wood from Montana.

In these trials very little difficulty was experienced in producing pulp from the woods tested. With the conifers grinding could be done under practically the same conditions employed for spruce. All the substitutes, with the possible exception of noble fir and amabilis fir, require the use of more power per ton of pulp than does spruce. The best results were generally obtained by grinding on a somewhat dull stone with high pressure and rather slow speed.

¹ Bull. No. 343, U. S. Dept. of Agriculture.

Of the woods tried all of the firs yield pulp suitable for newsprint purposes; hemlock gives a short fibre and much care is necessary in grinding; western hemlock is much superior to eastern. Tamarack gives a good quality of pulp except for its color which is grayish green, while western larch yields a very inferior pulp, shivey and of poor color. The pines yield pulp which could be used for newsprint work though there is a tendency toward softness. The one exception is loblolly pine which gives an inferior pulp which would find use only as a filler. Of the hardwoods aspen gives a satisfactory pulp if a large amount of power is employed in grinding. When mixed with spruce it operates very well. White birch yields a short, but very fine fibre, which has a pinkish tinge; it could be used as a filler in certain grades of paper. Black gum gives a fibre resembling in many ways that from white birch. It is very short but forms a tougher sheet than coniferous fibres of the same length. This pulp is not promising for newsprint paper but could be used as a filler or mixed with pulp of a better grade.

The ground wood process has received much attention from investigators with the object of producing fibre which could be used in making news paper without the addition of sulphite. Bache-Wiig¹ has patented a process whereby the blocks of wood are heated in a solution of salt and then ground as usual. As, in many cases, the salt does not penetrate the entire block the resulting pulp is a mixture of untreated and treated fibres. The claims for this process are that less power is required and the fibre is longer and stronger and of better color. According to another process² the wood blocks are placed in a digester which is partially evacuated, then treated under pressure with sulphur dioxide and finally cooked with water, salt solution or bisulphite liquor. Wood thus treated gives, on grinding, a pulp suitable for making news paper without the addition of sulphite.

Henckel³ proposes cooking the logs with a caustic soda solu-

¹ U. S. patent 913,679.

² Bache-Wiig: Paper, 1916, No. 21, p. 18.

³ Henckel: Austrian patent 34,816.

tion of 3° to 5° Bé. for three or four hours under pressure and then grinding as usual. The claims for this process are better fibre, less power and greater yield. It is difficult to see how the yield can be increased by treating with a solution having such strong solvent powers as a caustic soda solution.

A modification which has recently attracted much attention is that for producing white ground wood by the Enge process.¹ According to this process the logs are placed in a boiler which is then completely filled with water. The temperature is raised by direct or indirect steam to 176° to 257° F., steam is shut off and hot or cold water pumped in to raise the pressure to 147 lbs. or more, which is maintained for five to eight hours. The higher the pressure carried the higher can the temperature go; good conditions are 230° F., and six hours at 147 to 176 lbs. per square inch. Following this treatment the grinding is completed on ordinary stones as usual. The advantage of this process is somewhat doubtful, for although the pulp can be made into news paper alone, yet the extra cost for steaming, labor, etc., just about counterbalances the saving in cost of sulphite fibre.

With any method of grinding close control of the process is essential if a uniform product is to be made. A very simple method for obtaining such control is to examine the image of the fibres when thrown on a screen by means of a lantern. The pulp may be mixed with a little aniline dye so that a sharper image may be obtained. A little of the pulp is then placed between two glass plates in such a density that the individual fibres may be observed, and its image thrown upon a white screen. The best magnification is about 40 diameters and when enlarged to this extent it is very easy to tell the relative proportions of "fluff," long fibre, shives, slivers, etc. This method is in operation in one of the most progressive mills in Canada and is very highly recommended. Samples from each stone are examined every two hours and the condition of the stone and the work it is doing are thus accurately known, making it possible to sharpen the

¹ German patents 20,860 and 20,932, E VII, 55a.

stone when it is necessary and keep the pulp much more nearly uniform.

Another control test which is in actual use and is giving very good results is that of the sediment tester described by Fishburn and Weber.¹ In this test a mixture of 5 grams bone dry pulp and 500 c.c. of water is placed in a graduated tube with a woven wire bottom and the time required to drain down to a definite mark is noted. The standard time for news grade wood-pulp is 80 seconds and if it is ground in such a way as to give a test of 70 seconds trouble is experienced on the paper machine.

The bleaching of wood pulp cannot be performed by hypochlorites or other oxidizing agents since all the lignin and other incrusting matters are still present. Its color can be considerably improved by treating with sulphurous acid or a bisulphite. This is regularly done in European practice by moistening the pulp with a solution of sodium bisulphite as it is wound up on the press roll of the wet machine. According to Schutz² about 2 to 3 per cent is used. The action requires time and the color is not so bright as that of bleached chemical pulp. All woods are not equally susceptible to improvement in color by this process; hemlock and tamarack, for instance, are not so good as poplar and spruce.

¹ Paper, Oct. 11, 1916, p. 13.

² Schutz: Paper, Feb. 4, 1917, p. 64.

CHAPTER VIII

BLEACHING

All of the commercial processes for isolating the fibrous celluloses for paper making fail to produce a perfectly pure material since it is always associated with a small amount of the incrusting matter originally present in the raw material and generally also with coloring matters, which either escaped destruction during the process or were formed by it. The object of bleaching is the destruction or removal of such undesirable impurities so that the natural white color of the pure cellulose may become evident. The process of bleaching is essentially one of oxidation and the success attained depends on the fact that the accompanying impurities are attacked and resolved into soluble products much more easily than the comparatively inert cellulose of which the impure fibre is largely composed. Many different oxidizing agents can be utilized in the bleaching process and a number of them have been applied with more or less success, but practically all commercial work is performed by chlorine, or some of its compounds, which in the presence of moisture tend to liberate oxygen.

Chlorine. Chlorine is a greenish yellow gas, darkening in color as the temperature rises. It has a pungent and irritating odor and cannot be inhaled as it attacks the membranes of the throat and nose. Its atomic weight is 35.457 and a liter of it at 0° C. and 760 mm. pressure weighs 3.1691 grams. One volume of water at 15° C. and 760 mm. pressure absorbs 2.37 volumes of chlorine. At 15° C. and 6 atmospheric pressure it is converted into a clear yellow liquid of specific gravity 1.33, which is not miscible with water. When perfectly dry it does not attack iron, which enables it to be stored and shipped in

wrought-iron cylinders. Dry chlorine is also devoid of bleaching properties as may be shown by passing the dry gas over a piece of litmus paper, or a cloth dyed a delicate shade; so long as moisture is absent no bleaching action takes place, but on the addition of water the color is at once destroyed.

Gas Bleaching. In bleaching with chlorine gas the material to be treated must be placed, while in a moist condition, in a receptacle which is capable of being tightly closed. It is then subjected to the action of the gas, either generated by means of manganese peroxide or obtained from some other source. If the material to be bleached is very shivey, gas bleaching materially assists in the production of clean stock as it tends to resolve the woody matter more completely than does bleaching powder solution. It is also very efficient in removing metallic particles. Gas bleaching has in the past been applied to rag and rope stock, wood pulp, straw, etc., but little information is available to show how much of the gas is actually used up in the bleaching. Beadle and Stevens¹ cite a case of a cotton rag half-stuff which normally required 12 per cent of bleaching powder but in which a better color was produced by treatment with 2 per cent of chlorine followed by 2 per cent of bleach. In this case 2 per cent of chlorine replaces 10 per cent of bleaching powder, or is equivalent to 3.5 per cent of chlorine in the form of bleaching powder. Experiments by the author on a sample of soda hemlock which could not be satisfactorily bleached with hypochlorite solution showed that 4 per cent of chlorine followed by 5 per cent of bleach gave a good color and that in this case 2 per cent of chlorine was equivalent to 3 per cent in the form of hypochlorite. In spite of its good bleaching efficiency the process is seldom used because of the difficulty of maintaining tight apparatus and the general inconvenience involved; it is never employed in this country.

Hypochlorites. When chlorine is passed into an aqueous solution of an alkali, or alkaline earth, a hypochlorite or hypo-

¹ J. Soc. Chem. Ind., 1914, p. 727.

chlorous acid is formed according to the equations:

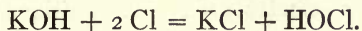

If it is passed into a suspension of calcium carbonate, hypochlorous acid only is formed:

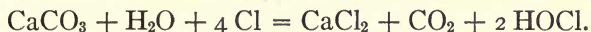

The first bleaching compound known, eau de Javel, was made in 1789 at the Javel works near Paris by passing chlorine gas into a solution of crude potassium carbonate. In 1798 Tennant patented a bleach liquor prepared by passing the gas into caustic soda or milk of lime and this method is still very largely employed where chlorine can be produced cheaply and the bleach solution used on the spot.

According to Higgins¹ hypochlorites and hypochlorous acid bleach because of their readiness directly to produce oxygen and to a lesser extent because of the generation of nascent chlorine. As the bleaching with hypochlorous acid proceeds, hydrochloric acid accumulates and reacts with the hypochlorous acid according to the equation, $\text{HOCl} + \text{HCl} = \text{H}_2\text{O} + \text{Cl}_2$. When a hypochlorite is used the acid formed is used in liberating more hypochlorous acid. It has been shown experimentally that the removal of free hydrochloric acid from either hypochlorous acid or chlorine water by means of calcium carbonate results in an acceleration of the bleaching action. Higgins² has also shown that the addition of calcium, barium or sodium chloride, or of sodium or potassium fluoride to a hypochlorite solution causes an initial increase in rate of bleaching, but that this acceleration soon ceases and the normal rate of bleaching ensues. This action is due to the formation of nascent chlorine: $\text{HOCl} + \text{NaCl} \rightleftharpoons \text{NaOH} + \text{Cl}_2$. The calcium chloride formed during the action of the bleaching powder is negligible but when calcium chloride is added during the process it always has

¹ J. Soc. Dyers and Colorists, 1914, 30, 326.

² J. Soc. Chem. Ind., 1913, 32, 350.

a stimulating effect. This effect of adding salt probably explains in part the claims for greater efficiency which many observers have made for electrolyzed salt solutions since the latter always contain a large proportion of undecomposed chloride.

Bleaching Powder. The bleaching solutions first prepared by Tennant proved difficult to keep and transport and in 1799 he introduced a great improvement by absorbing chlorine gas in slaked lime, thus forming bleaching powder, which is still the most important commercial bleaching agent.

The quality of the lime used in making bleaching powder is of importance, a fat lime which slakes quickly and gives a fine, light powder being most suitable since it absorbs the gas more quickly and gives a better keeping powder than a poorer lime. Careful slaking is essential since the total moisture in the chlorine and the lime should be about 28 per cent or about 4 per cent over that necessary to give calcium hydrate, $\text{Ca}(\text{OH})_2$. Well-made bleaching powder should be a pure white powder which, if of high strength, may contain some lumps. These, however, should be of the same quality as the powder and should not contain hard cores of calcium hydrate. In the air it absorbs moisture and carbon dioxide and is finally converted into a sticky, grayish mass. According to Lunge the composition of

bleaching powder is best expressed by the formula, $\text{Ca} \begin{matrix} \text{Cl} \\ \text{O Cl} \end{matrix}$.

On dissolving the powder this is changed into CaO_2Cl_2 and CaCl_2 .

The value of bleaching powder depends on the percentage of chlorine present as hypochlorite, or, as it is generally expressed, "available chlorine." Bleach made in cold weather may contain as much as 38 per cent available chlorine but in hot weather it is at times difficult to prepare it with even 35 per cent. In laboratory experiments it has been made with as high as 43.1 per cent available chlorine. The powder gradually loses strength, even in the absence of air, while the presence of air, moisture or heat causes it to deteriorate much more rapidly. The shaking

incident to transportation also causes more loss than would occur under normal conditions of quiet storage, hence the strength is usually guaranteed only at the place of shipment. In 1886 Pattinson¹ completed a very careful series of tests to show the deterioration of bleaching powder. He stored three casks of bleach in a cave and tested them at intervals of a month for eleven months, at the same time keeping a record of the temperatures by means of maximum and minimum thermometers. This record shows the temperature to have been comparatively low and quite uniform during the entire period, the highest being 62° F. and the lowest 38° F. Tests of the samples taken from the casks showed a gradual and regular loss of available chlorine which at the end of the investigation amounted to about 3 per cent. The complete analysis of each of the cask samples at the beginning and end of the experiment is given in the table below:

	Jan. 29, 1885			Jan. 5, 1886		
	A	B	C	A	B	C
Available chlorine.....	37.00	38.30	36.00	33.80	36.10	32.90
Chlorine as chloride.....	0.35	0.59	0.32	2.44	2.42	1.97
Chlorine as chlorate.....	0.25	0.08	0.26	0.00	0.00	0.00
Lime.....	44.49	43.34	44.66	43.57	42.64	43.65
Magnesia.....	0.40	0.31	0.43	0.31	0.36	0.38
Silicious matter.....	0.40	0.30	0.50	0.50	0.40	0.50
Carbon dioxide.....	0.18	0.30	0.48	0.80	1.48	1.34
Alumina, ferric oxide and oxide of manganese.....	0.48	0.45	0.35	0.40	0.40	0.37
Water and loss.....	16.45	16.33	17.00	18.18	17.20	18.89
	100.00	100.00	100.00	100.00	100.00	100.00
Total chlorine.....	37.60	38.97	36.58	36.24	37.52	34.87

It is seldom that bleach can be stored for any length of time at a temperature as low as 60° F., especially during the summer when the greatest loss of strength is likely to take place. It should, however, be kept in as cool and dry a location as possible and any damaged casks should be used first as

¹ J. Soc. Chem. Ind., 1886, 587.

the consequent exposure of the powder permits more rapid deterioration to take place. Another factor which has a considerable influence on the rate at which the powder loses strength is the quality of the cask in which it is packed. The best casks are those made from oak staves which are about an inch in thickness. Lighter staves and other woods are often used but soft woods which shrink badly when exposed to the sun should be avoided as they permit entrance of moisture if the casks are subsequently exposed to rain. In recent years the powder is often packed in thin, sheet-iron drums which have been found to give fairly good satisfaction. As these are not intended for refilling they are made as thin as is consistent with sufficient strength for handling and they are therefore lighter and occupy less space than wooden casks. Such drums will, however, rust through in time and allow the bleach to deteriorate.

The preparation of bleaching powder solutions has been carefully studied by Carey and Muspratt.¹ They found that long agitation of the powder with water caused slow settling and a larger volume of sludge and that the solution of the calcium hypochlorite was as complete with twenty minutes agitation as it was in a longer time. The temperature was also found to exert an important influence as at higher temperatures the settling was more rapid and the volume of sludge less. It was found safe to prepare solutions at 90° F., but 75° to 80° F. was considered better practice. The sludge, after drawing off the strong bleach solution, should be given a washing by filling the tank with water, agitating a few minutes and again allowing it to settle. The weak liquor thus prepared may be used to dilute the strong first liquor or for mixing with another charge of powder. The strength of solution usually prepared is 4.5° to 5° Bé., this together with the washings gives a liquor of about 3° Bé. which is a satisfactory strength for practical work.

The sludge, or residue, from dissolving bleaching powder consists almost entirely of calcium hydroxide but it is not possible to remove the last traces of available chlorine without excessive

¹ J. Soc. Chem. Ind., 1903, 674.

washing. With careful work such losses should not be over 0.3 to 0.4 per cent. The sludge should be tested for available chlorine at frequent intervals as considerable loss may occur if the washing is incomplete. The volume occupied by the sludge will necessarily vary with different powders and different methods of dissolving but under normal conditions it should not exceed 5 cu. ft. per 100 lbs. of powder.

A solution of bleaching powder is subject to decomposition of a nature similar to that taking place in the powder itself. This change is hastened by heat, light and air. Lunge and Landolt¹ examined the stability of bleach solutions and found that when kept in the dark and away from air no change took place in 24 days and only a very slight change at the end of 33 days; when stored in the dark, but in open vessels, one-eighth of its strength was lost in 33 days and when kept in diffused daylight 75 per cent of its strength was lost in the same time. Presence of acid or excess chlorine, or exposure to direct sunlight causes still more rapid decomposition. Tests by the author on a very strong bleach solution — 82 grams available chlorine per liter — prepared by absorbing chlorine in milk of lime, showed that when kept in a flask covered loosely with a watch glass and exposed to diffused daylight only 2 per cent of its strength was lost in eight days. Higgins² has compared bleaching-powder solutions with those prepared electrolytically, and with sodium hypochlorite prepared by treating bleach solution with soda ash, and found all equally stable. All of these investigations point to the desirability of storing bleach solutions in tall, narrow tanks, where they will be exposed to light as little as possible.

The action of bleaching powder solutions on metals has been studied by White.³ He found that antimony and cadmium were not attacked, lead and zinc were acted on only very slowly because of impurities such as iron and arsenic, while aluminum

¹ Chem. Ind., 1885, 343.

² J. Soc. Chem. Ind., 1911, 185.

³ J. Soc. Chem. Ind., 1903, 132.

was acted on very slowly in wire form but rapidly when present as filings. Nickel and iron were rapidly attacked with evolution of oxygen and formation of the respective hydroxides, while copper was slowly attacked and tin very slowly, about one-twentieth of the rate of action on iron. The author's tests on strong bleach solutions showed that in five days the presence of metallic zinc in contact with the solution caused a loss of 10.5 per cent of the available chlorine while lead caused a loss of 3.6 per cent and ferric oxide 6 per cent. Solutions of similar strength kept for the same length of time away from contact with all metallic substances lost none of their available chlorine.

Where electric power is available bleach solutions are often prepared by electrolyzing a strong salt solution and absorbing the chlorine in milk of lime. Such solutions have all the properties of those made by dissolving bleaching powder. If a sufficient excess of lime is used and the temperature is not allowed to rise too high it is possible to prepare solutions containing 250 grams per liter of 35 per cent bleach with 96 per cent of the chlorine in the available form. Such solutions are of course too strong to use in actual bleaching operations but they are economical of storage room and may be shipped to considerable distances in tank cars. In cold weather very strong solutions of bleach occasionally deposit a considerable quantity of crystals which consist of solid calcium hypochlorite. Some of this solid hypochlorite is also present in the mud which separates during the preparation of solutions containing 225 grams per liter, or more, of 35 per cent bleach. This crystalline form is very unstable and its preparation has never proved practical or desirable. In preparing strong bleach solutions there is occasionally a lot which turns pink. This was formerly supposed to be due to the presence of manganese but Tarugi¹ claims that it is caused by iron and has succeeded in causing it by warming a bleach solution to which a little soluble iron salt has been added. Elledge,² on the other hand, has proved that

¹ Chem. Centr., 1905, 584, 1902, 718.

² Elledge: J. Ind. Eng. Chem., 1916, 8, 780.

it can be caused by traces of manganese and it seems probable that it may be caused at times by either one of these substances.

Electrolytic Bleach. Besides the various calcium hypochlorite solutions there are numerous devices for the electrolysis of salt solutions and the direct application of the sodium hypochlorite solutions thus obtained. The most celebrated of these is the Hermite process which originally employed a solution of magnesium chloride but in which salt was later used almost exclusively. According to this plan the solution was first electrolyzed and then passed through the material to be bleached and back to the electrolyzer, thus keeping up a continuous circulation. This continuous process can only be applied to rag stock as the impurities dissolved in bleaching esparto or chemical wood pulp soon contaminate the solution to such an extent as to interfere with its proper operation. The Hermite process is probably not used in this country.

Many other schemes for the use of electrolyzed salt solutions have been proposed and much has been said about the superior bleaching power of a pound of chlorine thus prepared over the same quantity in the form of bleaching powder solution. While these claims are undoubtedly made in good faith it seems probable that many are based on incorrect comparisons since tests of efficiency by bleaching for a given time and determining the residual bleach are not accurate unless exactly the same colors are produced. Ahlin¹ states that it is not true that active chlorine produced electrolytically will do more work than an equal quantity from bleaching powder, and Dorenfeldt² claims that unless brine is to be obtained almost free of cost or unless sodium carbonate is worth no more than quick lime an electrically prepared bleach liquor (sodium hypochlorite) cannot possibly compete with bleach obtained from an electrical chlorine-soda process.

There have been proposed from time to time other bleach liquors formed by the addition of magnesium, aluminum or

¹ J. Soc. Chem. Ind., 1902, 718.

² Papier Ztg., 1903, 215.

zinc sulphate to a bleaching powder solution. These have the advantage of rapidity of action and except for their high cost would be useful in bleaching paper stock. The action of magnesium hypochlorite is purely oxidizing and it seems to have no tendency toward the formation of chlorinated products, while calcium hypochlorite shows this tendency quite strongly, especially when acid is used. Because of their cost these solutions are practically never used except in isolated cases where perhaps a little alum is added to the beater to hasten the action.

Principles of Bleaching. The general principles governing the practical application of the bleaching process have been carefully worked out by numerous investigators, who have studied among other factors the influence of concentration of stock, temperature of bleaching, and the accelerating effect of acids, air, beating, etc.

The concentration of the stock when bleached is held by Baker and Jennison¹ to be one of the most important factors. This is doubtless true when the bleaching is conducted by adding an excess of bleach and removing the unused part at the end of a certain time. Under these conditions the proportions of stock and water would certainly exert a considerable influence on the color produced and the old saying "more water, more bleach" would hold good. If, however, a definite amount of bleach is added to the stock and the action allowed to continue until the bleach is exhausted then the amount of water used is practically without effect on the final color of the stock, though it has a great influence on the time required to use up the bleach. This is illustrated by tests on two sulphite fibres, one of which required 5 per cent and the other 13 per cent of bleach; when these were bleached at a concentration of one part of fibre in 140 parts of water they required 21 to 22.6 hours to exhaust while at a concentration of one part in 23 the same point was reached in 15 to 15.5 hours. The color was, however, practically the same in both cases.

The temperature at which the bleaching is conducted has a

¹ J. Soc. Chem. Ind., 1914, 284.

very pronounced influence on the results obtained, both as to color produced and time required in the operation. Cross and Bevan¹ state that esparto bleached at 0° to 4° C. uses only 80 per cent of the bleach consumed at 35° C. and gives an equal color. With sulphite spruce and soda poplar we have found that to exhaust a given amount of bleach at 40° C. required eight to nine times as long as it did at 65° C. This extra speed was gained, however, at the expense of color, for the inferiority of the samples bleached at 65° C. was so marked that it would have been necessary to use fully 5 to 10 per cent more bleach in order to bring them to the standard color. Simonsen² in working with a sulphate pulp found that 7 per cent of bleach was sufficient at 13° C. but that if the temperature were raised to 35° C. it required 9 per cent of bleach to give the same color. Schwalbe claims that temperatures over 30° C. are to be avoided as bleach is lost through transformation into chlorate; this is quite probably one of the chief reasons for the poorer color obtained at higher temperatures. The maximum temperature which it is safe to use is variously stated by different authorities at from 68° to 110° F. (20° to 43° C.). No hard and fast line can however be drawn since it is often a question of adjusting the temperature so that a certain output may be obtained from a given equipment. In such cases it may be for a time better policy to increase the temperature rather than replace or enlarge the apparatus though it is certainly true that if the temperature rises much above 35° to 40° C. an appreciable portion of the bleach will be wasted.

The effect of temperature on the time required for bleaching is well illustrated by the following results obtained in the author's laboratory on three different kinds of fibre.

¹ J. Soc. Chem. Ind., 1890, 450.

² Paper Trade J., Feb. 12, 1914.

Fibre	Bleach used for standard color	Hours required to exhaust bleach		
		At 65° C.	At 40° C.	At 20° C.
	Per cent			
Sulphite.....	13.0	1.50	12.0	192
E. B. sulphite.....	5.0	1.25	10.8
Soda poplar.....	11.5	1.33	13.0

The rate at which bleach is consumed is also shown in the following table which contains the results of tests by the author as well as by Sindall and Bacon.¹ The figures show the percentage of the added bleach which was consumed in the times noted.

Fibre	Soda poplar	Soda poplar	Soda ¹	Sulphite ¹	Sulphite ¹
Bleach added.....	11.5	11.5	11.7	14	8
Temperature C.....	40.0	12.0	18.0	18	18
Time in hours	Per cent of bleach consumed				
0.5	63.8
1.0	70.0	51.3	33.0	20
1.5	55.3
2.0	72.5	44.0	30	33
3.0	51.0	43
4.0	82.5	66.0	55	49
5.0	71.7	70.0	56
6.0	78	63
7.0	80.0	90	70
8.0	73.1
11.0	100.0	77.5
71.0	96.7

¹ The Testing of Wood Pulp.

Weight Lost on Bleaching. The loss in weight which all fibre undergoes on bleaching, because of the oxidizing and dissolving power of the bleach solution, is in accord with the observed facts regarding the influence of temperature. Since the higher temperature causes quicker action and gives poorer color due probably to chlorate formation it would be expected that the attack on the fibre would be less with a consequent smaller loss in

¹ The Testing of Wood Pulp.

weight. That such is the case is proved by the following results of experiments in which the fibre was bleached at different temperatures but with the same amount of bleach until the latter was completely used up.

Fibre	Percentage bleach used	Loss in weight due to bleaching		
		at 20° C.	at 40° C.	at 70° C.
		Per cent	Per cent	Per cent
Sulphite.....	13.0	2.31	2.27	1.97
E. B. sulphite.....	5.0	1.89	1.66	1.11
Soda poplar.....	11.5	1.89	1.64

If the fibre is treated with an excess of bleach, which is not all used up when the desired color is reached, then an increase in temperature would be expected to increase the loss in weight and Simonsen¹ has found this to hold true in the case of a sulphate pulp which lost 4.5 per cent of its weight when bleached at 20° C. and 6.1 per cent at 30° C.

The amount of bleach used exerts a great influence on the loss in weight during the process and the chemical composition of the bleach solution probably also has a considerable effect. It is hardly to be expected that sodium, magnesium and calcium hypochlorites would all cause the same loss in weight and the presence of alkali or acid during the process would certainly have an influence. With calcium hypochlorite the effect of increasing the amount of bleach used is illustrated by the following data:

Fibre	Per cent 35% bleaching powder used	Loss in weight due to bleaching
		Per cent
Sulphite.....	13	2.27
".....	22	3.51
".....	32	5.06
E. B. sulphite.....	5	1.66
".....	15	3.59
".....	25	5.72
Soda poplar.....	11.5	1.94
".....	20.5	3.69
".....	30.5	8.03

¹ Paper Trade J., Feb. 12, 1914.

This has an important bearing on the cost per ton of bleached fibre, since in the production of very white stock not only is the amount of bleach increased, but the loss during the process also rises so that more fibre has to be used to produce a ton of finished product. In commercial fibres the loss due to the chemical

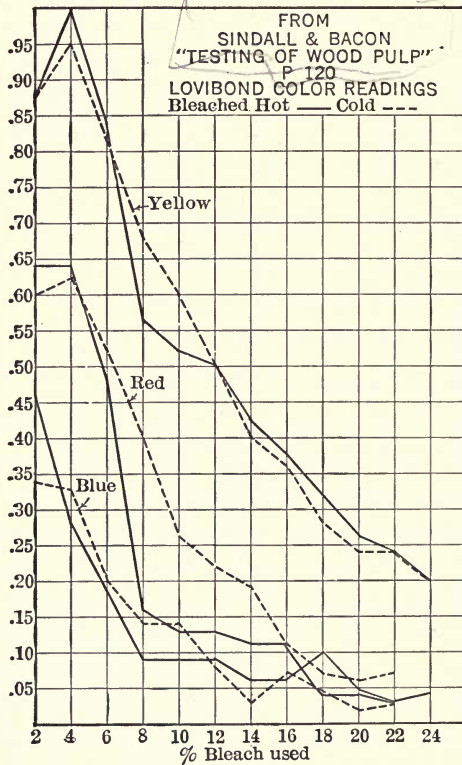

FIG. 34

action of the bleach may drop as low as 1 per cent for very easy bleaching stock or rise as high as 5 per cent for fibre taking 20 to 22 per cent of bleach. In one case where a fibre lost 12 per cent of its weight when bleached and washed it was discovered that it had been washed in the blow pits with sea water and that about one half of this loss was due to the soluble constituents left by the salt water.

The rate at which bleaching eliminates the color of sulphite fibre is shown graphically in Fig. 34, which is plotted from Sindall & Bacon's book on the Testing of Wood Pulp. The measurements were made by means of Lovibond's tintometer on samples of pulp which had been treated with progressively larger amounts of bleach. This shows very plainly the comparatively rapid disappearance of the red and blue and explains why bleached pulp generally has a slightly yellowish tone.

No very positive statement can be made in regard to the bleach required by various classes of paper making fibres since it depends so largely on the way the unbleached fibre was prepared as well as on the bleaching method employed and on the color obtained. At the present time the following figures are approximately correct:

	Per cent
Rags.....	2-5
Sulphite spruce.....	5-20
Soda fibres.....	8-15

Use of Backwater. The character of the water used in breaking up the pulp preparatory to bleaching has an appreciable influence on the amount of bleach required. In many cases it has been recommended, and has been the practice, to use the water drained from the bleached pulp to make up another charge for bleaching. This is not to be recommended since it is attended with an increase in bleach consumption and a lowering of the color of the pulp. The greater bleach consumption is caused by the organic matter in solution or suspension, which continues to use up bleach when further portions are added. In a number of tests by the author this "yellow water" removed from engines of bleached pulp which were originally furnished entirely with fresh water was found to use up for each liter of water from 0.94 gram of 35 per cent bleach in six hours to 1.53 grams in eighteen hours at 35° C. Since the ratio of water to stock was 30 : 1 in these tests it is evident that this bleach consumption would be equivalent to 2.8 per cent to 4.6 per cent of bleach on the weight of the fibre. Sindall and Bacon¹ found that at 32° C. the bleach

¹ Testing of Wood Pulp.

used up by this residual liquor was 35.5 lbs. for 10,000 lbs. of water while at 49° C. it amounted to 112 lbs. These quantities would be considerably increased if the water were used over and over, thus permitting an increase in the concentration of the organic matter. The use of "back" or "yellow" water for furnishing the unbleached stock is therefore to be recommended only when it is comparatively rich in unused bleach and when the products of its action can be washed out before the final bleaching is commenced, as under any other circumstances its use is likely to cost more than it saves. An intermediate washing to remove the soluble products formed by bleaching is beneficial as it enables a better color to be produced than would otherwise be possible, especially with hard-bleaching pulps. When one-third of the bleach is used up before such washing and the rest afterward it has been found in actual practice that about 90 lbs. of bleach gave the same results as 100 lbs. when all is added at once.

The bleaching of paper stock is performed in engines, chests or drainers according to the equipment available or the personal preference of the operator. Rag stock is most often treated with the bleach solution in the engine and then emptied into large tanks or chests provided with false bottoms. In these the bleaching is completed and the exhausted bleach solution then allowed to run away; the stock may then be treated with dilute sulphuric acid to still further improve the color and finally washed with water. The process may be hastened by heating the contents of the beater, best before the bleach is added, since otherwise it is likely to cause local overheating with loss of bleach and formation of oxycellulose. Addition of acid also hastens the bleaching by liberating hypochlorous acid which is more vigorous in its action than hypochlorite. A number of acids have been proposed for this work, from sulphuric to acetic or even carbonic which it has been proposed to lead into the beating engine just under the roll. The known accelerating influence of agitation or beating is due doubtless in part to the presence of carbonic acid in the air. Only a small amount of acid should be used, as it is constantly regenerated, and it should be added in a

highly dilute condition as strong acid tends to liberate chlorine and cause the production of yellow chlorinated products. Treatment with acid is especially useful in bleaching shivey flax or linen and in treating rags which have been boiled in alkali and hence have accumulated basic matters which might be injurious at some future stage.

Rags may also be bleached before reducing to half stock by washing the boiled rags and treating them in a tumbler with bleach solution; or they may be piled up in chambers and the warm bleach circulated through them. In the latter case they must be quickly drenched with cold water and transferred to the beaters as the fibres become tender if allowed to stand in contact with the bleach. Neither of these methods is so satisfactory as that of bleaching the half stock.

Systems of Bleaching. Bleaching systems in general may be divided into two classes, one a rapid bleach in which an excess of fairly strong liquor is added and the excess removed as soon as the stock has reached the desired color; the other a slower process, using only a very slight excess and allowing it to practically exhaust. The rapid bleach necessitates the use of the excess bleach liquor removed from the bleached stock, which has been shown to be uneconomical; it also requires more careful control since the higher temperature usually maintained and the stronger bleach solutions are more apt to cause oxidation of the cellulose and a consequent weakening of the fibre. The slower process is more economical of bleach but requires much more space for a given output and in the choice of a method the space available for the plant is frequently the deciding factor. In either method the amount of water used should be kept as low as possible since this saves both bleach and time. The proportion of water to fibre will necessarily vary with the type of apparatus employed but with large chests furnished with good agitators it should be not much greater than 30 to 1. If the bleaching is done entirely in engines somewhat less water can be used, while in the Belmer bleaching apparatus the stock may be run at $5\frac{1}{2}$ to $6\frac{1}{2}$ per cent density.

Recognition of the advantage of using as little water as possible is shown in Dobson's bleaching process in which the dry sheets of fibre are added to the bleach solution in a drum-like vessel which is then closed and rotated at two to four revolutions per minute for about three hours, when the bleaching is completed. The claims for this process are that it saves time, power and floor space and that the stock needs no washing or draining and is ready to use as soon as the bleaching is completed. While this process might be applied to wood pulp it is obvious that rags which have been cooked with lime could not be satisfactorily treated by it.

The bleaching of fibres prepared by the soda process, whether from esparto, straw or any of the numerous woods now used, follows in general the same course as rag stock. Since the alkaline cooking treatment gives a well reduced fibre with a tendency toward an alkaline or basic condition it is safe to use a little acid in the process. This is best added in a well diluted condition after a considerable part of the bleaching has taken place and even then it must be used with care as these celluloses are more easily attacked than cotton or linen. When the color of these fibres has reached the desired point the bleach residues should be quickly removed lest the stock "go back" in color; this is especially likely to take place if the temperature is much over 30° C. The removal of the exhausted bleach may be readily accomplished by running off the stock on some form of wet machine or on a press-pâte.

The treatment of sulphite fibre differs slightly from that accorded soda fibre since it has already a tendency toward acidity because of its method of preparation. Also it is usually not so thoroughly freed from lignin and incrusting matters as is soda fibre and hence is more liable to take up chlorine with the formation of yellow chlorinated compounds. As acid increases this tendency it is not generally used with sulphite fibre, though it may be successfully employed by adding it about an hour after the bleach, washing the bleached fibre, which is frequently orange colored, and rebleaching with 1½ to 2 per cent of bleach followed

by a little acid. This treatment is unnecessarily complicated as most sulphite which is cooked with the idea of making into bleached fibre can be satisfactorily treated in a single process. As with wood pulp prepared by the soda process bleached sulphite is very apt to "go back" in color, or turn yellowish, if it stands in contact with exhausted bleach liquors, especially at elevated temperatures. For this reason it is quite important that the temperature be kept as low as is consistent with the desired rapidity of bleaching and that the fibre be freed from bleach residues as soon as the process is completed.

In handling sulphite fibre it is frequently observed that a 'rose color develops on adding bleach. This is also caused by ferric chloride, potassium ferricyanide, mercuric chloride, potassium permanganate and potassium bichromate.¹ The exact reason for this phenomenon is not known but as the color produced is roughly proportional to the amount of bleach which the fibre requires it may be taken as giving an indication of the bleaching properties of the sample in question. This rose color is only transitory, as it disappears very quickly as the bleaching proceeds, and has no permanent effect on the color of the fibre.

Jute and manila fibres are particularly difficult to bleach since, in order to preserve their strength, they are generally only lightly treated with milk of lime and hence arrive at the bleaching process in a highly lignified condition. For this reason, and because the production of a high white seriously injures the strength of the stock, they are seldom bleached beyond a good cream shade. To hasten the action 4 to 5 per cent of alum is sometimes added but if the stock is heated this is particularly likely to cause the formation of yellow chlorinated compounds which defeat the object of the process. The bleaching of these fibres is usually conducted in the beater but in some cases they are dumped into drainers in which the last part of the bleaching proceeds slowly for several days. The chlorinated compounds mentioned, when treated with a solution of sodium sulphite, develop a strong magenta color. They are easily soluble in alkalis and may be

¹ J. Soc. Chem. Ind., 1896, 467.

removed from the fibre, by treating with a dilute soda-ash solution.

Ground Wood. The treatment of ground wood, or mechanical pulp, so as to improve its color, is a problem which has occupied the attention of many investigators. Since the ground wood contains all the constituents of the wood itself, except a very slight amount of water-soluble matter, it is obvious that any treatment with hypochlorite would be out of the question, since 40 to 50 per cent of the weight of the stock would have to be oxidized and dissolved before any good white color could develop. The first effect of adding hypochlorite to ground wood is the production of a red or brown shade which persists until nearly all of the incrusting matter has been destroyed.

The color of ground wood may be somewhat improved by treating it with sulphurous acid, or bisulphite solution. This cannot be considered a true bleaching process as the coloring matter is not destroyed but merely masked temporarily and the color returns on exposure to the air for some time. Considering the results obtained sulphurous acid is too costly and the reagent usually employed is calcium or sodium bisulphite. One method of treatment is to employ about 2.5 per cent on the weight of dry fibre, diluted with 20 to 30 times its weight of water, with which solution the fibre is flooded from below so as to drive out the air. After allowing to stand for some time the solution is washed out. Another procedure is to spray the fibre with bisulphite solution as it is taken from the wet machine and allow the whitening to take place in the moist laps. In this case no final washing is given.

Antichlors. It is very essential that the bleached stock going to the beaters should contain no active chlorine, which may readily be determined by means of iodide of starch solution. This may be prepared by boiling up a little starch with water and adding a few crystals of potassium iodide. A little of this test solution sprinkled on the pulp will, if the latter contains any bleach, develop a blue color varying from a faint color almost to a black according to the amount of bleach present. It is always

best to test the stock being bleached rather than the water squeezed from it since if much bleach is present in the latter it may destroy the blue, while if the bleach is nearly exhausted the liquor sometimes fails to give a test though the stock still shows its presence. The difficulties encountered and the time required in washing out the last traces of bleach from the pulp have led to the use of various chemicals to reduce and render harmless any which may remain at the completion of bleaching. Such chemicals, from the nature of the work which they perform, are called antichlors.

The one most commonly employed is sodium thiosulphate, $\text{Na}_2\text{S}_2\text{O}_3 \cdot 5 \text{H}_2\text{O}$, or "hyposulphite of soda" as it is generally called. This is added to the engine as a dilute solution after the stock has come to color. It acts on the bleach according to the following reaction:



in which the products formed are calcium sulphate, or "Pearl Filler," common salt and hydrochloric acid. According to Griffin and Little¹ if the solutions employed are very dilute the decomposition may take place in another direction as:

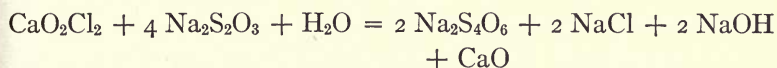

The products of either of these reactions are apt to exert a destructive influence on the machine wires and their presence in the paper is fully as serious as that of the bleach which they are intended to eliminate. The use of thiosulphate is therefore not to be recommended.

Safer antichlors to use are sodium sulphite, Na_2SO_3 , and calcium sulphite, CaSO_3 , which according to the reaction,

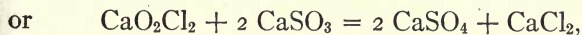
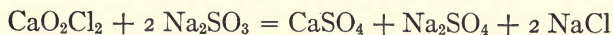

give products which are much less harmful than those from

¹ Chemistry of Paper Making.

thiosulphate. Because of the slight solubility of calcium sulphite the reaction in this case takes place rather slowly but it possesses the advantage that any excess acts as a filler and is in most cases quite harmless.

Other antichlors which have been proposed are the ordinary sulphite liquor used in the manufacture of wood pulp; the mixture of calcium thiosulphate and polysulphide prepared by boiling sulphur with milk of lime; and hydrogen peroxide. The first of these is a rapid and efficient antichlor and in many cases it tends to brighten, temporarily, the color of the fibre. It must be used with considerable caution as any excess tends to set up an acid condition in the pulp with consequent injury to wires, driers and even the paper itself. The lime-sulphur mixture is probably even more injurious, since a considerable amount of free sulphur is precipitated on the fibres during the reaction and this, because of its finely divided condition, is gradually oxidized to free sulphuric acid, which renders the paper brittle by reason of the formation of hydrocellulose. The free sulphur also causes tendering of the machine wires through formation of metallic sulphides. Hydrogen peroxide is the safest of all the antichlors since it forms only water and free oxygen. It is, however, too expensive for commercial use.

There are times when the use of an antichlor is of assistance but the regular employment of such an agent indicates inefficient bleaching methods since expense is being incurred in destroying a portion of the bleach which should be employed in doing useful work. In any well regulated mill it should be possible to eliminate the use of antichlors.

Washing Bleached Pulp. The washing of bleached pulp to remove chlorides and the products of antichlor action is generally considered very necessary if durable paper is to be made from the stock. While this is probably true with regard to excess of antichlor and may have some influence in the case of the chlorides formed by the reduction of the hypochlorite yet it is felt that for the general run of book and magazine papers too much stress is laid on this point. This opinion is based on experiments carried

out with very thoroughly washed soda and sulphite pulps, and with part of the same lots which had been only very slightly washed after bleaching. These conditions were chosen as representing the best and worst which were likely to occur in actual manufacturing operations. The two lots were beaten, sized and made into paper in the same way and pieces of the paper were then exposed to sunlight for three months and to temperatures of 80° to 90° C. for eight days. Neither of these tests showed greater discoloration in one case than in the other and both became brittle and unsized to about the same extent. The conclusion that slight washing is not likely to prove injurious to the durability of the paper is put forward with some hesitation as it runs counter to generally accepted theories but from the above experiments no other conclusion can be reached.

Washing will however improve the color of the bleached fibre by removing the yellow, soluble products of the bleaching action, and will, in large measure, prevent the brownish discoloration which is sometimes noticed on the edges of wet bleached pulp after storing for some time. According to Griffin and Little this is caused by the concentration of calcium chloride, due to more rapid evaporation on the edges, till it becomes strong enough to act on the fibre and form colored decomposition products. Our experiments with thoroughly washed, pure filter paper and a solution of chemically pure calcium chloride have shown that even relatively strong solutions fail to cause any discoloration even under very severe conditions of storage. The reason for these brown edges in commercial pulps is the incomplete removal of the soluble organic matter which is brought to the surface and edges of the pulp by capillary action and there concentrated by evaporation till its color becomes noticeable.

Permanganate Bleaching. Permanganate of potash has often been proposed as a bleaching agent in place of the hypochlorites, and all sorts of claims have been made regarding its alleged superior efficiency. In presence of acid permanganate reacts according to the equation

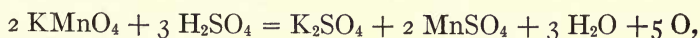

while in neutral solution the reaction taking place is

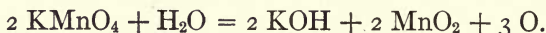

Since the presence of acid causes too powerful an attack on the fibre it is necessary to bleach in neutral or slightly alkaline solution.

Permanganate bleaching is extremely rapid and there is obviously no chance for the formation of chlorinated compounds. The permanganate should be added to the stock in dilute solution in order to avoid local formation of oxycellulose. When the bleaching has been completed it is necessary to remove the brown manganese peroxide by means of some reducing agent, most conveniently sulphur dioxide, or an acid sulphite. Beadle considers the sulphur dioxide to act as follows:

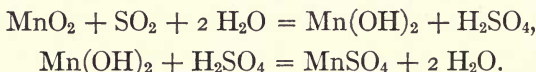

The Mn(OH)_2 being white is practically invisible and if the reaction goes no further may remain in the pulp and cause it to go back in color by absorbing oxygen and turning brown. All manganese peroxide should therefore be converted to the sulphate. As all the alkali formed during the reduction of the permanganate must be neutralized before the manganese peroxide can be dissolved it is evident that a considerable saving of sulphur dioxide can be effected by using some cheaper acid for this purpose.

Beadle found by experiments on rags¹ that one pound of permanganate did the same work as 10 lbs. of bleaching powder and concluded that the oxygen of the two substances acted quite differently. Our own experiments with sulphite and soda fibres show that in bleaching effect one pound of potassium permanganate is equivalent to 1.854 lbs. of 35 per cent bleaching powder, while according to the oxygen evolved one pound should equal 1.93 lbs of bleach. It is evident, in the case of chemical

¹ Chapters on Paper Making, Vol. II, p. 117.

wood fibres, that the oxygen evolved by the two substances has the same bleaching power.

The use of permanganate for conducting the entire bleaching process is more expensive than bleaching by hypochlorite and the necessity of acid for removing the manganese peroxide still further increases the cost. Even when the greater part of the bleaching is done by hypochlorite and the final treatment only is with permanganate the increase in cost is out of all proportion to the gain in whiteness. For these reasons permanganate is seldom employed in commercial work.

Sodium peroxide and perborates, persulphates, etc., have also been proposed as bleaching agents but they are never used in this country. In fact von Possanner¹ has shown that sodium peroxide is of little value for bleaching rag stock, since even when excessive amounts are used only a partial bleaching takes place. Moreover, if employed in too strong solutions, it attacks the fibre and forms oxycellulose.

Effect of Bleaching on Strength of Stock. The bleaching of paper stock induces in it a two-fold change since it affects both its physical and chemical properties. Experiments made by Froberg² led him to conclude that bleaching very greatly reduced the folding strength in comparison with that of paper made from the unbleached fibre. In nine samples of sulphite which he tested this reduction in strength varied from 29.8 to 62.7 per cent of the strength shown by the unbleached fibre. The breaking length was affected much less than the folding strength, being reduced by only about 7 to 12 per cent. A slight overbleaching was found to reduce the strength and durability of the paper to a still greater extent.

Our own very carefully conducted experiments entirely contradict those of Froberg. Starting with the unbleached fibre, samples were beaten and made into hand mould sheets under standard conditions. Portions of the same fibres were then bleached with two different amounts of bleach, the lowest being

¹ Wochbl. Papierfabr., 44, 3161.

² *Ibid*, 44, 3599.

that which would give a good standard white shade, and the bleached fibre beaten and made into sheets as before. The air dry sheets were then subjected to folding tests on the Schopper folder, and to bursting tests on the Ashcroft tester. The results on three different fibres are as follows:

Sulphite No. 1			
	Unbleached	13 per cent bleach	22 per cent bleach
Folding test.....	1.9	15.8	11.9
Ashcroft test.....	18.3	35.2	30.9

Sulphite No. 2			
	Unbleached	5 per cent bleach	15 per cent bleach
Folding test.....	2.9	15.0	4.4
Ashcroft test.....	21.1	34.0	32.4

Soda poplar			
	Unbleached	11.5 per cent bleach	20.5 per cent bleach
Folding test.....	1.5	0.0	0.0
Ashcroft test.....	21.3	20.2	9.2

With the sulphites the bleached fibres possess greater strength than the unbleached even when bleached to an extremely white color, while the strength of the soda fibre is reduced by bleaching. A partial bleaching with hypochlorite followed by permanganate was found in every case to give a stronger fibre than if the bleaching were carried to the same point by hypochlorite alone.

In this connection it is interesting to note the results obtained by O'Neill¹ on cotton cloth before and after bleaching. He

¹ Griffin and Little: Chemistry of Paper Making, p. 288.

measured the weight required to break a single thread with the following results:

	Before bleaching	After bleaching
	Grains	Grains
No. 1 cloth, weft threads.....	1714	2785
“ 1 “ warp “	3140	2920
“ 2 “ “ “	3407	3708
“ 3 “ “ “	3512	4025

In three out of four cases there is a distinct increase in strength due to bleaching.

In our opinion it is safe to conclude that the folding and bursting strength of sulphite is not injured by bleaching but that with soda poplar the bleaching process does occasion a loss in strength.

Effect on Chemical Properties. The two changes in the chemical properties of the fibre which are most likely to be caused by bleaching are the formation of oxycellulose and chlorinated cellulose. If acid is used hydrocellulose is also likely to be formed locally.

Griffin and Little¹ claim to have found between 5 and 6 per cent of chlorinated cellulose in a bleached sulphite pulp of good color, while Cross and Bevan² showed that during the bleaching of wood pulp and esparto chlorine combined with the residual non-cellulose constituents, forming chlorinated compounds some of which remain fixed on the fibres after washing. According to these statements the presence of chlorine in a bleached pulp would not necessarily indicate insufficient washing. Contrary to these opinions Schwalbe³ finds that when cellulose is bleached by hypochlorites, whether in acid or alkaline solution, the amount of chlorine which combines with the substance of the fibre is quite negligible. In the case of sulphite cellulose there is, however, a small quantity of chlorine

¹ Chemistry of Paper Making, p. 286.

² J. Soc. Chem. Ind., 1890, 450.

³ Chem. Ztg., 1907, 31, 940-941.

absorbed. Further work by the same author¹ was carried out with both calcium and sodium hypochlorite, in neutral and acid solutions and in industrial proportions and in excess. After bleaching the sulphite cellulose was washed, dried and carefully analyzed. The total chlorine in the bleached pulps from these tests varied from 0.051 to 0.114 per cent and of this 0.047 to 0.071 per cent was present in combination with organic matter, the rest being combined with the constituents of the ash. In spite of these figures Schwalbe concludes that no appreciable chlorination of the pulp takes place and that the products of bleaching are removed during the process of washing.

Besides the slight chlorination which may take place during bleaching there is a quite appreciable formation of oxycellulose. An approximately quantitative estimation of the amount of hydro- and oxy-cellulose formed may be made by determining the loss in weight of the thoroughly washed, bleached fibre when boiled in 0.25 per cent solution of caustic soda, or by means of Schwalbe's "copper number" method.² This latter method is a determination of the amount of copper reduced by the fibre on boiling with Fehling solution under carefully regulated conditions and the "copper number" is the number of grams of copper which would be so reduced by 100 grams of absolutely dry fibre.

Using the two methods to study the effect of various bleaching conditions the following data were collected from experiments on two samples of sulphite and one of soda. All figures are based on the materials as weighed out for analysis and are not reduced to a common basis.

These figures demonstrate that the more bleach used, and hence the whiter the product, the greater will be the attack on the cellulose itself. They also show clearly that permanganate causes much less oxycellulose formation than an equivalent quantity of hypochlorite.

¹ Z. angew. Chem., 1908, 21, 302-303.

² Z. angew. Chem., 23, 924 (1910), or *Chemie. der Cellulose*, p. 625.

		Copper number	Loss in weight on boiling with 0.25 per cent NaOH
			Per cent
Sulphite No. 1	unbleached.....	2.56	11.5
" " 1	13 per cent bleach.....	2.81	10.9
" " 1	22 " ".....	3.51	14.2
" " 1	32 " ".....	7.13	21.7
" " 1	{ 13 " KMnO ₄ } 5.4 " ".....	4.13	15.3
Sulphite No. 2	unbleached.....	3.18	13.0
" " 2	5 per cent bleach.....	2.36	10.2
" " 2	15 " ".....	4.99	17.4
" " 2	25 " ".....	7.99	25.2
Soda poplar	unbleached.....	0.72	1.5
" " 11.5	per cent bleach.....	3.04	10.5
" " 20.5	" ".....	6.70	22.0
" " 30.5	" ".....	10.30	27.7
" " { 11.5 " KMnO ₄ } 5.4 " ".....		4.20	13.4

By this same method of study Schwalbe has proved¹ that acid bleaching attacks cellulose more than alkaline, both in hot and cold bleaching. His results are:

	Copper number	
	Alkaline bleach	Acid bleach
Hot.....	2.86	3.54
Cold.....	2.77	4.23

In some commercial sulphites, particularly those which are slightly undercooked and hence hard to bleach, it is difficult to obtain the pure white which is desired and occasionally the attempt is made to mask the remaining yellow color by the careful use of blue. Any such improvement in color serves only to disguise the true value of the pulp and the practice should be strongly discouraged. The addition of blue can improve the color only when the bleached pulp has a yellow tint

¹ Wochbl. Papierfabr., 39, 2273.

as well-bleached pulps which have already reached a good degree of whiteness are made distinctly gray by the addition of blue and pink. If any considerable amount of blue has been added to the pulp it is generally quite noticeable, especially on looking through the suspected sample. When a smaller amount has been used its presence may usually be detected by rolling the sample into a tube and looking through it, in which case the multiple reflections of the light before reaching the eye intensify the color.

There is a tendency with all bleached fibres to change somewhat in color when kept for any length of time and while the alteration which takes place is slight and the chemistry of the process obscure, yet experiments have brought out some interesting facts. It has been shown that bleached sulphite which has been stored in well-seasoned hard-wood or tin receptacles hardly changes in color within six months, while similar samples stored in pine-wood boxes became somewhat yellower in the same time. Direct exposure to sunlight gives sulphite a reddish tone while if part of the sheets are protected from the light by black paper the portions thus protected become much yellower than the fibre before exposure. Soda fibre is more susceptible to these changes than sulphite and the more highly bleached the fibre the more rapidly it appears to deteriorate. These facts have a distinct bearing on the preservation of standard samples of bleached pulps and indicate the precautions which should be taken in studying the changes which take place on exposure to light.

Testing Bleaching Powder. In testing bleaching powder the first requisite is a fair sample. This should be obtained by boring a hole through the side of the cask midway between the ends or through the head near the centre, and inserting a sampler two or three inches into the bleach. The first sample should be rejected and the sampler again inserted as far as it will go, the sample thus obtained should be placed at once in a glass fruit jar which must be closed until the next cask is sampled. Every third or fourth package should be sampled, according to

the size of the shipment, but in no case should less than 20 per cent of the total packages be opened.

The sample should be well and quickly mixed, breaking up any lumps with a stout glass rod, and 10 grams weighed out, put in a porcelain mortar, a little water added and the mixture rubbed to a smooth cream. More water is mixed in with the pestle, allowed to settle a little while and then poured off into a liter flask; the sediment is again rubbed up with water, and the process repeated till the whole of the sample has been transferred to the flask and the mortar washed quite clean. The flask is then filled to the mark, thoroughly shaken and 50 c.c. at once removed with a pipette and placed in a beaker or cup.

To this solution is then added standard $\frac{N}{5}$ arsenite solution until a drop of the mixture taken out with a glass rod and brought in contact with potassium iodide starch solution gives no blue color. The percentage of available chlorine may then be calculated by the formula:

$$\frac{\text{cubic centimeters arsenite solution} \times 0.7092 \times 20}{\text{grams bleaching powder taken}} = \left\{ \begin{array}{l} \text{per cent} \\ \text{available Cl.} \end{array} \right.$$

The analysis may also be carried out by adding an excess of arsenite solution to the bleach and titrating the excess with standard iodine solution. This involves the use of another standard solution and is no more accurate than Penot's method as outlined above.

The standard $\frac{N}{5}$ arsenite solution is prepared by dissolving exactly 9.9 grams of the purest, powdered, sublimed, arsenious oxide in about 500 c.c. distilled water in which 40 grams pure sodium carbonate have been dissolved. In order to accomplish this it is necessary to heat the mixture on the steam bath. In spite of using the highest purity chemicals it is generally necessary to filter the solution, which is afterwards cooled and made up to a liter. The strength of this solution is best ascertained by titration against a standard iodine solution.

The starch-paste indicator may be made according to the following formula which has been found to give excellent results. Mix three grams of potato or arrow root starch to a thin cream with cold water and pour into 250 c.c. of vigorously boiling water. Cool, add a solution of 1 gram potassium iodide and 1 gram crystallized sodium carbonate and dilute to 500 c.c.

CHAPTER IX

SIZING

For some purposes papers are required to be porous and absorbent, in order to allow the passage of fluids, as in filter paper, or their rapid absorption as in blotting paper, but for most applications, which imply the use of ink of some kind, it is desirable that they be more or less non-absorbent. This is particularly essential in the case of writing papers which come in contact with very fluid inks, and in papers which are to be used for coating, and it is even considered of importance in printing papers though the nature of printing ink is such that good letter-press work can be done on an unsized or water-leaf paper. Since the absorbent power of paper depends on the capillary action of the fibre surfaces and on the spaces within and between the fibres, it is necessary, in order to make the paper non-absorbent, to coat the fibres with some substance which will offer resistance to the passage of ink. This object is accomplished by various methods of sizing. \

[The degree of sizing and the nature of the agents employed depend upon the use to which the paper is to be put. For news paper, on which the ink must dry very rapidly and almost wholly by absorption, the sizing must be slight so that capillary action may not be prevented; for book papers the sizing is usually harder than for news, not because the inks used are more easily absorbed, but because the sizing makes the paper more satisfactory for general service; for lithograph papers the sizing must be still harder because the paper becomes moistened during printing, while for writing papers on which very fluid inks are used the sizing must be particularly hard so that the ink may not spread and the lines become blurred.] In the days

of hand-made papers the sheets were sized by dipping them into a tub of gelatine solution and the process was known either as tub or animal sizing from the nature of this operation. A modified form of this process is still employed and as it consists essentially of the deposition of a layer of the sizing material on the surface of the paper it might well be spoken of as surface sizing.

This method of sizing is too slow and expensive for the great bulk of modern printing papers and for such other processes have been devised. Most of these depend upon the precipitation on the fibres of some material which on drying renders the sheet either repellent or resistant to moisture and as this operation generally takes place in the beating engine it is usually called engine sizing.

Surface Sizing. Numerous materials have been proposed from time to time for use in surface sizing but practically none are used in appreciable quantities except glue and starch and of these much more of the former is consumed than of the latter. For high-grade papers the best of glue, known as gelatine, should be used. These two terms are often indiscriminately applied, which is quite natural since gelatine may be considered as a highly purified glue which has been made with especial care.

Pure gelatine is a colorless, odorless, nearly transparent, nitrogenous substance which is insoluble in cold water but which swells and absorbs three or four times its weight when soaked in it. In hot water it dissolves readily and a strong solution sets to a firm jelly on cooling, even as little as 1 per cent giving a gelatinous mass. The purest commercial form of gelatin is isinglass which is made from the swimming bladders of various kinds of fish; below this in quality are the different grades of hide glue and still further down the scale are the bone glues. Many of the glues are excluded from sizing work because of their poor color and others because of their low gelatinizing power.

In most instances it is better for the paper maker to purchase a gelatine or glue of standard quality than it is for him to try

and make it. He is likely to get a more uniform product and moreover it is claimed that size made from air-dried glue is superior to that made from the original jelly. The gelatine which gives the firmest jelly is considered the best sizing agent and as a general rule the higher priced gelatines will be found the cheapest in the end because of their greater efficiency. A gelatine of high gelatinizing power gives a solution with a low specific gravity, while with low-grade glues the reverse is true.

The strength of solution used in sizing generally varies between 4 and 7 per cent and the temperature at which it is applied may range from 85° to 120° F. To this solution alum is frequently added to act as a preservative and aid in preventing spoiling of the sized paper in damp air. On adding the alum the glue solution thickens, and as the amount is increased it may almost form a jelly; strangely enough, however, if still more alum is added the solution becomes thin again and may even be more fluid than the original solution. This property offers a convenient means of controlling the penetration of the paper by the size, since this depends in part on the fluidity of the solution. The influence of alum added to the gelatin is shown in the following table¹ which gives the percentage of gelatine, based on the original dry paper, absorbed from a 5 per cent solution by papers sized with different amount of rosin.

Percentage of rosin size.....	0.0	0.5	1.0	1.5	2.0	2.5
Gelatine absorbed, no alum used.....	12.1	10.9	8.9	8.0	7.2	6.5
Gelatine absorbed, 8 per cent alum used	10.2	9.1	7.5	6.5	5.7	5.2

Another substance occasionally added to the size solution is soap, which is claimed to have a certain lubricating effect on the fibres, to improve the opacity and to disguise the color of poor glue. The soap is dissolved to a clear solution in water and added to the glue solution before the alum, the addition of which decomposes the soap. Not every kind of soap is suitable for this work as its nature must be such that the addition of

¹ Cyster: Paper, May, 1915, p. 18, from World's Paper Trade Review.

alum produces a fine emulsion rather than a curdled mass of fatty acids.

The mechanical operations involved in surface sizing sheets of paper are of a comparatively simple nature; the sheets are suspended in a vat of the hot size till the air is expelled, the excess of size is removed by pressing and the sheets are hung up to dry. The immersion of the sheets is sometimes accomplished by feeding them between endless felts into the size solution in a vat which must be long enough to give time for the air to escape from the paper. As applied to waterleaf papers this process is expensive because of the cost of handling single sheets and because of the large amount of size absorbed. This latter depends on the viscosity, temperature, and strength of the glue solution and upon the condition of the paper. Free stuff absorbs more glue than wet beaten stock, while bone dry paper absorbs it less rapidly than that with an appreciable amount of moisture.

In this country practically all surface sized paper is made as a part of the paper machine operation by leading the web of paper through a trough filled with the size which is maintained at the desired temperature by continual circulation to and from the supply tank. This method enables the paper to be engine sized with rosin and partially dried by passing over a few cylinders before reaching the size trough so that the amount of glue absorbed is materially reduced. (If, after removing the excess of size by squeeze rolls, the paper is reeled up and allowed to season a short time before drying the sizing is improved,) but in many cases it passes directly from the squeeze rolls to the driers which are skeleton drums around which the paper passes and within which are fans to keep up a circulation of air.

The drying of animal sized papers is a matter of particular importance since the quality of the product depends largely on this operation. It is desirable to dry slowly, without agitation and at a temperature below that required to liquefy the jelly so that the problem is really that of drying a jelly rather than a solution. Loft drying is the best but the slowest and most

expensive, the festoon arrangement used in drying coated papers gives fair results but is not perfect, while if the paper is dried on a steam cylinder the glue has little sizing power since individual fibres only are coated and the interstices are vacant. Papers dried on the skeleton drums are subjected to so much vibration from the fans that the surface tends to crack and the product is therefore inferior to loft dried paper. If, after drying, the sizing is found to be defective it may sometimes be improved by wetting and again drying. The temperature of drying depends in part on the atmospheric humidity. If this is low the drying takes place rapidly and a correspondingly low temperature may be employed but if the humidity is high the temperature must be raised to permit evaporation to take place. The upper limit is set by the liquefaction of the sizing, which in general may be said to take place at lower temperatures with the poorer grades of glue than it does with gelatines.

Surface sizing makes paper stronger and firmer and gives a better surface for writing than does engine sizing. Its effect is reduced by the subsequent operations of calendering, rolling or plate glazing which explains the fact that papers with a rough surface are more easily hard sized than those which are highly glazed.

The operation of surface sizing with glue, while apparently a simple one, is in reality one of the most difficult and uncertain of all those carried out by the paper maker, since the gelatine is influenced to so great an extent by atmospheric conditions and its absorption is so dependent on the physical and chemical conditions of the paper employed.

The tests to which glue or gelatine for surface sizing should be subjected are those for grease, acidity, ash, added alum and firmness of jelly. The methods for the first two are given in the chapter on coated papers. The ash may be determined by burning out a weighed sample in a porcelain crucible and weighing the residue which should then be examined for alumina by the usual qualitative procedure. The presence of the latter indicates that the jelly test may not be a just criterion of the

sizing value of the glue since it is probable that alum has been added to increase the thickness of its solution. The jelly strength may be found by comparing that formed from a definite strength of solution with that from standard samples similarly treated. It may be determined numerically by preparing jellies from the same strength of solution and noting the time required for a definite weight to penetrate the jelly a given distance or by determining the force required to remove a plunger round which the jelly has been formed.

Starch. This material is used in sizing both as a substitute for animal size and in the engines.

For surface sizing the solutions of the untreated starches are too thick to be applied in the ordinary manner or if they are reduced to the proper consistency so much water has to be used that enough starch to be effective is not present. For this reason the chemically treated, or so-called modified, starches are used for this work. These are dissolved by boiling in water and are applied, either with or without the addition of soap, wax or other chemicals, in much the same manner as animal size. Used in this way they give a firmness and rattle to the paper but they are not so effectual in sizing against writing ink as are animal sizes. This is probably due in part to the hygroscopic nature of starch and partly to the fact that it does not form a jelly on cooling and hence does not fill up the spaces between the fibres as does gelatine.

For use in the beating engines various kinds of starch are available but the one used is generally that which can be obtained most cheaply, due regard being paid to quality. For this reason corn starch is used almost entirely in this country while in Europe potato starch is largely employed. The starch is added to the engine either in the raw condition or after boiling with water to form a paste. The retention of the raw starch is undoubtedly greater than that of the boiled but its effect in hardening the paper may not be any greater since in order to accomplish this it must be gelatinized during the passage of the paper over the driers. Examination of papers made from stock containing

raw starch shows that many granules are not even swollen and such can have little value except as a filler.

Because of the difficulty of accurately determining starch in the presence of cellulose little definite information is available as to the percentage retained. It has been shown by Lutz¹ that the retention varies with the kind of starch and the condition when added. With hand-made papers prepared from stock to which 10 per cent of starch had been added he obtained the following retentions:

Kind of starch	Retention when added	
	Raw	Boiled
	Per cent	Per cent
Potato.....	73.6	46.2
Wheat.....	71.7	58.3
Rice.....	53.4	58.9

It is interesting to note that with raw starch the larger grains are retained better while if the starch is boiled the better retention occurs with those starches which give the stiffest pastes. It is very doubtful if such high retentions as the above can be expected in the case of machine-made papers where the chances for loss are so much greater.

Starch used in the beating engine hardens the paper, prevents dusting, increases the strength and tends to keep down the fuzz caused by insufficiently beaten stock. It probably increases the retention of filler very slightly but the gain in loading is not great enough to pay for the starch required. It cannot be considered a sizing agent in the same sense as rosin for it imparts no waterproof qualities.

There has recently been exploited a so-called sizing process, using starch and silicate of soda, in which the starch granules are swollen by heat in the presence of the silicate solution. The theory is that the silicate penetrates the starch granules as they swell and that when alum is added the silicate is thrown down

¹ Papier Ztg., 1908, pp. 1098 and 1142.

and carries the starch with it. This process was claimed to retain all the filler, increase the strength of the paper, and give a better printing sheet. Practical trials on a large scale have shown that it does not appreciably increase the retention of filler but that it does give a stronger paper. In one run, that part sized with silicate-starch was 15 to 18 per cent stronger than that in which no starch or silicate was used, while in another thinner order the gain in strength was 38 to 46 per cent. On the whole the results by this process appear to be in no way superior to those obtained by adding starch and silicate separately to the engine.

Rosin. This material is used in engine sizing to a greater extent than all other sizing agents together. It is obtained as a residue after distilling off the volatile portion from crude turpentine which is obtained in this country largely from the longleaf pine. Since the crude turpentine contains sand, bark, chips and other dirt these materials are always to be met with in commercial rosin. The point to which the distillation of the turpentine has been carried influences the color of the rosin, the higher the temperature the darker being the product. It also, to a certain extent, determines the commercial grading of the rosin since the grade depends on the color. Letters are used to denote the quality of the rosin, A being nearly black, while the lightest colored, W.W., or water white, is pale yellow. The medium grades, F and G, are those most commonly employed in paper sizing, and are considered to give better results than those of lighter color since the higher temperature of distillation insures the presence of less pitch.

Rosin, or colophony, is a transparent or translucent resin, nearly tasteless, very brittle and showing a conchoidal fracture. Its specific gravity is 1.07 to 1.08. It softens at 70° to 80° C., becomes semi-fluid in boiling water and melts completely at a somewhat higher temperature. It is insoluble in water but easily soluble in methyl and amyl alcohols, acetone, ether, chloroform, carbon disulphide and fixed and volatile oils. Because of its acid nature it dissolves readily in solutions of the alkalis forming

salts which are similar to those of the higher fatty acids or soaps.

Rosin contains practically no ash. Its acid number varies from 155 to 175 and averages about 164; this corresponds to 83.4 to 93.8 per cent of acid of the formula $C_{20}H_{30}O_2$. The unsaponifiable matter present ranges from 4 to 10 per cent. According to Schwalbe and Küderling, rosin contains from 0.1 to 6.7 per cent of matter insoluble in petroleum spirit. This insoluble matter is formed very rapidly when powdered rosin is exposed to sunlight and as it is friable and devoid of sizing power its amount should be as low as possible. Colophony varies more or less in chemical composition but its chief constituent is a monobasic acid of the formula $C_{20}H_{30}O_2$, variously spoken of as abietic, sylvic or pimaric acid.

Because of the growing scarcity of rosin and its increasing price considerable attention is being paid to its preparation by extraction processes from the "lightwood" and stumps of longleaf pine. There are on the market a number of rosins prepared in such ways and from a superficial examination it is difficult to distinguish them from those made in the regular manner from crude turpentine. The acid number of such rosins is low, samples tested by the author giving numbers between 153 and 157, while the unsaponifiable matter may run as high as 11.2 per cent. These rosins, when crushed or cooked for size, have an unmistakable odor of pine oil and this odor persists even into the finished paper if it is hard sized. They have been found to saponify rather more slowly than the regular grades and the size prepared from them must be boiled longer in consequence. The alum precipitate from such sizes has a distinct greenish color in comparison with the creamy white shade of that from ordinary size. Considering the small amount of rosin generally used in paper this is not a serious fault. Practical trials of such rosins have demonstrated that while they may give excellent results at times yet they are not entirely reliable.

The method of making rosin size varies more or less with different mills but the principle on which all are based is that of

combining the acid rosin with an alkali to render it soluble. Among the alkalis suggested are sodium aluminate and sodium silicate which are sufficiently alkaline to dissolve the rosin when their solutions are boiled with it. Size prepared with these alkalis precipitates alumina or silica on treatment with an acid or alum and these two substances aid in filling the paper and imparting hardness and rattle. The alkali commonly used however is soda ash which is obtainable in a high state of purity and which is said to give better results than caustic soda. The relative value of these two probably depends on local conditions to some extent but it has been the author's experience that for equal weights of rosin the size made with caustic soda was much more efficient than the other. One very general mode of operation is that of boiling in an open kettle fitted with a steam coil or jacketed around the bottom. The rosin may be added first and when it has all melted the soda ash dissolved in the desired amount of water may be run in, little by little, or the soda ash may first be dissolved in the kettle and then the crushed rosin added to the boiling solution. The time of boiling varies in different mills from three to seven hours but even with very long boiling it is probably not possible to cause all of the soda ash to combine with the rosin, so that the final product generally contains both free rosin and uncombined soda. In one mill where 400 lbs. of soda ash were used for 2,000 lbs. of rosin and the boiling continued for about three hours the size made analyzed as follows:

	Freshly prepared	Ready to use
	Per cent	Per cent
Combined rosin.....	22.0	30.5
Free rosin.....	11.3	15.9
Combined soda, Na ₂ O.....	3.0	4.5
Free soda, Na ₂ CO ₃	3.4	1.2
Water by difference.....	60.3	47.9

It was formerly the general custom to use a neutral size, or one in which the rosin was all combined with soda, but more recent practice calls for one containing more or less free or uncombined

rosin. The amount of this free rosin varies with the manner in which the size is to be used; if it is added directly to the beater without first dissolving, the limit is about 35 per cent of the total rosin and it is usual to run considerably lower. If an emulsifying or dissolving apparatus is employed the percentage of free rosin may safely go as high as 45 per cent. The theoretical percentage of sodium carbonate required to give a neutral solution with pure abietic acid is 17.5 but if this amount is used with commercial rosin the size will still contain a considerable amount of free rosin; hence it is quite general to use an even larger amount than this. With high free rosin sizes for use in emulsifying apparatus the amount of soda may go as low as seven parts per 100 of rosin.

Neutral size is generally clear and dark in color while free rosin sizes may be clear and dark or opaque and light colored. If a free rosin size contains about 50 per cent of water and free soda is present, the size, on cooling, will separate a dark reddish-brown liquid containing the excess of soda and some of the coloring matter of the rosin. This separation is sometimes caused to take place by adding a little common salt to the size, the idea being to improve the color of the paper. It is doubtful if the gain in color is appreciable since this dark liquor when acidified gives a precipitate which is only slightly grayish in color. The proportion of water in a size, besides affecting the separation of the black liquor, is also of importance because of its influence on the consistency of the size, which, at the end of the cook, should be sufficiently fluid to strain through a 60 mesh wire screen. It is occasionally found that a size is too thick and the attempt is made to thin it down by adding water, with the peculiar result that it becomes thicker instead of thinner. It is also frequently noticed that a size containing 30 per cent of water boils thinner than one with 50 per cent so that we are forced to the conclusion that a thick boil usually indicates too much, rather than too little, water.

From time to time various substances have been proposed as possible additions to rosin size. Among these may be mentioned

phenol, phenanthrene and linseed oil to cause the rosin to saponify more readily and to give a better emulsion, and starch, glue, casein and horn to enhance the sizing power of the rosin. Other suggested materials are potato meal, albumen, tannic acid and stearin.

Size is ^{usually} best added to the beater after the stock and filler are in but before the alum. Still better sizing results are said to be obtained by putting the size in the beater with enough water to carry it under the roll and allowing it to circulate before the stock is added. This however causes so much foaming that it is impractical. If the size contains less than 35 per cent of free rosin it may be added directly to the engine or it may first be dissolved in luke-warm water. Hot water should never be used because it causes the free rosin to collect in lumps which make spots in the paper. There is probably not much to choose between adding directly to the beater or dissolving so far as efficiency of sizing goes but as the dissolved size may be strained through cloth it is preferable from the standpoint of cleanliness.

With high free rosin sizes some form of emulsifier should be used in order that the emulsion of free rosin may be so fine that none will settle out. The emulsifier is practically a steam injector which takes the hot size and sprays it suddenly into a large body of cold water. This prevents the free rosin from collecting in flakes and gives very fine particles in suspension. Some forms of apparatus are so arranged that the operator can control the output and obtain at will either a milky suspension of comparatively coarse particles or a semi-transparent, brownish one in which the particles may be as small as 0.002 mm. in diameter. The concentration of the emulsion is said to have a large influence on the results and the upper limit for satisfactory work is variously given as a 2 to 3 per cent solution of rosin. The claims made for emulsification processes are more uniform, cheaper and better sizing and less dirt. In this country many mills which formerly added their size directly to the beater are installing emulsifying apparatus with very good results.

The mere presence of rosin size in the stock does not mean

that the paper will be sized; to accomplish this object the rosin must be precipitated on the fibre in such a way that the paper on drying will be water-resistant. The substances which will cause precipitation are acids, acid salts and salts of the alkaline earths and heavy metals. The precipitants which have been actually proposed from time to time include, sulphuric acid, sodium acid sulphate, carbonic acid, zinc sulphate, magnesium sulphate, calcium chloride, aluminum sulphate, etc. Practical trials have proved that while precipitation with acid will give fairly good sizing the results are by no means so permanent as when alum is used. None of the precipitants having an alkaline base as copper, lead, or zinc will give good results nor will the salts of the alkaline earths, as magnesium sulphate or calcium chloride even though they completely precipitate the rosin. Tests by Pauli, Froberg and others have proved that magnesium sulphate, whether used alone or as a partial substitute for alum, has no value as a sizing agent and experiments carried out under the direction of the author have shown that calcium chloride is equally valueless. In practical working we are concerned only with alum or aluminum sulphate which is the precipitant universally employed in rosin sizing.

Researches by Würster in 1878 led him to the conclusion that the prime sizing agent was the free rosin thrown down by the alum and on the basis of these experiments much stress has been laid on the use of sizes high in free rosin. This question has never been definitely settled and there is still much difference of opinion as to whether the sizing agent is free rosin or aluminum resinate. Our experience has been that, other things being equal, a pound of rosin as neutral size has as much sizing power as a pound in the form of size containing 30 per cent of its rosin in the free state. This does not necessarily mean that the sizing agent is not free rosin, since the latter may be formed by the reaction with alum, but it does indicate that too much importance is placed on the presence of free rosin in the size. The reaction between rosin size and alum has been studied by Remington,¹

¹ Remington, Bowack and Davidson: *J. Ind. Eng. Chem.*, 1911, 3, 466.

Schwalbe,¹ Neugebauer,² Heuser³ and many others with quite conflicting results. Even when considering the case of neutral size and alum alone there is marked lack of agreement and when the reaction takes place in the presence of cellulose still further complications are introduced by the absorptive power which the latter has for alumina and which Schwalbe claims may quantitatively effect the decomposition of 3 per cent of its weight of aluminum sulphate. The reaction between sodium resinate and alum is given by Heuser as follows:

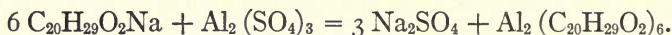

This is for equivalent quantities and indicates the formation of aluminum resinate. If an excess of alum is used free rosin is formed as follows:

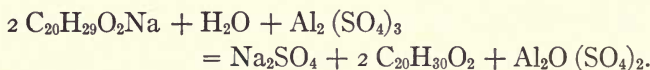

In the presence of cellulose these reactions are doubtless somewhat modified and it seems probable that free rosin, aluminum resinate and alumina all play a part in producing the final result.

The relation between the amount of alum and rosin used in the engine is of considerable importance. With a neutral size it was found that 0.202 lb. of alum (17 per cent Al_2O_3) was sufficient to precipitate each pound of rosin while with a 31 per cent free rosin size the figure found by titration was 0.201 lb. In actual operations these proportions are never even approximated for if they are the paper is very slack sized which indicates the necessity of inducing secondary reactions between the aluminum resinate and the alum. It has been found by experience that the ratio of alum to rosin should not fall much below $1\frac{1}{2} : 1$ if good sizing is to be expected, and this has been confirmed by laboratory experiments using a standard fibre

¹ Schwalbe and Robsahm: *Wochbl. Papierfabr.*, **43**, 1454.

² Neugebauer: *Z. angew. Chem.*, **25**, 2155.

³ Heuser: *Wochbl. Papierfabr.*, **44**, 1312, 1394, 1517, 1583, 1688.

furnish and an amount of size equivalent to $1\frac{1}{2}$ per cent of rosin on the weight of fibre. These tests gave the following results:

Percentage of rosin	Percentage of alum (17 per cent Al_2O_3)	Sizing Ink test in seconds
1.5	1.0	14
1.5	2.0	134
1.5	2.5	195
1.5	3.0	230
1.5	4.0	228
1.5	6.0	220
6.0	4.0	210
6.0	8.0	566

The extent to which the alum may be reduced is also limited by the difficulty which is caused by the stock sticking to the couch and presses of the paper machine. Practical trials on a book-paper machine showed that sticking was likely to take place if the ratio was dropped to 1.2 alum to 1 rosin, but that it ran safely if the ratio was 1.5 : 1. A safe, practical test for sufficiency of alum is to have the stock in the engine react slightly acid to litmus paper or turn alcoholic Congo red solution slightly brownish.

(The amount of rosin used in sizing paper varies greatly with the grade being made; in some it may drop as low as 0.25 per cent of the stock furnished while in hard sized orders it may amount to 2 per cent or even more.) The sizing increases with the quantity of rosin used as is seen from the following figures, which were obtained by sizing a mixture of one-half soda poplar and one-half sulphite spruce beaten together in a standard manner.

Per cent of rosin on fibre furnish	Per cent of alum on fibre furnish	Ink test in seconds
0.38	4	12
0.75	4	45
1.50	4	226
3.00	4	380
6.00	8	566

The increase in sizing is not proportional to the increase in rosin throughout the series, the greatest gain being obtained when the rosin is increased from 0.75 to 1.50 per cent.

The sizing of paper containing 18 per cent of ash, as well as that of the above series of tests, is illustrated in Fig. 35 which shows the marked difference caused by the filler. This indicates the waste of materials by using much more than $2\frac{1}{2}$ per cent of rosin in paper which is heavily loaded.

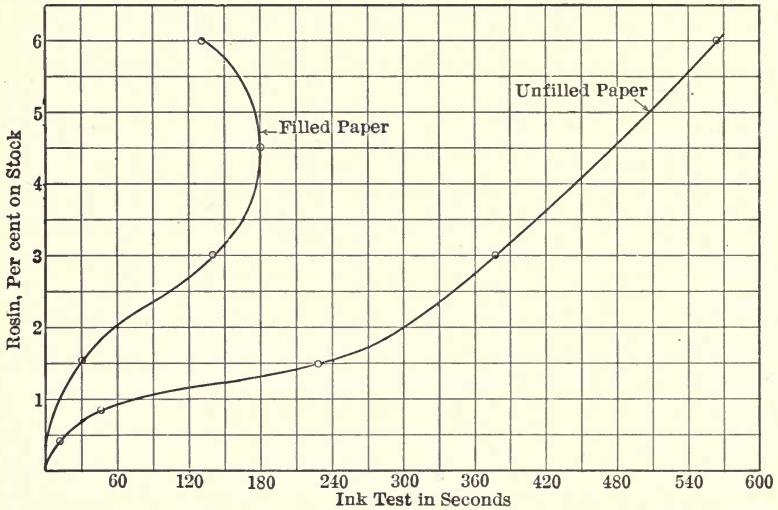

FIG. 35.

Trouble in sizing is frequently encountered in hot weather and particularly in engines where the stock tends to become heated. This is probably due to the rosin particles uniting to form larger masses which do not cover the fibres well. In such cases the size should be added to the stock as late as possible. Water containing calcium bicarbonate, or the presence of calcium carbonate or calcium hydroxide in the stock, is particularly bad for sizing, while calcium sulphate or chloride has practically no influence on the result. With the latter salt, even as much as 5 per cent on the weight of the fibre, has been found to be harmless though much less than this amount will

completely precipitate the average amount of size used. This is probably to be explained on the assumption that the alum subsequently added reacts with the calcium resinate forming free rosin, calcium sulphate and alumina. This is a very fortunate circumstance since the bleached fibre employed often introduces more than enough calcium chloride from the exhausted bleach to precipitate all the size used. Other disturbing factors are the soluble matters washed into the water supply by heavy rains, the presence of much filler, or of acid from incompletely washed sulphite fibre, etc. The influence of the filler is well illustrated by the curve on page 291.

The sizing process is not completed till the web of paper has passed over the driers and the manner of conducting this operation has a great influence on the results. The best conditions are said to be moderate steam pressure on the first drier, increasing to a maximum at about the middle of the bank and again decreasing toward the calenders. This warms the paper up gradually but permits it to reach a high temperature before the moisture is driven off, which has been found essential to good sizing.¹ If the first driers are too hot the sudden escape of steam opens up the pores of the paper and the sizing is defective, while if the paper becomes too dry before the proper temperature is reached the sizing is also poor. Moist heat seems to be a requisite of good sizing and slack sized paper may often be greatly improved by exposing it to steam even at as low a temperature as 100° C.

Experiments by the author on the drying of sized pulp taken from the first press of a paper machine gave quite different results from those of other observers. The drier was a stationary cylinder heated by steam and the sheets to be dried were held against its surface by a tightly stretched piece of old press felt. Two grades of paper were tested at various temperatures with the following results:

¹ Klemm: Wochbl. Papierfabr., 39, 1908, p. 1369.

Temperature of drier	Sizing: seconds for ink to penetrate	
	Sample 1	Sample 2
Deg. C.		
100	430	260
106	480	280
112	510	270
119	420	260
131	440	250
142	420	240
152	420	240

All these samples were held against the cylinder until steaming ceased and were then exposed to the air for twenty-four hours before testing for sizing. It was also demonstrated in these experiments that if the paper were alternately pressed against the cylinder and removed, as would be the case in passing over the driers of a paper machine, the sizing was only one-third to one-half as strong as though it had been held against the drier continuously.

This question of the relation between the manner of drying and the sizing of the sheet is one on which little work has apparently been done, but it is one which must be investigated much more carefully before it will be possible to say that the best conditions for sizing are maintained.

Defects of Rosin Sizing. It is the general opinion that the presence of rosin in paper causes more or less rapid deterioration according to the amount present. Much work has been done in the attempt to prove this point and to determine the maximum amount which it is safe to employ, but beyond the general conclusion that it is injurious if used in large amount there is little agreement between different observers. Under the action of oxygen rosin forms a substance having the nature of peroxide which then acts on cellulose forming oxycellulose and injuring the paper. This action is said to be more vigorous with the original rosin in ground wood than with that which has been made into size and reprecipitated. The discoloration of paper is also ascribed to the rosin but all attempts to devise a

positive test which will show whether rosin sized papers will become yellow have thus far failed. Zschoke¹ concludes that wood-free paper with not over 1 per cent of rosin will not become yellow, while Klason² thinks that papers properly sized with rosin will not be injured within sixty years.

If rosin sized paper is exposed to sunlight the sizing is destroyed and the paper becomes absorbent. This is also true of animal sized papers though the change is not so rapid. With rosin sizing this is undoubtedly due to the formation of the friable substance, insoluble in petroleum ether, which has been previously mentioned. The use of a small amount of tannin with the size is said to cause this change to take place much more slowly.

Defective sizing may also be caused by calendering as this has been found to reduce the resistance to ink from 6 to 40 per cent. Other factors which may cause defective sizing are too much filler, improper proportion of alum and poorly cooked size. These are all well-defined troubles and can be readily corrected but there are also defects which come from causes so obscure as to practically defy detection and for which little can be done.

Testing of Rosin and Rosin Sizes. In testing rosin for use in size making one of the most important determinations is that of the acid number, which is the number of milligrams of caustic potash required to neutralize 1 gram of rosin. This is best determined by dissolving a weighed sample of the rosin in neutral alcohol and titrating directly with alcoholic KOH solution, using phenolphthalein as indicator. With average American rosin about 164 milligrams of KOH will be required for every gram of rosin. This test indicates roughly the amount of alkali which the rosin will use up in the ordinary size-making process and it may be used as the basis for calculating the reduction in the amount of alkali which should give a size with a definite percentage of free rosin.

¹ Wochbl. Papierfabr., 44, 2976 and 3165.

² Paper Trade J., 1913, p. 46.

The unsaponifiable matter may be determined by heating a sample on the steam bath for several hours with an excess of caustic potash solution, cooling, extracting with ether, as in the case of size, evaporating off the ether, drying and weighing. This unsaponifiable matter is soft and sticky in character and if present in large amount is likely to cause trouble by sticking at various points on the paper machine.

The amount of material insoluble in petroleum ether should be determined by dissolving a weighed sample of the rosin in petroleum ether, separating the solution from the insoluble residue, washing the latter with several portions of ether, drying and weighing. The insoluble matter has practically no sizing properties and it should be present in small amount only.

In the case of rosin size containing no admixture of foreign material, the substances to be determined are moisture, free and combined rosin and free and total alkali.

Moisture may be conveniently determined by weighing out 2 to 3 grams of the size in a covered weighing bottle, dissolving in hot water, transferring to a weighed platinum dish, evaporating to dryness, drying and weighing. Total alkali may then be estimated in this dry sample by burning off the organic matter and titrating the residual mineral matter with $\frac{N}{2}$ acid using methyl orange as an indicator. For free alkali weigh out 10 grams of size and dissolve in 200 c.c. of *acid free* absolute alcohol. Allow to stand at least eight to ten hours, or longer, if possible, and filter, washing the filter with absolute alcohol. When well washed pour boiling water through the filter and titrate the aqueous solution with $\frac{N}{10}$ acid using methyl orange as an indicator.

Free rosin should be determined in a 5 to 10 gram sample. Dissolve in a small amount of hot water and wash into a separatory funnel keeping the volume of water as small as possible. Cool, add about 25 c.c. *acid free* ether, shake and allow to stand till the ether layer separates clear. If this does not take place

readily it may be hastened by adding a few drops of a strong solution of sodium chloride. When separation has taken place draw off the aqueous solution into a flask and wash the ether extract twice with small portions of water, adding these washings to the solution in the flask. Transfer the ether extract to a small weighed dish or flask and replace the aqueous solution in the separatory funnel. Repeat the extraction with ether and add the second extract to the first in the weighed dish. Carefully evaporate the ether, dry the residue at 105° C. for about two hours, cool and weigh as free or uncombined rosin.

Combined rosin may be determined in the soap solution remaining after the extraction of the free rosin. Add sufficient acid to completely free the rosin and then extract with ether as in the case of free rosin. For this determination it is probably well to extract three times with 25 c.c. of ether instead of twice as for free rosin.

A useful qualitative test for size containing free rosin is carried out by stirring luke-warm water into the size, a little at a time, until a thin milk is produced and then pouring this into a large jar of cold water. If during the dissolving the rosin separates in lumps, or if on standing for an hour after dilution flakes settle to the bottom, the size is unsafe to use unless some sort of an emulsifier is employed.

In addition to the tests already described, commercial sizes must be examined for such substances as starch, glue, casein, gum, dextrine, etc. All these are insoluble in alcohol and may therefore be looked for in the residue left on dissolving the size in strong alcohol. The character of this residue will generally give some indication as to the nature of the substances present and special tests may then be applied for those which are suspected.¹

Alum. As already mentioned the rosin sizing process necessitates the use of some precipitant and the agent universally employed is aluminum sulphate, or alum, as it is generally called in the paper industry. Alum is manufactured largely from clay and

¹ J. Marcusson: Chem. Rev. Fett. Ind., 1914, 21, 1-3.

bauxite by treatment with sulphuric acid. If calcined clay is added to sulphuric acid of 1.48 sp. gr. at 85° C. a vigorous reaction immediately takes place and the resulting mass after agitation and standing gradually solidifies. About 60 per cent of the alumina present in the clay is converted to sulphate. The product known as "alum cake" contains all the impurities of the clay and according to Bailey its average composition is

	Per cent
Al ₂ O ₃ (soluble).....	12.3-13.0
Fe ₂ O ₃	0.1- 0.2
SO ₃ (combined).....	29.5-31.8
SO ₃ (free).....	0.4- 1.0
Insoluble.....	20.0-26.5

Alum cake is sometimes purified by lixiviation, separation of the clear liquid and evaporation to about 1.56 sp. gr. at 115° C., when on cooling it sets in solid blocks.

The procedure with bauxite is very similar except that it is boiled with the acid for several hours, diluted to 1.35 sp. gr. at the boiling point, separated from insoluble matter, and then concentrated. The alum from bauxite may contain up to 0.7 per cent, or even more, of Fe₂O₃ and no entirely satisfactory method of freeing it from this impurity has yet been devised.

For the preparation of pure aluminum sulphate, powdered bauxite is mixed with so much soda ash that for each molecule of Al₂O₃ (including Fe₂O₃) there are present 1 to 1.2 molecules of Na₂O. The mixture is then heated in a reverberatory furnace with frequent stirring for five hours. On lixiviating the resultant mass a solution of sodium aluminate is obtained while the iron remains as Fe₂O₃ in the insoluble residue. Passage of carbon dioxide through the solution, or its treatment with alumina (Bayer's process), causes the separation of alumina which on solution in sulphuric acid gives an alum containing only 0.01 to 0.02 per cent of Fe₂O₃. A product containing less than 0.01 per cent Fe₂O₃ is generally called free from iron.

In making alum zinc is sometimes added to reduce the iron to the ferrous state, in which condition it imparts only a slight

greenish color to the product. The presence of free acid also tends to mask the presence of iron. If the alum is basic, 0.05 per cent of Fe_2O_3 gives a yellowish color and if 0.15 per cent is present, the basic ferric salts color the alum as dark as beeswax, while if free acid is present this amount of iron scarcely colors the alum at all.

Characteristic analyses of alum are as follows:¹

	1	2	3	4	5	6	7
Insoluble in water.....	0.49	0.06	0.67	0.18	0.4	0.16
Alumina, Al_2O_3	14.70	16.20	18.81	22.37	16.32	17.4	21.87
Iron, Fe_2O_3	0.12	0.06	0.80	0.59	0.51	trace	0.40
Zinc oxide, ZnO	3.80
Soda, Na_2O	1.34	0.76	0.67	0.84
Sulphuric acid, SO_3 :							
Combined.....	34.60	36.62	45.97	45.28	36.90	39.2	49.27
Free.....	0.40	1.03
Water.....	49.95	45.29	32.58	27.34	45.42	43.0	27.46

In interpreting the analysis of an alum it is to be noted that a large amount of insoluble matter indicates that the original raw material was not thoroughly broken down by the acid or that the purification was improperly conducted. Zinc precipitates its equivalent of size but it is seldom present in sufficient amount to have much influence on the value of the alum, while soda is usually due to the use of carbonate in the manufacture of porous alum but may also be derived from the soda used in the reverberatory charge.

The presence of much iron in an alum has a deleterious effect on the color of the paper and probably also on its permanence, and its amount is therefore a matter of some importance. Authorities differ as to the permissible amount of iron, but the general opinion seems to be that for news papers the Fe_2O_3 should not exceed 1 per cent and that not over 0.05 per cent should be in the ferric state, for good writing or book papers

¹ Analysis of sample 1 from Cross and Bevan, "Text Book of Paper Making," samples 2, 3 and 4 from Griffin and Little, "Chemistry of Paper Making," 5, 6 and 7 from analyses by the author.

0.2 to 0.3 per cent should be the upper limit and it should preferably be in the ferrous condition. For only the highest class of papers is it necessary to have less than 0.2 per cent of Fe_2O_3 and then the limit should be set at 0.01 per cent. While the appearance of an alum is improved by the reduction of the iron to the ferrous state it is probable that altogether too much stress is laid on this point as the processes of paper making permit its rapid oxidation so that the final result may be the same no matter what the condition of the iron originally.

The amount of free acid in alum is of importance because of its possible effect on the colors used, because it decomposes the size without throwing down alumina and because it increases the injurious effect of the alum on the beater bars and wires. If present in excessive amount it may even tend to weaken the paper as it passes over the driers. For use with gelatine in surface sizing alum containing free acid may cause brittleness of the paper and act injuriously on the metal plates used in printing. A small amount of free acid is probably harmless in most instances but it should be limited to 0.5 per cent.

The value of an alum is generally considered to be in proportion to the amount of alumina which it contains, though this is no indication of its size precipitating power since impurities such as zinc salts and free acid also cause precipitation of the rosin. A neutral or slightly basic alum is also preferred to one containing free acid in spite of the fact that the basic alumina possesses practically no size precipitating power. A basic alum is characterized by the separation of alumina on dissolving to a dilute solution.

The amount of alum used depends on a number of factors besides the amount of size employed. Hard water necessitates additional alum, as does also an increase in the temperature of the stock in the beater. The quantity to use is generally determined by experience rather than by scientific observation and it is always largely in excess of that necessary to precipitate the size. This excess is also essential in order to prevent the stock from sticking to the press-rolls, particularly in hot

weather. A portion of the alum not required to precipitate the size is undoubtedly decomposed by the cellulose, resulting in a fixation of alumina on the fibres but that a considerable part is lost is proved by the presence of aluminum sulphate in the back water. For an engine holding 1000 lbs. of stock, the alum ordinarily employed in sizing would range from 12 to 30 lbs. or even higher for very hard sized papers.

The method of adding the alum has some influence on the results obtained, it being found best to allow the size to become thoroughly mixed with the stock before furnishing the alum. Some mills, however, reverse these operations and add the alum first. It has been our experience that this gives somewhat inferior results though the difference is not very great. In some establishments it is also customary to add part of the alum before the size and the rest afterwards on the theory that any combination of size with lime salts will be prevented by the stronger reactivity of the alum. Experience has shown that even if sufficient calcium chloride is present to combine with all the size, subsequent addition of alum breaks down this combination and gives fully as good sizing as in the entire absence of calcium chloride. The method of divided alum is said also to reduce frothing and on this basis may be justified.

If possible alum should be used in the form of a solution as this promotes rapid mixing with the stock. It is stated by Hoffman that the solution should never be used hot or stronger than 6° Bé. The alum solutions may be readily prepared from either ground or ingot alum and should be stored in either wood or lead-lined tanks and distributed through lead or lead-lined pipes. In spite of the obvious advantages of distributing from a central dissolving station, many mills still add the ground alum directly to the beaters. The time of adding the alum is a compromise between two factors; it should be added as early as possible to give plenty of time to complete its reaction with the size and it should be put in as late as possible to prevent action on the beater bars and bed plates. If bronze bars are used this second factor is eliminated and the alum can be added sooner.

Testing Alum. The analysis of alum may be conveniently carried out according to the following scheme.

Insoluble matter is determined by dissolving 10 grams of the alum in a small quantity of water and filtering at once through a weighed filter into a liter flask. After washing the filter thoroughly with hot water it is dried at 105° C. and weighed. The difference between this weight and the original weight in grams multiplied by 10 gives the percentage of insoluble matter.

The filtrate and washings from the determination of insoluble matter should be made up to 1000 c.c. and thoroughly mixed; each 100 c.c. of this solution will then represent exactly 1 gram of alum.

For the determination of total sulphuric anhydride, SO_3 , 100 c.c. of the alum solution are diluted to about 300 c.c. and a few cubic centimeters of dilute hydrochloric acid added. The solution is now heated to boiling and hot barium chloride solution added in slight excess. After digesting on the steam bath for several hours the precipitated BaSO_4 is filtered off, washed free from chlorides, dried and ignited in a platinum crucible. After the carbon has all burned off the crucible is cooled and its contents moistened first with a few drops of concentrated nitric acid and then with a drop or two of strong sulphuric acid. The acids are then very cautiously evaporated and the crucible ignited for a few minutes at a dull red heat, cooled and weighed. The percentage of sulphuric anhydride is obtained by multiplying the weight of precipitate in grams by 34.30.

The total iron is best determined by a colorimetric method adapted from that of Stokes and Cain¹ and using a colorimeter in which the solutions to be compared are contained in two test tubes of the same diameter. For comparison with the alum a solution containing 0.10 gram ferrous iron per liter is made by dissolving 0.7026 gram ferrous ammonium sulphate in a liter of water. Into one of the test tubes 10 c.c. of this solution is put, together with 10 c.c. water, 5 c.c. sulphocyanic acid solution (saturated with mercuric sulphocyanate), 0.01

¹ Stokes and Cain: J. Am. Chem. Soc., 1907, 29, 409.

gram ammonium persulphate and 10 c.c. amyl alcohol. Into the other tube 0.5 c.c. of alum solution is run from a 10 c.c. burette and then 19.5 c.c. water, 5 c.c. sulphocyanic acid solution, 0.01 gram ammonium persulphate and 10 c.c. of amyl alcohol are added. Both tubes are then thoroughly shaken and comparison of the colors is made in the colorimeter as soon as the amyl alcohol layer clears. If the color of the alum solution is weak it is adjusted to the standard by adding alum solution, 0.1 c.c. at a time, and shaking well. If the alum tube shows too strong a color the alum solution may be added to the standard iron tube till the two match. By dividing 0.00002 by the grams of alum in the alum tube (or by this number minus the grams added to the iron standard tube) and multiplying this quotient by 100, the percentage of iron in the alum is obtained. This percentage multiplied by 1.43 gives the total iron calculated as ferric oxide, Fe_2O_3 .

For the determination of alumina in the absence of zinc, 100 c.c. of the alum solution are diluted to about 300 c.c. and treated with a few cubic centimeters of dilute hydrochloric acid and a few drops of concentrated nitric acid to oxidize the iron. The solution is brought to the boil, 5 c.c. ammonium chloride added and then ammonium hydroxide with constant stirring until the solution smells slightly of ammonia. After heating on the steam bath 5 minutes — when a faint odor of ammonia should still be noticeable on stirring — the solution is filtered, the precipitate washed free from chlorides, dried, and ignited over a blast lamp to constant weight. This weight multiplied by 100 gives the percentage of alumina and ferric oxide and by subtracting the percentage of the latter, already found by the colorimetric method, the per cent of alumina may be found.

If zinc is absent the filtrate from the alumina precipitate may be used for the determination of alkalis. The solution is evaporated to dryness in a weighed platinum dish, ignited to drive off ammonium salts, cooled, treated with a little concentrated hydrochloric acid and taken up with a little water. A few drops of concentrated sulphuric acid are added, and the solution evapo-

rated as far as possible on the steam bath. The dish and contents are then carefully ignited to drive off sulphuric acid, heated a few moments to dull redness, cooled and weighed. The weight of sodium sulphate thus obtained multiplied by 43.64 gives the percentage of sodium oxide in the alum.

The presence of zinc in an alum renders the above procedure for alumina inaccurate and a qualitative test for zinc should therefore be made before proceeding with the alumina determination. To a moderately strong solution of the alum add an excess of ammonia, heat to boiling and filter. To the clear filtrate add a few drops of ammonium sulphide and heat to boiling. If zinc is present a flocculent white precipitate will form which on boiling a few minutes will settle rapidly.

In the presence of zinc the alumina and iron should be determined by the basic acetate method. Dilute 100 c.c. of the alum solution to 500 c.c., add 2 grams of sodium acetate and a few drops of acetic acid. Bring to a boil and keep in active ebullition for ten to fifteen minutes. Allow to settle, decant the clear liquid through a filter as rapidly as possible and boil up the precipitate with water. Repeat the settling, decantation and boiling twice more and finally wash the precipitate on the filter with hot water containing a little ammonium acetate. The filtrate and washings are evaporated to 200 c.c. and if any precipitate separates it should be filtered off, washed and united with the rest of the precipitate which is then to be dried, ignited and weighed as above described for alumina. This method also gives the alumina and ferric oxide together and from the total weight that already found for ferric oxide should be deducted in order to give the alumina.

In the filtrate from the basic acetate precipitate the zinc may be determined by neutralizing as nearly as possible with ammonia, heating to boiling and adding ammonium sulphide drop by drop so long as a precipitate continues to form. The boiling is continued fifteen or twenty minutes, the zinc sulphide allowed to settle and the clear liquor tested with ammonium sulphide to make sure that precipitation is complete. If such is the case

filter off the zinc sulphide, wash with hot water and dry the filter in the oven. Remove the precipitate from the filter, burn the latter over a porcelain crucible, add the zinc sulphide and ignite with free access of air, gently at first but finally as strongly as possible. The occasional addition of a small piece of ammonium carbonate aids the operation and the ignition should be continued until on cooling and weighing a constant weight is attained. This weight multiplied by 100 gives the percentage of zinc oxide in the alum.

The presence of free acid in alum is indicated by a blue color with Congo red solution; if free acid is absent a dirty brown color only results. Craig¹ has proposed a method for the direct determination of free acid in alum. The solutions required are: (1) Potassium fluoride prepared by dissolving the pure salt in distilled water to a specific gravity of 1.45, neutralizing if necessary with caustic potash or sulphuric acid until 1 c.c. in 10 c.c. of distilled water shows a faint pink with phenolphthalein, filtering and diluting the clear solution to a specific gravity of 1.35. This solution should be preserved in glass coated with wax. (2) Sulphuric acid standardized against sodium carbonate using methyl orange as an indicator. (3) Caustic potash, free from alumina and similar bases, standardized against the acid, with phenolphthalein, in about 40 c.c. of water to which 10 c.c. of the potassium fluoride solution have been added. In making the test a weighed portion of the alum is dissolved to give a solution of 1 to 3 grams of alumina in 200 c.c.; this is filtered and 20 c.c. are gradually added, with stirring, to 10 c.c. of the potassium fluoride solution, to which 50 to 60 c.c. of distilled water and 0.5 c.c. of 0.2 per cent solution of phenolphthalein have been added. When free acid is present the mixture is practically colorless and standard alkali is slowly added until a faint permanent pink color is obtained; the amount of alkali required is calculated to free acid.

Moisture in alum cannot be determined by direct drying or

¹ J. Soc. Chem. Ind., 1911, 30, 184.

ignition; it is generally estimated by deducting the sum of the determined substances from 100 and calling this difference moisture. Griffin and Little¹ recommend the following method: Ignite a weighed sample of alum in a platinum crucible until copious fumes of SO_3 appear, cool, weigh and note the loss. Treat the ignited sample with hot hydrochloric acid until all lumps are broken down, filter, and wash the residue with hot water. The filtrate and washings are precipitated with barium chloride and the sulphuric acid determined as usual. The percentage of SO_3 here found, deducted from the total (determined in a separate sample), gives the percentage driven off by ignition and this taken from the total loss on ignition, in per cents, leaves the percentage of moisture in the sample.

The size precipitating power of an alum may be ascertained if desired by titrating a standard size solution by one of the alum in question. This test gives the total precipitating power of the alum and makes no distinction between sulphates of alumina, iron, or other bases or of free acid. It consequently shows little as to the value of an alum and its usefulness is still further reduced by the fact, already mentioned, that a considerable excess of alum over the theoretical must always be used.

Casein Sizing. Casein, as an engine size, imparts firmness, elasticity and strength to the paper and enables it to take a good finish. It aids in keeping down the fuzz on the surface of the paper and for this reason may form a partial substitute for beating. It does not size the paper in the same sense that rosin does as the precipitated casein is not water repellent.

Casein being an insoluble body must first be brought into solution by treating with an alkali, after which the solution may be incorporated with the rosin size or it may be added directly to the beater. In either case the addition of alum to the stock causes the precipitation of a bulky, gelatinous mass which adheres to the fibres and upon drying with them aids in filling the pores. Owing to the nature of the precipitated casein practically all of it is retained by the paper and when as little as 2 per

¹ Chemistry of Paper Making, p. 382.

cent is added to the stock its presence is readily detected in the finished sheet.

Unless used with considerable care casein is apt to impart an unpleasant odor to the paper. If used in too large proportions it cements the fibres together so firmly that the folding and tearing strength of the paper is considerably reduced though at the same time the bursting and tensile strength is increased. Probably from 2 to 3 per cent is the maximum which can be used without making the paper brittle. Because of these drawbacks, and also because of the comparatively high cost of the material, casein sizing is not generally employed and may be said to be used only for special purposes.

Glue. Glue has been exploited as an engine size in much the same way as casein and for the same reasons. Unlike casein, however, it requires only hot water for its solution and it is not precipitated by alum. For this reason its retention is very low, being probably only that amount which clings to the surface of the fibres from the very dilute solution in the beater. Its low retention was proved in one experiment where 2 per cent was added to the stock in the beater and yet the paper made from it failed to show its presence when tested by all ordinary methods.

It is asserted by many of the older paper makers that by the use of glue in the beater they can obtain results which they can get in no other way. Its use is, however, costly and its effects are probably greatly over-rated.

Viscose. This material, which is a solution of cellulose prepared by means of caustic soda and carbon bisulphide, was at one time proposed for engine sizing. The solution was added to the beater and the cellulose regenerated by the subsequent addition of magnesium sulphate or alum. Theoretically the sizing of a paper by filling its pores with a substance of the same chemical composition as the fibres composing the sheet is a very attractive proposition. Practically, however, the process has never attained any wide application, probably because of the somewhat complicated nature of the chemical reactions; because it

charges the engine with certain undesirable chemicals; and because of its cost.

This process also does not size by making water resistant, as does rosin, but its action is more in the nature of the starch sizing of textile goods.

Rubber Resins. These resins which are obtained as a by product from the treatment of certain grades of rubber have been suggested as of possible use in sizing paper. As they are unsaponifiable they cannot be dissolved in alkaline solutions and hence can only be used to replace the free rosin in the size. By this means they are dissolved and held in suspension and thus may be added to the beater just as is ordinary size. Experiments in German mills have indicated that this material has very little value but our own tests give contrary results and seem to show that it has more sizing value than an equal amount of colophony.

If this material ever comes on the market in sufficient quantity to compete in price with rosin it is certainly worthy of further investigation.

The Mitscherlich Sizing Process. Among the substances occurring in waste sulphite liquor are compounds derived from the wood which are sufficiently like tannic acid to possess its power of precipitating gelatine. This property has been utilized by Dr. Mitscherlich as the basis for an engine sizing process which is conducted as follows: Ordinary glue is digested at 60° C. with about ten times its weight of waste sulphite liquor. After several hours, during which time the mixture should be stirred occasionally, the glue is dissolved and the solution is then diluted with more waste liquor until it is present to the extent of fifty times the weight of the glue. This dilution should be conducted at ordinary room temperatures and should be made very gradually and with constant stirring. The whole is allowed to stand for twenty-four hours to allow the flocculent precipitate to settle, the clear liquor is then decanted and the precipitate diluted with a quantity of water equal to about fifty times the weight of the original glue. A little alkali is next added to neutralize the free

acid and to dissolve the compound of glue and astringent material and the solution so prepared is then ready to add to the engine. Alum, or an acid, causes the re-precipitation of the flocculent gelatine compound which adheres to the fibres and imparts to them its sizing properties. This process has never met with very wide application.

CHAPTER X

LOADING AND FILLING MATERIALS

Nearly all classes of papers, except a few for special purposes, contain some mineral filling or loading material and unless it is used to an excessive extent it cannot be considered an adulterant. In fact without some filler it is impossible to produce many of the grades which modern printing practices demand, since it fills up the interstices between the fibres and gives a better surface for process cuts and half-tones which are so largely used. It also makes the paper more opaque, improves the feel, and enables it to take a better finish on calendering, all of which are of importance to the trade.

Fillers tend to increase the weight more than the bulk of the paper and therefore cannot be largely used in light, bulky papers such as the so-called "featherweights." On the other hand, when they are used in very large amounts, and the paper subjected to supercalendering, they are of great assistance in producing the effects desired in imitation coated papers. When a filler is used in large amount it quite seriously reduces the strength of the paper produced; hence when the strength of a paper is specified, and a filler is used, a better grade of fibrous stock must be employed and more care used in manufacturing than if no filler were used. This has been amply demonstrated in Germany where in 1904, at the instigation of the Royal Testing Office, the restrictions as to amount of ash in the various classes of papers were abolished. Since that time it has been found that the requirements for strength have sufficed to keep the percentage of ash very largely within the limits formerly prescribed. The amount of filler also has a notable effect on the sizing, for as the percentage of ash in the paper rises the sizing, as shown by the

time required for writing ink to penetrate the paper, decreases. This is well illustrated by the curves in Fig. 36, which show the percentage of ash and the sizing tests on a large number of samples taken from the same run of paper.

The materials commonly used as fillers are china clay, talc, asbestine, calcium sulphate in its various forms, heavy spar,

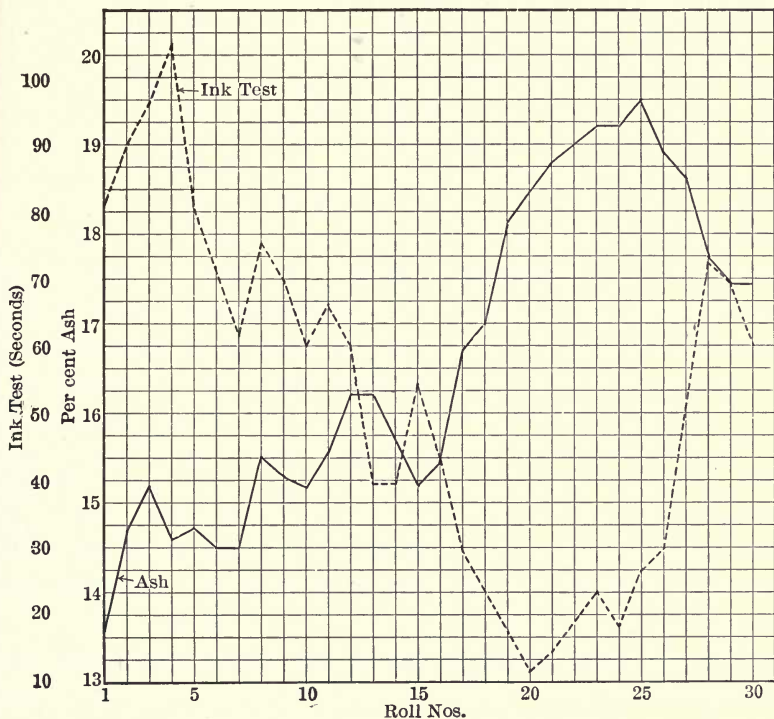

FIG. 36. EFFECT OF FILLER ON SIZING

blanc fixe and precipitated chalk. Many of these are sold under trade or fancy names and frequently at prices which do not correspond to their actual value. In addition to these, certain colors, as ochre, lead chromate, ultramarine, etc., are sometimes used in sufficient quantity to affect the bulk and ash of the paper, but as these are used primarily for coloring, and their loading effect is merely incidental, they will not be considered here.

The qualities to be considered in judging a filler are color, fineness, absence of grit, mica, etc., solubility, specific gravity and chemical composition. The chemical analysis of a filler, as a means of checking individual shipments of the same material, is of little value, except in special cases where for some reason a certain constituent must be proved absent, or else present in definite amount. It is essential, however, to know the chemical composition of the various fillers, as this makes it possible to tell from the analysis of a paper ash what kind of filler was used, and it is also necessary if it is desired to know the amount of filler in the paper, as many fillers, on igniting the paper to an ash, lose water which would normally be retained by them in the finished paper. The specific gravity is of importance, as it shows how the filler will affect the bulk of the paper, while the presence of grit in any considerable amount indicates that the wires, felts and jackets will be subjected to unnecessary wear and that the paper may be defective to such an extent as to cause serious trouble in printing. When making heavily colored papers in which soluble dyes are used, the type of filler should be selected only after consideration of the dye to be used, for different fillers have different absorptive capacities for the various dyes. Proper selection of the filler will therefore be of considerable assistance in obtaining satisfactory absorption of the dye and in reducing its loss. The relation of fillers to dyes will be discussed in Chapter XI.

The proportion of the filler added to the engine which appears in the finished paper is spoken of as the retention. This may vary from 30 to 90 per cent, though the latter figure is only reached under very exceptional circumstances and a retention of 50 per cent is generally considered satisfactory. Many factors, other than the filler, influence its retention and it is impossible to estimate their effects, except in a general way. The kind of stock and the extent of its beating, the speed of the paper machine, the pull on the suction boxes, the amount of filler added and the thickness of the sheet must all be taken into consideration. Slow or "greasy" stock, a light suction and a thick sheet all

tend to give high retention, while in the case of sulphate of calcium the retention increases with the amount added.

A study of the loss of filler taking place at different parts of the paper machine was made in a German mill¹ during the running of a rotary press print paper of 50 grams per square meter, made from stock containing 25 per cent sulphite and 75 per cent ground wood. The ash in the air dry stock at various points was as follows:

	Per cent
Stock from the chest.....	20.0
Stock just before suction boxes.....	19.0
Stock after the couch.....	15.0
Stock after first press.....	14.0
Stock after second press.....	13.5
Finished paper.....	13.0

The apparently slight loss in the drainage through the wire is due to the fact that the white water was used over again and the ash in the stock actually flowing onto the wire would therefore be greater than that in the chest.

Working with sulphite, and with sulphite and soda furnishes, Kress and McNaughton² found the retention to decrease slightly as the amount of clay added was increased. This is contradictory to the results given in the subjoined table from observations by the author. They also found, as would be expected, that increasing the thickness of the sheet — or the ream weight — increased the retention. It was also increased as the amounts of size and alum were increased, and by greater hydration of the stock in the beater.

The following figures from tests made under the observation of the author show what may be expected from various fillers when used in manufacturing high grade book papers.

¹ Paper: 1916, Sept. 20, p. 13, from Wochbl. Papierfabr.

² Kress and McNaughton: Paper, Oct. 3, 1917.

Filler	Percentage in finished paper	Percentage retention
China clay.....	39.1	76.2
“ “.....	32.2	74.6
“ “.....	26.7	68.6
“ “.....	25.6	66.5
“ “.....	15.1	57.6
Precipitated chalk.....	24.8	38.7
“ “.....	19.1	40.9
“ “.....	12.0	36.6
“ “.....	9.7	54.0
Asbestine.....	22.3	72.4
“ “.....	10.8	46.1
“ “.....	10.2	52.4
Pearl finish.....	24.9	64.4
Crown filler.....	24.2	51.2
Blanc fixe.....	27.9	39.0

Clay. Clay is a soft, friable, sectile, white substance showing irregularly shaped particles under the microscope and possessing only a moderate plasticity when mixed with water. It is a mixture of hydrated silicates of alumina containing particles of quartz, mica and felspar and its chemical composition is approximately $\text{Al}_2\text{O}_3 \cdot 2\text{SiO}_2 \cdot 2\text{H}_2\text{O}$. It is formed by the weathering of felspathic minerals and the presence of mica indicates its granitic origin. Those clays which remain overlying the rock from which they were formed are known as residual, while those which have been conveyed to a distance by eroding influences are called sedimentary. The former are usually more free from iron and of better color than the latter. Good grades of clay are found in England, France, Bohemia and the United States, but in spite of our own deposits the greater part of that used in this country is still imported. This is probably due in large part to insufficient care or improper methods of preparation, and it is thought that these will shortly be overcome so that domestic clays will play a much more important part in American manufacture.

Clay is prepared for the market by washing it with a stream of water through long sluices of riffles, in which the sand and mica are caught, into tanks or basins in which the fine clay is

allowed to settle. The water is then drawn off and the clay dug out and dried when it is ready for market. Instead of these crude methods the fine clay and water is sometimes passed through filter presses, and there has recently been proposed an electrolytic method of purification and separation which is claimed to give a product perfectly free from grit and much dryer than that from any filter press. Even the very finest washed clays contain a small proportion of sand and mica and there is always some moisture present. For English clays up to 12 per cent is permissible though it more frequently runs under than over that figure. It is not well to have a clay too dry as it causes loss in handling and the dust is bad from a hygienic standpoint. Freezing moist clay causes no permanent change in composition or physical properties so that clay which has been frozen can be used with perfect safety after it has been thawed out.

The following analyses give a good idea of the composition of different grades of clays; numbers one to four being English clays tested by Remington¹ while five and six are American clays.

No. of clay.....	1	2	3	4	5	6
Used for.....	Coatings	High grade papers	News	White printings
Silica, SiO ₂	46.21	47.60	46.46	45.92	45.67	43.36
Alumina, Al ₂ O ₃	39.82	38.26	37.40	38.43	37.86	40.54
Ferric oxide, Fe ₂ O ₃ ...	0.38	0.55	2.00	0.71	1.48	0.90
Lime, CaO.....	0.45	0.42	0.86	1.18	0.05	0.08
Magnesia, MgO.....	0.10	0.20	0.21	0.21	0.01	0.38
Alkalis, K ₂ O.....	0.23	0.57	1.26	0.78	0.80	0.88
Total water.....	12.81	12.40	11.81	12.77	13.22	13.86
Grit per cent.....	100.00 0.09	100.00 0.32	100.00 2.22	100.00 2.28	99.09	100.00

The similarity of these analyses is quite noteworthy and it is evident that, apart from the ferric oxide which seriously influences

¹ J. Ind. Eng. Chem., 3, 555.

the color, the qualities by which a clay may be judged are largely physical. It is stated by one authority that if the grit rises over 2 per cent the clay would be objectionable for high grade newspaper.

The total water in these clays is very largely that chemically combined. This is not driven off on drying at 100° C. but is expelled at a red heat or at the temperature of the usual ash determination. For this reason the percentage of ash as determined in a paper loaded with clay should be divided by 0.88 in order to convert the ash into the approximate amount of actual filler; this is neglecting the ash from the fibrous materials and from the size and alum which is usually insignificant in comparison with the filler. Clay loses all hygroscopic moisture at 100° C. and all combined water at about 500° C. Clay which has been dried at 100° regains its plasticity on soaking in water. In this connection it should be noted that some air dry clays contain a small amount of moisture which is driven off on drying at 100° C. and again absorbed on exposure to the atmosphere. In a number of high grade clays this moisture was found to amount to 0.43 to 0.77 per cent of the weight of the air dry clay.

The size of particles varies greatly in different clays and the proportion of coarse and fine particles may be quite different in clays which are very similar in appearance. Tests of a number of clays by separation of the particles which settle 1½ ins. in different lengths of time gave the following results:

	Domestic	UXL	GAC	GH	AR
	Per cent	Percent	Percent	Percent	Percent
Settling in 1 minute.....	2	4	26	13	44
“ “ 1-10 minutes.....	20	24	10	35	25
“ “ 10-120 “	30	37	28	25	12
“ “ over 2 hours.....	48	35	36	27	19

In the case of UXL clay the sizes of the particles separated in this way were found to be

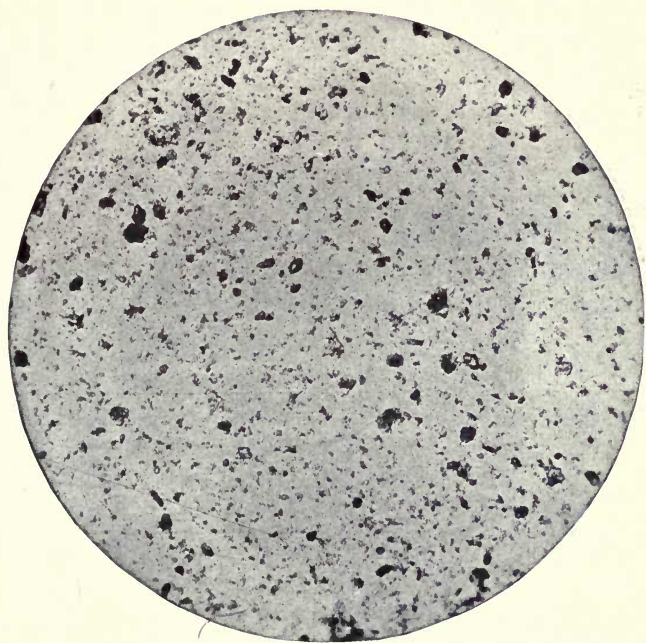

PLATE 27

Domestic Filler Clay. Magnification 100 diameters. Photographed by
Bureau of Standards.

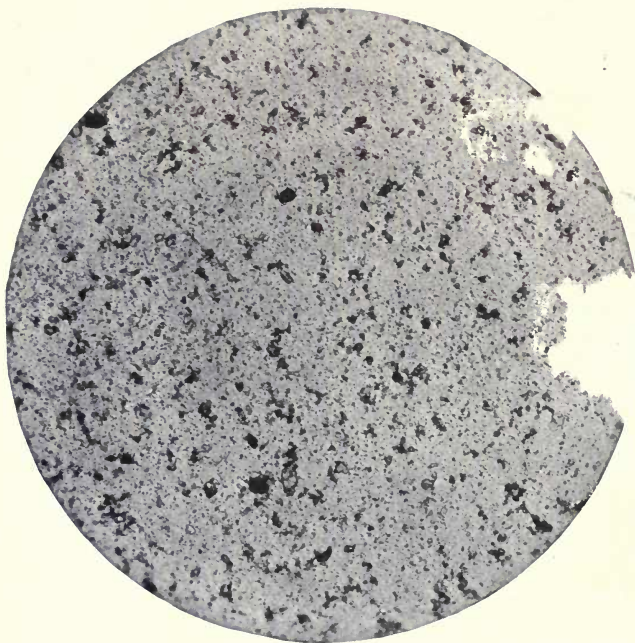

PLATE 28

English Coating Clay. Magnification 100 diameters. Photographed by
Bureau of Standards.

Settling in 1 minute.....	0.028 m.m.
“ “ 1-10 minutes.....	0.007-0.018 m.m.
“ “ 10-120 minutes.....	0.0035-0.007 m.m.
“ “ over 2 hours.....	0.0015 m.m.

The specific gravity of clay is variously given as 2 to 2.86. Observations by the author on six different samples of thoroughly dried English clays showed them to range from 2.568 to 2.634. The weight per cubic foot of clay as ordinarily received varies according to the method of handling from 53 lbs. when the fine material is run in loosely to 84 lbs. when the clay is tamped in hard. This is for clay with about 7.5 per cent of moisture.

Clay is usually added to the stock in the beater soon after it is furnished so that it may be well distributed before the alum is added. The old way was to add the dry clay direct to the beater but the more progressive mills are now mixing the clay with water and straining before adding to the stock, thus avoiding much dirt. In preparing domestic clays for use in this way ammonia or sodium phosphate is sometimes found to be of assistance in helping the clay to work up and in keeping in suspension. In testing this clay mixture for uniformity it should be noted that the consistency of a clay-water mixture is dependent on the physical qualities of the clay as well as upon the amount used. Of six clays which were mixed in such a manner that 100 c.c. of the mixture contained from 19.6 to 19.9 per cent of dry clay the Baumé readings varied from 16.5° to 23°. It should be noted that this method cannot be used for daily control if the clay supply varies.

A satisfactory control test for the clay mixture supplied to the beaters may be made by determining the weight of a definite volume of the mixture in comparison with an equal volume of water. A 250 c.c., glass stoppered, ungraduated flask is a convenient volume to use. First clean, dry and weigh the empty flask including the stopper; then fill it completely with distilled water, insert the stopper carefully so that no air is trapped, dry the outside of the flask and weigh again. Once these two weights are established for a given flask they may be consid-

ered as constants. The test therefore consists simply in filling the flask with the clay mixture, cleaning the outside, especially around the stopper, and weighing.

Assuming the specific gravity of clay to be 2.6 the calculation of the weight of dry clay in the flask would be as follows:

Let x = weight of dry clay in flask

y = weight of water in flask

w = weight in grams of flask full of clay mixture

c = capacity of flask in cubic centimeters = weight of water it will hold

f = weight of empty flask in grams.

Then $x = w - f - y$

$$y = c - \frac{x}{2.6}$$

$$x = w - f - c + \frac{x}{2.6}$$

$$x = \frac{2.6(w - f) - 2.6c}{1.6}$$

$$x = 1.625w - 1.625(f + c).$$

Since f and c are constants it is only necessary to make a single weighing of the flask full of clay mixture in order to be able to calculate the amount of dry clay it contains. This can be converted readily into pounds per inch in any measuring tank which may be used.

This method of testing has been employed in mill control work for a number of years and if the flask is weighed to a tenth of a gram the results are found to check closely with those obtained by drying and weighing a definite volume of the clay mixture.

Gypsum. This is a natural calcium sulphate, $\text{CaSO}_4 \cdot 2 \text{H}_2\text{O}$, and is prepared for use as a filler by grinding, or it may be calcined, finely ground, washed and dried quickly to prevent its reabsorbing water and becoming hard and compact. The ground,

uncalcined mineral has the form of plates. Three-quarters of the water of crystallization of gypsum is driven off at a temperature of 120° C. and the calcined gypsum which is formed takes up water readily and sets to a firm mass. If, however, the gypsum is heated to over 160° C. there is formed an anhydride which absorbs water very slowly and hence may be rapidly washed. This anhydride on long soaking in water changes in form from the irregular particles of the ground mineral to small needle-shaped crystals. This change takes place so slowly that it is doubtful if it is completed during the time elapsing between the furnishing of the engine and the running of the stock into paper.

Gypsum is generally added directly to the beating engine and results in the production of rather soft paper. Its use also tends to fill up the felts due to the crystallization of $\text{CaSO}_4 \cdot 2\text{H}_2\text{O}$. All gypsum is soluble in hydrochloric acid, or in 400 to 500 parts of water, which causes serious loss and poor retention unless the back-water is used over again. This solubility has not been found to interfere in any way with the rosin sizing in the engine in which it is used and in certain cases it is even claimed to be beneficial. The loss on ignition of calcined gypsum is only 0.5 to 2 per cent, while that of the uncalcined material is nearly 21 per cent.

Pearl Hardening is an artificial, hydrated calcium sulphate made by precipitating a solution of calcium chloride with sodium sulphate. It may occur in two forms, flat, tabular crystals or minute, needle-shaped crystals. Its specific gravity is 2.39 and it loses 21 per cent of its weight on ignition. Other names for calcium sulphate preparations, either hydrated or anhydrous, are Pearl White, Crown Filler, Pearl Finish, Annaline, Alabastine, etc. Some of these contain considerable water besides that chemically combined, and extravagant claims are frequently made as to their advantages both as to the finish imparted to the paper and the amount retained. These claims are to be taken with a grain of salt as all possess essentially the properties of gypsum or pearl hardening.

Precipitated Chalk or calcium carbonate is occasionally used as a filler particularly in very thin papers of the Bible class such as are now used so largely for the printing of dictionaries and encyclopædias. It may be added directly to the engine but much better results are obtained by mixing a solution of calcium chloride with the stock and, when it has become thoroughly incorporated, precipitating it with a solution of sodium carbonate. Care should be taken that the quantities used are approximately equivalent as otherwise serious losses may occur; a slight excess of either one has not, however, been found to be injurious to the paper though a large excess of calcium chloride would cause it to absorb moisture and become limp and lifeless.

Calcium carbonate seriously interferes with the rosin sizing and even when the size is precipitated by alum before the filler is added it has been found practically impossible to produce a well-sized sheet. The advantage of precipitated chalk lies largely in its color since it imparts to the paper a much whiter color than can be obtained by the use of clay. It also gives the paper a characteristic velvety feel though it does not take such a high polish on supercalendering as does a clay-filled paper.

Talc. Talcum or Spanish chalk is a hydrated silicate of magnesium. A part of the magnesia is nearly always replaced by alumina so that it may be regarded as a double silicate of magnesium and aluminum with the magnesium largely in excess. It is very soft, has a characteristic soapy or greasy feel and is usually of a creamy or greenish white shade. Its specific gravity is 2.6 to 2.9. It is very resistant to acids and solutions of alkalis and also to heat, losing no water below a red heat. In preparing it for the market the stone is sorted according to color and then ground and graded either by an air blast or by bolting. The product is not so fine as clay and the grit is usually greater. It is often adulterated with heavy spar or more often with ground limestone.

Talc improves the printing qualities and the feel of the paper and gives it a rag-like appearance. It is said that 20 per cent

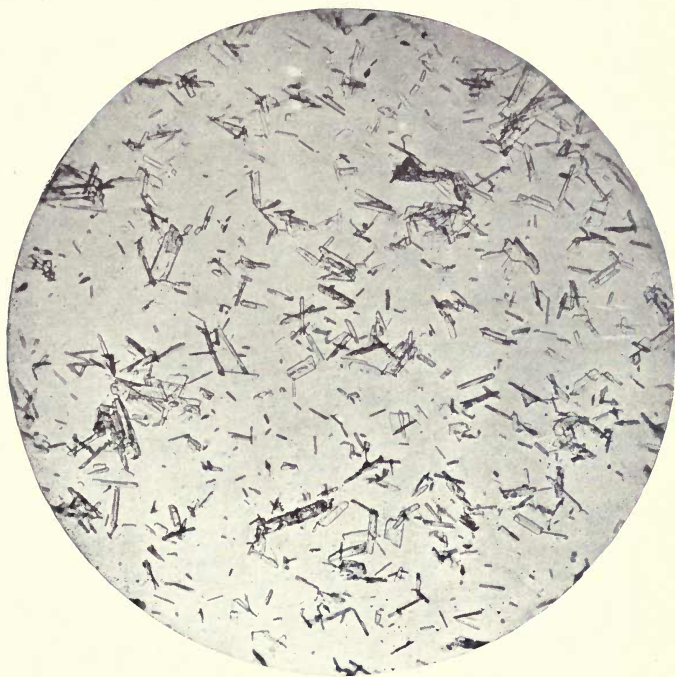

PLATE 29

Crown Filler. Magnification 100 diameters. Photographed by
Bureau of Standards.

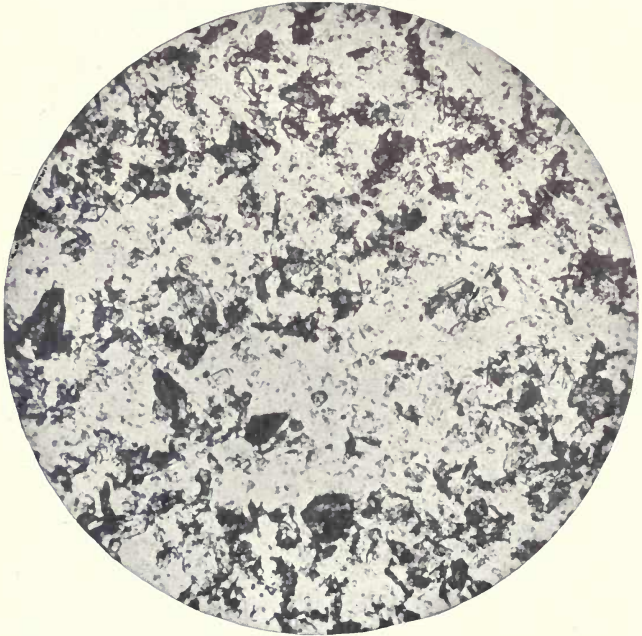

PLATE 30

Talc. Magnification 100 diameters. Photographed by
Bureau of Standards.

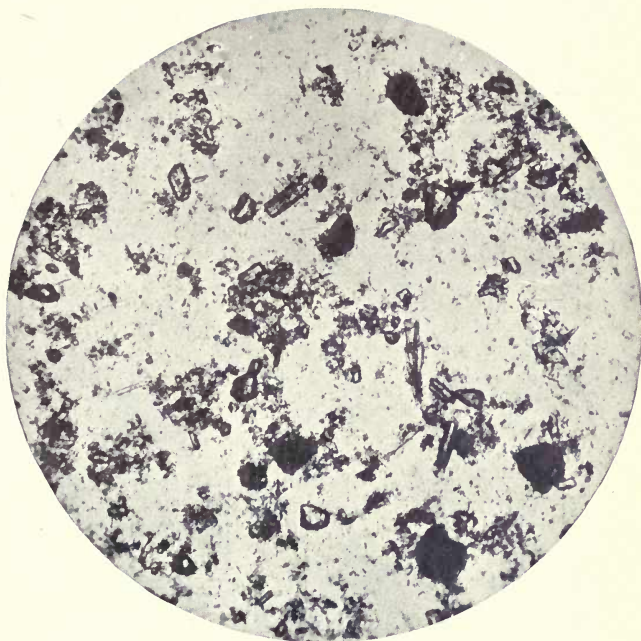

PLATE 31

Asbestine. Magnification 100 diameters. Photographed by
Bureau of Standards.

of talc will give the same results as 30 to 40 per cent of lower grade china clay.

Asbestine, or agalite, is a fibrous talc which occurs as an alteration product of tremolite. It is of American origin and is extensively prepared in St. Lawrence County, N. Y. It is nearly pure (95 to 97 per cent) magnesium silicate and being in the form of rodlets attaches itself well to the fibres and gives good retention. It does not impart quite so high a finish to the paper as does talc. The best grades are free from sand, nearly free from iron and almost snow white. This material loses up to 1.3 per cent on drying at 100° C. and from 0.5 to 7 per cent on ignition. The following analyses are fairly representative of the composition of asbestine or agalite.

	1	2	3
Silica, SiO ₂	60.59	61.89	62.01
Alumina, Al ₂ O ₃	0.13	1.36	0.31
Ferric oxide, Fe ₂ O ₃	0.23	0.44	0.10
Manganese oxide, MnO.....	1.16
Calcium oxide, CaO.....	4.21
Magnesia, MgO.....	34.72	30.70	32.12
Water.....	3.77	1.40	4.30
	<u>100.60</u>	<u>100.00</u>	<u>98.84</u>

Heavy Spar and **Witherite** are sometimes used as fillers. The former is a naturally occurring barium sulphate, BaSO₄, while the latter is carbonate of barium, BaCO₃. In preparing the heavy spar the foreign stone is broken off and the spar is first ground dry, then wet and finally washed.

Neither of these materials is very satisfactory as their high specific gravity, 4.2 to 4.5, causes much loss of filler and also settling on the wire so that the two sides of the sheet are not alike and the wire side is particularly destructive to pens and type. If barium sulphate is to be used as a filler it should be precipitated in the engine by adding first barium chloride and then a solution of sodium sulphate and great care should be exercised that loss does not occur through an insufficiency of the latter.

Testing Fillers. The color of fillers is best determined by comparison with standard samples of similar materials. As the moisture present has a very great influence on the color, especially with clays, the materials compared should be equally dry. This is readily assured by drying at 100° C. before comparing. One method, which is extensively used, is to mix the material to a paste with water on a glass plate and after drying to compare with the standard, similarly treated. A better method and one which can be rapidly carried out is to use a block of wood in the top of which there are shallow compartments separated by knife edges

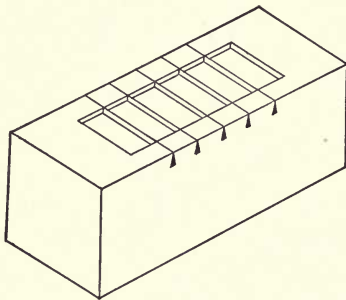

FIG. 37. BLOCK FOR TESTING COLOR OF CLAYS

coming flush with the upper surface of the block. Such a testing block is shown in Fig. 37. Into one of these compartments the standard material is pressed by means of a polished steel spatula and in the next the filler to be compared is placed. The knife edges permit of very close contact of the two samples, the polished spatula gives a good

surface and the small size of the block allows it to be easily handled so that it may be held in any position with regard to the light and the samples examined from all sides.

In many cases it is well to note how much a filler can be improved by the addition of blue. This may be readily done by grinding the dry filler in a mortar with a very little ultramarine and then comparing the color with the same material unblued or with the standard.

To determine whether a clay has been blued, it may be moistened with turpentine to form a rather thin paste on a porcelain plate, and then compared with samples which are known to be blued and unblued and which have been treated in the same manner. The artificially colored clays are said to give a bluish green color but as it is claimed there are a number of natural

English clays which give this same color with turpentine the test cannot be considered as conclusive.

A better method is carried out as follows: In one of two similar white porcelain dishes place a measured amount of freshly prepared saturated lime water and in the other dish an equal amount of distilled water. Then into each of these liquids dust, from the end of a knife or spatula, a little at a time, equal amounts of the clay. After allowing to stand for a few minutes the excess liquid should be siphoned off and the moist clay examined. If the clay has been artificially blued the lime water will remove the bluing so that the two samples will appear quite different after this treatment. Although neither of these tests is entirely satisfactory, yet if both are applied it is possible to get a fairly accurate idea whether the sample has been artificially blued or not.

The grit in clay or other loading material may be determined in a number of ways. One roughly quantitative test is to place a little of the clay in the mouth when the grit may be readily detected between the teeth. A more accurate procedure and one which may be easily duplicated by independent operators is to weigh out a sample of the clay, place it on a standard mesh screen and wash it with a spray of water until the water running away is perfectly clear. The residue on the screen is then dried, weighed, and reported as grit. The size of the sample may be varied according to the preference of the operator but 20 grams has been found to be a convenient amount. Some form of spray head which delivers a fine spray under a considerable pressure will be found very satisfactory for washing the clay on the screen. It is also desirable to make the test on both 200-mesh and 300-mesh screens in order to get a more comprehensive idea of the character of the grit.

A flotation process which gives excellent comparative results may be carried out by means of a large, wide mouthed, bottle fitted with an inlet tube for water and a siphon whose inlet is always kept near the surface of the liquid by means of a float. This siphon is fitted with an automatic stop to prevent its en-

tirely emptying the bottle. The clay, or other filler to be tested, is mixed with water and placed in the bottle and water is forced in rapidly through the inlet tube until it rises to a mark near the neck. The mixture is allowed to stand a definite time and the siphon then started; this process is repeated until at the end of the settling period the water is perfectly clear for a definite distance down from the filling mark. Any material settling more than this distance in the standard time is considered as grit and its quantity is determined by drying and weighing. It is evident that the dimensions of this apparatus

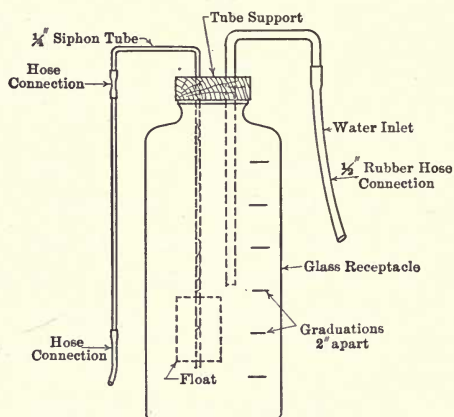

FIG. 38. APPARATUS FOR DETERMINING GRIT IN FILLERS

may be arranged to suit the convenience of the operator but those of an outfit which gives very satisfactory results with clay, blanc fixe, asbestine, etc., are shown on the accompanying sketch, Fig. 38. This method cannot be employed with calcium sulphate because of its slight solubility.

The grit, when separated by any method, should be examined by means of the microscope as its appearance reveals much as to the quality of the filler and gives some idea of the trouble it is apt to cause. Thus the grit from clay may be either sand or mica, and, while the former causes wear on the wire and sometimes pinholes in the paper, the latter may make shiny spots

which are apparent on looking across the sheet and also give trouble in printing.

Talc, as stated above, is often adulterated and hence its color is not a sure criterion of value. It should be tested for gypsum, calcium carbonate, mica, iron and sand. The usual test for calcium carbonate is by boiling with acid and noting the loss in weight, but if the acid used is too strong the test may be erroneous because the solvent action includes other portions of the filler. Good grades of talc should not contain over 1 to 2 per cent of oxides of iron or over 3 to 4 per cent of CaCO_3 . Talc may be readily distinguished from clay by moistening with a little cobalt nitrate solution and warming over a flame; the talc gives a pinkish color and the clay a strong blue.

CHAPTER XI

COLORING

The importance of coloring matter to the paper industry is not always evident to the casual observer but it is at once realized when it is understood that very few papers are made without coloring matter of some kind. This is of course self-evident in the case of heavily colored papers, or even pronounced shades, but it is equally true of white papers, for very few of these are made of the natural color of the fibre. It may even be said that coloring, as applied to the production of shades of white, is of much more importance than in the making of colored specialities, for the production of the former runs into far greater tonnage. It is also true that the maintenance of uniformity in a tinted white requires more attention and care than in the case of deeper colored papers, for a slight error in the amount of color used will make an appreciable difference in the resulting shade, while with deeper colors an error of the same magnitude will have hardly noticeable results. Variations in the color of the fibres used are also much more serious in the case of tints than they are with deeper colors.

In coloring paper it is usually required that the shade of a sample be matched. When such a sample is submitted previous runs of paper should be looked over to see if anything of the same or a similar color has been made before. It is often the case that the records of former orders will show just about what coloring matters should be used and an engine can then be colored up and the paper compared with the sample as soon as it gets over the machine. When the shade desired is an entirely new one the use of a small beater, of a pound or two capacity, will be found very convenient. By using a weighed amount of

stock in such a beater, sizing and loading as usual, and noting carefully the quantities of colors used, the amounts necessary for the larger engines may be easily calculated. The stock prepared in the small beater should be made into sheets on a hand mould and dried on a steam heated drying cylinder. The sheets may then be compared, either before or after calendering, with the sample submitted. When such records or equipment are not available a small part of the sample should be reduced to a pulp with a little water, being careful not to use so much that coloring matter is lost by being washed out. The first engine is then colored up to match this wet sample. Whichever of these methods is used a sample of the paper should be taken from the winders, as soon as the color gets thoroughly over the machine, and compared with the sample submitted. If the shade is not right then the proper changes should be made at once, both in the stock in the chest and in the other engines which are being prepared.

In estimating the amount of dye to use due attention must be paid to the beating of the stock and the calendering of the finished paper. The more hydrated the stock has become from prolonged beating the less dye will be required for a given shade. Calendering and supercalendering also darken the shade.

When a colored order is to be made it is desirable to start in the morning so that plenty of daylight may be available for matching the shade. The nature of the light used for color comparisons is important and a subdued north light is generally considered best. This should be from a window not affected by reflections from neighboring buildings. Whatever light is selected as a standard, it should be used for all color work as the same results cannot be obtained if south light is used one day and north light the next. Difficulties from variations of light are entirely avoided if one of the color matching outfits, or so-called "daylight lamps," is used. These vary more or less in quality but several excellent ones are on the market. To give the best results a lamp of this type should be used in a dark room.

In comparing colors the first impression should be decisive as

the eye becomes less sensitive by prolonged staring. If doubt exists after the first glance rest the eyes by closing them, or by looking at some distant object, and then make a second comparison. When papers are being examined they should be folded to such an extent that their thickness prevents any light from being transmitted through them since it is the light reflected from the surface which it is desired to compare. It is also well to change the samples from side to side — that in the right hand being transferred to the left, and vice versa — since the relative positions of the sheets has an influence on their apparent colors.

[In the coloring of paper the materials used may be divided into two general groups, the pigments, which are for the most part insoluble materials, and the dyes, which are generally employed in solution.] (Each of these classes has certain advantages and disadvantages which must be taken into consideration in selecting the coloring matter to be used in any particular lot of paper.)

[**Pigments.** Pigments are as a rule very fast to light and have the added advantage that they increase the weight of the paper by acting as fillers. They are not generally so brilliant as the dyes and have been in most cases replaced by the latter.] They have properties, however, which make them valuable for certain papers and they should not be overlooked because they are more or less old fashioned. Both pigments and paste colors may with safety be added directly to the beater though heavy colors such as the canary and orange pastes may advantageously be thinned with a little water to prevent the settling of lumps and to insure their thorough mixing with the stock. > While coloring with pigments is a purely mechanical operation it is at the same time necessary to pay due attention to the nature of the materials used and to those of the substances with which they come in contact; otherwise trouble will be caused by using simultaneously substances which are injurious to each other.

Natural mineral colors are obtained from numerous natural deposits but before being of value they must be ground and separated in some way from any coarse or gritty particles. The

fineness of their particles never equals that of the pigments produced by chemical means but the finer they are ground the better results they will give. In addition to this mechanical treatment some of the earth colors are also treated chemically and in some cases various shades are obtained by heating the colors to certain temperatures. The shades of the natural mineral colors are usually of a subdued rather than a brilliant nature but so far as permanence is concerned they are not equaled by any other class of colors. Among colors of this class which are of interest to the paper maker are ochres, and red and brown earth colors. Whites, which would also come in this class, such as clay, gypsum, blanc fixe, etc., are discussed in the chapter on fillers. and

Ochres depend for their coloring power upon ferric oxide or hydrated ferric oxide, and various shades from yellow to brown are found upon the market. The best are finely divided powders, soft to the touch, and possessing plastic properties; dark-colored brands of this nature are generally richest in coloring matter. Ochres are sometimes mixed, or "topped," with chrome yellow to produce more brilliant shades; such products possess the defects of chrome yellow and if used without proper precautions are likely to cause trouble. 7

The red earths owe their coloring power to the presence of amorphous ferric oxide. This is the chief ingredient in red hematite, which is the basis for numerous colors. Other reds are obtained by heating to redness, clays which contain hydrated ferric oxide. This class of colors includes a number of "red oxides," varying from yellowish to bluish red, and also Pompeian and Venetian reds which are usually of less strength than the "oxides."

Among the brown earth colors are "velvet," "umber" and "chestnut" brown which depend upon burnt ferric hydrate for their coloring power. True umber consists mostly of manganese silicate which is greenish brown in its natural state but becomes a rich deep brown on burning.

These natural mineral colors are largely used in the production of wall paper, for which purpose their subdued shades, their fast-

ness to light and their resistance to atmospheric influences render them especially suitable.

Artificial mineral colors are still used quite extensively in the coloring of paper, though, as already stated, many of them have been replaced by aniline dyes. Among those which are still relatively important are chrome yellow, Prussian blue and ultramarine.

Chrome yellow may be obtained in the paste form from the manufacturers of pigments or it may be prepared directly in the engine by adding first nitrate or acetate of lead and when this is thoroughly mixed following with a solution of potassium or sodium bichromate. This determines the precipitation of lead chromate upon the fibre, in a very finely divided state. The color produced is influenced by alkalis, very small amounts of which are sufficient to darken the shade. Heat also influences the shade to a marked extent which necessitates very careful handling of the paper on the driers if irregular results are to be avoided. As the lead salts used are readily soluble in cold water no heating is necessary at this point and for the purest yellows the size and alum solutions should also be cold when used. The choice between the ready made paste color and that prepared in the beaters is largely a question of personal preference. The paste colors are comparatively simple to use and the matching of shades is much facilitated when they are employed; on the other hand the production of the color in the beater aids in the fixing of the color and in the obtaining of even shades.

Chrome yellow is very fast to light but is destroyed by hydrochloric acid. As the lead salts are dangerous poisons, their use is not to be recommended, and whenever possible the substitution of yellow dyes would appear to be good policy.

Chrome yellow may be converted into chrome orange, or basic lead chromate, by treatment with caustic soda or hot milk of lime. This color can be used for unsized papers only as it reverts to chrome yellow in the presence of aluminum sulphate.

Prussian blue is classed with the mineral colors because of its iron content. It may be produced directly in the beater by add-

ing ferrous sulphate followed by potassium ferrocyanide; the white precipitate which is first formed is rapidly oxidized by exposure to air with the formation of the blue color. This action may also be hastened by the addition of bleaching powder or acid to the beater. As the ferrocyanide is the more expensive of the two ingredients any excess is carefully avoided and it is customary to use three parts of ferrous sulphate to two of the ferrocyanide although two parts of the sulphate are usually sufficient for the full development of the color. Prussian blue which has been oxidized in the beater sometimes causes the paper to turn red after some time. This can be avoided by washing the stock nearly free from acid or better by employing a Prussian blue prepared outside the beater and washed before use.

[Paper colored with Prussian blue has the peculiarity that exposure to sunlight partially decolorizes it; the full blue shade is, however, again developed when the paper is kept in the dark in contact with the oxygen of the air.] Prussian blue is affected by alkalis, particularly caustic soda, which destroys the color with the formation of ferric hydrate; treatment with acid restores the color. When using it in the beater it is well to see that it is added while the reaction is slightly acid due to the presence of alum.

Soluble Prussian blue is produced when a ferric salt is added to an excess of a solution of ferrocyanide. The soluble product also results if Prussian blue is boiled in a ferrocyanide solution. It is soluble in water but is precipitated by salts.

[Ultramarines are formed when aluminum silicate is calcined with sodium sulphide.] In actual practice the sulphide is formed from the action of sulphur and carbon upon sodium sulphate or carbonate.

Ultramarines are manufactured in various shades of blue from a greenish to a reddish tone and there are even pure greens which, however, find little use in coloring paper. They are made by heating mixtures of pure clay, sodium sulphate, sodium carbonate, sulphur, silica and charcoal; the mixture after heating is finely ground and washed. The proportions of the ingredients

vary with the different manufacturers but in general three grades are made as follows:

1. Sulphate ultramarines are those made with sodium sulphate. They are the palest, are greenish in tint and are most easily attacked by alum.

2. Soda ultramarines low in sulphur are pure blue and darker than the sulphate ultramarines.

3. Soda ultramarines high in sulphur and silica are the darkest and have a reddish tinge. They are the most resistant to alum.

The finished ultramarine contains sodium, aluminum, silicon, sulphur and oxygen; its actual constitution is not known and no theory so far proposed accounts for all its properties. Ultramarines are absolutely fast to light and are not changed by exposure to the atmosphere or by weak alkalis. They are decomposed by mineral acids with evolution of hydrogen sulphide and destruction of the color. They are darkened by moisture which is taken advantage of by unscrupulous dealers who add water, glycerine or molasses to make them appear of greater strength. For this reason ultramarine should not be purchased on the basis of its appearance but actual coloring tests should be made. The different products vary in the fineness of their particles and the ease with which they mix with water. Both of these points should be considered since if they are not satisfactory spots or color streaks are likely to appear in the paper.

When used for tinting in the production of white papers ultramarines give bright effects which are hard to equal with other coloring materials. If they are used for deeper colors the two sides of the sheet are apt to vary in shade because of the loss of pigment in passing over the suction boxes.

Another pigment which is still used occasionally for gray or black papers is lamp black. If used in large proportions it tends to cause streaks and specks in the paper and to make it smut badly. Its low specific gravity makes it difficult to handle without getting it all over the beater room and uniform results are hard to obtain because the shade depends so much on the length

and nature of the beating which the stock has had. Lamp black is being replaced by various mixtures of soluble dyes.

Natural Organic Colors. Colors of this class, of a vegetable or animal origin, were formerly much used in coloring paper but they are no longer employed to any extent because of the better and cheaper results obtained with the coal tar colors. For this reason brief mention of their names and properties is all that seems desirable.

Annatto is derived from the fruit of the annatto tree and gives shades of orange. It is costly and fugitive.

Turmeric is prepared from the roots of *Curcuma tinctoria*. It dyes paper pulp a direct yellow which is fast to acids but is sensitive to light and alkalis.

Weld is obtained from the blossoms of *Reseda luteola*. It gives various shades of yellow according to the mordant used.

Quercitron is the powdered bark of *Quercus tinctoria*. It gives yellow shades when used in the same manner as weld.

Safflower is obtained from the petals of *Carthamus tinctoria*. It gives pinks of great beauty but they are fugitive to light and air.

Redwoods. Various species of *Cæsalpinia* have been used for the dyeing of pink and reddish shades which are not very fast to light.

Cochineal is obtained from the cochineal insect and was formerly used as a pink for toning white papers.

Cutch or Catechu is the dyestuff obtained from *Mimosa catechu*. It gives shades of brown which are fast to light, acids and alkalis.

Logwood is obtained by extracting *Hæmatoxylon campechianum*. It is used for blacks in conjunction with iron salts and tannic mordants.

Artificial Organic Colors. This class includes all the so-called coal tar colors or aniline dyes. They are superior to other coloring matters in brilliancy and purity of shade, coloring power,

solubility and ease of application and their chief drawback is lack of fastness to light.

In using these dyes the method of working depends on the fibre to be dyed and the nature of the coloring matter used. A knowledge of the methods employed in textile dyeing is of considerable assistance though the impossibility of thorough washing in the beater renders impractical the use of many of these methods. Moreover since vegetable fibres only are used in paper making any methods which are applied to wool or silk are only of abstract interest to the dyer of paper. It must be borne in mind that the different fibres in mixed stock may have different affinities for the coloring matter and by taking it up in different degree cause an uneven or variegated appearance. [If clear light shades are desired only bleached pulp may be used while the heavy, deep colors can with advantage be obtained on unbleached stock.

[Fillers which take up the dyes assist in obtaining even shades and whenever possible the filler should be selected with this object in view. To allow the filler to absorb the greatest amount of color it should be added after the dye but before the size.

The combination of the filler and the dyestuff is regarded by some as a chemical phenomenon while others consider it purely a physical action depending on the ability of the filler to form colloidal solutions. [The amount of dye taken up by different fillers has been determined by Heuser¹ who gives in the following table the percentage of the added dyestuff taken up by the filler when 10 grams of the latter are treated with 0.4 gram of color.

¹ E. Heuser: Wochbl. Papierfabr., 1914, 2288 and 2470.

Color	1	2	3	4	5	6
	Asbestosine	Blanc fixe	Bohemian earth	China clay	Kaolin	Talc
Malachite green.....	96.65	32.40	28.62	45.32	72.75	49.95
Crystal violet.....	99.97	25.96	62.93	56.91	64.68	60.56
Manchester brown.....	97.83	28.25	40.00	40.87	72.86	40.62
Safranine.....	84.82	33.10	53.48	66.45	41.12	30.06
Chrysoidine.....	96.10	25.82	62.35	41.87	55.91	35.52
Alkali blue.....	66.10	15.52	48.35	31.75	25.73	35.26
Acid magenta.....	60.81	18.70	40.07	45.29	26.00	49.89
Ponceau.....	58.42	23.10	31.89	44.15	22.50	54.27
Cotton scarlet.....	68.75	33.47	41.00	45.62	20.25	60.12
Naphthol yellow.....	25.00	5.75	5.00	16.52	0.52	25.45
Diamine green.....	58.50	19.61	32.58	37.92	35.45	50.00
Dianil blue.....	96.32	30.45	48.03	38.09	53.93	60.76
Diamine violet.....	68.48	31.84	29.53	35.57	52.95	69.11
Diamine heliotrope.....	60.59	31.17	46.25	39.71	30.24	65.85
Diamine purpurine.....	59.89	50.02	47.51	56.14	43.93	60.48

The following figures by H. Ström¹ show the color absorbed in grams by 1 gram of filler from 100 c.c. of 0.1 per cent solution of the dyestuff.

	Asbestine	Blanc fixe	Talcum	Kaolin	China clay
Malachite green.....	0.005786	0.003715	0.005058	0.008425	0.008425
Safranine, conc.....	0.007752	0.004877	0.007752	0.009941	0.009941
Paper Scarlet ex.....	0.003715	0.002251	0.003237	0.001914	0.003237
Dianil yellow R.....	0.005786	0.006712	0.004518	0.005603	0.004518
Dianil red R.....	0.008039	0.010000	0.006526	0.006526	0.009404
Eosine ex. 5 B.....	0.000900	0.002764	0.002764	0.002936	0.002593
Paper deep black, conc..	0.005970	0.007277	0.004877	0.003633	0.006712

Not all dyes of the same class are taken up to the same extent by the same filler. Acid dyes can be removed almost completely from fillers by washing with hot or cold water; basic colors fix themselves on silicates but even basic colors can be washed out of blanc fixe.

Apart from all questions of the theory of dyeing the coloring

¹ Strom: Wochbl. Papierfabr., 44, 4516.

of paper pulp is not only a question of forming and fixing colored precipitates where pigments are concerned but also of fixing the soluble colors firmly on the fibres by means of mordants. Coal tar colors which form no precipitates with metallic salts and which are not fixed on the fibres when the pulp is acidified are of no use in coloring paper. The mordants in some cases serve to fix the color upon the fibre and make it more fast to washing, light, etc., while in other cases they combine with the dye as an essential constituent without which it would be uncolored or a worthless shade. Mordants are of two general classes, acid mordants, such as tannic acid and the fatty acid compounds used for fixing basic dyes; and basic mordants, consisting of the hydrated oxides of the heavy metals as tin, copper, chromium, iron, aluminum, etc., which serve for fixing the acid dyes. Basic mordants are employed in the form of soluble salts, such as the sulphate or acetate of aluminum, which react with the fibre with the deposition of the base which then attracts and fixes the color. Time is required for this reaction and different mordants give different colors with the same dye. [Cotton has little affinity for ordinary metallic salts but if they are present in very basic condition it may decompose them with the loose fixation of metallic hydroxides. Tannin on the other hand has a direct affinity for cotton and may be still more firmly fixed by the use of tartar emetic or glue. Linen is similar to cotton but is even more difficult to dye. While not strictly a mordant rosin size gives to fibres some of the properties of animal fibres and enables them to take up many colors without the use of any other mordant.]

The use of mordants, other than rosin sizing, is not nearly so general in the paper industry as in textile work and in many mills they are never employed.

[The water used in dyeing operations may have a considerable influence on the results. Finely divided vegetable impurities have little effect on either colors or mordants but inorganic impurities are much more serious.] [Hard water due to carbonates or bicarbonates of calcium or magnesium may cause partial precipitation of basic colors;] if it is necessary to use such water for

dissolving basic colors it should be corrected by adding a very slight excess of acid, preferably acetic acid. Salts of iron in the water are particularly bad as they discolor the fibres and act as mordants with the production of bad shades.

Dyes should not be added to the beater in the dry state except in very special cases, as sooner or later trouble with color specks will be encountered. They should be dissolved in soft, or condensed, water and strained through a hair sieve or through wet flannel before being used. The amount of water necessary varies greatly but in general is more for basic than for acid dyes; with some of the former it may be necessary to use as much as 200 lbs. of water for 1 lb. of color. Most colors may be heated nearly to boiling without danger, but a few, as auramine, methyl green, etc., are injured by boiling and should not be heated above 160° to 170° F. If the color separates from solutions which have been made some time it may be redissolved by heating and stirring. Some colors are insoluble or slightly soluble in water and in this case equal parts of methyl alcohol and water may be used.

The dyestuffs are variously classified by different writers. Direct or substantive colors are those which color the fibres directly without the use of a mordant; they are fully developed colors and always give the same shade, either weaker or stronger according to the amount used. Mordant or adjective colors are those which must be treated by chemical means in order to develop the true colors. This group forms with metallic oxides insoluble precipitates or lakes on the fibre. Colors which are of interest to the paper maker may be divided into four principal groups as follows: (1) direct colors, (2) basic colors, (3) eosines and rhodamines and (4) acid colors. The grouping of the acid colors separately is for practical rather than scientific reasons since the dividing line between the acid and the direct cotton colors is not at all sharp.

Direct Cotton Colors. These may be used on unmordanted fibres in a neutral or alkaline condition and they can be used mixed with each other in the same bath. Acid colors may usually

be mixed with the direct colors and used together though basic colors should never be mixed with direct colors either dry or dissolved. Dyeing with the direct colors is best done at the boiling temperature though it may also be done warm or even cold. If the stock is not heated the backwater is apt to be colored. Salt to the extent of 75 lbs. to a 1,000-lb. beater is also desirable to assist the fibre in taking up the dye. Under most conditions the colors tend to bleed from the fibres when they are mixed with white fibres so that they are not satisfactory for granite papers. This can be prevented to a certain extent by topping with basic colors and it is also claimed that by adding 10 lbs. of Glauber salt per 100 lbs. of fibre and boiling for three quarters of an hour fastness to water can be insured. The direct cotton colors are usually precipitated by lime and magnesia and water containing these substances should be corrected by boiling with soda ash.

These colors are particularly desirable for blotting papers and tissues where sizing cannot be used; they are also equally serviceable for sized papers. They exhaust well and a colorless backwater is usually obtained. They vary greatly in fastness to light, some being fully as fugitive as the basic colors while others are among the fastest colors known. Certain of the direct blues are increased in light resistance by adding a little copper sulphate to the beater after the dye has been taken up by the fibre. When 1 per cent or less of the dyestuff has been used 2 per cent of copper sulphate should be added but if over 1 per cent of dye has been employed an equal weight of the sulphate will be sufficient.

Basic Colors are salts of organic bases of artificial origin, the base containing the color bearing group. Most commercial basic colors are hydrochlorides, though sulphates, acetates, oxalates, nitrates or even double salts of hydrochloric acid and zinc chloride are also met with. In rare cases the color base is used. All basic colors are decolorized by reducing agents as zinc and hydrochloric acid. Some are decomposed into other substances so that the color cannot be regenerated but with most a colorless or "leuco compound" is formed which is easily oxidized to the

original color. In dyeing with basic colors the salts decompose, the basic part combining with the acid present in the fibre or fixed thereon by mordanting with tannic acid. The nature of the mordant or of the fixing metal does not greatly affect the shade of any given dye.

Basic colors have very great tinctorial power and are generally of pure and brilliant shades. They are fugitive to light but because of their great coloring power they are extensively used where permanence is not of the utmost importance. The affinity of all fibres for basic dyes is not the same, so when mixtures are being treated uneven dyeing may result; this can be avoided to a great extent by adding a little alum before the color or by adding the dye in a very dilute condition. When the fibres have a considerable affinity for the color, as with sulphite and jute, the dyeing may be done with the aid of rosin and alum or even alum only but for absolute fastness, as for use in making granite papers, mordanting with tannin is necessary. With unbleached sulphite there is a very strong tendency to absorb the color and to avoid uneven dyeing it is well to use the color in very dilute solution. For ground wood pulp basic colors are especially suitable and the dyeing should be done hot.

Basic colors may be used mixed with each other but never mixed with either acid or direct colors since precipitation results. If it is necessary to use both classes of color they should be dissolved separately and added separately to the beater. Many of the lakes formed by basic and direct colors are decomposed at 70° C., or even below, so where both are used it is well to avoid high temperatures. The use of acid and basic colors together gives colorless backwater; to obtain the best results it is well to use the basic dye first and top with the acid color. The exhaustion of the color is also aided by the filler which readily takes it up at comparatively moderate temperatures.

Eosines and Rhodamines. Commercial eosines are alkali salts of chlorine, bromine, iodine or nitro-substitution products of fluorescein or some of its derivatives, while rhodamines are

basic hydrochlorides of organic bases. Rhodamine B, for instance, possesses both acid and basic properties while the eosines have the properties of feeble acids. All of this group form leuco compounds on reduction and regenerate more or less rapidly on oxidation but not always to the same compound as the halogen is frequently removed by the reducing agent.

The eosines are mostly soluble in soft water or dilute alcohol, but with hard water insoluble lakes are formed so that such water must be corrected with soda ash. Rhodamines may be dissolved as with basic colors. Solutions of the eosines show more or less fluorescence particularly in alcoholic solution or in the presence of ammonia. Eosines are fast to alkalis but not to mineral acids; they are also affected by alum to a harmful extent so that an excess of the latter should be avoided. They have very slight affinity for vegetable fibres and their fixation is due largely to the sizing. They form lakes with metallic salts, those with lead being particularly brilliant; to obtain the best shades, therefore, sugar of lead may be used in the beater.

Eosines dye shades from yellowish to bluish red; they are remarkably brilliant but are very fugitive. Rhodamines are also very brilliant and are much faster. They are not much used on cotton because they cannot be permanently fixed on the fibre without impairing their brilliancy.

Acid Colors. Acid colors are of three groups (1) nitro compounds, (2) azo compounds and (3) sulphonated basic colors. They are decolorized by reducing agents but are differently affected; nitro compounds are converted into amino compounds from which the coloring matter cannot be regenerated; azo compounds decompose with breaking up of the azo group and cannot readily be linked up again; while the sulphonated basic colors form leuco compounds from which the color can be regenerated.

Acid colors can be mixed with each other to produce compound shades. They are not suitable for unsized papers as they have comparatively little affinity for fibres and cannot be fixed

on cotton or linen to resist washing. Rosin sizing is essential for good results especially for deep shades and better fixation is obtained if the color is added long enough before the size to insure thorough mixing before the latter is added. As a rule acid colors have comparatively little tinctorial power. They are quite variable in fastness to light but are generally more fast than basic dyes.]

Miscellaneous. Not mentioned in any of the previous groups are certain organic pigments especially the indanthrenes. These belong to a class of vat dyes which in textile work yield shades which are remarkably fast to light. While a number of vat colors are used in textile work the only ones which have been tried for coloring paper are the [blue indanthrenes.] These are sold in the form of paste colors, being insoluble in water and dilute acids or alkalis. They are used in the same way the pigments are and have the common fault of all paste colors that the strength of the color is continually changing because of the loss of water through evaporation. The colors obtained with indanthrene, at least where tints are concerned, are not particularly bright and as a class they have little to recommend them except their great fastness to light.

Various Applications. The foregoing [remarks apply chiefly to the coloring of paper stock in the beater. The coloring of coating to be applied to the surface of the paper follows similar lines, except that the colors used must in general be fast to alkalis since satin white contains considerable amounts of free lime and the casein is usually treated with an excess of alkali in dissolving. When pigments are used in coating they must be very finely divided and easily broken down into their ultimate particles since lumps of color will crush when calendering and form spots or streaks.

A third method of coloring is that known as stuffing, padding, or calender staining. Here the color is applied to the surface of a web of paper as it passes through the calenders. Soluble colors are necessary for this work and for absorbent, or very slightly sized, paper the solution may be made with water. If

the paper is hard sized, the color may be dissolved in denatured alcohol to make it penetrate the paper slightly. Acid dyes are much used for this type of work.

For the production of heavy colors a saving of dye is sometimes made by coloring the stock partly in the beater and when the paper is partly dried on the first section of driers running it through a vat of the color solution, then through squeeze rolls and finally over the rest of the driers.

Testing Colors. The tests which it is desirable to apply to colors are those which will show whether the material is of the same shade and strength as the standard. In the case of new samples it is necessary to compare their color and tinctorial power with dyes already in use, and also to apply tests to show whether they are sufficiently fast to the chemicals with which they will come in contact.

The most satisfactory method of testing colors, though by no means the quickest, is to color up a weighed amount of stock which has been beaten, sized and loaded in a small beater. Sheets made from this stock and dried will then give a permanent record of the shade and strength of the color in question. This method can be applied equally well to dyes and pigments but it is not very satisfactory for tints, such as the blue- or pink-whites, of the book or writing paper class.

With soluble colors the following method has proved satisfactory in most cases. Prepare a solution of one part of the dye in 1000 parts of water, noting carefully any insoluble residue. From this solution remove two samples of 50 c.c. and 25 c.c. respectively, place them in separate beakers of about 300 c.c. capacity, and dilute each to exactly 250 c.c. From a stock supply of dry, bleached, sulphite fibre prepare strips of the same size which will fit easily into the beakers of the diluted dyes. Plunge these strips into the solutions for exactly one minute, remove, drain and air dry. They can then be compared with the standard strips for shade and strength. For some of the very strong basic colors it is well to use 25 and 10 c.c. instead of 50 and 25. It is obvious that this test is

comparative only and that the quantities and volumes may be varied to suit the wishes of the observer.

With pigments the following test has proved very convenient. Weigh into a porcelain cup 100 grams of clay and 3 grams of the pigment. Mix this with 70 to 75 c.c. of water and then add 60 grams of a casein solution containing exactly 12 grams of casein. Mix the contents of the cup very thoroughly and by means of a brush or some sort of a scraping device apply a very thick coat of the mixture to small sheets of white paper. When these sheets are dry, preferably air dried, they are compared with the standard sheets for color. This test also is comparative only and to make it of value the same clay, casein and paper must be used in every case.

Fastness to chemicals may be determined by treating a dilute solution of the dye with small quantities of the chemicals with which it will come in contact. By making the tests with solutions of definite strength and using the same volumes each time the effects of the chemicals on the different dyes can be more readily compared. It is well to make the test first by noting the effect of standing several hours in the cold and finally by bringing the solutions just to a boil.

For use in vulcanized fibre the colors should be fast to zinc chloride solution. This is best determined by coloring some of the stock with the dye to be tested, passing the sheet through a bath of zinc chloride of the correct strength, and finally washing. This will show whether the color is affected and also whether it will bleed during the washing of the finished product.

Fastness to light may be determined by exposing strips of paper, colored with the dye to be tested, in a printing frame in such a way that part of the strip is protected from the light. If daylight is used it is difficult to duplicate the test because of the variation in the quality of the light from day to day and at different times of the year. This can be avoided by using artificial light rich in the ultra violet rays which are the ones most active in the fading of colors. Such apparatus intensifies

the fading effect and enables results to be obtained in a comparatively short time.

It is very seldom that it is necessary to determine what dye was used in coloring a given sample of paper, usually it is sufficient to be able to match the shade. The determination of the dyestuff used is a difficult matter at best and is greatly complicated when more than one dye was used, which is generally the case with colored papers. If it is necessary, the scheme proposed by A. G. Green¹ for the determination of dyes on vegetable fibres is probably the best one to follow. The identification of the dyes themselves may be carried out according to the schemes of A. G. Green² and S. P. Mulliken.³ The general properties of the different classes of dyes have already been described and it is usually sufficient to determine to what class or group the sample belongs, since this information fixes the dye method to be used.

It is often desirable to know whether a commercial product is a simple dye or a mixture. If the dyes have been mixed in the powdered state, the fact that it is a mixture may be ascertained by taking a small sample on the end of a spatula and blowing it onto a piece of wet, white blotting paper. Each speck of color gradually dissolves and the various colors of a mixture show very plainly and can be tested by chemical means. When the coloring matters have been mixed in solution and evaporated together this test fails. For such cases the dye can be tested by making a succession of dyeings of wool or cotton skeins in the same dye bath. If the dye is a mixture the first and last skeins will differ in shade.

¹ Green: *J. Soc. Dyers and Colorists*, 1907, 252.

² Green: *J. Soc. Chem. Ind.*, 1893, p. 3.

³ Mulliken: *Identification of Pure Organic Compounds*, Vol. III, Commercial Dyestuffs.

CHAPTER XII

COATED PAPERS

The class of papers variously known as coated or glazed, and in England as art papers, has been developed within comparatively recent years in response to the demands of the printers for a paper on which half-tones could be reproduced to good advantage. The essential feature of such papers is a thin layer of mineral matter and adhesive applied to the surface of an ordinary sheet of paper, the function of the mineral matter being to form the surface for printing, while the adhesive is merely added to hold this mineral matter on the paper and prevent its being removed by the ink. The coating covers the individual fibres on the surface of the paper and in addition fills in any hollows or irregularities between them so that when the paper is calendered there results a fine, smooth, even, and continuous surface which permits the finest dots of the half-tone screens to take perfectly. Such papers are used for lithographic work, for magazine and other printing and especially for the high class half-tones in catalogues and advertising matter.

While coated papers possess advantages from the standpoint of the printer, they also have certain defects which are of a quite serious nature. The body stock is frequently made of inferior materials while the coating, due to its nitrogenous nature, is peculiarly subject to decay and to the attacks of insects, especially when stored in warm, damp places. The paper is also very heavy and bulky so that books made from it are difficult to handle and, moreover, it has very poor folding or bending qualities and is therefore much more liable to injury than uncoated papers. It is by no means certain that coated papers will not deteriorate within a comparatively short time

to such an extent that matter printed on them will be valueless and for this reason they should never be used for documents of permanent or historic value.

The paper, or body stock, to which the coating is applied, need not be of the highest class since it is entirely covered by the coating, and hence inferior materials are frequently used in its manufacture. In fact in Europe ground wood is often one of the principal ingredients though it is a finer quality of ground wood than is generally made in this country. A practical limit is set to the use of low-grade stock by the fact that the coating is more or less translucent and does not prevent dirty or shivey stock from showing in the finished paper.

Some of the qualities demanded in paper for coating are regular formation, softness and pliability, freedom from fuzz and cockles, uniformity of finish, and medium sizing. The regular formation is essential if uniform finish is desired in the coated paper, and softness and pliability are necessary if the paper is to run well on the coaters since a hard, rattly sheet will not lie flat, tends to curl on the edges and does not take the coating well. Each little fibre which stands up from the surface in a fuzzy sheet seems to attract the coating so that it causes a mottled effect; this is particularly noticeable when the coating is tinted since the color seems to concentrate itself round the base of each fibre. One of the most important qualities to be considered is the sizing of the sheet since if it is too hard sized the coating tends to lie on the surface and be streaky, while if it is too slack sized the adhesive will be absorbed, permitting the coating to be weak or necessitating the use of an abnormally large amount of adhesive. Defective sizing is much more serious when glue is used than when casein is employed since the temperature of the drying lines is generally high enough to keep the former liquefied and thus permit its absorption.

The coating mixture is nearly always applied to the paper by machinery, several different types of apparatus being used. In one the mixture is transferred from a roller revolving in a trough to a felt or brush, and from this to the surface of the paper;

in another the paper passes under a roller which is immersed in a tank of the coating mixture and the excess is removed by squeeze rolls. In either case the coating is immediately smoothed out and brought into good contact with the paper by means of brushes working across its surface with a reciprocating motion. The first of these brushes is comparatively coarse, but they gradually become finer till the last, which is very fine, to eliminate the marks made by the first. The arrangement of this coating machine is indicated in Fig. 39. After leaving the brushes the paper passes through a drying gallery heated by steam coils or a current of hot air and when thoroughly dry is reeled up ready for calendering. The amount of coating applied by this process varies with the purpose for which the paper is made and may be anything from a wash coat up to 35 per cent of the weight of the finished paper. According to the type of coating machine used, both sides may be coated at one operation with the same color or each side may be coated separately with the same or different colors.

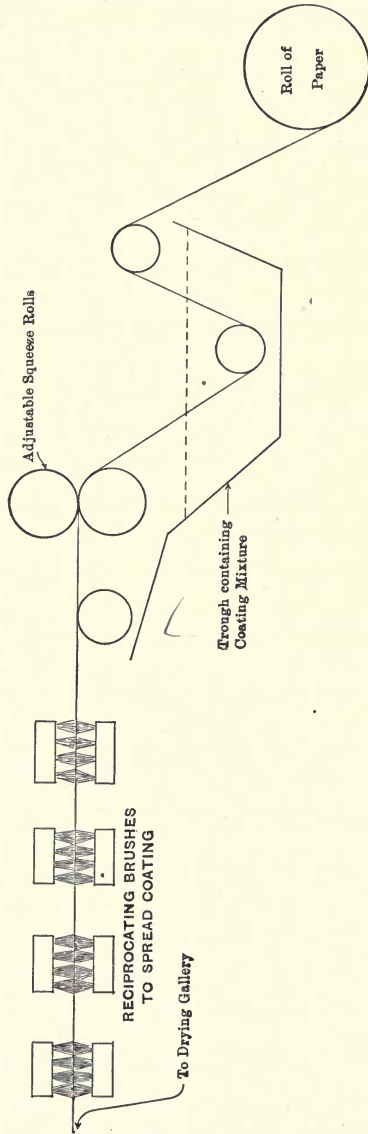

FIG. 39. DIAGRAM OF COATING MACHINE

The adhesives used in coated paper are chiefly glue and casein, though starch and albumen have been used to some extent and many others have been proposed from time to time. The amount used varies with the different mineral matters, satin white requiring much more than blanc fixe, while clay occupies an intermediate position. If too much adhesive is used the paper tends to curl, the color is not so good and the coating is less porous so that when printed the ink is apt to offset and to crawl or mottle instead of lying flat. Such paper also takes a lower finish on calendering than when less adhesive is employed. From the point of view of the printer, as well as for reasons of economy, it is therefore desirable to use as little adhesive as possible. On the other hand if too little is used, the coating will "lift" or "pick" when printed, especially if heavy or tacky ink is used. This imposes a minimum beyond which the adhesive cannot be reduced, while as a matter of fact this minimum is seldom even approached because the many variable conditions render it necessary to employ a large factor of safety. In good work it is seldom possible to use less than 15 lbs. of dry casein to 100 lbs. of dry clay and much more frequently 18 to 20 lbs. are used, while with glue the quantity employed is about 20 to 25 lbs.

The influence of the amount of casein in the coating on the time required for linseed oil to saturate the paper, which may be taken as a measure of the rapidity with which ink will penetrate, is well shown by the following experimental data.

Grams of casein per 100 grams clay	Time in seconds for oil to saturate	Grams of casein per 100 grams clay	Time in seconds for oil to saturate
10	20	25	780-1020
15	37	30	Does not penetrate
20	125

The mineral matter employed in coating paper may be clay, blanc fixe, satin white, talc, or a number of other substances and they may be used singly or in mixtures of two or more.

The character of the finished paper depends very largely upon the mineral matter used and many different effects can be produced by a careful blending of the various substances. (Satin white gives the smoothest coating and the highest finish of any of these materials, clay gives a lower finish,) while blanc fixe takes less polish than either, thus by a proper selection nearly any desired finish may be obtained. The qualities demanded in a coating substance are good color, freedom from grit and the property of working up to a good, fluid mixture when the adhesive is added. For tinted or colored papers it should also be free from all traces of acid since this might injure the shade. The color demanded of a coating material is in general much brighter than that which a filler is expected to possess and the price paid is correspondingly higher.

In addition to the two main ingredients in the coating mixture, other substances are frequently used in smaller amounts for special purposes. (Soaps or waxes, either in solution or in the form of emulsions,) are added with the object of improving the finish; antifoam oils are used to prevent excessive foaming of the coating mixture; glycerine, or some of its substitutes, is added to give the coating increased pliability or folding power and salt is sometimes employed to reduce the curling tendency of the paper. (Nearly every manufacturer has in use some such modification of the regular process which he generally considers a secret, though it often proves to be quite widely known. There is thus opened a very wide field for the employment of chemistry in the coating industry and it is probably safe to say that it offers more and harder problems than any other department of paper making.

The finish imparted to coated paper depends on the way in which it is calendered as well as upon the materials of the coating; the damper the paper the higher the finish. There is a limit, however, to the amount of moisture which can be advantageously left in coated paper which is to be calendered, since if it is too high the paper tends to crush or blacken and the color is seriously injured. The amount of moisture which will cause

this varies with different papers and with the pressure put on the calenders so that no invariable limit can be set. It is, however, safe to say that if the paper contains much over 5 to 6 per cent of moisture, exceeding care will have to be used in calendering it. The finish of paper may be considered as composed of two factors, smoothness and shine. The former is essential to good printing while the latter is not, and since it is highly inartistic as well as seriously injurious to eyesight, it would seem well to avoid it as far as possible. This is being done by producing dull finish or mat papers in which the smoothness is imparted by a light calendering, which is done in such a way that little friction is employed, so that the polishing effect is slight. Another method is to give a very thin wash coat, on the coating machine, over a paper which has been thoroughly smoothed. This produces a peculiarly velvety surface which takes half-tone effects with very beautiful results but possesses the slight defect that it is easily scratched, a slight stroke with the finger nail sufficing to cause a distinct mark. Careful selection of materials which do not readily take a high finish, such as blanc fixe, barytes, precipitated chalk, etc., materially assists in the minimizing of this defect and also aids in the production of dull finish papers of the first class. Although papers with a very high glossy finish are still largely demanded, yet these dull finish papers are rapidly growing in favor and it is anticipated that they will become more popular as they become more widely known.

The printing qualities of coated papers are largely influenced by the kind of adhesive used as well as by the amount. Glue coating possesses the property of taking ink especially well while casein is slightly more difficult to handle. This difference caused trouble when casein was first introduced and its general use was delayed because of the prejudice of the printers. It is often claimed that the reason for this difference lay in the acid reaction of glue coated papers and the alkalinity of those coated with casein. This explanation is probably erroneous since it has been found that casein coated papers, except those contain-

ing satin white, are normally acid to litmus in spite of the fact that an excess of alkali is almost always used in preparing the casein solution. Except with inks which are exceedingly sensitive to acids or alkalis the reaction of the papers is probably of very little importance since printers practically never make any difference, in regard to the ink used, between ordinary coated papers and those containing considerable satin white which are strongly alkaline.

Glue. (Of the adhesives used for coating paper glue was the first, and for a long time practically the only one, and although it has been largely superseded by casein it is still used to some extent. It was formerly the custom, in many cases, for the consumer to manufacture his own glue but it is better practice to purchase it of some reliable dealer as the supply obtained in this way is likely to be more uniform. For convenience in handling, the ground glue is to be preferred to the sheet glue, since it requires very little time for soaking and the solution can be quickly prepared. The quality best suited for coated paper work is a good grade of hide glue but it is undoubtedly true that much inferior material is used, either intentionally because of the apparent saving in cost, or unintentionally because of its substitution by unscrupulous dealers. Poorly made glue is apt to give trouble by frothing and it probably lowers the quality of the paper in which it is used though from the numerous variables entering into the manufacture it is frequently impossible to locate the cause of inferiority with certainty.

(Glue for coating paper should be of good color, free from objectionable odor, of good strength, nearly neutral in reaction and for some purposes free from grease.) The grease if present in appreciable amount tends to make "birds'-eyes" in the coating and thus cause defective printing. Too much grease also lowers the clay carrying power or strength of the glue. If on the other hand, the glue is entirely free from grease, the coating dusts on the calenders and the paper will not take a good finish. This reason for dusting was suspected by one manufacturer who made his own grease-free glue and when a small amount

of fat was added to the glue solution the trouble entirely disappeared.

A rapid semi-quantitative test for grease may be made by coloring the glue solution intensely with some aniline dye and then brushing it lightly onto white paper. If grease is present, spots or "birds'-eyes" will form and the number of these is roughly proportional to the amount of grease. This test also gives an indication of the way the coating mixture will spread under the action of the brushes. The best quantitative method for the determination of fat is that of Kissling which is carried out by dissolving 20 grams of the sample in 150 c.c. of water containing 10 c.c. of hydrochloric acid (sp. gr. 1.20). This is heated three to four hours on the steam bath, using a reflux condenser, and after cooling the fat is extracted by means of petroleum ether, which is then evaporated off and the residue dried and weighed. Good grades of glue may contain 0.1 to 0.6 per cent of fat, but it is safer to use those which run nearer the lower figure.

The presence or absence of acidity in glue is of even more importance than the question of fat since in many instances the colors used are affected by the acid to such an extent as to cause serious variations in shade. The acidity of glue may be determined with fair accuracy by dissolving 1 gram of the sample in 500 c.c. of water, adding a few drops of phenolphthalein solution and titrating with $\frac{N}{10}$ alkali. This gives all free acid,

organic as well as mineral, and since a number of acids may be present it is well to express the total quantity as the equivalent percentage of sulphuric acid. The percentage of acid in glues is quite variable, often running as high as 1.2 per cent, but for use with delicate colors it should not be over 0.2 to 0.3 per cent.

The strength of glue is often considered to be proportional to the firmness of the jelly which it forms, but experience has shown that the amount of clay which a sample will hold is not always in accord with its jelling powers. A much more reliable test for strength is described under casein.

Coated papers in which glue is used are generally slightly acid in reaction and they possess certain qualities of surface and porosity not present in casein-coated papers. The change from glue to casein was delayed for this reason since it involved also a change in inks and the technic of printing, but the lower price of casein enabled it to force its way gradually in till now it has almost wholly replaced glue in all ordinary grades of coated papers.

Casein. Casein is a nitrogenous body which is present in milk to the extent of about 3 per cent by weight. It may be separated from milk either by the action of acids or rennet, but the rennet casein is relatively insoluble in alkalis so that it is out of the question for coated paper work. Acid caseins may be prepared by the action of any of the mineral, or the stronger organic acids; or the milk may be allowed to curdle spontaneously from the formation of lactic acid. This latter procedure gives the so-called "self-soured" casein, while if acid has been used its name is usually attached to denote the method of preparation, as muriatic casein, sulphuric casein, etc. In this country acid is generally added to the skim milk, in South America much is made by self-souring, while in Europe both processes are used.

Commercial casein is prepared from milk which has been freed as much as possible from fat by means of cream separators. This skimmed milk is warmed to 49° to 50° C., the acid is added and when the curd has settled the whey is drawn off. The curd is then washed by hot water, drained on racks or boards, shredded, spread on wire bottom trays and dried in a current of warm air. The dried curd is then ground to any desired degree of fineness. If a high grade product is to be made great care must be taken that the wet curd is not kept so long that it has a chance to decompose or mould and the drying temperature must be closely regulated, since if it goes too high the casein becomes orange-brown and difficultly soluble. The kind of acid used also exerts a considerable influence on the character of the product; that made with muriatic acid gives

thick solutions which tend to foam and to become jelly-like on cooling, the self-soured produces thinner solutions which, on cooling, retain their fluidity to a notable extent, while that made by means of sulphuric acid occupies an intermediate position. The green curd from any of these methods can be used to good advantage in preparing the solutions for coating, but owing to its poor keeping qualities it is only obtainable locally.

The nitrogen in pure casein has been found by various investigators to range from 15.12 to 15.74 per cent, hence the percentage of nitrogen found in any sample multiplied by the average factor of 6.48 will give the percentage of ash-, fat-, and moisture-free casein. Commercial caseins have been found to contain about 13 per cent of nitrogen on an average so that the factor to convert percentage of nitrogen into commercial casein would be $\times 7.69$.

The results of examinations of samples of casein from both German and American markets are given below and show the variations to be expected in good commercial material. The German samples were tested by Höpfner and Burmeister,¹ while the American samples were analyzed in the author's laboratory.

	German			American		
	Max.	Min.	Avg.	Max.	Min.	Avg.
Per cent						
Moisture.....	10.50	7.27	9.23	12.3	5.4	9.65
Fat.....	2.06	0.23	0.85	9.9	trace	3.68
Ash.....	4.95	3.53	4.07	4.5	1.0	3.29
Nitrogen on total sample.....	13.55	12.52	12.99
NaOH to neutralize to litmus....	3.83	1.30	2.51

The specific gravity of commercial casein as received ranges from 1.31 to 1.34 and the weight per cubic foot is 38.6 lbs. if run loosely into the container or 47.8 if tamped.

The moisture in casein has been found to vary with the humidity of the surrounding atmosphere as is shown by the results of tests on two standard commercial samples.

¹ Chem. Ztg., 36, 1912, 1053.

Per cent humidity	Moisture in	
	Sample 1	Sample 2
40.6	7.27	7.20
47.5	8.27	8.06
52.7	9.13	8.99
62.2	10.53	10.53

This explains why a sample of casein containing 12 to 14 per cent of moisture when received will, if spread out in a thin layer, lose weight very rapidly at first until the moisture is reduced to 7 to 8 per cent and then will gain or lose in weight according to atmospheric conditions.

Soluble caseins which were formerly on the market in large quantities, and are still met with occasionally, are merely mixtures of ground casein and some alkali as borax, soda ash, etc. An analysis of a representative sample gave the following results:

	Per cent
Moisture.....	12.2
Casein (free from fat, ash, and moisture).....	67.1
Soda ash, Na_2CO_3	8.6
Borax, $\text{Na}_2\text{B}_4\text{O}_7, 10 \text{H}_2\text{O}$	3.1
Fat.....	1.3
Ash insoluble in water.....	9.3
	101.6

Such caseins are easy to handle but they are likely to keep poorly as the alkali may absorb water and act destructively on the casein, thus impairing its solubility and decreasing its strength. They also limit the user to the kind of alkali already mixed with the casein and do not permit its proper adjustment to the work in hand. A third point against them is that a cheap alkali is paid for at the price of casein so that the user can make quite a saving by buying both the alkali and the casein separately and mixing them himself in the proportions he desires.

Casein is essentially of an acid nature and hence requires treatment with an alkali to bring it into solution. It forms two

series of salts, those neutral to phenolphthalein being called basic caseinates, while those neutral to litmus are known as neutral caseinates. The caseinates of sodium, potassium, lithium and ammonia are readily soluble, those of calcium, barium and strontium are much less so while those of the heavy metals are insoluble.

The alkalis which have been proposed as solvents are ammonia and ammonium carbonate, and hydroxide, carbonate, silicate, borate, sulphite, and phosphates of sodium. Of these ammonia and the carbonate, borate and phosphates of sodium are the ones most frequently used while caustic soda is generally avoided because of its drastic action if used in excess. If care is used caustic soda is one of the best solvents, being cheap, quick in its action, and giving as good solutions as the more expensive solvents. The relative amounts of these alkalis required to give a neutral solution vary with the different caseins as the following figures from a large number of tests made with high-grade commercial solvents will show

1 lb. borax, $\text{Na}_2\text{B}_4\text{O}_7 \cdot 10 \text{H}_2\text{O}$		
= 0.1736 - 0.2330 lb. NaOH		average 0.2020
= 1.062 - 1.159 lb. $\text{Na}_3\text{PO}_4 \cdot 12 \text{H}_2\text{O}$		average 1.130
= 1.158 - 1.872 lb. $\text{Na}_2\text{HPO}_4 \cdot 12 \text{H}_2\text{O}$		average 1.419

In the case of the phosphates the reaction evidently ceases when dihydrogen sodium phosphate is formed and this supposition is confirmed by the fact that the latter salt has no appreciable solvent action even when used to the extent of 50 per cent of the weight of the casein.

Practical application of these solvents brings out certain marked differences; ammonia is one of the quickest solvents and is especially useful in dissolving the last traces of the casein, the phosphates give thinner solutions especially with muriatic caseins, while borax is a reliable general solvent for most work but cannot be used with satin white. In any case a considerable excess is to be avoided as it is wasteful, darkens the color and with most caseins causes a very marked thickening of the

solution. The full strength of a casein is developed if the alkali used is sufficient to give a solution neutral to litmus and while a moderate excess does not cause loss of strength, this does take place if a large excess is used, particularly if the heating is prolonged. The amount of alkali required to give a neutral solution varies greatly with different caseins; with borax the range may be as great as from 7 to 18 per cent. A difficultly soluble casein may be improved by soaking it in 10 parts of water acidulated with acetic acid and then washing. This improves its solubility and reduces the amount of alkali required.

In very many caseins there is a small amount of insoluble matter which generally takes the form of white flakes resembling skins or envelopes from which the casein has been dissolved. In some cases these will dissolve on the addition of more alkali, but usually it is impossible to eliminate them in this way. They are light but bulky so that they appear to be present in large amount while in reality the percentage is very small, the worst sample which has been noticed containing only 1.64 per cent by weight. Under the microscope the great majority of these white flakes are found to consist of the hyphæ of moulds so the old theory that they were particles of albumen precipitated by overheating of the milk is untenable. Additional proof of their nature has been obtained by moistening casein and allowing it to mould, then drying and grinding it to its original fineness. Four samples thus treated showed white flakes amounting to 15 to 80 times those originally present and all had the same microscopic appearance as those present before moulding. These flakes cause trouble by working up into the brushes of the coating machines and after they have collected in quantity, dropping off onto the paper thus making spots which sometimes stick to the calender rolls and break the paper. They also cause the brushes to work "dead" and not spread the coating well. These flakes, as well as all other undissolved foreign matter or casein, can be easily and completely removed by centrifugal clarification of the casein solution and the good portion of a casein

which is dirty or partially insoluble can thus be obtained in fit condition to use.

Solutions of casein are very liable to become spoiled, especially in the summer months, and such solutions cannot be used both because of their extremely bad odor and because the strength of the casein is very largely destroyed. Many substances have been proposed as preservatives for casein solutions, among them camphor, essential oils, salicylates, benzoates, hexamethylene tetramine, etc., but few of them are worth the added expense. The proper selection of alkalis has a large influence on the rate of spoiling, borax acting as a good preservative, while ammonia, phosphates or caustic soda permit rapid spoiling. Tests on the same casein with different solvents gave spoiled solutions in forty-eight hours when ammonia, caustic soda, or trisodium phosphates were used while if borax was employed the solution was good at the end of 16 days. Other experiments proved that 3 to 4 per cent of borax on the weight of the casein was sufficient, when mixed with other alkalis, to preserve the solution as long as it would ever be necessary under normal working conditions, provided ordinary care was employed in keeping the tanks and mixers clean. For this reason it is a wise precaution to use a small amount of borax in preparing casein solutions.

Another substance which acts as a preservative but which is used primarily as a waterproofing agent is formaldehyde. This is obtained commercially as a strong aqueous solution of the gas and should always be diluted with about ten times its volume of water before adding to the coating mixture. Over 2 per cent of the strong solution, based on the weight of the casein, will cause thickening while $1\frac{1}{2}$ to 2 per cent can be added safely if it is well diluted and stirred in. This amount is sufficient to make the coating waterproof or washable, while even smaller quantities produce very noticeable waterproofing effects. When small amounts of formaldehyde are used the waterproofing is slight at first but gradually develops so that paper which has been stored several weeks will show better results than when first made.

Many other substances are capable of rendering casein insoluble but as most of them cause curdling or thickening of the casein solution they cannot be applied when the coating is spread. If casein coated paper is moistened with solutions of salts of iron, lead, copper, aluminum, magnesium, zinc, etc., the casein is rendered insoluble to such an extent that the paper may be safely washed. The use of any of these materials means putting the paper through one more process and as the desired properties can be more cheaply attained by formaldehyde none of them are now employed; they do, however, possess possibilities worthy of future investigation.

Under normal conditions of storage caseins are apt to become infested with worms, the larvæ of either moths or beetles, and the deterioration thus caused is very marked. Caseins affected in this way require less alkali to give neutral solutions and in some cases may lose as much as 50 per cent of their original strength in one year. The period of greatest deterioration is found to be in the summer, when the worms are most active, while in winter very little change takes place. Obviously the best conditions for lengthy storage would nearly approach those of cold storage plants.

The tests which may be applied to casein are of two general classes, chemical analyses for certain constituents as moisture, ash, fat, or nitrogen and empirical tests to show certain properties as solubility, strength, and alkali required.

Moisture may be determined by drying in a thin layer at 100° to 105° C. for about two and a half hours, cooling, and weighing in a closed vessel to prevent reabsorption of moisture. All caseins are not equally sensitive to heat but none have been found which, under these conditions, suffer decomposition which is serious enough to cause any appreciable error. In fact most caseins may safely be heated much longer at this temperature, or even as high as 115° C., without vitiating the results.

The ash in casein may be determined by burning 2 to 3 grams in a silica dish; platinum should not be used because of the presence of phosphates which might be reduced and injure the

platinum. In some cases the ash is gray and infusible while in others it melts to a clear, glassy mass. Rennet casein burns out readily and gives a high ash, while acid caseins are much harder to ignite free from carbon.

Fat may be estimated by extracting the finely ground sample in a Soxhlet apparatus with ether and petroleum ether, evaporating the solvent, and drying and weighing the fat. A more accurate and rapid method is as follows: Soak 2 grams casein in 6 c.c. water in a small beaker and after about half an hour add with constant stirring 9 c.c. of concentrated sulphuric acid (sp. gr. 1.84). Pour the solution into a Babcock skim milk bottle and wash out the beaker with 5 c.c. water and 5 c.c. H_2SO_4 . Fill to the base of the neck with dilute sulphuric acid (4 c.c. water and 5 c.c. conc. H_2SO_4) and whirl in the Babcock centrifugal five minutes. Fill with dilute acid, whirl two minutes and while still hot read the fat on the graduated neck. The reading multiplied by nine gives the percentage of fat in the casein. The secret of this method is in getting the concentration of the acid just right since if it is too strong the fat will char while if it is too weak the casein will not all be in solution and a reading will be impossible.

Nitrogen is best determined by the usual Kjeldahl method. The factors for converting this to casein have been given above.

These chemical analyses, while giving information as to the purity of the sample in question, do not show how it will work in practice, whether it is completely soluble, how much alkali it will require, whether the solution will be thin or thick, or whether the casein has good adhesive strength. For the manufacturer of coated paper these points are far more important than the chemical data and while such tests are for the most part comparative they are quite simple to carry out and are sufficiently accurate for practical purposes.

The alkali required, the consistency of the solution, and its completeness may be determined at one operation as follows: Soak 50 grams of the finely ground casein in 200 c.c. of water in a weighed No. 3 breaker for about half an hour then add a weighed

amount of the solvent and heat on the steam bath with constant stirring. The amount of solvent should be less than will be required to give a neutral solution and the kind is immaterial so long as it is capable of being accurately measured; borax and trisodium phosphate are very satisfactory or a standard caustic soda solution may be added from a burette in place of weighing the dry solvent. When the alkali added has all been used up test the solution by dipping in it a moistened piece of blue litmus paper. If the reaction is acid add more alkali and repeat the heating on the steam bath. This operation should be continued until the solution reacts neutral to litmus, which will be when it turns red litmus slightly blue and blue litmus slightly red. If at this stage the solution is not complete it is well to add more alkali and see if this excess will bring into solution all of that which is insoluble at the neutral point. This test indicates the minimum amount of alkali which can be used with the casein in question, shows whether it is good enough to use without clarifying the solution and by the consistency of the solution tells the experienced man much as to the kind of alkali to use and the manner of running it on his coaters. The test is of such a nature that, so far as the consistency of the solution and its completeness go, it does not lend itself readily to numerical expression. For this reason the interpretation of the test requires experience and this cannot be imparted by words.

The strength of a casein or the amount of clay which a given weight of casein will hold on the surface of the paper is best determined by a method approximating actual coating operations. The apparatus is simple; a porcelain cup (without a handle), a brass plate, a steel scraper so shaped that a thin coating of the clay and casein may be applied to a sheet of paper, a copper stirrer flattened and bent at one end so that the contents of the cup may be thoroughly worked over, and a set of scales capable of weighing down to 0.1 gram. One hundred grams of clay, previously dried at 100° C., are weighed out into the cup and soaked up with 70 c.c. water. The casein solution which was prepared in the solubility test is so adjusted, by evaporating or adding

water, that each gram of dry casein is equivalent to 5 grams of solution. The clay and water are now worked over with the copper stirrer, the whole balanced up on the scales, 30 grams of casein solution added and the mass stirred until homogeneous. A sheet of paper is then laid on the brass plate, a little of this coating mixture placed on one end and a thin but even coating applied by means of the scraper. What coating mixture remains on the scraper is returned to the cup which is again balanced up, 5 grams more casein solution added and another sheet spread. This is repeated until the dry casein used amounts to 12 grams per 100 grams of clay. The coated sheets, which are marked from 6 to 12, according to the amount of casein, are allowed to dry and then by looking through the sheets places of uniform thickness are selected and marked on each. Short pieces of high grade sealing wax are then melted on one end, either in a gas flame or on the surface of a steam heated box, and applied to the marked places with a firm pressure. They are allowed to become thoroughly cold and are then removed from the paper by a steady vertical pull. If enough casein is present the surface of the wax will be covered with fibres to the very edge, if too little has been used the coating comes away from the paper without pulling off any fibre, while there is usually an intermediate case in which the center of the wax shows fibre and the edges clay only; this would be considered just on the line between weak and strong.

This is an excellent comparative test but it does not show the actual amount which can be used practically, but for several reasons indicates a higher strength than the same casein shows on a large scale. It will be found, however, that if this test shows one lot to be weaker than another it will be necessary to use more of the former than the latter when it is put on the coaters. The test is also influenced by the kind of clay, thickness of coating, nature of paper, etc., so that it is necessary to use standard materials in carrying it out. This means that, while it gives very valuable comparative results in the hands of experienced persons and under standard conditions, it is not safe to compare results obtained in different laboratories.

Albumen. Both blood- and egg-albumen are similar in some respects to casein yet differ from it by losing their solubility if heated to about 75°C ., while casein may be treated with boiling water and still be soluble when the correct proportions of alkali are used.

Solutions of either of these may be prepared by stirring the albumen into warm water to which a little spirits of ammonia has been added. The temperature should not be over 20°C . and the stirring must be frequent enough to prevent the albumen from collecting and sticking on the bottom of the container. Other substances are also used as assistants in dissolving albumen, as borax, magnesium sulphate, etc. The strength of albumen is very nearly equal to that of casein, 24 to 28 parts of albumen doing the work of 22 to 24 parts of casein.

Coatings prepared with albumen are not rendered so waterproof by formaldehyde as are casein coatings; they may, however, be made washable by heating, preferably in the presence of steam. Mixtures of casein and albumen when treated in this way give washable coatings which are good for chromo and leather papers because of their capacity to absorb printing ink. While under certain conditions albumen gives a higher finish to paper than does casein yet it is seldom used because of its high price and in many cases its disagreeable odor.

Starch. As an adhesive for coated paper work starch has many good points; it is clean, of good color, without odor, non-nitrogenous and hence not liable to putrefactive decomposition, has good strength and is cheap. The different starches, such as corn, wheat, cassava, potato, etc., have quite distinct characteristics yet all are sufficiently alike so that they may be discussed as a class.

The simplest way to prepare an adhesive from starch is to stir the dry starch into 8 to 15 times its weight of water and heat to the boiling point. Different starches vary as to the temperature at which they gelatinize and the thickness of the paste they produce but with reasonable amounts of water all are too thick to use on the ordinary coating machine. This difficulty may be

overcome by modifying the starch by chemical treatment so that it cooks thinner while at the same time losing nothing in strength but in many cases actually gaining in adhesive properties. Such modified starches may be produced by treatment with acids, acid salts, oxidizing agents, etc., under very varied conditions and the patents taken out along such lines are almost innumerable. The products of these treatments resemble the original starches in appearance but as stated give much thinner solutions and also have, according to their method of preparation, minor differences which sometimes cause trouble on the coaters.

A well made modified starch for coated paper work should give a light colored, thin solution when one part of starch is boiled with four parts of water. This solution should not thicken too much on cooling or at least should thin down to its original consistency on reheating. While there are many such products only a few give satisfactory mixtures with clay as most are lacking in the property which glue and casein possess of making the clay into a very fluid suspension. The lack of this quality causes the coating mixture to work "dead" or draggy and the paper is apt to show brush marks, or if these results are to be avoided so much water has to be added that the drying lines are overtaxed and the capacity of the machine is reduced. The strength of starch has been found to be slightly less than that of casein so that about 20 to 25 lbs. are required to do the work of 18 to 20 lbs. of casein.

Coated papers prepared with starch do not take such a high, glossy finish as casein coated papers, partly because of the larger amount of adhesive used and partly because of the nature of the starch itself. Even the addition of considerable amounts of wax does not enable it to take so good a finish as casein coated paper. This does not prevent half tones taking well on it for its surface is sufficiently smooth and even to print well. A characteristic feature of starch coated paper is the porosity or absorbent power of the surface. This seems to be greater than with glue or casein coatings so that the printing ink tends to sink in rather more and the resulting cut, especially with color work, is slightly dull.

This trouble can be overcome by a proper adjustment of the ink but at present it is delaying the general introduction of starch coating, though otherwise the paper works well, running well on the presses, permitting rapid work and requiring no slip-sheeting.

Miscellaneous Adhesives. Other materials have been proposed from time to time as assistants to, or substitutes for, casein and among these may be mentioned gluten, viscose, shellac, algæ, vegetable gums, mucilages, etc.) While these may be, and probably are, used in small quantities or for special purposes, as for instance shellac in the manufacture of imitation leather papers, their employment is by no means general and it is not probable that they will ever seriously compete with casein.

Clay The nature and properties of clay have been discussed in the chapter on fillers and the methods of testing which are given there apply equally well to coating clays.) The principal differences between filler and coating clays are in color and fineness, the coating grades being whiter and finer and containing less grit. These differences are not by any means along hard and fast lines since the higher grade filler clays are sometimes used for coating, while for certain kinds of high class book papers, good grades of coating clay are used in the beating engines. The presence of grit in clay for coating is more serious than in a filler since it is sure to appear on the surface of the paper where it interferes with the finish and may even cause trouble in printing, especially in lithographing. In this process it is said to etch the stones or plates so that the portions which should remain white are not entirely ink resistant thus permitting the ink to be transferred to the paper when it is not desired and giving tinted or mottled backgrounds.

The fineness of the clay has a large influence on the finish which the paper will take on calendering, the finer the particles of the clay the higher the gloss which is imparted. Unfortunately the amount of casein, or other adhesive, required increases quite rapidly as the size of the clay particles decreases so that the gain in finish due to a fine clay is in part offset by the effect of more adhesive. Unexpected or unknown changes in the fineness of

the clays used are without doubt responsible for some of the cases of weak coating, especially when the amount of casein used is kept as near the minimum as possible.

With ordinary clays from 15 to 18 parts of casein are required for 100 parts of clay and with this casein any of the ordinary solvents as borax, soda ash, ammonia or mixtures of these solvents may be used with good results.

Blanc Fixe and Barytes. Both of these are chemically barium sulphate, $BaSO_4$; blanc fixe being prepared by precipitation while barytes is the natural mineral ground and bolted to any desired degree of fineness. The best grades of blanc fixe are prepared from witherite ($BaCO_3$) by dissolving in muriatic acid, filtering and precipitating with sulphuric acid. The precipitate is washed practically free from acid and put on the market either dry or as a paste containing 25 to 30 per cent of moisture. Cheaper grades of blanc fixe are produced as by-products in the manufacture of hydrogen peroxide, etc., and appear to be only slightly inferior to that from witherite in color and cleanliness. Under the microscope blanc fixe is seen to consist of extremely fine crystals, which are very uniform in size. If large irregular shaped pieces are present it may be taken as an indication of adulteration with barytes or of very careless handling of the solutions before precipitation. The grit in blanc fixe, as determined by the flotation test described in the chapter on fillers, should not exceed 0.2 to 0.3 per cent and it should consist almost entirely of small lumps of the blanc fixe itself which have not broken down during the test. This test also will show the presence of barytes though not its amount. The reaction of blanc fixe varies commercially from neutral to decidedly acid; both appear to give equally good results under ordinary working conditions as the acid is neutralized by the excess of alkali in the casein.

Barytes, being a ground mineral, gives much larger amounts of grit than blanc fixe, the flotation test showing from 8 to 15 per cent for different commercial grades. Its particles are much coarser and more variable in size than those of blanc fixe, and

it is usually quite inferior to the latter in color. For these reasons it should not be used in the highest class of papers.

Blanc fixe is one of the whitest of the minerals used in coating paper and can be used in the very best of products. It does not take such a high finish as clay or satin white and is especially serviceable in making dull finish coateds since it has less tendency to scratch than clay or satin white. Since barium sulphate is practically insoluble it cannot react with casein solutions so that almost any solvent can be used in preparing the latter. Both blanc fixe and barytes require much less casein than does clay and both tend to settle out of the coating mixture more rapidly than clay on account of their high specific gravity.

Satin White. This material consists essentially of calcium sulphate and aluminum hydrate, formed by the interaction of slaked lime and aluminum sulphate; $3 \text{ Ca (OH)}_2 + \text{Al}_2 (\text{SO}_4)_3 = 3 \text{ CaSO}_4 + \text{Al}_2 (\text{OH})_6$. The alum used may be potash or ammonia, or aluminum sulphate itself may be used, and the character of the resulting product depends very largely on which is employed. The slaked lime is frequently used in excess and the amount of this excess together with the quality of the lime has a very great influence on the working properties and color of the product. The following analyses of two commercial samples of satin white show its approximate composition after being dried at 100° C .

	No. 1	No. 2
	Per cent	Per cent
Sulphur trioxide, SO_3	28.9	29.3
Alumina, Al_2O_3	13.9	12.3
Total lime, CaO	39.1	39.7
Loss on ignition.....	<u>17.5</u>	<u>18.5</u>
	99.4	99.8

Both these samples contained 24 to 26 per cent of free lime while other samples tested for this substance have shown that it may run as high as 30 per cent, or the satin white may even be perfectly neutral.

In the commercial preparation of satin white the slaked lime is mixed with alum solution, or in some cases the undissolved alum, and after sufficient agitation to insure a uniform reaction the paste is diluted, strained through fine wire gauze, 130 to 140 mesh, and run into a filter press where it is washed with clear water. The resulting paste containing about 30 per cent of bone dry material is the satin white of commerce. When a standard method of manufacture has once been established it should be strictly adhered to, since changes in the kind or proportions of the ingredients may cause differences which may not appear in the analysis yet which will cause serious trouble in the coating room. In fact it cannot be safely predicted from the analysis how a lot will work and the only sure way is to give it a trial on a practical scale.

The properties imparted to coated paper by satin white are high gloss on calendering and clear white color. Because of the presence of aluminum hydrate the coating becomes rather dense and brittle so that papers with much satin white have rather poor folding qualities; this is especially true with very heavily coated papers.

The amount of casein required to hold a given amount of satin white is much greater than for the same amount of clay, probably in most cases nearly one and one half times as much. Special precautions have to be used in mixing the two or the result is a thick, curdled mass which cannot be spread. In order to avoid this difficulty the casein solution may be prepared with an excess of soda ash or with a mixture of sodium phosphate and ammonia and the satin white should be mixed with a little ammonia before the casein is added. When phosphates are present with satin white heating causes thickening so that hot casein solution should not be mixed with satin white, nor should the mixture be heated. For working with this material temperatures of 30° C. or below are desirable. If these precautions are observed very little trouble will be encountered.

Accessories. Under this heading may be mentioned those materials which are used in small amounts or for special pur-

poses and which do not form an essential part of the coating itself.

(Soaps and waxes are added for the purpose of improving the finish obtained on calendering.) Among those used may be mentioned, beeswax, carnauba wax, stearic acid, paraffin, Japan wax, white soap, lard oil, etc.) Many different recipes are used for mixing the ingredients but most of them are suspensions or emulsions of one or more substances in a soapy medium. Japan wax has the property of saponifying very readily and is quite generally used to hold the other materials in suspension. As an example of this type the following formula may be cited; to about 250 gals. of hot water add 50 lbs. each of Japan wax, paraffin and stearic acid and then 22 lbs. borax and a little ammonia. When stirred until the waxes are melted this forms a creamy white permanent emulsion which is ready to use in the coating mixture.

While it is undoubtedly true that such materials assist in obtaining the high finish on glacé papers repeated trials have demonstrated that they are of doubtful value for the ordinary grades of coated papers and it has been proved that at times some of them may be responsible for poor results in printing.

Closely connected with this class of materials are those added to prevent undue frothing of the coating mixture; in fact some of the substances sold to improve the finish are also claimed to reduce the froth. Anti-frothing substances may have widely different characteristics as for instance wood alcohol, Turkey red oil, fusel oil, skim milk, and gasoline. Probably no one of these will work in every case as froth varies in its character and cause but it is believed that a little gasoline added to the frothing mixture from time to time will give the best results. This substance should be used with great caution on account of the danger of fire.

For softening the coating and increasing its pliability glycerine is frequently recommended. Its beneficial effect is supposed to be due to its hygroscopic nature but tests have shown that commercial glycerines absorb very little moisture from the air so that the increase in weight of the paper would be practically only that

of the glycerine added. Tests by a large manufacturer indicate that amounts up to 2 per cent of the weight of dry clay in the coating have practically no effect on the folding properties of the coated paper and if 5 per cent is used the printing qualities of the paper are seriously injured.

The glycerine substitutes, mostly invert sugars, are even less hygroscopic than glycerine itself and hence would have even less effect. The use of any of these substances is therefore of doubtful advantage and their use is not to be recommended.

CHAPTER XIII

WATER

Water which is pure, in the sense that it contains no foreign matter of any kind, is never found in nature, so that from the manufacturing standpoint, as well as from that of sanitation, water must be considered with reference to the amount and kind of the impurities which it contains. These may include solid, liquid or gaseous substances and they may be either in suspension or solution. Both mineral, or inorganic substances, and organic materials may be present, and the latter may be derived from decaying vegetation or from minute living organisms. Some of these substances may have a great influence on the quality of the paper, while others, which are harmless for this purpose, are decidedly bad if used in boilers. The quality of the available water supply is therefore a vital consideration in connection with the manufacture of paper.

The comparative readiness with which the quality of the water affects that of the paper is still further emphasized by a consideration of the very large volumes necessary for the various manufacturing operations. Griffin and Little¹ estimate the amount required in making a ton of paper at 50,000 to 200,000 gals., or about 200 to 800 times the weight of the paper produced. Others have estimated that in American fine paper mills, making linens, bonds and ledgers from rag stock, the water used amounts to 1000 gals. per pound of dry paper made.² Reliable data for water consumption are rarely available and no generally applicable figures can be given because its use depends so largely on local conditions, as purity, quantity avail-

¹ Chemistry of Paper Making, p. 330 (1894)

² Paper: June 21, 1916, p. 12.

able, cost of pumping, necessity for filtration, reuse of back-water, etc. In some cases it may be necessary to purify the waste waters in order to avoid stream pollution and this tends to reduce the amount of water used. Considering these enormous volumes, and the fact that the paper stock forms a very effective filter, the result of very small amounts of injurious substances may be easily imagined. Compared with this problem that of the boiler-house supply for steam raising is relatively unimportant.

Waters may be broadly classified as (1) rain, (2) surface and (3) ground waters. Rain water, if properly collected, is the purest form of natural water, though it always contains gases and impurities from roofs, products of combustion, etc. Because of the relatively small amounts available it is of no practical importance as a paper making supply. Surface waters include those of brooks, rivers, ponds and lakes. These waters pick up impurities of various kinds according to the nature of the soils over which they flow and they are also contaminated by mineral substances derived from springs which discharge into them. They generally contain less mineral matter but more organic matter than ground waters, and, particularly in the case of river waters, are likely to vary greatly in composition at different periods of the year. Suspended matter is usually present in greater or less amount and in the case of swamp waters there is usually a yellowish color due to the peaty soil over which the water has passed. Waters of this type are likely to contain plant and animal life which may impart considerable color to them. Ground waters are those which have percolated through a considerable depth of soil and the underlying porous strata. Such waters, derived from springs and deep wells, are usually clear and colorless but they contain more dissolved mineral matter than do surface waters.

Soft waters are those which contain little of those mineral substances which are capable of decomposing soap, while hard waters are those which possess this property to a marked degree. The most common cause of hardness is the presence of

lime salts, either the sulphate or carbonate, the latter being much the more general. The salts of magnesium have an even greater effect than those of calcium but they are not so often present. The sulphates of both calcium and magnesium are soluble in pure water but the carbonates require the presence of carbon dioxide to enable them to dissolve as bicarbonates. The necessary carbon dioxide is derived from the air, from the decay of vegetable matter or from subterranean sources. Bicarbonates form what is termed "temporary hardness" since on boiling the carbon dioxide is driven off, causing the precipitation of calcium carbonate and the softening of the water. Sulphates cause "permanent hardness" since they are not affected by boiling.

Soft water is said to be desirable for the washing of stock because it has a greater solvent power than hard water. If the latter is employed for washing sulphite fibre there is a tendency for insoluble calcium resins to be deposited on the fibre, thus rendering the product unnecessarily hard to bleach, while in the soda process the lime salts may be precipitated as carbonate or sulphate and carry down coloring matters with the same result.¹ Water which is very hard because of the presence of calcium bicarbonate may also be injurious to sizing, though the presence of calcium sulphate is harmless. For other purposes in paper making as in the boiling of either sulphite, soda or rag stock, or in bleaching, or furnishing an engine, the importance of soft water is greatly overestimated since the materials employed will immediately harden the softest water.

In making colored papers the quality of the water may affect the results obtained. Carbonates cause precipitation of the salts of iron, tin and aluminum, which are sometimes used as mordants, and reduce their effectiveness. Sulphates have little or no action. Neither carbonate nor sulphate will cause trouble when using acid colors as the amount of acid used far outweighs any alkali present in the water. Iron in the water dulls almost all mordant colors. It is also very injurious in the manufac-

¹ Beveridge: Paper, Oct. 30, 1918.

ture of photographic paper, particularly if it is present in such form that it may deposit in the pipes, reservoirs, etc., as such sludge may break away at times and cause endless trouble.¹

The most important quality of water, from a paper making point of view, is its color. The purest natural waters are clear and colorless when examined in comparatively thin layers, while in large masses they have a bluish tint. Surface waters on the other hand show all variations in color from colorless, through yellowish and reddish tints, to the deep brown of swamp water. This color is due largely to decaying vegetable matter and where the decay has proceeded far the color is very permanent in character. The color derived from plant growths, principally algæ, is usually most pronounced in the summer months. They are green or bluish green, require light for their development and thrive best in ponds or reservoirs where there is little movement to the water. These lower forms of plant life are very sensitive to copper sulphate and a treatment with a very small amount of this material is sufficient to destroy them. This method is often used, even in the case of a water supply for drinking purposes.

At times the color of a water is greatly affected by the suspended matter which it carries; this is a very variable factor, its greatest effect appearing when heavy rains have washed much finely divided soil into the streams. Soluble mineral matter has, as a rule, little effect on the color, even the soluble salts of iron are seldom present in sufficient concentration to cause any perceptible color. Trouble is caused, however, when for any reason these iron salts are precipitated as hydroxide.

Practically all waters, especially surface waters, consume small quantities of bleaching powder, the amount depending upon the source of the water. In most cases the loss of bleach from this cause is slight but if much organic matter is present, as in swamp waters or those largely contaminated with trade wastes or sewage, the loss may be appreciable. Griffin and Little²

¹ Anon: Paper, Jan. 1, 1919.

² Chemistry of Paper Making, p. 333 (1894).

give the bleach consumed by three waters as 1.77, 1.16 and 3.87 grains per gallon but do not state the source of the water or the conditions of the test.

Water which is to be used for boiler purposes should generally be soft and free from suspended matter, for substances either in solution or suspension will accumulate and form mud or scale. Such a deposit may be hard and dense or loose and porous according to the substances present. Dense scale is the more serious and water which causes it should either be avoided or treated in some way. Such a scale causes a large loss of fuel by preventing the transfer of heat to the water and when it is of any considerable thickness there is danger of overheating the boiler locally with consequent damage to the tubes or plates. Hardness, however, is not always an indication of scale forming power for both calcium chloride and magnesium sulphate make water hard but do not form scale.

One of the most frequent causes of scale is calcium carbonate. This is present as bicarbonate but at the temperature of the boiler is again broken down into calcium carbonate and carbon dioxide. This same reaction takes place with magnesium bicarbonate and if both are present in the water they will be found together in the scale. The precipitated carbonates are at first loose and powdery but if the boiler is blown off without cooling the flues, the precipitate is likely to bake into a dense, hard scale. Under these conditions the magnesium appears in the scale as hydroxide. Calcium carbonate is not so likely to bake onto the plates as the magnesium salt. The following analysis¹ shows the general characteristics of a carbonate scale, though the relative proportions are likely to vary quite widely in different samples.

	Per cent		Per cent
Carbonate of lime	75.85	Silica	7.66
Sulphate of lime	3.68	Oxides of iron and alumina	2.96
Hydrate of magnesia	2.56	Organic matter	3.64
Chloride of sodium	0.45	Moisture	<u>3.20</u>
			100.00

¹ Griffin and Little: Chemistry of Paper Making, p. 334 (1894).

If the hardness of a water is due to calcium sulphate no precipitation takes place until the solution becomes saturated due to concentration; then a crystalline scale deposits. This is at first $\text{CaSO}_4 \cdot 2 \text{H}_2\text{O}$, but it begins to lose its water of crystallization at about 260°F . and becomes more insoluble. These actions tend to produce a hard scale which may accumulate to a considerable thickness.

A certain amount of scale may be formed in the boilers even when the water is soft, though the quantity is almost never enough to be serious. The following analyses show the composition of a soft water which proved excellent for boiler purposes and also of the scale which formed during its use.

WATER *

Constituents	Parts per million	Per cent of dry matter
Silica (SiO_2).....	3.8	15.5
Iron (Fe).....	0.04	0.2
Calcium (Ca).....	3.2	13.1
Magnesium (Mg).....	0.6	2.4
Sodium and potassium ($\text{Na} + \text{K}$).....	4.2	17.1
Carbonate radicle (CO_3).....	0.0	28.5
Bicarbonate radicle (HCO_3).....	14.0
Sulphate radicle (SO_4).....	3.6	14.7
Nitrate radicle (NO_3).....	0.5	2.0
Chlorine (Cl).....	1.6	6.5
Total suspended solids.....	7.4
Total dissolved solids.....	25.0

SCALE

	Per cent
Moisture and organic matter.....	17.16
Silica (SiO_2).....	35.64
Ferric oxide (Fe_2O_3).....	4.32
Alumina (Al_2O_3).....	4.28
Calcium oxide (CaO).....	30.97
Magnesium oxide (MgO).....	5.59
Carbon dioxide (CO_2).....	1.40
Sulphur trioxide (SO_3).....	0.92
	<u>100.28</u>

* Analysis by U. S. Geological Survey.

Water Softening. Many so-called "boiler compounds" have been proposed for use in the prevention of scale and while some

may work well under certain conditions, none are of universal application and many are useless or even injurious. If the water is bad enough so that a "boiler compound" seems desirable, it is in most cases preferable to give it a preliminary softening treatment.

For waters containing the bicarbonates of calcium and magnesium the method most generally employed is that of Clark, which consists in adding slaked lime to react according to the equation:

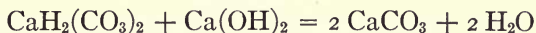

The lime is added either as lime water or milk of lime, the former being preferable because it is more easy to control. This treatment removes all the bicarbonate as well as the added lime.

This method was originally applied in large tanks where the water could remain quiescent for a considerable time. The lime water was added in such an amount that, after thorough mixing, the water gave a yellow or brown color with silver nitrate, then more water was added until the silver nitrate test gave no color. This test should always be applied in order to make sure that an excess or deficiency of lime is not caused by variation in the water supply. Temporary hardness of course is all that is removed, and even that not completely, as a little calcium carbonate remains in solution and magnesium bicarbonate is not so completely removed as that of calcium. Salts of iron and some organic matter are also removed.

Various modifications of this process have been tried out in the attempt to shorten, or do away with, the time required for settling. The Porter-Clark process employs a filter press for the removal of the precipitate. Gaillet and Huet cause the water to take a zig-zag course to promote sedimentation and often use both lime and caustic soda to remove both temporary and permanent hardness according to the reactions

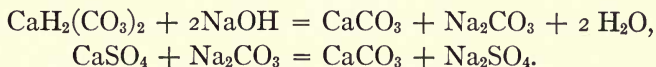

The Archbutt-Deeley process blows air through the treated water after mixing it with the sludge from a previous precipitation. This hastens the sedimentation so that the clear water may be drawn from the top by a floating arm. Other proposed modifications employ barium hydroxide, sodium oxalate, magnesium hydroxide, etc. The latter is not always to be recommended as it may result in the formation of magnesium chloride and consequent corrosion of the boiler.

An entirely different process is the so-called permutite process. Permutite is an artificial zeolite formed by fusing together silica, alumina or china clay, and sodium carbonate. On extraction with water a crystalline body is obtained of the approximate composition, SiO_2 , 46; Al_2O_3 , 22; Na_2O , 13.6; H_2O , 18.4. Filtration of water through this material removes the calcium and magnesium thus:

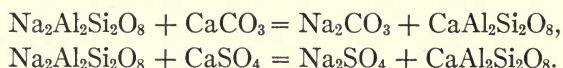

It is claimed that the whole of the hardness is removed and that the calcium and magnesium zeolites formed can be reconverted into the original permutite by treating with a strong solution of salt. A manganese permutite can also be used for the removal of iron.

Filtration. The principal action in filtering water is that of straining to remove suspended mineral and vegetable matter. It is, however, much more complex than a mere straining since the water undergoes chemical and biological changes, particularly in slow sand-filtration. Among these changes oxidation is one of the chief, due to the fact that in passing through porous earth an enormous surface is exposed. In natural filtration, during the transformation of surface into ground waters, this action may proceed so far that all the organic matter originally present is oxidized leaving the water clear and colorless. In continuous mechanical filtration no such oxidation takes place and the removal of organic matter has to be secured by other means.

Many forms of mechanical filters have been devised, some

working by gravity and some under pressure. With all of them some provision is made for cleaning the filtering medium, which is usually sand, either by reversing the flow of water, by mechanical agitation with rakes, by compressed air or some other means. The frequency of such cleaning depends on the quality of the water, and if this varies much, due to the time of year, storms, etc., the intervals between cleaning will also vary. If the stream from which the water is drawn is contaminated with fibre, sawdust or other coarse mechanical impurities the efficiency of the filters may be greatly increased by first running the water supply over a revolving screen similar to the moulds of a wet machine.

Water may be filtered directly, in which case only suspended matter will be removed, or it may first be treated with a little alum. The slight alkalinity of most waters causes the precipitation of hydrated alumina which on standing for some time collects in flocks of appreciable size, gathers together finely divided suspended matter and at the same time takes out much of the organic coloring matter. The precipitate forms a film over the filtering medium and aids in removing bacteria and other minute organisms. If much loam or silt is present a little lime is sometimes added before the alum to insure a sufficiently bulky precipitate. The amount of alum necessary depends on the hardness of the water. It is customary to add it mechanically by some sort of device controlled by the flow of the raw water so that the proportion added may be the same at all times. After the addition of the alum it is desirable that the water remain for thirty minutes to an hour in a settling basin where heavy sediment may settle and the chemical reaction between the alum and the bases present in the water may take place. It is then ready to pass to the filter.

Water Analysis. The following analytical methods have been taken in large part from "Standard Methods for the Examination of Water and Sewage,"¹ to which reference should be made if more complete details are desired.

¹ Am. Public Health Assn., Boston, 1917.

Sampling. Care must be taken that the sample is truly representative of the liquid to be analyzed. If for any reason variations are likely to occur, as for instance because of periodic contamination by trade waste, a sample obtained by mixing together several portions taken at different times is likely to be more representative than one taken all at one time. The amount required for the ordinary chemical, physical and microscopical analysis is not less than two liters, and for special tests larger quantities may be required.

The samples should be collected in glass-stoppered bottles which have been previously cleaned with sulphuric acid and potassium bichromate or with alkaline permanganate, followed by a mixture of oxalic acid and sulphuric acid and by thorough rinsing and draining. The stoppers and necks of the bottles should be protected from dirt by tying cloth or thick paper over them.

The time which may safely elapse between the collection of the sample and its analysis depends on the character of the sample and the tests to be made. No exact limits can be fixed but it is considered that the analysis should be begun within the following times.

	Physical and chemical analyses	Microscopic examinations
	Hours	Hours
Ground waters.	72	72
Fairly pure surface waters.	48	24
Polluted surface waters.	12

In general the shorter the time elapsing between the collection of a sample and its analysis the more reliable will be the analytical results.

Turbidity. The turbidity of water is due to suspended matter such as clay, silt, finely divided organic matter, microscopic organisms, etc.

The standard for turbidity adopted by the United States Geological Survey,¹ is a water containing 100 parts per million

¹ F. D. West: Proc. Ill. Water Supply Assoc., Vol. VI, pp. 49-51, 1914.

of silica in such a state of fineness that a bright platinum wire 1 mm. in diameter can just be seen when the centre of the wire is 100 mm. below the surface of the water and the eye of the observer is 1.2 meters above the wire. This observation should be made in the middle of the day, in the open air but not in sunlight, and in a vessel so large that the sides do not shut out the light so as to influence the results. The standard may be prepared by sifting dry Pear's "precipitated fuller's earth" through a 200-mesh sieve and suspending 1 gram of the material in 1 liter of distilled water. This has a turbidity of 1000 but should be tested by diluting with nine times its volume of water and trying out with the platinum wire apparatus. If not exactly right it may be adjusted by adding more silica or more water. This method requires a rod with a platinum wire 1 mm. in diameter inserted in it 1 in. from one end and projecting from it at least 25 mm. Near the other end of the rod and 1.2 meters from the wire is fixed a small ring, directly above which the observer places his eye when making the observation. This rod is graduated so that when lowered into the water to be tested, as far as the wire can be seen, the level of the water on the graduated scale indicates the turbidity.

Turbidity may also be determined by the candle turbidimeter,¹ which consists of graduated glass tubes with flat polished bottoms, enclosed in a metal case. This is supported over an English standard candle so that the distance from the bottom of the tube to the top rim of the candle shall be 3 ins. The observation is made by pouring the sample of water into the tube until the image of the candle flame just disappears. This test should be carried out in a darkened room or with a black cloth over the head. An electric light may conveniently be substituted for the candle as it avoids any deposit of soot or moisture on the tubes. The calibration of the instrument may be made by means of the silica standards already mentioned.

Color. The "true color" of water is that due to substances in solution while the "apparent color" is that of the original

¹ Tech. Quart., Vol. XIII, pp. 274-279, 1900.

unfiltered sample and includes also any color caused by suspended matter.

A convenient standard for color¹ is prepared by dissolving 1.246 grams of potassium platonic chloride ($\text{PtCl}_4 \cdot 2 \text{KCl}$), containing 0.5 gram of platinum, and 1 gram crystallized Cobalt chloride ($\text{CoCl}_2 \cdot 6 \text{H}_2\text{O}$), containing 0.25 gram of cobalt, in water with 100 c.c. concentrated hydrochloric acid and diluting to 1 liter with distilled water. This solution has a color of 500 and by diluting in Nessler tubes standards of 0, 5, 10, 15, 20, 25, 30, 35, 40, 50, 60 and 70 should be prepared. These tubes should be of such diameter that the graduation mark is 20 to 25 cm. above the bottom and of such uniformity that the distance from the bottom to the graduation of the longest tube shall not be more than 6 mm. greater than that of the shortest tube. The tubes should be protected from light and dust when not in use.

The color of the sample is measured by filling a standard Nessler tube to the height equal to that in the standard and then comparing by looking vertically downward through the tubes upon a white surface placed at such an angle that light is reflected upward through the liquid. Water with a color greater than 70 should be diluted before testing, and water containing suspended matter should be filtered unless the apparent color is desired, in which case unfiltered water should be used.

Nitrogen. This occurs in water in various forms as ammonia, nitrites, nitrates, etc., and its determination has been standardized by numerous methods. It is of very great importance when considering water from a sanitary standpoint, as its presence in any appreciable quantity indicates pollution, but as it is of minor importance in the manufacturing operations of paper making the methods for its determination will not be discussed.

Oxygen Consumed. This is determined by heating 100 c.c. of the water with 10 c.c. of dilute H_2SO_4 and 10 c.c. of a standard solution of potassium permanganate, adding 10 c.c. of a

¹ Am. Chem. J., Vol. XIV, pp. 300-310, 1892.

standard ammonium oxalate solution and titrating the excess with the permanganate.

It is considered by some as an indication of the amount of carbonaceous matter present but where pollution, or contamination with trade wastes, has taken place it will also include such materials as nitrite nitrogen, ferrous iron, sulphides, etc.

As a substitute for this determination it is suggested that a direct determination of the bleach consumed by the water under conditions of temperature and time similar to those of actual fibre bleaching operations would be of much more value to the paper maker. This can be carried out by adding a known volume of a standard hypochlorite solution and after allowing it to stand for a definite time determining the amount remaining; the difference represents the amount consumed.

Residue on Evaporation. Ignite and weigh a clean platinum dish, and measure into it 100 c.c. of the thoroughly shaken sample. Evaporate to dryness on the water bath, heat in an oven at 103° C. or 180° C. for one hour, cool in a desiccator and weigh. The increase in weight gives the total solids or residue on evaporation. The results should be expressed as parts per million and the temperature of drying should be given in the report.

Fixed Residue. Ignite the total solids in the platinum dish at a low red heat. Cool, moisten the residue with a few drops of distilled water, dry in the oven, cool in a desiccator and weigh. For the greatest accuracy an electrically heated muffle furnace should be used. The loss on ignition is the difference between the total residue on evaporation and the fixed residue on evaporation.

Suspended Matter. This may be determined directly by means of an asbestos lined Gooch crucible or indirectly by calculation from the difference between the total solids in filtered and unfiltered portions of the same sample.

A test which gives valuable information regarding the paper making value of water is made by treating a definite volume of the water with enough dilute aluminum sulphate solution to

precipitate all coagulable matter. After allowing it to stand a sufficient time for coagulation to take place, it is filtered through a Gooch crucible or through a tared filter paper and the weight of the precipitate determined by difference after drying. The amount and character of the precipitate indicate whether the water will prove satisfactory without filtration or whether it will be necessary to treat it with alum and filter before using.

Hardness. A water is said to be hard when it contains in solution mineral constituents, which form insoluble compounds with soap. The most accurate method of ascertaining total hardness is to calculate it from the amounts of calcium and magnesium found by analysis of the sample. If appreciable amounts of iron or other metals are present these must be included in the calculation. The total hardness expressed as CaCO_3 equals 2.5 Ca plus 4.1 Mg.

Titration with standard soap solution is a method often employed for determining total hardness, though in reality it merely measures the soap consuming power of the water. The soap solution is prepared by dissolving 100 grams of dry, white Castile soap in 1 liter of 80 per cent alcohol. After standing several days dilute 100 c.c. to 1 liter with 70 per cent alcohol and standardize against a solution of calcium chloride containing the equivalent of 0.2 gram CaCO_3 per liter. This is done by placing 20 c.c. of calcium chloride solution in a 250-c.c. glass-stoppered bottle and diluting to 50 c.c. with distilled water which has been recently boiled and cooled. To this the soap solution is added from a burette, 0.2 to 0.3 c.c. at a time, shaking vigorously after each addition, until the lather remains unbroken for five minutes over the entire surface of the water while the bottle lies on its side. Repeat this test, using 15 c.c., 10 c.c. and 5 c.c. of the calcium-chloride solution and finally distilled water alone, and from the results plot a curve showing the relation of various quantities of soap solution to corresponding quantities of calcium carbonate and hence to parts per million of hardness.

In testing water 50 c.c. of the sample are placed in the bottle and the test carried out exactly as in the standardization of the soap solution. If magnesium is present a false end point may be obtained. To see if this is the case, read the burette when the end point has apparently been reached and then add 0.5 c.c. more of the soap solution. If the end point was caused by magnesium the lather will disappear and the titration must be continued until the true end point is reached.

Temporary Hardness. Temporary hardness is due to magnesium or calcium carbonates which are held in solution as bicarbonates by dissolved carbon dioxide, and which are partly precipitated when the latter is driven off by boiling. It is most accurately estimated by determining the alkalinity by titration with N/50 acid, using methyl orange as indicator, both in the original water and again after boiling, cooling, making up to the original volume with boiled distilled water and filtering. The difference between the two titrations represents temporary hardness which would include iron bicarbonate.

Alkalinity or Acidity. Alkalinity or acidity may be determined by titration with N/50 acid or sodium carbonate respectively. Indicators for alkalinity include phenolphthalein, methyl orange, lacmoid and erythrosine while for total acidity phenolphthalein should be used.

Chlorides. The chlorides in water are due to common salt, which may come from mineral deposits in the earth, from wind-borne ocean vapors or from sewage and trade wastes.

It may be determined by titrating a measured volume of the water with standard silver nitrate, using chloride-free potassium chromate solution as indicator. This shows a faint reddish color when the end point is reached. If the water has a color greater than 30 it should be decolorized by shaking with a little washed aluminum hydroxide and allowing it to settle. The clear portion is then used for the test. The results should be expressed as parts per million of chlorine.

Iron. Iron may be present in both the ferrous and ferric states. In ground waters it is usually in the ferrous condition

and combined with carbonic or sulphuric acid or with organic matter. After exposure to air it is frequently present as a colloidal hydroxide. Silt-bearing waters often contain much iron in suspension, while waters contaminated with sewage effluents and manufacturing wastes contain various forms of iron of different degrees of solubility.

The total iron present may be determined as follows: Evaporate 100 c.c. of the water to dryness and ignite at a low red heat. After cooling add 5 c.c. of concentrated hydrochloric acid, moisten the surface of the dish and warm two or three minutes, again moisten the inner surface of the dish with the acid and wash the solution into a 50-c.c. Nessler tube. Dilute to 50 c.c., add 3 drops of N/5 potassium permanganate solution and then add 5 c.c. of potassium sulphocyanide solution. Compare the color produced with that from solutions of known iron content similarly treated with sulphocyanide.

The fixed residue from a previous determination may be dissolved in hydrochloric acid, converted to sulphates by evaporation with sulphuric acid, and treated as in the modified Stokes and Cain method as applied to the analysis of alum.

Manganese. The determination of manganese may be carried out colorimetrically if the water contains less than ten parts per million but if more than this amount is present it may be preferable to use a volumetric or gravimetric method.

The amount of water used should contain not more than 0.2 mg. of manganese. Add to it 2 c.c. of nitric acid (concentrated acid diluted with an equal volume of water), and boil down to 50 c.c. Precipitate the chlorides with silver nitrate, being sure that a slight excess is used, and filter. Add about 0.5 gram ammonium persulphate crystals and warm the solution until the maximum permanganate color is developed, which usually takes about ten minutes. At the same time prepare standards containing 0.2, 0.4, 0.6 c.c., etc., of the standard manganous sulphate solution to about 50 c.c. and treat them in exactly the same way as the standard. Transfer sample and standards to Nessler tubes and compare the color at once.

The standard manganous sulphate is prepared by dissolving 0.288 gram of the purest potassium permanganate in about 100 c.c. of distilled water, acidifying with sulphuric acid, boiling and just discharging the color with a dilute solution of oxalic acid. After cooling and diluting to 1 liter, 1 c.c. of the solution contains 0.1 mg. of manganese.

CHAPTER XIV

TESTING WOOD PULPS

In the purchase of wood pulp it is very desirable to have some means of judging its quality, as otherwise the material obtained is quite likely to be entirely unsuited to the grade of paper being made. The usual crude tests, such as feeling of the sheet, tearing it and noting the length of fibre, biting the fibre to note its hardness, etc., at best give but a slight idea of its suitability for the work in question and if intelligent purchases are to be made more definite methods of testing must be devised. Accurate sampling and testing are also very essential in the case of moisture determinations, since pulp is purchased on a 10 per cent moisture basis and large sums of money are frequently at stake.

The following methods are those which have been gradually worked out during years of experience but they are given as a working basis rather than as final and unalterable procedures, since it is certain that many of them are capable of considerable improvement.

Moisture in Wood Pulp. Baled Pulp. The following is the official method of sampling and testing baled pulp as adopted by the American Paper and Pulp Association and the Association of American Wood Pulp Importers.

“All tests must be made by a chemist duly authorized and approved by the joint committee representing the Association of American Wood Pulp Importers and the American Pulp and Paper Association on one side and the Scandinavian Wood Pulp Associations on the other side, and must be made strictly in accordance with the following instructions — otherwise the committee reserves the right to withdraw the approval of any chemist at any time.

"Before proceeding to the weighing and sampling the chemist must ascertain that not less than half of the parcel in question is available.

Number. Not less than 5 per cent, nor more than 10 per cent of the entire shipment, but not less than ten bales shall be sampled. Samples to be drawn only from sound and intact bales, from different sections of the entire shipment, and analyst shall be careful to observe that no unusual conditions prevail in the selection of the bales. The accurate weight of all bales sampled to be ascertained by sworn weigher before sampling, or, wherever sworn weigher is not available, by a competent person who must make sworn affidavit that weights are correct, and no other bales than those weighed to be sampled, and whenever bales are numbered, the number is to be given in addition to the weight.

"Method of Sampling

Depth of Boring. The sample shall be taken by boring into a bale to a depth of 3 ins. (7.62 cm.) with a special auger which cuts a disk about 4 ins. (10.16 cm.) in diameter.

Selection of Disks. The disks shall be removed, and ten of them taken as a sample, these to be selected as follows:

- 1 disk 2nd sheet from the wrapper.
- 2 disks 1 in. (2.5 cm.) deep.
- 3 disks 2 in. (5.05 cm.) deep.
- 4 disks 3 in. (7.62 cm.) deep.

10

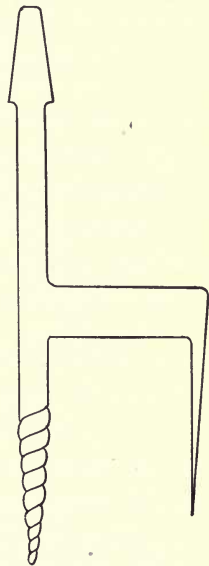

FIG. 40. CUTTER FOR SAMPLING PULP

Location of Borings. The holes to be bored shall be so located that in five successive bales they will represent a portion extending diagonally across the bale. Each bale to be bored but once. The first hole to be bored at the corner, the edges of the cut being

at a distance of one inch from the edge of the bale. The second cut shall then be made half way between the location of the first cut and the center of the bale, the third bale shall be cut at the center, the fourth bale half way between the center and the corner, and the fifth bale in the opposite corner in a position corresponding to the first.

“All samples must be either weighed immediately after being drawn from the bales by accurate scales, or, when this is impracticable, must be put into airtight vessels, made of metal or glass, with ground-glass or metal stoppers, and due care must be used in the transportation of such samples until they can be properly weighed at the laboratory of the chemists. The entire bulk of samples selected from the bales must be dried out for the test. The temperature in the drying oven shall not exceed 212° F.

“Chemists must have proper and adequate equipment for weighing and sampling the bales, and for the weighing and drying of samples.

“All sampling of pulp must be done by or supervised by the approved chemist personally, or by his bona fide assistants — each chemist to file with the committee a complete list of his bona fide assistants who will do the sampling, such list to have the approval of the committee. The chemist will be held responsible for the correct sampling by his approved assistants. The committee shall at any time have the privilege of investigating the sampling done by chemists or their assistants.

“Every test certificate shall clearly state the name of the person who did the sampling.

“The test certificates hereafter shall be uniform and in accordance with forms to be approved by the committee, a sample draft of which will be furnished by the committee to each chemist.”

This procedure can also be applied to rolls, making the first boring 1 in. from the end, the second half way between the end and the middle, the third at the middle, and so on.

This method of testing is the quickest of any which has been proposed and it leaves the bales or rolls in good shape to be stored or shipped but it is not necessarily the most accurate. In

the opinion of the author it favors the seller of the pulp since the percentage of moisture decreases more rapidly on the outside than in the centre and the loss in the weight of the bale does not keep pace with the decrease in the percentage of moisture as shown by the sample taken. This is particularly true of bales put aside for a retest and stored in a comparatively dry place for several weeks; such retests therefore nearly always show a greater net weight of air dry pulp than do the original tests.

The quarter-sheet method of sampling consists essentially of opening up the bales and taking a quarter of a sheet from different parts of the bale in such a way that the combined samples would cover the entire area of the bale. It is variously applied by different workers; some take two quarter-sheets from each bale, others more, the extreme being ten quarter-sheets starting with the second sheet from the wrapper and spacing the others equally between the second sheet and the centre of the bale. On the whole it is believed that the quarter-sheet method is more accurate than the disc method already described but that it is unpractical because of the large amount of time and labor involved and because it leaves the bales in no condition for storage or further shipment.

Lap Pulp. The methods of testing pulp for moisture have been exhaustively investigated by the Technical Section of the Canadian Pulp and Paper Association.¹ For lap pulp from ordinary wet machines or Rogers wet machines they tentatively recommend taking a strip 3 ins. wide clear across the sheet and to the full thickness of the sheet. Such a sample should be taken for each 2000 lbs. of wet stock in the shipment. Tests by this method in comparison with the entire sheets dried out prove that the two methods give practically identical results and that the strip method is therefore accurate.

For hydraulic pressed pulp they recommend the wedge system as proposed by Woodruff.² They have proved that this method gives more accurate results than the strip method in which

¹ Slack: Pulp Paper Mag. Can., XVII, 1919, 265.

² Woodruff: Paper, Oct. 3, 1917, p. 86.

2-in. strips are cut from the centre of the lap to the outer edge, the cut portions forming a cross for each four samples. In the wedge system for hydraulic pulp a template is employed to mark the laps. This template has an angle of 9 degs. and at its apex is attached a disc divided into forty parts. This disc is placed at the centre of the lap and the wedge marked out by a pencil along the edges of the template. The lap is put one side and the next marked in a like manner, but moving the wedge of the template to the second position on the disc. Forty laps are thus marked, giving a total sample equivalent to one entire lap. The marked laps are then taken to a circular saw and the wedges cut out. These wedges may be split in halves if it is necessary to reduce the bulk of the sample.

Strength or Beating Test. This method of testing was first described by the writer in 1915¹ and was the outcome of an attempt to demonstrate experimentally the variations in the strength of sheets made from different sulphite fibres after they had been given the same beating treatment. The method first proposed is as follows:

The fibre to be tested is allowed to become air dry and two lots of 50 grams each are then weighed out. One of these is soaked up in 1000 c.c. of water and reduced to pulp by rubbing with the hands; it is then rinsed into a small pebble mill with just 1000 c.c. more water. The mill is now closed and allowed to revolve at 60 revolutions per minute for exactly an hour, at the end of which time the entire contents are emptied upon a $\frac{1}{2}$ -in. mesh sieve and the pulp washed off the stones into a pan placed beneath the sieve. The pan is then filled to a definite mark — 27 liters total contents, and four sheets are made on a hand mould, taking two dips for each sheet and reversing the hand mould between dips so that the sheets may be of uniform thickness on the two edges. After pressing between felts in a copying press the sheets are air dried and are then tested for strength with an Ashcroft tester. Five bursting tests are made on each sheet along one of the diagonals and the average of the twenty

¹ Paper, Nov. 10, 1915.

tests taken as representing the beaten strength of the sample. If it is desired to compare the strength before and after beating the second sample of 50 grams is broken up into a pulp as before and made into sheets from the same volume of water as in the case of the beaten pulp.

This method has been slightly modified¹ by the Committee on Sulphite Pulp of the Technical Association of the Pulp and Paper Industry but the changes they propose are largely to shorten the time required and do not alter any of the essential features of the test as originally proposed.

Many factors influence the results of this test and in order to get concordant results careful control is necessary. This does not lessen the value of the method but it means that intelligent supervision is essential if the best information is to be derived. Some of the vital factors will be briefly mentioned.

The size of the pebble mill as well as its volume and charge of pebbles must be carefully considered. Two mills of the same make often vary enough in size and capacity so that very different beating effects are obtained. The only satisfactory way seems to be to assume one to be right and adjust the charge of pebbles, fibre and water in the other so that the same strength test will be given by the beaten fibre. If the results in two plants are to be directly comparable it will of course be necessary to standardize their pebble mills on the same lots of fibre. This is not a serious inconvenience and is not found to detract much from the value of the test since in most cases comparative results only are wanted.

The proportions of fibre and water must be closely adhered to, as comparatively slight variations cause appreciable differences in the bursting strength. This is also true of the time of beating, which should be regulated with care and not allowed to vary more than a minute or two.

Factors having minor influence on the tests are the temperature of the water in the pebble mill and the relative humidity of the

¹ Paper, Nov. 8, 1916.

atmosphere when the bursting tests are made. For ordinary routine tests consideration of these factors may be neglected.

A variable having great influence in many cases is that of the moisture in the pulp when taken for the test. Wet pulp will not give the same test as it will after being air dried. Experiments on one lot of pulp showed that the beaten strength was highest in the wet lap and decreased as the moisture diminished; the change from 70 to 5 per cent moisture reduced the bursting strength from 64.7 lbs. to 40 lbs. This change cannot be reversed by wetting dry pulp, which indicates the reason for air drying all samples before testing so that all may be on the same basis. For the most accurate work it would be very desirable to dry all samples at a constant humidity since this would insure more concordant results. One of the changes which it was proposed to make in the original method was to press the samples of wet pulp to a constant moisture and use this pulp as a basis for the test. This shortens the time required but it does not permit comparison of the wet pulp with one received in the air dry condition.

A point of very great importance is the manner of forming the sheets to be tested. If a hand mould is used the weight of the sheets varies considerably depending on whether the fibre is "free" or "greasy" after beating. It has been proposed to get around this difficulty by calculating the breaking test per unit weight of sheet but this is not an entirely satisfactory method. All such variations can be eliminated by using some form of sheet making machine in which a constant volume of stock is used and none is lost by overflowing the edges as happens with the deckle of the hand mould.

Different methods of employing this test may be used; the original idea was to beat for a fixed time and note the differences in the strength developed, but Hatch¹ has adopted the modification of beating a number of samples for different lengths of time in order to see what maximum strength would be developed and the time necessary for its production.

For other interesting data relating to the beating test reference

¹ Paper, Oct. 3, 1917.

is made to the work of Mansfield and Stephenson¹ and of Sutermeister.²

This method of testing gives satisfactory results with sulphite, soda, and sulphate pulps but does not appear suitable for ground wood since the latter is not affected by the beating treatment to nearly so great an extent as the others.

Color Comparison of Bleached Pulps. The method outlined here has been taken, with slight modifications, from the report of the Committee on Sulphite Pulp of the Technical Association of the Pulp and Paper Industry.³

The grading of the shade of a piece of bleached pulp usually leads to very uncertain results. Two pieces of pulp, which under certain conditions of light appear identical in shade, under different light conditions appear to be very different in shade. Very often bleached pulp which is satisfactory in shade under artificial light, appears quite yellow in daylight. Again, different pieces of the same pulp often appear to be of different shade, when graded together under identical light conditions. This latter phenomenon can be due only to one cause: differences in the surfaces of the two pieces of the same pulp. The problem to be solved therefore appeared to be twofold.

1. To devise some means of obtaining constant illumination conditions; and this illumination to be of such a quality that slight differences in shade could be easily distinguished.

2. To devise a means whereby

- (a) the surface of different pulps could be made the same, or
- (b) the effects of different surfaces of different pulps could be minimized.

Many so called daylight lamps were tried, including both the bulb and arc types. Finally the arc type of color comparator made by the General Electric Company was adopted as giving

¹ Pulp Paper Mag. Can., Oct. 1, 1916.

² Paper, Dec. 11, 1918.

³ Paper, Nov. 8, 1916, 19, No. 9.

the most constant artificial light of all those tried out and a light whereby one could most easily distinguish small differences of shade.

The procedure adopted consists in attaching six disks of the pulp to be tested to the front of six wheels of varying degrees of whiteness. The wheels and pulp are then revolved at high speed (2,500 revolutions per minute) and the operator judges to which of the standardized color wheels the pulp is nearest in shade. The shade of pulp is then declared to be that of the wheel to which it is nearest in color. The test being made always under the same conditions of illumination both variable factors of light and pulp surface are rendered constant and thereby the remaining variable, the actual shade of pulp, can be easily determined.

Description of Apparatus

1. *Cutting Press.* The disks of pulp are cut with a press and dies of the type FO₂, made by the Ferracut Machine Company, of Bridgeton, N. J. The dies are so arranged that a disk $3\frac{1}{2}$ ins. in diameter is cut with a $\frac{3}{8}$ in. hole in the center, at one operation.

2. *Revolving Disk Machine.* Fig. 41 gives details of the construction of this apparatus. The method of preparing the differently shaded wheels is as follows: Different combinations of plaster of Paris, magnesia and chromate of potash are made into a paste with water, this paste poured into the brass wheel, allowed to set and then planed down to a smooth surface.

It is recognized, of course, that one fixed standard of color shade is not applicable as a standard to all kinds of pulp. For example: bleached pulp when run from a drying machine has a radically different shade from the same pulp run through a wet machine and hydraulically pressed. Yet both pulps on being made into paper would give identical color shades to the paper. Hence, it is necessary to employ different color mixtures on the revolving disk machine for different types of pulp. Again the standard of pulp color shade demanded by some manufacturers of paper is entirely different from that of other manufacturers. Hence it is not possible to recommend a formula applicable to

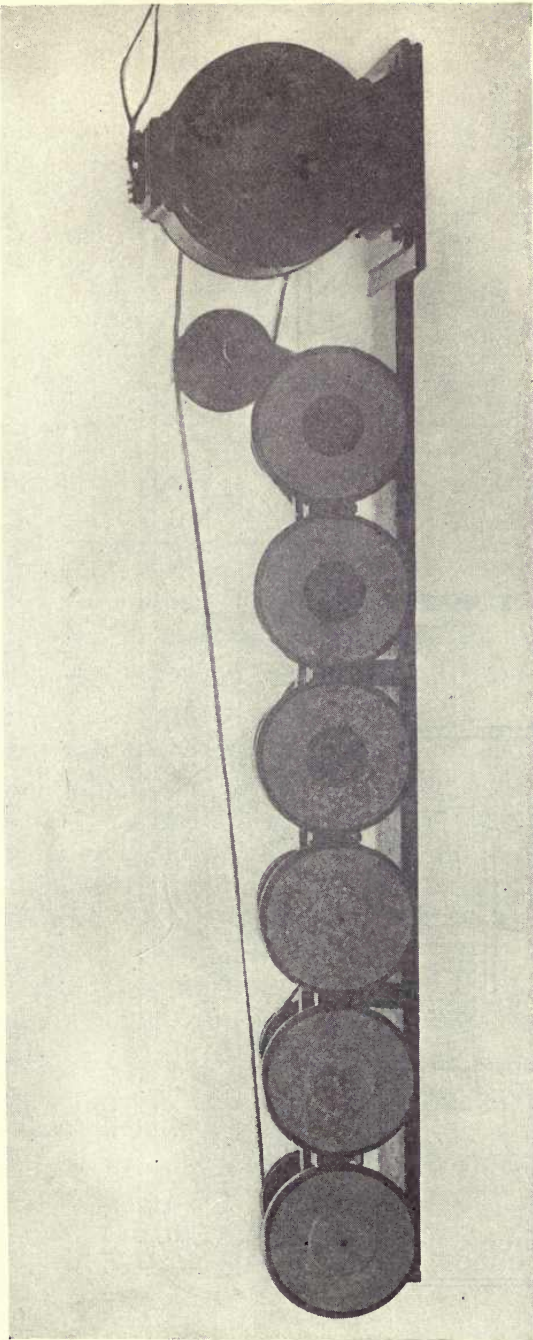

FIG. 40a. PHOTOGRAPH OF COLOR MATCHING APPARATUS

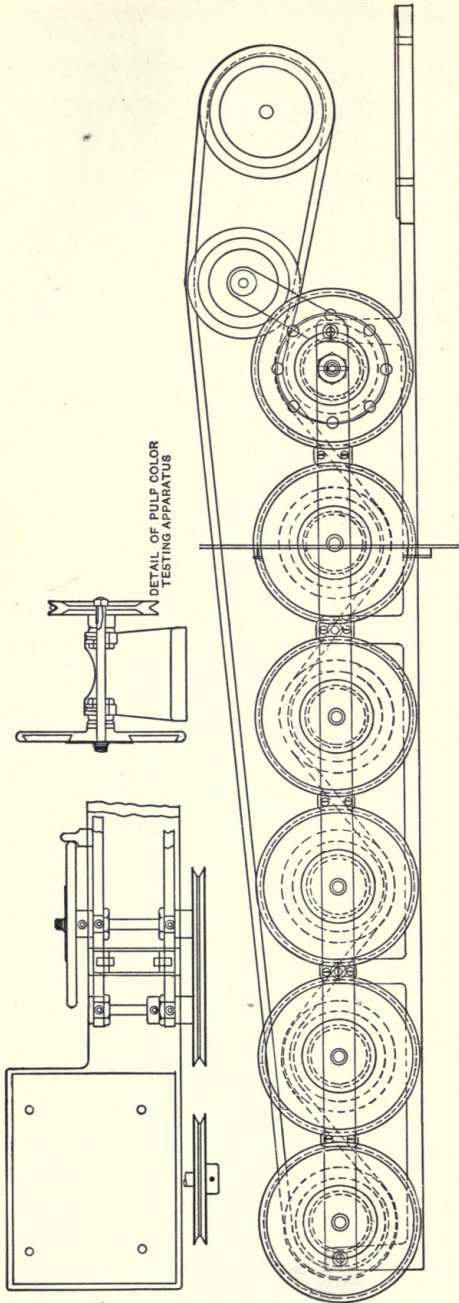

FIG. 41. COLOR TESTING APPARATUS FOR WOOD PULPS

all cases. The formula given here is applicable to bleached drier pulp and the color 95, as named in this report, when applied to this product is satisfactory to the great majority of paper manufacturers in this country.

The different wheels are numbered as follows, reading from left to right:

100, 95, 90, 85, 80, 75.

The formulas are as follows:

No. of wheel	Water	Plaster of Paris	Chromate of potash	Magnesia, powdered
100	120	107	0.0	20
95	120	107	0.0245	20
90	120	214	0.1490	0
85	120	214	0.4660	0
80	120	214	0.6120	0
75	120	214	0.7770	0

The plaster of Paris and magnesia are first thoroughly mixed together, then the water added and the paste thoroughly stirred up and poured into the wheel.

When pouring the wheels containing the chromate, the latter is first dissolved in the water, the solution added to the plaster of Paris, the whole thoroughly stirred up and poured into the wheel.

After pouring, the wheels are allowed to set forty-eight hours and then revolved by means of the motor, and turned down smooth with a sharp-edged cold chisel and finished with fine sandpaper.

A sewing machine belt was tried out to drive the machine, but a satisfactory fastener could not be found which at the speed employed would not pull out after a short time. It was found that $\frac{1}{4}$ in. rope with a spliced joint stands up very well.

3. *Daylight Lamps.* Two of these, manufactured by the General Electric Company, are used. They are known as their direct current multiple color matching outfits. The whole apparatus, of course, is placed in a dark room, where no light rays can penetrate to interfere with the light of the lamps.

This method of testing is a noteworthy attempt at putting the designation of color on a numerical basis in a practical way and it is in successful operation in several mills. The equipment is however rather expensive, and if several grades of pulp, such as soda poplar, sulphite spruce, and sulphate pine, are to be examined a large number of standard discs must be kept on hand and the preparation of the filling for such discs is by no means easy and is often quite unsatisfactory.

It is the belief of the author that fully as reliable comparisons can be made by using hand mould sheets as explained under "Bleaching Qualities." It is of course desirable that such comparisons should be made under a "daylight lamp" in a dark room but if this is not available a north light should be used and tests made at as nearly as possible the same time each day.

Bleaching Qualities. The method used in determining the bleach required by a sample of fibre depends on the point of view of the observer and should in general be made to conform as closely as possible to actual operations in the plant in question. The method preferred by the author is as follows: Two 50-gram samples of the fibre are weighed out and at the same time a small sample is taken for a moisture test. From this moisture test it is possible to calculate the air dry fibre (10 per cent moisture) corresponding to the 50-gram samples and upon this air dry weight the figures for bleach are based. One of the samples is now broken up in a little water in a 6-in. by 8-in. battery jar until a uniform pulp is obtained and this is then diluted to about two liters with water. From a solution of bleaching powder, whose strength has previously been determined, a volume is measured out which corresponds to the percentage of bleach which it is estimated the fibre will require. This is added to the jar of pulp and the contents kept agitated and at about 35° to 40° C. until the bleach is just exhausted. The fibre is then thrown upon a screen of 70-mesh wire and washed with a heavy stream of water to remove the bleach residues and break up any knots or balls of fibre which may have formed. The pulp is next made into hand mould sheets which are dried on a small steam heated

cylinder and compared with sheets of pulp of the standard color. If the color is found to be much different from the standard a second test is made using more or less bleach as the first test indicates.

Since bleached fibre slowly changes in color it is quite essential to obtain some permanent standard but so far efforts along this line have not been entirely successful. Plates of dull porcelain have been suggested but the difference in surface texture between the porcelain and the fibre sheets would probably render the comparison of their colors quite unsatisfactory. Attempts have also been made to use slabs of plaster of Paris tinted to the right shade and given the desired surface texture by pressing between felts. Great difficulty was experienced in getting just the right color in such slabs. The most practical method seems to be to cut out a large number of samples from the same lot of unbleached pulp and determine with great care the amount of bleach required to give the standard white color. After this is determined one sample is bleached each month, the sheets made therefrom serving as the standard for the month following.

In plants where practically this same method of bleaching is carried out the above scheme of testing is found to give results in very close agreement with those of actual practice. In other plants where an excess of bleach is added and the residual bleach washed out after the color is brought up to the desired shade a method of testing employing these same principles should be used. In such tests a known amount of bleach is added and that remaining at the end of the test is determined by analysis; from these data the per cent used by the fibre may be calculated. This method of testing is quicker than the one first given but it is necessary to compare the colors of the bleached fibres in the wet state before the yellow products of the bleaching action have been removed.

Richter¹ has suggested a method of testing sulphite fibres which depends on the comparison of the colors developed on treating samples of unbleached fibre with nitric acid. Weighed sam-

¹ E. Richter: Proc. Eighth Int. Cong. Appd. Chem.

ples of the fibre to be tested, and also of one whose bleaching properties are known, are treated with 13 per cent nitric acid solution for about an hour; portions of the acid are then drawn off and compared in a colorimeter of any standard construction. Knowing the bleach required by one fibre it is possible to estimate that necessary to produce the same color in the other sample. This method is quick and may possibly be reasonably accurate with fibres cooked under nearly the same conditions but with samples from a number of different mills it proved to be only approximate, some of the results being as much as 10 to 15 per cent higher or lower than the figures obtained by actual bleaching trials. Moreover it does not appear to be applicable to soda and sulphate fibres, at least when a sulphite fibre is used as a standard for comparison.

Loss in Weight on Bleaching. This test, taken in connection with the bleaching test, throws considerable light on the value of a pulp, since it shows what loss in weight will be suffered by the fibre because of the oxidizing and solvent action of the bleach, apart from the mechanical loss in the bleaching process, which should be practically the same for all fibres. The method is as follows:

Weigh out two samples of about 2 grams each and determine the moisture in one by drying to constant weight at 100° to 105°. The second sample is broken up to a pulp in a little water by rubbing between the thumb and fingers and the pulp transferred to a small flask. This procedure requires care and skill but after a little experience it can be done with no loss of fibre. Bleach solution is now added from a burette, the amount being regulated to give the percentage which the bleaching test proved would give the standard white color in the sample being tested. The flask is now kept at about 35° to 40° until the bleach is exhausted, when the fibre is transferred to a Gooch crucible, washed very thoroughly with hot water, dried and weighed. The difference in the bone dry weight of the unbleached and bleached fibre, which shows the loss due to the chemical action of the bleach, may conveniently be expressed as percentage of the former.

Sedimentation Test. This test is one which has not yet been standardized but which has been applied to the study of pulps by many different observers most of whom used home-made apparatus of some sort. The principle of the test is that the longer the fibres have been beaten, or in the case of ground wood the finer it is ground, the more slowly it will part with its water. The general method of making the test is to place a known amount of fibre, reduced to a uniform pulp in a definite volume of water, in some sort of receptacle with a perforated bottom through which the water can drain and on which the fibre settles to form a mat. A valve below the false bottom prevents the escape of the water until the desired time and makes it possible to record the time of outflow. In Fishburn and Weber's apparatus¹ the receptacle is a graduated glass cylinder and the test consists in noting the time required for the water level to drop $9\frac{1}{2}$ ins. In the Riegler-Schopper² tester, Fig. 42, the water draining from the stock falls into a chamber having two discharge outlets of different dimensions and at different levels. The amount of water issuing from the large orifice, which is at the higher level, gives an indication of the degree of beating or the natural slowness or quickness of the stock. The smaller opening, which discharges under a practically constant head, acts as a sort of automatic cut-off and by taking care of the last slow drainage from the test sample it makes the differences in the results more marked.

A test of this nature, using a long tube as a sedimentation chamber, has been used in testing sulphite pulps and it is claimed³ that it shows very marked differences between long and short fibred stocks.

Nature and Amount of Dirt. The dirt in a sample of pulp can be successfully investigated if a sheet of it is wet and examined by transmitted light. A convenient outfit consists of a box painted white inside and fitted with two or more electric light

¹ Fishburn and Weber: Paper, Oct. 11, 1916, 13.

² U. S. Pat. 1,193,613, Aug. 8, 1916. Paper, Aug. 30, 1916.

³ "Snowshoe": Pulp Paper Mag. Can., Sept. 5, 1918, XVI, 793.

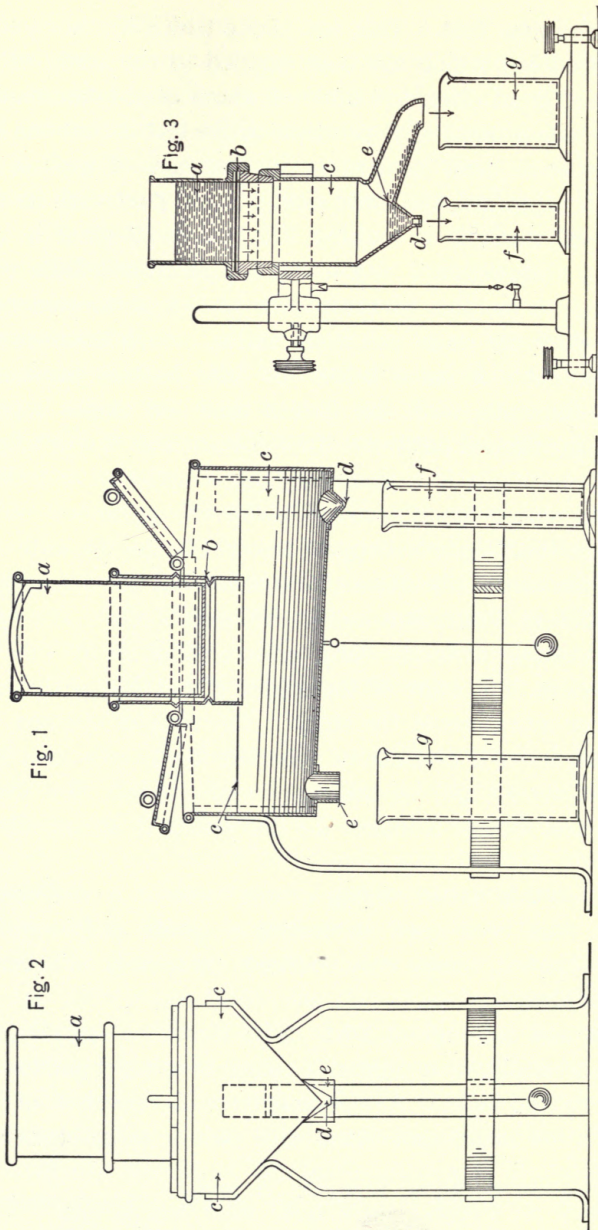

FIG. 42. RIEGLER-SCHOPPER SEDIMENTATION TESTER

bulbs. The top of the box consists of a glass plate upon which the pulp rests. This box may be of any convenient size but the sample of pulp should completely cover its top so that no glare from the lights enters the observer's eyes. If a box is made to take a sheet $6\frac{1}{4} \times 8$ ins. and the dirt is counted on both sides a simple multiplication by 2 gives the dirt count per 100 sq. ins., which has been found a satisfactory method of expressing the results. The sheets to be examined should be of nearly uniform thickness so that the count may be on practically the same quantity of pulp in every case. If desired the dry sheets can be weighed before testing and in this way the dirt count can be placed on a weight basis. If the material in question is not received in the form of sheets it may be made into sheets on a hand mould before examination. It will be found convenient to dry these completely and again wet them before examination; this will enable the wet sheets to be handled with much less trouble than if they are taken direct from the hand mould in which case they tear so readily that they are extremely difficult to turn over. In making this test it is well to dig out with a needle the specks of dirt which are not directly on the surface, since particles which appear to be dirt, will, in some cases, prove to be small rolls of fibre. It is also desirable to record the results under at least two headings, dirt and shives, and in some special cases it is even well to classify them in such groups as cinders, bark, iron rust, etc., as this will often enable the chief cause of the trouble to be located.

The results obtained in this test depend almost entirely on the opinion of the observer as to what constitutes dirt and since the opinion of different observers often varies widely it is plain that the tests should all be made by one person in order to avoid the personal factor. Records of this nature are valuable in showing whether the product of any plant is being kept up to standard and they are also helpful in selecting pulps in the market when purchases are in question.

CHAPTER XV

PAPER TESTING

In the following chapter are given the methods in common use in the testing of paper, together with some of the more unusual tests which are occasionally called for. It has been attempted to give these methods concisely but in sufficient detail to enable them to be carried out without difficulty by any technically-trained man who has had some experience in the paper industry. It should not be forgotten, however, that the intelligent interpretation of the results depends in many cases upon the judgment of the observer and that good judgment can only be replaced to a slight extent by even the most detailed directions.

The essential features of a number of these tests have been taken from the report of the Committee on Paper Testing of the Technical Association,¹ to which acknowledgement is hereby made, and the student is referred to this report for more complete details of many of the methods. There are also included a considerable number of tests which are not mentioned in this report but which practical experience has shown to be of value in the study of paper. For a more detailed study of the factors influencing many of these tests reference should also be made to Herzberg's "Papierprüfung,"² where the subject is exhaustively treated. The methods of testing are grouped under three heads: microscopical examinations, physical testing, and chemical analysis.

Microscopical Examinations

The microscope offers practically the only means for determining the kinds of fibres and the relative proportions of each

¹ Paper XXV, 693, 739, 777, 831 and 877, Dec. 10, 17, 24, 31, 1919, Jan. 7, 1920.

² Herzberg: Papierprüfung, Berlin, 1907.

in a sample of paper and it is therefore the universal method for making a fibre analysis. The method is rapid, and in the hands of an expert is fairly accurate, but it is probably not desirable to attempt to estimate percentages much closer than 5 per cent. The accuracy attainable depends upon two factors (1) the kind of mixture under examination, *i.e.*, whether two or more fibres, and how beaten and (2) the experience and care of the observer. As a rule, the opinion of one thoroughly trained and careful analyst is more exact than the average judgment of several inexpert men who have spent collectively much more time on the examination.

The microscope used should be of some standard make so that attachments may be added from time to time as seems desirable. The particular kind of microscope and whether monocular or binocular is largely a matter of personal preference. This also holds true of the magnification employed, some advocating 45 diameters and others 120 or even as high as 160 diameters. An instrument with two-thirds and one-sixth inch objectives and 1- and 2-inch eyepieces will be found to give as great a range of magnification as is necessary for all ordinary paper-mill work. A substage condenser and iris diaphragm should by all means be included and it is very desirable to add a stage micrometer and an eyepiece micrometer.

Estimation of Fibre Content. In order that the sample taken shall be representative several small pieces should be clipped from various parts of the sheet, or if several sheets are available small pieces should be taken from each. These should be placed in a dish, small flask, or any suitable container, covered with 0.5 per cent caustic soda solution, and heated to the boiling point in order to dissolve sizing or binding materials. The samples are then washed several times in water, rolled into a ball and kneaded between the thumb and finger and then reduced to a pulp by shaking vigorously in a test tube about half full of water. A small sample is then removed from the test tube by means of a needle, placed on a microscope slide and the water removed by touching the drop with a piece of

folded filter paper of ordinary quality. The fibres are covered with a drop or two of Herzberg's stain, carefully separated by the aid of microscope needles, so that they will not lie too much in a bunch, and they are then covered with a cover glass. The slide is then ready for examination by means of the microscope.

In preparing the sample for examination a number of precautions must be observed if good results are to be obtained, and a discussion of some of these important points will be helpful, at least to those who are just beginning the work.

There are several methods of removing a representative sample from the test tube. Spence and Krauss¹ prepare a rather dilute pulp in a test tube about $\frac{3}{4} \times 8$ ins. and for removing the sample use a glass tube 10 ins. long by $\frac{7}{8}$ -in. in diameter. This tube is fitted with a small rubber bulb at one end while the walls at the other are rounded to present a smooth surface. The test tube is well shaken, the dropper quickly inserted 2 ins. below the surface, two bubbles of air expelled and about half an inch of mixture drawn into the tube. This entire portion is transferred to slides, making four drops in all, and the water removed by evaporation in an air bath. The slides are then ready to stain and examine.

Another and more usual method is to prepare the mixture in a smaller test tube, say $\frac{5}{8} \times 6$ ins., and after shaking vigorously remove the sample by inserting a microscope needle and taking out a small bunch of the fibres. This method is better for long-fibred stock such as bond, ledger and writing papers, while the first method is safer for ground-wood papers and others where very short fibres are present.

A modified form of the second method, which makes it applicable to all grades of paper, is to prepare the mixture of such density that on shaking the test tube and then placing it upright, small clots of fibre will remain adhering to the walls of the tube above the liquid. The sample is then obtained by removing all the fibre included in one of these small clots.

Removal of water from the sample before staining may be

¹ Spence and Krauss: Paper, 20, 1917, p. 12, May 23.

done with filter paper or by drying as already outlined, or a blotting paper of firm texture may be pressed down directly on the drop on the slide. This removes the water and leaves the fibre adhering to the slide ready for staining. If a firm blotter, free from lint, is used and any loose fibres are removed by blowing upon its surface just before applying it, no contamination of the sample need be feared. Another method is to place the sample removed by the needle from the test tube directly upon a piece of suitable filter or absorbent paper; this takes up the water and the fibre can then be transferred to the slide.

The use of very thin cover glasses for covering the stained specimen is only to be recommended when very high magnification is to be used. In nearly all fibre analysis it is quite sufficient to use a second thin microscope slide as a cover. This permits several fields to be prepared on one slide and eliminates much breakage. The slide as a cover glass also possesses another advantage over the lighter and thinner form: if the sample is well loosened up with the needle so that no lumps remain and the slide is then dropped onto it from a distance of half an inch or so a very even distribution of the fibres can be obtained.

The Herzberg stain, which is very generally used, is made up according to the following formula:

Solution *A*. 20 grams zinc chloride dissolved in 10 c.c. of distilled water.

Solution *B*. 2.1 grams potassium iodide and 0.1 gram iodine dissolved in 5 c.c. of distilled water.

Prepare the two solutions separately, mix and allow the mixture to stand several hours or until all sediment has settled out. The clear liquid is then decanted and is ready for use in staining fibres; it should be kept in a brown glass bottle or else in the dark. This stain gives different colors with different kinds of fibres; ground wood, jute, flax tow, uncooked manila hemp and practically all highly lignified tissues are colored yellow or lemon yellow. Thoroughly cooked and bleached soda and sulphite pulps as well as bleached straw and esparto fibres are colored

blue or navy blue. Cotton and linen rags, thoroughly cooked and bleached manila hemp and some of the Japanese fibres are colored wine red.

It is very essential that this stain be so made up as to give satisfactory colors on the different fibres. Its quality should be proved by staining a mixture of fibres known to contain about equal proportions of rag, bleached sulphite and bleached soda fibres. If the stain is satisfactory, the soda pulp should stain a dark blue color, while the sulphite, because of its thinner walls, will be a light blue, and the rag fibres will be red or wine-red. If the blue is not clear but tends toward the violet, too much iodine is present and more water or zinc chloride should be added. A stain which gives the best results with ground wood will not always be entirely satisfactory with mixtures of well-bleached fibres and if widely varying papers are to be examined, it is well to keep on hand a number of stains so adjusted that one suitable for any grade of fibre is available. One should be prepared to give a bright lemon yellow on ground wood; a second should give the colors already mentioned on sulphite, soda and rag fibres, etc.

A stain which is considered by some to be better than the Herzberg stain is made up as follows:

✓ Solution *A*. 1.3 grams iodine and 1.8 grams potassium iodide in 100 c.c. of water.

Solution *B*. A clear, practically saturated solution of calcium chloride.

In using this stain apply a drop or two of solution *A* to the moist fibres on the microscope slide. After a minute or so remove the stain by means of a blotter and immediately put on a drop or two of solution *B*. Pull the fibres apart and distribute them by means of needles as before and drop on a cover glass or thin microscope slide. Any excess of solution *B* should be removed by absorbing it with moist blotting paper. This stain is also selective in its action, the colors produced being as follows:

Red or brownish red: Cotton, linen, hemp, ramie.

Dark blue: Bleached soda pulps from deciduous woods.

Bluish or reddish violet: Bleached sulphite fibres and the thoroughly cooked part of the unbleached sulphite.

Greenish: Jute, manila and the more lignified fibres in unbleached sulphite.

Yellow: Ground wood.

As with the Herzberg stain this one should be adjusted by trial on known mixtures of fibre until it shows satisfactory differences in color. The two solutions should be protected against evaporation and dust but light does not change their staining properties to any extent.

In estimating the fibre content of a paper no account is taken of the size, clay, alum, etc., which may be present; the paper is therefore considered as being all fibre and the sum of the percentages of the various kinds is made to equal 100 per cent. The estimation should be based on the examination of at least two samples of fibre removed from the test tube and in some cases where especial accuracy is desired it is well to examine four separate slides. A set of standard samples containing known percentages of the different ingredients is very useful in making comparisons with unknown samples and should be used occasionally to refresh the judgment of the analyst.

There are two methods of determining the percentage of the various fibres, one is the "count method," while the other is known as the "estimation method." In the first method the fibres of each kind are counted and from the figures obtained the percentage of each is calculated. The estimation method depends upon the comparison of the unknown sample with standard mixtures of known composition. The accuracy of this method depends upon the experience of the analyst and upon continual reference to the known standards. It is probably fully as accurate as the count method, is considerably quicker, and is much easier to teach to a beginner. For these reasons it is usually preferred to the count method. In using

either method it is quite obvious that the analyst must be thoroughly familiar with the size, shape, and markings of the various fibres and with the appearance of any ducts, cells, or foreign matter which habitually accompany them. Without such knowledge it is useless to attempt to make a fibre analysis.

A third method has recently been proposed by Spence and Krauss¹ to enable an estimation to be made of the different kinds of fibres in a mixture containing such fibres as hemlock, beech, poplar, birch, maple, etc. Four samples are made up by the method of Spence and Krauss already given. Each slide is examined under the microscope and the lengths of the various fibres are measured in terms of the diameter of the observed field. The magnification recommended is 160 diameters and an adjustable stage is essential in order to cover systematically the entire sample on each slide. After all four samples have been examined the figures are added together to get the total length of each kind of fibre present. This total length multiplied by a weight factor, which varies with different kinds of wood, gives a set of directly comparable results which may be converted into the per cent of each kind of fibre present. The weight factors given are as follows: rag pulp 1; hemlock pulp 0.870; poplar pulp 0.454; birch pulp 0.652; beech pulp 0.525; maple pulp 0.365. Where a mixture of fibres from deciduous woods is under examination the number of counts of each kind to which the weight factor is to be applied may be determined from an examination of the number of ducts present. It was found that the proportion of ducts and fibres in different woods was as follows:

	Per cent ducts	Per cent fibres
Poplar.....	5.9	94.1
Birch.....	2.4	97.6
Beech.....	4.9	95.1
Maple.....	2.3	97.7

¹ Spence and Krauss: Paper 20, 1917, May 23, p. 11.

This method is too slow to be used where many routine analyses are to be made daily but its accuracy recommends it particularly for settling cases of dispute between different authorities.

Unbleached Sulphite Determination. The method given is that worked out by Bright.¹

“The principle of the method is first to stain the fibres with Cross and Bevan’s ferric ferricyanide solution, which colors the unbleached sulphite green, on account of the lignin contained in it, and leaves the bleached sulphite colorless. This alone gives a good distinction, but by subsequently staining with a red substantive dyestuff, the green of the unbleached is changed to a very pure blue, the bleached being colored red, thus giving a most striking contrast.

“The problem is to adjust the treatment with the two solutions to bring out the sharpest contrast. If the treatment with red is too severe, some of the unbleached fibres are likely to be colored purplish, or in extreme cases take on a dull, dirty red color. On the other hand, if the treatment with ferric ferricyanide is continued for too long a time or at too high a temperature, the reagent has a tendency to decompose and form a deposit on the slide as well as on the bleached sulphite, so that the latter turns a dull purplish color when subsequently stained with red.

“The results depend on three factors — namely: (1) the concentration of the solution, (2) the temperature at which each is applied, and (3) the length of time each is allowed to act.

“The solutions are prepared according to the following procedure:

Ferric Ferricyanide

Sol. A. — N/10 FeCl_3 — 2.7 grams $\text{FeCl}_3 \cdot 6 \text{H}_2\text{O}$ per 100 c.c.

Sol. B. — N/10 $\text{K}_3\text{Fe}(\text{CN})_6$ — 3.29 grams per 100 c.c.

“After diluting to the mark with distilled water, filter through dry filters into clean, glass-stoppered bottles — protect from dust.

¹ Bright: Paper 20, 1917, Aug. 29, p. 11.

“Equal volumes are mixed fresh whenever the reagent is used.

Substantive Red

Benzopurpurin 4B extra (Bayer Co.).....	gm. 0.4
Oxamine brilliant red BX (Badische Co.).....	gm. 0.1
Distilled Water.....	c.c. 100

“Have the water hot and stir in the dyes slowly.

“The stain is placed in a tall, narrow, cylindrical beaker, which is set into a water bath. The slides are suspended in the beaker by a clamp which holds them at their upper ends, the clamps resting across the top of the beaker. A thermometer is suspended in the beaker of stain beside the slides. The beaker should be as small as possible so as not to use up too much stain at one time.

“Staining with ferric ferricyanide is done as follows:

“Mix equal volumes of two fresh solutions and heat to 35° C. regulating the waterbath so that it will remain within 1 deg. of the temperature named, for 15 minutes. The dry slide is then dipped in water to moisten it uniformly, so that air bubbles will not be formed when it is immersed in the stain. If air bubbles are formed the fibres under the bubbles will not be stained. If dipping in water still leaves bubbles, they can be removed by blowing across the slide from the edge. The slide is then suspended in the stain and left there for 15 minutes at 35° C. It is then removed and washed by dipping in and out of a beaker of distilled water six times and repeating the process in a fresh beaker of water. The slide can then be placed wet into the red solution, but it is perhaps best to dry it out so that the fibres will be stuck on tightly again in case they have been loosened to any extent by the treatment.

“Staining with the substantive red solution is done as follows:

“A fresh solution is heated to 45° C., and the slide, after moistening and excluding bubbles as before, is suspended in the solution for five minutes at 45° C. and immediately washed in two beakers of distilled water.

“The slide is then dried and a cover glass placed on with a drop of balsam.

“To get the clearest, brightest results, distilled water must be used throughout, and the staining solution must be fresh. The two solutions for ferric ferricyanide will keep well if placed in separate bottles. Equal volumes are mixed together immediately before using. The red solution should be made freshly each time for the best results, as it gets thick and stringy on standing, especially when it is being heated up continually.

“This method of staining will in general give a distinction between pure cellulose fibres and those which contain lignin. Rags, bleached sulphite, soda pulp or any thoroughly bleached materials are stained red, while unbleached sulphite, ground wood, jute, or any lignified materials are stained blue.”

Physical Tests

Machine Direction. Several methods are available for determining the machine direction in a sample of paper. It may sometimes be ascertained by mere inspection of the sheet, as the formation noted on looking through it is often conclusive to the trained observer.

The usual machine wire imparts to the sheet of paper a “wire mark” consisting of a series of diamond-shaped marks, the long diagonal of which points in the machine direction. If the wire mark is sufficiently prominent so that its direction can be determined this will establish the machine direction.

If the paper is well sized and a circular piece is cut out and moistened on one side by floating on water, it will tend to roll up into a cylinder whose axis is in the machine direction of the sheet. If the paper is unsized it will become entirely soaked through on floating on water and will not curl up. This may be avoided by sizing the paper with an alcoholic solution of rosin, or with a solution of gelatine in water, drying and then making the test.

Another method of determining the machine direction is to cut two narrow strips of the paper, one from either direction,

place these one over the other and hold them upright in the fingers. They will droop over of their own weight and if they cling close together the under strip is in the machine direction while if the under strip falls away from the upper the latter is in the machine direction.

The form of the break made by the Mullen tester shows the machine direction, as the longest, or chief, line of rupture is always across the sheet. This is shown in Fig. 43, which illus-

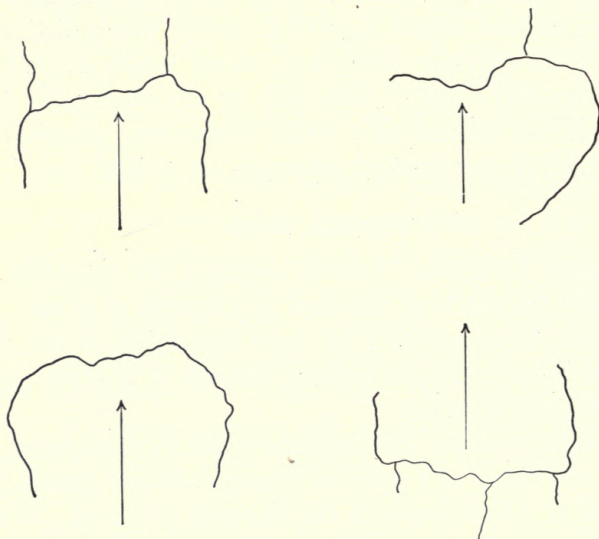

FIG. 43. LINES OF RUPTURE IN MULLEN TEST

trates four typical ruptures and in which the arrows indicate the machine direction.

Wire or Felt Side. In many cases this may be determined very easily by a simple inspection but in some papers the wire marks do not stand out at all plainly. Sometimes they may be made more prominent by plunging the sample for a moment into water and draining or blotting off the excess. The moisture causes the fibres to expand, thus undoing the work of the calenders and restoring the texture of the sheet as it left the machine wire. Inspection of a sheet thus dampened will often

show that the wire marks stand out plainly, where before they were indistinguishable. This method very often proves satisfactory even for coated papers.

Weight of Sample. The weight of a sample of paper is usually expressed as so many pounds per ream of a given size, but the number of sheets per ream and the standard size of the sheet are more or less variable in the different branches of the in-

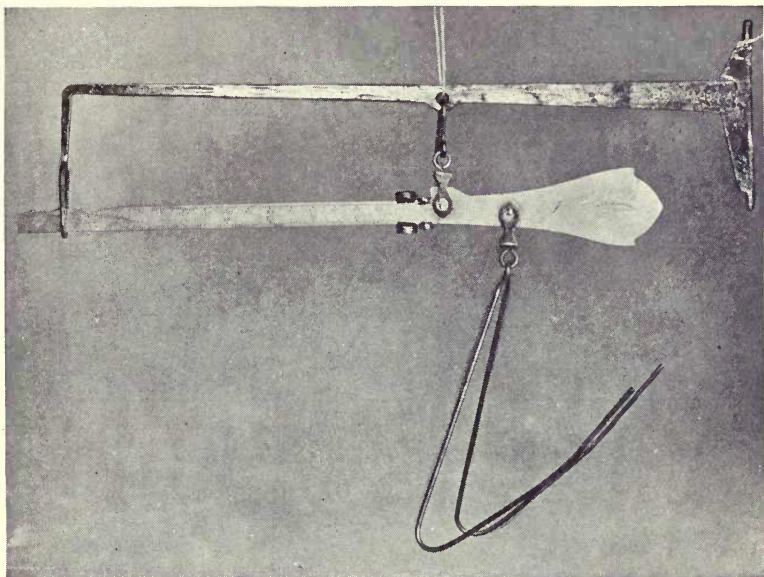

FIG. 44. BEAM TYPE OF PAPER SCALE

dustry. Where a full sheet of paper is available the weight per ream may be conveniently found on scales of the type shown in Fig. 44. The folded sheet is placed on the hooks and the weight per ream is shown by the position of the sliding poise on the beam. This instrument, which is largely used for mill work, is usually graduated for reams of both 480 and 500 sheets.

Two representative scales of the quadrant type are shown in Fig. 45 and Fig. 46. With these the weight per ream in pounds

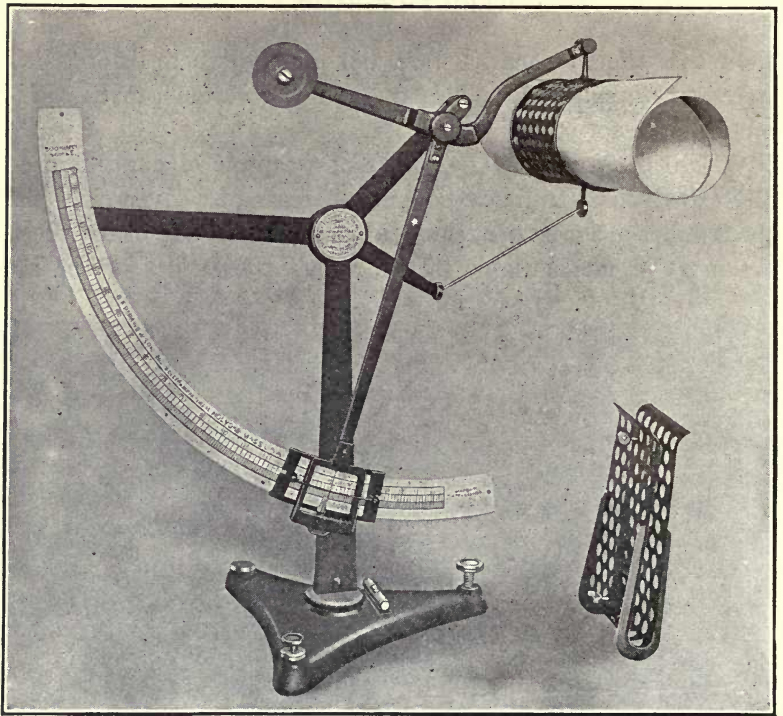

FIG. 45. "QUICK-STOP" PAPER SCALE
Courtesy of B. F. Perkins & Son, Inc.

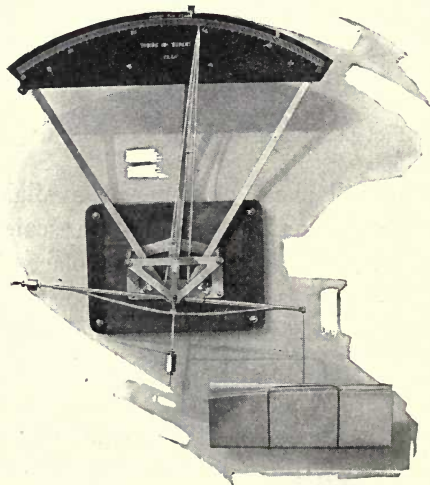

FIG. 46. BASIS-WEIGHT SCALE
Courtesy of Thwing Instrument Company

per 500 sheets is read off directly on the scale and no movement of weights is necessary.

In the case of very small samples a piece of known area should be weighed on a chemical balance and the ream weight calculated by the following formula:

$$\frac{(\text{Wt. in grams}) \times (1.103) \times (\text{area of trade size desired})}{\text{Area of sample in square inches}} \\ = \text{Weight on trade size desired.}$$

Thickness. The thickness of a paper may best be determined by means of a spring micrometer having a hand that

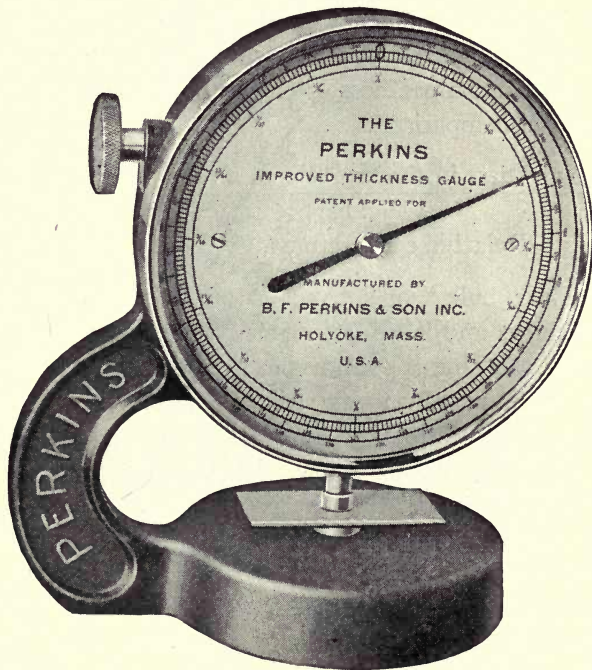

FIG. 47. THICKNESS GAUGE

Courtesy of B. F. Perkins & Son, Inc.

travels around a circular dial which is graduated in thousandths of an inch. One of the many such instruments is shown in

Fig. 47. This type of tester should not be read closer than half a thousandth as this is about their limit of accuracy.

Thickness may also be measured by means of an ordinary micrometer caliper but the amount of pressure is not easily controlled unless it is supplied with a ratchet device which prevents an excessive pressure being applied. This is not so accurate as the spring type but is useful for approximate work around the mill.

It is advisable to have all thickness gauges tested before use. This may be done by securing a set of standard sheet-metal leaf gauges which range from 0.001 to 0.015 in. These should be used occasionally to make sure that the instrument for measuring thickness remains accurate.

It has been suggested by the Committee on Paper Testing that the relative compactness of papers be calculated as follows for purposes of comparison.

$$\frac{\text{Thickness in thousandths of an inch} \times 10,000}{\text{Weight } 25 \times 40,500} = \text{Relative compactness.}$$

Bulk. The "bulk" of a paper is the thickness of a certain number of pages and is a factor which must be taken into consideration in planning a book which must not exceed a definite thickness. It is usually measured by making up a "dummy" or cutting out short strips, piling them up to the required number and measuring its thickness with the ordinary graduated sliding clamp. In using this the pressure used must be specified as heavy, medium, or light and this introduces an element of uncertainty into the results.

The so-called "pressure bulker," Fig. 48, made by B. F. Perkins and Son has been made to eliminate these troubles. In this instrument the "dummy" is put under a definite pressure which is read in pounds per square inch on the dial and the thickness in inches is read on a scale at the side.

Opacity. The opacity or translucency of a paper may be measured by the "Contrast ratio" method using a Martens

photometer in a specially constructed box.¹ This method involves a determination of the difference in photometric brightness, or contrast, between a black and white spot when covered with the material to be tested.

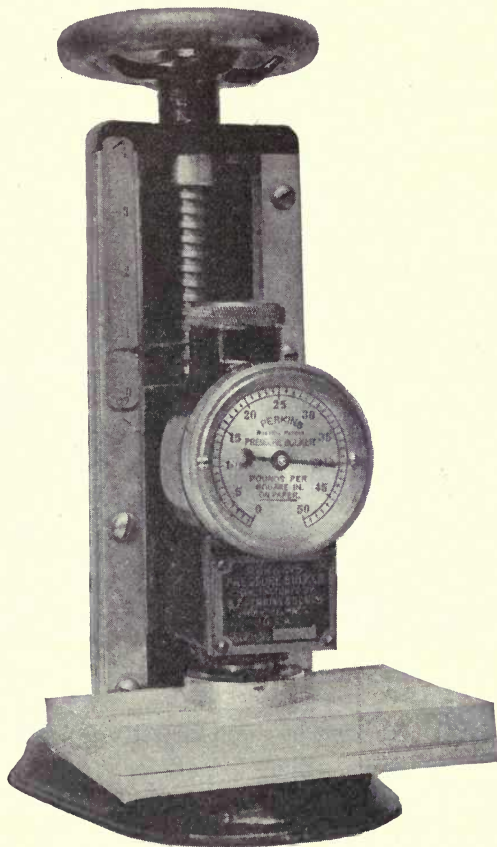

FIG. 48. PRESSURE BULKER

Provided this apparatus is not available, good comparative tests can be made by cutting a small, sharp-edged opening in a piece of cardboard and placing this over a source of intense light. Pieces of the paper are then laid over the opening one

¹ Bureau of Standards Circular No. 63.

at a time and the number of sheets required to completely obliterate the light is noted. By determining the thickness per sheet the absolute thickness of the paper required to obliterate the light can be calculated.

Gloss or Glaze. An instrument to measure the gloss or glaze of paper has been devised by L. R. Ingersoll.¹ It was found that light specularly reflected from paper at an angle of 57.5 degs. was almost completely plane-polarized and working on this basis the instrument was designed to measure the gloss

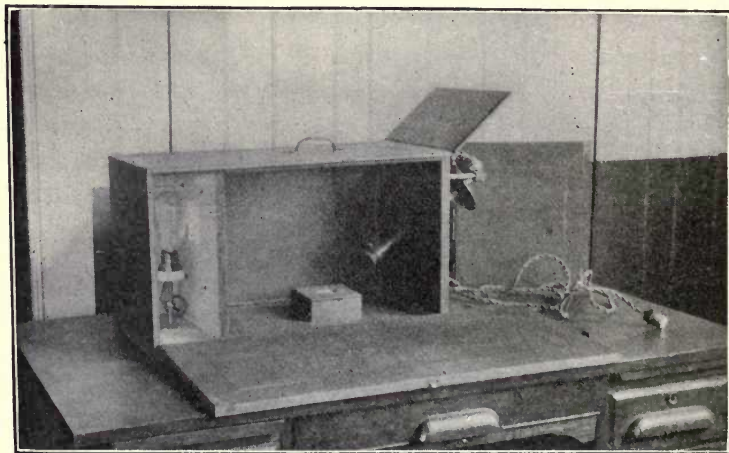

FIG. 49. INGERSOLL GLARIMETER

by determining the fraction of the light reflected from the paper at an angle of 57.5 degs. which is polarized. In using the instrument, light from a tungsten lamp is reflected from the paper through a diaphragm, part of the opening of which is covered with a small Nicol prism and the rest with a piece of smoked glass which absorbs about one-half the light. The beam then passes through the eyepiece which is another Nicol prism mounted to rotate in a divided circle which reads with the aid of the vernier to five minutes of arc. On looking into the eyepiece a divided field is seen and a measurement is made

¹ L. R. Ingersoll: *Electrical World*, 63, 1914, 645.

by turning the divided circle until the dividing line between the two parts of the field disappears. From the average of a number of such measurements the percentage gloss may be found by consulting a table which accompanies the instrument.

Fig. 49 gives a perspective view of the Ingersoll glarimeter.

In using this instrument it must be remembered that the results are comparable only when papers of the same color are considered, since a black paper having the same glossy surface as a white paper would reflect an entirely different per cent of light, due to the absorption of the black color. Since the great majority of papers examined are white, this limitation is not a serious objection.

Tensile Strength. The tensile strength of a paper is determined by the load, in pounds, required to break a strip of it. The tensile strength machine best known in the paper industry is the Schopper tensile machine, illustrated in Fig. 50.

In this device a strip of paper 15 mm. (approximately $\frac{1}{2}$ in.) wide by 180 mm. long (approximately $7\frac{1}{4}$ ins.), is clamped at each end and the clamps are moved apart until the strip is broken. A suitable device indicates the pull in kilograms (approximately 2.2 lbs.) required to break the strip. It is recommended that the load in kilograms per 15 mm. width strip, be converted into pounds per inch of width by the following formula:

$$(3.73) \times (\text{Tensile strength in kg. per 15 mm. width}) \\ = \text{Tensile strength in lbs. per 1 in. width.}$$

A tensile strength factor may be determined by the following formula:

$$\left(\frac{\text{Tensile strength in lbs. per 1 in. width}}{\text{Weight } 25 \times 40,500} \right) \\ = \text{Tensile strength factor.}$$

The usual factor for tensile strength is known as the breaking length. This is the length of a strip which, if suspended at one end, would break of its own weight. The following formula may be used to determine the breaking length of a sample:

$$\frac{(\text{Tensile strength per 1 in. width}) \times (13,889)}{(\text{Weight of a sheet } 25 \times 40,500)}$$

= Breaking length in yards.

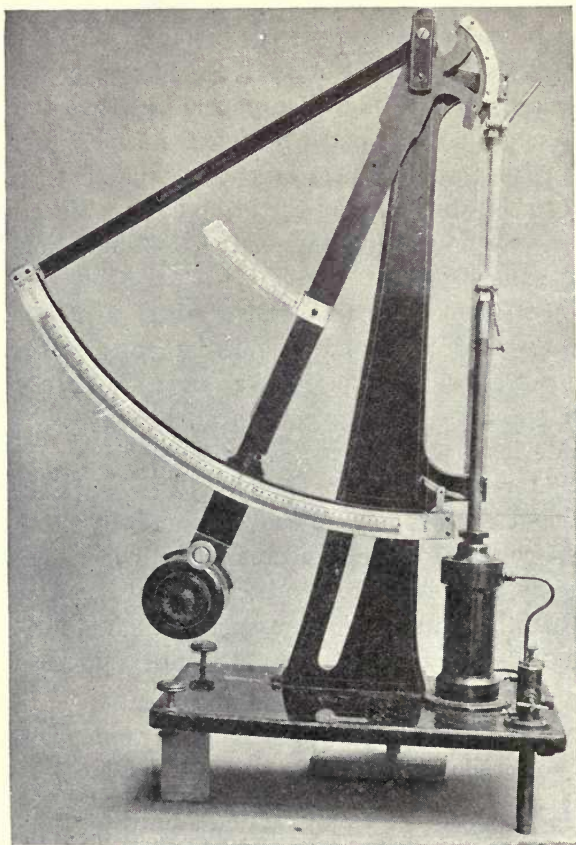

FIG. 50. SCHOPPER TENSILE MACHINE

Stretch. The amount of elongation at the instant of rupture of a strip of paper under tension is measured on the Schopper tensile strength machine. The result is figured as a per cent of the total original length.

Bursting Strength. There are two general types of apparatus used to determine bursting strength. One is of the hydraulic

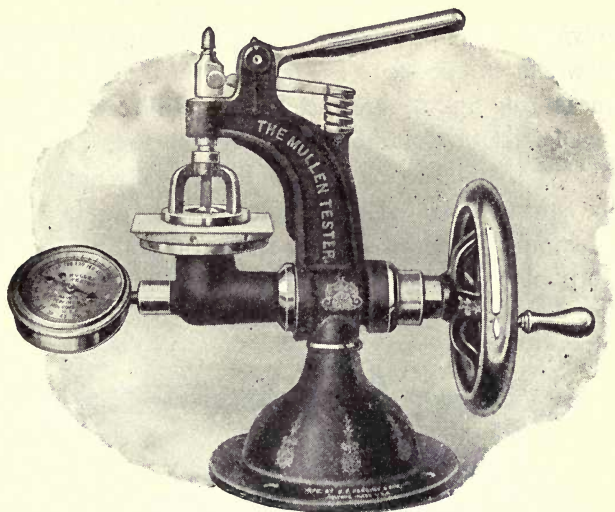

FIG. 51. MULLEN TESTER

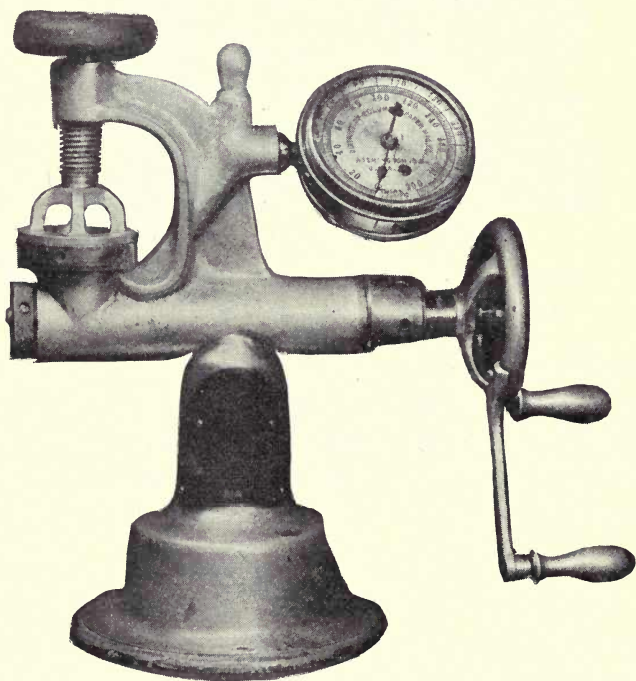

FIG. 52. DISTRICT OF COLUMBIA PAPER TESTER

type, in which the paper is clamped against a rubber diaphragm, through which the pressure is applied to a circular area of the paper measuring one square inch. The Mullen tester, Fig. 51, and the District of Columbia paper tester, Fig. 52, are of the hydraulic type. The second type of bursting strength apparatus is of the spring operated metal plunger design, in which the paper is clamped between annular rings, through which a spring operated plunger is forced. The Ashcroft tester, Fig. 53, is the only one of the above type now on the market.

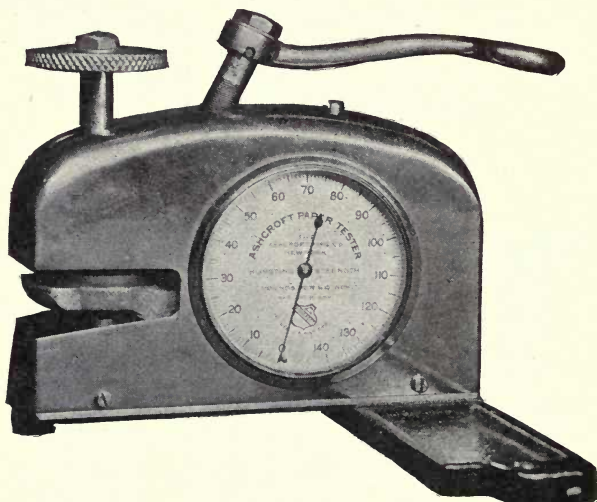

FIG. 53. ASHCROFT TESTER

The bursting strength to be of greatest use must be expressed in terms of the weight of the sample. This ratio of strength to weight may then be directly compared with the strength ratio of any other paper, if the same standard size sheet is used in each case. The strength ratio is expressed as a percentage.

$$\text{Strength ratio} = \frac{\text{Bursting strength} \times 100}{\text{Weight in pounds (on a size } 25 \times 40,500)}$$

Folding Endurance. The folding endurance of a paper is measured by a machine in which a strip of paper is caused to

fold back and forth upon itself until it is worn through. The Schopper Folding Machine, which is the only device so far

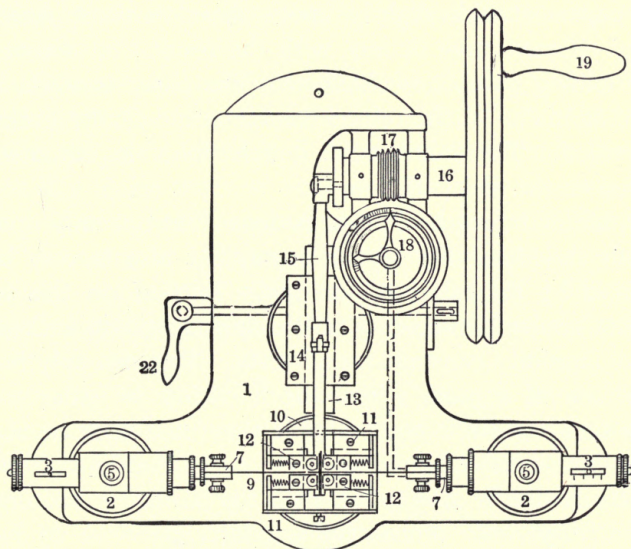
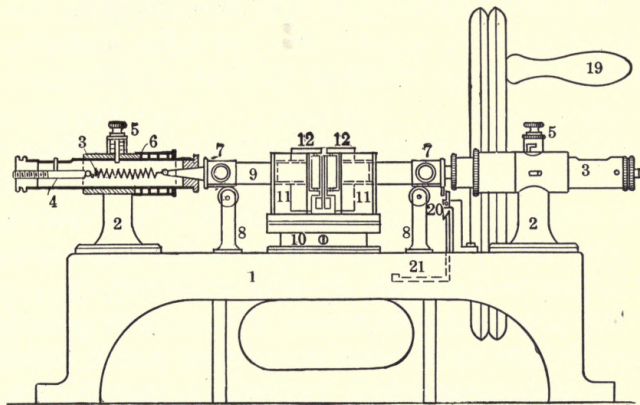

FIG. 54. SCHOPPER FOLDING MACHINE

made to carry out this test, is shown diagrammatically in front view, and from above in Fig. 54.

In making a test the slot cut in the thin metallic plate fastened

to the end of the shaft (13), is brought exactly in line with the jaws (7) and a strip of paper cut accurately, 15 mm. in width and 100 mm. in length, is firmly clamped between the jaws and through the slot. The paper is then put under tension by pulling out the shafts (4) to which the jaws are fastened by an intermediate spring (3). The shaft (13) is given a reciprocating motion by the revolution of the wheel (19), and the paper is folded and refolded over the edges of the slot in the thin metallic plate and around the rollers (12), the revolving of which eliminates friction between the paper and the rollers. Twice in each revolution of the drive wheel (19), the jaws are pulled out to what may be termed the maximum position and the paper is then under a tension of 1000 grams. When the slot in the metallic plate is in line with the jaws the test strip is under the minimum tension of approximately 730 grams. Most papers stretch slightly under these tensions, which are thereby reduced more or less, with the result that a somewhat higher folding number is obtained. The paper is weakened in the crease made by the repeated folding and finally broken by the tension. The number of double folds is automatically recorded on the dial (18).

The folding strength of paper is dependent not only upon the strength and durability of the paper, but also is very largely influenced by the relative humidity. To perform this test in the most accurate manner it is therefore necessary to keep the relative humidity constant for all tests. This can only be done by the use of a room where the humidity is under control. Where such a room is not available then note must be made of the per cent relative humidity of the air at the time of the test. No tests should be attempted when the humidity is either very high or very low. A relative humidity between 65 and 70 per cent is most easily attained throughout the year and is the standard humidity recommended.

The folding factor is determined by the following formula:

$$\frac{\text{Folding endurance}}{(\text{Weight } 25 \times 40,500)} = \text{Folding factor.}$$

The folding factor will vary between about 0.1 and 200.

The standardization of the folding tester and the accuracy of the results obtained have been very carefully investigated by Veitch, Sammet and Reed¹ who consider it valuable for indicating the probable durability of paper and its suitability for specified purposes.

Tearing Test. This method of testing paper is not yet standardized though much interest has recently been shown along this line and several methods have been proposed for determining the tearing strength of paper.

Case² cuts a strip $2\frac{1}{2}$ ins. by 1 in. which is slit lengthwise for a distance of $2\frac{1}{4}$ ins., leaving a distance of $\frac{1}{4}$ in. to be torn. The strip on one side of the slit is fastened in a clamp and to the other strip is suspended a small bucket into which water is allowed to flow until the two strips are torn apart. The weight of the bucket and water in grams is taken as the tearing resistance number.

The Schopper tensile machine was used by Wells³ who removed the weight from the arm and used only the arm and the milled screw with the pawls held out of action. To eliminate the local variation in a single sheet, several samples from the same sheet were torn at once, half being cut across and half with the grain. A speed of tearing of $1\frac{1}{2}$ ins. per minute was used and readings taken every five seconds while making a tear of 3 ins. This method was found to give good check results provided the speed of tearing was constant.

A tearing tester recently devised by Thwing is shown in Fig. 55. A small sample of paper is cut and punched by a special die and attached to two pins one of which is attached to a movable weight on an arm carrying a recording pen while the other is attached to a motor driven, sliding record card holder. This holder is caused to move away from the pin on the weight arm, thus tearing the paper along the line of perforations. The record

¹ Veitch, Sammet and Reed: Paper, 20, 1917, May 30, p. 13.

² Case: J. Ind. Eng. Chem., 11, 1919, 49.

³ Wells: Paper, 23, 750, Feb. 12, 1919.

shows graphically the force in grams required to tear the paper between each two perforations, thus giving five peaks, the average of which is taken as the tearing strength.

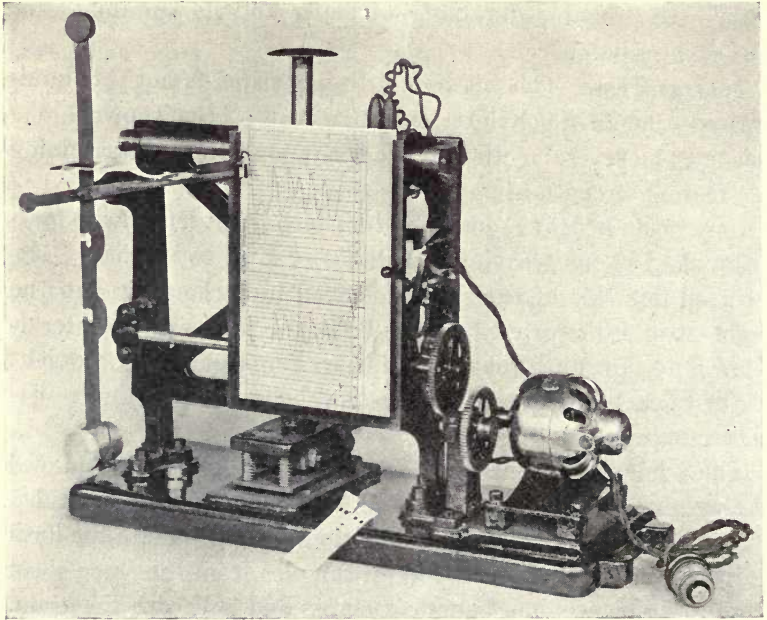

FIG. 55. THWING TEARING TESTER
Courtesy of Thwing Instrument Company

Absorbency. The absorbent power of a paper is generally measured by suspending strips vertically with their lower ends dipping into water and noting the height to which the water rises in ten minutes. The average for several strips cut in both directions should be taken as the figure for absorption.

This method is criticized by Reed¹ because it employs water instead of ink but still more because it is unaffected by the bulk or weight of the paper. He proposes allowing 1 c.c. of a standard ink to fall from a pipette upon the surface of a 4-in. square of the blotting paper which is placed over a tumbler or beaker of

¹ Reed: *J. Ind. Eng. Chem.*, 10, 1918, 44.

such size that the edge of the spot will not touch the glass. The time for the complete absorption of the ink is recorded. In this test attention must be paid to the temperature of the ink, the delivery time of the pipette, the distance of the tip above the surface of the paper, and the amount of liquid used. All of these factors must be standardized if comparable results are to be obtained.

Volumetric Composition. The determination of the volume composition of a paper is at best only an approximation but it is at times desirable to carry it out. The weight of a cubic centimeter of the paper is first ascertained by calculation from the thickness of the sample and the weight of a measured area. The percentage by weight of the various materials present, fibres, clay, size, etc., is then determined in the usual way and from this the weight of each in a cubic centimeter of the paper is calculated. The weight of each substance in grams divided by its specific gravity gives the volume occupied by it, and the sum of all of these volumes subtracted from 1.0 gives the volume of air per cubic centimeter of paper. This method is fairly accurate when only fibres, clay and rosin are present but when other substances are added, as in coated papers, the problem becomes more complex and the results less reliable.

If the volume of air per cubic centimeter of paper is the only information needed it may be obtained by determining the actual specific gravity by weighing in air and then in oil of known density exactly as in making specific gravity determinations in water. It will be found necessary to expose the paper, submerged in oil, to reduced pressure for some time in order to be sure that all air is removed and replaced by oil.

Permeability to Air. No simple and accurate apparatus for measuring this property of paper is available. Herzberg¹ has made measurements by passing air through a definite area of the paper under standardized conditions and measuring the amount passed by a gas meter provided with a special overflow to equalize the level on the two sides of the meter. This method

¹ Herzberg: Mitt. k. Materialprüf., 1915, 33, 142-144.

doubtless gives reliable comparative tests but the apparatus is not of a kind which is generally available.

In the case of waxed or waterproofed papers it has been proposed by Seiter¹ to use the paper as a diaphragm in a dialyzing apparatus, placing ferric chloride above the paper and potassium ferrocyanide below. The time required for the development of Prussian blue is a measure of the porosity of the paper.

Grease-Proof Properties. The surest method of determining whether a paper is grease-proof is to place the sample on a piece of white paper, pour on it a small quantity of oil of turpentine and rub it around with a bit of absorbent cotton. If the white paper becomes stained with the oil the sample is not grease-proof.

A rough test for parchment papers is to heat the sample momentarily over a flame and note the formation of blisters. Pin holes will prevent the formation of blisters while on the other hand the more impervious the surface the more blisters will be formed. This test is not absolutely reliable, as some papers which blister are not grease-proof, while some which do not blister are satisfactory in this respect; it is, however, reliable in the majority of cases.

Degree of Sizing. For book and magazine papers which are ordinarily not sized very hard a sufficiently accurate test may be made by floating a small piece of the paper on a bath of ink and noting the time required for the ink to penetrate to the upper surface. In this test a standard ink should be used and it should be thrown away when used once and not returned to the bottle. The temperature of the ink has a very great influence on the time of penetration and it should be maintained within half a degree throughout the tests. The personal factor of course plays a very important part in this test and to make results strictly comparable they should all be obtained by the same person.

Attempts have been made to eliminate the personal equation by measuring the conductivity of the paper as it is gradually

¹ Seiter: Chemist-Analyst No. 21, April, 1917.

penetrated by an electrolyte. Okell¹ applies the solution of the electrolyte to both sides of the paper in a specially constructed cell which permits of slight but constant pressure on both sides of the sheet. A slightly modified form of this cell has also been employed by Clark and Durgin.² The results obtained are interesting and warrant its use for scientific investigations but the apparatus does not appear well adapted to the rapid work required where a large number of routine tests must be made in the shortest possible time.

For high grade papers, such as surface sized writing papers, the flotation test does not indicate sufficiently well the quality of the sizing. For such papers the method proposed by Sammet³ should be used.

This method involves the drawing of a strip of paper over the surface of an iron tannate ink and allowing it to drain and dry naturally. Upon examination of the surface with a low power microscope, a well sized paper will show no indication of the fibre having absorbed the ink. Any variation in the depth of color on the surface will indicate a lack of uniform sizing. This test may be still further developed by erasing the surface with an ink eraser (a spun glass eraser is most suitable) and again dipping the sheet as before. A paper well sized throughout the sheet will show little or no additional absorption of ink at the erased spot. This test is only comparative but may be valuable to a mill in checking the daily progress.

The ink used for the above test is made as follows:

Tannic acid (dry).....	23.4 grams
Gallic acid (crystals).....	7.7 grams
Ferrous sulphate.....	30.0 grams
Dilute hydrochloric acid (U. S. P.).....	25.0 c.c.
Phenol.....	1.0 gram
Blue Dye (Bavarian Blue S. & J. No. 478).....	2.2 grams
Water to make up to 1000 c.c.; allow to settle, and decant from any sediment.	

NOTE. — Any water-soluble aniline blue, as methylene blue, may be used in place of Bavarian blue.

¹ Okell: Paper, April 11, 1917, 20.

² Clark and Durgin: Paper, 22, 1918, 223.

³ Sammet: Bureau of Chem. Circular No. 107, also Paper, 10, 1913, No. 9, p. 15.

Chemical Tests

Moisture in Paper. In most cases the moisture may be determined easily and accurately by weighing a sample into a weighing bottle with a ground-glass stopper, drying at 100° to 105° C., closing the bottle, cooling in a desiccator and again weighing. The loss in weight represents moisture. In no case where the work demands any degree of accuracy should the weighing of the dried paper be done in the open air because the dry paper absorbs moisture very rapidly from the surrounding atmosphere.

This procedure is inaccurate in some cases where substances are present which lose water of crystallization, or of constitution, at the temperature named. This is particularly true of papers where calcium sulphate is used as a filler or where satin white is used in the coating. In these cases drying at 100° to 105° C. expels three-fourths of the water of crystallization of the calcium sulphate and this loss gives an entirely fictitious value to the hygroscopic moisture. In such cases the only expedient seems to be to dry the samples to constant weight in a desiccator over sulphuric acid.

Ash Determination. A sample of one gram of the paper is ignited in a weighed dish, over a burner, or in a muffle, until all carbon is burned off. The dish is then cooled in a desiccator and weighed; the increase in weight represents ash and by moving the decimal point two places to the right it may be expressed at once as percentage of the paper taken.

If the ash is to be cooled and weighed in the dish the ignition may be made in porcelain, platinum or any material not changed in weight by heating to a bright red heat, but platinum will be found to be the cheapest in the long run because it cools quickly, is practically constant in weight and above all because the ignition is more rapid than in porcelain or silica. Because of the greater speed of combustion a shallow dish is much preferable to a crucible and a still further gain may be made by covering the dish with a curved piece of platinum foil which reflects the

heat downward but allows the entrance of plenty of air. With four such dishes it is easily possible to weigh out twelve samples, ignite, cool, weigh and record the results within an hour.

The sample of paper need not be weighed closer than 0.005 gram except in cases where extreme accuracy is desired and then the sample should be weighed in the bone dry condition in a weighing bottle. Meker burners have been found very satisfactory for ash determinations, being considerably more rapid than the ordinary Bunsen. During burning care must be taken that no ash is blown out of the dish by strong air currents as this is likely to take place especially with the light, fluffy ashes from unloaded or lightly loaded papers. This same danger must be guarded against when removing the covers from the desiccators in which the dishes are cooled. The use of desiccators may be avoided and some time saved by pouring the ignited ash into a counterpoised aluminum pan as soon as the dish is cool enough to avoid danger of loss from convection currents. The ash will cool almost instantly and may be weighed at once.

The ash as finally obtained includes all non-volatile and incombustible matter in the paper. It may come from at least five sources: 1, materials in the pulps employed; 2, the loading or filling materials used; 3, substances used in coating or surface sizing; 4, mineral coloring matters or pigments; and 5, ash due to alum and size. It is possible that a paper may have an ash content as high as 5 per cent without being loaded but if this figure is exceeded it is safe to say some filler has been employed. In this connection it is interesting to note the following percentages of ash in fibrous raw materials as given by Wrede.¹

Stock	Percentage ash
Bleached linen half stuff.....	0.12-1.86
Bleached cotton half stuff.....	0.24-0.79
Unbleached cotton half stuff.....	0.24-1.12
Sulphite, unbleached.....	0.48-1.25
Soda.....	0.36-1.40
Adansonia.....	5.70-7.19
Japanese fibres.....	2.5

¹ Wrede: Paper, Jan. 31, 1912.

In coated papers the ash, of course, includes that from the coating as well as from the body stock. If it is desired to examine each separately the coating may in most cases be removed as described under "amount of coating." The difference between the total ash and that in the body stock gives that present in the coating.

If it is desired to calculate the original amount of filler used, or to make any computations regarding the minerals in the coating it is necessary to determine the nature of the mineral matters and in certain cases the amount of each present. This is rendered necessary because the different minerals lose different percentages of their weights in passing from the air dry to the ignited condition; some of the ground minerals used as fillers lose only about 1 per cent, clay shows a loss of around 12 per cent while crystalline calcium sulphate loses nearly 21 per cent. The complete quantitative analysis of an ash is a rather complicated process which can be carried out successfully only by a skilled chemist. The following simple tests may be of use where a complete chemical analysis is not considered necessary.

Boil a little of the ash with water, filter and to the filtrate, acidified with hydrochloric acid, add a few drops of barium chloride solution. A white precipitate indicates sulphates.

Warm a little of the ash with dilute hydrochloric acid filter and make slightly ammoniacal. Filter off any precipitate, which may have formed and add a little ammonium oxalate solution. A white precipitate indicates calcium.

In order to be conclusive both these tests must be pronounced as small amounts of sulphates may be derived from the sizing materials and a little calcium is almost always present in clay.

Evaporate a small sample of the ash to dryness after having moistened it with hydrochloric acid. Treat the dry residue with a little strong hydrochloric acid, take up a little of the moist material on a loop of platinum wire and hold it in a non-luminous gas flame. Calcium will impart a red color and barium a green color to the flame. If both are present the red color will show as soon as the wire is placed in the flame while the green will show with considerable persistence after the red has disappeared.

Boil the material moistened with strong hydrochloric acid in the above test, with a little water, filter and add a slight excess of dilute ammonia. A whitish, flocculent precipitate indicates alumina from the clay used.

No simple test for magnesia, indicating the presence of talc, asbestine or similar minerals, can be given, as the qualitative test for this element is one which requires more than the ordinary skill.

Retention. By retention is meant that per cent of the entire loading material added to the beater which appears in the finished paper. To ascertain this determine the following facts:

- P = weight of pulp added in pounds
- C = weight of clay added in pounds
- A = per cent of ash in finished paper
- A_p = per cent of ash in pulp
- W_c = per cent of water of composition of clay
- M_p = per cent moisture in pulp
- M_c = per cent moisture in clay.

The per cent of clay used would then be $\frac{100 C}{P}$, or with greater accuracy $\frac{100 C (1 - M_c)}{P (1 - M_p)}$.

The retention may be calculated by the following formulæ, the second being the more accurate.

$$\text{Retention} = \frac{100 A_p}{C (100 - A)}$$

$$\text{Retention} = \frac{100 P (A - K)}{C (100 - A + K)}$$

In this last formula K is the per cent of filler not derived from the loading added; an average value, which may be applied in the above formula, is 0.50.

Sizing Materials. In its broadest sense the term "sizing" is applied to a number of materials used in the beater, in the coating and in surface sizing, and satisfactory qualitative tests

must be able to distinguish between these various substances and also to show whether a paper is tub (surface) sized or not.

Starch may be, and frequently is, used for all three purposes and is applied either raw or cooked in the beater and cooked only in the other two cases. The universal test for starch is to apply a dilute iodine solution to the paper when a blue to violet color will appear if starch is present. It is well to confirm this test by boiling some of the paper with a little water, filtering and testing the filtrate, after cooling, with a few drops of iodine solution. This is necessary because hydrocelluloses, which are only slightly soluble in boiling water, also give a blue color when brought into direct contact with iodine solution. Microscopic examination will show whether the starch granules have been burst by boiling or whether the starch was used without cooking. If the paper to be tested is torn so that it splits on the edge before being moistened with the iodine solution it is generally possible to tell whether it is surface sized or not. If it is surface sized only, the interior of the sheet will remain white while the surface will turn blue; if, however, considerable starch was used in the beater, this is in part cooked and drawn to the surface by the heat of the driers so that the paper has the appearance of being surface sized when in reality it was not. Microscopic examination of the papers after treating with iodine will sometimes enable an opinion to be formed though it is seldom possible to prove positively in such a case whether the paper is surface sized or not.

Casein may be detected in paper by moistening the sample with Millon's reagent and warming gently either over a flame or over an open steam bath. If casein is present a brick-red color will develop. In the case of coated paper in which much satin white is used, the alkali present determines the formation of a yellow color. In this case proof may be obtained by moistening the paper first with dilute nitric acid, to neutralize the alkali, and then applying the Millon's reagent as before; tested in this way satin white coated papers will give the usual red color. Casein may also be detected by boiling the paper with

water and a few drops of ammonia, filtering and adding to the filtrate dilute acetic acid very gradually. Casein will precipitate when the solution becomes very faintly acid, but it may redissolve on adding a considerable excess. This test is also given, though usually less strongly, by rosin, so the precipitate should be tested with Millon's reagent to confirm the presence of casein. Casein is seldom used except in the coating; cases of surface sizing or of its use in the beaters are very rare.

Glue is sometimes used as an adhesive in coating papers and in rare instances in the beaters; the better grades known as gelatines are used in surface sizing. If glue is present alone it may be detected by boiling the sample of paper in water, filtering if necessary, and adding a little dilute tannic acid solution; a grayish, flocculent precipitate indicates glue. Casein is also precipitated by tannic acid and the presence of starch prevents the precipitation of glue so that when either casein or starch is present there is apparently no means of proving the presence or absence of glue.

Rosin is used almost exclusively in the beaters to impart waterproof properties to the paper. There is no single test of a simple nature which will demonstrate positively the presence or absence of rosin and any judgment regarding it must be based on the indications of a number of different tests. If a little ether is dropped onto a sheet of paper and allowed to evaporate there will be formed, in the case of rosin-sized paper, a ring of rosin at the edge of the zone where the ether evaporated. This will be absent in most unsized papers, and it will, of course, be formed in any paper which contains any ether soluble material besides rosin.

Another test is made by boiling a little of the paper for a few minutes in glacial acetic acid and pouring the acid into a little distilled water. A pronounced turbidity indicates rosin, but a slight opalescence may be caused by other soluble substances and must be disregarded.

A third test is that known as the Raspail reaction. If a drop of concentrated sulphuric acid be placed on the paper and a

grain or two of sugar added a pronounced raspberry red color will develop with rosin-sized papers, while with unsized papers the color formed is brownish with only a trace of pink. This red color is also formed when albuminous materials are present so they must first be proved absent before the test can be considered indicative of rosin.

Rosin Determination. The amount of rosin in a sample of paper may be determined most accurately by the ether-alcohol method described by Sammet.¹

“Cut five grams of paper into strips approximately one-half inch wide and fold them into numerous small crosswise folds. Place the folded strips in a Soxhlet extractor and fill with acidulated alcohol diluted to approximately 83 per cent, made by adding to 100 c.c. of 95 per cent alcohol 15 c.c. of acidulated water containing 5 c.c. of glacial acetic acid to 100 c.c. of distilled water. Place the Soxhlet flask directly in the boiling water of a steam bath and extract by siphoning from six to twelve times, according to the nature of the paper. Wash the alcoholic extract of rosin, which may contain foreign materials, into a beaker and evaporate to a few cubic-centimeters on a steam bath. Cool, take up in about 25 c.c. of ether, transfer to a 300-c.c. separatory funnel containing about 150 c.c. of distilled water to which has been added a small quantity of sodium chloride to prevent emulsion, shake thoroughly, and allow to separate. Draw off the water into a second separatory funnel, and repeat the treatment with a fresh 25-c.c. portion of ether. Combine the ether extracts, which contain the rosin and any other ether-soluble material, and wash with 100-c.c. portions of distilled water until the ether layer is perfectly clear and the line between the ether and the water is sharp and distinct. Should glue which is extracted from the paper by alcohol interfere by emulsifying with the ether, it may be readily removed by adding a strong solution of sodium chloride to the combined ether extracts, shaking thoroughly and drawing it off, repeating if necessary, before washing with distilled water. Transfer the washed ether

¹ J. Ind. Eng. Chem., 5, 732, Sept., 1913.

extract to a weighed platinum dish, evaporate to dryness and dry in a water oven at from 98° to 100° C. for exactly one hour, cool, and weigh. This length of time is sufficient to insure complete drying. Prolonged heating causes a continual loss of rosin.

Paraffin Determination. Weigh out enough of the paper to give a weighable amount of paraffin, — one to two grams should be sufficient, — and place the sample in a Soxhlet extraction apparatus, or an Erlenmeyer flask, fitted with a reflux condenser. Cover with gasoline or carbon tetrachloride and extract until the paraffin is all dissolved; if the Erlenmeyer flask is used a second extraction with a fresh amount of solvent will probably be necessary. Evaporate the solution to dryness and weigh the residual paraffin. If there is a tendency for the paraffin to creep over the edge of the dish it may be more satisfactory to weigh the paper after extraction and consider the loss in weight as paraffin.

Either gasoline or carbon tetrachloride is satisfactory from the standpoint of solvent power but the latter is to be preferred because of its non-inflammability. It is also superior to chloroform because its fumes are not likely to produce anesthesia.

Chlorine. As generally spoken of in the mill "chlorine" means free chlorine or more often hypochlorites. These are tested for in the stock in the beater by adding to a small sample of it a few drops of potassium iodide starch solution. If they are present a characteristic blue color will result, its depth being somewhat proportional to the amount of chlorine present.

Where the finished paper is to be examined it is best to moisten it with distilled water on a glass plate and test it with starch iodide paper.

It is sometimes desired to determine the total chlorine present, including that as hypochlorites, inorganic chlorides and organic chlorides. This may be accomplished by moistening a weighed sample of the paper with a solution of chlorine-free sodium carbonate, drying it in a platinum crucible and then igniting cautiously until all the organic material is completely reduced to

carbon. The soluble salts are then leached out and the chlorides in the solution are determined by titration with N/10 silver nitrate solution.

Free Acid Determination. Weigh 10 grams of the paper to be tested, tear into small pieces, place in a porcelain casserole and cover with a small amount of distilled water. Heat gently for an hour over water bath or electric hot plate. Pour off water and wash with small quantities of distilled water; adding same to water extract. Make up to 100 c.c. according to directions given on page 103 of Cohn's Indicators and Test Papers.

The solution is then poured into a 100-c.c. Nessler tube (long form). A similar tube is filled with 100 c.c. of distilled water to which has been added two drops of the litmus solution. To the former is then added tenth normal standard solution of caustic soda until the color matches the sample. The acidity is then expressed in terms of SO_3 .

Sulphur Determination. Sulphur may be present in paper in a number of different forms and from several causes. White papers may be toned with ultramarine, which nearly always contains sulphur, and which evolves hydrogen sulphide in the presence of alum or acid. The use of sodium thiosulphate as an antichlor or the presence of improperly prepared sulphite fibre may also account for the presence of sulphur compounds.

The users of tissue paper for wrapping silver demand that the paper shall be free from sulphur and a method for its determination, based on the stain produced on lead acetate paper, has been worked out as follows:¹

The apparatus consists of a 500-c.c. round bottom flask with a neck about 2 ins. long and 1 in. in diameter. The mouth of this neck is ground to a flat surface and on this is placed a glass tube about 4 ins. long and an inch in diameter, the lower end of which is also ground flat to fit tightly upon the upper surface of the neck of the flask. The whole is so arranged that after placing a piece of filter paper between the two ground surfaces,

¹ Sutermeister: Pulp Paper Mag. Can., 15, 1917, 1021.

the tube and flask can be securely clamped together so that all gas generated in the flask must pass through the filter paper and then up through the superimposed glass tube.

The procedure for the testing of tissue papers is as follows: A sample of 25 sq. ins. is taken and its weight determined. It is then shaken up in a wide mouth glass-stoppered bottle with 10 c.c. of distilled water; when partial disintegration has taken place, another 10 c.c. of water is added and the shaking continued until the paper has been completely reduced to pulp. The larger part of the pulped mass is now transferred to the flask described above, and the residue which is left in the bottle is rinsed into the flask with a mixture of 10 c.c. of sulphur-free phosphoric acid and 20 c.c. of water.

Prepare turnings from the highest grade, pure stick zinc, which must be free from sulphur and arsenic. Treat one gram of these turnings with 10 c.c. of a dilute solution of copper sulphate containing about 0.002 gram actual copper. After a few minutes all the copper will have deposited and the turnings are then thoroughly washed to remove every trace of zinc sulphate.

The turnings are added to the flask and a wad of cotton inserted in its neck. Between the two ground glass surfaces is then clamped a piece of filter paper about 2 ins. square which has been perforated with small pinholes about $\frac{1}{8}$ of an inch apart and which just before use is moistened with several drops of lead acetate solution. Finally a loose wad of cotton is placed in the tube above the paper.

The flask is placed on the steam bath and allowed to stay, with occasional shakings, for an hour. The filter paper is then removed from the neck of the flask and air dried. It is best compared with the standard test pieces by placing them side by side on a piece of white paper and covering them with a thin piece of clear, white glass. The standard test pieces are prepared by using sulphur-free cotton in the flask instead of the disintegrated paper and adding to this definite volumes of a very weak solution of sodium thiosulphate whose strength is accurately known. The sulphur-free cotton is prepared by

boiling absorbent cotton in weak caustic soda solution and washing thoroughly with distilled water.

The sensitiveness of this test is such that the presence of 0.000001 gram of sulphur in the flask will give a distinct color on the lead acetate paper. From tests of a considerable number of papers which have been found satisfactory in actual practice it has been proved that tissue paper is safe for wrapping silverware if it does not contain more than 0.000002 gram of sulphur per 25 sq. ins. of paper (about 0.25 gram).

In using this method certain precautions are necessary if reliable results are to be obtained. The sample to be examined must be kept away from all dust and laboratory fumes and in handling it in preparing the sample the fingers should be scrupulously clean. Any perspiration on the fingers will be sufficient to give an incorrect result and it was found by sad experience that if the fingers were run through the hair while handling the sample for analysis a strong test for sulphur was obtained. It is quite obvious that any sample which is submitted for tests should be taken from a freshly opened package of paper and that it should be handled as little as possible. To make a test of a sample which has been lying around an office for some time and which has been handled repeatedly is merely a waste of time.

The purity of the zinc employed must be ascertained by very careful tests and the same is true of the phosphoric acid. Other acids should not be substituted for phosphoric acid unless they are first proved to be absolutely reliable and it has been demonstrated that sulphuric and hydrochloric acids are not entirely safe.

The standard test papers, which are prepared with known amounts of sulphur, must be freshly made each time the test is carried out since they are not sufficiently permanent even when kept in tightly stoppered bottles in the dark.

Amount of Coating. It is sometimes desirable to determine the percentage of coating on a sample of paper or the amount applied per ream. To do this cut a sample of some definite size and weigh in the air dry state; soak this sample for a few minutes

in a dilute solution of ammonium hydroxide, remove it to a glass plate and loosen the coating by brushing carefully with a flat camel's hair brush moistened with the ammonia solution. Finally wash in running water, air dry, and weigh. The difference in weight represents the coating removed.

In some cases the coating is so thoroughly waterproofed that this treatment fails to remove it; in such cases there is no known method for determining its amount. Where the coating is partly waterproofed it may be desirable to increase the strength of the ammonia or to warm it slightly. Where the coating is not easily removed the brushing must be done with great care lest a considerable loss in weight be caused by removal of fibrous material. It is sometimes a question of judgment as to whether a greater error is caused by failure to remove traces of coating or by rubbing off some of the fibres.

Glue or Casein Determination. There is apparently no quantitative method known for the determination of these substances when they are present together. Both materials contain nitrogen. If only one be present and the nitrogen content of the original material as added to the paper be known then by means of the nitrogen determination the content of glue or casein may be estimated.

For the determination of nitrogen weigh out from three to five grams of the paper, cut into small pieces and place in a Kjeldahl digestion flask. Add 10 grams potassium sulphate, 0.7 gram mercury and 25 c.c. of concentrated sulphuric acid; place the flask in an inclined position in a hood with a good draft and heat below the boiling point of the acid until frothing has ceased. Increase the heat until the acid boils briskly and continue the digestion until the solution is colorless or pale straw yellow. Allow the contents of the flask to cool and add 30 c.c. of a 4 per cent solution of potassium sulphide. Next add 50 c.c. of caustic soda solution (saturated solution), or enough to make the reaction strongly alkaline, pouring it carefully down the side of the flask so that it does not mix with the contents. Connect the flask at once with the condenser, shake to mix the contents of the flask,

and distil until all ammonia has passed over. Collect the distillate in a flask containing a known volume of standard acid, and at the end of the test titrate the excess of acid with standard alkali, using sodium alizarin sulphonate or methyl red as indicator. The end of the condenser tube should dip below the surface of the acid, the distillation should require about 45 mins. and the distillate should amount to about 200 c.c. If a few pieces of granulated zinc or pumice stone are added to the distillation flask bumping during the distillation may be avoided.

As a check on the purity of the reagents a "blank test" should be made using the same amounts of chemicals as in the regular test but adding no paper.

Subtract the volume of alkali required to neutralize the distillate from the volume required by the blank; the difference is the number of cubic centimeters of standard alkali equivalent to the ammonia. This number of cubic centimeters of tenth normal alkali multiplied by 0.0014 gives the grams of nitrogen in the sample taken. To convert this to casein multiply by the factor 6.3, and for glue use the factor 5.6. Since the percentage of nitrogen varies in different lots of casein and glue these factors should be determined, wherever possible, on the actual materials used in the paper being tested.

Unbleached Fibres. Besides the microscopical method described elsewhere it is possible to detect unbleached sulphite fibre by chemical means. If a sheet of paper containing a small amount of unbleached fibre is moistened with Millon's reagent and then warmed in the steam escaping from a steam bath it will be found that the unbleached fibres will show up very distinctly as brownish hairs. If no unbleached fiber is present the brown hairs are absent. From the proportion of fibres stained brown it is possible to make an approximate estimate of the amount of unbleached fibre present, provided its quantity is not large. Where the sheet is mostly unbleached, or where groundwood is present in considerable amount, the entire surface becomes brown and no estimate of the proportion of unbleached fibre can be made.

Groundwood Pulp. For the qualitative determination of groundwood a number of stains are available and find quite general application.

Aniline sulphate stains groundwood a yellow color, though the test is not quite so sensitive as that with phloroglucinol. The aniline sulphate solution should be prepared by dissolving 5 grams in 50 c.c. of distilled water and acidulating with one drop of concentrated sulphuric acid.

A very satisfactory stain is made by dissolving 1.0 gram of paranitroaniline in 405 c.c. of distilled water and 30.5 c.c. of sulphuric acid (sp. gr. 1.84). With groundwood this gives an intense orange color which develops without drying the sample. This stain possesses an advantage over phloroglucinol in that the acid is not volatile and that it does not deteriorate so rapidly.

One of the most generally used stains is prepared by dissolving 5 grams of phloroglucinol in a mixture of 125 c.c. of distilled water and 125 c.c. of concentrated hydrochloric acid. This solution should be kept in the dark as light affects its staining properties to some extent. With groundwood this stain causes a magenta color, the depth of which is approximately proportional to the amount of groundwood present. A very light shade, however, does not necessarily prove the presence of groundwood, as partly cooked jute, undercooked unbleached sulphite and some other fibres are also slightly colored.

The reaction with phloroglucinol has been employed by Cross, Bevan, and Briggs¹ as the basis of a quantitative method for estimating groundwood. The necessary solutions are:

1. 2.5 grams of pure phloroglucinol dissolved in 500 c.c. of hydrochloric acid, sp. gr. 1.06.
2. 1 c.c. of 40 per cent formaldehyde in 500 c.c. of hydrochloric acid, sp. gr. 1.06.

The paper under examination should be rasped to a loose powder but size need not usually be extracted. Two grams of the powdered sample are dried at 100° C., weighed, transferred to a dry flask and covered at once with 40 c.c. of phloroglucinol solu-

¹ Cross, Bevan and Briggs: *Papier Ztg.*, **32**, 1907, 4113 and 4479.

tion. The flask is stoppered, shaken, and allowed to stand several hours or best over night. The solution is next filtered through a very little cotton placed in a funnel and 10 c.c. are measured out for titration. This is diluted with 20 c.c. of hydrochloric acid (sp. gr. 1.06), warmed to about 70° C. and the formaldehyde solution added from a burette in lots of 1 c.c. at a time. Allow to stand two minutes after each addition and then remove a drop without filtering and place it on a strip of partly sized news paper. After ten seconds shake the drop off and see if a red color is produced; if it is, add more formaldehyde solution and toward the end of the reaction reduce the amount added each time to 0.25 c.c. Non-development of a red color indicates the end of the reaction. The test paper is sensitive to a solution of one part of phloroglucinol in 30,000.

A control test should be made with 10 c.c. of the phloroglucinol solution in exactly the same way and the absorption of the groundwood calculated from the difference of the two titrations. It should be based on the dry material taken for analysis.

In carrying out this test it is essential that pure phloroglucinol be used and it is well to obtain a considerable supply so that its uniformity may be assured. The proportion of sample to phloroglucinol solution must be kept constant and the temperature must be maintained at 70° C. during the titration.

The absorption numbers of various fibres have been found to be as follows:

	Per cent
Groundwood.....	7.87-8.15
Groundwood, brown.....	5.52
Sulphite, bleached.....	0.90-1.00
Sulphite, unbleached.....	0.90-1.03
Esparto.....	0.50
Cotton.....	0.20

Assuming an absorption number of 8 per cent for groundwood and 1 per cent for sulphite then

$$H = \frac{100(P - 1.0)}{8.0 - 1.0},$$

where H = per cent of groundwood

P = absorption value of dry ash-free fibre in sample.

CHAPTER XVI

PRINTING

In spite of its title this chapter is not a dissertation on the art of printing but is rather a collection of facts, intended to throw a little light on the relation of the paper maker, the printer and the ink maker. It is frequently the case that no one of the three fully understands the troubles of the others and this lack of knowledge prevents the coöperation which is necessary if the greatest progress is to be made. Fortunately it is becoming more frequent to find mutual assistance taking the place of unjustified criticism and it is this spirit of helpfulness which has enabled many of the following notes to be collected. Necessarily they relate chiefly to the use of book and coated papers, since it is upon these papers that by far the greatest amount of fine printing is done.

Printing may be defined as "the reproduction of designs, characters, etc., on an impressible surface by means of an ink or a pigment (generally oily), applied to the solid surface on which they are engraved or otherwise formed."¹ The only "impressible surface" which need be considered here is the paper. According to the method of preparation of the "solid surface" the various printing processes may be classed under three headings: (1) relief; (2) intaglio; and (3) planographic. The relief processes are those in which the printing surface stands up above the surrounding ground; of this group the half-tone is the most important representative. Intaglio engravings are those in which the design to be printed lies below the surrounding surface of the plate; the depressed lines or dots hold the ink which is trans-

¹ Century Dictionary.

ferred to the paper after the surface of the plate has been wiped clean. The old-fashioned steel-engraving is typical of the intaglio process. Planographic processes are those in which the printing is from a flat surface, neither raised above, nor depressed below, the surrounding ground. Lithography with its flat stone or metal plate is typical of planographic processes.

Half-Tone Plates. For the preparation of half-tones a "screen" is necessary. This is prepared by coating a sheet of glass with a wax composition and then ruling diagonally upon it fine parallel lines at exactly equal distances from each other. The plate is then treated with hydrofluoric acid, which etches the glass wherever the diamond point has removed the wax, and after cleaning the plate an opaque, dark pigment is rubbed into the lines. Two such plates are sealed together face to face, with the rulings at right angles, to form the finished screen. The distance between the lines varies from 50 per inch for very coarse work to 300 for the finest.

What is termed a screen negative is prepared by placing this screen in a camera, in front of and near the plate, but not in direct contact with it, and then photographing, through the screen, the picture, drawing or photograph to be reproduced. The lines prevent the passage of light, and the resulting negative consists of innumerable dots separated by the unexposed spaces which were covered by the lines.

The metal plate which is to form the half-tone block is carefully planished, sensitized with a mixture of gelatine and bichromate of potash, dried, and exposed under the screen negative just as in ordinary photographic printing. Copper is used for the best plates while zinc is employed in cheaper work. The exposed plate is then washed in water which dissolves the gelatine film wherever it has not been exposed to light. This gelatine picture is heated and burnt onto the metal like an enamel which protects the metal at these points during the next step which is etching. This is done by treating the plate with ferric chloride solution which dissolves away the copper where it is not protected by the enamel, thus leaving the picture in relief. In order to produce

the best results the plate must be re-etched locally and it is in this operation that skill and judgment are most necessary on the part of the plate maker. The following table shows the standard depths for half-tone plates in thousandths of an inch.

Tone values	55-line zinc	85-line zinc	100-line zinc	100-line copper	120-line copper	133-line copper	150-line copper	175-line copper
High lights.....	8	4.6	3.2	2.6	2.5	2.3	2.2	1.8
Middle tones.....	5	3.1	2.2	1.8	1.7	1.6	1.4	1.0
Shadows.....	3	2.2	1.4	1.0	0.9	0.9	0.9	0.6

Original plates are seldom used where any large number of impressions are to be made as they soon wear out, necessitating the making of entirely new plates; the use of electrotypes obviates this difficulty. These are prepared by coating the original with a thin film of the finest graphite and then taking an impression of its surface in wax or gutta-percha. The graphite prevents sticking and allows the plate to be removed from the wax, which is then placed in a bath of copper sulphate and coated electrolytically with a film of copper. Deposit of copper may be continued until it becomes thick enough to use as a plate or a thinner film may be backed up by type metal. This process allows any number of electrotypes to be prepared from the same original, which insures a sufficient supply of plates for even the largest editions. Where excessive wear is expected they are sometimes faced with steel or nickel by electrolytic means.

For three color work three half-tone blocks have to be prepared, one for yellow, one for red, and one for blue. Three separate photographs are taken through ray filters; the first of these absorbs all rays except those coming from yellow portions of the picture, the second does the same for red and the third for blue. From these three photographs three half-tone blocks are made in the usual way except that the screen is turned at a slight angle so that when the plates are printed one over the other the dots will not fall exactly in the same place but will form little patches of color side by side.

Lithography. The stones used for lithography are certain porous limestones which possess the property of absorbing either water or grease but which will not take up a greasy ink wherever they have been moistened. The surface of the stone is prepared by grinding it with emery or sand, using a small stone or a cast iron levigator moved in circles all over the surface, until it is perfectly flat. The next operation is polishing with pumice stone to remove sand scratches and this is then followed by a final polishing with a "snake-stone." This completes the preparation of the stone for some kinds of work but for others the surface has to be grained. This is accomplished by hand by going over it with graining sand and a muller or mechanically by sprinkling it with sand and rolling it with glass balls.

The design may be placed upon the stone in two ways; it may be drawn on the surface directly by a pen or a brush or by means of a greasy crayon, known as "chalk"; or it may be transferred to the stone from a design prepared upon suitable transfer paper. When the drawing is made directly upon the stone it has to be in reverse so that the final print may be in the proper position. The next operation is a treatment with a gum arabic solution, followed, after drying and washing, by rolling up with ink. Corrections are made by a scraper and dirt is removed by acid and the stone is etched by dilute nitric acid, which acts only on those portions which are not protected by ink. After etching the stone is again inked, gummed and set aside to dry; when wanted for printing the gum is washed off and the surface of the stone allowed to become saturated with water.

The principles of lithography, as very briefly outlined, are also applied to modified processes such as printing from plates of zinc and aluminum and also in the more recent offset process.

Paper for Different Types of Printing. The kind of paper which should be used on any job depends on a number of factors which include the kind of work being produced, the skill of the printer, the artistic education of the customer and finally the price which he is willing to pay. It is frequently the case that the quality of the paper is determined by the illustrations which it

is necessary to use since type matter can be printed successfully on any paper.

Half-tones prepared from very coarse screens may be used on even such poor paper as news print but the results obtained can hardly be called artistic, though they serve their purpose. As the paper becomes better and its surface smoother the screen may be correspondingly finer. It is difficult to establish definite limits for the screen which may be used successfully with any class of papers since papers of the same class vary considerably in finish from time to time and according to the mill in which they are made. Considering book papers, upon which most of the fine printing is done, the following may be taken as approximately the limit of fineness for the screen which may be used with good success.

	Lines
Machine finish book.....	120
Super and English finish.....	133
Imitation coated.....	150
Dull and semi-dull coated.....	133
High finish coated.....	175

For the best results in printing half-tones, the surface of the paper must be such that every dot is perfect. If the paper is rough many of the dots will fall upon the elevated portions, where they will print, but enough will come over depressions, where they will not touch the paper, to give a decidedly gray and irregular print. The avoidance of such irregularities is the chief argument for the use of coated papers.

The rotogravure process uses a copper cylinder on which the illustration is printed from a positive prepared without the use of a screen. The etching is similar to that of the half-tone plate but is entirely mechanical. After inking the excess is removed from the surface by a doctor which leaves the depressions filled with ink. The paper is then pressed into these inked portions by means of a rubber roller. This process possesses the advantage that papers of the poorest quality give very beautiful results; even very low grade news print can be depended on to give illustrations with remarkable depth of tone.

For lithographic work the paper should lie flat in order to avoid wrinkles during printing. The filler used in plain paper must be free from gritty particles as these cause etching of the stones or plates. Where coated paper is employed, the adhesive used in the coating must be such as to give it waterproof properties, or rather insolubility, so that the dampness will not cause the coating to come off. If the printing is from zinc or aluminum plates the paper must be free from any chemicals which might dissolve and cause etching of the plates.

Paper used for offset printing is generally of an antique finish though coated paper can also be used. This process was made possible by the use of metal plates. It uses less ink than the ordinary lithographic process and causes less wear on the plates as the latter do not come in contact with the paper but only with a rubber blanket which is used to transfer the ink from the plates to the paper. Paper for this process must be well sized and have a firm, hard surface, free from fuzz. If the paper is unsized, the damp blanket tends to remove fibres and dust which are transferred to the plates and cause fill-up troubles and dirty prints. Freedom from wire and felt marks and a neutral reaction are desirable properties, and the sheets must be perfectly flat so that wrinkles may not form in passing through the press. Stretching of the sheet under pressure must also be avoided as much as possible as it also causes wrinkles to form.

Choice of Inks. The selection of a proper ink for the paper which is to be used is generally the key to success in that particular job. There are comparatively few general rules to follow and it is largely a question of skill and experience on the part of the printer. Even if he uses good judgment in the choice of an ink type, his results may turn out poor, for he is almost entirely at the mercy of the ink maker who may use inferior raw materials with little fear of detection. Ink is a very complex mixture which it is practically impossible to analyze with any degree of accuracy or completeness; moreover the figures which can be obtained are not easy of interpretation. For these reasons it is good policy to obtain inks from reliable

manufacturers who are known to turn out good products and who are building up or maintaining good reputations.

Inks are composed chiefly of pigments and oily carriers or vehicles. These range from high grade varnishes in the inks for engravings down to low grade oils for the cheap inks used for news print. To these ingredients are added numerous other materials such as driers, softeners, oil soluble colors, etc., each of which imparts certain properties to the ink and makes it suitable for some particular kind of work. The ink for printing newspapers, for example, must dry by penetration and not by oxidation, because the rapidity with which the paper is handled allows no time for oxidation to take place. At the other extreme is the ink for engravings, such as letter heads, etc., in which a very stiff varnish is used so that the ink will stand up above the surface of the paper and dry entirely by oxidation. Between these two limits there are all kinds of inks made up for all kinds of printing; opaque inks for colored papers so that the color of the paper will not show through; transparent colored inks for process work; double tone inks; those which dry glossy and those which dry with a dull finish, and many others for special purposes.

Defects. It has been stated by one who has had much experience in both the paper and the printing industries, that fully 70 per cent of the criticisms against paper are due to troubles caused by inferior or inappropriate inks. In addition to the selection of an unsatisfactory ink, there are the troubles caused by the printer who finds his work defective in some way and attempts to improve it by the addition of some material to his ink. While the "dope" used may cure the trouble, it is, at the same time, likely to cause defects in some other, and totally unexpected, quarter. The modification of inks is something which should be done by, or under the direction of, a man who has had years of experience and even under those conditions it is apt to do more harm than good.

There are, of course, many defects which may be present in the paper and which may cause the printer serious trouble.

Some of these are so obvious that they hardly need mentioning. Among these would be classed fuzz on the surface, and trimming dust from the edges; these cause the filling up of cuts and type and may give the appearance of picking in half-tone illustrations or heavy blacks. Such defects make it necessary to wash up frequently if good work is to be turned out and in the case of coated papers often lead to their rejection as weak coated when in reality the coating was amply strong. Not all cases of fuzz, however, can be laid entirely to the paper criticized, as an examination of the fuzz collected from the press usually shows the presence of some wool and silk fibres and sometimes it is found to be composed largely of fibres which were not used in that particular paper. Curling, wavy edges or a cockly surface are also very readily detected in paper though not always so easily cured. They may be caused by too prolonged beating, unsatisfactory drying on the machine, defects in the calenders, or variations in the humidity of the surrounding air. In the last case the paper usually becomes flat again if it is stored in thin layers for a sufficient length of time for it to come to equilibrium with its surroundings.

Lumps in paper are a fruitful source of complaint and are often, though not always, justly blamed on the paper. If large or thick they may seriously injure the plates or even ruin them, necessitating the preparation of new ones. Lumps may be caused by any number of things; if they are an integral part of the paper, they are frequently from the growth of slime in the pipes or chests, or from strings of fibre which collect on the screen plates and finally drop off, or from rolls of stock which break away from some doctor on the presses or driers. These are the fault of the paper and nothing else, but there is another class, the blame for which cannot be so definitely placed. This includes lumps which have become fastened to, or pressed into, the surface of the paper after the latter has been completely dried. Here there is always the possibility that they came from something in the press-room just as well as from a defect in the paper mill. Among the complaints on record, are those

relating to lumps composed entirely of fibres and printing ink; here the fibres might have been contributed by the paper, but the ink must have come from the press-room. In another case, lumps of starchy material resembling cake were complained of; some boy may have thrown part of his lunch at a fellow workman, but it might just as well have been in the press-room as in the paper mill. In the case where the complainant stated that lumps of metal were present in the paper and on examination they were found to have the appearance and chemical composition of electrotype metal it was reasonable to exonerate the paper mill.

Complaint is often made that the ink strikes through the paper and causes staining on the other side. With very fluid inks of the double-tone type it is possible to make them strike through, but it can be done only by using an excessive amount, far more than would ever be used even on the heaviest cuts. It has been stated by one ink manufacturer that with paper as heavy as $25 \times 38 - 70$, the ink is not made which will strike through. In nearly all such complaints the trouble can be proved to be offset provided enough of the printed sheets are submitted. In some the offset will coincide so exactly with the print that it might easily be taken for soaking through, but in others it will be found to be displaced uniformly to one side of the cut, indicating that it did not strike through but that it is an offset from the sheet below upon which the sheet in question did not fall exactly true. At times the fact that it is an offset can be proved by finding traces of the pigment portion of the ink upon the stained paper. Even though the oily part might strike through, it is hardly conceivable that the solid pigment could be made to do so. Tearing the paper so that it will split and expose the inner part of the sheet will prove that the pigment has not penetrated far into the paper and in most instances will show that the stain is wholly upon the surface.

Offsetting is a well-known phenomenon and is avoided in the press-room by slip-sheeting. There are certain well-recog-

nized types of work in which slip-sheeting is necessary and others in which it is not required, and so long as papers fall in their proper classes, offsetting cannot be considered a defect either of the paper or the ink. There are occasional abnormal cases, however, in which either the paper, or the ink, or both, may be to blame. If the paper is finished and packed very dry, handling it may cause so much electrification that the sheets will cling to each other as they are piled up after printing. This close contact tends to increase offsetting. Electric neutralizers are a great help in eliminating electricity from the paper, while the gas flame arrangement attached to the press in such a manner that the printed sheet passes over it has a tendency to prevent offset. Both these devices are in general use in the large printing plants.

Excessive atmospheric humidity, which greatly delays the drying of the ink, is also a cause which contributes toward offsetting. The use of slow drying inks and the employment of papers which are so hard sized with animal sizing that the ink does not readily penetrate both tend to increase the trouble, while greater porosity of the paper decreases it. In general it may be said that the majority of coated papers will offset seriously if not slip-sheeted, while with machine finish and antique papers such precautions are seldom necessary.

The drying of the ink is sometimes so slow that complaint is made regarding the quality of the paper. The only qualities in the paper which are known to retard drying are lack of porosity, and in the case of coated paper too much of certain oils or waxes in the coating. On the other hand, atmospheric conditions may hinder drying or the composition of the ink may be at fault; it is a well-known fact that the drying of an ink can be very greatly changed in either direction by the proper adjustment of the ingredients. Poor drying sometimes results during color work because of the so-called "crystallizing" of the yellow which is printed first. This trouble occurs because the yellow dries in such a way as to prevent the penetration of the other colors which consequently remain on the surface and dry

very slowly. This defect in the ink can be easily corrected if it is discovered before the job is completed, yet this is not always done and then the paper gets the blame unjustly. Not only is this true, but at times the printer complains to both the paper maker and the ink manufacturer in order to make sure of a rebate from one or perhaps both sources.

Picking is a defect of coated paper caused by a deficiency of adhesive in the coating. This weakens the adhesion of the mineral matter in the coating to the body stock to such an extent that it is overcome by the ink and the coating is removed in places causing white spots in the print and also fouling the plates or type. As already noted, some complaints of picking are due to dirt which collects on the plates and prevents the ink from coming in contact with the paper; these are easily distinguished from true picks by examination under a strong lens or a microscope, as they show that the coating is intact and not ruptured as it is when picking has taken place. Picking is usually the fault of the paper maker though this is not always true. If too tacky an ink is used any paper can be made to pick, no matter how strongly the coating may be sized. The selection of an ink of the proper consistency, or the adjustment of its consistency to suit the paper, is therefore of very great importance in using coated paper. The temperature of the press-room and the ink also influence the results very greatly. Most inks are ground in No. 1 varnish and will work properly at 70° F. At this temperature No. 1 varnish has as much tack as No. 0 varnish at 60° F., No. 2 varnish at 80° F. or No. 3 varnish at 90° F. The colder the ink the more tacky it becomes, hence picking is more frequent on Monday mornings when starting work. Defects from this cause should not be blamed on the paper since the trouble disappears when normal conditions are once more established.

A result somewhat similar to the picking on coated paper is found very rarely in plain papers. This is caused by dry froth from the wet end of the paper machine which gets onto the surface of the paper as it is being formed but does not become

thoroughly incorporated with it. On drying and calendering these bits of froth are smoothed down so that they do not show except on very careful inspection, yet they do not adhere very firmly to the sheet and are readily removed by the inked plate causing a white spot closely resembling those where coated paper has picked.

In lithograph work it is claimed that the paper sometimes causes the ink to smut or to show slightly where there should be white surfaces only. This is said to be due to chemicals in the paper which act on the stones or metal plates and cause them to take a little ink where there should be none. For this reason it is well to avoid the presence of water-soluble substances which can in any way affect the plates. In some cases, however, this smutting is not the fault of the paper but of the ink which may be made of dyes or lakes which are partly soluble in water and are therefore taken up as very light tints by that portion of the stone which has been moistened. This is particularly likely to happen with inks in which eosine or similar dyes have been used. To prove the presence of such water-soluble colors in the ink, a piece of the printed sheet may be placed between sheets of moist, white blotting paper and pressed for some time in a copying press. If water-soluble dyes were used, a distinct offset will be present on the blotter.

Another defect of coated paper which is not strictly one of printing, but is closely allied to it, is that of brittleness or poor folding qualities. This can be avoided to a considerable extent by the proper selection and beating of the fibres for the body stock and by the use of as little coating as is consistent with obtaining the proper printing surface. Much can be done to avoid the cracking of the surface by the careful handling of the sheets in the folding and stitching machines. Where possible the fold should be made with the grain of the paper and operations should be conducted in as damp an atmosphere as possible since the damper the paper the less it will crack on folding.

Grayness of the cut or filling-up of the half-tone screen are things which are occasionally blamed to the paper. The gray-

ness of an illustration is almost entirely a question of ink selection or adjustment; it may be possible to overcome it by using more ink, provided too much is not used, or perhaps another ink can be substituted. In case the ink needs to be reduced a black ink of the desired consistency should be used rather than a varnish, for the latter may diminish the covering power of the pigment to such an extent that the cut will appear gray. Reduction with a liquid is also more likely to result in filling up the plates, which necessitates frequent clean ups. Grayness may also be caused by too porous a coating which absorbs too much of the ink and leaves so little on the surface that it is not well covered. The froth pits which are sometimes present in poorly coated paper may, if present in too great numbers, cause gray prints either locally or throughout the cut. These pits are caused by small bubbles which keep the coating away from the spot which they occupy and when they finally break leave a depression or pit in the coated surface. These are so much lower than the general surface that the ink is not forced into all of them and the result is a white spot where there should be a half-tone dot of ink.

Filling up of the half-tone plates results in a muddy cut in which detail is lacking. This is most frequently the result of improper selection of ink and can often be corrected by substituting a different quality. Occasionally the paper may be at fault if its surface is at all inclined to be dusty or to allow very minute fragments to break away and become mixed with the ink.

In some cases an ink is supposed to dry with a dull, lustreless surface instead of the usual gloss; such inks are largely used on the dull and semi-dull finish papers. When using such inks it is sometimes observed that the completed print has a mottled effect, part of the surface being dull, while the rest is shiny. This shiny part is generally distributed quite regularly in patches of moderately uniform size, the edges of which gradually shade off from the glossy to the dull surface. This mottled effect is due to the fact that part of the sheet is

less absorbent than the rest and in these less absorbent spots the ink is obliged to stay upon the surface and dry like a varnish. The exact reason for this trouble has not been fully determined, but it probably goes back to irregular formation on the paper machine. If the fibres are more or less bunched up they will give a surface with hills and hollows; this may be reduced to a plane surface by calendering but the density of the sheet must vary according to the amount of compression it has undergone and its ability to absorb ink will vary correspondingly. Where coating is applied to a "wild" sheet it tends to be thicker in the hollows than on the elevations and when it is calendered there is again a considerable variation in density and porosity. It is quite probable that local variations in the sizing of the sheet are caused by the weave of the drier felt exerting more or less pressure on the sheet as it is dried. When such a sheet is coated the adhesive is absorbed more completely by the slack-sized spots and is held upon the surface where it is harder sized. When it is calendered it appears to have a uniform finish, but wherever the sizing is harder than elsewhere the ink will not penetrate and will dry with a gloss. It is absolutely certain that a high gloss does not necessarily mean a good printing surface although the two are not necessarily incompatible.

Closely connected with the mottled effect is the excessive spread of the double-tone inks when they are used on certain papers. The amount of adhesive used in the coating has much to do with this for if the coating is porous the ink is absorbed without allowing any sidewise spreading of the oil, while if it is non-absorbent, because of too much adhesive, the ink will spread to an excessive extent.

In color work where a number of impressions are made at intervals the question of register is very important. If the size of the sheet changes between impressions it is practically impossible to make the two colors coincide and a defective job results. This is often claimed to be the fault of the paper by printers who believe that the paper maker can treat his

product so that it will not change dimensions with changing atmospheric conditions. As an actual fact very little can be done by the paper maker to cure this trouble since it is just as inherent in paper to stretch when dampened as it is for wood to swell when exposed to moisture. If the paper is sent out containing the average amount of moisture which it would be expected to contain under the conditions of the average printing shop, the paper maker may be considered to have done his best and the rest is up to the printer. Seasoning the paper in the press-room to bring it to equilibrium with its surroundings is an excellent precaution, particularly where constant humidity conditions are maintained in the press-room. If the shop windows are kept open so that outside changes are transmitted to the paper, good register is a question of good luck or of waiting before making the second impression until the same weather conditions prevail as when the first color was applied. With commercial work, where the job must be completed at a definite time, waiting is out of the question, so the single factor of luck may be said to be the important one. Both temperature and humidity control in the printing shop are strongly recommended, if much color work is to be done. The temperature, if it changes materially, will alter the size and relative position of the plates enough to cause trouble, while the humidity has a very great effect on the paper. It is interesting to note that in shops where air conditioning systems are installed color work can be done successfully during periods of weather which completely shut down shops of the ordinary type.

APPENDIX

SOLUBILITY OF ALUMINUM SULPHATE

(Poggiale)

100 parts water dissolve (a) parts $\text{Al}_2(\text{SO}_4)_3$ and (b) parts $\text{Al}_2(\text{SO}_4)_3 \cdot 18\text{H}_2\text{O}$ at

	0°	10°	20°	30°	40°	60°	80°	100°
<i>a</i>	31.3	33.5	36.15	40.36	45.73	59.09	73.14	89.11
<i>b</i>	86.85	95.8	107.35	127.6	167.6	262.6	467.3	1132.00

INFLUENCE OF TEMPERATURE ON DENSITY OF BLACK LIQUOR FROM THE SULPHATE PROCESS

(C. Moe)

Degrees F.	Specific gravity	Baumé	Specific gravity	Baumé	Specific gravity	Baumé	Specific gravity	Baumé
200	1.0800	10.7
190	1.0080	1.2	1.0840	11.2	1.2560	29.6
180	0.9800	1.0120	1.7	1.0880	11.7	1.2600	29.9
170	0.9840	1.0160	2.3	1.0920	12.2	1.2640	30.3
160	0.9880	1.0200	2.8	1.0960	12.7	1.2680	30.7
150	0.9920	1.0230	3.3	1.0995	13.1	1.2720	31.0
140	0.9950	1.0260	3.7	1.1030	13.5	1.2760	31.4
130	0.9980	1.0290	4.1	1.1065	14.0	1.2795	31.7
120	1.0010	0.2	1.0320	4.5	1.1095	14.3	1.2830	32.0
110	1.0030	0.4	1.0340	4.8	1.1125	14.7	1.2865	32.3
100	1.0050	0.7	1.0360	5.0	1.1155	15.0	1.2900	32.6
90	1.0070	1.0	1.0380	5.3	1.1180	15.3	1.2935	32.9
80	1.0080	1.2	1.0400	5.6	1.1205	15.6	1.2970	33.2
70	1.0090	1.3	1.0410	5.7	1.1230	15.9	1.3005	33.5
60	1.0100	1.4	1.0420	5.8	1.1255	16.2	1.3030	33.7

SPECIFIC GRAVITY OF SOLUTIONS OF PURE ALUMINUM SULPHATE AT 60° F.
From Beveridge

Specific gravity	100 liters of sulphate of alumina solution contain				
	Al ₂ O ₃ kilos	SO ₃ kilos	Kilos sulphate with		
			14 per cent Al ₂ O ₃	15 per cent Al ₂ O ₃	17 per cent Al ₂ O ₃
I.005	0.14	0.33	1	0.9	0.8
I.016	0.42	0.98	3	2.8	2.5
I.026	0.70	1.63	5	4.7	4.1
I.036	0.98	2.28	7	6.5	5.8
I.045	1.26	2.94	9	8.4	7.4
I.055	1.54	3.59	11	10.3	9.1
I.064	1.82	4.24	13	12.1	10.7
I.073	2.10	4.89	15	14.0	12.3
I.082	2.38	5.55	17	15.9	14.0
I.092	2.66	6.20	19	17.7	15.6
I.101	2.94	6.85	21	19.6	17.3
I.110	3.22	7.50	23	21.5	18.9
I.119	3.50	8.16	25	23.3	20.6
I.128	3.78	8.81	27	25.2	22.2
I.137	4.06	9.46	29	27.1	23.9
I.145	4.34	10.11	31	28.9	25.5
I.154	4.64	10.76	33	30.8	27.3
I.163	4.90	11.42	35	32.7	28.8
I.172	5.18	12.07	37	34.5	30.4
I.181	5.46	12.72	39	36.4	32.1
I.190	5.74	13.38	41	38.3	33.7
I.198	6.02	14.03	43	40.1	35.4
I.207	6.30	14.68	45	42.0	37.0
I.215	6.58	15.33	47	43.9	38.7
I.224	6.86	15.99	49	45.7	40.3
I.232	7.14	16.64	51	47.6	42.0
I.240	7.42	17.29	53	49.5	43.6
I.248	7.70	17.94	55	51.3	45.3
I.256	7.98	18.59	57	53.2	46.9
I.265	8.26	19.25	59	55.1	48.5
I.273	8.54	19.90	61	56.9	50.2
I.281	8.82	20.55	63	58.8	51.8
I.289	9.10	21.20	65	60.7	53.5
I.297	9.38	21.86	67	62.5	55.1
I.305	9.66	22.51	69	64.4	56.8
I.312	9.94	23.16	71	66.3	58.4
I.320	10.22	23.81	73	68.1	60.0
I.328	10.50	24.47	75	70.0	61.7
I.335	10.78	25.12	77	71.9	63.4

VOLUMES SO₂ DISSOLVED BY ONE VOLUME OF WATER

Per cent SO ₂	2 per cent	2½	3	3½	4	4½	5	5½	6	6½	7
At											
0° C.	1.6	2.0	2.4	2.8	3.2	3.6	4.0	4.4	4.8	5.2	5.6
10° C.	1.13	1.41	1.7	2.0	2.26	2.55	2.83	3.11	3.4	3.68	3.96
15° C.	0.95	1.18	1.42	1.66	1.89	2.13	2.37	2.60	2.84	3.07	3.31
20° C.	0.79	0.99	1.18	1.38	1.58	1.77	1.97	2.17	2.36	2.56	2.76
30° C.	0.54	0.68	0.82	0.95	1.09	1.22	1.36	1.50	1.63	1.77	1.90
40° C.	0.38	0.47	0.56	0.66	0.75	0.85	0.94	1.03	1.13	1.22	1.32

Per cent SO ₂	7½	8	8½	9	9½	10	10½	12	14	15	16
At											
0° C.	6.0	6.38	6.78	7.2	7.6	8.0	8.38	9.58	11.17	11.97	12.77
10° C.	4.25	4.53	4.81	5.0	5.28	5.66	5.94	6.79	7.92	8.49	9.06
15° C.	3.55	3.78	4.02	4.36	4.59	4.73	4.97	5.67	6.62	7.10	7.57
20° C.	3.00	3.15	3.35	3.55	3.74	3.94	4.13	4.73	5.56	5.91	6.30
30° C.	2.04	2.18	2.31	2.45	2.58	2.72	2.86	3.26	3.70	4.08	4.35
40° C.	1.41	1.48	1.58	1.69	1.79	1.88	1.97	2.26	2.63	2.82	3.00

Per cent SO ₂	17	18	20	22	24	26	28	30	35	40	45
At											
0° C.	13.56	14.36	15.96	17.55	19.15	20.74	22.32	23.94	27.93	31.92	35.91
10° C.	9.62	10.2	11.32	12.45	13.58	14.71	15.84	16.98	19.81	22.64	25.47
15° C.	7.94	8.57	9.46	10.40	11.35	12.29	13.24	14.22	16.58	18.92	21.28
20° C.	6.69	7.09	7.88	8.66	9.45	10.24	11.03	11.82	13.79	15.76	17.73
30° C.	4.62	4.89	5.44	5.98	6.52	7.07	7.61	8.16	9.52	10.88	12.24
40° C.	3.19	3.38	3.76	4.13	4.51	4.88	5.26	5.64	6.58	7.52	8.46

Per cent SO ₂	50	55	60	65	70	75	80	85	90	95	100
At											
0° C.	39.90	43.89	47.88	53.67	55.86	59.85	63.64	67.63	71.82	75.81	79.8
10° C.	28.30	31.13	33.96	36.79	39.62	42.45	45.28	48.4	50.97	53.77	56.6
15° C.	23.65	26.01	28.38	30.74	33.11	35.47	37.84	40.20	42.57	44.99	47.3
20° C.	19.70	21.67	23.64	25.61	27.58	29.55	31.53	33.50	35.46	37.43	39.4
30° C.	13.60	14.96	16.32	17.68	19.04	20.40	21.76	23.12	24.46	25.82	27.2
40° C.	9.40	10.34	11.28	12.12	13.16	14.20	15.04	15.98	16.92	17.86	18.8

CONVERSION OF CENTIGRADE TO FAHRENHEIT DEGREES

° C.	° F.	+° C.	+° F.	+° C.	+° F.	+° C.	+° F.	+° C.	+° F.
-30	-22.0	17	62.6	64	147.2	111	231.8	158	316.4
29	20.2	18	64.4	65	149.0	112	233.6	159	318.2
28	18.4	19	66.2	66	150.8	113	235.4	160	320.0
27	16.6	20	68.0	67	152.6	114	237.2	161	321.8
26	14.8	21	69.8	68	154.4	115	239.0	162	323.6
25	13.0	22	71.6	69	156.2	116	240.8	163	325.4
24	11.2	23	73.4	70	158.0	117	242.6	164	327.2
23	9.4	24	75.2	71	159.8	118	244.4	165	329.0
22	7.6	25	77.0	72	161.6	119	246.2	166	330.8
21	5.8	26	78.8	73	163.4	120	248.0	167	332.6
20	4.0	27	80.6	74	165.2	121	249.8	168	334.4
19	2.2	28	82.4	75	167.0	122	251.6	169	336.2
18	0.4	29	84.2	76	168.8	123	253.4	170	338.0
17	+ 1.4	30	86.0	77	170.6	124	255.2	171	339.8
16	3.2	31	87.8	78	172.4	125	257.0	172	341.6
15	5.0	32	89.6	79	174.2	126	258.8	173	343.4
14	6.8	33	91.4	80	176.0	127	260.6	174	345.2
13	8.6	34	93.2	81	177.8	128	262.4	175	347.0
12	10.4	35	95.0	82	179.6	129	264.2	176	348.8
11	12.2	36	96.8	83	181.4	130	266.0	177	350.6
10	14.0	37	98.6	84	183.2	131	267.8	178	352.4
9	15.8	38	100.4	85	185.0	132	269.6	179	354.2
8	17.6	39	102.2	86	186.8	133	271.4	180	356.0
7	19.4	40	104.0	87	188.6	134	273.2	181	357.8
6	21.2	41	105.8	88	190.4	135	275.0	182	359.6
5	23.0	42	107.6	89	192.2	136	276.8	183	361.4
4	24.8	43	109.4	90	194.0	137	278.6	184	363.2
3	26.6	44	111.2	91	195.8	138	280.4	185	365.0
2	28.4	45	113.0	92	197.6	139	282.2	186	366.8
1	30.2	46	114.8	93	199.4	140	284.0	187	368.6
0	32.0	47	116.6	94	201.2	141	285.8	188	370.4
+ 1	33.8	48	118.4	95	203.0	142	287.6	189	372.2
2	35.6	49	120.2	96	204.8	143	289.4	190	374.0
3	37.4	50	122.0	97	206.6	144	291.2	191	375.8
4	39.2	51	123.8	98	208.4	145	293.0	192	377.6
5	41.0	52	125.6	99	210.2	146	294.8	193	379.4
6	42.8	53	127.4	100	212.0	147	296.6	194	381.2
7	44.6	54	129.2	101	213.8	148	298.4	195	383.0
8	46.4	55	131.0	102	215.6	149	300.2	196	384.8
9	48.2	56	132.8	103	217.4	150	302.0	197	386.6
10	50.0	57	134.6	104	219.2	151	303.8	198	388.4
11	51.8	58	136.4	105	221.0	152	305.6	199	390.2
12	53.6	59	138.2	106	222.8	153	307.4	200	392.0
13	55.4	60	140.0	107	224.6	154	309.2		
14	57.2	61	141.8	108	226.4	155	311.0		
15	59.0	62	143.6	109	228.2	156	312.8		
16	60.8	63	145.4	110	230.0	157	314.6		

(Reprinted from D. Van Nostrand's Chemical Annual, Fourth Issue, 1918, with the permission of the editor and publishers.)

PHYSICAL CONSTANTS

Number	Name	Sym- bol	Atomic weight. O=16	Molec- ular weight	Specific Gravity. Water=1. Air=1 (A). Hydrogen =1 (D.)	Atomic vol. At.wt. Sp.Gr.	Specific heat at 0° C.
1	Aluminium.....	Al	27.1	{ 2.708 2.72 ¹⁸ ₈ °	10.01 9.96	} 0.2220
2	Antimony.....	Sb	120.2	6.6900 ²⁴ ₄ °	18.2	0.0495
3	Argon, gas.....	A	39.88	39.88	{ 1.379 A. 19.96 D. }	0.1233
4	liquid.....	A	39.88	1.4046 ⁻¹⁸⁶ ₀	28.4
5	Arsenic, amorph...	As	74.96	299.84	4.716 ¹⁴ ₀	15.9	0.0758 { 21°—
6	cryst.....	As	74.96	299.84	5.727 ¹⁴ ₀	13.1	0.0830 { 65°
7	Barium.....	Ba	137.37	3.75	36.6
8	Bismuth.....	Bi	208	9.7474	21.3	0.03013
9	Boron, amorph....	B	11.0	2.45	4.5	0.3066
10	cryst.....	B	11.0	2.53—2.68	4.2	0.165 ^(21°)
11	Bromine, gas.....	Br ₂	79.92	159.84	5.8691 ⁶⁰⁰ ₀ A.	0.0555(83°)
12	liquid.....	Br ₂	79.92	159.84	3.1883 ⁰⁰ ₀	24.9	0.1071
13	Cadmium.....	Cd	112.40	112.40	8.642 ¹⁷ ₀	13.0	0.0548
14	Caesium.....	Cs	132.81	1.87 ²⁰ ₀	17.0	0.0522
15	Calcium.....	Ca	40.07	1.5446 ^{29,2°} ₀	25.9	0.1453
16	Carbon, amorph...	C	12.005	1.75—2.10	6.2	0.241
17	graphite.....	C	12.005	2.10—2.585	5.1	0.202
18	diamond.....	C	12.005	3.47—3.5585	3.4	0.1469
19	Cerium.....	Ce	140.25	6.92 ²⁵ ₀	20.3	0.05112
20	Chlorine, gas.....	Cl	35.46	70.92	2.491 ⁰⁰ ₀ A.	0.1241
21	liquid.....	Cl	35.46	1.4405 ⁰⁰ ₀	24.6	0.2262
22	Chromium.....	Cr	52.0	6.92 ²⁰ ₀	7.6	0.10394
23	Cobalt.....[bium]	Co	58.97	8.718 ²¹ ₀	6.8	0.1030
24	Columbium (Niobium).....	Cb	93.5	7.061 ⁸ ₀	13.2
25	Copper.....	Cu	63.57	8.91—8.96	7.1	0.0936
26	Erbium.....	Er	167.4	4.77	35.1
27	Fluorine, gas.....	F	19.0	38.0	1.31 ¹⁵ ₀ A.
28	liquid.....	F	19.0	38.0	1.14 ⁻¹⁸⁷ ₀	16.7
29	Gadolinium.....	Gd	157.3	1.31	120.1
30	Gallium.....	Ga	69.9	5.95 ²⁴ ₀	11.8	0.079
31	Germanium.....	Ge	72.5	5.409 ²³ ₀	13.3	0.0737
32	Glucinum (Beryllium).....	Gl	9.1	1.85 ²⁰ ₀	4.9
33	Gold.....	Au	197.2	19.32	10.2	0.0316
34	Helium, gas.....	He	4.00	4.00	{ 0.1368 A. 1.98 D. }	29.2 20.2	} 1.248 ²¹⁸ ₀

OF THE ELEMENTS

Number	At. heat, sp. heat X at. wt.	Electrical conductivity† at 0° C.	Thermal conductivity K* at 0° C. Ag=1.00	Linear coefficient of expansion		Melting point, ° C.	Boiling point, ° C.
					At ° C.		
1	6.02	324000	.3435	.04245	40°	657°	> 2200°
2	5.95	27100	.0442	.041152	40°	630°	1440°
3	4.92043894	-187.9°	-186.1°
4
5	5.69	28600040559	40°	< 360°
6	6.23	sublimes at	554°
7	850°	vol. 950°
8	6.27	9260	.0177	.041346	40°	268°	1420°
9	3.37	2200° in	sublimes at
10	1.82	vacuo	3500°
11	4.44
12	8.57	-7.3°	58.7
13	6.16	146000	.2213	.043069	40°	321°	765.9°
14	6.93	254000339482	27-100°	28.45°	670°
15	5.83	95000	805°
16	2.8904054	40°	sublimes at	3500°
17	2.22040786	40°	sublimes at	3500°
18	1.76040118	40°	sublimes at	3500°
19	6.28	13950	635°
20	4.40	-102°	-33.6°
21	8.02021978	0-10°
22	5.42	1520°	2200°
23	6.08	83200041236	40°	1478°
24	1950°
25	5.95	640600	.7198	.041678	40°	{ 1083° 1065° (in air)	2310°, 2000° in vacuo
26
27
28	-223°	-187°
29
30	5.53	30.15°
31	5.34	916°	vol. 1350°
32	54100 ²⁰⁰	1280°	> 1900°
33	6.23	468000	.7003	.041470	0-100°	1062°	2530°, 2000° in vacuo
34033386	< -269°	-268.75°

* K = the number of grams of water which can be raised from 0° to 1° C. by the heat which passes through a cubic centimeter of the substance in one second when the temperature of the opposite sides of the cube are maintained at a difference of 1° C.

† Reciprocal of the resistance in ohms of a centimeter cube of the substance.

PHYSICAL CONSTANTS

Number	Name	Sym- bol	Atomic weight. O=16	Molec- ular weight	Specific Gravity. Water=1. Air=1 (A). Hydrogen=1 (D.)	Atomic vol. At.wt. Sp.Gr.	Specific heat at 0° C.
1	Hydrogen, gas....	H	1.008	2.016	0.06949 A. -252.83°	3.410
2	liquid.....	H	1.008	2.016	0.07105 745.52 mm.	1.4	6.
3	Indium.....	In	114.8	7.12 ² ₈	16.1	0.05695
4	Iodine, gas.....	I	126.92	8.72 A.	0.0336 ^{206°}
5	solid.....	I	126.92	253.84	4.948 ^{17°}	25.7	0.04852
6	Iridium, spongy...	Ir	193.1	15.86	12.2
7	crystalline.....	Ir	193.1	22.42	8.6	0.0323
8	Iron, pure.....	Fe	55.84	7.85-7.88	7.1	0.1162
9	wrought.....	Fe	55.84	7.86	7.1	0.1130
10	steel.....	Fe	55.84	7.60-7.80	7.3	0.1066
11	gray pig.....	Fe	55.84	7.03-7.13	7.9
12	white pig.....	Fe	55.84	7.58-7.73	7.3	0.1050
13	Krypton, gas....	Kr	82.92	82.92	{ 2.818 A. 40.78 D. }
14	liquid.....	Kr	82.92	2.155 ^{-152°}	38.5
15	Lanthanum.....	La	139.0	6.1545	22.6	0.04485.
16	Lead.....	Pb	207.20	11.337 ^{19.94} _{19.94}	18.3	0.0310
17	Lithium.....	Li	6.94	0.534 ^{20°}	13.00	0.8366
18	Magnesium.....	Mg	24.32	1.69-1.75	14.1	0.2456
19	Manganese.....	Mn	54.93	7.42	7.4	0.1217
20	Mercury.....	Hg	200.6	200.6	13.5953 ²	14.8	0.03346
21	Molybdenum.....	Mo	96.0	10.281 ²⁴	9.3	0.0659
22	Neodymium.....	Nd	144.3	6.9563	20.7
23	Neon.....	Ne	20.2	{ 0.695 A. 9.96 D. }
24	Nickel.....	Ni	58.68	8.6-8.93	6.7	0.1084
25	Nitrogen, gas....	N	14.01	28.02	0.96737 A.	0.2438
26	liquid.....	N	14.01	0.8042 ^{-195.5°}	17.4
27	Osmium.....	Os	190.9	22.48	8.5	0.03113
28	Oxygen, gas.....	O	16.00	32.00	1.10535 A.	0.2175
29	liquid.....	O	16.00	32.00	1.1181 ^{-182.5°}	14.3
30	Ozone.....	O ₃	48.00	1.658 A.
31	Palladium.....	Pd	106.7	11.4-11.9	9.2	0.0592
32	Phosphorus, yel..	P	31.04	124.16	1.831 ^{18°}	17.0	0.202
33	red.....	P	31.04	124.16	2.296 ^{16°}	13.5	0.1829
34	liquid.....	P	31.04	1.764 ^{44.3°}	17.6
35	Platinum.....	Pt	195.2	21.16 ^{24°}	9.2	0.0323
36	Potassium.....	K	39.10	0.8621 ^{20°}	44.7	0.1729
37	Praseodymium....	Pr	140.9	6.4754	21.8
38	Radium.....	Ra	226.0
39	Rhodium.....	Rh	102.9	12.1	8.5	0.05803
40	Rubidium.....	Rb	85.45	1.532 ^{20°}	55.78	0.0802

OF THE ELEMENTS

Number	At. heat, sp. heat × at. wt.	Electrical conductivity† at 0° C.	Thermal conductivity K* at 0° C. Ag=1.00	Linear coefficient of expansion		Melting point, ° C.	Boiling point, ° C.
					At ° C.		
1	3.44		.03270			-259°	-252.5°
2	6.05						
3	6.56	119500		.0417	40°	155°	700°
4	4.27						
5	6.16			.04837	-190-17	114.2°	184.35°
6						2250°	
7	6.23			.040700	40°	1950°	
8	6.50	131000	.1665	.041182	0°-100°	1530°	2450°
9	6.32		.2070	.0411	0°-100°	1600°	
10	5.96	63000	.1300	.0411	0°-100°	1375°	
11		10200-		.041061	40°	1275°	
12	5.87	11300	.1490			1075°	
13						-169°	-151.7°
14							
15	6.23					810°	
16	3.52	50400	.0836	.042924	40°	327°	1525°
17	5.86	119000		.04600	0°-180°	186°	>1400°
18	5.98	230000	.3760	.042694	40°	650°	1120°
19	6.70					1260°	1900°
20	6.69	10630	.0148	.03182	0°-100°	-38.85°	357.33°
21	6.33					2500°	
22						840°	
23						-253°	-243°
24	6.36	144200	.1420	.041279	40°	1452°	
25	3.42		.04524			-210.5°	-195.5°
26							
27	5.95	105300		.040657	40°	2700°	
28	3.48		.04563			-227°	-182.7°
29							
30						decomp. 270°	-119°
31	6.32	97900	.1683	.041176	40°	1550°	
32	6.26			.03124	0°-44°	44.1°	290°
33	5.67					725°	350° (yel.)
34							
35	6.29	91200	.1664	.040899	40°	1753°	
36	6.51	150500		.0483	0°-50°	63.5°	757.5°
37						940°	
38						700°	
39	5.97			.040850	40°	1970°	
40						39°	696°

PHYSICAL CONSTANTS

Number	Name	Sym- bol	Atomic weight. O=16	Molec- ular weight	Specific Gravity. Water=1. Air=1 (A). Hydrogen=1 (D).	Atomic vol. At. wt. Sp. Gr.	Specific heat at 0° C.
1	Ruthenium, spon.	Ru	101.7	8.6	11.8
2	melted	Ru	101.7	11.4	8.9
3	cryst.	Ru	101.7	12.26 ⁸⁰	8.3	0.0611
4	Samarium	Sm	150.4	7.7-7.8	19.4
5	Scandium	Sc	44.1
6	Selenium, amorph.	Se	79.2	633.6	4.26-4.28 ²⁵⁰	18.5	0.09533
7	monoclinic	Se	79.2	633.6	4.47 ²⁵⁰	17.7	0.08401
8	hexagonal	Se	79.2	633.6	4.8 ²⁵⁰	16.5
9	Silicon, amorph.	Si	28.3	2.00	14.2	0.24 ²¹⁰
10	cryst.	Si	28.3	2.49 ¹⁰⁰	11.4	0.1697 ²²⁰
11	Silver	Ag	107.88	10.53	10.2	0.0559
12	Sodium	Na	23.00	0.9712 ²⁰⁰	23.6	0.2813
13	Strontium	Sr	87.63	2.54	34.5
	Sulphur,						
14	amorphous soft.	S	32.06	256.48	1.955 ⁶⁰⁰	16.4
15	“ yellow	S	32.06	256.48	2.046	15.6
16	rhombic	S _α	32.06	256.48	2.05-2.07 ⁰⁰	15.6	0.1728
17	monoclinic	S _β	32.06	256.48	1.958	16.4	0.1809
18	plastic	S _γ	32.06	256.48	1.92	16.7	0.1902
19	Tantalum	Ta	181.5	14.49 ¹⁸⁰	12.5	0.03017
20	Tellurium, amorph	Te	127.5	255.0	6.015 ²⁰⁰	21.2	0.0525
21	cryst.	Te	127.5	255.0	6.27	20.4	0.0475
22	Terbium	Tb	159.2
23	Thallium	Tl	204.0	11.85	17.2	0.0326
24	Thorium, amorph.	Th	232.40	11.00 ¹⁷⁰	21.1
25	cryst.	Th	232.40	11.23	20.7
26	Thulium	Tm	168.5
27	Tin, gray	Sn	118.7	5.8466 ¹⁵⁰	20.3	0.0545
28	rhombic	Sn	118.7	6.53-6.56	18.2	0.0559
29	tetragonal	Sn	118.7	7.2984 ¹⁵⁰	16.3	0.0559
30	Titanium	Ti	48.1	4.50 ^{17.50}	10.7	0.1125
31	Tungsten	W	184.0	18.77	9.8	0.0336
32	Uranium	U	238.2	18.685 ¹⁴⁰	12.8	0.0280
33	Vanadium	V	51.0	6.025 ¹⁸⁰	8.5	0.1240
34	Xenon, gas.	Xe	130.2	{ 4.22 A. } { 63.5 D. }
35	liquid	Xe	130.2	3.52 ^{-109.10}	37.0
36	Ytterbium	Yb	173.5
37	Yttrium	Yt	88.7	3.80 ¹⁵⁰	23.4
38	Zinc	Zn	65.37	65.37	7.142 ¹⁶⁰	9.2	0.09356
39	Zirconium, amorph	Zr	90.6	4.15	21.8
40	cryst.	Zr	90.6	6.40 ¹⁸⁰	14.2	0.0660

OF THE ELEMENTS

Number	At. heat, sp. heat X at. wt.	Electrical conductivity† at 0° C.	Thermal conductivity K* at 0° C. Ag=1.00	Linear coefficient of expansion		Melting point, ° C.	Boiling point, ° C.
					At ° C.		
1						> 1950°	
2						2000°	
3	6.21			.040963	40°	2000°	
4						1350°	
5						1200°	
6	7.55					50° (softens)	690°
7	6.65			.043680	40°	170°-180°	690°
8						217°	690°
9	6.06						3500°
10	4.82	200-15600		.040763	40°	1420°	3500°
11	6.04	681200	1.000	.041021	40°	961.5°	1955°
12	6.47	211000	.365	.0472	0°-50°	97.6°	877.5°
13		40300				900°	
14						> 120°	444.6°
15						ignition pt. 255	444.6°
16	5.54			.047433	13°-50°	114.5°	444.6°
17	5.80			.046413	40°	119.25°	444.6°
18	6.10						444.6°
19	5.46	60600		.0408		2900°	
20	6.69			.041675	40°	446°	1390°
21	6.07	46600		.043440	0°-20°	452°	1390°
22							
23	6.65	56800		.043021	40°	302°	1280°
24						> 1700°	
25							
26							
27	6.49					stable < 20°	
28	6.65					stable > 170°	> 2275°
29	6.65	76600	.1528	.042234	40°	232°	1450-1600
30	5.41					1795°	
31	6.18					3267°	
32	6.68					800°	
33	5.90					1720°	
34						-140°	-109.1°
35							
36						1800°	
37						1250°	
38	6.12	186000	.2653	.042918	40°	419°	918°
39						1500°	
40	5.98					2350°	

VAPOR PRESSURE OF WATER
ACCORDING TO REGNAULT

° C.	° F.	Inches of mercury	Pounds per square inch	° C.	° F.	Inches of mercury	Pounds per square inch
0	32.0	0.181	0.0890	42	107.6	2.404	1.216
1	33.8	0.194	0.0955	43	109.4	2.533	1.244
2	35.6	0.209	0.1025	44	111.2	2.669	1.312
3	37.4	0.224	0.1100	45	113.0	2.811	1.381
4	39.2	0.240	0.1180	46	114.8	2.959	1.454
5	41.0	0.257	0.1263	47	116.6	3.114	1.530
6	42.8	0.276	0.1354	48	118.4	3.276	1.609
7	44.6	0.295	0.1452	49	120.2	3.444	1.692
8	46.4	0.316	0.1551	50	122.0	3.62	1.78
9	48.2	0.338	0.1657	51	123.8	3.81	1.87
10	50.0	0.361	0.1773	52	125.6	4.00	1.96
11	51.8	0.386	0.1893	53	127.4	4.20	2.06
12	53.6	0.412	0.2023	54	129.2	4.41	2.17
13	55.4	0.439	0.2158	55	131.0	4.63	2.27
14	57.2	0.469	0.2303	56	132.8	4.85	2.39
15	59.0	0.500	0.2456	57	134.6	5.09	2.50
16	60.8	0.533	0.2618	58	136.4	5.33	2.62
17	62.6	0.568	0.2789	59	138.2	5.59	2.75
18	64.4	0.605	0.2970	60	140.0	5.86	2.88
19	66.2	0.644	0.3162	61	141.8	6.14	3.01
20	68.0	0.685	0.3363	62	143.6	6.42	3.16
21	69.8	0.728	0.3577	63	145.4	6.72	3.30
22	71.6	0.774	0.3802	64	147.2	7.04	3.46
23	73.4	0.822	0.4040	65	149.0	7.36	3.62
24	75.2	0.873	0.4289	66	150.8	7.70	3.78
25	77.0	0.927	0.4554	67	152.6	8.05	3.95
26	78.8	0.984	0.4833	68	154.4	8.41	4.13
27	80.6	1.044	0.5126	69	156.2	8.79	4.32
28	82.4	1.106	0.5434	70	158.0	9.18	4.51
29	84.2	1.172	0.5759	71	159.8	9.58	4.71
30	86.0	1.242	0.6101	72	161.6	10.00	4.91
31	87.8	1.315	0.6461	73	163.4	10.44	5.12
32	89.6	1.392	0.6838	74	165.2	10.89	5.35
33	91.4	1.473	0.7234	75	167.0	11.36	5.58
34	93.2	1.558	0.7655	76	168.8	11.84	5.82
35	95.0	1.647	0.810	77	170.6	12.35	6.06
36	96.8	1.740	0.855	78	172.4	12.87	6.32
37	98.6	1.838	0.903	79	174.2	13.40	6.58
38	100.4	1.941	0.954	80	176.0	13.96	6.85
39	102.2	2.049	1.007	81	177.8	14.54	7.14
40	104.0	2.162	1.061	82	179.6	15.14	7.44
41	105.8	2.280	1.121	83	181.4	15.75	7.74

Reprinted from D. Van Nostrand's Chemical Annual, Fourth Issue, 1918, with the permission of the editor and publishers.

VAPOR PRESSURE OF WATER (Continued)

° C.	° F.	Inches of mercury	Pounds per square inch	° C.	° F.	Atmospheres	Pounds per square inch
84	183.2	16.39	8.05	129	264.2	2.592	38.11
85	185.0	17.05	8.37	130	266.0	2.671	39.26
86	186.8	17.73	8.71	131	267.8	2.753	40.47
87	188.6	18.43	9.05	132	269.6	2.836	41.68
88	190.4	19.16	9.41	133	271.4	2.921	42.93
89	192.2	19.91	9.78	134	273.2	3.008	44.21
90	194.0	20.69	10.16	135	275.0	3.097	45.52
91	195.8	21.49	10.56	136	276.8	3.188	46.87
92	197.6	22.31	10.95	137	278.6	3.282	48.24
93	199.4	23.17	11.38	138	280.4	3.378	49.65
94	201.2	24.04	11.81	139	282.2	3.476	51.06
95	203.0	24.95	12.26	140	284.0	3.576	52.55
96	204.8	25.89	12.71	141	285.8	3.678	54.07
97	206.6	26.85	13.19	142	287.6	3.783	55.60
98	208.4	27.85	13.68	143	289.4	3.890	57.16
99	210.2	28.87	14.18	144	291.2	4.000	58.79
		29.92		145	293.0	4.113	60.44
100	212.0	1.000*	14.70	146	294.8	4.227	62.13
101	213.8	1.036*	15.23	147	296.6	4.344	63.86
102	215.6	1.074*	15.79	148	298.4	4.464	65.62
103	217.4	1.112*	16.35	149	300.2	4.587	67.41
104	219.2	1.152*	16.94	150	302.0	4.712	69.26
105	221.0	1.193*	17.53	151	303.8	4.840	71.14
106	222.8	1.235*	18.15	152	305.6	4.971	73.06
107	224.6	1.278*	18.78	153	307.4	5.104	75.02
108	226.4	1.322*	19.44	154	309.2	5.240	77.03
109	228.2	1.368*	20.11	155	311.0	5.380	79.07
110	230.0	1.415*	20.80	156	312.8	5.522	81.22
111	231.8	1.463*	21.51	157	314.6	5.667	83.29
112	233.6	1.513*	22.24	158	316.4	5.815	85.47
113	235.4	1.564*	22.99	159	318.2	5.966	87.69
114	237.2	1.616*	23.76	160	320.0	6.120	89.96
115	239.0	1.670*	24.55	161	321.8	6.278	92.27
116	240.8	1.726*	25.37	162	323.6	6.439	94.63
117	242.6	1.782*	26.20	163	325.4	6.603	97.04
118	244.4	1.841*	27.06	164	327.2	6.770	99.50
119	246.2	1.901*	27.94	165	329.0	6.940	102.01
120	248.0	1.962*	28.85	166	330.8	7.114	104.56
121	249.8	2.025*	29.78	167	332.6	7.291	107.18
122	251.6	2.091*	30.73	168	334.4	7.472	109.84
123	253.4	2.157*	31.70	169	336.2	7.656	112.53
124	255.2	2.225*	32.70	170	338.0	7.844	115.29
125	257.0	2.295*	33.72	171	339.8	8.036	118.11
126	258.8	2.366*	34.78	172	341.6	8.231	120.98
127	260.6	2.430*	35.86	173	343.4	8.430	123.90
128	262.4	2.515*	36.97	174	345.2	8.632	126.87

* Atmospheres.

VAPOR PRESSURE OF WATER (*Continued*)

° C.	° F.	Atmospheres	Pounds per square inch	° C.	° F.	Atmospheres	Pounds per square inch
175	347.0	8.839	129.91	203	397.4	16.364	240.54
176	348.8	9.049	133.00	204	399.2	16.703	245.49
177	350.6	9.263	136.15	205	401.0	17.047	250.53
178	352.4	9.481	139.35	206	402.8	17.396	255.67
179	354.2	9.703	142.62	207	404.6	17.751	260.88
180	356.0	9.929	145.93	208	406.4	18.111	266.18
181	357.8	10.150	149.32	209	408.2	18.477	271.55
182	359.6	10.394	152.77	210	410.0	18.848	277.01
183	361.4	10.633	156.32	211	411.8	19.226	282.58
184	363.2	10.876	159.84	212	413.6	19.608	288.21
185	365.0	11.123	163.47	213	415.4	19.997	293.92
186	366.8	11.374	167.17	214	417.2	20.391	299.72
187	368.6	11.630	170.94	215	419.0	20.791	305.57
188	370.4	11.885	174.76	216	420.8	21.197	311.57
189	372.2	12.155	178.65	217	422.6	21.600	317.62
190	374.0	12.425	182.61	218	424.4	22.027	323.78
191	375.8	12.699	186.63	219	426.2	22.452	330.01
192	377.6	12.977	190.72	220	428.0	22.882	336.30
193	379.4	13.261	194.88	221	429.8	23.319	342.70
194	381.2	13.549	199.13	222	431.6	23.761	349.21
195	383.0	13.842	203.43	223	433.4	24.210	355.81
196	384.8	14.139	207.81	224	435.2	24.666	362.50
197	386.6	14.441	212.25	225	437.0	25.128	369.29
198	388.4	14.749	216.77	226	438.8	25.596	376.17
199	390.2	15.062	221.37	227	440.6	26.071	383.15
200	392.0	15.380	226.04	228	442.4	26.552	390.22
201	393.8	15.703	230.79	229	444.2	27.040	397.40
202	395.6	16.031	235.61				

SODIUM CHLORIDE SOLUTION AT 15°

GERLACH

Specific Gravity	Per cent NaCl	Specific Gravity	Per cent NaCl	Specific Gravity	Per cent NaCl	Specific Gravity	Per cent NaCl
1.00725	1	1.05851	8	1.11146	15	1.16755	22
1.01450	2	1.06593	9	1.11938	16	1.17580	23
1.02174	3	1.07335	10	1.12730	17	1.18404	24
1.02899	4	1.08097	11	1.13523	18	1.19228	25
1.03624	5	1.08859	12	1.14315	19	1.20098	26
1.04366	6	1.09622	13	1.15107	20	1.20433	26.395
1.05108	7	1.10384	14	1.15931	21		

Reprinted from D. Van Nostrand's Chemical Annual, Fourth Issue, 1918, with the permission of the editor and publisher.

SODIUM CARBONATE SOLUTION AT 15°

LUNGE

Specific Gravity	Degrees Baumé	Per cent Na ₂ CO ₃	Per cent Na ₂ CO ₃ .10 H ₂ O	1 liter contains grams	
				Na ₂ CO ₃	Na ₂ CO ₃ .10 H ₂ O
1.007	1.0	0.67	1.807	6.8	18.2
1.014	2.0	1.33	3.587	13.5	36.4
1.022	3.1	2.09	5.637	21.4	57.6
1.029	4.1	2.76	7.444	28.4	76.6
1.036	5.1	3.43	9.251	35.5	95.8
1.045	6.2	4.29	11.570	44.8	120.9
1.052	7.2	4.94	13.323	52.0	140.2
1.060	8.2	5.71	15.400	60.5	163.2
1.067	9.1	6.37	17.180	68.0	183.3
1.075	10.1	7.12	19.203	76.5	206.4
1.083	11.1	7.88	21.252	85.3	230.2
1.091	12.1	8.62	23.248	94.0	253.6
1.100	13.2	9.43	25.432	103.7	279.8
1.108	14.1	10.19	27.482	112.9	304.5
1.116	15.1	10.95	29.532	122.2	329.6
1.125	16.1	11.81	31.851	132.9	358.3
1.134	17.1	12.61	34.009	143.0	385.7
1.142	18.0	13.16	35.493	150.3	405.3
1.152	19.1	14.24	38.405	164.1	442.4

Reprinted from D. Van Nostrand's Chemical Annual, Fourth Issue, 1918, with the permission of the editor and publishers.

CONCENTRATED SODIUM CARBONATE SOLUTION AT 30°

LUNGE

Specific Gravity	Degrees Baumé	Per cent Na ₂ CO ₃	Per cent Na ₂ CO ₃ .10 H ₂ O	1 liter contains grams	
				Na ₂ CO ₃	Na ₂ CO ₃ .10 H ₂ O
I. 142	18.0	13.79	37.21	157.5	425.0
I. 152	19.1	14.64	39.51	168.7	455.2
I. 162	20.2	15.49	41.79	180.0	485.7
I. 171	21.2	16.27	43.89	190.5	514.0
I. 180	22.1	17.04	45.97	201.1	542.6
I. 190	23.1	17.90	48.31	214.0	577.5
I. 200	24.2	18.76	50.62	225.1	607.4
I. 210	25.2	19.61	52.91	237.3	640.3
I. 220	26.1	20.47	55.29	249.7	673.8
I. 231	27.2	21.42	57.80	263.7	711.5
I. 241	28.2	22.29	60.15	276.6	746.3
I. 252	29.2	23.25	62.73	291.1	785.4
I. 263	30.2	24.18	65.24	305.4	824.1
I. 274	31.2	25.11	67.76	319.9	863.2
I. 285	32.2	26.04	70.28	334.6	902.8
I. 297	33.2	27.06	73.02	351.0	947.1
I. 308	34.1	27.97	75.48	365.9	987.4

Reprinted from D. Van Nostrand's Chemical Annual, Fourth Issue, 1918, with the permission of the editor and publishers.

EQUIVALENT OF DEGREES BAUMÉ (AMERICAN STANDARD)
AND SPECIFIC GRAVITY AT 60° F.

$$\text{Degrees Baumé} = 145 - \frac{145}{\text{Sp. Gr.}} \text{ for Liquids Heavier than Water}$$

Degrees Baumé	Specific Gravity	Degrees Baumé	Specific Gravity	Degrees Baumé	Specific Gravity	Degrees Baumé	Specific Gravity
0.0	1.0000	.7	1.0262	.4	1.0538	.1	1.0829
.1	1.0007	.8	1.0269	.5	1.0545	.2	1.0837
.2	1.0014	.9	1.0276	.6	1.0553	.3	1.0845
.3	1.0021	4.0	1.0284	.7	1.0561	.4	1.0853
.4	1.0028	.1	1.0291	.8	1.0569	.5	1.0861
.5	1.0035	.2	1.0298	.9	1.0576	.6	1.0870
.6	1.0042	.3	1.0306	8.0	1.0584	.7	1.0878
.7	1.0049	.4	1.0313	.1	1.0592	.8	1.0886
.8	1.0055	.5	1.0320	.2	1.0599	.9	1.0894
.9	1.0062	.6	1.0328	.3	1.0607	12.0	1.0902
1.0	1.0069	.7	1.0335	.4	1.0615	.1	1.0910
.1	1.0076	.8	1.0342	.5	1.0623	.2	1.0919
.2	1.0083	.9	1.0350	.6	1.0630	.3	1.0927
.3	1.0090	5.0	1.0357	.7	1.0638	.4	1.0935
.4	1.0097	.1	1.0365	.8	1.0646	.5	1.0943
.5	1.0105	.2	1.0372	.9	1.0654	.6	1.0952
.6	1.0112	.3	1.0379	9.0	1.0662	.7	1.0960
.7	1.0119	.4	1.0387	.1	1.0670	.8	1.0968
.8	1.0126	.5	1.0394	.2	1.0677	.9	1.0977
.9	1.0133	.6	1.0402	.3	1.0685	13.0	1.0985
2.0	1.0140	.7	1.0409	.4	1.0693	.1	1.0993
.1	1.0147	.8	1.0417	.5	1.0701	.2	1.1002
.2	1.0154	.9	1.0424	.6	1.0709	.3	1.1010
.3	1.0161	6.0	1.0432	.7	1.0717	.4	1.1018
.4	1.0168	.1	1.0439	.8	1.0725	.5	1.1027
.5	1.0175	.2	1.0447	.9	1.0733	.6	1.1035
.6	1.0183	.3	1.0454	10.0	1.0741	.7	1.1043
.7	1.0190	.4	1.0462	.1	1.0749	.8	1.1052
.8	1.0197	.5	1.0469	.2	1.0757	.9	1.1060
.9	1.0204	.6	1.0477	.3	1.0765	14.0	1.1069
3.0	1.0211	.7	1.0484	.4	1.0773	.1	1.1077
.1	1.0218	.8	1.0492	.5	1.0781	.2	1.1086
.2	1.0226	.9	1.0500	.6	1.0789	.3	1.1094
.3	1.0233	7.0	1.0507	.7	1.0797	.4	1.1103
.4	1.0240	.1	1.0515	.8	1.0805	.5	1.1111
.5	1.0247	.2	1.0522	.9	1.0813	.6	1.1120
.6	1.0255	.3	1.0530	11.0	1.0821	.7	1.1128

Reprinted from D. Van Nostrand's Chemical Annual, Fourth Issue, 1918, with the permission of the editor and publishers.

EQUIVALENT OF DEGREES BAUMÉ (AMERICAN STANDARD)
AND SPECIFIC GRAVITY AT 60° F. (Continued)

Degrees Baumé	Specific Gravity	Degrees Baumé	Specific Gravity	Degrees Baumé	Specific Gravity	Degrees Baumé	Specific Gravity
.8	I. 1137	.2	I. 1526	.6	I. 1944	28.0	I. 2393
.9	I. 1145	.3	I. 1535	.7	I. 1954	.1	I. 2404
15.0	I. 1154	.4	I. 1545	.8	I. 1964	.2	I. 2414
.1	I. 1162	.5	I. 1554	.9	I. 1974	.3	I. 2425
.2	I. 1171	.6	I. 1563	24.0	I. 1983	.4	I. 2436
.3	I. 1180	.7	I. 1572	.1	I. 1993	.5	I. 2446
.4	I. 1188	.8	I. 1581	.2	I. 2003	.6	I. 2457
.5	I. 1197	.9	I. 1591	.3	I. 2013	.7	I. 2468
.6	I. 1206	20.0	I. 1600	.4	I. 2023	.8	I. 2478
.7	I. 1214	.1	I. 1609	.5	I. 2033	.9	I. 2489
.8	I. 1223	.2	I. 1619	.6	I. 2043	29.0	I. 2500
.9	I. 1232	.3	I. 1628	.7	I. 2053	.1	I. 2511
16.0	I. 1240	.4	I. 1637	.8	I. 2063	.2	I. 2522
.1	I. 1249	.5	I. 1647	.9	I. 2073	.3	I. 2532
.2	I. 1258	.6	I. 1656	25.0	I. 2083	.4	I. 2543
.3	I. 1267	.7	I. 1665	.1	I. 2093	.5	I. 2554
.4	I. 1275	.8	I. 1675	.2	I. 2104	.6	I. 2565
.5	I. 1284	.9	I. 1684	.3	I. 2114	.7	I. 2576
.6	I. 1293	21.0	I. 1694	.4	I. 2124	.8	I. 2587
.7	I. 1302	.1	I. 1703	.5	I. 2134	.9	I. 2598
.8	I. 1310	.2	I. 1712	.6	I. 2144	30.0	I. 2609
.9	I. 1319	.3	I. 1722	.7	I. 2154	.1	I. 2620
17.0	I. 1328	.4	I. 1731	.8	I. 2164	.2	I. 2631
.1	I. 1337	.5	I. 1741	.9	I. 2175	.3	I. 2642
.2	I. 1346	.6	I. 1750	26.0	I. 2185	.4	I. 2653
.3	I. 1355	.7	I. 1760	.1	I. 2195	.5	I. 2664
.4	I. 1364	.8	I. 1769	.2	I. 2205	.6	I. 2675
.5	I. 1373	.9	I. 1779	.3	I. 2216	.7	I. 2686
.6	I. 1381	22.0	I. 1789	.4	I. 2226	.8	I. 2697
.7	I. 1390	.1	I. 1798	.5	I. 2236	.9	I. 2708
.8	I. 1399	.2	I. 1808	.6	I. 2247	31.0	I. 2719
.9	I. 1408	.3	I. 1817	.7	I. 2257	.1	I. 2730
18.0	I. 1417	.4	I. 1827	.8	I. 2267	.2	I. 2742
.1	I. 1426	.5	I. 1837	.9	I. 2278	.3	I. 2753
.2	I. 1435	.6	I. 1846	27.0	I. 2288	.4	I. 2764
.3	I. 1444	.7	I. 1856	.1	I. 2299	.5	I. 2775
.4	I. 1453	.8	I. 1866	.2	I. 2309	.6	I. 2787
.5	I. 1462	.9	I. 1876	.3	I. 2319	.7	I. 2798
.6	I. 1472	23.0	I. 1885	.4	I. 2330	.8	I. 2809
.7	I. 1481	.1	I. 1895	.5	I. 2340	.9	I. 2821
.8	I. 1490	.2	I. 1905	.6	I. 2351	32.0	I. 2832
.9	I. 1499	.3	I. 1915	.7	I. 2361	.1	I. 2843
19.0	I. 1508	.4	I. 1924	.8	I. 2372	.2	I. 2855
.1	I. 1517	.5	I. 1934	.9	I. 2383	.3	I. 2866

EQUIVALENT OF DEGREES BAUMÉ (AMERICAN STANDARD)
AND SPECIFIC GRAVITY AT 60° F. (Continued)

Degrees Baumé	Specific Gravity	Degrees Baumé	Specific Gravity	Degrees Baumé	Specific Gravity	Degrees Baumé	Specific Gravity
.4	1.2877	.8	1.3401	.2	1.3969	.6	1.4588
.5	1.2889	.9	1.3414	.3	1.3983	.7	1.4602
.6	1.2900	37.0	1.3426	.4	1.3996	.8	1.4617
.7	1.2912	.1	1.3438	.5	1.4010	.9	1.4632
.8	1.2923	.2	1.3451	.6	1.4023	46.0	1.4646
.9	1.2935	.3	1.3463	.7	1.4037	.1	1.4661
33.0	1.2946	.4	1.3476	.8	1.4050	.2	1.4676
.1	1.2958	.5	1.3488	.9	1.4064	.3	1.4691
.2	1.2970	.6	1.3501	42.0	1.4078	.4	1.4706
.3	1.2981	.7	1.3514	.1	1.4091	.5	1.4721
.4	1.2993	.8	1.3526	.2	1.4105	.6	1.4736
.5	1.3004	.9	1.3539	.3	1.4119	.7	1.4751
.6	1.3016	38.0	1.3551	.4	1.4133	.8	1.4766
.7	1.3028	.1	1.3564	.5	1.4146	.9	1.4781
.8	1.3040	.2	1.3577	.6	1.4160	47.0	1.4796
.9	1.3051	.3	1.3590	.7	1.4174	.1	1.4811
34.0	1.3063	.4	1.3602	.8	1.4188	.2	1.4826
.1	1.3075	.5	1.3615	.9	1.4202	.3	1.4841
.2	1.3087	.6	1.3628	43.0	1.4216	.4	1.4857
.3	1.3098	.7	1.3641	.1	1.4230	.5	1.4872
.4	1.3110	.8	1.3653	.2	1.4244	.6	1.4887
.5	1.3122	.9	1.3666	.3	1.4258	.7	1.4902
.6	1.3134	39.0	1.3679	.4	1.4272	.8	1.4918
.7	1.3146	.1	1.3692	.5	1.4286	.9	1.4933
.8	1.3158	.2	1.3705	.6	1.4300	48.0	1.4948
.9	1.3170	.3	1.3718	.7	1.4314	.1	1.4964
35.0	1.3182	.4	1.3731	.8	1.4328	.2	1.4979
.1	1.3194	.5	1.3744	.9	1.4342	.3	1.4995
.2	1.3206	.6	1.3757	44.0	1.4356	.4	1.5010
.3	1.3218	.7	1.3770	.1	1.4371	.5	1.5026
.4	1.3230	.8	1.3783	.2	1.4385	.6	1.5041
.5	1.3242	.9	1.3796	.3	1.4399	.7	1.5057
.6	1.3254	40.0	1.3810	.4	1.4414	.8	1.5073
.7	1.3266	.1	1.3823	.5	1.4428	.9	1.5088
.8	1.3278	.2	1.3836	.6	1.4442	49.0	1.5104
.9	1.3291	.3	1.3849	.7	1.4457	.1	1.5120
36.0	1.3303	.4	1.3862	.8	1.4471	.2	1.5136
.1	1.3315	.5	1.3876	.9	1.4486	.3	1.5152
.2	1.3327	.6	1.3889	45.0	1.4500	.4	1.5167
.3	1.3329	.7	1.3902	.1	1.4515	.5	1.5183
.4	1.3352	.8	1.3916	.2	1.4529	.6	1.5199
.5	1.3364	.9	1.3929	.3	1.4544	.7	1.5215
.6	1.3376	41.0	1.3942	.4	1.4558	.8	1.5231
.7	1.3389	.1	1.3956	.5	1.4573	.9	1.5247

HYDROCHLORIC ACID

Bé. °	Sp. gr.	Tw. °	Percent HCl	Bé. °	Sp. gr.	Tw. °	Percent HCl	Bé. °	Sp. gr.	Tw. °	Percent HCl
1.00	1.0069	1.38	1.40	16.0	1.1240	24.80	24.57	20.8	1.1675	33.50	32.93
2.00	1.0140	2.80	2.82	16.1	1.1248	24.96	24.73	20.9	1.1684	33.68	33.12
3.00	1.0211	4.22	4.25	16.2	1.1256	25.12	24.90	21.0	1.1694	33.88	33.31
4.00	1.0284	5.68	5.69	16.3	1.1265	25.30	25.06	21.1	1.1703	34.06	33.50
5.00	1.0357	7.14	7.15	16.4	1.1274	25.48	25.23	21.2	1.1713	34.26	33.69
5.25	1.0375	7.50	7.52	16.5	1.1283	25.66	25.39	21.3	1.1722	34.44	33.88
5.50	1.0394	7.88	7.89	16.6	1.1292	25.84	25.56	21.4	1.1732	34.64	34.07
5.75	1.0413	8.26	8.26	16.7	1.1301	26.02	25.72	21.5	1.1741	34.82	34.26
6.00	1.0432	8.64	8.64	16.8	1.1310	26.20	25.89	21.6	1.1751	35.02	34.45
6.25	1.0450	9.00	9.02	16.9	1.1319	26.38	26.05	21.7	1.1760	35.20	34.64
6.50	1.0469	9.38	9.40	17.0	1.1328	26.56	26.22	21.8	1.1770	35.40	34.83
6.75	1.0488	9.76	9.78	17.1	1.1336	26.72	26.39	21.9	1.1779	35.58	35.02
7.00	1.0507	10.14	10.17	17.2	1.1345	26.90	26.56	22.0	1.1789	35.78	35.21
7.25	1.0526	10.52	10.55	17.3	1.1354	27.08	26.73	22.1	1.1798	35.96	35.40
7.50	1.0545	10.90	10.94	17.4	1.1363	27.26	26.90	22.2	1.1808	36.16	35.59
7.75	1.0564	11.28	11.32	17.5	1.1372	27.44	27.07	22.3	1.1817	36.34	35.78
8.00	1.0584	11.68	11.71	17.6	1.1381	27.62	27.24	22.4	1.1827	36.54	35.97
8.25	1.0603	12.06	12.09	17.7	1.1390	27.80	27.41	22.5	1.1836	36.72	36.16
8.50	1.0623	12.46	12.48	17.8	1.1399	27.98	27.58	22.6	1.1846	36.92	36.35
8.75	1.0642	12.84	12.87	17.9	1.1408	28.16	27.75	22.7	1.1856	37.12	36.54
9.00	1.0662	13.24	13.26	18.0	1.1417	28.34	27.92	22.8	1.1866	37.32	36.73
9.25	1.0681	13.62	13.65	18.1	1.1426	28.52	28.09	22.9	1.1875	37.50	36.93
9.50	1.0701	14.02	14.04	18.2	1.1435	28.70	28.26	23.0	1.1885	37.70	37.14
9.75	1.0721	14.42	14.43	18.3	1.1444	28.88	28.44	23.1	1.1895	37.90	37.36
10.00	1.0741	14.82	14.83	18.4	1.1453	29.06	28.61	23.2	1.1904	38.08	37.58
10.25	1.0761	15.22	15.22	18.5	1.1462	29.24	28.78	23.3	1.1914	38.28	37.80
10.50	1.0781	15.62	15.62	18.6	1.1471	29.42	28.95	23.4	1.1924	38.48	38.03
10.75	1.0801	16.02	16.01	18.7	1.1480	29.60	29.13	23.5	1.1934	38.68	38.26
11.00	1.0821	16.42	16.41	18.8	1.1489	29.78	29.30	23.6	1.1944	38.88	38.49
11.25	1.0841	16.82	16.81	18.9	1.1498	29.96	29.48	23.7	1.1953	39.06	38.72
11.50	1.0861	17.22	17.21	19.0	1.1508	30.16	29.65	23.8	1.1963	39.26	38.95
11.75	1.0881	17.62	17.61	19.1	1.1517	30.34	29.83	23.9	1.1973	39.46	39.18
12.00	1.0902	18.04	18.01	19.2	1.1526	30.52	30.00	24.0	1.1983	39.66	39.41
12.25	1.0922	18.44	18.41	19.3	1.1535	30.70	30.18	24.1	1.1993	39.86	39.64
12.50	1.0943	18.86	18.82	19.4	1.1544	30.88	30.35	24.2	1.2003	40.06	39.86
12.75	1.0964	19.28	19.22	19.5	1.1554	31.08	30.53	24.3	1.2013	40.26	40.09
13.00	1.0985	19.70	19.63	19.6	1.1563	31.26	30.71	24.4	1.2023	40.46	40.32
13.25	1.1006	20.12	20.04	19.7	1.1572	31.44	30.90	24.5	1.2033	40.66	40.55
13.50	1.1027	20.54	20.45	19.8	1.1581	31.62	31.08	24.6	1.2043	40.86	40.78
13.75	1.1048	20.96	20.86	19.9	1.1590	31.80	31.27	24.7	1.2053	41.06	41.01
14.00	1.1069	21.38	21.27	20.0	1.1600	32.00	31.45	24.8	1.2063	41.26	41.24
14.25	1.1090	21.80	21.68	20.1	1.1609	32.18	31.64	24.9	1.2073	41.46	41.48
14.50	1.1111	22.22	22.09	20.2	1.1619	32.38	31.82	25.0	1.2083	41.66	41.72
14.75	1.1132	22.64	22.50	20.3	1.1628	32.56	32.01	25.1	1.2093	41.86	41.99
15.00	1.1154	23.08	22.92	20.4	1.1637	32.74	32.19	25.2	1.2103	42.06	42.30
15.25	1.1176	23.52	23.33	20.5	1.1647	32.94	32.38	25.3	1.2114	42.28	42.64
15.50	1.1197	23.94	23.75	20.6	1.1656	33.12	32.56	25.4	1.2124	42.48	43.01
15.75	1.1219	24.38	24.16	20.7	1.1666	33.32	32.75	25.5	1.2134	42.68	43.40

Specific Gravity determinations were made at 60° F., compared with water at 60° F.

From the Specific Gravities, the corresponding degrees Baumé were calculated by the following formula:

$$\text{Baumé} = 145 - \frac{145}{\text{Sp. Gr.}}$$

Baumé Hydrometers for use with this table must be graduated by the above formula which formula should always be printed on the scale.

Atomic weights from F. W. Clarke's table of 1901. O = 16.

ALLOWANCE FOR TEMPERATURE

10-15° Bé.	—	1/40° Bé. or .0002 Sp. Gr. for 1° F.
15-22° Bé.	—	1/30° Bé. or .0003 " " " 1° F.
22-25° Bé.	—	1/28° Bé. or .00035 " " " 1° F.

AUTHORITY — W. C. FERGUSON.

The above table was prepared under the supervision of the Manufacturing Chemists Association of the United States and adopted by the Association as standard for United States practice. Reprints of each table may be obtained from the Secretary of the Association, 84 State St., Boston.

NITRIC ACID

Bé. °	Sp. Gr.	Tw. °	Percent HNO ₃	Bé. °	Sp. Gr.	Tw. °	Percent HNO ₃	Bé. °	Sp. Gr.	Tw. °	Percent HNO ₃
10.00	1.0741	14.82	12.86	23.00	1.1885	37.70	30.49	36.00	1.3303	66.06	52.30
10.25	1.0761	15.22	13.18	23.25	1.1910	38.20	30.86	36.25	1.3334	66.68	52.81
10.50	1.0781	15.62	13.49	23.50	1.1934	38.68	31.21	36.50	1.3364	67.28	53.32
10.75	1.0801	16.02	13.81	23.75	1.1959	39.18	31.58	36.75	1.3395	67.90	53.84
11.00	1.0821	16.42	14.13	24.00	1.1983	39.66	31.94	37.00	1.3426	68.52	54.36
11.25	1.0841	16.82	14.44	24.25	1.2008	40.16	32.31	37.25	1.3457	69.14	54.89
11.50	1.0861	17.22	14.76	24.50	1.2033	40.66	32.68	37.50	1.3488	69.76	55.43
11.75	1.0881	17.62	15.07	24.75	1.2058	41.16	33.05	37.75	1.3520	70.40	55.97
12.00	1.0902	18.04	15.41	25.00	1.2083	41.66	33.42	38.00	1.3551	71.02	56.52
12.25	1.0922	18.44	15.72	25.25	1.2109	42.18	33.80	38.25	1.3583	71.66	57.08
12.50	1.0943	18.86	16.05	25.50	1.2134	42.68	34.17	38.50	1.3615	72.30	57.65
12.75	1.0964	19.28	16.39	25.75	1.2160	43.20	34.56	38.75	1.3647	72.94	58.23
13.00	1.0985	19.70	16.72	26.00	1.2185	43.70	34.94	39.00	1.3679	73.58	58.82
13.25	1.1006	20.12	17.05	26.25	1.2211	44.22	35.33	39.25	1.3712	74.24	59.43
13.50	1.1027	20.54	17.38	26.50	1.2236	44.72	35.70	39.50	1.3744	74.88	60.06
13.75	1.1048	20.96	17.71	26.75	1.2262	45.24	36.09	39.75	1.3777	75.54	60.71
14.00	1.1069	21.38	18.04	27.00	1.2288	45.76	36.48	40.00	1.3810	76.20	61.38
14.25	1.1090	21.80	18.37	27.25	1.2314	46.28	36.87	40.25	1.3843	76.86	62.07
14.50	1.1111	22.22	18.70	27.50	1.2340	46.80	37.26	40.50	1.3876	77.52	62.77
14.75	1.1132	22.64	19.02	27.75	1.2367	47.34	37.67	40.75	1.3909	78.18	63.48
15.00	1.1154	23.08	19.36	28.00	1.2393	47.86	38.06	41.00	1.3942	78.84	64.20
15.25	1.1176	23.52	19.70	28.25	1.2420	48.40	38.46	41.25	1.3976	79.52	64.93
15.50	1.1197	23.94	20.02	28.50	1.2446	48.92	38.85	41.50	1.4010	80.20	65.67
15.75	1.1219	24.38	20.36	28.75	1.2473	49.46	39.25	41.75	1.4044	80.88	66.42
16.00	1.1240	24.80	20.69	29.00	1.2500	50.00	39.66	42.00	1.4078	81.56	67.18
16.25	1.1262	25.24	21.03	29.25	1.2527	50.54	40.06	42.25	1.4112	82.24	67.95
16.50	1.1284	25.68	21.36	29.50	1.2554	51.08	40.47	42.50	1.4146	82.92	68.73
16.75	1.1306	26.12	21.70	29.75	1.2582	51.64	40.89	42.75	1.4181	83.62	69.52
17.00	1.1328	26.56	22.04	30.00	1.2609	52.18	41.30	43.00	1.4216	84.32	70.33
17.25	1.1350	27.00	22.38	30.25	1.2637	52.74	41.72	43.25	1.4251	85.02	71.15
17.50	1.1373	27.46	22.74	30.50	1.2664	53.28	42.14	43.50	1.4286	85.72	71.98
17.75	1.1395	27.90	23.08	30.75	1.2692	53.84	42.58	43.75	1.4321	86.42	72.82
18.00	1.1417	28.34	23.42	31.00	1.2719	54.38	43.00	44.00	1.4356	87.12	73.67
18.25	1.1440	28.80	23.77	31.25	1.2747	54.94	43.44	44.25	1.4392	87.84	74.53
18.50	1.1462	29.24	24.11	31.50	1.2775	55.50	43.89	44.50	1.4428	88.56	75.40
18.75	1.1485	29.70	24.47	31.75	1.2804	56.08	44.34	44.75	1.4464	89.28	76.28
19.00	1.1508	30.16	24.82	32.00	1.2832	56.64	44.78	45.00	1.4500	90.00	77.17
19.25	1.1531	30.62	25.18	32.25	1.2861	57.22	45.24	45.25	1.4536	90.72	78.07
19.50	1.1554	31.08	25.53	32.50	1.2889	57.78	45.68	45.50	1.4573	91.46	79.03
19.75	1.1577	31.54	25.88	32.75	1.2918	58.36	46.14	45.75	1.4610	92.20	80.04
20.00	1.1600	32.00	26.24	33.00	1.2946	58.92	46.58	46.00	1.4646	92.92	81.08
20.25	1.1624	32.48	26.61	33.25	1.2975	59.50	47.04	46.25	1.4684	93.68	82.18
20.50	1.1647	32.94	26.96	33.50	1.3004	60.08	47.49	46.50	1.4721	94.42	83.33
20.75	1.1671	33.42	27.33	33.75	1.3034	60.68	47.95	46.75	1.4758	95.16	84.48
21.00	1.1694	33.88	27.67	34.00	1.3063	61.26	48.42	47.00	1.4796	95.92	85.70
21.25	1.1718	34.36	28.02	34.25	1.3093	61.86	48.90	47.25	1.4834	96.68	86.98
21.50	1.1741	34.82	28.36	34.50	1.3122	62.44	49.35	47.50	1.4872	97.44	88.32
21.75	1.1765	35.30	28.72	34.75	1.3152	63.04	49.83	47.75	1.4910	98.20	89.76
22.00	1.1789	35.78	29.07	35.00	1.3182	63.64	50.32	48.00	1.4948	98.96	91.35
22.25	1.1813	36.26	29.43	35.25	1.3212	64.24	50.81	48.25	1.4987	99.74	93.13
22.50	1.1837	36.74	29.78	35.50	1.3242	64.84	51.30	48.50	1.5026	100.52	95.11
22.75	1.1861	37.22	30.14	35.75	1.3273	65.46	51.80				

Specific Gravity determinations were made at 60° F., compared with water at 60° F. From the Specific Gravities, the corresponding degrees Baumé were calculated by the following formula:

$$\text{Baumé} = 145 - \frac{145}{\text{Sp. Gr.}}$$

Baumé Hydrometers for use with this table must be graduated by the above formula, which formula should always be printed on the scale.

Atomic weights from F. W. Clarke's table of 1901. O = 16.

ALLOWANCE FOR TEMPERATURE:

At 10°-20° Bé.	—	1/30° Bé. or .00029 Sp. Gr. = 1° F.
20°-30° Bé.	—	1/23° Bé. or .00044 " " = 1° F.
30°-40° Bé.	—	1/20° Bé. or .00060 " " = 1° F.
40°-48.5° Bé.	—	1/17° Bé. or .00084 " " = 1° F.

AUTHORITY — W. C. FERGUSON.

The above table was prepared under the supervision of the Manufacturing Chemists Association of the United States and adopted by the Association as standard for United States practice. Reprints of each table may be obtained from the Secretary of the Association, 84 State St., Boston.

AQUA AMMONIA

Bé. °	Sp. Gr.	Per cent NH ₃	Bé. °	Sp. Gr.	Per cent NH ₃	Bé. °	Sp. Gr.	Per cent NH ₃
10.00	1.0000	.00	16.50	.9556	11.18	23.00	.9150	23.52
10.25	.9982	.40	16.75	.9540	11.64	23.25	.9135	24.01
10.50	.9964	.80	17.00	.9524	12.10	23.50	.9121	24.50
10.75	.9947	1.21	17.25	.9508	12.56	23.75	.9106	24.99
11.00	.9929	1.62	17.50	.9492	13.02	24.00	.9091	25.48
11.25	.9912	2.04	17.75	.9475	13.49	24.25	.9076	25.97
11.50	.9894	2.46	18.00	.9459	13.96	24.50	.9061	26.46
11.75	.9876	2.88	18.25	.9444	14.43	24.75	.9047	26.95
12.00	.9859	3.30	18.50	.9428	14.90	25.00	.9032	27.44
12.25	.9842	3.73	18.75	.9412	15.37	25.25	.9018	27.93
12.50	.9825	4.16	19.00	.9396	15.84	25.50	.9003	28.42
12.75	.9807	4.59	19.25	.9380	16.32	25.75	.8989	28.91
13.00	.9790	5.02	19.50	.9365	16.80	26.00	.8974	29.40
13.25	.9773	5.45	19.75	.9349	17.28	26.25	.8960	29.89
13.50	.9756	5.88	20.00	.9333	17.76	26.50	.8946	30.38
13.75	.9739	6.31	20.25	.9318	18.24	26.75	.8931	30.87
14.00	.9722	6.74	20.50	.9302	18.72	27.00	.8917	31.36
14.25	.9705	7.17	20.75	.9287	19.20	27.25	.8903	31.85
14.50	.9689	7.61	21.00	.9272	19.68	27.50	.8889	32.34
14.75	.9672	8.05	21.25	.9256	20.16	27.75	.8875	32.83
15.00	.9655	8.49	21.50	.9241	20.64	28.00	.8861	33.32
15.25	.9639	8.93	21.75	.9226	21.12	28.25	.8847	33.81
15.50	.9622	9.38	22.00	.9211	21.60	28.50	.8833	34.30
15.75	.9605	9.83	22.25	.9195	22.08	28.75	.8819	34.79
16.00	.9589	10.28	22.50	.9180	22.56	29.00	.8805	35.28
16.25	.9573	10.73	22.75	.9165	23.04			

Specific Gravity determinations were made at 60° F., compared with water at 60° F.

From the Specific Gravities, the corresponding degrees Baumé were calculated by the following formula:

$$\text{Baumé} = \frac{140}{\text{Sp. Gr.}} - 130.$$

Baumé Hydrometers for use with this table must be graduated by the above formula, which formula should *always* be printed on the scale.

Atomic weights from F. W. Clarke's table of 1901. O = 16.

ALLOWANCE FOR TEMPERATURE

The coefficient of expansion for Ammonia Solutions, varying with the temperature, correction must be applied according to the following table:

Corrections to be added for each degree below 60° F.			Corrections to be subtracted for each degree above 60° F.			
Degrees Baumé	40° F.	50° F.	70° F.	80° F.	90° F.	100° F.
14°	.015° Bé.	.017° Bé.	.020° Bé.	.022° Bé.	.024° Bé.	.026° Bé.
16°	.021 " "	.023 " "	.026 " "	.028 " "	.030 " "	.032 " "
18°	.027 " "	.029 " "	.031 " "	.033 " "	.035 " "	.037 " "
20°	.033 " "	.036 " "	.037 " "	.038 " "	.040 " "	.042 " "
22°	.039 " "	.042 " "	.043 " "	.045 " "	.047 " "	
26°	.053 " "	.057 " "	.057 " "	.059 " "		

AUTHORITY — W. C. FERGUSON.

The above table was prepared under the supervision of the Manufacturing Chemists Association of the United States and adopted by the Association as standard for United States practice. Reprints of each table may be obtained from the Secretary of the Association, 84 State St., Boston.

SULPHURIC ACID

Bé.°	Sp. Gr.	Tw.°	Per cent H ₂ SO ₄	Weight of 1 cu. ft. in lbs. Av.	Per cent O. V.	Pounds O. V. in 1 cu. ft.	* Freezing (Melting) Point		Bé.°	Sp. Gr.	Tw.°	Per cent H ₂ SO ₄	Weight of 1 cu. ft. in lbs. Av.	Per cent O. V.	Pounds O. V. in 1 cu. ft.	* Freezing (Melting) Point	
							° F.	° F.								° F.	° F.
0	I. 0000	0.0	0.00	62.37	0.00	0.00	32.0	37	I. 3426	68.5	43.99	83.74	47.20	39.53	32.0	-50	
1	I. 0069	1.4	1.02	62.80	1.09	0.68	31.2	38	I. 3551	71.0	45.35	84.52	48.66	41.13	31.2	-63	
2	I. 0140	2.8	2.08	63.24	2.23	1.41	30.5	39	I. 3679	73.6	46.72	85.32	50.13	42.77	30.5	-47	
3	I. 0211	4.2	3.13	63.69	3.36	2.14	29.8	40	I. 3810	76.2	48.10	86.13	51.61	44.45	29.8	-41	
4	I. 0284	5.7	4.21	64.14	4.52	2.90	28.9	41	I. 3942	78.8	49.47	86.96	53.08	46.16	28.9	-35	
5	I. 0357	7.1	5.28	64.60	5.67	3.66	28.1	42	I. 4078	81.4	50.87	87.80	54.58	47.92	28.1	-31	
6	I. 0432	8.6	6.37	65.06	6.84	4.45	27.2	43	I. 4216	84.3	52.26	88.67	56.07	49.72	27.2	-27	
7	I. 0507	10.1	7.45	65.53	7.99	5.24	26.3	44	I. 4356	87.1	53.66	89.54	57.58	51.56	26.3	-23	
8	I. 0584	11.7	8.55	66.01	9.17	6.06	25.1	45	I. 4500	90.0	55.07	90.44	59.09	53.44	25.1	-20	
9	I. 0662	13.2	9.66	66.50	10.37	6.89	24.0	46	I. 4646	92.9	56.48	91.35	60.60	55.36	24.0	-15	
10	I. 0741	14.8	10.77	66.99	11.56	7.74	22.8	47	I. 4796	95.9	57.90	92.28	62.13	57.33	22.8	-14	
11	I. 0821	16.4	11.89	67.49	12.76	8.61	21.5	48	I. 4948	99.0	59.32	93.23	63.65	59.34	21.5	-18	
12	I. 0902	18.0	13.01	68.00	13.95	9.49	20.0	49	I. 5104	102.1	60.75	94.20	65.18	61.40	20.0	-22	
13	I. 0985	19.7	14.13	68.51	15.16	10.39	18.3	50	I. 5263	105.3	62.18	95.20	66.72	63.52	18.3	-27	
14	I. 1069	21.4	15.25	69.04	16.35	11.30	16.6	51	I. 5426	108.5	63.66	96.21	68.31	65.72	16.6	-33	
15	I. 1154	23.1	16.38	69.57	17.53	12.23	14.7	52	I. 5591	111.8	65.13	97.24	69.89	67.96	14.7	-39	
16	I. 1240	24.8	17.53	70.10	18.81	13.19	12.6	53	I. 5761	115.2	66.63	98.30	71.50	70.28	12.6	-49	
17	I. 1328	26.6	18.71	70.65	20.08	14.18	10.2	54	I. 5934	118.7	68.13	99.38	73.11	72.66	10.2	-59	
18	I. 1417	28.3	19.89	71.21	21.34	15.20	7.7	55	I. 6111	122.2	69.65	100.48	74.74	75.10	7.7	..	
19	I. 1508	30.2	21.07	71.78	22.61	16.23	4.8	55	I. 6292	125.8	71.17	101.61	76.37	77.60	4.8	..	
20	I. 1600	32.0	22.25	72.35	23.87	17.27	+ 1.6	57	I. 6477	129.5	72.75	102.77	78.07	80.23	+ 1.6	..	
21	I. 1694	33.9	23.43	72.94	25.14	18.34	- 1.8	58	I. 6667	133.3	74.36	103.95	79.79	82.95	- 1.8	..	
22	I. 1789	35.8	24.61	73.53	26.41	19.42	- 6.0	59	I. 6860	137.2	75.99	105.16	81.54	85.75	- 6.0	..	
23	I. 1885	37.7	25.81	74.13	27.69	20.53	- 11	60	I. 7059	141.2	77.67	106.40	83.35	88.68	- 11	+12.6	
24	I. 1983	39.7	27.03	74.74	29.00	21.63	- 16	61	I. 7262	145.2	79.43	107.66	85.23	91.76	- 16	27.3	
25	I. 2083	41.7	28.28	75.36	30.34	22.87	- 23	62	I. 7470	149.4	81.30	108.96	87.24	95.06	- 23	39.1	
26	I. 2188	43.7	29.53	76.00	31.69	24.08	- 30	63	I. 7683	153.7	83.34	110.29	89.43	98.63	- 30	46.1	
27	I. 2293	45.8	30.79	76.64	33.04	25.32	- 39	64	I. 7901	158.0	85.66	111.65	91.92	102.73	- 39	46.4	
28	I. 2398	47.9	32.05	77.30	34.39	26.58	- 49	64½	I. 7957	159.1	86.33	112.00	92.64	103.65	- 49	43.6	
29	I. 2500	50.0	33.33	77.96	35.75	27.88	- 61	64¾	I. 8012	160.2	87.04	112.34	93.40	104.93	- 61	41.1	
30	I. 2609	52.2	34.63	78.64	37.16	29.22	- 74	64¾	I. 8068	161.4	87.81	112.69	94.23	106.19	- 74	37.9	
31	I. 2719	54.4	35.93	79.33	38.55	30.58	- 82	65	I. 8125	162.5	88.55	113.05	95.13	107.54	- 82	33.1	
32	I. 2832	56.6	37.26	80.03	39.98	32.00	- 96	65½	I. 8182	163.6	89.55	113.40	96.10	108.97	- 96	24.6	
33	I. 2946	58.9	38.58	80.74	41.40	33.42	- 97	65½	I. 8239	164.8	90.60	113.76	97.22	110.60	- 97	13.4	
34	I. 3063	61.3	39.92	81.47	42.83	34.90	- 91	65½	I. 8297	165.9	91.80	114.12	98.51	112.42	- 91	1	
35	I. 3182	63.6	41.27	82.22	44.28	36.41	- 81	66	I. 8354	167.1	93.19	114.47	100.00	114.47	- 81	-29	
36	I. 3303	66.1	42.63	82.97	45.74	37.95	- 70										

Below
— 40

* Calculated from Pickering's results, Journal of London Chemical Society, vol. 57, p. 363.

Approximate Boiling Points

50° Bé.,	295° F.
60° "	386° "
61° "	400° "
62° "	415° "
63° "	432° "
64° "	451° "
65° "	485° "
66° "	538° "

Allowance for Temperature

At 10° Bé.,	-0.29° Bé. or .00023 Sp. Gr. =	1° F.
" 20° "	-.036° "	" = 1° "
" 30° "	-.035° "	" = 1° "
" 40° "	-.031° "	" = 1° "
" 50° "	-.028° "	" = 1° "
" 60° "	-.026° "	" = 1° "
" 63° "	-.026° "	" = 1° "
" 66° "	-.0235° "	" = 1° "

Specific Gravity determinations were made at 60° F., compared with water at 60° F.

From the Specific Gravities, the corresponding degrees Baumé were calculated by the following formula:

$$\text{Baumé} = 145 - \frac{145}{\text{Sp. Gr.}}$$

Baumé Hydrometers for use with this table must be graduated by the above formula, which formula should always be printed on the scale.

$$66^\circ \text{ Baumé} = \text{Sp. Gr. } 1.8354.$$

1 cu. ft. water at 60° F. weighs 62.37 lbs. av.

Atomic weights from F. W. Clarke's table of 1901. O = 16.

H₂SO₄ = 100 per cent.

O. V.	H ₂ SO ₄	O. V.	60°
60°	93.19	100.00	119.98
50°	77.67	83.35	100.00
	62.18	66.72	80.06

Acids stronger than 66° Bé. should have their percentage compositions determined by chemical analysis.

AUTHORITIES. — W. C. FERGUSON; H. P. TALBOT.

The above table was prepared under the supervision of the Manufacturing Chemists Association of the United States and adopted by the Association as standard for United States practice. Reprints of each table may be obtained from the Secretary of the Association, 84 State St., Boston.

COMPARISON OF METRIC AND CUSTOMARY UNITS FROM 1 TO 9

1. LENGTH

Inches (in.)	Millimeters (mm.)	Feet (ft.)	Meters (m.)	Yards (yd.)	Meters (m.)
0.039 37=1		1=0.304 801		1=0.914 402	
0.078 74=2		2=0.609 601		2=1.828 804	
0.118 11=3		3=0.914 402		3=2.743 205	
0.157 48=4		4=1.219 202		4=3.657 607	
0.196 85=5		5=1.524 003		5=4.572 009	
0.236 22=6		6=1.828 804		6=5.486 411	
0.275 59=7		7=2.133 604		7=6.400 813	
0.314 96=8		8=2.438 405		8=7.315 215	
0.354 33=9		9=2.743 205		9=8.229 616	
1= 25.4001		3.280 83=1		1.093 611=1	
2= 50.8001		6.561 67=2		2.187 222=2	
3= 76.2002		9.842 50=3		3.280 833=3	
4=101.6002		13.123 33=4		4.374 444=4	
5=127.0003		16.404 17=5		5.468 056=5	
6=152.4003		19.685 00=6		6.561 667=6	
7=177.8004		22.965 83=7		7.655 278=7	
8=203.2004		26.246 67=8		8.748 889=8	
9=228.6005		29.527 50=9		9.842 500=9	

2. AREA

Square inches (sq. in.)	Square centimeters (cm. ²)	Square feet (sq. ft.)	Square meters (m. ²)	Square yards (sq. yd.)	Square meters (m. ²)
0.155 00=1		1=0.092 90		1=0.8361	
0.310 00=2		2=0.185 81		2=1.6723	
0.465 00=3		3=0.278 71		3=2.5084	
0.620 00=4		4=0.371 61		4=3.3445	
0.775 00=5		5=0.464 52		5=4.1807	
0.930 00=6		6=0.557 42		6=5.0168	
1.085 00=7		7=0.650 32		7=5.8529	
1.240 00=8		8=0.743 23		8=6.6890	
1.395 00=9		9=0.836 13		9=7.5252	
1= 6.452		10.764=1		1.1960=1	
2=12.903		21.528=2		2.3920=2	
3=19.355		32.292=3		3.5880=3	
4=25.807		43.055=4		4.7839=4	
5=32.258		53.819=5		5.9799=5	
6=38.710		64.583=6		7.1759=6	
7=45.161		75.347=7		8.3719=7	
8=51.613		86.111=8		9.5679=8	
9=58.065		96.875=9		10.7639=9	

3. VOLUME

Cubic inches (cu. in.)	Cubic centimeters (cm. ³)	Cubic feet (cu. ft.)	Cubic meters (m. ³)	Cubic yards (cu. yd.)	Cubic meters (m. ³)	Cubic inches (cu. in.)	Liters (l.)	Cubic feet (cu. ft.)	Liters (l.)
0.061 02=1			1 =0.028 317		1 =0.7646		1 =0.016 386 7		1 = 28.316
0.122 05=2			2 =0.056 634		2 =1.5291		2 =0.032 773 4		2 = 56.633
0.183 07=3			3 =0.084 951		3 =2.2937		3 =0.049 160 2		3 = 84.949
0.244 09=4			4 =0.113 268		4 =3.0582		4 =0.065 546 9		4 =113.265
0.305 12=5			5 =0.141 585		5 =3.8228		5 =0.081 933 6		5 =141.581
0.366 14=6			6 =0.169 902		6 =4.5874		6 =0.098 320 3		6 =169.898
0.427 16=7			7 =0.198 219		7 =5.3519		7 =0.114 707 0		7 =198.214
0.488 19=8			8 =0.226 536		8 =6.1165		8 =0.131 093 8		8 =226.530
0.549 21=9			9 =0.254 853		9 =6.8810		9 =0.147 480 5		9 =254.846
1 = 16.3872		35.314= 1		1.3079= 1		61.025= 1		0.035 315= 1	
2 = 32.7743		70.629= 2		2.6159= 2		122.050= 2		0.070 631= 2	
3 = 49.1615		105.943= 3		3.9238= 3		183.075= 3		0.105 946= 3	
4 = 65.5486		141.258= 4		5.2318= 4		244.100= 4		0.141 262= 4	
5 = 81.9358		176.572= 5		6.5397= 5		305.125= 5		0.176 577= 5	
6 = 98.3230		211.887= 6		7.8477= 6		366.150= 6		0.211 892= 6	
7 =114.7101		247.201= 7		9.1556= 7		427.175= 7		0.247 208= 7	
8 =131.0973		282.516= 8		10.4635= 8		488.200= 8		0.282 523= 8	
9 =147.4845		317.830= 9		11.7715= 9		549.225= 9		0.317 839= 9	

4. CAPACITY

LIQUID MEASURE								DRY MEASURE	
U. S. fluid ounces (fl. oz.)	Milli- liters (ml.)	U. S. liquid pints (pt.)	Liters (l.)	U. S. liquid quarts (qt.)	Liters (l.)	U. S. gallons (gal.)	Liters (l.)	U. S. dry quarts (qt.)	Liters (l.)
0.033 815=1		1 =0.473 17		1 =0.946 33		0.264 18=1		0.9081=1	
0.067 629=2		2 =0.946 33		2 =1.892 67		0.528 36=2		1.8162=2	
0.101 444=3		3 =1.419 50		3 =2.839 00		0.792 53=3		2.7243=3	
0.135 259=4		4 =1.892 67		4 =3.785 33		1.056 71=4		3.6324=4	
0.169 074=5		5 =2.365 83		5 =4.731 67		1.320 89=5		4.5405=5	
0.202 888=6		6 =2.839 00		6 =5.678 00		1.585 07=6		5.4486=6	
0.236 703=7		7 =3.312 17		7 =6.624 33		1.849 24=7		6.3567=7	
0.270 518=8		8 =3.785 33		8 =7.570 66		2.113 42=8		7.2648=8	
0.304 333=9		9 =4.258 50		9 =8.517 00		2.377 60=9		8.1729=9	
1 = 29.573		2.1134= 1		1.056 71= 1		1 = 3.785 33		1 =1.1012	
2 = 59.146		4.2268= 2		2.113 42= 2		2 = 7.570 66		2 =2.2024	
3 = 88.719		6.3403= 3		3.170 13= 3		3 =11.356 00		3 =3.3036	
4 =118.292		8.4537= 4		4.226 84= 4		4 =15.141 33		4 =4.4048	
5 =147.865		10.5671= 5		5.283 55= 5		5 =18.926 66		5 =5.5060	
6 =177.437		12.6805= 6		6.340 26= 6		6 =22.711 99		6 =6.6072	
7 =207.010		14.7939= 7		7.396 97= 7		7 =26.497 33		7 =7.7084	
8 =236.583		16.9074= 8		8.453 68= 8		8 =30.282 66		8 =8.8096	
9 =266.156		19.0208= 9		9.510 39= 9		9 =34.067 99		9 =9.9108	

5. MASS

Troy ounces (oz. t.)	Grams (g.)	Avoirdupois ounces (oz. av.)	Grams (g.)	Avoirdupois pounds (lb. av.)	Kilo- grams (kg.)
0.032 151=	1	0.035 274=	1		1 =0.453 59
0.064 301=	2	0.070 548=	2		2 =0.907 18
0.096 452=	3	0.105 822=	3		3 =1.360 78
0.128 603=	4	0.141 096=	4		4 =1.814 37
0.160 754=	5	0.176 370=	5		5 =2.267 96
0.192 904=	6	0.211 644=	6		6 =2.721 55
0.225 055=	7	0.246 918=	7		7 =3.175 15
0.257 206=	8	0.282 192=	8		8 =3.628 74
0.289 357=	9	0.317 466=	9		9 =4.082 33
1 = 31.103		1 = 28.350		2.204 62 =	1
2 = 62.207		2 = 56.699		4.409 24 =	2
3 = 93.310		3 = 85.049		6.613 87 =	3
4 = 124.414		4 = 113.398		8.818 49 =	4
5 = 155.517		5 = 141.748		11.023 11 =	5
6 = 186.621		6 = 170.097		13.227 73 =	6
7 = 217.724		7 = 198.447		15.432 36 =	7
8 = 248.828		8 = 226.796		17.636 98 =	8
9 = 279.931		9 = 255.146		19.841 60 =	9

From Circular No. 47, U. S. Bureau of Standards.

INDEX

A

- Abietic acid, 265
- Absorbency of papers, 410
- Acid colors, 320
 - in paper, determination of, 422
 - sulphite cooking liquor, 160
 - effect on metals, 178
 - strength of, 176, 184, 190
 - systems of making, 169
 - testing, 209
 - thiosulphuric acid in, 166
- Acids, action on cellulose, 8
- Adansonia, 40
- Adhesives for coating, 328, 331, 333, 343, 345
- Albumen, 343
- Alcohol from soda cooks, 117
 - sulphate process, 147
 - sulphite process, 198, 205
- Alder, 62
- Alkali cellulose, 20
- Alum, 269, 277
 - amount necessary in sizing 270, 280
 - cake, composition, 278
 - composition, 279
 - decomposition by cellulose, 7
 - effect on glue, 259
 - free acid in, 280
 - iron in, 279
 - manufacture, 278
 - method of adding to beaters, 281
 - substitutes, 269
 - testing, 282, 286
 - use in clarifying water, 359
- Aluminum resinate, 269
 - sulphate (table), 444, 445
- Ammonia (table), 464
- Analyses, see Testing

- Aniline dyes, 313
 - absorption by fillers, 314
 - adding to beaters, 317
 - classification of, 317
 - dissolving, 317
 - mordants for, 316
- Annatto, 313
- Antichlors, 244
- Antifroth oils, 329, 349
- Appendix, 444
- Asbestine, 301
- Ash, determination in papers, 414
 - in fibrous materials, 415
 - qualitative analysis of, 416
- Ashcroft tester, 406
- Asparagus for pulp, 44
- Aspen, 61

B

- Bache-Wiig process for ground wood, 222
- Backwater, use in bleaching, 239
- Bagasse, 43
- Balm of Gilead, 61
- Bamboo, 43, 86
 - composition of, 87
 - pectose in, 93
 - treatment recommended, 87
 - yield of stems per acre, 86
 - fibre, 87
- Bark, 55
 - in soda process, 95
 - sulphite process, 158
- Barker acid system, 173
- Barkers, 158
- Barytes, 346
- Basic colors, 318
- Basswood, 65

- Bast fibres, 37
- Baumé and specific gravity (table), 459-461
- Beating test for wood pulps, 372
- Beech, 62
- Binder from sulphite waste liquor, 201
- Birches, 61
- Bisulphites (see also acid), 160
losses in preparing, 176
- Black ash, 133
furnaces, 132, 149
leaching tanks, 133
waste, 135
testing, 140
- Black gum, 65
- Black liquor, 123
composition of, 123, 127, 147
evaporation of, 127
table, 444
testing, 139
use in sulphate process, 142
utilization of, 125
- Blanc fixe, 346
- Bleach required by fibres, 123, 380, 381
water, 354
- Bleached pulp, blueing of, 253
color change on storing, 254
oxycellulose in, 252
washing, 246
- Bleaching, 225
apparatus, 240
determination of degree of, 11
Dobson process, 242
effect of acid, 240, 242
temperature, 234
on chemical properties, 251
strength of fibres, 249, 250
ground wood, 244
Hermite process, 233
jute, 243
principles of, 234
rate of color change, 239
systems, 241
use of antichlors, 244
backwater, 239
weight lost on bleaching, 236
- Bleaching with chlorine gas, 226
permanganates, 247
peroxides, perborates, etc., 249
- Bleaching powder, 228
action on metals, 231
deterioration, 229, 231
dissolving, 230
sludge from, 230
testing, 254
- Blow pits, 194
tanks, 118
- Blowing down pressure, 193
- Boiler compounds, 356
scale, 355
- Boiling wood for grinding, 219
- Bricks for digester linings, 181.
- Bright's method for unbleached sulphite, 393
- Bulk of fibrous materials, 65
paper, determining, 400
- Bulker, pressure, 401
- Burgess acid system, 173
- Bursting strength of paper, 404
- C
- Calcium hypochlorite, color of solutions, 232
solid, 232
- Calender staining, 321
- Casein, composition, 334
detection in paper, 418
deterioration of, 339
determination in paper, 425
influence on penetration of oil, 328
insoluble matter in, 337
molding of, 337
preservation of solutions, 338
properties and preparation, 333
sizing, 286
soluble, 335
solvents, 336
testing, 339
waterproofing, 338, 339
- Cattle feed from waste sulphite liquor.

- Causticity of soda cooking liquor, 109
 Causticizing methods, 98
 Cell, structural unit of plant, 34
 Cellulose, 1
 acetates, 17
 action of salts on, 7
 and acids, 8
 alkalis, 9, 20
 ferments, 12
 water, 3
 benzoates, 19
 chlorinated, 251
 commercial meaning, 2
 composition and constitution, 2
 compound, 23
 compounds of, 13
 copper number of, 11, 252
 cuto-, 23
 decomposition of, 8, 12
 destructive distillation of, 13
 determination of, 27
 esters, 18, 19
 formates, 19
 groups of, 22
 hydrates, 4
 ligno-, 24, 156
 nitrates, 13
 nitrites, 17
 normal moisture, 4
 oxidation of, 10
 pecto-, 23
 peroxide, 11
 physical properties, 1
 solvents for, 5
 sulpho-carbonate, 20
 xanthate, 20
 Cement for digester linings, 180
 Chardonnet silk, 15
 Chestnut, 62
 Chips, length of, 159
 Chlorinated cellulose, 251
 Chlorine gas, 225
 in bleached fibre, 252
 in paper, 421
 preparation by electrolysis, 232
 Chrome yellow, 310
 Clark process for water softening, 357
 Clay, 294
 composition of, 295
 fineness of particles, 296
 for coating, 345
 specific gravity, 297
 testing, 297, 302
 Coated paper, 325
 body stock for, 326
 brittleness of, 440
 finish on, 329
 picking of, 328
 printing qualities, 330, 344
 waterproof, 338
 Coating, coloring of, 321
 determining amount on paper, 424
 glycerine in, 329, 349
 method of applying, 326
 minerals used, 328
 oils, soaps and waxes, 329
 Cochineal, 313
 Color standards for bleached pulp, 379,
 381
 water, 362
 Coloring, 306
 comparing colors, 307
 matching shades, 306
 mineral colors, 308, 310
 mordants, 316
 organic colors, 313
 pigments, 308
 vulcanized fibre, 323
 Colors, acid, 320
 basic, 318
 direct cotton, 317
 eosines and rhodamines, 319
 pigments, 308
 testing, 322
 Combustion chamber, 166
 Cooking liquor, testing, 137, 152, 209
 Cooking sulphite, following progress in,
 191
 irregularities in, 191
 Mitscherlich process, 183
 precautions, 186
 recording conditions, 187

- Cooking sulphite, Ritter-Kellner process, 184
 schedules for, 186
 superheated steam for, 185
 Coolers for sulphur dioxide, 168
 Copper number of cellulose, 11, 252
 Corn stalks, 43
 Cotton, 36
 Cotton stalks, 44
 Cottonwood, 61
 Cucumber tree, 63
 Cuprammonium hydrate cellulose, 5
 Cutch, 313
 Cuto-cellulose, 23
 Cutter for sampling wood pulps, 369
 Cutting press for color disks, 376
 Cymene, 198
- D
- Daylight lamps, 307, 375, 379
 Decay of wood, 56
 effect on soda process, 95
 Defects in printing, 435
 Densities of soda stock, 122
 stock in bleaching, 234, 241
 sulphite stock, 195
 Digesters, soda, 97, 98
 sulphate, 142
 sulphite, 178
 bronze, 179
 Mitscherlich, 183
 Salomon-Brünger, 179
 sizes of, 181
 Direct cotton colors, 317
 Dirt in pulps, 383
 Disk machine for color comparisons, 376
 District of Columbia paper tester, 405
 Dobson bleaching process, 242
 Dolomite for acid making, 174
 Dorr causticizing process, 100
 Douglas spruce, 60
 Drying sized papers, 273
 Ducts, proportion to fibres, 392
- E
- Eau de Javel, 227
 Electrolyzing salt, 232
 Electrolytic bleach, 233
 Electrotypes, 431
 Elements, table of physical constants, 448-453
 Enderlein's evaporator, 128
 Enge process for ground wood, 223
 Eosines, 319
 Esparto, 42, 77
 alkali required, 78
 bleaching fibre from, 79
 boilers, 78
 bulk of, 66
 cooking conditions, 79
 dust, 77
 recovery of alkali, 79
 Evaporators, Enderlein's, 128
 Gorion, 127
 Yargan, 128
 Zarembo, 131
- F
- Ferments, action on cellulose, 12
 Fert ilizer from waste sulphite liquor, 202
 Fibre length of woods, 49
 Fibres, estimation in paper, 387
 by method of Spence and Krauss, 392
 Fibrous materials, bulk of, 65
 Fillers, 290
 absorption of dyes by, 314
 effect on sizing, 290
 effect on strength of paper, 290
 losses in process, 293
 materials used, 291
 retention of, 292, 417
 testing, 302
 Filters, 358
 Firs, 58
 Folding endurance of paper, 406
 Formaldehyde in coatings, 338
 Freeman process for soda cooks, 115
 Fuel from waste sulphite liquor, 203

- Furfural, 11
 Furnaces, recovery, 132, 149
- G
- Gas bleaching, 226
 pressure in sulphite cooks, 188
 relieving, 189
 recovery, 192
 Gelatine, 258
 testing, 261, 332
 Glarimeter, 402
 Gloss of paper, 402
 Glue, 258
 detection of, 419
 determination of, 425
 for coating, 331
 sizing, 287
 Glycerine in coating, 329, 349
 Grease-proof qualities of paper, 412
 Grinders for wood pulp, 212, 213
 Groundwood pulp, 212
 Bache-Wiig process, 222
 bleaching, 224
 condition of stone, 216
 wood, 218
 efficiency of grinding, 219
 estimation in paper, 427
 from boiled or steamed wood, 219
 in print papers, 89
 sand settlers, 214
 screens for, 213
 speed of stones, 217
 stones for making, 212
 temperature of grinding, 218
 testing, 223
 woods for, 221
 Gun-cotton, 15
 Gypsum, 298
- H
- Halftone plates, 430
 standard depths, 431
 screens for different papers, 433
 Hardness in water, cause, 353
 determining, 364
 effect on sizing, 353
- Heartwood, 49
 Heavy spar, 301
 Hemlock, 60
 Hemp, 38
 Hermite electrolytic bleach process, 233
 Herreshoff pyrites burner, 166
 Herzberg stain, 389
 Hydrocellulose, 4, 8
 Hydrochloric acid (table), 462
 Hypochlorites, 226, 233
 Hypochlorous acid, 227
- I
- Incinerating furnaces, 132, 149
 Indanthrenes, 321
 Ingersoll glarimeter, 402
 Ink, choice of, 434
 double tone, 442
 drying, 438
 for sizing test, 413
 mottling of, 441
 offsetting, 437
- J
- Jute, 39
 bleaching, 243
- K
- Knots, 56, 94, 159
 Kraft fibre, 141
- L
- Lamp black, 312
 Larch, 60
 Leaching tanks for black ash, 133
 Lignin, 25, 35, 157
 reactions with sulphurous acid, 157
 sulphonic acid, 157
 Ligno-cellulose, 24, 156
 Lime, 175
 for causticizing, 103
 rag boiling, 72
 mud testing, 138
 recovery in soda process, 102

- Lime, slaking, 175
 testing, 138
 waste, 102
- Limestone for acid towers, 170
- Linen, 37
- Linings for sulphite digesters, 178
- Lithography, 432
 smutting of ink, 440
- Loading and filling, 290
- Loft drying, 260
- Logwood, 313
- M
- Machine direction, 395
- Magazine grinder, 213
- Manila hemp, 39
 bleaching, 243
- Maples, 64
- Mechanical pulp, 212
- Melt from sulphate recovery, 150
- Mercaptans, 146
- Metric and ordinary units (table), 466-468
- Microscopic examination of paper, 386
- Milk of lime acid systems, 173
- Mineral colors, 308, 310
- Mitscherlich acid tower, 169
 cooking process, 183
 digester lining, 179
 sizing process, 288
- Moisture estimation in lap pulp, 371
 paper, 414
 wood pulps, 368
- Monosulphite of calcium, 171, 176, 177, 192
- Mordants, 316
- Mortrud digester, 97
- Mullen tester, 405
- Multiple effect evaporation, 128
- N
- Newspaper, fibre from, 90
- Nitric acid (table), 463
- Nitro-cellulose, 13

O

- Ochres, 309
- Odors from sulphate cooks, 142, 146, 151
- Offsetting, 437
- Opacity of paper, 400
- Oxide colors, 309
- Oxycellulose, 10, 252

P

- Padding, 321
- Paper, recovering fiber from printed, 88
- Paper mulberry, 41
 scales, 397, 398
- Paper testing, 386
 absorbency, 410
 acidity, 422
 ash, 414
 bulk, 400
 bursting strength, 404
 chlorine, 421
 coating, 424
 fibre content, 387
 folding endurance, 406
 gloss, 402
 grease-proof qualities, 412
 groundwood pulp, 427
 machine direction, 395
 microscopic examination, 386
 moisture, 414
 opacity, 400
 paraffin, 421
 permeability to air, 411
 physical tests, 395
 retention of filler, 417
 rosin estimation, 420
 sizing, 412, 417
 stretch, 404
 sulphur, 422
 tearing strength, 409
 tensile strength, 403
 thickness, 399
 unbleached sulphite, 393, 426
 volumetric composition, 411
 weight per ream, 397
 wire side, 396
- Papyrus, 44

- Paraffin, determination in paper, 421
 Parchment paper, 6
 Pea vines, 44
 Pearl hardening, 299
 Peat, 45
 Pebble mills, 373
 Pecto-cellulose, 23
 Pectose, 93
 Perborates in bleaching, 249
 Permanganate bleaching, 247, 252
 Permeability of paper, 411
 Permutite water softening process, 358
 Peroxides in bleaching, 249
 Picking of coated papers, 328, 439
 Pigments, 308
 Pimaric acid, 265
 Pines, 59
 Pitch from waste sulphite liquor, 202
 Poplar, 61
 Porion evaporator, 127
 Precipitated chalk, 300
 Preston lining, 180
 Printing, 429
 defective, 435
 inks, 434
 paper for different types of, 432
 Print-papers, 88
 Prussian blue, 311
 Pyrites, 161, 166
 burner, 166
- Q
- Quercitron, 313
- R
- Rags, alkali used in boiling, 71
 bleaching, 240
 boilers for, 73
 boiling, 70
 bulk of, 65
 dusting and sorting, 70
 grades of, 68
 lime for boiling, 72
 losses in treating, 76
 starch in, 72
 washing of boiled, 75
- Recovery of sulphur dioxide, 192
 Redwoods, 313
 Register in printing, 442
 Relieving digesters, 103, 117, 189
 Resins in plant cells, 35
 woods, 53
 rubber, 288
 Retention of fillers, 292
 Rhodamines, 319
 Rinman's black liquor process, 125,
 148
 Ritter-Kellner acid towers, 170
 cooking method, 184
 Rosin, amount used in paper, 271
 detection in paper, 419
 determination in paper, 420
 extraction from stumps, 265
 in sulphite pulps, 195
 properties of, 264
 recovery from soda cooks, 117
 size making, 265
 testing, 275
 Rosin sizing, 264
 additions to, 267
 and hard water, 272
 composition, 266
 defects, 274
 effect of sunlight, 275
 emulsifier for, 268
 precipitation of, 269
 troubles, 272
 Rotogravure process, 433
 Rubber resins for sizing, 288
 Rushes, 43
- S
- Safflower, 313
 Salomon-Brünger digester, 179
 Sand settlers, 122
 Sapwood, 49
 Satin white, composition, 347
 preparation, 348
 Schopper folding machine, 407
 tensile machine, 404
 Sedimentation test, 383
 Seed hairs, 36

- Sizing (see also Rosin), 257
 alum used, 277
 casein, 286
 defects of, 274
 determining degree of, 412
 kind of, 417
 effect of drying, 273
 filler, 272, 291
 hard water, 353
 sunlight on, 275
 from sulphite waste liquor, 203
 glue, 287
 ink for testing, 413
 Mitscherlich process, 288
 reactions in, 270
 requirements of different papers, 257
 rosin, 264
 rubber resins, 288
 silicate-starch, 263
 starch, 262
 surface or tub sizing, 258
 viscose, 287
- Smelting furnaces, 149
- Soap in coating, 329, 349
 tub sizing, 259
- Soda process, 93
 alkali required, 115
 black liquor, 110, 123
 boiling operations, 103
 caustic soda consumed, 112
 circulation of liquor, 103
 cooking liquor preparation, 98
 digesters, 97, 98
 discharging digesters, 118
 effect of caustic added, 107
 causticity of liquor, 109
 concentration of liquor, 106
 steam pressure, 104
 time under pressure, 108
 lime recovery, 102
 liquor per cord, 103
 loss of fibre, 122
 modified forms, 115, 116
 principles of, 93
 rate of reaction, 110
 relief of digesters, 103, 117
- Soda process, rosin recovery, 117
 soda losses, 135
 recovery, 126
 steam lost on blowing, 119
 required, 104
 sulphur in, 115
 wash pits, 119
 washing black stock, 120
 wood preparation, 95
 woods used, 94
 yields from various woods, 114
- Soda lost in process, 135
 recovery, 126
- Sodium carbonate (tables), 457, 458
 chloride (table), 456
- Specific gravity and Baumé (table),
 459-461
- Spruces, 58
- Starch, detection in paper, 418
 for coating, 343
 sizing, 262
 modified, 344
 retention, 263
- Starch-iodide indicator, 256
- Steam lost on blowing digesters, 119
 required in soda cooks, 104
 sulphite cooks, 185
- Steaming wood, 220
- Straw, 41, 80
 alkali recovery, 85
 boards, 81
 bulk of, 66
 cellulose, 84
 chlorination of, 86
 composition of, 80
 cooking, 81, 83, 86
 packing in boilers, 82
 retting, 86
- Stretch of papers, 404
- Stuffing, 321
- Sudan III, 35
- Sulphate process, 141
 black liquor, 147
 by-products from, 148
 composition of liquor, 144
 cooking, 143

- Sulphate process, digesters, 142
 odors from, 142, 146, 151
 recovered ash, 150
 recovery furnaces, 149
 smelting furnaces, 149
 soda recovery, 149
 value of alkalis, 143
 yields, 145
- Sulphite acid (see Acid)
 fibre, composition of, 195
 process, 156
 absorption apparatus, 168
 cooking, 183, 191
 digesters and linings, 178
 modified processes, 197
 pumping acid, 177
 reactions of liquor making, 160
 storing acid, 177
 sulphur dioxide preparation, 161
 theory of, 156
 woods for, 157, 160
 "turpentine," 198
 waste liquor, 198
 alcohol from, 205
 cattle feed from, 203
 composition of, 199
 destructive distillation, 204
 fertilizer from, 202
 fuel from, 204
 pitch from, 202
 sizing, 203
 tanning materials from, 204
 testing, 210
 use as binder, 201
 volume obtainable, 200
- Sulphur, 161
 determination in paper, 422
 in soda cooks, 115
 per ton of sulphite, 193
 sublimation, 166
 testing, 207
 use of molten, 162
- Sulphur burners, 162
 air supply, 165
 automatic feed, 162
 color of flame, 166
 Sulphur burners, flat, 162
 rotary, 162
 temperatures in, 165
 Vesuvius, 163
- Sulphur dioxide (table), 446
 absorption apparatus, 168
 cooling, 165, 168
 preparation, 161
 recovery, 192
 solubility in water, 168, 446
 testing, 208
- Sulphur trioxide in burner gases, 165
- Sulphuric acid (table), 465
 and cellulose, 6
- Sunlight, effect on sizing, 275
- Superheated steam for sulphite cooking, 185
- Sweet gum, 63
- Sycamore, 64
- Sylvic acid, 265
- T
- Tables: Aluminum sulphate, 444, 445
 Ammonia, 464
 Baumé and specific gravity, 459-461
 Black liquor, 444
 Hydrochloric acid, 462
 Metric and ordinary units, 466-468
 Nitric acid, 463
 Physical constants of the elements, 448-453
 Sodium carbonate, 457, 458
 Sodium chloride, 456
 Sulphur dioxide solubility, 446
 Sulphuric acid, 465
 Temperature conversions, 447
 Vapor pressure of water, 454
- Talc, 300
- Tank systems for acid making, 171
- Tanning material from waste sulphite liquor, 204
- Tearing test for paper, 409
- Temperature comparisons (table), 447
- Tensile strength of paper 403

- Testing acid, 209
 alum, 282, 286
 black ash and black ash waste, 140
 black liquor, 139
 bleaching powder, 254
 burner gases, 208
 caseines, 339
 clay, 297, 302
 colors, 322
 cooking liquor, 137, 152, 209
 fillers, 302
 gelatine and glue, 261, 332
 groundwood pulp, 223
 lime, 138
 lime mud, 138
 paper, 386
 rosin and rosin size, 275
 soda ash, 137
 sulphur, 207
 waste sulphite liquor, 210
 water, 359
 wood pulp, 368
 Thickness of paper, 399
 Thiosulphuric acid in sulphite liquor,
 166
 Three color work, 431
 non-register, 442
 Thwing tearing tester, 409
 Tower systems of acid making, 169
 comparison with milk of lime sys-
 tems, 175
 difficulties in operating, 171
 Tracheids, 45
 Tub sizing with gelatine, 258
 starch, 262
 Tuliptree, 63
 Turmeric, 313
 Turpentine, sulphite, 198
- U
- Ultramarine, 311
 Umber, 309
 Unbleached sulphite estimation, 393,
 426
 Ungerer's cooking process, 143
- V
- Vapor pressure of water (table), 454
 Venetian red, 309
 Viscose, 20, 287
 silk, 21
 Volume composition of paper, 411
 Vulcanized fibre, colors for, 323
- W
- Wash pits for soda fibre, 119
 Washing black stock, 120
 bleached pulp, 246
 rag stock, 75
 sulphite fibre, 194
 Water, 351
 alum treatment, 359
 analysis, 359
 bleach consumed by, 354
 classification of, 352
 filtration, 358
 for dyeing, 316
 iron in, 353
 requirements in paper making, 75,
 351, 353
 sampling, 360
 scale from, 355
 soft and hard, 352, 364
 softening, 356
 suspended matter in, 354, 363
 Waterproof coated paper, 338, 343
 Waxes in coating, 329, 349
 Weight per ream, 397
 Weld, 313
 Wilesden products, 6
 Winestock process for old papers, 90
 Wire side of paper, 396
 Witherite, 301
 Wood, 45
 barking, 158
 capacities of machinery for handling,
 160
 chipping, 159
 decay of, 56
 fibre length, 49

- fibres, 45
 - for grinding, 221
 - kinds used, 57
 - moisture in, 51
 - preparing, 94, 157
 - proximate analysis, 54
 - requirements for sulphite process, 157
 - resins in, 53
 - weight per cord, 66, 114
 - cubic foot, 52
 - Wood pulp testing, 368
 - beating test, 372
 - bleaching qualities, 380
 - borer for sampling, 369
 - color comparisons, 375
 - Wood pulp testing, dirt count, 383
 - loss in weight on bleaching, 382
 - moisture determinations, 368
 - sedimentation test, 383
- Y
- Yaryan evaporators, 128
 - capacities, 132
- Z
- Zacaton, 44
 - Zaremba evaporator, 131
 - Zinc chloride and cellulose, 5

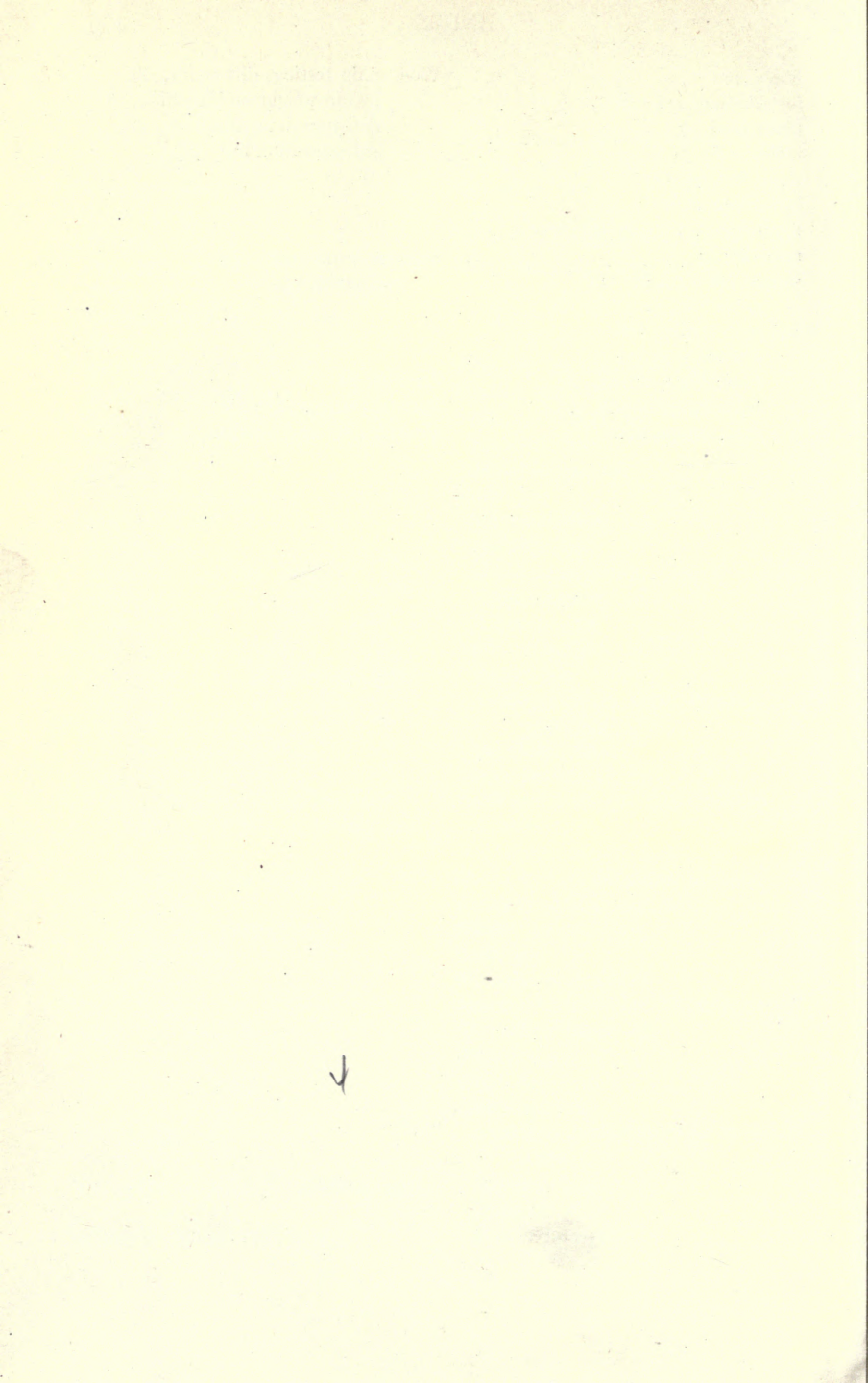

THIS BOOK IS DUE ON THE LAST DATE
STAMPED BELOW

AN INITIAL FINE OF 25 CENTS
WILL BE ASSESSED FOR FAILURE TO RETURN
THIS BOOK ON THE DATE DUE. THE PENALTY
WILL INCREASE TO 50 CENTS ON THE FOURTH
DAY AND TO \$1.00 ON THE SEVENTH DAY
OVERDUE.

SEP 18 1945

LIBRARY USE

MAR 20 1954

23 Apr '57 KE

SIBARANI

MAY 23 1957 (11)

REC'D LD

MAY 23 1957

24 Jun '57 GB

Fernandez

JUL 24 1957 (8)

REC'D LD

JUL 25 1957

11 May '60 FW

REC'D LD

MAY 11 1960

2 Jun '60 FW

REC'D LD

JUN 6 1960

YL 75743

500
80

4000

428725

TS

M05

S05

THE UNIVERSITY OF CALIFORNIA LIBRARY

