

A decorative, ornate frame with a crown-like top and a pointed bottom. Inside the frame, the text "The CINDERELLAS of the FLEET" is centered. Below the text, three stylized sailing ships are arranged: one on the left, one in the center, and one on the right. The ships are depicted from a side-on perspective, showing their masts and rigging. The entire design is rendered in a light, possibly embossed or printed, style against a dark background.

The
CINDERELLAS
of the
FLEET





Digitized by the Internet Archive
in 2011 with funding from
LYRASIS members and Sloan Foundation

T TRAGLE
211 FLORENCE DR.
HAMPTON, VA. 23666

The
CINDERELLAS
of the
FLEET

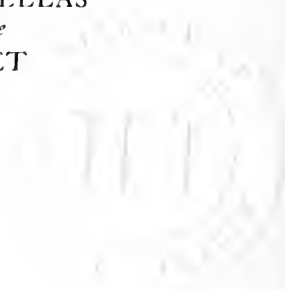



Painted by John Olaf Todahl

The Submarine Chasers.

The
CINDERELLAS
of the
FLEET

By
WILLIAM WASHBURN NUTTING
Lieut. j. g. (C. C.) U. S. N. R. F.

With stories and photographs
by

Walter P. Groszman, Lieut., U. S. N. R. F.
Herbert L. Stone, Lieut., U. S. N. R. F.
Joseph L. Day, Lieut., U. S. N. (T)
George S. Dole, Lieut. j. g., U. S. N. R. F.
Maclear Jacoby, Lieut. j. g., U. S. N. R. F.
George N. Wallace, Ensign, U. S. N. R. F.
Henry Bonnell, Ensign, U. S. N. R. F.
Maurice P. Shea, Lieut., R. N. V. R.
Gordon S. Maxwell, Lieut., R. N. V. R.
Bewick S. Cawthorn, Lieut., R. N. V. R.
and Frontispiece
by
JOHN OLAF TODAHL

Published by
THE STANDARD MOTOR CONSTRUCTION CO.
JERSEY CITY, N. J.

Copyright, 1920
by
THE STANDARD MOTOR CONSTRUCTION CO.

PREFACE

THIS LITTLE BOOK does not pretend to be a history of anti-submarine warfare. Neither is it a scientific treatise on the instruments and methods used in this the newest phase of naval fighting. On the other hand, I am afraid there is all too little in it of the romantic personal element, in which a war fought largely by kid reservists in small boats is bound to be rich. It is the story of an idea and how it grew in the face of indifference and ridicule to a success as unexpected by the regular Navy as it was by the average layman. It is the story of the Submarine Chasers.

Without wishing to underrate the part played in the war by the high-seas fleets of Great Britain and our own country, we may say that their part was largely a potential one. The actual work of strafing the U-boat, which was the big job of the war, was done by the scrubs—the destroyers, the yachts, the trawlers, the drifters, the motor craft, that Rudyard Kipling so aptly dubbed “The Fringes of the Fleet.”

When the war cloud burst over Europe the submarine was the big, new, practically untried instrument of naval warfare, to which the Germans, foiled in their attempt to terminate the conflict in a single, rapid thrust, looked to isolate England and to bring down the mighty British Fleet, bit by bit, to the level of their own. No weapon had yet been devised to counter it nor any successful method of fighting it evolved. Its success was appalling and to make matters worse, it seemed to evolve and multiply much more rapidly than the means and methods of combatting it.

But gradually, out of the chaos and the experience dearly bought with countless lives and scores of ships, there was evolved a method of defense against the submarine and then a method of aggressive warfare, with specially designed boats and numerous and elaborate instruments for apprehending and destroying the tin shark.

Possibly we are still a little too close to the war to pick out of the welter of unheard-of things and stupefying events those which were really important, but as time goes on the last five years gradually will

resolve themselves into a few salient, outstanding facts, just as wars always have done since the beginning of time. To many people the scrap between the Monitor and the Merrimac is the only thing that happened on the water during the Civil War, although at the time, I dare say, it received no more than passing notice. To the generations to come, the big things in the World War, so far as the naval part of it is concerned, will not be the Battle of Jutland, nor the Gallipoli fiasco, nor the few other engagements in which capital ships took part, but rather the spectacular, though long-drawn struggle between the comparatively new submarine and the even newer means of combatting it—the Submarine Chaser and its deadly depth bomb.

The Chaser is essentially an American product as was the British "M.L.," its predecessor. The idea originated here and the boats, as well as their motors and much of their ingenious equipment, were built in this country. And now that they have made good, we're proud of them. Everybody who knows what they did is proud of them. Even the regular Navy shows marked signs of pride in her precocious step-children, and those of us who talked motor boats from the time the war began are trying hard to suppress a very real and a very human impulse to say: "We told you so." For the Submarine Chasers, the Cinderellas of the Fleet, have come home with a service record unsurpassed by any class of ships in the Navy.

For a year, flung far along the Allied coast lines and our own, these little vessels carried tirelessly on—convoying merchant ships, hunting the submarine with their uncanny detection apparatus, dropping the deadly depth bomb when they found him, exploding mines, fighting ahead of the fleets and performing a thousand drudgeries as well, too menial for their bigger sisters. And then, many of them in the dead of winter, they came home across three thousand miles of ocean, bearing proudly the scars of Durazzo and with a record of 40% of all the submarines destroyed by American vessels.

Nobody, not even the visionary gentlemen who first began to play with the idea, could have predicted the remarkable success attained by the Submarine Chasers. Nobody except a handful of small boat enthusiasts would have believed it possible for them to live out some of the dirtiest weather that ever flayed the Western Ocean. And but few, even after the job was finished, seemed to appreciate the fact that

the Chasers more than any other one thing sealed the fate of the German submarine.

But they did more than that, for through their performance over countless weary, rolling miles of sea, they have given us a fund of valuable data on the possibilities of small boats and their power plants that we never should have gathered in many a lazy year of peace.

Yes, we're proud of them now and of the kid reservists who commanded them and of the gobs who manned them. The little vessels that were damned and ridiculed by the majority of battle-wagon men from the time their design was first noised about, made good—gloriously made good. They have written a story that will live along with the classics of naval history to fire the imagination of the youth of generations to come.

WILLIAM WASHBURN NUTTING.

New York City,
September, 1919.

DEDICATED
TO
THE BLACK GANG

Part I

The British M. L.'s

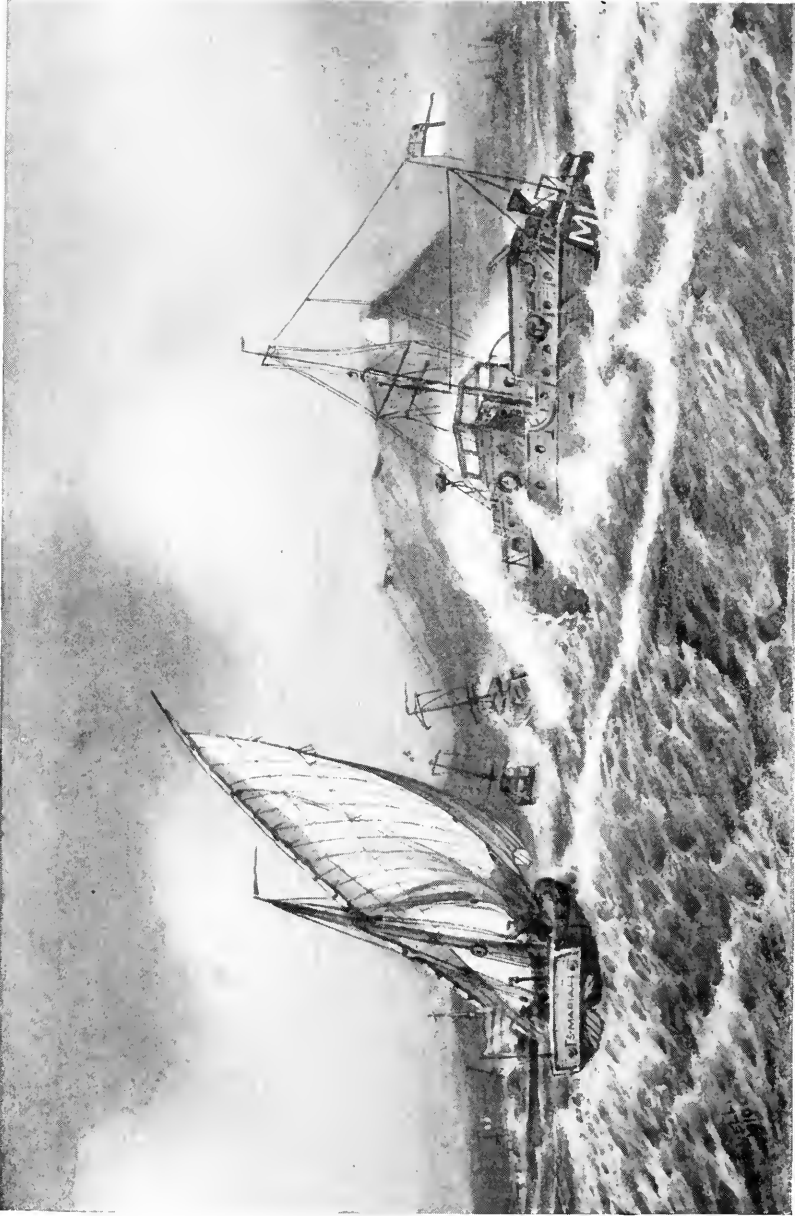

Dragon by J. C. Forcell.

The "movies" in the Mediterranean.

THE CINDERELLAS OF THE FLEET

CHAPTER I

THE M. L.'s—THEIR ORIGIN AND THEIR DUTIES

I HAVE always thought of the world as divided into two classes of people: those who are interested in boats, and—well, just plain folks.

So far as America is concerned, the "just plain folks" have been somewhat in the ascendancy since the days when the New Bedford whalers and the famous Yankee clipper ships made the American ensign a thing well known and respected on all the seven seas. Of late years there hasn't been much to keep alive in our people a love of the sea or much to which we could point with pride to refute the taunt of the lime-juicer that we have forsaken the sea and become a soft, land-loving nation—not much besides our Navy and always our Gloucester fishing fleet.

But the war has changed all that. Not only has it put us back on something like a decent footing as a maritime nation, but it has added a brilliant chapter to our naval history as well. It has brought back thousands of men to the sea, and it has instilled in other thousands a new interest in things nautical.

Let us take it for granted then that whoever finds himself in possession of this book is interested in boats, that he speaks the language, and that he wants in one volume as much information as he can get about the particular kind of boat that, developed by the war, did as much as any other instrumentality in bringing it to a successful conclusion.

No weapon, no policy, no idea developed under the stimulus of war returned a fuller measure of what it was intended to do than did the Submarine Chasers. No program was carried through to a successful conclusion with less waste, less confusion, less blundering than the seemingly impossible feat of building and powering in a year's time four hundred and fifty 110-foot boats in forty different places all over the country. And no individual or organization is more

entitled to the gratitude of the nation at large than the company that built, without hint of profiteering, the hundreds of engines with which these boats were powered. But the really remarkable thing about the whole program is that it was accomplished for the most part in the existing boat-building yards of the country without deflecting labor or material from the shipyards or delaying in the slightest the production of merchant and naval vessels or their propelling machinery.

Another remarkable and typically American accomplishment was the building of the earlier patrol boats for England—the five hundred and fifty 80-footers, known as the M. L.'s, which did such varied and valiant service during the later years of the war. These boats were the forerunners of our own Chasers and it was upon the results of their performance, to some extent, that our boats were designed. For this reason I have decided to tell something of the M. L.'s and what they did for England before continuing with the story of the Chasers.

THE BRITISH M. L.'S

Back in 1914 America, the big, more-or-less neutral bystander, startled and fascinated by what was happening on the other side of the Atlantic, began to develop an interest in the scrap and to shout suggestions to John Bull. John, fat and somewhat out of training, was taking a lot of punishment on those selfsame waves that he had been ruling for so long.

These suggestions were numerous and many of them proved of service, but the best of them was this: "Why don't you go after the pirates with a fleet of fast motor boats?"

Probably John Bull already had been thinking along this line himself for he had mobilized his trawlers and his yachts and his motor craft early in the war, but at any rate his boat yards could not turn out a job of this size. Standardized Chasers might be all right and they might not, but other definite things were needed and his shipyards were having all they could handle to produce these things without experimenting with something doubtful.

By the spring of 1915 the submarine situation had become so grave that the Lords of the Admiralty decided that something had to be done and done quickly. From the frequent and audacious sinkings, some of them at the very mouths of English harbors, and the toll



Drawn by J. C. Fowell.

An M. L. strikes heavy weather in the Straits of Gibraltar.

already taken from the British fleet itself, it was plain that a large and powerful Navy was not the solution of the problem. Neither were the thousands of trawlers, and other auxiliary craft patrolling the waters of the British Isles, able to check the growing menace.

It was not long after this that a steamship arrived in New York harbor bearing a commission of prominent British engineers on a quest for boats, and they frankly solicited the co-operation and advice of those whose experience might be of service. America, through John P. Holland, had given to the world the most terrible of all the deadly implements of modern warfare and now America was called upon to devise a means for its destruction.

The very day of the arrival of the ship a message was received by the Standard Motor Construction Company and the plant was kept lighted that evening for the inspection of the engineer officers. The facilities of the company were carefully considered as well as the design of the motor and late in the night the visitors departed convinced of the possibilities of the plant for the production of engines in the quantities in which they were likely to be needed.



A group of M. L.'s on the ways ready for launching.

Subsequently members of the commission met the head of the Elco Works, a boat building organization, with a record as old and as excellent as that of the Standard Motor Construction Company. Away back in 1893 this company had built a fleet of fifty electric launches for the Chicago World's Fair and from that time on had acquired a reputation for standardized boats. It seemed the logical yard to tackle the job.

Several days passed and then the commission expressed its readiness to place an order for fifty 75-foot boats if the whole lot could be delivered within a year's time. This was a task unprecedented in the history of boat building, but Mr. Eugene Riotte of the Standard Motor Construction Company and Mr. Henry Sutphen of the Elco Works decided that it could be done.

On April 9, 1915, the contract for fifty boats was signed and once actually started, the work progressed so rapidly that by the first of May the master or pattern boat, from which the others were to be standardized, was in frame at the Bayonne plant.

It was on this day that the Lusitania sailed on her last voyage and a week later the appalling news of her destruction rocked the world.



M. L.'s awaiting their trial runs on the St. Lawrence.

This probably was the cause of a cablegram from the Admiralty ordering five hundred additional Chasers, the whole lot to be delivered complete and in running order by November 15, 1916. Five hundred fifty boats in as many days! Eight miles of boats—think of it! There was romance in the idea—romance beyond the dreams of a Kipling or an H. G. Wells.

THE DESIGN OF THE M. L.'S

In order to appreciate the work that the M. L.'s have done in the war, let us look at the design and how it was arrived at.

The problem which was put up to Mr. Irwin Chase, the designer, was one which at first glance would seem impossible of solution. The first consideration was the speed, which was to be 19 knots minimum when fully loaded. The second consideration was the large cruising radius specified, to attain which the fuel capacity had to be over 2000 gallons, which meant a weight of 12,000 pounds for fuel alone. Besides this, it was necessary to allow for a deadweight of 20,000 pounds, the equivalent of the weight of the guns, ammunition, water

and supplies—in other words, the weight over and above that of the boat and its power plant complete.

The next consideration was seaworthiness, for it was specified that the boat should be able to maintain station in any sort of weather. And finally there was the problem of rapid construction which eliminated at the start any possibility of the use of such features as double planking and the like. A type of construction had to be decided on which would be within the limits of complete standardization.

Further to limit the designer, the size had to be such that the boats could be carried on the decks of steamships and for this reason 75 feet at first was decided on as the length of the boats.

This set of conditions would seem to be absolutely incompatible. Never had there been a boat built which might offer suggestions and the speed-length ratio was so high that any existing data from the designs of torpedo boat destroyers was of no use whatever.

And so it was with an absolutely clean slate that Mr. Chase went to work. Several sets of lines were drawn up as quickly as possible from which models were made and in order to determine beyond a doubt which of these would best meet the requirements, a flying trip was made to the University of Michigan where they were towed in the experimental tank. There had to be a compromise between speed and seaworthiness and after elaborate tests in the basin, a model was decided upon which had fairly fine lines forward and a rather flat after underbody or run, but still with considerable underwater body or deadrise as the depth of the boat from the turn of the bilge to the keel is called.

One of the models was more symmetrical in shape with the V-sections carried clear to the stern, but while this might have proved a trifle easier especially when running before a sea, it was found impossible to attain a speed of 19 knots with reasonable power on a length of 75 feet. The latter model, the so-called more seaworthy model of the two under discussion, was found more easily driven up to a speed of 15 knots but beyond this the advantage was all with the boat with the flat run, especially when trimmed by the stern.

From the start the designer and the British Commission were determined to employ medium speed motors, for the boats were to be used day in and day out and they could not afford to risk a high

speed machine in a decidedly heavy duty outfit. Twin Standard air-starting and reversing motors, rated at 220 horsepower each seemed the logical power plant.

The results of the tests were wired at once to the Admiralty, and these gentlemen, although they had specified a speed of 19 knots, were inclined to doubt that such a speed could be obtained on the calculated displacement and waterline length and with the power specified. The designer realized the conservative rating of the motors and their capacity for delivering considerably more than their rated horsepower, but it was not until the trials of the first boats were run off that the British representatives were convinced that this speed was possible.

It was calculated that the cruising radius at full speed with 2000 gallons of gasoline would be 800 miles, although at 15 knots it would be possible to cover 1000 miles and at 11 knots, 2100 miles. When the order for 500 boats came in shortly after the completion of the first sample from which the rest were standardized, it was decided to lengthen out the boat from 75 to 80 feet. The body plan was kept the same but it was found that by loosening up the interior arrangement more comfortable quarters were obtained without the slightest reduction in speed.

Crowding 500 horsepower into even an 80-footer means that you're not going to be able to treat the crew very generously in the matter of living quarters with what space is left. Up forward, in a length of twenty feet, seven men lived and slept in a fo'c's'le considerably smaller than that of a Gloucester fisherman. The officers' quarters in the stern were divided into a ward room "where two can turn around and three becomes a crush" and a pretty decent sized stateroom with two bunks.

Stuck in between the engine room and the pretentious ward room was the galley, "stink hole of weird stenches that carry their message of strange forms of nutrition fore and aft and permeate the nostrils of all hands and especially of the cook." "I am afraid," says Lieut. Dawson, "that I cannot tell in restrained tones of that hole of iniquity in the galley, with its tintinnabulation of shifting pots and pans and burning concoctions flung in a heavy sea over paraffine burners."

THEIR RECEPTION IN ENGLAND

It was to be expected that there would be some criticism of such a type of boat when it arrived on the other side. Not only were the naval authorities unfamiliar with this sort of craft, being somewhat behind our own navy in experience with motor-driven boats, but the yachtsmen of the R. N. V. R., who for the most part commanded them, were equally inexperienced in the type. The Britisher had a constitutional leaning toward a model with greater draft for sea work and a pretty good leaning it is too, and there was not a little apprehension that the boats would behave badly and might actually capsize in a heavy sea. The motor they knew to some extent and besides, its sturdy, honest qualities were just those to appeal to the conservative British temperament.

Gradually whatever doubt there may have been at the start was dispelled by the remarkable performance of the boats. When they arrived the submarine shifted the scene of his activities farther and farther out to sea and the M. L.'s gradually came to be called upon to perform much more strenuous work than anyone had anticipated when they were designed. For days on end they maintained their station far out at sea—too far to be able to run for a harbor in case of dirty weather. Frequently they were forced to ride out storms which for cussedness and perseverance have our own brand beaten forty ways. The shallow North Sea is bad enough at any time, but in the winter it is downright wicked.

But the M. L.'s made good. Not only in the actual work of patrolling for submarines but in countless other ways as well—sweeping for mines in the channels ahead of ships, convoying merchant vessels, towing the deadly Q type paravane for lurking subs, laying mines, co-operating with air craft—in the Channel, in the North Sea, in the Mediterranean, at the Dardanelles and in the Adriatic.

The ubiquitous M. L.'s did what the other ships could not do and did it well. Their work attracted the attention of the French and Italians, and large orders were placed for Standard motors and in many cases for completed boats which brought the total number of M. L.'s up to 720.

In this connection it might be interesting to read what the skipper

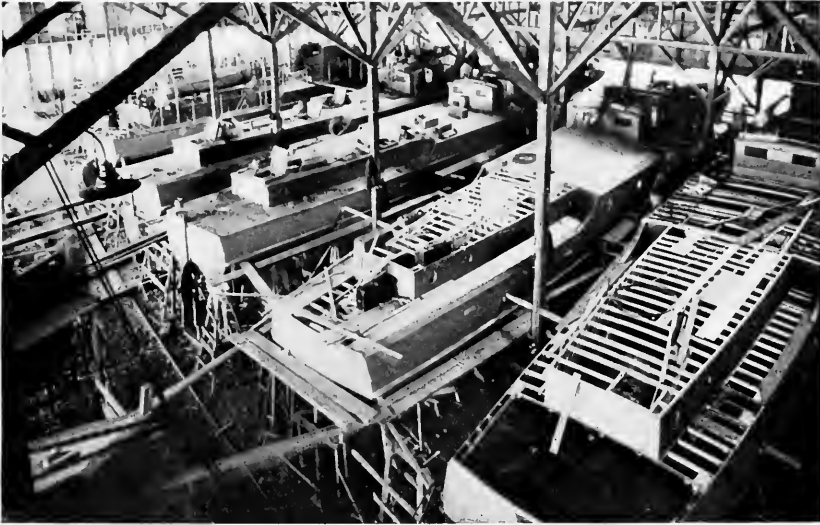

Assembling the M. L.'s. Even the planking of these boats was standardized and cut to templates before shipping from the Bayonne plant.

of one of the M. L.'s has to say about them. "Seven Pennant," writing in the *Yachting Monthly*, says:

"Our sympathetic friends and relations on shore have often expressed pity for the hardships of the winter of wet and cold, but no one outside the M. L.'s themselves have ever realized what is really the greatest hardship of all. It is summed up in the word motion. Reader, have you ever tried to do a continual course of Swedish exercises from, say, 4 a. m. until 6 p. m. with no interval for food? I take it you have not, but if you can try and imagine to yourself the bodily fatigue and vexation of spirit that would be produced by this form of penance and then add to it wind, bitter cold and, perhaps, nay probably, wet, you may glean some idea of the hardships expressed by this little two syllabled word. I might also have added a slight form of nausea common to many of us, but often not admitted. Motion—and we get it throughout most days of the winter—is the curse of our existence. It is present without respite, without pity for fatigue and aching bone and muscle, an enemy to rest, to rob us of food, and indeed of every amenity of life. This briefly is what the



Photograph by courtesy of Lieut. Bewick S. Cawthorn, R.N.V.R.

The gun crew of an M. L. and their wicked little 3-inch gun.

hardships of motion mean to us. An M. L. is never on an even keel, save on the very smoothest of days, days that during the year one can count on one hand. We ride over everything, and our very lives depend on this fact, for we are too fragile to "go through" or take it really "solid." It is due to this fact, too, that our brave little ships derive their wonderful seagoing capacity.

"In spite of all we hear to the contrary, how wonderful are the sea-going qualities of the M. L.'s. Never in my wildest dreams did I think a small vessel of their size could live in the seas I have seen them live in, and survive without the smallest hurt, the only anxiety being the engines, the failure of which might have meant disaster, and perhaps death. The longer I live and have my being in them the more I marvel at the boats and the more confidence I gain. How different it has turned out to that which I was led to expect in those early days of the service when we were all "doing" our M. L. course at one of the bases. Speaking personally those were the days of expectant cold feet, and so much did I hear of the unseaworthiness and general futility of these little craft, that I dreaded the day when

I should have to set out on one. Even our instructors used to inform us that with a following sea in the Solent it had been found impossible to steer an M. L., and that they had even tried towing 30 fathoms of a 4-inch rope astern, but apparently without avail. Then we heard a vessel had blown up going round the coast and that the crew had perished miserably in the flames as the burning petrol surrounded them as they swam. This and like harrowing tales were bandied round, but, looking back after this considerable lapse of time, I am inclined to think it was part ignorance and partly a case of bad workmen blaming their tools. * * * * *

“We M. L. sailors are specialists. We do things and go out in weather that no sailor, accustomed to ordinary ships, would in his prudent senses attempt unless he had served with understanding in our ships. Some of the most fundamental axioms of seamanship we put aside. Do not the more knowing ones among us invariably clear from a crowded harbor quayside in a tideway by going astern? Provided she is handled astern and not ahead, in the hands of the artist the M. L. can be made to ‘do anything except wait at table,’ but who taught the knowing ones this now quite obvious principle but that most excellent of all teachers, practical experience? And indeed it is this teacher that has taught us most of what we know. We have had to

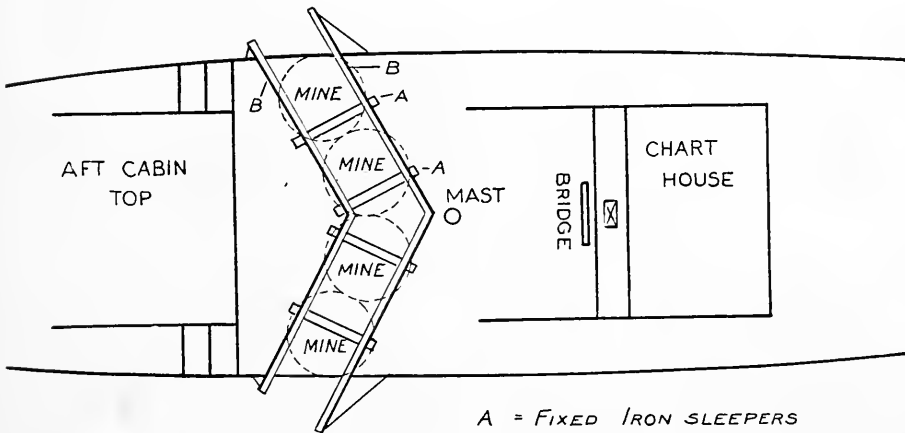

A = FIXED IRON SLEEPERS

B = REMOVABLE ANGLE IRON RAIL

Method of carrying and launching mines from the deck of an M. L.

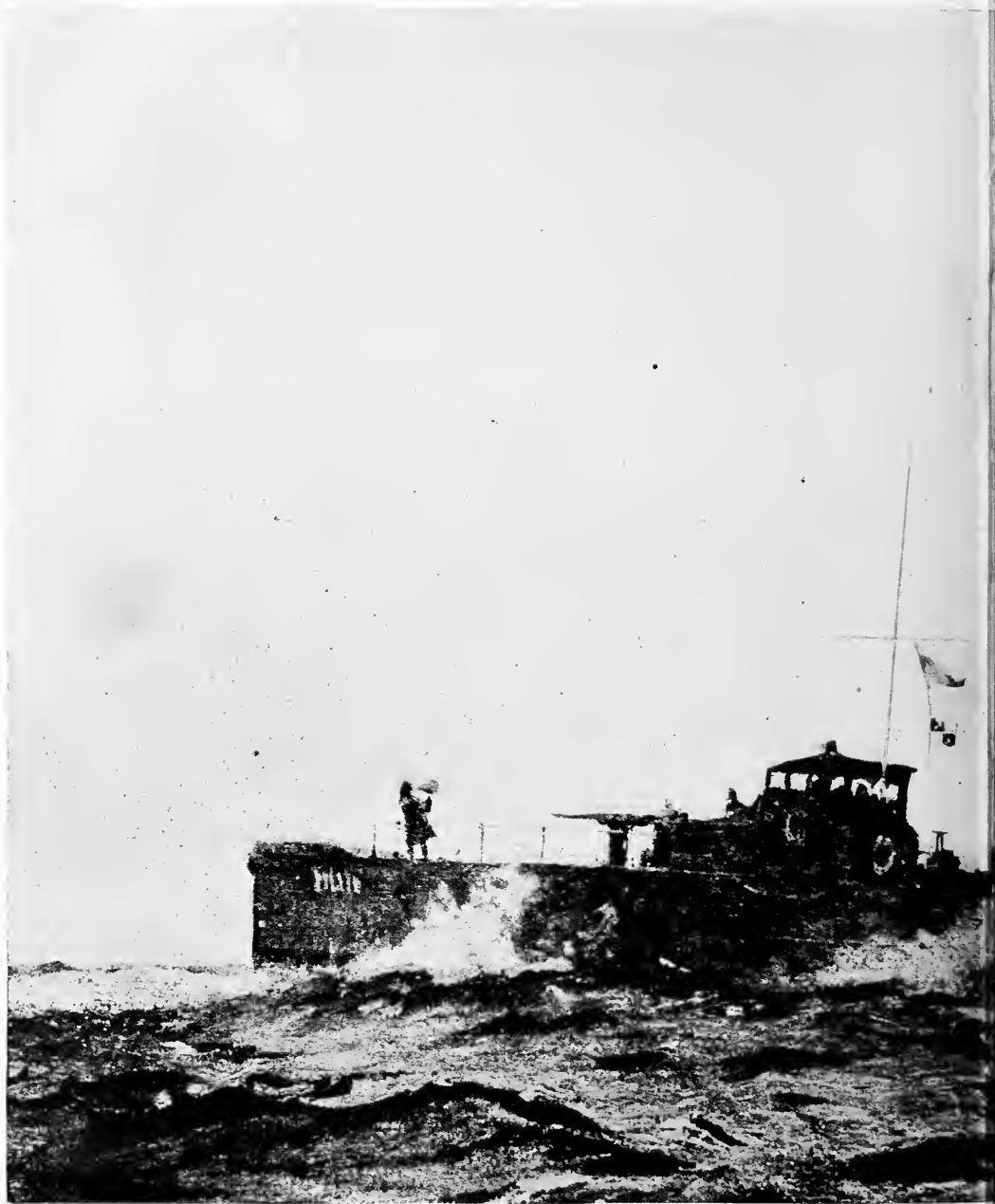

"You are standing into a minefield," from

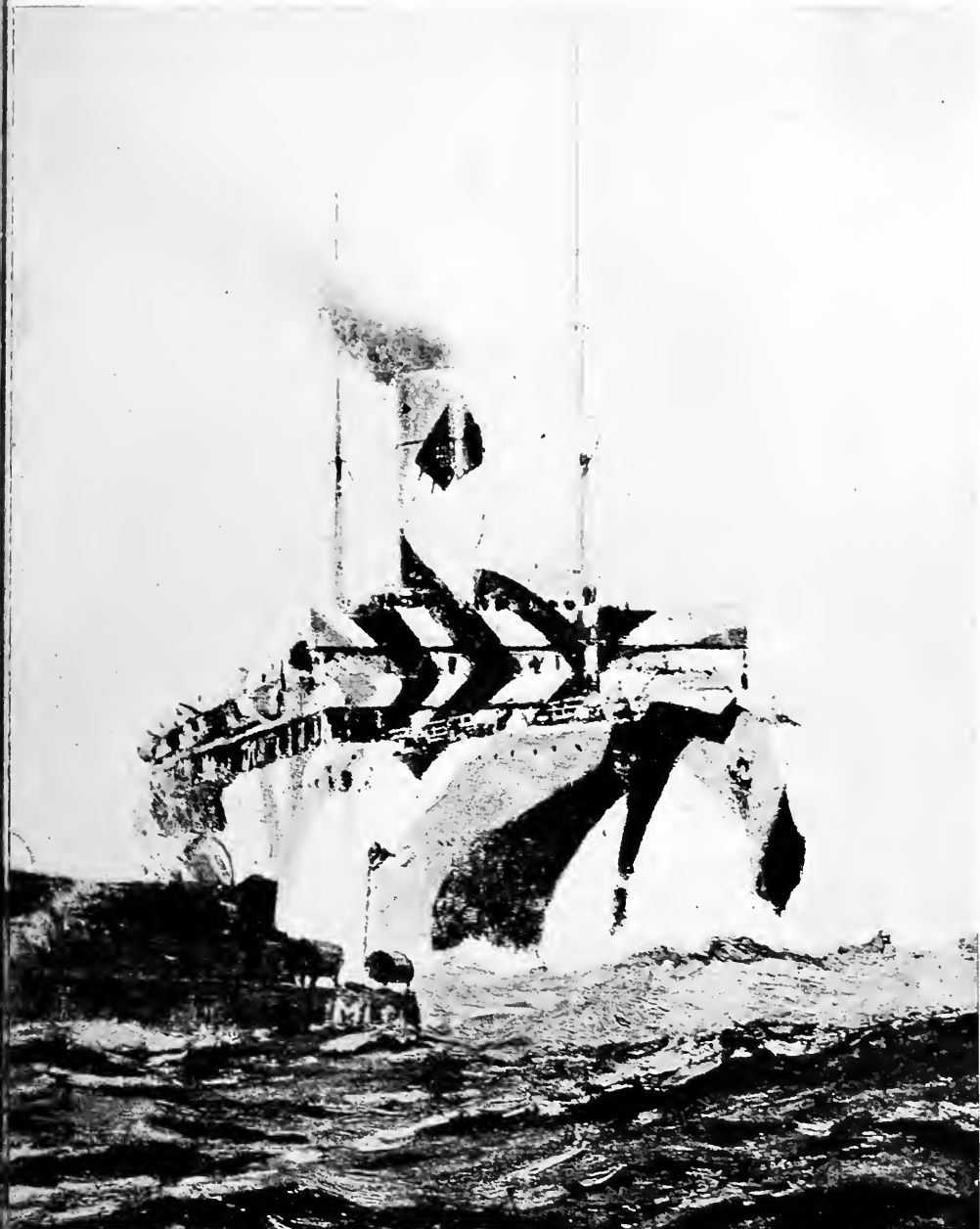

a painting by Norman Wilkinson, R.I.

Reproduced by permission from "The Sphere."

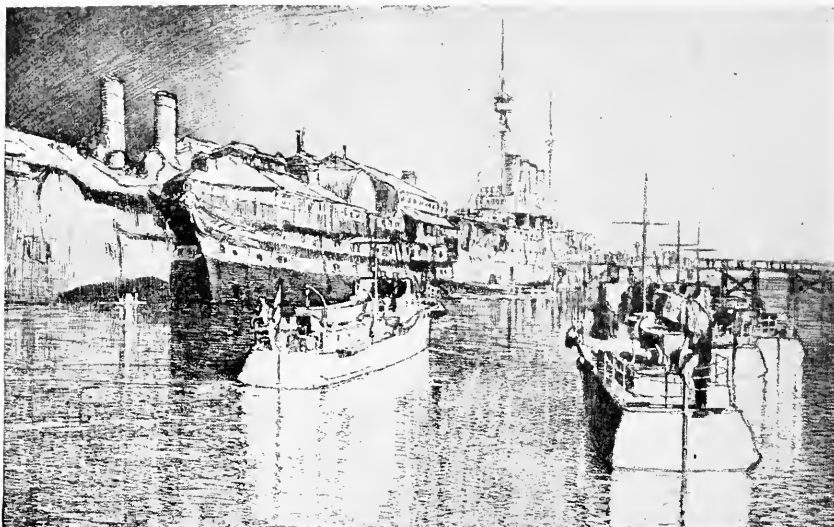

Reproduced by permission from "The Graphic."

The oldest and youngest members of the British fleet.

find our own way along a thorny path for the most part, with no one to advise us, and at first generally under the orders of someone who, through no fault of his own, had no more idea of what we could do than the man in the moon—in those days we had very little idea ourselves."

HUNTING SUBMARINES

When used actually to hunt submarines, the little boats of the "Gray Patrol" operated in groups of four, one of which was the flagship. Sometimes they worked out of an important harbor a day at a time, but as often you'd find them 100 miles off shore, for days on end under conditions hitherto considered impossible, and with the small comfort of, say, some Scotch fishing village to return to. For the men stuck off out of touch with civilization for months, the simple every-day things of life took on a totally new significance and the thought of a week in London was a dream comparable only to the orthodox idea of heaven. No wonder the men whose lot it was to hunt the submarines aboard the "movies" became attached to their little ships and the motors that stood by them so gallantly.

In the work of U-boat strafing the M. L.'s worked frequently with seaplanes and blimps, the small dirigibles which were found to be even better than the planes for spotting the sub-sea fighters. The boats carried no wireless or telephones and depended upon the blinker and semaphore systems for intercommunication. In the event that a blimp or seaplane spotted a sub the information was communicated to the patrol boats by means of smoke bombs.

The fighting equipment of the M. L. consisted of a short calibre 3-inch gun using a shell weighing in the neighborhood of 13 pounds. It was a short gun with a long recoil and while the range was much less than that of a standard Navy gun of the same bore, it required a smaller gun crew and was successful for these small quick-acting vessels on which the ability to shoot a large shell was more to be desired than range.

But more important than the deck gun was the depth bomb with which the little fighters put the fear of *Gott* into the biggest U-boats. This highly-revered shipmate known to our own gobs as the ashcan, contained 250 pounds of T. N. T. and could be set to explode at any predetermined depth. It was the depth bomb that sealed the fate of the submarine. With it, it was not necessary actually to hit the submerged target; merely to explode the can within 30 or 40 yards of the sub frequently was sufficient to cause the starting of a seam or the disarrangement of the storage battery or other internal mechanism.

In order to fight the submarine at close range the early boats carried what were known as lance bombs—14 pound bombs on the end of 4½-foot handles. These were designed to be thrown much as an athlete would throw a hammer and, needless to say, they were handled and treated with the utmost reverence. Later they were omitted from the equipment.

Loaded as the M. L.'s were with enough high explosive to blow a dreadnaught to kingdom come, it is not pleasant to think what would happen and what did happen occasionally when a shot found its mark. "Like Agag," says Lieut. Dawson, "we must go tenderly all our days and not bump too hard lest not only M. L. disappear like the conjuror's cat, in a loud explosion and a puff of smoke, but also most things within a quarter of a mile's radius."

All the M. L.'s carried portable directional hydrophones, which were

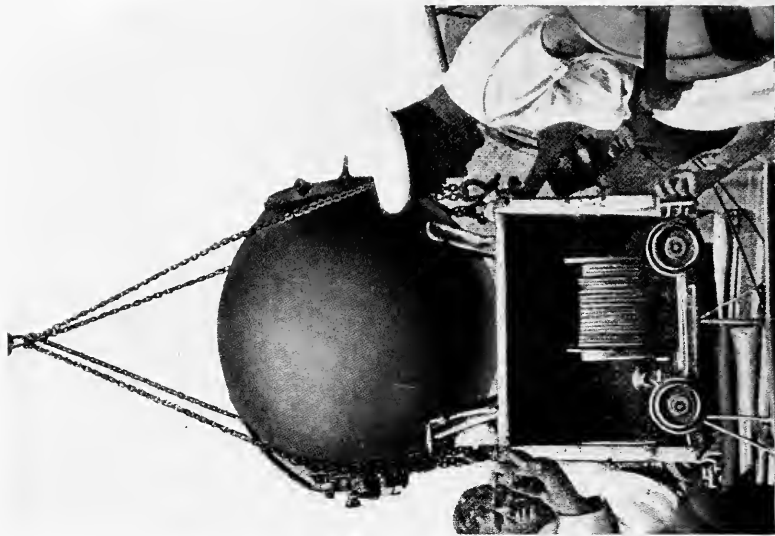

Placing a British mine aboard an M. L. The sinker door has been removed showing reel on which mine mooring rope is wound.

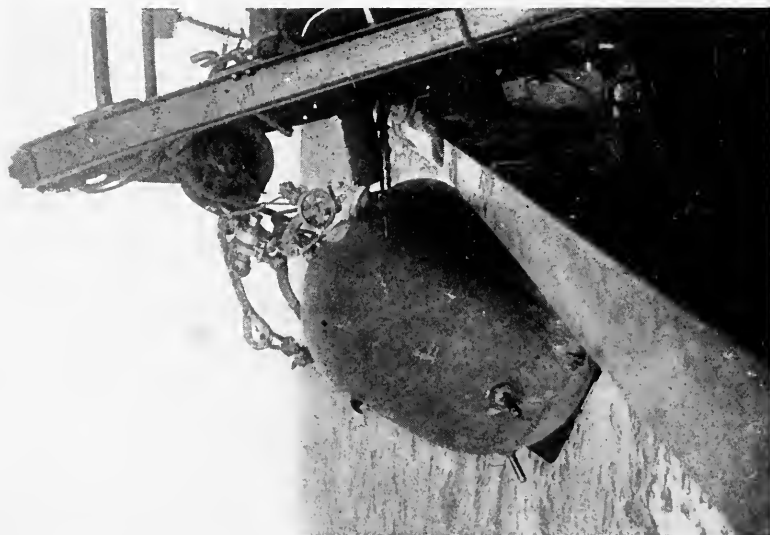

Photo by courtesy of *Lieut. Bewick S. Cawthorn, R.N.V.R.* Picking up a German mine, bottom up, for safety. If one of the horns were bent while in this position, the liquid from the glass phial could not cause a detonation.



Several of the M. L.'s were fitted with paravanes—the ordinary type for cutting mines adrift; the deadly explosive "Q" type for anti-submarine work. A pair of these most ingenious instruments are shown on either side of the deck.

sufficiently accurate to enable them to tell within about two degrees the direction of the approach of any sort of vessel and listeners became so proficient that they were able to determine whether the sounds heard were those of a turbine engine, a reciprocating engine, a paddle wheeler, an M. L., a submarine on the surface operating on her Diesel engine or a submarine submerged and driven by her electric motors. These sounds were entirely different and in the confusion caused by several at the same time the listener was trained to eliminate everything but the sound of the submarine. Our own listening devices with which the Submarine Chasers were equipped, were somewhat more elaborate than those of the M. L.'s and will be described later.

MINE LAYING AND SWEEPING

Those who had occasion to traverse the war zone during the last two years of the war will remember the varied duties that the M. L.'s were called upon to perform and the remarkable gear with which many of them were equipped. Dubbed the "movies" because of their

activity in a sea way, the ubiquitous M. L.'s earned the title in a better sense because of their never ending activity in performing all sorts of nasty jobs for which they were never intended.

Probably one of the last duties one would expect an M. L. to perform is mine sweeping which was generally done by heavily built steel trawlers and paddle-wheelers. But many of the M. L.'s were called upon for this service because of their ability to sweep a channel much faster than the regular sweepers. Frequently they swept in flotillas of four in quarter line formation using the "kite" to hold the sweeping cable extended. At other times the P. V. sweep was used, consisting of a pair of paravanes towed off the quarters. These paravanes or "otters" were much the same as those with which all merchant and naval vessels traversing the war zone were equipped in order to protect them from moored mines. When used for sweeping, the paravanes operated in practically the same way except that they were towed off the quarters instead of off the forefoot, thereby offering no protection to the boat from which they were towed. Extending out at an angle of approximately 45 degrees, the towing cable of the paravane encountered the mooring wire of the mine, deflecting it out to the paravane where it was cut by the steel knives in the head of the latter. After being cut adrift the mine was exploded by gun fire.

But the ordinary method was the "D" sweep. With this sweep the boats worked in pairs towing a cable one end of which was attached to either boat. The mines were caught by their mooring wires and if not pulled adrift from their mooring, were reeled in and disengaged by hand—a hazardous operation which has resulted in many a casualty.

When the M. L.'s were designed no one had the slightest idea that they would ever be called upon for the work of mine laying but in the latter months of the war many of them were so engaged. They were fitted with tracks capable of carrying two mines nested in their sinkers on either side, and their operation was something like this: three or four divisions of four would proceed to sea in single line formation having to cover possibly fifty miles before arriving at the mine field, which was indicated by a buoy. After bearings had been taken and the exact position determined, they would proceed in single line ahead until the senior officer's boat arrived at the buoy. Then a signal would be hoisted calling for an eight point turn which would

bring the M. L.'s in line abreast at intervals of about 75 feet. A rocket fired by the senior officer was the signal to start to lay, when the forward starboard mine would be dropped. Thirty seconds after the forward port mine went over, then the aft starboard one and then the last one from the port side. In this way a staggered formation was obtained and a flotilla of twenty boats would lay eighty mines in scarcely more than the time it takes to describe the operation.

The last M. L. carried several buoys which were dropped at the time the mines were laid to indicate the length of the field laid on that trip.

A DANGEROUS GAME

We are indebted to Lieut. Morris P. Shea, R. N. V. R., for many interesting facts about the work of the M. L.'s. During the last eight months of the war, Lieut. Shea was in command of one of the M. L.'s working with the British Grand Fleet at Scapa Flow in the Orkney Islands. His work, with that of the other M. L.'s, consisted in patrolling, convoying, running torpedoes for the ships of the fleet and in fact almost any sort of a job which was beneath the dignity of the larger vessels. One of the motor launches was tied for several days to a pier operating its auxiliary engine, furnishing electric light for an air station on one of the islands and also furnishing current for a movie show to entertain the sailors of the Grand Fleet.

For a considerable time Shea's M. L. was stationed in a little bay outside the entrance to Scapa Flow harbor where the British fleet, as well as some of the American battleships, lay at anchor. It was expected that sooner or later the Germans would endeavor to break through the nets at the entrance to this harbor. The risk was great but the stakes were high. In order to be prepared for such a raid, the M. L.'s were kept at five minutes' notice for weeks on end and were ordered to sea at any hour of the day or night—sometimes because suspicious craft were heard by the hydrophone listening stations on shore and at other times merely to keep them on the jump and prepared for the real thing.

An interesting stunt and a dangerous one in which Shea participated was pulled off shortly before the armistice was signed. A signal came for his M. L. No. — to remain at anchor at a given point

within shelter of a certain island and to carry out a prearranged program at eleven o'clock that evening. It was pitch dark. The orders were to proceed at full speed without lights and make for the entrance to Scapa Flow. It must be remembered that the war was very much on at this particular time and this was exactly what it was expected that some daring *unterseeboot* might attempt at any moment. His job then was to play submarine and endeavor to get as far as the boom without being noticed—scarcely an enviable position at a time when your friends are likely to shoot first and investigate afterward.

The islands round about were equipped with powerful searchlights with watching crews to look for and locate instantly any suspicious craft that might attempt to enter the prohibited area. Any such craft would also be heard by the hydrophone listening stations.

The orders were to proceed at full speed and not to stop until picked up by the searchlights or fired upon. This he did, zigzagging, stopping, going full speed astern, in order to elude the searching fingers of light that seemed every instant to be on the point of exposing him. Finally a blinding shaft picked up the M. L. and in scarcely a second's time it was the center of two score powerful beams like a brilliant gem in some weird, titanic stage setting. Then when the watchers discovered that they had not bagged a German, the lights went out and the M. L. returned to an extra late supper.

Such things as those were all in the day's work of the M. L. and many a time the similarity that these little craft bore to a submarine on the surface, accentuated by fog, darkness or the fevered imaginations of some high-strung gun crew, drew the fire of their own countrymen—and a brief line in the obituary column.



From "Yachting Monthly."

CHAPTER II

THE "M. L.'s" AT THE ZEEBRUGGE RAID

BY all odds the most spectacular and genuinely heroic naval event of the war was the raid which resulted in the blocking of the mouth of the canal at Zeebrugge. This canal which connects Bruges with the coast had long been a base for German submarines. It was of the utmost importance to the Germans, obviating as it did the long run to and from Wilhelmshaven and the other home bases, and consequently it was so thoroughly fortified as to make it supposedly immune from attack. But here the German psychology was wrong again for the "conservative" British Admiralty planned or consented to let a group of its officers plan not only to attack Zeebrugge but actually to do the "impossible" stunt of closing the canal by sinking block ships across its entrance, under the concentrated fire of the land batteries.

It took many months to perfect the plan of attack and during this time the men, who had volunteered for what was explained meant a fifty-fifty chance with death, were trained to the highest pitch of efficiency in the parts they were to play in the "big show," and all communication with the outside world was cut off. After several false starts and long, tense, agonizing days of waiting, the night of the attack came and just one hundred minutes after the firing of the first shot the flotilla withdrew, leaving the mole and its batteries a total wreck—and two concrete laden block ships sunk across the channel.

The raid was one of the most audacious of all time and its fortunate outcome was due largely to the work of the M. L.'s. Everyone knows of the splendid work done by Capt. Carpenter and the crew of the *Vindictive* as she lay in that inferno alongside the mole, but less loudly sung are the exploits of the little boats that placed the marking flares and made the smoke screen and stood by and removed the crews of the block ships after they had been sunk in the channel.

This tale of the work of the M. L.'s at Zeebrugge has been told admirably by Lieut. Gordon S. Maxwell, R. N. V. R., who was in

command of one of them. His story, which appeared originally in the *Yachting Monthly* of London, follows:

"On St. George's Day, 1918, Tradition was born to the Royal Naval Reserve. In the early hours of the now famous day the R. N. V. R., represented by a flotilla of motor launches, played an important part in a Naval engagement that thrilled the nations.

"Of the action in general I do not propose to deal, save so far as concerns the M. L.'s, for the former has already been described; but of the experience of the particular part played by the R. N. V. R. this, I think, is the first account to appear.

"The worst part of the whole affair was perhaps the waiting—the anticipation of the unknown. Before the action we had two abortive starts, both of which failed to materialise on account of the weather conditions. The ten days that elapsed were trying to the nerves, and we were glad when we had orders to leave harbour. Word quickly circulated that it was to be the real thing this time. The M. L.'s made a fine showing as they left Dover Harbour and formed up ahead. At "A" position, where the other forces joined up, we started in earnest. The destroyer Warwick with Vice-Admiral Keyes on board led, Vindictive came next with Iris and Daffodil in tow. Then came the blockships, Thetis, Intrepid, Iphigenia, Brilliant and Sirius. On each beam of the line were the M. L.'s and, outside, the destroyers. It was an imposing sight in the twilight. Vindictive seemed to loom up above everything else; she was a weird looking craft with no mast, tall funnels and boarding gangways swung up high upon her port side.

"At 'D' position Brilliant and Sirius left us for Ostend, while we continued our way to Zeebrugge, each ship going to its appointed station for the attack. As we neared our objective the Huns learned of our approach by aeroplane. Star shells began to go up. They were wonderful star shells, and lit up the sea like day. The last I saw of Vindictive that night was when the first star shell soared above her. There she was, like some grim phantom ship ploughing her way towards the dim outline of the Mole (our smoke screen had already begun), while close behind rounded the squat looking Iris and Daffodil, with all surrounded by M. L.'s and C. M. B.'s.

"The smoke began to thicken, till finally it blotted out everything in its fumes. Still, the relief when one of those brilliant star shells hit

the water and went out was great, for while their light was shining it seemed that every ship approaching the enemy harbour must be an easy mark for the batteries, and it gave one a very "naked" feeling. Thicker and thicker grew the smoke as more floats were dropped. All sight of the Mole and the happenings on and inside it were blotted out from our sight if not from our ears, for we could still hear the guns' incessant roar and the greater single roar that seemed to rend the very night as the old submarine blew herself up to destroy the viaduct connecting the Mole with the shore.

"The action, from the attack on the Mole by *Vindictive* to the retirement, lasted exactly *One Hundred Minutes*. During those fatal moments history was made. It is indeed good to hear men say that had it not been for the smoke screen put up by the M. L.'s and C. M. B.'s and the rescue work of the former, the action could never have succeeded; in fact, could not have been attempted. In this the R. N. have acknowledged our part like sportsmen, and the R. N. V. R. are proud to have had the chance of proving themselves blood brothers to the R. N. One remark, overheard in the Burlington Hotel at Dover, shows how a new feeling towards us has been born. A group of R. N. officers, some from the blockships and some not, were overheard discussing the part played by the M. L.'s, and one said: 'Well, if I ever hear anyone call them Harry Tate's Navy after this, I'll punch his damned head.' And the rest answered in chorus. A casual incident, but one with much behind it. Not that we mind banter, for you will hear more jokes at the expense of M. L.'s on board M. L.'s than anywhere else—thank God for a sense of humour.

"I am saying little about the part played by the 'Hush Boats' (C. M. B.'s), not because their work was not as good as ours (in many ways it was far more wonderful, for, although they have double our speed, they are only half our length and practically open boats), but because I think it better that someone who was on one of the marvellous little boats should write up the 'stunt' from their point of view. Their personnel is, of course, a mixture of R. N., R. N. R., and R. N. V. R.

"The first two M. L.'s to get inside the Mole were those of Lieut. H. A. Littleton and Lieut. P. T. Deane, and these two boats constitute the keystone of what credit is due to the M. L.'s for their share in the action. The first of the blockships to enter was *Thetis*. Close on her

quarter was an M. L. Next came Intrepid, with another M. L., and Iphigenia close behind. Of the other M. L.'s that were designed to enter the enemy harbour one was that of Lieut.-Commander Young, which was sunk before she got in.

"A very brisk fire was opened on the ships as they came round the end of the Mole through the gap between the barges and the boom to the shore. But the old cruisers plunged on to their objective—the blocking of the entrance to the Bruges Canal—at the same time answering the fire of the shore batteries with their guns. Then Thetis had the bad luck to fall foul of the net boom with her propeller, which left her at the mercy of the guns on shore, so her Commander was forced to sink her where she was, where she would be an obstruction, though not in the spot intended. Heedless of the heavy fire from the shore, Lieut. Littleton closed her in his M. L. and picked up the crew who were already in the boats. When all were aboard he turned to leave the harbour, but just as he did so a shout was heard from behind and some one cried out that a boat-load was coming up from one of the other ships. A begrimed and hatless figure in a duffel coat said, 'Do you mind waiting a moment, I think there are some more men coming?'

"Littleton's answer surprised the Captain: 'You priceless old thing, of course I won't wait for them.'

"The Captain stared.

" 'I'll go back for them,' added the 'Doctor,' and right back into that inferno of fire he took his M. L., got the crew aboard and turned once more to clear harbour, but stopped yet again to pick up a man who had fallen in the water. With a surplus crew of 60 odd, the M. L. found her way outside the Mole amidst the smoke and trail of shells, to arrive finally at Dover without mishaps save for a machine gun bullet through her after hatch, and a piece of shrapnel through the roof of her bridge house—a wonderful achievement and a wonderful escape.

"To the number one, Lieut. Lefron Geddes, praise is due for his untiring efforts throughout the whole affair, and for seconding his skipper in the rescues and in the running of the ship under heavy fire, and bringing it safely out of the danger zone, while Lieut. Littleton was doing his best to make the wounded comfortable with the limited accommodation a motor launch affords.

"The rumour that the 'Doctor' put on a clean collar in the middle of the action because the 'damned smoke' had soiled the one he was wearing is, I believe, unfounded; but it is at least characteristic of Lieut. Littleton. He told me afterwards that he had no idea that the dishevelled figure was a hatless 'brass-hat.' He thought he was an A. B. I wonder how he would have looked under normal conditions on being called a 'priceless old thing' by a two-striper R. N. V. R.

"Meanwhile Intrepid and Iphigenia were making their way into the mouth of the Bruges Canal, followed by Lieut. Deane in his M. L. His achievement was possibly the most remarkable of any M. L. throughout the action, for he was instrumental in saving over a hundred men from Intrepid and Iphigenia. Curiously enough they managed to get inside the Mole with hardly a shot being fired at them, by using one of the blockships as a screen from the enemy guns. Still following close behind Intrepid and Iphigenia, Lieut. Deane managed to get his boat straight into the mouth of the Bruges Canal, where he waited alongside the western arm while the blockships swung into position, putting up an effective smoke screen which certainly hampered the shore batteries which had by this time transferred their attention from Thetis and were submitting the two ships in the mouth of the canal to a devastating fire. After the explosion which sank the blockships, Lieut. Deane closed them and took off the crew who were already in the boats casting off. These he got aboard, and he was just going to leave the harbour when his boat grounded on the sloping side of the canal, damaging her propellers. At the same moment he discovered a Carley float with one man on it, so he went ahead again and took off the occupant, which happened to be the Captain of Intrepid. So intense was the fire all around that the M. L. was forced to back out to save time, and, as this had to be done with damaged propellers, it was certainly a wonderful piece of work, laden as the launch was. It must be remembered that all the while brilliant star shells made the scene as light as day.

"During the manœuvre three men on the launch were killed, including the coxswain at the wheel. Slowly the C. O. brought his vessel round the stern of Thetis, where he managed to turn her and commence the perilous passage out of the harbour, passing the gap in the Mole, now clearly visible by the light of the star shells. It says much for the coolness and resource of Lieut. Deane that he conceived the daring

plan of running his boat close along the Mole wall, thus rendering ineffective many of the larger German guns which could not be depressed sufficiently to bear upon him, although of course the manœuvre did not prevent the heavy machine gun fire being directed on his boat.

"But just as the M. L. was clearing the harbour, in fact, as she was passing the last of the anchored barges which marked the entrance, a shell from the shore batteries burst over the dinghy and killed several men, and carried the deck pump away, while another hit the fore-castle, killing three men and wounding several others.

"It is certainly a little less than a miracle that the boat managed to get to the open sea at all, for at this point the steering gear jammed, owing to somebody's coat getting entangled in the wire, and several valuable minutes elapsed at this vitally critical juncture before the cause could be discovered and the wires cleared, during which time the boat had to be steered by the engines alone.

"The behaviour of the Number One, Lieut. Keith Wright, throughout the action deserves the highest praise. Soon after the shell that killed the coxswain had hit the boat, the C. O. sent a message to him from the bridge and received a reply as though nothing had happened. Just as they were clearing harbour he sent again to him, saying that he was wanted on the bridge, but received the answer that Lieut. Wright was busy attending the wounded and could not come. Ever since they had left the Canal entrance Lieut. Wright had been lying on the floor of the Chart House, dangerously wounded and unable to move. He had given strict instructions to the messengers that this fact must be kept from the C. O. until they were clear, in case it might distract his attention from his work and thus add another danger to the boat, so already encompassed by perils.

"Subsequently Lieut. Deane managed to pick up Warwick and put the rescued crews aboard her, except one or two dead men and one man too seriously wounded to swim, whom he took direct to Deal Pier, where an ambulance had been summoned by wireless.

"That an M. L., whose full complement is ten men all told, should have been able to get out of harbour with over a hundred men on board, at night, would have been wonderful under peace-time conditions, but when we consider that the feat was performed amidst a tornado of gun fire, some idea of the achievement can be imagined, for

by the time the *Vindictive* was clear of the *Mole* all the attention of the enemy was directed on the *M. L.*

"The first R. N. V. R. officer to be killed was the Senior *M. L.* Officer in the action, Lieut.-Commander Dawbarn Young, who was in command of the first *M. L.* to approach the *Mole* with the purpose of laying flares to guide the blockships in. This he was never destined to do, for when he was yet four hundred yards away his bridge was struck with three shells from a shore battery, killing the coxswain instantly and severely wounding Lieut.-Commander Young, Lieut. Lee and members of the crew. Although mortally wounded he stuck to his post and gave orders for the dinghy to be lowered. Lieut. G. F. Bowen, the first Lieutenant of the ship, had perhaps what was one of the most marvellous escapes of the night; although standing on the bridge close to his C. O. and Lieut. Lee, he escaped without a scratch. Great credit is due to Lieut. Bowen for his coolness at this time, for with the *M. L.* still under heavy fire, with the help of the unwounded members of the crew he launched the dinghy and managed to get his C. O., who had now collapsed on the deck, into it. When all the rest were aboard, he wrenched off the ship's compass, passed it over, and from the Lewis gun emptied two trays into the already holed hull of the *M. L.*, at the same time smashing her in several places under the water line with an axe, not leaving her until she was settling down by the head. The plight of nine men, many of whom were wounded, in a little tin dinghy in such an inferno could hardly be worse, but they stuck gamely to it. Lieut. Bowen and the chief motor mechanic were the only men in a fit state to row; all the rest were either badly wounded or prostrated with shock.

"The circumstances in which Lieut. Lee happened to be on board the *M. L.* are interesting. He had just arrived at Dover for the 'stunt', to find to his disappointment that his boat was not ready to sail, owing to some important repairs being necessary. Rather than miss the action he obtained permission to go on Lieut.-Commander Young's *M. L.* as a spare officer. Even now, while they were in the dinghy, Lieut. Lee, though unable to row, refused to be a passenger in spite of his wounds, but held the compass between his knees and with his uninjured hand managed to work an electric torch and set the course.

"For about half an hour they toiled on, heading away from the

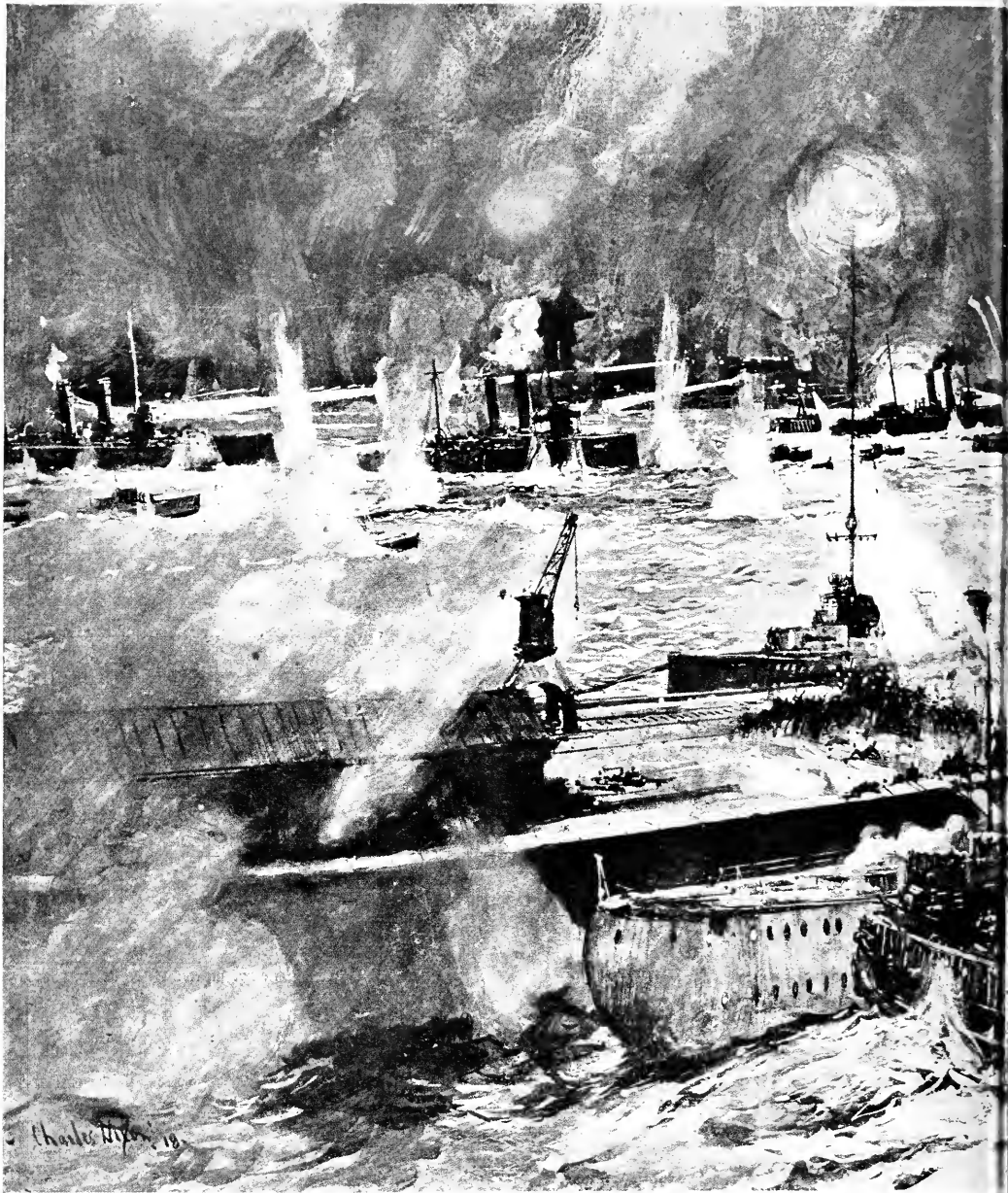

One of the most audacious adventures in Naval History

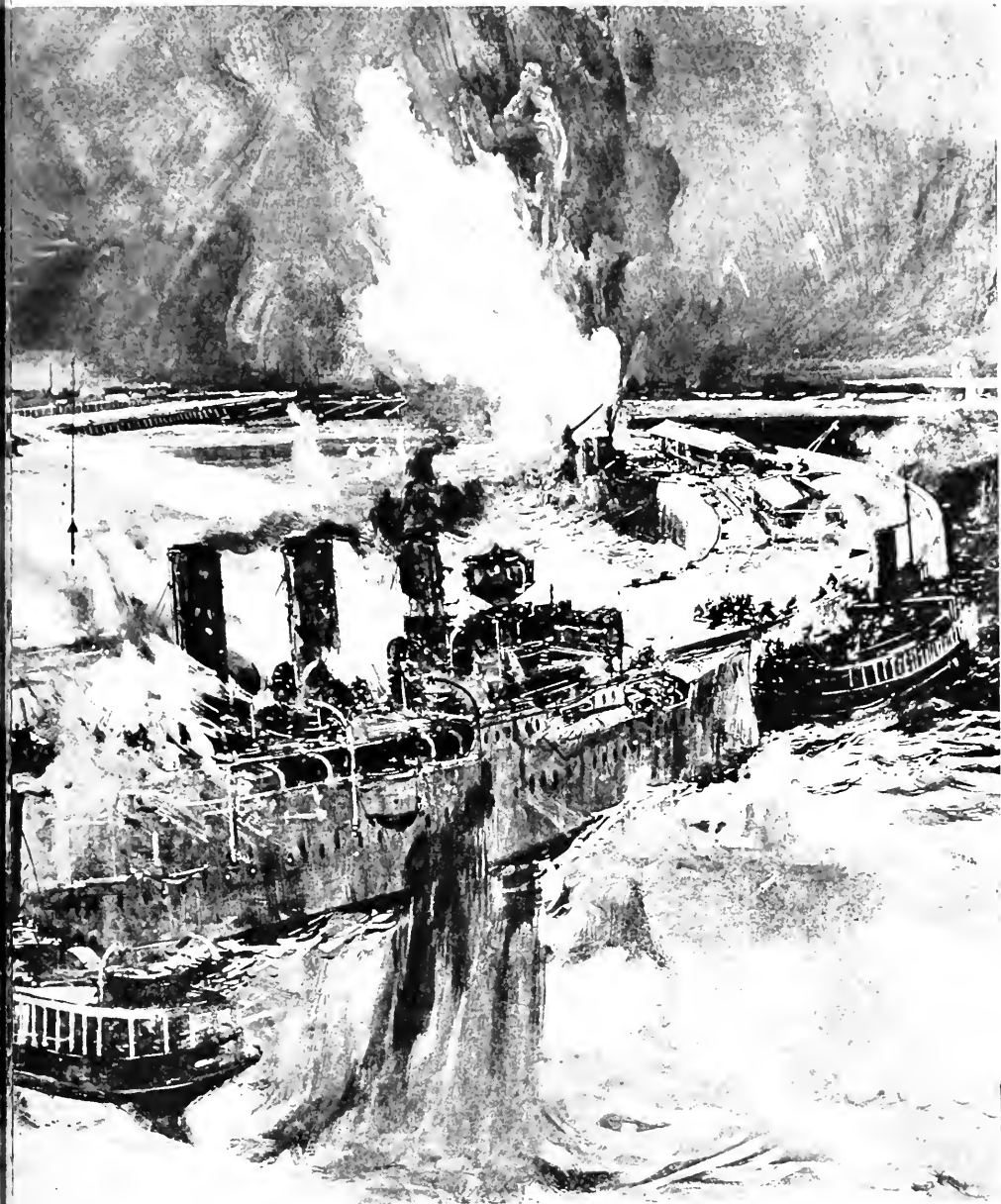

attack on Zeebrugge. Drawn by Charles Dixon, R.I. *Reproduced by permission from "The Graphic."*

Mole with a strong easterly tide. Three C. M. B.'s dashed by, but were lost again in the darkness and smoke before they could hear the hails from the dinghies. Then an M. L., under Lieut. H. W. Adams, loomed up in the gloom and luckily heard the shouts.

"Lieut.-Commander Young died on the way across. He was conscious till the last, and wonderfully plucky over his wounds. His left arm and right leg were badly hurt, but it was a gash in his left lung which proved fatal. His death will be a great loss to the R. N. V. R. in general and in particular to the Dover base, where he had been for over two years. Young was a 'white man'; a mean or lying action was impossible to his nature, and no man ever set or kept a straighter course than he. A most efficient officer and a very hard worker, he expected others to be the same; but he would never ask a junior officer to do what he would not willingly do himself; in fact, he often did more work than he need have done in his position, a fact which all who served under him appreciated. I have often heard men say, 'You'll always get a straight deal from Young,' and it was true. He was the essence of fairness in all his dealings. What finer epitaph could he have had than this:—'We sincerely mourn the loss of a true friend and a very gallant comrade, who died as he would have wished, at his post of duty.'

"Lieut. Oswald Robinson was the second M. L. officer to be killed. The circumstances were unsimilar to those connected with the death of Lieut.-Commander Young. His boat was hit while off the Mole, and again it was the bridge that was struck, the shell killing the C. O. and the Coxswain instantly. Lieut. Robinson's body was never recovered; it must have been blown away. Another incident that was almost the same as that experienced on the first boat to go: Number One, in this case Lieut. J. W. Robinson, was on the bridge at the time the M. L. was hit, but came off unscathed. The dinghy was launched, but before it could be manned, another M. L., under Lieut. R. Saunders, came up from out of the smoke and took them off. Lieut. Oswald Robinson will be missed by all and his cheery personality is a great loss to our little fleet. Only a few days before the action he was one of the principal performers in a concert we got up in the wardroom of Arrogant. He was a wonderfully clever mimic and actor, and his impersonations were the feature of the concert.

"Some of the M. L.'s had remarkable escapes. One of the narrowest was that of the boat under Lieut.-Commander L. S. Chappell, on which the Flag-Captain, Captain R. Collins, R. N., who was in command of the Motor Launch Flotilla, hoisted his flag. Through the hottest part of the action Lieut.-Commander Chappell kept his boat right off the Mole, on the beam of *Vindictive*, to screen, as much as possible, the latter vessel with his smoke. Every now and then when they came to the end of their short patrol the smoke blew away, exposing them to the full glare of the searchlights from the Mole. The only escape was to turn sixteen points into their own smoke and make their way back and renew the manœuvre. This the M. L. kept up during the time that the storming party from the *Vindictive* landed on the Mole, and it undoubtedly saved them from much of the fire from the western shore batteries. It was Captain Collins himself who hailed the blockships during the early part of the action and directed them to the entrance of the enemy harbour, after Lieut.-Commander Young's boat had been sunk, whose duty this was originally. It was during one of the exposed moments that I have mentioned that Lieut.-Commander Chappell's boat had its miraculous escape. A 6-inch shell landed on their magazine hatch, ricocheted on to a box of six-pounder ammunition and blew up the latter without, however, exploding every shell. The iron top of the hatch was blown clean away, but fortunately the explosion expended itself upwards instead of downwards, otherwise nothing could have saved the ship. Some of the cordite from the six-pounder shells exploded in mid-air after the shells had been blown to pieces in a very curious way, for the force of the explosion really burst the shells instead of detonating them in the usual way. The only real damage it did was to set the foredeck on fire, but once again the magazine was saved by the quick action of the Number One, Lieut. C. C. Calvin, who extinguished the flames very promptly with pyrene.

"There were other narrow escapes on M. L.'s that night; for instance, on one a shell fell into the engine room, but did not explode. But it is not possible to narrate every story, or to pretend that this account is that of an eye-witness, the dense artificial fog, or smoke, in which the action took place would render such impossible. As regards the eye-witness point of view, I can speak only of what happened on my own M. L. Perhaps I am justified in telling the story.

"We were the most westerly boat of unit 'G,' whose duty it was to find No. 4 buoy previously laid down by a Coastal Motor Boat. This in the darkness, we failed to pick up, so when we considered we were in the approximate position (fairly accurately, we subsequently discovered) we dropped our buoy, and stood by as the smoke patrol boats passed us, turned, and disappeared to the eastward. It was a signal for a fresh shower of shrapnel and pompom shells around us, a good deal closer than was pleasant. This gave us an idea. If the Germans liked to fire at us, why shouldn't they, as long as the position of those buoys was where we wanted them? Accordingly, under cover of the thick pungent smoke, we steamed northwards for a minute and then westward at full speed for two miles, and then, more cautiously, we made our way in-shore. We must have been about five hundred yards or so away, for by the light of the star shells over Zeebrugge we could see the beach and the sandhills plainly. All at once the beams of a powerful searchlight blazed out from the shore and swept about us. At first we were not located, but after a moment they picked us up and then the batteries opened up. A buoy was dropped at once and managed to dodge the beams of the searchlight behind the thick smoke that poured off. We drew off about a quarter of a mile, but the batteries still continued blazing away at the buoy and the searchlight was trying to pierce the smoke to discover what was behind the flare. We dropped a second buoy, and about a quarter of a mile further on let go to a third. All these sent up the same bright flare, and a perfect fusillade from the western shore batteries was poured forth at them. We were out to sea again, and as no shots came near us, we waited to note the effect of our little ruse. It certainly seemed to be answering, for we undoubtedly had the Hun guessing. Those lights so close to shore, away from the main operation, evidently puzzled him; possibly he imagined that something in the nature of a landing was being attempted, but whatever he thought, he certainly wasted a lot of ammunition on nothing, which meant the less for Vindictive alongside the Mole.

"It appealed to our sense of humour to think that one solitary little M. L., a couple of miles away from its friends and relations, could put the 'wind up' the Hun to that extent. Had we not been getting short of buoys and in need of what we had left for our correct position,

we should have been tempted to repeat the experiment, but we steamed back to our original place in the line and carried on smoking till the time for the retirement. But we had nothing much nearer us, beyond stray shots. I think the western batteries were still waiting for the fictitious landing party somewhere Blankenherge way. Credit for the success of our run is very largely due to my Number One, Lieut. Gordon Ross, who carried on during the whole action with a broken finger, superintending and assisting in the dropping of the buoys, no light articles, and awkward to handle on the narrow gangways of an M. L.

"On our way to the rendezvous we waited for about half an hour off Zeebrugge in case we could be of assistance to any men or vessels in distress. Vindictive, Iris and Daffodil we knew had gone, for they were working to a schedule of time, but we saw nothing, though we kept a good look out for pursuing German craft. Apparently none came out. I think they were too rattled, and too thankful that the British had done, to worry about pursuit.

"Then full speed for the rendezvous, but there were no ships there. And so on, still full speed, for Dover. I shall never forget that run, tearing through the blackness of night 'all out.' About half way we had a bit of excitement, a dark shape was sighted upon our port bow; it was a ship of sorts and looked very like a submarine. We challenged it at once, and by its reply we knew it to be a friend, so we closed it and discovered that it was an M. L., curiously enough one of our own unit. They also had seen no one since leaving Zeebrugge, so we sped on in the darkness together. When dawn broke we were still out of sight of land and a slight haze on the water made visibility bad. The first thing we picked up was a wreck on the Goodwin Sands, which loomed up out of the mist rather nearer than we thought ourselves to be. Soon the white line of breakers warned us that we must alter our course to the northward. We reached Dover Harbour just as Vindictive had entered. That entry will be in my mind for ever. About six M. L.'s were converging out of the fast clearing mist, and I am afraid we all raced for the western entrance. Our ship won; and had the honour of being the first M. L. to enter harbour from the Zeebrugge action.

"Then came what was to me the most stirring part of the whole

affair. As the six M. L.'s passed *Vindictive*, battle-scarred and covered with the signs of her wonderful fight, all eyes were turned upon her and the men who thronged her deck. Then those men, remnants of the landing party and the ship's company, each of whom deserved the V. C., waved their caps and cheered again and again as the M. L.'s steamed slowly past. We could scarcely believe our ears that these men, whom we felt we ought to be cheering, actually got in first with a cheer for the M. L.'s who had helped them in their wonderful achievement.

"That cheer went home straight to the heart, and its echoes will sound there till my dying day. Our little ships' companies replied lustily and our sirens added their voices. But to be cheered first—well, I am not ashamed to own that a lump came into my throat. To lead the first M. L.'s into harbour from Zeebrugge and to be cheered by *Vindictive's* crew—it seems like a dream now that I look back upon it.

"During the next few hours the M. L.'s returned to port in dribbles, some bearing the marks of their narrow escapes from enemy gun fire or collision in the fog. These hours were anxious ones for us, waiting to learn who was safe and who had fallen. At length all had returned but two, and of these two we had received reports of their loss. Then we knew the fate of all who had gone into action with us. The feeling in our hearts was mixed; genuine sorrow for the good comrades who had made the Great Sacrifice and thankfulness at our own escapes, and, being human, a certain amount of pride that we had helped in an action that will live in History."



Reproduced by permission from "The Graphic."

The M. L.'s placing guiding flares and screening the larger vessels with an artificial fog.

CHAPTER III

THE "MOVIES" AT OSTEND

SIMULTANEOUSLY with the attack on Zeebrugge, there was launched a similar raid on Ostend, at which point the other end of the Bruges Canal furnished a second convenient haven for the German subs, and while this offensive was destined to meet with less success than that at Zeebrugge, the M. L.'s carried off their part of the program just as efficiently.

The block ships "Brilliant" and "Sirius" were unsuccessful in reaching the mouth of the canal, but the work of rescuing their crews was accomplished by the M. L.'s under conditions just as harrowing as those at Zeebrugge. To be sure there was no breakwater to negotiate, but, on the other hand, there was no landing party to divert the fire of the enemy, which was concentrated on the blockships and their tiny escort.

The motor launches were under the command of Commodore Herbert Lynes but the organization of the flotilla at this engagement as well as Zeebrugge was the work of Capt. Hamilton Benn, D. S. O., R. N. V. R., who led them into action.

The failure of the blockships to find the narrow entrance to the canal on the night of April 22d was due to the shifting by the Germans of the buoy off the entrance and to the fact that a last minute shift of wind carried the smoke screen landward across the mouth of the harbor, obscuring it from view. Both block ships were lost after a hot engagement during which they returned the enemy's fire until practically shot to pieces, but their crews were rescued and returned to Dunkirk in safety.

A second and more successful effort to block Ostend harbor was carried out on the night of May 9th. The story of this "pukka show" as the "limies" themselves would call it, has been told by S. M. R. in *The Yachting Monthly*, and is in part as follows:

"The first daring stroke failed to block the harbor and the Sirius lies in the surf some two thousand yards east of the entrance, which the old war ship gallantly failed to obstruct, and when in the early

hours of morning the battle scarred Vindictive groped her way through the smoke screen and headed for the entrance it needed but little imagination to picture the old fighting ship awake and looking on. One of the M. L.'s had visited her and hung a flare in her slack and rusty rigging, and that eye of unsteady fire, paling in the blaze of the star shells or reddening through the drift of the smoke, watched the whole great enterprise from the moment when it hung in doubt to its ultimate triumphant success.

"The main problem now was to secure the effect of a surprise attack upon an enemy who was clearly from his ascertained dispositions, expecting him. The Sirius and the Brilliant had been baffled by the displacement of the Stroom Bank buoy, which marks the channel to the harbor entrance, but since then aerial reconnaissance had established that the Germans had removed the buoy altogether and that there were now no guiding marks of any kind. They had also cut gaps in the piers as a precaution against a landing, and further when toward midnight on Thursday the ships moved from their anchorage it was known that some nine German destroyers were out and at large on the coast.

"It was a night that promised well for the enterprise—nearly windless, and what little breeze stirred came from a point or so west of north; a sky of lead blue, faintly star dotted, and no moon; a still sea for the small craft, the motor launches and the coastal motor boats.

"From the destroyer which served the Commodore for flagship the remainder of the force was visible only as swift silhouettes of blackness, destroyers bulking like cruisers in the darkness, motor launches like destroyers, and coastal motorboats showing themselves as racing hillocks of foam. From Dunkirk a sudden and brief flurry of gunfire announced that German airplanes were about—they were actually on their way to visit Calais—and over the invisible coast of Flanders the summer lightning of the restless artillery rose and fell monotonously.

"'There's the Vindictive!'"

"The muffled seamen and marines standing by the torpedo tubes and guns turned at that name to gaze at the great black ship, seen mistily through the streaming smoke from the destroyer's funnels, plodding silently to her goal and her end. Photographs have made familiar that high side profile and the tall funnels with their Zeebrugge

sears, always with a background of the pier at Dover against which she lay to be fitted for her task. Now there was added to her the environment of the night and the sea and the greatness and tragedy of her mission.

"She receded into the night astern as the destroyer raced on to lay the light buoy that was to be her guide, and those on board saw her no more. She passed thence into the hands of the small craft, whose mission it was to guide her, light her and hide her in the clouds of the smoke screen.

"There was no preliminary bombardment of the harbor and the batteries as before the previous attempt; that was to be the first element in the surprise. A time table had been laid for every stage of the operation and the staff work beforehand had even included precise orders for the laying of the smoke barrage with plans calculated for every direction of wind. The monitors, anchored in their firing position far to seaward, awaited their signal; the great siege batteries of the Royal Marine Artillery in Flanders, among the largest guns that have ever been placed on land mountings, stood by likewise to neutralize the big German artillery along the coast and the airmen who were to collaborate with an aerial bombardment of the town waited somewhere in the darkness overhead. The destroyers patrolled to seaward of the small craft.

"The *Vindictive*, always at that solemn gait of hers, found the flagship's light buoy and bore up for where a coastal motor boat, commanded by Lieut. Slayter, R. N., was waiting by a calcium flare upon the old position of the Stroom Bank buoy. Four minutes before she arrived there and fifteen minutes only before she was due at the harbor mouth, the signal for the guns to open was given.

"Two motor boats under Lieut. Reid, R. N. R., and Lieut. Poland, R. N., dashed in toward the ends of the high wooden piers and torpedoed them. There was a machine gun on the end of the western pier and that vanished in the roar and the leap of flame and debris which called to the guns. Over the town a flame suddenly appeared high in air and sank slowly earthwards, the signal that the airplanes had seen and understood, and almost coincident with their first bombs came the first shells whooping up from the monitors at sea. The

surprise part of the attack was sprung. The surprise, despite the German's watchfulness, seems to have been complete.

"Up to the moment when the torpedoes of the motor boats exploded there had not been a shot from the land—only occasional routine star shells. The motor launches were doing their work magnificently. These pocket warships, manned by officers and men of the Royal Naval Volunteer Reserve, are specialists at smoke production. They built to either hand of the *Vindictive's* course the likeness of a dense sea mist driving landward with the wind. The star shells paled and were lost as they sank in it; the beams of the searchlights seemed to break off short upon its front. It blinded the observers of the great batteries, when suddenly, upon the warning of the explosions, the guns roared into action.

"There was a while of tremendous uproar. The coast about Ostend is ponderously equipped with batteries, each with its name known and identified—*Tirpitz*, *Hindenburg*, *Deutschland*, *Cecilia* and the rest. They register from six inches up to monsters of fifteen-inch naval pieces in land turrets, and the Royal Marine Artillery fights a war long duel with them. These now opened fire into the smoke and over it at the monitors. The marines and the monitors replied. Meanwhile the airplanes were bombing methodically and the anti-aircraft guns were searching the skies for them. Star shells spouted up and floated down, lighting the smoke banks with spreading green fires, and these strings of luminous green balls, which airmen call "flaming onions," soared up to lose themselves in the clouds. Through all this stridency and blaze of conflict the old *Vindictive*, still unhurrying, was walking the lighted waters toward the entrance.

"It was then that those on the destroyers became aware that what had seemed to be merely smoke was wet and cold, that the rigging was beginning to drip, that there were no longer any stars—a sea fog had come on.

"The destroyers had to turn on their lights and use their sirens to keep in touch with each other. The air attack was suspended and the *Vindictive*, with some distance yet to go, found herself in gross darkness.

"There were motor boats to either side of her, escorting her to the entrance, and these were supplied with what are called Dover

flares—enormous lights capable of illuminating square miles of sea at once. A Very pistol was fired as a signal to light these, but the fog and the smoke together were too dense for even the flares. The Vindictive put her helm over and started to cruise to find the entrance. Twice in her wanderings she must have passed across it and at her third turn, upon reaching the position at which she had first lost her way, there came a rift in the mist and she saw the entrance clear, the piers to either side and the opening dead ahead.

“The inevitable motor boat dashed up (No. 22, commanded by acting Lieut. Guy L. Cockburn, R. N.), raced on into the opening under a heavy and momentarily growing fire, and planted a flare on the water between the piers. The Vindictive steamed over it and on. She was in.

“The guns found her at once. She was hit every few seconds after she entered, her scarred hull broken afresh in a score of places and her decks and upper works swept.

“The machine gun on the end of the western pier had been put out of action by the motor boat’s torpedo, but from other machine guns at the inshore ends of the pier, from a position on the front and from machine guns apparently firing over the eastern pier, there converged upon her a hail of lead. The after control was demolished by a shell which killed all its occupants, including Sub-Lieut. MacLachlan, who was in command of it. Upper and lower bridges and chart room were swept by bullets, and Commander Godsall, R. N., ordered his officers to go with him to the conning tower.

“There they observed that the eastern pier was breached some 200 yards from its seaward end, as though at some time a ship had been in collision with it. They saw the front of the town silhouetted again and again in the light of the guns that blazed at them: the night was a patchwork of fire and darkness.

“Immediately after passing the breach in the pier Commander Godsall left the conning tower and went out on deck, the better to watch the ship’s movements. He chose his position and called in through the slit in the conning tower his order to starboard the helm. The Vindictive responded. He laid her battered nose to the eastern pier and prepared to swing her 320 feet of length across the channel.

“It was at that moment that a shell from the shore batteries struck

the conning tower. Lieut. Sir John Alleyne and Lieut. V. A. C. Crutchley, R. N., were still within. Commander Godsall was close to the tower outside. Lieut. Alleyne was stunned by the shock. Lieut. Crutchley shouted through the slit to the Commander, and receiving no answer rang the port engine full speed astern to help in swinging the ship.

"By this time she was lying at an angle of about 40 degrees to the pier and seemed to be hard and fast, so it was impossible to bring her further round. After working the engines for some minutes to no effect Lieut. Crutchley gave the order to clear the engine room and abandon ship, according to the programme previously laid down.

"Engineer Lieutenant Commander Bury, who was the last to leave the engine room, blew the main charges by the switch installed aft. Lieut. Crutchley blew the auxiliary charges in the forward six-inch magazine from the conning tower. Those on board felt the old ship shrug as the explosive tore the bottom plates and the bulkheads from her. She sank about six feet and lay upon the bottom of the channel. Her work was done.

* * * * *

"Most of the casualties were incurred while the ship was being abandoned. The men behaved with just that cheery discipline and courage which distinguished them in the Zeebrugge raid. Petty Officer Reed found Lieut. Alleyne in the conning tower, still unconscious, and carried him aft under a storm of fire from the machine guns. Lieut. Alleyne was badly hit before he could be got over the side and fell into the water. Here he managed to catch hold of a boat fall, and a motor launch under Lieut. Bourke, R. N. V. R., succeeded in rescuing him and two other wounded men.

"The remainder of the crew were taken off by Motor Launch 254, under Lieut. Drummond, R. N. V. R., under a fierce fire. When finally he reached the Warwick the launch was practically in a sinking condition. Her bows were shot to pieces. Lieut. Drummond was himself severely wounded. His second in command, Lieut. Ross, R. N. V. R., and one hand were killed. A number of others were wounded. The launch was found to be too damaged to tow and day was breaking.

"She and the Warwick were in easy range of the forts, so as soon

as her crew and the *Vindictive's* survivors were transferred a demolition charge was placed in her engine room and she was sunk.

"Always according to programme, the recall rockets for the small craft were fired from the flagship at 2:30 a. m. The great red rockets whizzed up to lose themselves in the fog. They could not have been visible half a mile away, but the work was done and one by one the launches and motor boats commenced to appear from the fog, stopped their engines alongside the destroyers and exchanged news with them.

"There were wounded men to be transferred and dead men to be reported, their names called briefly across the water from the little swaying deck to the crowded rail above. But no one had seen a single enemy craft. The nine German destroyers who were out and free to fight had chosen the discreeter part."

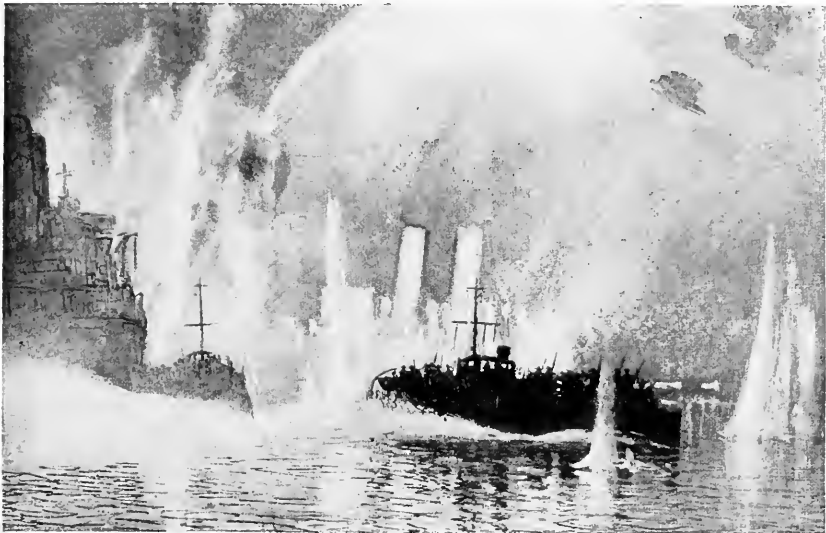

Reproduced by permission from "The Graphic."

The M. L.'s at Ostend rescuing the crews of the blocking ships.

THE CINDERELLAS OF THE FLEET

THE SONG OF THE "SEA SLUGS"

(ANONYMOUS)

Sing me a song of a frail M. L.
 May the Lord have mercy upon us;
 Rolling about in an oily swell,
 May the Lord have mercy upon us;
 Out on a high explosive spree,
 Petrol, Lydite, and T. N. T.,
 Looking for U-Boat 303,
 May the Lord have mercy upon us.

Sing me a song of a bold young "Lieut."
 May the Lord have mercy upon us;
 Two gold bands on an "Owed for suit,"
 May the Lord have mercy upon us;
 Ship the cable and full ahead,
 Hard a starboard and heave the lead,
 The detonators are in my bed,
 May the Lord have mercy upon us.

Sing me a song of a bright young "Sub."
 May the Lord have mercy upon us;
 A terribly ignorant half-baked cub,
 May the Lord have mercy upon us;
 Of the King's Regulations he knows not one,
 He has left undone what he ought to have done,
 And Oh! My Lord, when he fires that Gun,
 May the Lord have mercy upon us.

Sing me a song of a CMB (Engineer),
 May the Lord have mercy upon us;
 Bred in a garage and sent to sea,
 May the Lord have mercy upon us;
 Taken away from the motor trade,
 Seasick, sorry and sore dismayed,
 But a hell of a "Knut" on the Grand Parade,
 May the Lord have mercy upon us.

Sing me a song of the M. L. Cook,
 May the Lord have mercy upon us;
 With a Petrol stove in a greasy nook,
 May the Lord have mercy upon us,
 Our meals a lukewarm lingering death,
 We'll praise the Ilun with our final breath
 If he'll strafe our Galley and slay our Chef,
 May the Lord have mercy upon us.

Sing me a song of a North Sea Base,
 May the Lord have mercy upon us;
 A dirty forgotten one horse place,
 May the Lord have mercy upon us;
 When the wind blows West how brave we are!
 When the wind blows East, it's different far,
 We wish we were back in the Harbour Bar,
 May the Lord have mercy upon us.

Part II

The American Submarine Chasers

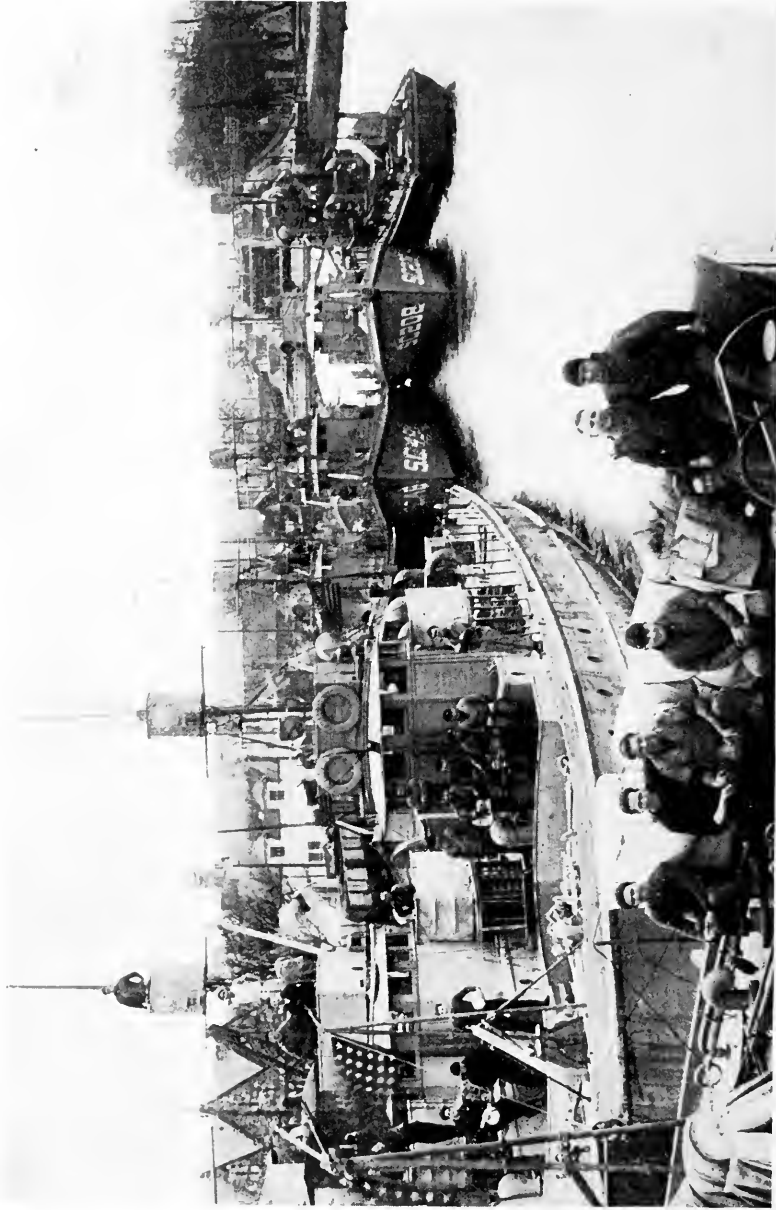

Photograph by courtesy of E. M. Laughan, U.S.N.R.F.
American Chasers at Inverness, Scotland. After the fighting was over these boats were engaged in the stimulating work of destroying the American 53,000 mines that obstructed the North Sea.

CHAPTER IV

THE AMERICAN SUBMARINE CHASERS.

IT was not until the summer of 1916 that our own Navy Department began to display an interest in the submarine swatter idea, which the Allied Powers were taking so seriously. The potential value of a vast fleet of privately owned yachts and motor craft as auxiliaries to the Navy in the event of war was appreciated, of course, as it had been by both England and Germany at the outbreak of hostilities, and for this reason the Department authorized and solicited the cooperation of the yachtsmen of the country in the civilian cruises and the accompanying manoeuvres for motor boats. Furthermore, the Navy Department, realizing that much could be learned from the architects who had specialized in this type of boat, solicited suggestions in the form of designs for motor boats which would be suitable for conversion for the use of the Navy, and actually ordered two boats as an example to patriotic yachtsmen who might wish to build. But little else was done until the war was actually upon us.

Then all at once we became uncomfortably conscious of our long and unprotected coast line, the vulnerability of which already had been forcefully demonstrated by the arrival of the "Deutschland" and the escapade of the "U-53." Our venerable confidence in our ability to take down the old musket from its peg on the wall, if the occasion actually demanded it, and walk out and chasten the world, depending rather on American nerve than on any equipment or preparation in particular, was suffering a rude awakening. We thought of our destroyers. They were few. We ordered many more of them. When would they be completed? In two years at the earliest.

We were inclined to put our trust in destroyers when it came to such a job as hunting submarines—that is, the Navy was. But from the first of the World War there were those who believed that the destroyer was not the final solution to the problem. Those of us whose business and hobby it was to know small boats raised our voices in behalf of them. We preached motor boats, we wrote, we painted, we did everything but sing our belief in them and finally the idea that



The steel bulkheads were set up on the keelson and used as molds.

had got across to England and France and Italy and even to Russia began to "get across" over here.

Destroyers, bully boats that they are, cost a million apiece and could not be built in a hurry. Submarines were a prolific breed, multiplying with incredible rapidity, and at this stage of the game Germany was placing her hope of victory more and more in her *unterseeboots* and every available yard was given over to the fabrication of super-sub capable of crossing the Atlantic and returning to their bases on a single fueling. These boats were carrying their "war" over an ever-increasing area and since it seemed to be the accepted policy to pursue the individual hornet over a great part of the North Atlantic and the Mediterranean instead of attempting to burn out his nests, it became evident that a few score destroyers were not a drop in the bucket.

What was needed for this work was an immense fleet of small, quickly built, easily manoeuvred vessels, with power plants that could be shut down instantly in order to use the newly developed listening devices, and started again time and again without end—a thing well nigh impossible with a destroyer. It was obvious that a dozen such vessels, even with lighter guns, stood a better chance in the game of

submarine hunting than a single destroyer at the same cost. With the advent of the depth bomb for destroying the submerged sub, the superiority of a vast fleet of small boats was even more apparent.

By this time reports of the performance of the M. L.'s on the other side began to come in. These reports varied widely according to who made them, but the consensus of opinion seemed to be that they already were doing a great deal more than justifying their existence. And so it was that the Navy Department turned its attention to the design of a suitable type of boat. The officials of the Standard Motor Construction Company were sent for by the Secretary of the Navy and were informed that the company's cooperation in this emergency was desired. The Navy's requirements were met at a lower cost than had been expected and a guarantee was given to supply the motors at a rate to keep pace with the building of the boats.

With the problem of the propelling machinery out of the way, the next question was that of the most suitable type and size of hull to meet the conditions under which the boats would be called upon to operate. Mr. A. Loring Swasey, a naval architect of broad experience in the design of motor driven craft was summoned to cooperate with the Bureau of Construction and Repair and the design of the 110-foot Submarine Chaser was the result.

The early idea had been that a submarine chaser should be very fast above all else, but as the submarine developed and enlarged its field of operation, necessitating a real sea-going type of chaser, extreme speed was no longer considered worth the price in comfort and seaworthiness that must be paid for its attainment. Another idea dear to the hearts of the newspaper writers was that the boats should be very shoal of draft so as to be immune from torpedo attack. And less importance was placed on armament for it was popularly supposed that any old sort of a shooting iron would do to pop the periscope of a defenseless U-boat.

Then when it was appreciated that extreme speed and shoal draft were more a talking point than anything else, and when it was seen that the submarine was no longer a defenseless, vulnerable thing, but had become an armed and armored fighter, the demand was for larger boats that could mount a sizable gun and that would be liveable possibly for many days on end.



Motors installed and ready for the decks.

Now it is not necessary to employ the same extreme form to attain a given speed with a large boat that it is with a small one. Take for instance the V-bottom form developed by William H. Hand, Jr., a form of unchallenged merit for fast boats up to a moderate size. Mr. George Crouch has found that the critical speed at which the V-bottom form becomes more efficient than a well-designed hull with round bilges is in miles per hour numerically equal to four times the square root of the length in feet. That is to say 20 miles an hour for a 25-footer and 40 miles an hour for a 100-footer.

For sea work there are several well defined requirements. What is necessary is a generous under-water body of a shape with plenty of deadrise, that is, wedge-shaped in section rather than flat or round. The hull should not be designed as were those of the M. L.'s and most of our so-called express cruisers, with a broad, flat after body or run and fine waterlines at the bow. It is obvious that the great bulk aft and the lack of it forward make for erratic action in a following sea when the stern is lifted bodily and the bow depressed. More or less symmetrical ends are desirable.

Then again the pronounced hollow flare or flam that many de-

signers work into the topsides at the bow is of more use in throwing off spray than in keeping the bow from rooting. The normal flare, like that say of the whaleboat, is a type unsurpassed for sea work since the time when the Vikings braved the Western Ocean. And that is just about what the design of the 110-footers amounts to—a big whaleboat cut off at the waterline aft. Incidentally, this form of hull is extremely easy to drive at moderate speeds and it is seldom that the condition of the sea will permit a small boat to be driven at anything more than moderate speeds.

This type of boat, the lines of which appear on another page, was unlike anything hitherto turned out by the Navy and, as was to be expected, it caused a storm of criticism from the battle wagon men. Even the people who professed to know small boats took a shot at it, for it was just as unlike any yacht or motor boat of its size as it was unlike any naval vessel existing or extinct. The remarkable speeds attained by our hydroplanes and our express cruisers in smooth water, not to mention the pseudo-scientific Sunday supplement, were responsible for the popular belief that boats for hunting submarines should be able to clip off at least thirty or forty knots. Therefore when it was announced that the new Chasers would do sixteen or seventeen at the outside, the public was disappointed.

But the Bureau of Construction and Repair had confidence in the design and went ahead with preparations to have the boats built. Instead of concentrating the job at a single huge plant, it was decided to build the boats in the existing boat building yards all over the country, a plan that at first glance seemed doomed to failure. That it did not fail but proved just about as successful as any program this country put through during the war, not only speaks volumes for the Bureau but also is a flattering commentary on the American Boat Building Industry.

The motor used in the American Submarine Chasers, like that of the British M. L.'s, is a stock model made by the Standard Motor Construction Company of Jersey City, N. J. The job of producing all these motors was tremendous even with the best of modern production methods. In a little over three years the Standard Motor Construction Company delivered about 700,000 b.hp. of this model alone. That is enough power to drive 25 of the large super-

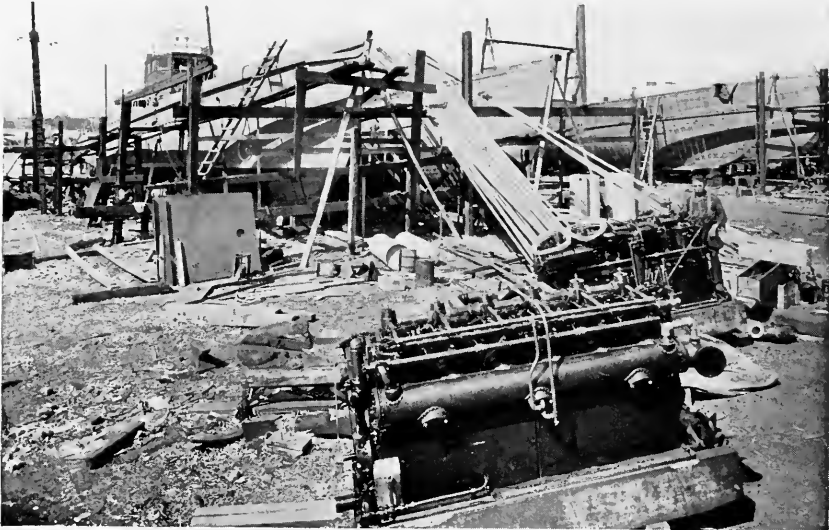

Three of these 220-horse Standard motors were installed in every Chaser and the production of engines kept pace with the completion of the hulls.

dreadnaughts like the *Arkansas*; more than will be needed for our proposed battleship program for the next three years. It is only by making such a comparison that the size of this submarine chaser undertaking is comprehended. We may well be proud of such a showing.

SEAWORTHINESS

To illustrate the remarkable seaworthiness of the Submarine Chasers, I am going to chronicle the story told me by an S. C. skipper, who knows the Chasers from truck to keel. He has taken his boat across the Atlantic and back again, not to mention numerous convoying expeditions to Bermuda and this is the account of the particular party that he considers the most strenuous of all his experiences. Here it is:

It was in June, 1918, while returning to Norfolk after escorting troop transports through the danger zone that we were caught in a nasty bit of weather. We were probably 150 miles out and were headed for Cape Charles lightship, averaging 10 knots, when the weather began to thicken. It blew up from the southeast, with light rain squalls, and the barometer gave every indication of approaching bad weather.

The fact that the entire fleet of eighteen Chasers had only just enough fuel to reach port, did not add to our peace of mind.

About six in the evening it began to blow great guns, with fog and rain, which meant that it was next to impossible to maintain any sort of position. Luckily we had the wind on our quarter, so that we rode easily and made fairly good time. As the night wore on the wind stiffened with incessant rain and hail squalls. We were leading one column and had an awful job maintaining position on the destroyer that commanded the fleet, but we managed to do it, although none of us showed lights.

About four in the morning it was blowing a good 75 miles an hour and was so thick that the fleet became badly scattered. Measuring my gas tanks, I found I had about three hours' fuel left, and so I dumped twenty gallons of kerosene—all that I had aboard—into the tanks in hopes that this would take us in.

At six o'clock, as we had not picked up the lightship, I thought it best to take a sounding, and got thirteen fathoms. A half hour later we sounded again and got twelve. By this time the destroyer had disappeared entirely, and I decided to run due south in the hope of clearing Cape Charles and picking up Cape Henry. The seas were breaking clear over us, and as we were running on only one engine, to save fuel, I found it impossible to control the vessel. We kept falling off into the trough, and upon taking another sounding, we found only nine fathoms, which accounted for the nasty character of the seas. They were treacherous seas and seemed to break clear from the bottom with crests that smothered us every time they broke.

Between waves I managed to get a few men out of the fo'csle, who, with lines lashed to their waists, began the almost impossible task of getting out additional cable. It was my plan to shackle on a seventy fathom chain to a sixty fathom towing hawser, then to anchor and ride it out.

Just then there occurred the most remarkable roll I have ever seen a Chaser indulge in. A breaking sea slapped us onto our beam ends and before we could recover, a second big comber caught us just right and from my position in the pilot house I saw the entire ship disappear beneath the water. Down and down we went until I seemed to be lying flat on my back against the cabin side where a second before I was



A Chaser is about the size of a modern Gloucester fishing schooner with some of the latter's good points.

standing upright. One man on the lee side of the bridge touched the water. A spy glass, which was kept on a shelf on the weather side of the pilot house, fell through the intervening space and out the opposite window which, when on an even keel, was higher than the shelf. Then the motor stalled and I received the cheerful word that there was three feet of water in the engine room, which had come through the cowls of the ventilators.

Finally we righted, and how the one man in the engine room ever did the trick, I don't know, but in a few seconds we were chugging ahead again with the deck swept clean of every piece of gear.

Fortunately the destroyer hove into view just at this time, and after finding out that we had barely an hour's fuel left, she took us in tow. The job of passing a line and hauling in that nine-inch towing hawser seems impossible now, but it was finally accomplished, although for every man who hauled another was necessary to keep him from being swept overboard, and all of us worked in water up to our waists.

Once in tow, we were better off and in a few hours' time made Hampton Roads.

Some of the other Chasers fared worse than we did. Some had men swept away, never to be seen again, but one by one they all made port. Below decks every boat was a wreck. Galley stoves, mess tables, bunks, everything, wrenched from its moorings and smashed to kindling, but the hulls and the motors stood the gaff and not a boat reported serious damage. Big ships were lost in that storm, ocean-going tugs foundered, steamers grounded, but the 110-foot bottles were well corked and although they disappeared from view time and again in the terrible breaking seas, which were infinitely worse than anything experienced in deep water, they never failed to come up. They proved that day that they could live through anything.

* * *

To Secretary Daniels, Assistant Secretary Roosevelt, Admirals Griffin and Taylor, and to other high officials of the Navy Department must go the credit for open mindedness and imagination enough to foresee the possibilities of a type of vessel for which there was no precedent. To Commander J. A. Furer, under whose immediate charge the building program was carried out, to Commander Joe Fisher, in charge of powering the little vessels, and to Lieut. Commander A. Loring Swasey, U. S. N. R. F., who collaborated with the Bureau of Construction and Repair in designing them and who had charge of building most of them, particular credit must be given. But even with an excellent design and the brains to organize the work of production, few of the boats would have been completed on time had it not been for the untiring efforts of the corps of inspectors drawn from the motor boat industry, who directed the work where direction was needed, smoothing out apparently insurmountable difficulties with their admirable enthusiasm. From the Chief Constructor to the thousands of workmen engaged on the job, this organization functioned with an enthusiasm, a lack of self-interest, an *esprit de corps* that was nothing short of magnificent.

Tale after tale might be written of the difficulties encountered and overcome in the building and delivering the boats on time—stories that prove that the fighting of the war was not all on the other side of the Atlantic. Here is one: Eight of the boats built at Kingston, a hundred miles or so up the Hudson River from New York, were caught by the early freeze-up of 1917 that locked the river tighter



A completed Chaser waiting her turn at the launching ways.

than it had been locked within the memory of the oldest inhabitant. Twelve-inch ice paralyzed navigation—but the boats were needed:

It looked like a big delay, but at the command of the New York office an utterly unprecedented thing was done. Five of the boats were placed on a floating drydock with the remaining three made fast astern, protected from the ice by a barge on either side, and a fleet of ten tugs was commandeered to tow the outfit down the river. The start was made one Thursday night with the thermometer at 24 degrees below zero. The progress was slow and the work was heart-breaking. One day the little fleet was driven back fifteen miles by the tide and wind. But on Monday morning it arrived in New York. The crews had been on the job continuously for four days and nights in the bitter cold and with but little food. Many a man has won the *Croix de Guerre* for a less heroic job.

CHAPTER V
EQUIPMENT OF THE CHASERS

ARMAMENT

THE gun with which the majority of the Chasers were equipped was in many respects like that used on the British M. L.'s. It is a short-caliber 3-inch Poole gun with long recoil and with somewhat less range than the regular Navy gun of the same bore, and is adaptable to high-angle fire for anti-air-craft work. Several types of shells were carried including shrapnel for close range and air-craft work, high-explosive for attacking a submarine on the surface and the newly-developed non-ricochet type with the flat nose which was used when attacking a submerged submarine at a distance. And then there was a dummy shell loaded with sand, which was used only in target practice.

Besides the deck gun two machine guns of the Lewis or Colt type were carried on the wings of the bridge and there were rifles for the men and automatic pistols for the officers.

But the depth bomb was by far the most formidable weapon carried by the Chasers. The Mark II depth bomb weighs in the neighborhood of 300 pounds and is arranged that it may be set to explode at any required depth merely by the adjustment of a dial on the outside. The terrible havoc wrought by the detonation of 250 pounds of T.N.T. fifty feet or so beneath the surface of the sea, really must be seen—and felt and heard—to be appreciated. One of the photographs gives some idea of what happens.

Originally these ash cans were carried in cradles at the stern of the vessel to be shoved overboard by hand when needed, but with the improvement of the bomb it was found that only on the faster vessels would such a method of launching be safe. Slower vessels were in danger of having their sterns blown off before they could reach a safe distance. The next step was the development of the howitzer for hurling the bombs clear of the ship and then the Y-gun, with which practically all the Chasers were equipped.



Photograph by Ensign Henry Bonnell, U.S.N.R.F.

The effect of 300 lbs. of T. N. T. showing why it was desirable to ring up full speed ahead before dropping an ash can over the stern. This bomb was set to explode at a depth of 100 ft.

THE Y-GUN

If you will look at the deck view of a fully-equipped Chaser you will notice a Y-shaped instrument installed somewhat aft of amidships, between the two trunks, its arms pointing over the sides at an angle of about 45 degrees. This is the Y-gun, or as we used to call it in the days of the censorship, the Siamese twins. With this gun two bombs were hurled over the quarters simultaneously and although the hand method of launching over the stern was still used on the Chasers, it is obvious that the Y-gun considerably increased the area of destruction.

It will be seen from the close-up portrait of the Y-gun and the section of motion picture film taken at the instant of discharge, that the cans are held on the ends of plungers which fit the bore of the gun and which are discharged along with the bombs. A blank 3-inch shell is inserted in the breech at the intersection of the barrels and is fired by means of a lanyard in the usual way. The plungers with their bombs are hurled fifty yards or so clear of the vessel and as they are

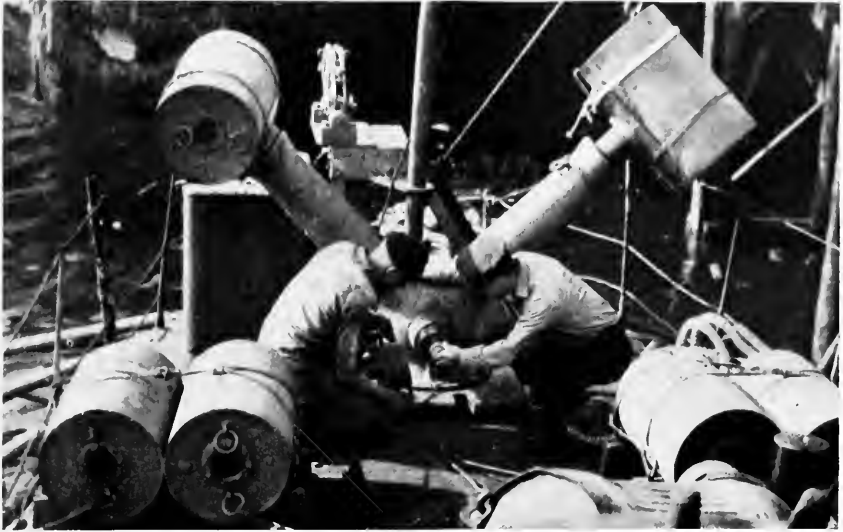

Photograph by Keystone View Co.

An excellent portrait of a Y-Gun with ash cans in place. A blank 3-inch shell is inserted in the breech as shown and the depth bombs with the plungers on which they are carried are hurled simultaneously well clear of the vessel. The bombs may be set to explode at any predetermined depth by the indicator on the end.

discharged simultaneously, it will be seen that the lateral component of the recoil is neutralized leaving nothing but a downward thrust which is taken up by a stanchion supporting the deck.

THE WIRELESS TELEPHONE

It would be hard to overestimate the value of the wireless telephone which was one of the many points of superiority that the S. C.'s had over the M. L.'s. This means of communication, being independent of fog or light or the condition of the weather, with the possible exception of electrical storms, rendered the semaphore and the blinker and even the ordinary wireless obsolete and permitted the Chasers to maneuver at lightning speed. Of course when hunting submarines it was not the custom to converse over the telephone as in ordinary conversation. All communication was carried on in code by means of letters and to avoid the confusion due to the similarity in the sounds



Photograph by courtesy of W. C. Van Natta, C.M.M., U.S.N.R.F.

Rehearsing for a possible sub off Gibraltar, which shows faintly in the distance to the right.

of many letters, the letters of the alphabet were given names which were used instead. For instance, suppose the code message read: "A B Q;" the sender would shout: "Abel Boy Quack" and instantly every Chaser in the vicinity responded. An ordinary wireless receiving outfit, if properly tuned, will pick up wireless telephone messages and the operators in the vicinity of a flock of sub-chasers must have been startled by the ludicrous things they overheard.

DIRECTIONAL HYDROPHONES OR LISTENING TUBES

All American Chasers operating in foreign waters were equipped with several distinct types of listening apparatus for determining the position of a submarine by the sound of its propelling machinery transmitted through the water. The listening devices in common use were the "S. C." tube, the "M. B." tube, and the "K." hydrophone, of which the two former were used principally in the daytime, because of the ease with which they could be lowered and raised again. At night when hove to or when lying idly on station in the daytime, the "K." in

addition to the other tubes was used. But before describing these tubes in detail let us look at the problem in general.

Sound travels better through the water than through the air, at least in water up to a certain depth. In the early part of the war it was supposed that the deeper the water the more accurately it would be possible to determine the bearing or direction from which the sound came. But it was found later on by Professor Mason and those engaged in experimental work on listening devices, that in water deeper than 600 fathoms a vessel had to be fairly close, say less than a mile distant, before she could be heard at all, which seems to prove that the sound waves are reflected off the bottom.

The principle of all listening devices is based on the fact that to hear a sound most distinctly it is necessary to turn the head so that it faces the direction from which the sound comes, in other words, so that the ears are equi-distant from the source of sound. Both the "S. C." and the "M. B." tubes were built in the form of an inverted T, one L of which was connected to the listener's right ear and the other to his left ear. When the ship was stopped and the tubes lowered they were revolved with the same effect as though the listener were turning his head beneath the water. When a sound was heard it was "centered" by turning the tube until it came to the listener's ear with equal intensity. Its bearing relative to the ship's head was then read from a collar at the top of the tube marked in degrees. For example, if the sound came from the starboard side directly abeam, its bearing was 90 degrees. Knowing the ship's course, it was then a simple matter to convert this bearing into a magnetic compass bearing, to be transferred to the guide ship by telephone.

It is remarkable how expert the listeners became not only in picking up noises, but actually in determining the type of vessel from which they came. Liners, battleships, destroyers, submarines on the surface and submerged, all had their own characteristic sounds, and a listener who could not distinguish them had no place on a Chaser. There is one case on record where a listener reported a submarine traveling submerged and ventured the opinion that it was an American vessel and further that it belonged to the "K." class, which, much to the surprise of his commanding officer, proved to be the case. So accurate

was the fix that a little later, when the sub came to the surface to give the laugh to the Chaser, she was actually rammed by her pursuer.

THE "S. C." TUBE

The "S. C." tube was installed on the port side of the keel well forward and when not in use was hauled up into a protective housing built along the garboardstrake. When lowered it projected about 3 feet below the keel. As shown in the sketch, the arms of this tube were fitted with hollow rubber ears connected by tubes of absolutely equal length to the stethoscopes. The sound coming through the water struck the outside of these sensitive rubber bulbs setting up a vibration of the air inside which traveled up the tubes to the ears of the listener.

There were several objections to this type of tube. For example, when the chaser was rolling more than 20 degrees, and she usually was, the water washing against the ears made it difficult to get a good center. But a greater difficulty was that because of its construction all the sounds in the neighborhood were heard at once, producing a confusion which made it difficult to isolate any particular one.

THE "M. B." TUBE

The "M. B." tube was designed to overcome these difficulties. It was installed on the starboard side directly opposite the "S. C." and, while more accurate, was heavier and much more elaborate. It was constructed with 16 ears, eight on the right side and eight on the left, all on the bottom of the tube and all connected by passage of equal length to the stethoscopes.

The principle of the ears equi-distant from the listener's ears was the same as in the "S. C." tube. The advantages of the "M. B." were that water noises had much less effect on it and that if there were more than one sound, all but one could be cut out provided they were more than 30 degrees apart.

With the "S. C." any sound in the circle of the horizon could be heard while the "M. B." worked more as a telescope to concentrate on one spot. Both of these principles, by the way, were employed in the later German periscopes which were so constructed that the same in-

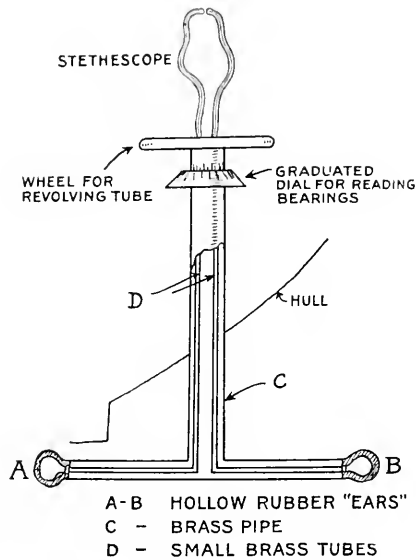

Diagram of the "S. C." Tube.

strument gave a complete view of the horizon and an enlarged section of any portion of it at the same time.

The ability of the "M. B." to eliminate undesirable noises is explained by the fact that a sound coming from the sides would strike the nearest ear first, then the next, and the next, and so on, and by the time it got to the main channel of the instrument would be confused and blanketed by itself. Supposing the instrument were set at zero, only sounds coming from the sector between 345 degrees and 15 degrees and those from the opposite sector between 165 degrees and 195 degrees would be heard at all. It took somewhat longer to search the complete circle with the "M. B." tube but its possibility for accuracy was much greater although I believe on some boats it was seldom used because of its complicated construction and susceptibility to leaks.

THE "K" HYDROPHONE

Submarines took advantage of the darkness to come to the surface to charge their storage batteries. A submarine is itself a pretty good listening device even without any special listening apparatus, and when

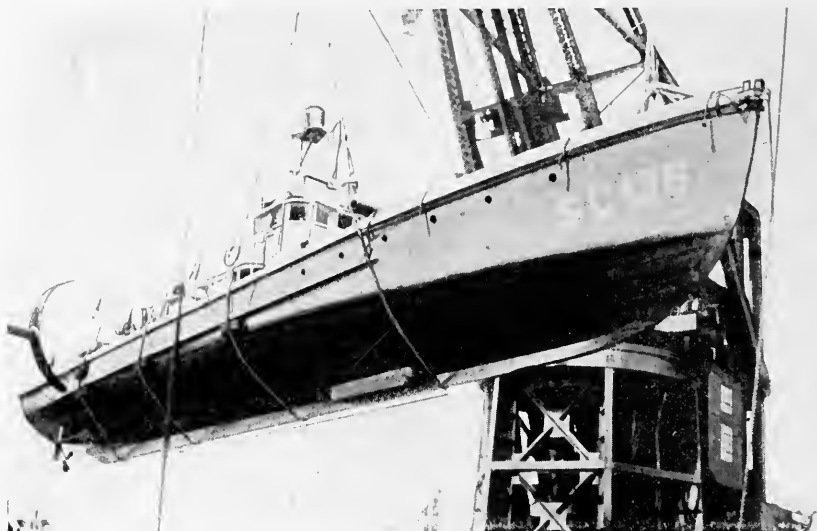

Photograph by courtesy of Ensign George Wallace, U.S.N.R.F.

The "136" lifted out bodily for over-night repairs at Norfolk, showing the housing of her hydrophone alongside the keel.

it heard anything in the vicinity it stayed below. For this reason it was customary for the Chasers to lie to and drift all night in order to listen and avoid being heard. At such times or when on station in the daytime a much more elaborate electrical listening device was used known as the "K. tube." The "S. C." and the "M. B." tubes had a radius of only about four or five miles but with the "K." working under good conditions, vessels could be heard up to 30 miles or more. The "K." tube, which was really not a tube at all, was designed to eliminate local water noises and was constructed in the following manner. A triangular shaped brass pipe with rubber ears at the corners was suspended by an electric cable at a depth of about 40 feet. This device was supported for the most part by a hollow metal float, the buoyancy of which was just a little less than that necessary to support the triangle. The remaining buoyancy was furnished by twelve small floats known as the "twelve apostles" through which a cable ran to the boat, and it was found that this arrangement effectually eliminated all local water noises. The ears were filled with little carbon granules

and a sound coming in vibrated these and was sent up the electrically charged cable to the "compensator" and thence to the stethoscopes in much the same way that a telephone operates.

When the engines were shut down the Chaser lay beam to the wind and drifted slowly to leeward. The device was put over the weather side and assumed a position out to windward. The little buoys were treated with phosphorescent paint so that their bearing from the boat was easily determined, and when the sound-bearing was read from the scale on the compensator it was a simple matter to convert it first to the bearing relative to the ship's head and then to the true magnetic.

Without attempting to explain the rather elaborate principle on which this device operated, it may be said that there were three scales on the compensator for reading the bearing of the sound, viz., "AB," "BC," and "CD," corresponding to the sides of the triangle. By revolving the wheel on the compensator box until the sound was of equal intensity in both ears, whatever the bearing of the sound, it would appear on two of the scales. This eliminated the so-called 180 degree error, or in other words, made it possible to determine which of the two diametrically opposite bearings was the correct one.

THE LATEST DEVELOPMENT

The results obtained with the hydrophones described above were uncanny in their accuracy, but inventive activity stimulated by the war never was content to let well enough alone. During the last few months of hostilities a new tube was developed which eliminated the faults of the others. Time lost by having to stop to listen, the water noises of the "M. B." and "S. C." tubes, the 180 degree error, and the necessity of having two men below in the magazine to raise and lower the tubes, all were washed out by the new device. The greatest advantage of the new "M. V. tube" as it was called, was that it could be used while under way. It was a much more cumbersome device than any of its predecessors weighing, complete, in the neighborhood of two tons and consisting of two parts lying along either side of the forward part of the keel for a distance of $38\frac{1}{2}$ feet. The device was $23\frac{1}{2}$ inches wide and projected $15\frac{1}{2}$ inches below the keel, but by enclosing the tubes in a streamline shell very little resistance was caused by its presence on the bottom of the boat.

The new tube had 348 ears and was so arranged as to cut out the sound of the ship's own propellers. Noises caused by slapping water were done away with by encasing the device in a non-watertight shell so that it was always surrounded by dead water. While not actually used against enemy submarines I know of one case where accurate bearings were obtained of a sub traveling submerged at three knots from a Chaser traveling at ten knots at a distance of eight hundred yards. Never before had it been possible to hear a submarine running at such low speed or to get an accurate bearing from a vessel in motion.

An interesting thing developed during the tests of the new hydrophone on Submarine Chaser 252. Henry P. Bonnell, her commanding officer, says that in spite of the two tons which meant an additional weight of nearly three per cent of the total displacement of the boat, and the added resistance of the bulb on the bottom, his vessel made better speed after it was installed than she had before. This, of course, was due to the fact that the Chasers were so heavily loaded aft that they were about 18 inches down by the stern and this weight forward caused the boat in question to assume a more normal running trim.

Still another detection device with which the S. C.'s were equipped was called the "Trailer," the purpose of which was to detect the presence of a submerged submarine when lying idly on the bottom as was frequently their custom. No type of listening device would help in such a case and so the trailer was designed to establish an electrolytic action and ring a buzzer in the pilot house when contact was made with the steel hull of the submarine. The device consisted of two parts, one a bronze plate hung over the stern and the other a length of heavy chain on the end of a phosphor bronze wire. The latter was trailed astern, the weight of the chain keeping it on the bottom, and when contact was made with the hull of the sub an electrolytic action was set up between this and the bronze plate. It was found later that by attaching one wire to the quadrant the bronze rudder served as an electrode as well as the plate, simplifying the device.

The Trailer was not used to any great extent but actually proved of value on several occasions in determining the position of a submarine that had been bombed, thereby establishing the kill.

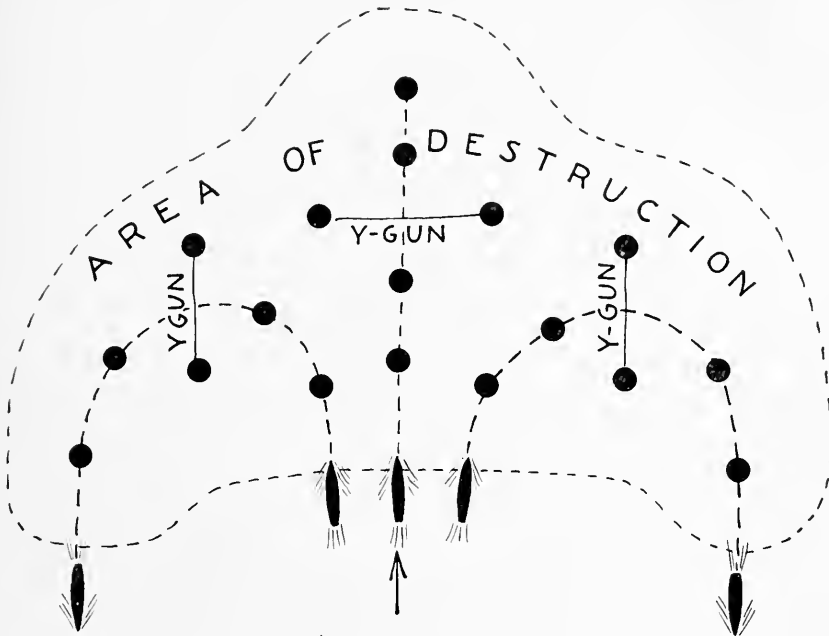

FORMATION FOR THE ATTACK

When out after submarines the Chasers worked in units of three which was the least number that could obtain an accurate fix from sound bearings obtained through the hydrophones. Two vessels, working under ideal conditions, might obtain a fairly accurate fix from cross bearings but with a third a check was obtained on the other two. If either of the wing boats was not in contact with the sub, the third vessel supplied the necessary second bearing. Three vessels were fully as mobile as two and with one acting as guide, it was simple for the others to maintain their positions.

The original formation was a triangle, vessels two and three maintaining positions off the quarters of the first vessel on a bearing of exactly 45 degrees, no matter what the course of the leader. But this formation proved slow and unwieldy because of the fact that Nos. 2 and 3 besides checking up constantly on the other positions had the job of remembering and holding to their courses. The final plan, therefore, was a line-abreast formation at right angles to the line of

bearing on the submarine. It was the job of the guide ship to keep headed for the submarine, and it was a simple matter for the wing ships to maintain their positions on the guide ship's beam.

Naturally, courses changed frequently during a hunt calling for a great amount of pivoting, and there was also the frequent necessity of stopping to listen in, but due to the wireless telephones with which all Chasers were equipped, such maneuvers were executed with lightning rapidity.

When all three boats had drawn within a few hundred yards of a sub and were in a position to attack, the wing ships would close in to within 100 yards of the guide and the plan of dropping depth bombs shown in the sketch was carried out.

Probably the greatest advantage of the Chaser over the destroyer and other larger vessels in anti-submarine work was the ability to stop all machinery instantly, in order to listen with the hydrophones which was necessary at intervals of about ten minutes whenever in motion, whether actually on the trail of a sub or not; a thing obviously impossible on a destroyer with her elaborate auxiliary pumping machinery. By means of the air starting and reversing feature of the Standard engine, starting, stopping and maneuvering could be carried on *ad infinitum*.

The phenomenal speed obtained by the Chasers in maneuvering was made possible as we said before, by the wireless telephone which made other similar methods of intercommunication obsolete. Flags and shapes to transmit courses and bearings and the Morse code and the semaphore were alike unnecessary to the Chasers whose work was done with the precision of clockwork and the speed of greased lightning. In fact, the intercommunication between the members of the "S. C." fleet was so perfect on the Otranto "barrage" across the mouth of the Adriatic, that an order was issued to the commanding officers of all German and Austrian submarines operating in the vicinity not to fire on a Chaser because of the fact that it would mean almost sure destruction for the sub at the hands of the other boats in the neighborhood. This order was intercepted by wireless and was a pretty compliment to the efficiency of the barrage.

The Chasers being comparatively slow boats, very little faster than a submarine, in fact, had to work with the utmost speed when stop-

ping to get bearings. That they did so is shown by the fact that it was not unusual for three Chasers to stop, lower their listening devices, obtain a bearing on a submerged sub, transmit it on the phone to the center or guide ship where it was plotted, obtain the new course and distance, and be under way in less than a minute. No wonder that these energetic youngsters who cared not a tinker's damn for regulations, which it was impossible to observe on tiny ships that were never on an even keel, have been called the best disciplined crowd in the Navy. They did their work *sans* rest, *sans* food, *sans* praise. They did it largely in their own way but they did it well.

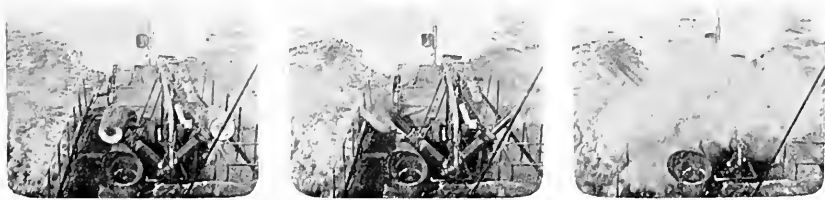

Section of a motion picture film, showing the Y-Gun and depth bombs at the instant of discharge. The plungers on which the "ash cans" are carried may be seen distinctly.



Photograph by courtesy of Lieut. Edmund Frederick, U.S.N.R.F.

Fresh bread from the mother ship on the way over. A venturesome gob takes advantage of the opportunity to visit his friends.

CHAPTER VI

THOSE WHO WENT ACROSS

EXCEPT for the hundred turned over to the French Government, some of which were towed over, most of the 235 Chasers that crossed the Atlantic did so under their own power. When the war cracked there were 135 in European waters, manned and under the command of young American reservists, and their field of operations extended from the Adriatic to the Arctic Ocean.

It would have been hard to believe, a couple of years ago, that a bunch of youngsters from every sort of occupation and with only a few months' training would be taking "those damned S. C.'s" across the Atlantic. It's no mean trick to navigate a ship, but did you ever try to shoot the sun from a small boat in a seaway? And did you ever try to prepare hot food in such a boat at sea? Or stand a watch in an engine room when the weather was so rough that every opening had to be battened down to keep the water out and the atmosphere was like a German gas attack? If you have you will appreciate the magnificence of the feat.

Of course, the boats were seaworthy. We knew they would be that in spite of their numerous critics. Most people, with the possible exception of the big-ship crowd, are coming to realize that actual seaworthiness is not a matter of size. But living on the boats frequently battened down for days on end is another matter. Talk about the destroyers! If you want a real sensation, go to sea in a Submarine Chaser.

The American Chasers operating in foreign waters were sent to points where most needed. In the neighborhood of fifty were stationed at Plymouth, England; thirty at Corfu, Greece, which is near the mouth of the Adriatic; eighteen at Gibraltar; twelve at Brest, and fourteen in the Azores. Each boat carries two officers and a crew of twenty-four men, and it is estimated that the average distance covered on patrol was over a thousand sea miles a month. Commander Joseph C. Fisher, who has had a lot to do with the Chasers, said to the writer recently, "They were the most efficient vessels in locating



Photograph by courtesy of Lieut. Edmund Frederick, U.S.N.R.F.

Fueling on the way across the Atlantic by means of bases from the mother ship. The Chestnut Hill afterward accommodated seven Chasers at a time—three astern and two at either side.

submarines submerged that were employed in anti-submarine warfare, the reason being that it was possible to stop all their machinery while using the detection apparatus.”

“The fitting out of the 110-foot Submarine Chasers,” said Secretary Daniels in his annual report for 1918, “has had a marked effect upon the submarine campaign both here and abroad. At the beginning of the year there were thirty-eight of these Chasers in commission. There are now 406 Submarine Chasers in commission, of which 235 (100 French and 135 American) have been despatched abroad and the remainder assigned to duty in home waters.

“The problem of sending such a large number of these small vessels, with a limited cruising radius, across the Atlantic, was one that required careful thought. A plan of sending these Chasers in groups, convoyed by a fuel ship and fueling at sea, was finally adopted and was most successful.

“In connection with the operation of a group of these Chasers in the Adriatic, the following cable has been received:

"Italian Naval General Staff expresses highest appreciation of useful and efficient work performed by United States Chasers in protecting major vessels during action against Durazzo; also vivid admiration of their brilliant and clever operation which resulted in sinking two enemy submarines."

LIFE ON A CHASER

Now that we have some idea of the boats themselves and how they came to be designed, let's sign on for a cruise across the Atlantic and learn something of the intimate life aboard—"how twenty-four men and two officers nicely sardined aboard a packet originally designed for only eighteen, spent their time at sea and their money in port."

George Wallace, erstwhile Ensign, U. S. N. R. F., skipper of the "253" and commander of "L" Division of six boats, has had an unusually broad experience in all phases of Chaser work, and we can do no better than to take his story as he told it to the writer recently and as he wrote it subsequently for *Motor Boat*. I quote:

In order that no one may get a wrong impression and accuse me of flippancy or a grudge against the Navy, or a grouch, I want to state here and now that I would not have preferred any other branch of the service to the one I was in, nor would the majority of officers and men aboard those chasers that went to sea, and by going to sea I mean clipping off anywhere from fifteen to fifty thousand miles in big water.

We had many discomforts, but by the same token, an awful lot of fun. The latter, of course, was contingent on the first, for after a man had neither washed nor shaved for two weeks and had subsisted out of a tin can for the same period he was likely to take his fun in large doses—regardless of expense or the innocent bystanders. For that reason, as well as our youth, I have always had a sneaking suspicion that some men—long in battlewagon service—wondered how such an undisciplined mob as hit the beach on liberation from the chasers ever got away with what they did, either in running and navigating a chaser, or in pursuing the elusive submarine. I would have wondered myself if I had never been on one. As a matter of fact, in their own way, submarine chaser men were the best disciplined in the whole navy. They and the destroyers had the toughest assignment of the naval war.

They carried out their assignment efficiently. They accomplished what they were put aboard to do—defeat the submarine—and they did this not aboard a 25,000-ton, steam-heated and steam-driven, six-decked, pianola-equipped battleship, but in a little sweat-box or ice-box (according to the weather), of a wooden ship which rolled 140 degrees in seven seconds (70 degrees each way), whose decks leaked so that everyone's clothes were soaking wet, and so small and so overloaded with engines and anti-submarine gear of all kinds that there were not enough bunks to go around. You drank your coffee standing, when there was coffee, and you never had a laundry bill. When a chaser did put into port, is it any wonder that all hands wanted exercise—to say the least.

Maybe I am the biased one—but as I had been to sea once or twice before I saw the Navy, perhaps I'll be pardoned for saying that the deck force of the average chaser could not have consisted of better men. They started as green as grass, learned their job quickly, did it well, and were game—even at the end of six months of four hours on and four off, day in and day out. As for the black gang—God bless 'em. Running at night—darkened ship—with every port closed—practically no ventilation—stinking fumes thick as pea soup—repairs to be made whether smooth or rough—those boys did their bit. My one suggestion is: if you ever want a good gas engine man—and there are not very many really good ones—employ one who has stood a regular watch on a chaser.

But I must get on with my story. It was my good fortune to be assigned to sub-chaser experimental work before many had been launched. There was a fleet of twelve of us at New London, Conn., whose job it was to test out all listening apparatus and to make practical use if possible of those inventions which were laboratory successes but had not as yet bridged the gap between that and the gruelling work of the open sea. After finding what was best we then had to evolve chaser tactics, which included maneuvers, special signals, hunting, patrol and attack formations, and at the same time take men who had never been to sea before, and not only cram practical seamanship into their heads and bodies, but the specialized knowledge so necessary to efficient, lightning-fast sub-chaser operation, and all this in the short space of three or four months. Consequently we were going morning.

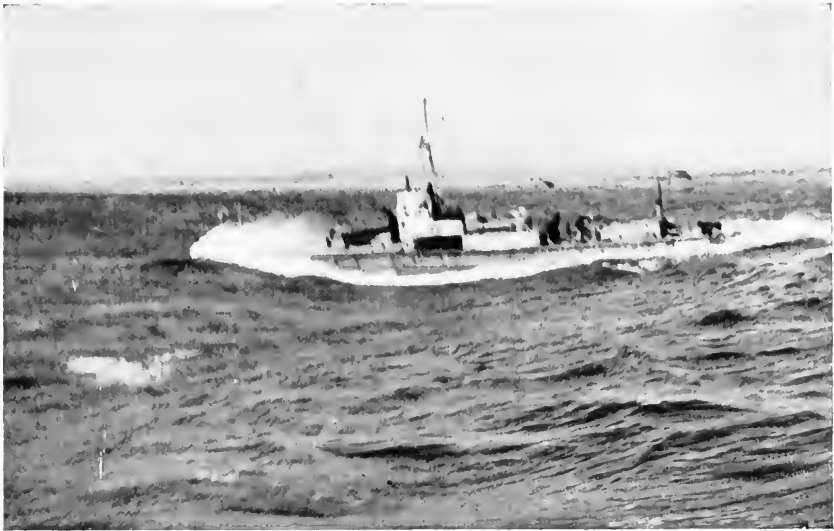

*Photograph by courtesy of W. C. Van Natta, C.M.M., U.S.N.R.F.
Taking it over the fo'c's'le head.*

noon and three to four nights a week, and if you will but recall the winter of 1917-18, this meant operating in ice anywhere from six to twelve inches thick.

We had no heating systems, but we lived aboard just the same, and many a morning, with the thermometer hovering around and often under zero, engines were started only after a thorough application of a blow torch on frozen cylinders.

When March came blustering along, we hunted subs—American ones to be sure, but we had all the local color of the English Channel, produced by the fog and winds of Block Island and old Montauk.

In those days, alas, few of us had our sea stomachs, and many a seaman locked arms with a civilian inventor or two over the rail. Speaking of inventors, there was one little Southerner in command of a chaser whose luck had run to inventors for several weeks, and on all his trips he had to feed them one or two meals daily. He was decidedly out of pocket and his mess accounts groaned under the added burden. And then one day he smiled. It was noticed that the "long hairs," as they were known, avoided his chaser. When asked

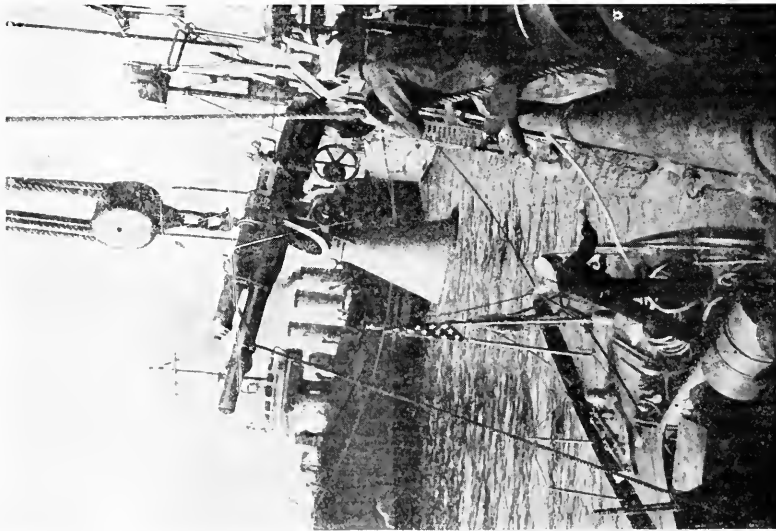
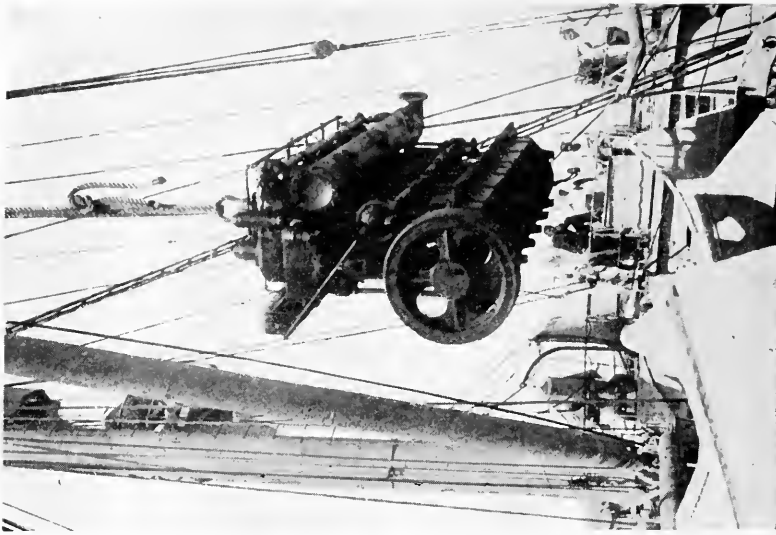

The mother ship acted as a base for the Chaser and carried everything likely to be needed, from a deck gun to a Standard motor.

how he did it, he replied, "Well, I got blamed tired of their big appetites, and the way they guzzled hot coffee was a caution, so I just bought me a pound of chicory to mix with a few beans of Java, and when they hit the Race with that in their stomachs they just naturally passed out."

As March merged into April, chasers arrived in increasing numbers to be equipped with all the gadgets, spend a few weeks under instruction, and then slip quietly out for foreign waters. This outfitting was done at the Marine Iron Works, and it was there one day that all of us first got into action. The affair was informally known as the "Battle of the Marine Iron Works." It seemed that one chaser out of the twenty or thirty at the dock had just mounted her Y-gun as well as the two 400-lb. depth charges, which the gun was used to hurl clear of the ship—3-in. blank charges being used for this purpose. The gunner's mate of this particular chaser was testing out his ammunition and had neglected to go through the formality of removing the firing pin. The inevitable happened. There was a loud report and two ash cans loaded with T.N.T. went sailing majestically through the air. Simultaneously about 500 men marathoned up the dock, regardless of rank, rate or precedent, expecting every second to be lifted into the air and with visions of "full military honors." Fortunately the charges were on safety, and when they splashed in shoal water, they failed to explode.

You can imagine our feelings—seeing the other chasers start across, leaving us to gadjeter around New London—and then on the first of June the war started on our own coast. Now I don't believe any of us wished our poor, harassed merchantmen any hard luck, but all of us blessed the first U-boat sinking over here, because it meant action. We got it—and at once. Three of us Tactical boats—the "6," the "214" and the "253"—the night of June 3 received orders to be ready for sea at midnight, and, we, only station ships with no grub, no ammunition, reduced crews! How we did it no one knows, but when we left at daylight next morning we had aboard strange faces and strange engine parts, and other vessels' food. We left behind many enemies and much cursing, but we were ready.

Then began three months of the hardest grind any of us ever went through. Hardly ever in port, without a base, with the whole

Atlantic Coast to cover, never a day for repairs, it was a case of keeping at sea until fuel was exhausted—a dash to port to fill up—then out again. At night a light showing, even the glimmer of a match, was a disgrace, and if you lost the main body in a fog or rain you kept quiet and found your position if you could or carried out orders alone.

We three boats joined fifteen others, which, with the destroyer *Jouett*, made up the Special Anti-Submarine Force. During June we operated from Norfolk and had the honor of convoying over 400,000 troops on four separate convoys two-thirds of the way to Bermuda—and not without a brush with a submarine. It was lively work for a few moments, with the transports blazing away with their sixes and eights and all the glorious upheaval of the depth bombs. After leaving the troopships we would scout back to port. Many were the lifeboats and the wrecks we sighted, and one night for six and a half hours the “Holy Trinity” (6—214—253) chased a Hun. Of course we could not see him, but we heard him, and if we had not run out of gas I think we would have got him. Such is the irony of fate.

An unusual thing happened on one of these trips. Another group of three chasers had contact with a sub a few miles off the Delaware capes. They dropped bombs, one of which failed to explode. Some hours later an American sub came to the surface of the breakwater to find a depth bomb lying on her fo’castle deck.

The latter part of July we were rushed up to Cape Cod to patrol from Nantucket to Halifax—just in time for those pea-soup August fogs and mean southeasters. During August, by the way, we had just nine clear days, and we spent a total of 92 hours in port. It cost each of us about 20 lb., but we accomplished our purpose.

Many and varied were our experiences, and perhaps the weirdest was one run the Holy Trinity made from Provincetown to Nantucket Lightship and return in one of those smoking-brown blanket fogs that was as heavy as rain and so thick that a lookout was a joke and a searchlight undiscernible at 80 yards. The weirdest thing of all was that we did pick up the lightship and right where she ought to be. We did not see any subs, but brought back a few starving fishermen left by our courageous enemy to drift around in dories 100 miles from port.

Of course, I cannot tell how a certain group of chasers tied up alongside of each other in the thick of that fog and had a progressive

luncheon, or how "Tal" tried to shoot "Warry" with a Very signal pistol for kidding and cursing him, causing me heart-failure because I thought some one had been sunk, nor how all hands went fishing off Chatham before we were ordered to patrol Massachusetts Bay while President Wilson was at Manchester. Nor dare I mention how one chaser was fooled into thinking a sub fired at her with pistols—shortly followed by a torpedo. Nor would it be diplomatic to mention the name of a certain cruiser which mistook us for subs and blazed away six times at us with her 8-in. guns before clapping on 25 knots and disappearing over the horizon; nor of the wild tales of the sea the Gobs told the natives of Halifax, and wilder ones about the subs we had sunk. But I *can* tell of the wonderful spirit that pervaded that little fleet, in spite of the wringing wet, drudgery of protecting the coastal traffic, the cheerfulness of men and officers, worn out, digestions ruined, sick of climbing up endless hills and counting countless hollows. And I can tell of the respect—yes, the adoration—we had for our force commander, Captain W. P. Cronan—a born leader who knew when men were doing their best and, more by his attitude than his words, expressed his satisfaction.

And so it was with real regret, although with a great joy too, that the fleet was broken up and twelve chasers were ordered to New London for ten days' overhaul, and then—foreign service! We said goodbye to our friends and two days later were in the throes of an overhauling in the midst of a real, real town where there were trains and movies, broiled steaks, real hotel beds, bell boys. Our appearance promptly earned us the title of "The Dirty Dozen." We deserved it, for twelve more ragged ships have never been seen. 13,500 miles without paint or repairs had done their work.

Two weeks later, with the force augmented by eighteen other chasers, six of them French, three big brutes of tugs, and mothered by our old friend the "Prairie," and the wallowing "Hippo" as fuel ship, we set sail for Bermuda.

To us that trip was a restful vacation. True, the chow came out of the same old can, and the water was just as big, but this time we had a light to follow—a wee, dim, blue thing—but a light. What a blessing it was to come on watch at 2 A. M. and see that tiny flame dead ahead, after months of red-eyed straining blackness.

That first leg was made without incident. We fooled the tugs, for no one broke down, and our stay in Bermuda was very brief. The Flu had us all quarantined aboard, so there was nothing to do but rush our few repairs and set out for the Azores.

We were twelve days making those 2,000 miles. Our speed was $8\frac{1}{2}$ knots, and every third day we slowed down to fuel, which we accomplished alongside or astern of the "Hippo." We would catch a heaving line and haul in a 6-in. sea painter and make fast, then the gasoline hose next, and in 40 minutes our tanks would be full. Two boats fuelled astern as well, and I have seen six chasers at a time performing the operation. It sounds simple, but in a chop or heavy ground swell it took all the niceties of judgment and seamanship to get close enough to make fast and yet keep clear and escape being cracked like an egg against the steel sides of the rolling tanker.

But the longest trip must terminate, and one morning we sighted the Island of San Miguel, Azores, and finally crept behind the seawall of old-world Ponta Delgada, and feasted on fresh picked luscious pineapples, we were quite willing to forget the past two weeks and continue the war. That night, the greasy, dirty American Pension rivalled Rector's in our eyes, and the Michelenses Club appeared as festive as any cabaret. We spent twelve days there, expediting repairs quite as usual, prowling around through the stinks of the town, seeking souvenirs, or roaming the walled-in fields that rose to the splendid rolling heights. Evenings found us at the club for cards and roulette, and always Anton, his sandwiches and his many merry bottles.

And then the Flu descended to ravage poor bewildered Ponta Delgada. Thousands on the Island died, for among those ignorant islanders there were few who knew of sanitation and none had medicines. In a few days we found water scarce and fresh provisions impossible to obtain. So to sea we went, this time without our fuel and mother ships, accompanied only by one destroyer. We left in the midst of a howling northwester which grew worse within 24 hours. If the wind had not been astern our scanty fuel supply would never have lasted to Portugal. We battled for $4\frac{1}{2}$ days—scattered apart into detachments of twos and threes, but we all made Lexioes, the sea outlet to Oporto, and few there were who had an hour's supply of gas left or less than 3 ft. of water in their after compartment.

Here let me chronicle one of the bravest individual feats I have yet to hear of. At 1 A. M. on a particularly bad night with seas practically submerging us, one nasty one swept away the rail of the "355." The chief quartermaster went with the rail and in the wink of an eyelash was 100 yards astern. Ensign Peterson, the captain, got his engines backing, his searchlight working and then went over the side after his chief. He got him, too—unconscious and nearly gone—and he brought that dead weight to the ship in the face of those breaking crests. It was only pure courage that could have done it—the 1 A. M. kind where there was no gallery to applaud and give encouragement.

We thought we had a week at Lexioes for repairs and to wait for gasoline. We thought, too, that we were going to Brest, but the next day the destroyer *Parker* sneaked into the harbor and then a tug loaded with gasoline drums. We were ordered to Gibraltar—rush. You see, Austria having just made peace meant that German subs had no base nearer than Germany, and every one in the Mediterranean had to pass through the Straits to get home. It was our big opportunity—probably the last one we would have—but there was only enough gasoline for half a dozen even after we had worked all night draining each other's tanks for the last remaining drop.

Next morning nine left—four in tow of the destroyer and tug. We others had to get gas by hook or crook from Oporto. Enough was obtained for three of us to pull out the next morning at 2 A. M. One broke down and went aground at the mouth of the harbor, leaving the "214" and "253" to make the run down the Coast alone. After two days' good weather, the wind howled around to the northwest again, and that eighteen-hour run was the worst I've ever had in a chaser. The seas were tremendous, and time and again the truck light of the "214," 40 feet above water, would disappear from my view—and yet she was a scant 200 yards astern. We made Lisbon next night and dropped anchor in the roads. Perhaps I can best describe the force of the wind by saying that I was swinging to 65 fathom of chain in 9 fathom of water—yet when I raised the anchor next morning the shank was bent at right angles.

We had little time to enjoy beautiful Lisbon, for it was a case of taking all day to cut the international red tape to obtain fuel. We

gassed all night and pulled out early next morning. We were lucky to get out at all, as some of the men from my ship had gone ashore the night before as broke as sailors could be who had not been paid for a month. They ran up quite a bill at a cafe and then took French leave. Next morning the proprietor and the police were on the dock and I had to haul out in the stream P.D.Q. to avoid international complication.

We made Gibraltar Straits next morning just in time to see the last of the torpedoed British battleship "Brittania"—to see the destroyer "Parker" miss destruction by about 6 ft. and take up the hunt ourselves immediately. I certainly admire that Hun's nerve. After stealing through the Straits he hung around awhile and got a battleship.

That night we ran into port, fuelled, and formed our force on barrage the next day.

The weather was still against us, as a No. 6 wind from the east had raised a nasty chop against the westerly set of the current, but the five days the chasers were on barrage were sufficient to obtain credit for three sinkings divided among the eleven of us. It was exciting, soul-satisfying work, none the less interesting, because a British destroyer mistook the "214" and "253" for subs and promptly opened fire, or because a newly arrived Brazilian cruiser thought sure the "190" was a Hun and fired twelve rounds from her bow guns before recognizing the flag—and this at 11 A. M.

And then the armistice—a stirring race to port, a shift to shore clothes and a shave, and the finest, craziest time of the whole war.

We lay in Gibraltar for a month and a half—every one bent on doing the same things—as little work as possible and having all the fun there was. There were trips to Africa and others to Spain—to Algieras, where there is the daintiest hotel in all Europe—afternoon tea with the "Limies," at the Grand or Cecil, and many evenings of related experiences.

We left on December 23 for the Azores, and spent Christmas at sea. It was hardly a jovial day, and a "Merry Christmas" frequently called forth considerable cursing, but there was real thanksgiving, too, for we were homeward bound. This time our stop at Ponta Delgada was but a hurried one and the day after New Year's found us headed for the Virgin Islands in the West Indies.

That was a sixteen-day run—a repetition of the other long one—weather ideal, with frequent mid-ocean swims when we stopped to fuel.

Bad news awaited us at Charlotte Amalie, for visions of seeing the dear old *Estats Unis* were rudely dissipated. Instead of proceeding to Charleston, the entire fleet was disbanded and distributed throughout the West Indies. Six of us went to Haiti—those two old cronies the “214” and “253” still sticking together. Our experience in the negro republic was probably the most interesting of all. Our marines had made many improvements in the few years of their stay. Port au Prince, the capital, had been cleaned up, roads built, police forces established, but the bulk of the population, particularly outside of the city, lived as their ancestors had lived in Africa. To the blasé tourist I recommend Haiti, for there can he find the typical palm-bordered shore of the tropics, the heat-ridden plains of India, and the mountainous beauties of our own country. Adventure awaits him as well, for few white men have been able to explore the interior alone.

In Haiti our wanderings ceased, for after six weeks' stay there three of us proceeded to New Orleans for repairs, arriving on April 2. And it was there, in a home port, I left the “253.” I took her over and I had the satisfaction of bringing her back. Perhaps her journeys are not ended, but at least her war-time chapter has been written to completion.”



A limney officer's conception of one of our Chasers.

Drawn by J. C. Forwell.

CHAPTER VII

THE OTRANTO BARRAGE

IT was in order to bottle up the submarine bases of the Austrian Coast that a cordon of vessels was thrown across the neck of the Adriatic from the heel of Italy to the Island of Corfu. This section, patrolled as it was continuously by several lines of vessels, was known as the Otranto Barrage, and I think the American Submarine Chasers deserve most of the credit for making it so efficient that submarine troubles in the Mediterranean were practically eliminated. The work of the Chasers on the Otranto Barrage is characteristic of that done by our little vessels abroad. The duties were much like those of the S. C.'s working out of Plymouth, England, and the French ports and the story which follows gives a graphic account of this particular phase of our activities. Lieut. Walter P. Groszman, U. S. N. R. F., told me the story, and here it is as it was written by him for *Motor Boat*:

It was at Ponta Delgada, on Sunday, May 5, 1918, that our bluff skipper, Capt. Chas. P. Nelson, U. S. N., commanding U. S. S. "Leonidas," our Mother Ship, called a meeting of all of us commanding officers to impart some important information. Until then none of us knew what our ultimate destination was to be, and curiosity, of course, ran high.

In his usual straight from the shoulder, enthusiastic way he opened up with, "Well, boys, I wouldn't swap my job with anybody, either in heaven or on earth, for we have the greatest little assignment for hunting Huns that one could wish for." From that day on we were his "gang of Hun hunters."

He then proceeded to tell us of the frightfully successful submarine activities in the Mediterranean, where a higher percentage of tonnage was being destroyed than in any other like area of sea, and that it was our job to stop it.

Corfu, Greece, was to be our base, so about 2,800 miles of travel still lay before us.

Gibraltar was, of course, our next stop, and it was there that we

got our first taste of "Hun hunting." Necessary minor repairs were being made by all of us preparatory for our next run to Malta, when a hurry call came from the Mother Ship, which summoned all commanding officers aboard. Two submarines had been reported out in the Straits, and the British admiral had asked if we were ready and willing to assist in destroying them. If you knew our "big skipper" you might be able to imagine how that politely put inquiry must have affected him. Just what words he used in his answer I don't know, but probably it was a very explosive "Of course we are ready, sir!"

We got hurried instructions, and as soon as we could get back to our ships the whole fleet of 30 chasers, lame ducks and all, shoved off and, under the leadership of Captain Nelson, stood out into the Straits.

There had been little time for planning the hunt, except in a general way, and the units, consisting of three chasers each, were left pretty much to their own resources. It was the first time that our listeners had heard an enemy sub, but, after hunting all afternoon and night, our efforts were brought to a successful close, one submarine being sunk by depth charges and the other driven ashore, disabled, on Spanish territory, where it was forced to intern. We all felt pretty cocky over our party, and Captain Nelson gave out grunt after grunt of satisfaction.

Next to the feeling of satisfaction over getting the subs was the realization of the prestige which we gained with the English. Wherever we had come into contact with them before we had noticed a very decided attitude of tolerant indulgence, a sort of "You'll have to show us" spirit. When we made good on our first attempt it knocked that attitude clean out of them, never to return. On our run from Gibraltar to Malta the dastardly destructive work of the submarine was made only too clear to us. Every few miles we ran into clusters of wreckage, hatches, deck chests, all kinds of ships' gear that would float, besides bales and boxes of cargo. It made one heartsick to think of all this wanton destruction, and no doubt caused the resolve in the hearts of all of us to do our utmost to stop it and to punish those engaged in this nefarious work.

In Malta we stopped only long enough to be drydocked for a final cleaning and painting of the hull. On June 2 nine of us were sent on to our final port, Corfu, there to await the rest of the fleet.

Early in the morning of June 4 we arrived off the south entrance to Corfu Roads, the beautiful body of water separating the Island of Corfu from the mainland of Greece. We were met and challenged by a fussy little French torpedo-boat and then escorted through the elaborate mine fields and nets up to what was to be our own base. Our reception, as we slowly steamed into the harbor, was most impressive and stands out in my memory as one of the big moments to be remembered always.

Little is known by the general public of Corfu, but during the latter part of this war it was the most important center on the Mediterranean. France had assembled there a mighty fleet of her finest dreadnoughts to act as a buffer for any naval aspirations that Austria and Germany might have had from their big naval bases on the Adriatic. The English had a base there for drifters, trawlers, destroyers and cruisers, and there were also Italian war craft there most of the time. At this time also was Corfu the seat of the Serbian Government.

It was through this assembled mighty Allied fleet that our small American submarine chasers slowly steamed, and it was with fast beating hearts that we answered their salutes. All the big "battle wagons" had their rails and rigging manned, and the silent homage that these big fellows were paying to the good old U. S. A. as represented by our tiny craft surely went deep.

In what became known as American Bay we dropped our mud hooks and surveyed what we were informed was to be our base. It looked—well, peaceful. Simply an ancient olive grove. Visions of "working parties" loomed large in the minds of the crews. Visions sometimes come true, and this was one of the times.

A few days later the *Leonidas* arrived with the rest of the chaser fleet, and work began. Work on the base, however, was not allowed to interfere with what we came there to do, namely, hunt subs, so the following day, June 12, twelve of us went to sea for our first "barrage."

To get a good idea of the strategic value of our field of endeavor, a glance at a chart of the Adriatic Sea will show its importance. Practically all the submarines which operated in the Mediterranean had their bases on the Adriatic, at Durazzo, Cataro, Pola, etc., and, of course, in order to go out from and to return to these bases, had to



Racing back to Corfu after a run up the Adriatic. The buoys of the protecting net may be seen to the right

pass through the Straits of Otranto. Could, therefore, a barrage of properly equipped ships be kept across this comparatively narrow strip of water, about 52 miles, then the sub could be caught coming and going. For quite some time before our arrival such a barrage had been operated by the British, using for the purpose drifters, trawlers, motor launches (M. L.'s) and a few destroyers.

Their equipment, though rather inferior to ours, had yet enabled them to make their presence felt and establish the value of the scheme. So we were hurried to the spot with our admittedly superior devices.

What value was attached by the Germans to the barrage, was shown by the fact that only a few weeks before our arrival they had made a surface raid on the line and sunk every ship that was on patrol, fourteen in all.

The general scheme was that our twelve chasers formed a line across the straits from Cape de Leuca, the southernmost point on the heel of Italy, eastward to Fano Island. About ten miles to the north was a line of drifters and trawlers and closer inshore were M. L.'s. As a protecting screen to the north, a line of British destroyers patrolled. For support in case of a surface raid by destroyers and light cruisers, a flying squadron of light, fast vessels was held at Brindisi, Italy. This organization varied from time to time, so that the enemy could never be sure of just where he might encounter us.

Strange as it may seem, yet only one enemy sub was seen on the surface during all the months that this barrage was maintained. It made no difference to us whether he came through under or on the water, for with our listening gear we could hear him much farther than we could see him.

In the hunting three chasers worked together as a unit, the unit leader being the center vessel in a line abeam formation. A chaser hearing a suspicious sound would telephone the magnetic direction to his unit leader. The other wing vessel's sound angle would also be obtained. The bearings at which all three vessels are hearing are then plotted, and, naturally, the point at which all three lines intersect is the location of the source of sound. Knowing the distance between the chasers, it was then a simple matter of triangulation to determine the distance off.

After a number of these operations it was possible to obtain the

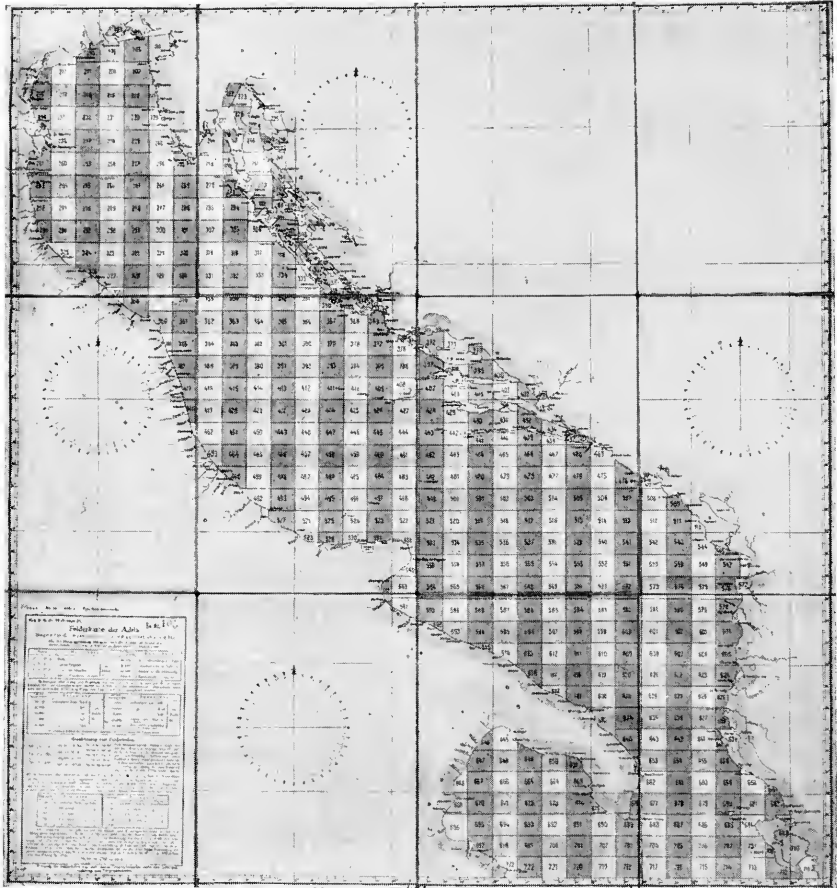

Reproduced by courtesy of Ensign Frank W. Nolan, U.S.N.R.F.

Reproduction of a chart of the Adriatic taken from a German submarine.

sub's course and speed and gradually work up into position for attack. When sure of his position a pattern of eighteen depth charges was laid which certainly caused a commotion that would strike terror into the stoutest heart.

The theory is very simple and was very successful, but yet there were many things that had to be overcome. The sub skipper always knew when he was being pursued, for a submarine is in itself a huge

listening device, and therefore used every means at his disposal to throw us off the scent. They would zig-zag, making it hard for us to get them fixed long enough for an attack, stop their engines when we stopped for listening. The latter availed them little, for we knew just how long a submarine could "balance," as it is known, and simply out-waited them. The work required much patience before the attack and mighty quick action when the right moment had arrived.

After an attack had been delivered it was necessary to continue listening for some time. They would simulate destruction by releasing oil from their tanks, also allow air to escape in the hope of making us think that our job was done and we then would move away satisfied. Those tactics availed them nothing, for we were good waiters and hung around until all doubts of destruction had been dispelled.

From the first day that our chasers assumed duty until the armistice a full strength barrage was maintained regardless of weather conditions, with the result that Submarine Chaser Detachment Two is officially credited with fourteen submarines.

The life was certainly not surrounded by any comforts, for our tour of duty was five days at sea and three in port, with sea watches of four hours on and four off. The climate in those latitudes is very fine, but if anybody can show me a meaner body of water than the Adriatic I should like to see it. The sudden gales that howl down from the Albanian mountains whip up the sea in a frightful manner. Many a day cooking was an impossibility and eating became a fine art, of the impressionistic school, to be sure, plastered all over one's person, as it were.

Fritz, too, seemed to take a delight in adding to our discomforts by choosing nights for his time for trying to sneak through. That usually meant an all-night hunt, with all hands at general quarters, tearing around in the darkness at full speed, hoping that a stray floating mine doesn't get you before you get him. Our luck held to the end, though. During daylight we found many mines that had been sown by Fritz to reap a harvest of chasers, but during our night running a protecting angel must have flown with us, for none of them ever found its mark.

At Otranto, Italy, an Allied airplane station was located which the enemy seemed to have a particular dislike for. They never seemed to



The crew of the "327" as the loved ones at home pictured them and as they looked on the Otranto Barrage. Lieut. Walter P. Groszman, at the left, has been awarded the Navy Cross.

tire of raiding it. I witnessed three such raids from out at sea, and wonderful sights they were. Suddenly a shrapnel shell would be seen bursting high up over the city, and then for an hour the bombardment would continue. Weird sights they were.

On the Albanian side could be seen, also at night, the heavy artillery fire from the Balkan line.

Surface raids by the enemy were the bug-bear that constantly hung over our heads, for the more effective we became the greater became their desire to annihilate us. Fortunately, our intelligence sources were always able to get the information of contemplated raids, and in turn theirs found out that we knew of their plans, causing them to give up for the time being. Had hostilities continued very much longer, they no doubt would have gotten down sometime without us having been forewarned and then there would not have been so many chasers to return to the home port.

Our chasers, under certain conditions of light, resembled submarines so much that on numerous occasions we were fired upon by friendly vessels. There were, of course, recognition signals, and the failure to give an instantaneous reply to a challenge, drew a shot. To appreciate the alertness necessary in this respect alone, just picture yourself in the center of a large circle on a dark night. A light flashed for just a second, somewhere on the circumference, must be caught and recognized and the proper reply made. If the eye does not happen to catch that flash then the next flash in all probability will be from the mouth of a gun and a shell dropped somewhere close aboard. We were working on the orders of shoot first and investigate afterwards and an unanswered challenge meant an enemy, and we could not continue to challenge because it would give the enemy a very definite point to fire at.

On one occasion a unit of chasers had worked pretty well toward the north in pursuit of a sub on a particularly dark night when a surface vessel was very dimly made out some 800 yards distant. The challenge was made but remained unanswered. The commanding officer of the leading chaser knew that he was near the line where the British destroyers should be patrolling, and, thinking that it was probably one of them, wanted to make sure, so he challenged again. No response was forthcoming so he let go with the three inch. He got

a direct hit right into the boiler room of what proved to be a British destroyer after all. The destroyer was entirely disabled and had to be towed to port. Just why they had failed to answer the challenge we never did find out, but, of course, the blame lay entirely with the destroyer. It only goes to show that everybody had to be on the job every second of the time that he was on watch.

On the night of September 29 twelve of us were ordered to sea, very mysteriously, destination unknown. That something important was afoot we knew from the fact that Captain Nelson himself was leading the squadron, aboard one of the chasers, and each chaser had taken aboard a hospital apprentice and some extra radio men. The next day, at noon, we arrived in Brindisi, Italy, and were then informed that we were to take part in the big bombardment of Durazzo on the Albanian coast. Durazzo was not only a submarine base but also the port of entry and supply for the Austrians along the Albanian front. Its destruction would materially affect both their sea and land forces.

It was to be quite an ambitious undertaking. Durazzo is on a large semicircular bay, protected by numerous mine fields and nets, both inside and outside of the bay. Along the shores and on the heights of the bay were seven or eight heavy batteries under whose guns we had to work.

Three Italian battle cruisers and three British light cruisers constituted the main offensive, while destroyers, torpedo boats and our chasers brought the attacking squadron up to about 35 vessels. There were also 45 airplanes in the engagement, some for bombing and some for fire direction. To avoid a possible attack from the Austro-German fleet from the north, a screen of British, French and Italian ships of various types had been sent about 50 miles to the north of Durazzo.

Our part of the work was to screen the larger vessels against submarine attack and to prevent the escape of any vessels from the harbor.

All day of Tuesday, October 1, we were busy with our preparations. Provisions were made for the destruction of the ships in the event of imminent capture, for a U. S. ship may never surrender. Means were provided for the last minute disposal of all code books, confidential publications and the like, ammunition was tested, guns tried out, in fact everything brought up to the highest point of perfection. After all the mechanical appliances had been gone over, the



The Otranto Barrage from the heel of Italy to the Island of Corfu.

men themselves got theirs. Navy regulations provide that before going into battle the men shall bathe and put on clean clothing, to guard, as much as possible, against infection in case of wounds. It was not until they were ordered to bathe that the men seemed to realize what lay before them. The usual good-natured banter was just a little more boisterous than usual and their spirits never flagged.

It was a 90-mile run to Durazzo, and the chasers were to leave at 3.30 A. M., followed at intervals first by the Italians and then the British.

One of our chasers had the misfortune to wrap a wire hawser around one of her propellers in leaving her berth at Brindisi, and, while the rest went on, I was ordered to stand by to help her get clear. After an hour's delay it was necessary to leave her behind as it was impossible to clear the propeller without a diver. Brindisi harbor is very intricate and narrow, and in the pitch blackness of

that early morning I was hard put to find my way out. I had never been there before, was unfamiliar with its mine and net defenses, navigation lights, of course, not permitted, but after sweating blood for about an hour, found myself in what I thought was open water. Later it developed that I had run for 12 miles through a mine field. Those mines were set at a depth of about 2 feet greater than my draft, but a considerable sea was running, which should have dipped me down onto them. Again a guardian angel was sailing with me, for we hit nary a one. After an hour's run at full speed the rest of the chasers were picked up ahead.

Arrived off Durazzo we waited for the Italian battle-cruisers, whose smoke could already be seen on the horizon.

The shore batteries got busy as soon as we got fairly in range, but we just cruised around and kept them guessing as to what was coming off. As soon as the big ships came up, three chasers took positions on either flank of the column and accompanied them over their firing sector with every faculty alert to the first sign of a sub. Three chasers were detailed to guard the north entrance and two of us at the south entrance.

Shells from the land batteries were by this time coming seaward pretty fast, but our steaming zig-zag at full speed kept us away from the immediate spots where the shells fell. Some came pretty close, but then a miss is as good as a mile.

The unit at the north entrance had the most interesting time. A hospital ship that was in the harbor steamed out at the beginning of the engagement and some submarines apparently used it as a screen. They all came out of the north entrance and it wasn't long before our boys were after them. A periscope was sighted and was shot away by the first shot from a chaser. A dash was made for the spot and depth charges dropped. There was no room for doubt as to that sub's demise, for he was literally blown to pieces.

Another sub showed for a moment and a dash was made for him, and even though he also was destroyed, still he had gotten off a torpedo which struck the stern of H. M. S. Weymouth, killing two men and blowing off about 15 feet of her stern.

In making the attack on one of these subs the switches on the

chaser were thrown out by the force of the first depth charge explosion, stopping the engines. The commanding officer knew that the sub was just beneath him and another charge should be dropped. His attention was called to the fact that his ship was stopped and would probably be blown up if he dropped a bomb, but he simply yelled, "This is war, to hell with safety first, let her go." The charge was dropped and though the chaser was badly shaken up no serious damage resulted.

My own unit had really little to do. We almost had a little private party with a destroyer that seemed to think that the south entrance offered an avenue of escape, there being only two chasers there, but when we steamed in to meet him he had a change of heart and turned back to seek the protection of the shore batteries. It was really ludicrous, for he had at least six guns of from four to six inches against our two three-inch, but I guess Yankee bluff looked good to him. He was later blown up by two British destroyers who followed him into the harbor and by some beautiful team work landed a salvo of six shots right into him, sending him into kingdom come amid a cloud of spray and steam. Unfortunately we could not be in at the finish, for we had certain prescribed limits to patrol and so could not leave them.

The net result of two and a half hours' work was the complete silencing of all the shore batteries, Durazzo a pile of dust and flames, five transports and two destroyers sunk, a hospital ship captured and several thousand men killed. In other words, a finished job. Our own losses were only two killed on H. M. S. Weymouth when she was torpedoed.

In the blowing off of her stern the Weymouth lost her rudder, but proceeded back to Brindisi under her own power, steering with her engines. It was, of course, necessary for her to proceed slowly, so a screen of destroyers and our chasers accompanied her back to port.

It was rather a history-making day for our little chasers, for it is the only major engagement of the war in which American vessels took part.

After our party at Durazzo we went back to our barrage duty, and

it was only a month later that Austria read the handwriting on the wall and wisely decided that it was a losing fight.

With the signing of the armistice our work became one of mercy and investigation among the Jugo-Slavs in Dalmatia. Much valuable information for our Government was gathered, and our flag was shown in many little ports where it had never before been seen. With the completion of that work, the war duty of our wonderful little yessels came to an end and our thoughts were turned to our loved ones at home.

It was not a propitious season for chasers to cross the Atlantic, so our skipper got permission to make use of the intervening time to see a little of the brighter things, and an itinerary of the most interesting ports of the Mediterranean was arranged.

Right then we changed from "Hun Hunters" to "Fun Hunters."



CHAPTER VIII

HOW IT FEELS TO SINK A SUBMARINE*

BY MACLEAR JACOBY, LIEUT. (J. G.) U.S.N.R.F.

ON October 12, 1917, I was assigned to duty as commanding officer of the U. S. Submarine Chaser No. 129, outfitting at Norfolk for distant service. Like the other sub-chasers, the "129" underwent the usual trials and tribulations of this sort of craft in getting from the United States to where the enemy submarines were most active. My place of action was the Adriatic Sea. The "129" arrived there on the 12th of June, 1918, and immediately took up the severe and tedious patrol duty on the Otranto Barrage line.

On September 30 we received orders to prepare to get under way at 9 p. m. on a secret mission in company with eleven other chasers. This savored of something very good after months of never ending cruising between the Island of Corfu and the heel of Italy listening for the Hun.

Captain Nelson was in command on the "S. C. 95" when the little squadron cast off from the mooring buoys at the designated time. Great was our joy when we headed north—this meant something doing in the upper Adriatic. Often we had speculated among ourselves on the chances of raiding an enemy submarine base, such as Cattaro, Pola or Durazzo. Needless to say, everyone was most anxious to try conclusions with the enemy and no one welcomed the chance more than I did.

The following morning, October 1, we arrived at Brindisi. With the customary snap which always characterized Captain Nelson's submarine chasers, we steamed past the nets and past several large Italian and English cruisers. After making fast to the dock the first order that came around was one of just three words, "No liberty ashore." Something was in the air.

That afternoon all officers were called together on the "95" for what we were fain to call "hot dope." And it sure was hot. In

* Reprinted from *Motor Boat*.

conjunction with the Italian and English cruisers we were to participate in a bombardment of the enemy port of Durazzo, Albania. Various instructions were given out as to the plan of action to be taken. Quite a discussion arose as to what method was the best to use in destroying a chaser, if one should be in immediate danger of capture. It was finally decided to set them on fire if the occasion should arise for so doing. After this, all hands repaired to their respective ships and prepared all ordnance gear for immediate use on the morrow. All hands worked far into the night loading machine gun belts, pistols, shining up bayonets, overhauling breech mechanisms on the 3 inch and "Y" gun, and all depth charges were carefully inspected as to their readiness for dropping.

The chasers got under way the next morning at 4 a. m. (2 a. m. G. M. T.), and stood out of the harbor; that is, all except the "244," which had the misfortune to wind up some wire rope in her propeller, necessitating a diver. There were then eleven chasers that actually went to Durazzo. Durazzo is a semi-circular shaped port, really an open roadstead. It is, however, quite important commercially, being the chief seaport in Albania, with railway connections to the interior. The Germans were using it as a base to send in supplies to help the Bulgarians and also a harbor of refuge for their submarines going up or down the Adriatic. It was for these reasons that the Allied forces were bombarding the town and whatever ships might be lying in the roadstead. After demolishing the place troops were to be landed and the country occupied. No doubt if the war had continued Durazzo would have been used as an Allied base for operations from the land upon Cattaro and other enemy ports.

The Italian and British cruisers were to leave Brindisi at 7 a. m. and make a speed of 18 knots to Durazzo—a distance of 60 miles. We averaged 10 knots and timed our departure so as to arrive off the Albanian coast at the same time as the Allied ships. Down in our hearts we were hoping for a little fun all alone before the big boys arrived.

About 9:30 the dim outlines of the rugged Albanian coast hove into view. On we eleven Chasers came nearing the coast at every turn of the propellers. It more than once crossed my mind what the Austrians said when they saw eleven little American ensigns snapping

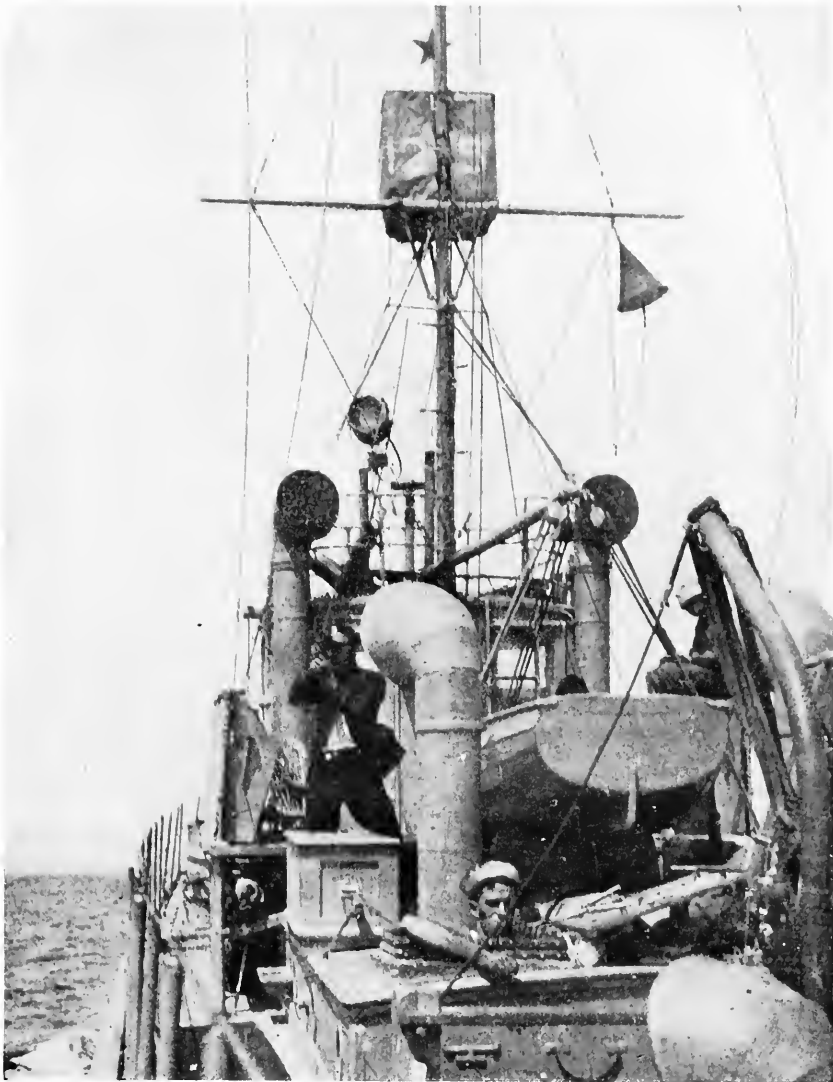

Photograph by courtesy of Ensign Alfred Loomis, U.S.N.R.F.

Lieut. Jacoby takes a sight from the bridge of the "129"—note the gold star above the crow's nest awarded for sinking a sub at the battle of Durazzo. Jacoby has been awarded the Navy Cross.

in the breeze and boldly approaching the coast. Perhaps they laughed at our size, but I am inclined to think that our presence cast a decidedly dark cloud across their hopes.

We were within five miles of the coast when a smudge on the horizon indicated the big ships. The signal was hoisted to take assigned positions. My position was last boat in a unit of three Chasers assigned as a screen to the British light cruisers, when they rounded their turning point off Cape Pali preparatory to coming into the bombarding sector. Cape Pali is the northern cape at the entrance to the harbor of Durazzo, as you will see from the diagram.

Our unit was known as "Unit B" and was commanded by Lieut. Wilden A. Ott, U. S. N., aboard the "S. C. 215," considered the fastest Chaser at Corfu. Aboard the "215" was Lieut. Commander Paul H. Bastedo, U. S. N., who was in command of the unit for this special occasion. The other Chaser in the unit was the "128," commanded by Ensign H. R. Chambers and ably assisted by Ensign H. A. Ball.

Besides myself in the "129" was Ensign B. F. Hiscock, a real old Florida fisherman, who knew seamanship and the handling of small craft from A to Z. Backing up the officers was a crackerjack crew, composed mostly of regular navy men, all seasoned veterans. In charge of the gun crew was Chief Boatswain Mate M. M. Padgett, a navy man who had seen twelve years' service; at the "Y" gun was H. F. Oliver, a machinist mate, and sitting on the stern with a large knife duly and carefully sharpened with childlike devotion was N. M. Walden, also one of the engine-room force. These men had been carefully chosen for their jobs and great confidence was placed in their ability to do the right thing at the right moment. There were three men in the engine-room and the rest of the crew were at their regular stations. I was in the pilot house and Mr. Hiscock was on top. Thus we went into the bay.

With engines going at full speed we steamed into position, steering a northeasterly course. While proceeding on this base course all the fun started. On my starboard beam were the shore batteries of Cape Pali, firing as rapidly as they could get the guns to bear. We could easily make out the red flashes, then the splash of a shell explosion.

One salvo from the shore batteries hit the H. M. S. "Weymouth" and damaged the foretop.

At precisely 10:40 a lookout reported a moving feather on our port beam. Being in the pilot house at the time, I could not see it. Mr. Hiscock immediately picked it up. There was no time to lose. I decided therefore to get this fellow myself.

"Give her left rudder," I directed the wheelman.

Turning gradually to the left and directed by Mr. Hiscock, I brought the periscope directly ahead. Allowing for his course, it was my intention to sneak up on him and cross his course and when right in front of him let go all depth charges. He was distant from me about 1600 yards.

I had covered about 800 yards of this distance when I heard the hoarse shriek of my whistle. Too late! Some one had stepped on the whistle on top of the pilot house, thereby giving a signal to let go a charge. Despite my frantic endeavors, Walden rolled a charge overboard and it went off with a tremendous bang at 50 feet. My heart sank, for surely this crash would make the submarine submerge.

Keeping my eyes on his feather, I saw the periscope come out of the water. He had come up a little, thereby showing his second periscope. The explosion of the premature depth charge must have shook him up. By this time I was almost on top of him. Leaning out of the pilot house window, and with my eyes glued on him, I rang the whistle cord for a "fare." It was immediately forthcoming—four times I rang for a depth charge. These charges went off directly across his course and the periscope disappeared. I thought surely at the time I would ram him. Just by the merest chance he slipped under me. After firing these four I turned to the left and gave the signal to let go the "Y" gun. At the same time one more from the stern was discharged, this last one at 150 feet.

These last three explosions put the engines out of commission for a moment. On every side vast quantities of oil were rising, together with many bubbles. While resting in that position one of the crew reported a boiling patch of water. Sure enough, on my port beam one could see a sort of geyser rising, undoubtedly an air tank, a conclusive proof that the submarine had received a vital blow.

By this time we had gotten the engines going again—the explosion

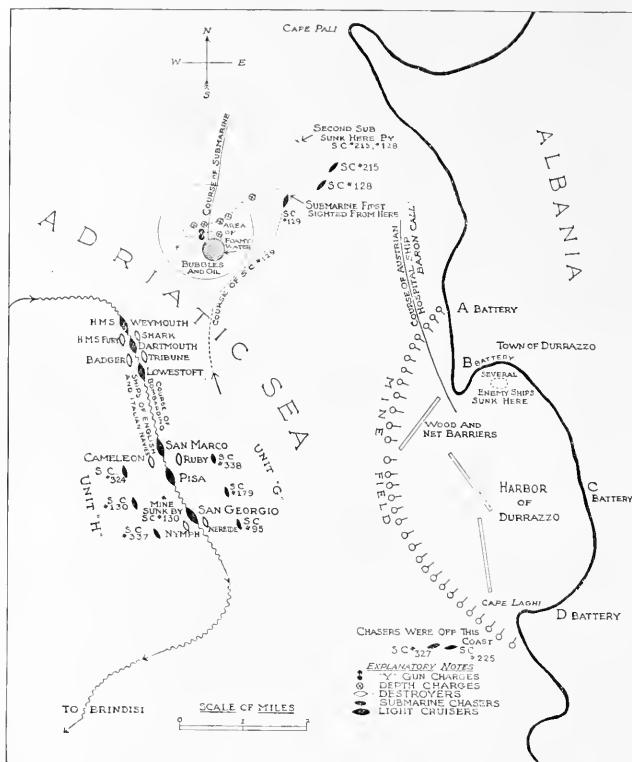

Plan of the Battle of Durazzo from a sketch by Lieut. Jacoby.

of the depth charges had thrown every switch out of the switchboard. The "128" and "125" came alongside at this moment and I reported to Lieut. Commander Bastedo that I had gotten a submarine. The three vessels then proceeded in toward the coast to pick up an enemy hospital ship. The bombarding ships had by this time completed their bombardment and had made off for Brindisi.

The hospital ship was seen in the distance escorted by British destroyers and having on board a British armed guard. We acted as escort to the "Baron Call," as it was later found to be, and set course for Brindisi. The hospital ship was found to be of no value and later was returned to Durazzo.

So much for the bombardment of Durazzo. You all know what

the other Chasers did, especially the "128" and "215," who got a submarine between them.

Before passing, I want to show you an example of quick thinking, performed by Ensign Henry R. Dann, temporarily in command of the "S. C. 130." While screening the Italian cruisers he spotted a floating mine directly in the path of the oncoming British destroyers. There was no time to sink the mine, but with a quick presence of mind he laid his ship alongside the obstacle, in the course of the Britishers. The result was that the destroyers had to sheer out to avoid hitting the Chaser. Undoubtedly this quick work prevented the loss of a destroyer.

People have asked me why the submarine did not see me. In my judgment the submarine was so intent on getting ready to let go a torpedo at the "Weymouth," a British light cruiser, that he never noticed the little Chaser sneaking up on his wake.

The author had occasion after the armistice to visit the German submarine base at Cattaro and found it to be most well equipped in everything that a submarine has use for. Many interesting souvenirs were collected at this base and the engineers reported that German waste was found to be better for the Standard engines than our own article. To illustrate the efficiency of the intelligence branch of the Austro-German navy: I found on one of the Austrian battleships a picture of the "Weymouth" with her stern torpedoed, which picture the Austrian officer explained had been secured just after the bombardment. I was most anxious to find out particulars about the submarines at Durazzo, but never could get anything definite.

After the armistice the "129" went to Athens, Greece, where it became a unit for the Red Cross distributing supplies throughout the islands in the Aegean Sea. This service was followed by similar work around Constantinople. On May 25, 1919, the "129" sailed for home, mounting a star for her efforts at Durazzo. It was a proud moment when we sailed up New York Bay, bringing to a successful conclusion a 30,000-mile cruise.

CHAPTER IX

FARTHEST NORTH IN A CHASER

IT is not generally appreciated that the Chasers reached Archangel. They did, and their cruise up the Norwegian coast and around North Cape, far into the Arctic Circle, is one of the most interesting exploits in the short but spectacular career of these little ships. It is particularly noteworthy in that during this jaunt of nearly seven thousand miles the three vessels of the detachment were "on their own" without the possibility of any outside mechanical help. My friend, Lieutenant (j. g.) G. S. Dole, veteran of the Otranto Barrage and wearer of the Navy Cross, was in command of No. 354, the flagship, and his story of the cruise follows:*

After having participated in practically every phase of naval activity in which the forces of the United States engaged during the war, two major operations yet remained in which the Submarine Chasers were destined to take part; first, our land forces in northern Russia were clamoring for naval assistance to insure their immediate relief and, secondly, a mine field consisting of more than fifty-three thousand mines covering an area of some six thousand square miles of the North Sea formed a menace to navigation demanding speedy removal.

The north Russian Expedition, as the expedition for the relief of the United States Land Forces in north Russia was known, is unique in the history of the Submarine Chasers in that for fifty-three days they operated without repair ships or bases, and covered a distance of 6,950 miles. Their mission was to cooperate with the United States, Russian and Allied military and naval forces in northern Russia, principally in establishing and keeping open communications between widely separated military and naval units.

The story of the Russian detachment of Submarine Chasers begins at Lisbon, Portugal, where the detachment assembled and received its equipment of guns and ammunition in preparation for the expedition. On the 10th of April it left Lisbon for Inverness, via Brest, France.

* Reprinted through the courtesy of *Motor Boat*.

where we received more supplies, Milford Haven, and the Caledonian Canal, a distance of 1380 miles.

The period of preparation at Inverness consumed nearly as much time as the actual expedition and operations that followed. To meet the conditions of the Arctic Sea it was necessary to go into drydock, overhaul all underwater fittings, and secure metal sheathing for protection from ice. Nothing was left undone to put the boats in the best possible shape for the tasks that lay before them. Also numerous stores, winter clothing and supplies had to be taken aboard, a British tanker had to be loaded with extra supplies and spare ammunition before we were ready to start north.

On the 6th of June our little detachment consisting of the U. S. Submarine Chasers Nos. 354, 95, 256 and the H. M. S. "Birchol" (tanker) set out from Inverness for Archangel, stopping for a few hours at Lewwick, Shetland Islands, for the tanker to take on fuel and water for the long run. From the Shetlands we laid our course to Holmengraa, Norway. The North Sea lived up to its reputation and gave us a rough passage. Many times we looked back to see if the tanker was afloat or showed signs of distress. We had considerable anxiety concerning the cargo of the tanker, as it was very uncongenial cargo. Necessity makes strange companions and 2,000 rounds of live 3-inch shells and 800 tons of aeroplane gasoline separated by a $\frac{3}{8}$ -in. steel bulkhead certainly possessed possibilities, especially if, as was the case, no suitable stowage for the ammunition was possible. If the shells had ever started to shift—well, the expedition would have been off. The Captain of the tanker was game, and heart and soul with us in the expedition, driving his ship at maximum speed in all kinds of weather, so as to cause as little delay as possible. On the 4th of July, when the United States forces in Archangel were due to observe Independence Day by full dressing ship, the H. M. S. "Birchol" full dressed ship with us. We were all pleased when at the close of the expedition the Captain of the tanker received the recognition he so well merited.

Holmengraa Light looked very good to us as we rounded it and came to anchor in the lea of a group of islands, awaiting the arrival of "lodz" or pilots from Bergen. Leaving Holmengraa on the 9th of June, we soon entered one of the fiords and were sailing "behind the

land." To the novice one of the striking features of the cruise along the Norwegian coast is that from the Naze to the North Cape the route lies, with the exception of about 100 miles of open sea, behind thousands of islands forming a passageway almost completely sheltered. From Holmengraa to the North Cape we passed through nearly a thousand miles of fiords and "inner leads" of surpassing beauty. The ordinary maps give no conception of the nature of this country. Navigational charts give only an approximate idea. The whole scheme of nature is on such a grand scale that photographs fail to show the impressive grandeur of the scenery. This country must be seen to be appreciated. New vistas of snow capped mountains rising abruptly from the sea with the picturesque Norwegian villages at their bases, were continually opening, each more imposing than the preceding, making it difficult to compel yourself to turn in. All hands were on deck most of the time. I purposely do not say day and night as we traversed the whole distance and returned in perpetual daylight.

Leaving Holmengraa, our first stop was scheduled to be Tromso, but we were forced to anchor in the lea of the island of Syd (South) Fuglo, for a few hours to allow the tanker to nurse a hot bearing, the result of forcing her engines to the limit. We were running $9\frac{1}{2}$ knots, over a knot faster than the normal cruising speed of the tanker.

As soon as the inner leads of this region are reached the landscape takes on an entirely different appearance. Green fields, with thriving crops, numerous villages, and beautiful summer homes mark the lowland. An occasional automobile, generally recognized as of well known American parentage, is seen moving along the water front. The waters are alive with small fishing craft of all descriptions, going out light and coming in heavily laden, and Laplanders in characteristic costume carrying on their trade in small boats generally propelled by oars.

Making our way among numerous ships we came to anchor off Tromso, the metropolis of the Arctic Circle, on the thirteenth of June with the midnight sun shining brightly and the city showing almost the life of mid-day. Small boats immediately swarmed about us peddling their wares, postcards, candies, fish, and fruits, or looking for an opportunity to take liberty parties ashore. It was here we were first introduced to the Arctic scale of prices. With apples at 15 cents apiece it compared favorably with New York.



The officers of the Chaser expedition to Archangel.

Eighteen hours was all the time allotted us in Tromso, as the greater part of the journey lay ahead of us. It was here that the pilot's social engagements conflicted with his business and we sailed without him, resolving forever after to keep pilots under lock and key while in port.

Passing Hammerfest, the crescent city of the North, we entered the Soro Sund, noted for its remarkable scenery of mountains and glaciers, and were soon standing out in the open Arctic Sea to the northeast of North Cape. The North Cape (Nord Kap) was fast in the grip of snow and ice almost to the water's edge and was a credit to its name.

Keeping well clear of the coast, as the war developed the bad habit of mining the waters off prominent capes, land falls and channels ordinarily used by mariners, we reached our point farthest north, latitude $71^{\circ} 23'$, 293 miles north of the Arctic Circle, rounded Nord Kym and set course to Vardo, one of the easternmost ports of Norway where we were to stop to refuel. The chart is a little out of scale and I have drawn the course to the latitude actually reached and checked by observation and bearing.

The coast of Lapland is bleak, desolate and partially snow clad, with little evidence of human life, and is strewn with wrecks of ships that were driven ashore during gales or caught in the ice or that came to grief trying to cut mine fields.

Four hours at Vardo were sufficient to refuel and get our fill of the odor of fish oil. We lost no time in getting under way. The Murman coast was no improvement on Lapland. Barren and forbidding, offering no shelter, it served as the home of countless thousands of sea gulls. Some of the great gull rookeries of the Arctic are located along this coast, and the air was literally full of flying birds. The report of a gun would cause thousands resting on the water to rise and add their din to the rest. Seal and ducks were also abundant.

We were very much surprised to sight a vessel flying the American flag off Kola Inlet. It turned out to be the U. S. S. "Yankton" that had been laying to for four hours off Kola Inlet awaiting our arrival. We were going into Murmansk, prior to going to Archangel but the original plans were changed in order to expedite our arrival at our destination.

On the afternoon of the 16th of June the peculiar condition of the sea led us to believe there were breakers some distance ahead. Consulting the charts we could not account for any such disturbance, owing to lack of wind and shoals. We were, however, soon to solve the question, as on coming closer, the white line covered the horizon to the eastward and ice was the only answer. The "Yankton" headed to the north to look the field over, determine its extent and see if it was possible to go around it. The northern limits seemed interminable and at about 4 P. M. the "Yankton" turned back and we entered the field.

After passing through the first barrier which proved to be light, we found numerous leads and open places. The change in temperature was very noticeable, and we were soon enveloped in a heavy fog, so dense that at times we had to rely on the "Yankton's" whistle in order to follow her wake, though she was for the greater part of the time hardly more than a hundred yards ahead. After the novelty of the situation wore off, overcoats and winter clothing made their appearance on deck. We were favored by a calm sea with no surge to the ice, which would have made it impossible for us, and the perpetual daylight made it easier to pick channels. Once the "Yankton" was stopped but was able to back out and try another lead with better success. The tanker also brought up solid but managed to get free.

It took us until ten the following morning before we finally cleared the field, 10 miles to the eastward of Cape Goradetski, and left it and

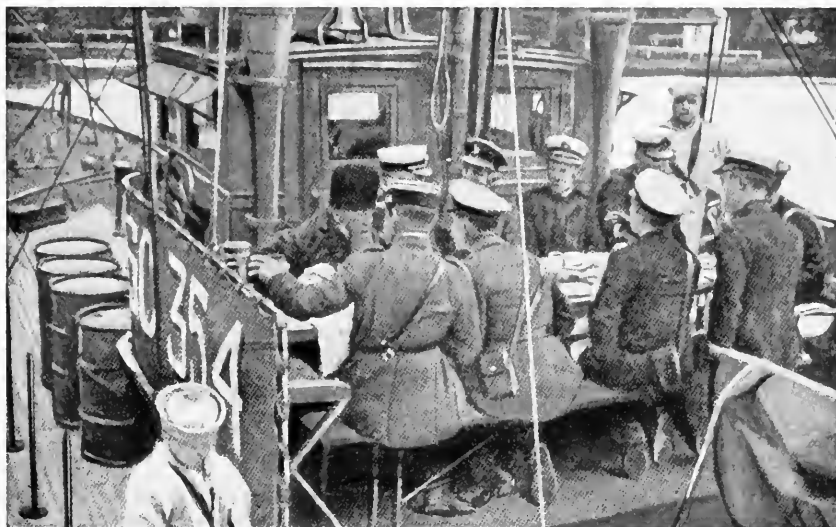

Admiral McCully's party aboard the "No. 354" at Solovetzi.

its enveloping fog behind. The ice was snow covered and practically every inch showed evidence of being packed by seals.

As soon as we cleared the entrance of the White Sea the coast showed a marked change. Pine and fir clad hills took the place of barren snow-covered cliffs, and villages appeared in clearings at the mouths of streams. The most conspicuous landmark in practically every village is its white cathedral with its many gaudy colored domes and steeples, contrasting sharply with the somber log houses of the natives.

On either bank of the Dwina, from its mouth to Archangel, a distance of 35 miles, is one continuous succession of lumber yards and saw mills. Only an occasional mill showed signs of being in operation, and then only to partial capacity. Millions of feet of lumber lay stocked in regular rows like the blocks of a city. The supply seemed endless. Small groups of buildings clustered about the mills housed the workers of the locality, though outside of women washing clothes in the river, we saw very few laboring. Young Russia seemed to be in swimming, or getting ready to go in or just coming out while the men lounged about the wharves or banks smoking.

This whole region which was fated to be destroyed by fire a few weeks later gave the impression of a giant industry gone to waste. Whatever work was going on was being done by women, even to rowing the boats carrying produce, principally hay, grain, fish and farm products.

About noon on the 18th day of June we came to anchor off the city of Archangel. The day was uncomfortably warm and most of us spent considerable time in the water during the early hours of the afternoon prior to going ashore in the evening. The temperature of the water was 71° and the only drawback to swimming from the ship was the swift current of the river.

Archangel is a city of one principal street stretched for nine miles along the east bank of the Dwina, giving the impression of a large city. The large white public buildings and cathedrals stand out sharply against the green background and throughout the whole length of the city the wharves and river are crowded with ships of all descriptions—transports, merchantmen, men-of-war of Russia and the Allies.

The peace time population of 45,000 was greatly swelled by the military and naval units. The streets thronged with men in uniform. Regimental bands gave evening concerts in the parks where the pleasure seekers congregated much the same as in our own country. The theatres and moving picture houses were well filled but the restaurants received little patronage and the reason was not far to seek. Two and one-half rubles, about 12 cents,* would purchase a ticket to the pictures and 5 rubles was the usual price of a seat at the principal theatre, while to get a satisfactory meal, from 160 to 280 rubles were required. Money proved to be of little value owing to the greatly inflated currency, the instability of the government and the great shortage of food. Barter was the popular method of exchange.

But we had little time ashore. It is not the purpose of this article to deal with the military situation; that has received sufficient attention during the past months. We shall merely mention that from the time we arrived at Archangel until we left it was one continuous race between Archangel and the ports of the White Sea, Kem, and Keret Bay, carrying officers, men, dispatches, mail, money and supplies. Seldom were we in a port more than a few hours before we were dispatched

* Before the war the ruble was worth 52 cents.



Waterfront of Archangel on the Dwina river. This ancient port was Russia's northern gateway until the railroad was put through to Murmansk.

on some mission to another port. This with the necessary time for drills and target practice, kept us moving most of the time and enabled us to become familiar with the greater part of the White Sea.

We never lacked passengers. Those whose transportation was an immediate necessity came aboard reluctantly and with many misgivings. Some after bringing their baggage looked at our small craft and found business that would detain them a few days. Some of the higher officials, having heard of the size of the boat, dispatched a messenger to express their regrets that they would be unable to make the trip. Notwithstanding the above, we always sailed with every available space below decks taken.

We were very fortunate in being able to visit Solovetzki Island and its monastery. The "354" has the distinction of being the first vessel flying the American flag to visit this port. Solovetzki is the Mecca of the pilgrims of Russia. Every Russian of the Greek faith hopes some day to visit this monastery. The monastery itself presents an imposing spectacle both on account of its size and architecture. The interior is no less remarkable. The walls abound with paintings.

Many of the rooms, the altars, shrines, etc., were closed to us, only those of the faith being permitted to enter. But we were allowed to look through steel gratings in some cases.

The paintings and mural decorations of this monastery are noteworthy for the unity of theme. Everywhere you turn you are greeted with representations of men and women undergoing various forms of torture. The slaughter of the innocent, various tortures by hell fire and devils with spears, and the whipping post seemed to be the most favored designs.

The priests themselves were most hospitable, inviting us to their rooms where they brewed tea in their characteristic samovars, and also gave us some of their terrible black bread which we managed to dispose of in other ways than by eating. Their rooms were simply furnished with a plain wooden table and chairs and a bed of boards without mattress. Oil paintings and ikons adorned the walls. The wives of the priests occupy a separate building built of brick and quite pretentious, a few hundred yards from the monastery walls.

In addition to carrying on religious work the monastery owns and operates a shipbuilding plant, and dry dock. It also carries on trade and passenger service with various ports. The monastery is also interested in agriculture and fishing and has the appearance of being a thrifty business corporation.

We were all anxious to get back to Archangel and see more of the city and its people. There were still two American regiments there awaiting transportation and we did not lack guides. The athletic games at Kego Island on the fourth of July, baseball, boxing, races, wrestling, etc., under the auspices of the U. S. naval forces, to which the whole city of Archangel was invited and a good section attended, and a very interesting farewell ball given by the Embassy during which some of us struggled vainly with the Russian language, completed our social engagements, and on the fifth we sailed for Murmansk.

We stayed two days at Murmansk, spending most of the time trout fishing in the streams and lakes. Some of the parties had good luck; all had a good time, notwithstanding the opposition of the mosquitoes. The country was beautiful and air exhilarating. The bathing in the lakes was also good. Wild flowers seemed as abundant as in our



Solovetzki monastery on an island in the White Sea.

own forests and violets were plentiful although well north of the Arctic Circle.

Our trip back over the same route was even more interesting to us than the northward cruise. We stopped at Vordo and Honningsvog to pick up pilots. Honningsvog is the northernmost town in this region, latitude $70^{\circ} 59' N$. It is a thriving fishing village of about 600 population. This village, teeming with life during the summer months like many others that we passed on our journey through this north country, was soon to be desolate. During the winter most of the fishing villages are turned over to the nearest tribe of Laps, the inhabitants spending their winters in the larger cities of southern Norway.

Before reporting to the Commander of the mine force, the Admiral gave us a week's leave in any city of Norway. Of course we chose Christiania. In the first place we would complete our trip, see practically the whole of Norway, and it would give us an opportunity to take side trips into Sweden and Denmark.

The trip from Bergen to Christiania is noteworthy for the great number of fine summer homes that line the fiords and for the numer-

ous yachts and motorboats encountered. Boating and skiing might be called the national sports of Norway and it seemed as if almost every one was on the water. Arendal on Troms Sund is one of the great summer resorts of Norway. We went a little out of our course to go through Arendal and it was well worth the time. In fact many of us would have been willing to have anchored there and spent the week.

We arrived at Christiania on the 18th of July, just one month after reaching Archangel, and forgetting our cares and hardships of the trip, proceeded to enjoy our stay. The people of Christiania were most hospitable and when on the 25th we sailed to join the remainder of the detachment at Bergen, the mine fields offered no consolation.

The following skeleton log and extracts from the official report show various data interesting to motor boatmen, and also summarizes the operations:

- June 6th Sailed from Inverness, Scotland.
- “ 18th Arrived at Archangel, Russia. (Distance, 1975 miles.)
- July 5th Sailed for Murmansk.
- “ 7th Arrived at Murmansk.
- “ 9th Sailed for Bergen and Christiania.
- “ 16th S. C. 354 and S. C. 95 sailed for Christiania.
- “ 18th Arrived at Christiania.
- “ 25th Sailed for Bergen.
- “ 26th Arrived at Bergen.
- “ 27th Refueled and all these Chasers sailed for Kirkwall.
- “ 28th Arrived at Kirkwall.

SUMMARY OF DATA

	S. C. 354	S. C. 256	S. C. 95
(1) Miles Run	5570	4774	5527
(2) Hours under way	681	744	661
(3) Days in port	24.4	21.3	24.2
(4) Days under repair	None	None	None
(5) Fuel consumed under way, gals.	11,381	9510	12,835
(6) Fuel consumed in port, gals....	39	250	190
(7) Average speed	8.2	6.4	8.4
(8) Gallons per nautical mile	2.04	2.00	2.30

"The performance of the boats during this period of running was excellent. They averaged 3400 miles per month until reaching Christiania and during the entire period away from England there was not a single breakdown or delay for a Chaser. They received no outside assistance for repair or overhaul and the only outside assistance received was the issue of small stores and a very limited amount of provisions. The boats were kept almost constantly underway until reaching Christiania, as the greater part of the days at anchor were interrupted by shifting berth for fuel, provisions, etc.

"The boats stood up excellently, and completed the trip in good condition. S. C. 354 and S. C. 95 made the run from Christiania to Bergen (370 miles) unhampered by the tanker, at an average speed of 12.9 knots."

CHAPTER X

RACING HOME FROM BERMUDA

IT was during the homeward run of the group of Chasers that had lingered in the Mediterranean, doing the Navy's odd jobs after the signing of the Armistice, that the race home from Bermuda was decided upon. Lieut. Joseph L. Day, the skipper of the "131" and Ensign Alfred Loomis, the executive officer of the same Chaser, suggested the idea to Captain Nelson. The suggestion appealed to "Juggy," as his admiring Chaser skippers call the popular four-striper, and he readily obtained the consent of the Navy Department. Six boats were chosen, because of some distinguished service, to participate in this whirlwind finish and the story which follows* is by the skipper of the winning "131," Lieut. Joseph L. Day, U. S. N. (T.), veteran of Durazzo and the Otranto Barrage.

Great masses of hurrying storm clouds were rolling up over the southwestern ridge of that tiny dot of a reef called Bermuda, as six officers representing Submarine Chasers 90, 129, 131, 217, 224, 351 climbed aboard from the little sloop that brought them out on a flying trip from Hamilton to Ireland Island after the last evening's run ashore. Well primed with soda and ice cream (already we were training for our sojourn in Sahara) each was busy with thoughts and plans for the race which was to start the following afternoon.

The six chasers, all veterans of many a hunt for German submarines and each distinguished for some special form of war activity, were lying just outside the dockyard breakwater. They were swinging to the breeze, as only such high bowed craft can, keeping their thirty fathoms of chain stretched out well ahead, seeming, in the half light that filtered through the rifts in the clouds, like spirits alive and impatiently waiting to be off. From their engine rooms came unmistakable sounds of anxious engineers giving those last hopeful touches to their three babies, the main engines.

The weather had us all worried, not that we thought we could not go, for to a Sub Chaser man the weather is merely a barometer of

* Reprinted from *Motor Boat*.

comfort or discomfort, mostly the latter. He can always go. There was, however, a "weather permitting" clause in our orders and we were afraid we might not be allowed to start if it was very bad the next day. The barometer was the lowest I had seen it since saying good bye to Bermuda bound for the hunting grounds of the Mediterranean and Adriatic. The Hamilton paper carried the reassuring news item that slow time across the Gulf Stream was likely to be our lot. It had been breezing for two days and we knew it was bubbly outside. However, as the morning would bring its weather regardless of my desires or those of the other racing skippers, I decided to see if I had complied with all the preliminary conditions for the race.

The rules governing the race were simple, fair to all, and allowed great latitude for individual judgment. They were drawn by a man who understands Chasers and Chaser work, a man who had been with the Chasers for nearly two years and who had seen them under all conditions, from the dock-ramming stage, when officers, crews and boats were green as the tinned peas they ate, to Durazzo when he handled them like a squadron of destroyers; and back again across the Atlantic to a point where he was glad to let six of them show what they could do on their own. I am giving Captain Nelson's rules for the race in their essentials.

First: All courses, speeds, and engine combinations discretionary for each contestant in conformity with rules.

Second: Sails or any other means of helping speed may be used subject to provisions of following paragraph.

Third: No fixtures, stores or any other article will be thrown overboard to lighten ship. This includes empty gasoline oil and water barrels on board at the start.

Fourth: Each contestant may have on board at start 2,900 gallons of gasoline and must not have more than that amount.

Oil tanks must be filled to capacity. Extra oil may be carried.

Water tanks must be filled to capacity.

Provisions on board will be retained and no boat will start without at least ten days' provisions for all hands.

Fifth: Engineering.

In order to obtain accurate record of performance measurements

will be taken and logged of gasoline and oil remaining whenever changes in revolutions or combinations of engines in use are made.

The discretion allowed regarding engine combinations is only limited by the proviso that at no time will any engine be operated at a greater speed than 400 revolutions per minute.

While the contestant crossing the finish line first undoubtedly will be considered the winner, provided specified post-race conditions are met, the contestant showing the best economy performance and having complied with all other race conditions will be awarded the first place for efficiency.

At the completion of the race all three engines (main) must be in operating order, and the vessel must have fuel enough aboard to run all three engines at 300 revolutions per minute for at least 20 miles. Any vessel unable to fulfill this condition will be disqualified.

An umpire, assigned by lot, will be placed on board each Chaser, to observe transfer of gasoline, note changes in running conditions and keep records. He will act in an advisory capacity whenever his services may be of value but he will have no authority to give orders as to operating conditions nor will he be assigned an operating station at any time.

Sixth: The start will be at 5.00 P. M. L. M. T. (local mean time) Saturday, August 16, 1919, from a line 120 deg. mag., from St. David's Head lighthouse. Chasers will cross this line between the U. S. Ontario and the H. M. S. St. Abbs, having on board the official starter, Vice-Admiral Morgan Singer, R. N., and proceed to New York via Ambrose Channel, where they will finish at a line between the Statue of Liberty and the southern end of Governors Island.

The following orders were received by the S. C. 131 during the race: "When you reach the Lightship (Ambrose Channel), hail her and request instructions. If no umpire is on board Lightship, ask her to report you, and then proceed to finish line.

Saturday morning gave no signs of a let-up in the steady southwest breeze, but we found, to our delight, that Captain Minner of the Tallahassee was from the right school, and we would start on time, with a word to get to New York as fast as the Lord and our engines would let us.

Promptly at 3 P. M., after drawing their umpires, the chasers got

under way and followed the U. S. Ontario and the H. M. S. St. Abbs down the winding channel to St. David's Head. The weather had cleared considerably, the breeze had eased off, and in the shelter of the island it was comparatively smooth. The clouds which had been piling over Bermuda for the past two days had broken away, and the delightful greens of the high headlands were lighted with welcome sunlight, contrasting with the sparkling light blue of the shallow water. It was an ideal afternoon for the start.

By prearrangement all Chasers were to cross the line as nearly together as possible and they slowly jockeyed into a line a quarter mile southwest of the two starting vessels. S. C. 90 was the guide and took up her position to pass close to the Ontario. S. C. 131 took position to pass close aboard the St. Abbs with the other Chasers between from port to starboard 129, 217, 224 and 351.

At 4.50 L. M. T. the signal, international "W. R. C.," was run up on the St. Abbs by the official starter, Vice-Admiral Morgan Singer, R. N., who had kindly consented to honor us by giving us a send-off on the sporting finish of our long cruise. As the signal was hauled down, all the chasers started together, keeping position on the 90, breaking out their homeward-bound pennants and manning the rail. Making about fifteen knots as they went across the line, all hands in white uniform, and at right-hand salute in honor of the admiral, homeward-bound pennants streaming clear, the six well-groomed chasers were a most inspiring sight.

A moment later every one above decks turned-to to set sail and take every advantage of the breeze, which was fair to our turn around Kitchin Shoal buoy, six miles away. The race had started. White uniforms were rapidly changed to dungarees. Anxious eyes watched the movements of the other boats. The long grind was on.

The start was made at 4.20.18, seventy-fifth meridian time.

This was the time used by all boats and umpires during the entire race. S. C. 131 was officially the first across the line, although we on board could distinguish no difference in position between the 90, 217 and ourselves. The 129 crossed the line last, 35 seconds late. It was a fair start, and, with every one bunched, gave promise of a fight to the finish and "the devil take the hindermost."

My plan was to run 350 revolutions on three engines until the

Gulf Stream was encountered, then to slow to 10 knots using two engines making necessary repairs and to speed up on leaving the Gulf Stream to 400 revolutions on all three (the maximum allowed) holding it if possible to the finish. On paper this gave a schedule of 58 hours elapsed time to Ambrose Channel and I was somewhat in doubt as to the likelihood of maintaining it. That we did even better was due to our having an engine room force second to none, and an entire crew ready to drive her every minute.

As we passed down the course to the first turn, the 217 and 90 stepped rapidly into the lead. Our trysail was drawing well and as they were just getting their own set we felt sure they never could hold that speed so we contented ourselves with 350 on three and let her roll. At 4.50 we rounded Kitchen Shoal Buoy and, with a feeling of hope and happy expectation never equalled before, squared away for New York.

For the first few hours the sea was easy; but as we passed out of the influence of the Bermuda reefs we felt the old roll kicked up in the last two days and the chop of the present fresh Westernly. The 131 took the seas easily and no solid water came on board. The engines ran very smoothly and without any tendency to race. Before the start I was told that she was trimmed wrong and possibly she was. The reply that she wouldn't be "trimmed" right till the race was over, was perhaps justified. Three of our ten gasoline drums and one oil barrel was lashed well aft to hold her wheels down, while this was not the best trim for smooth sailing it saved the wear and tear of racing engines and paid good dividends in the weather we encountered.

As the evening progressed we could see that the leaders were not going to hold their speed. It was getting more and more choppy each hour. The breeze was about force 4 (about 23 miles) and lightning in the west gave promise of showers and squalls later on. At 10.00 o'clock I got my last look at the fleet when I could be sure of the position of each vessel. The 90 was two points forward of our starboard beam, 217 broad on starboard beam, 351, 3 points abaft starboard beam, 129, 3 points on starboard quarter and 224 astern of the Ontario.

That husky Navy tow boat was steaming according to instruction

in a position to keep as close touch as possible with all chasers. To the best of her ability she maintained touch with all by radio throughout the race; but conditions for chaser radio operation were very poor. The flying spray from a sea abeam and forward of abeam together with continual showers kept the apparatus, insulators and antenna damp and cut down radiation to such an extent that communication was difficult at all times and often impossible. Everyone was fortunate, however, in having no very serious breakdown and, although always ready, the Ontario never had to use her tow line.

About 10.30 Loomis relieved me on deck and I went below to find the quarters so hot and uncomfortable that I decided to sleep on the bridge. At that time the trysail was drawing nicely close hauled and very little spray came over the chart house. The sky was overcast but to my sorrow I took a chance.

Sometime in the wee small hours when the folks in the country are long asleep and the boys on Broadway are, nowadays, also resting peacefully, I was jolted into semi-consciousness by the slatting of our sail and the crew clewing it up. Shortly, inspired by the pelting rain which followed that first gust, down the ladder I went, sleepily dragging bed, blanket and all with me through the chart house, down the hatch and into the quarters, there to roll in again and sleep like a Christian, with gas in my nostrils and the roar of three engines in my ears. We of the Chasers can thoroughly enjoy our future Pullman berths. Loomis, however, profited by my experience and turned in below when he called me at 5.30 A. M., taking a chance on the lesser of the two evils.

In the morning between showers the 217 and 90 could both be seen from our bridge now well astern to starboard. All the other Chasers and the Ontario were out of sight and we felt confident well astern. The 351 had been holding far to the northward and we were worried a bit that she might slip by us. By eleven o'clock, however, both the 217 and the 90 had melted into the mist astern and as we had not increased our speed we felt sure we were doing well.

This day was the worst of the entire run, squalls were frequent and between them the wind averaged between 4 and 5. Although that is not much of a blow it makes things lively for a Chaser, especially when the breeze is on the bow and she is doing eleven good knots an

hour. The sun when visible at all was very fuzzy and navigation was almost out of the question. I got a sight at 10.00 A. M. and a noon sight for latitude but I was very glad that we had plenty of sea room. When a chaser is jumping and rolling as they do every six seconds unless the sea is dead calm or dead ahead, and the sun looks like a maltese cat flying across an horizon of scrambled eggs, sights are sometimes listed as doubtful. Loomis once figured out how many times we would roll going from Gallipoli, Italy, to New York, and it is my belief that the old girl concentrated these rolls especially for my benefit on August 17.

We had what we called our position at noon anyway and it wasn't so far wrong after all. We had made 216 miles and on measuring our gasoline decided we could afford to bend another 25, so we speeded up to 375 revolutions on all three engines and the water began to fly. This was the only time we had any solid water on deck; but a few green ones slid by the chart house and a lot more just didn't. They would come up and look through the bull nose; but most of them refrained from getting too sociable. Men going off watch that Sunday afternoon had to be careful, however, and it was a lucky gob who reached the fo'castle dry.

What sights we had obtained showed us that despite the heavy chop and fresh breeze we were making practically no leeway. In fact, we were, if anything, to the left of our plotted course. This was a great surprise to me on this and the following day when we passed through the Gulf Stream to boot, we did not drift over twelve miles in the entire trip. As I allowed 18 in laying my course, I was forced to change course on Sunday afternoon one degree and on Monday afternoon seven degrees, both changes being to the right. At that we picked up Navesink only about a point on the port bow and had to head up even more to hail Ambrose. Although this rather worked out to our advantage, with the weather we had, it was a surprise. and I can only lay it to the fact that the Chasers never make as much leeway as you expect them to, and also that I allowed, perhaps, a little too much for the Stream.

After noon we were unable to get any sights so contented ourselves with watching the sea and the clouds and hoping for smooth weather. About 4.00 P. M. the water commenced to darken and by

5.00 we were running through the deep indigo of the Gulf Stream. Here the sea was much less choppy and our speed increased perceptibly.

At 6.20 p. m. we received the news by an intercepted radio from the Ontario of the only accident of the trip. S. C. 129 had broken a crankshaft and now having only two engines was disqualified under the race rules. She was still running nicely on two engines, nevertheless, and made a good showing at the finish as her time was well under that of the best previous performance.

The night in the Gulf Stream was an interesting one. In the early evening there was a succession of thunder storms accompanied by almost enough wind and rain to equal the black squalls of the Straits of Otranto in the Adriatic. The spray and rain were so persistent that our port running light shorted and we spent a busy hour chasing trouble and getting our lights all bright again. Before I left the deck, however, the sea had quieted down and the weather gave promise of better going.

About 4.00 a. m., Mr. Loomis called to me to look out on the starboard side. We were passing the U. S. S. Hannibal, one of the supply ships of the main Chaser convoy which had started 24 hours ahead of us. She loomed up close aboard and we passed her very quickly as we were making about five knots over her best speed. This was the only ship of our own detachment sighted during the trip, as we passed the Leonidas, Captain Nelson's flagship, and the main body of chasers in the fog a few hours later.

The morning of our last day at sea dawned hazy, and before nine o'clock the fog was rolling by in heavy banks. Above the fog, though, the sky was clear and at times the sun broke through. As we needed a position badly now, and since we must have one some time this day, I made every effort and tried every dodge to get a reliable sight, all to no avail.

By noon, to my great relief, both sun and horizon had cleared and a good sight for latitude was obtained. But longitude was now our greatest concern, for we were anxious to check our course since having run through the Gulf stream at noon and found our gasoline supply still holding up beyond our expectations, we had speeded up to 390 revolutions on all three engines. We were now making good $12\frac{1}{2}$

knots an hour, and, with only 160 miles to go, it was certain we would make our landfall about midnight. Of course, it was imperative that we should waste no time at Asbury Park, Ambrose Channel was our goal.

Our last afternoon was delightful and our rough days were quickly forgotten as the breeze which had been falling all morning gradually died and the sun coming out in earnest dried off our spray soaked decks. As we slid along over an easy swell with clear bright weather, navigation was easy. By 5.00 P. M. both Loomis and I had positions we were as sure of as though we had passed a light. The fact that they differed by three miles did not affect our confidence a whit. Laying a course from a point midway between them we set our course for Scotland Light vessel and at 7.00 o'clock with 60 miles to go to Ambrose Channel we figured we should raise Navesink at 11.30.

About this time I turned in and Mr. Loomis took the deck with a bank of fog looming up just ahead. He had his troubles that watch. The fog shut down like a blanket and it was darker than the inside of the proverbial Black Cow. It is the absolute truth that, anxious as we were to make speed, we slowed down (a little). The fog did not last long; but it was followed by a stiff breeze from the northeast and when I came on deck at 11.15 it was cold and the spray was flying.

Anxious as usual, Mr. Loomis was in the crow's nest as he had spotted a flare that might be a light.

He was "right as rain" for at 11.30 we had identified the powerful flash of Navesink Highlands Light and shortly afterward we got enough of a bearing on it (our heavy rolling made accuracy an impossibility) to change course for Ambrose Light Vessel.

We sighted Ambrose at exactly midnight and at 1:17 with engines stopped we rolled alongside of her hailing and finally sounding our call letters to rouse the watch aboard. There was no umpire on board and to our request to report us she replied that her radio was out of commission. As ours had been out for several hours there was nothing for us to do but proceed and very glad we were to do it. It was lively then and the glow of the white lights looked good to all hands.

While we felt sure that we were ahead, still every moment was precious till we had crossed that final finish line. At 1.25, with no

signs of other chasers approaching, we got under way again and headed up the channel.

We had made the run from the start to Ambrose Channel Light vessel in 56 hours and 56 minutes, in all kinds of weather, and were satisfied that we had done our best.

The trip up the channel was a lively one. The breeze was right astern, and as we raced down the backs of the short, choppy seas steering was almost impossible. My Chief Boatswain's Mate, who had stood perfect wheel watches throughout the trip, gave vent to some "choice ones" as, even after we were well up the line of buoys, we persisted in heading first for the white lights and then for the red. That he kept her between them is to his credit.

With a strong flood tide helping us we certainly made knots up through the narrows and as I had never entered New York Harbor from the sea before, Mr. Loomis, who was watching the chart, was kept jumping answering questions and laying courses to the "next one." The right answers came every time, however, and just as we crossed the finish line we saw the shadowy form of Liberty veiled in mist; but always ready with her welcome to the men from overseas.

Considering the hour, we crossed the official finish line at 2.53 A. M. 75th Meridian standard time, our reception committee if there was one, were readily excused for their absence, and we stole up through the fog to the Navy Yard where we tied up just as if we hadn't been gone sixteen months.



Harry Richardson's conception of a Chaser in a heavy sea.

CHAPTER XI

THOSE WHO PATROLLED OUR COAST

BUT how about the crowd who stayed at home and patrolled our coasts? Few people have realized why the Germans, who had already demonstrated the ability of their submarines to cross the Atlantic, gave us so little trouble on this side. The answer is the "hundred-and-tens," the boats of the "Sectional Patrol" and a few elderly destroyers, that made up the great bulk of the vessels patrolling our coasts. Why, at the time that the "San Diego" was lost off Fire Island, the Submarine Chasers under the command of Lieutenant LeSavage, Section Base No. 6, were out as much as twenty-eight days out of thirty. For the most part they kept their stations and listened—listened for days on end—and this is the most tedious task that a sailorman was ever called upon to do. Cruising in a rough sea on a boat of this kind is strenuous, but rolling about interminably with power shut off is maddening.

And then there was the fearful sickness, in spite of which they carried on, and the ever present danger of being potted for a sub. A glance at one of the vessels at a distance will show the marked similarity in appearance to a German U-boat, and at night with all lights out and with the gun crews of every freighter on edge and eager to let fly at the first suspicious object, there is little wonder that such accidents occurred. There was, for instance, the regrettable case of "S. C. 209," which was shelled and sunk by the Freighter *Felix Taussig* off Fire Island, when Lieut. Henry J. Bowes, Ensign E. H. Randolph and fourteen enlisted men lost their lives.

In the face of the ever-present menace of the submarine and his actual presence on this side of the Atlantic during most of the summer of 1918, it was necessary to keep the sea lanes open for the steady stream of troop and supply ships going to France and to protect the coastwise shipping as well. To be sure some fifty vessels were actually sunk in our waters but the fact that the losses were not infinitely greater was due to the tireless efforts of our patrol boats.

The first of the chasers to be finished were hurried across the



Drawn by Harry Richardson.

The midnight challenge—a Sub Chaser cross examines a camouflaged merchantman.

Atlantic to points where the need for them was the greatest so that when the first Fritz appeared on this side, about May 25th, the Chaser fleet here was just going into commission and many of the boats did not have their batteries, depth charges or listening devices aboard. These had to be fitted hurriedly as the boats could be spared from the arduous and varied duties they were called upon hurriedly to perform. Troop and merchant convoys had to be escorted hundreds of miles to sea, the coastwise shipping lanes had to be kept well patrolled, besides the never-ending hunt for mines, disabled seaplanes and the crews of torpedoed vessels.

No greater test of the ability of the officers and men could have been devised, than this coastwise work in a submarine zone where shipping was congested and where no lights were permitted. The officers for the most part had just been graduated from officer material schools at the various training camps, where they had received from three to four months' training *ashore* and most of them never had had sea experience until, upon graduation, they were shoved aboard the chasers, where seamanship is infinitely more important



Photograph by Underwood & Underwood.

In a heavy sea or in thick weather, the Chasers frequently were mistaken for hostile subs.

than on the larger vessels. There was no experienced officer above to direct and those below were as green as their officers.

The tours of duty of these little boats frequently were from five to six days with but brief intervals of rest between jobs. With but two officers, it meant watch and watch, four hours on and four off, twelve hours on duty out of twenty-four. And in rough weather there wasn't much rest below when off watch and the meals were only such as could be prepared by holding pots on the stove as the boats rolled their beam ends under. In one squadron of twenty-odd Chasers the records show that for two months the boats averaged 75 per cent. of the time on duty, which meant that to maintain this high average, some of them were out as much as 85 per cent. of the time. The strain on the crews and on the boats themselves was tremendous.

The squadron that made this brilliant record was based at Hampton Roads and was in command of Lieut. Herbert L. Stone, U. S. N. R. F., from Feb. 1 to Nov. 20, 1918. Lieut. Stone, who was subsequently the navigating officer of the troop transport "Pastores" and later occupied the same position on the U. S. S. "Montgomery," is known

to the yachtsmen of the country as the former editor of *Yachting* and one of our best amateur stick handlers. His work in the Naval Reserve was so excellent that he has been recommended for the Distinguished Service Cross, a reward he thoroughly deserves.

We are indebted to Herb Stone for many an interesting story of the Chasers. Here is one:

About the first real information that was had that the U-boats had arrived was when three battleships, among them the "Louisiana" and "Ohio," at target practise off the Virginia coast, made contact with a Fritz and after firing at the spot where he disappeared, put on full speed for port, zigzagging as they came and carrying a bow wave up to the stem head, it being the policy of the department not to risk first line ships against subs. As they flew by the guard ship off the Virginia Capes they semaphored "In contact with enemy Submarine 25 miles to the southeast. Send chasers to investigate."

So a couple of little 110-footers were chased off shore with their three Standards turning up 425 revolutions, where they spent the day and night scouring the sea for the elusive sub, with their crews up on their toes in anticipation. But what they would have done to Fritz if they had come across him, it is hard to say, for at that time neither of the boats had guns, depth bombs or any offensive equipment. But this didn't bother their crews a bit for they figured that the sub wouldn't know of these minor deficiencies.

If the records of the Navy Department are ever published they will show that on at least two occasions the Sub-Chasers actually made contact with and attacked enemy submarines on this coast. According to Lieut. Stone, it came about in this way: A destroyer, in command of a squadron of Chasers was out hunting submarines off the coast between Hatteras and Cape Cod along the edge of the 100 fathom curve, where the German commanders usually lurked. Steaming in line of columns, the leading Chasers suddenly saw a German sub broach right in the face of the squadron. As soon as Fritz saw what he had run into he dived and headed inshore, away from the squadron. In an instant listening tubes were down and the hunt was on.

For an hour and a half the chase lasted, the little boats using the latest listening devices and the tactics in which they had been drilled at New London. At the end of that time the listeners told them they



What might have happened to that sky line had it not been for the watch dogs?

were within striking distance and they attacked, dropping 17 "ash cans" over the spot where Fritz had been located. This attack evidently shook the Germans up a bit from the amount of oil that came to the surface, but it did not put the sub out of business. At any rate he changed his intent doubling on his tracks and heading northeast for deeper water.

Once more tubes were down, but the chase was not so long this time. In less than an hour the attacking squadron was over the sub and once more attacked with the deadly T. N. T. This time there was every reason to believe that Fritz was badly, if not mortally, hurt, for he went to the bottom in about 25 fathoms of water and for an hour lay there working his pumps while great quantities of fuel oil kept coming to the surface and spread over the sea for half a mile. After bombs had been dropped freely the sounds of pumping finally ceased and no more was heard from the bottom.

Believing that the sub was done for, the spot was buoyed and the flotilla lay-to until the next day, sending a radio in for a diver and mine sweeper to come out and locate what was left of him. But the water was too deep to allow of adequate examination by a diver and



Warren Sheppard's conception of a Chaser in a heavy sea is not far from the truth.

the sweepers failed to pick up anything from the submarine. This may have been due to the fact that only the center of the bight of sweep dragged the bottom and the sub could easily have been missed.

This was in August. A little later a submarine was picked up well off Barnegat, where she had been worrying shipping. She was chased in the same way and attacked with depth bombs when spotted, but there is no evidence to show that she was destroyed. In this case darkness added to the difficulties of the chase.

The unfortunate affair southeast of Fire Island Lightship in which Sub-Chaser No. 209 was shelled one night by an American steamer which mistook her for a submarine, occurred a short time before the incidents just noted. The fourth shell fired at point blank range from the 5 in. gun of the "Felix Taussig" hit the "209" fairly amidships and blew her to splinters. Sixteen of her crew were killed or died of wounds and the survivors, some seven or eight, were picked up by Sub-Chaser "188." The water was a sea of flame from burning gasoline and the rescues called for genuine heroism which the Department should not let go unrewarded.

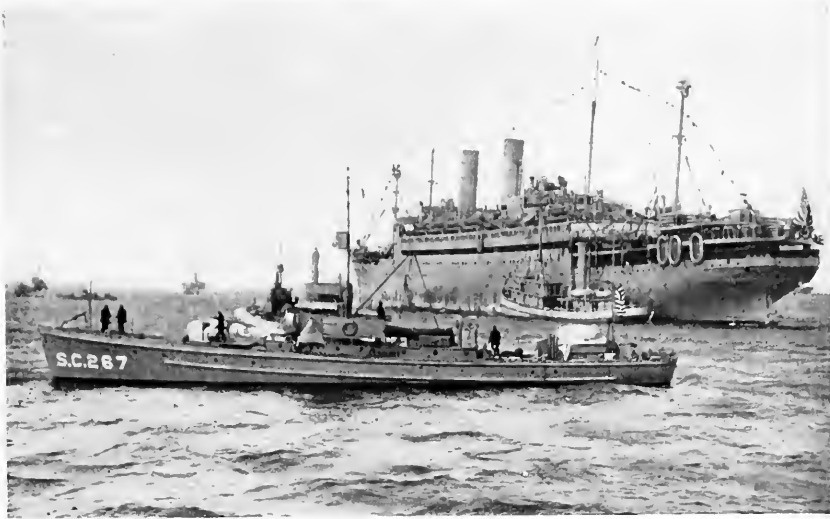

Photograph by International Film Service.

The President leaves for France aboard the George Washington; a Chaser superintends the ceremony.

Three of the Chasers in this squadron were built on Puget Sound and made the long 8,000-mile cruise to the Atlantic coast on their own bottoms and with no mechanics except Navy enlisted personnel on board. At the conclusion of the long trip the boats reported to the commander of the squadron on the Atlantic coast as "ready for duty" and inside of 24 hours they were ordered to sea as escort for a fast troop convoy, without any time for overhaul or repairs.

The Chasers were part of a squadron of 12 which came from the west coast, through the canal and up to north Atlantic ports without any repair or mother ship, tug or supply vessel accompanying them for most of the voyage. They had no paymaster or funds of any kind except what personal money the officers might have had and yet they kept going, with the aid of one fuel tanker sent ahead to a Mexican port on the west coast, and arrived still a lap ahead of their pay accounts.

Lieut. Stone tells the following story of the squadron:

The boats had dropped into Charleston, S. C., on the way north, for supplies, and the ensign commanding the group went to the com-

mandant of the yard to try to get some back pay. The latter official said somewhat testily, "Don't bother me about this, go to your paymaster."

"But we have no paymaster, sir," replied the ensign.

"I know you have none on your ship, but go to the paymaster of your mother ship or escorting vessel," said the commandant.

"But there is no mother ship or escorting vessel," persisted the ensign, who was pretty hard up.

"Then go to your supply ship, they'll take care of you."

"We have no supply ship, sir, to go to," was the answer.

"How many Chasers are in your squadron, and did you have a medical officer along?" asked the commandant, beginning to get interested.

"Twelve, sir, and we've seen no medical officer since we left Puget Sound, except at Panama."

"Now, let me get this straight"—went on the head of the navy yard, beginning to get interested. "You say that these twelve little boats came all the way from the west coast without funds?"

"Yes, sir."

"Without an escort, or supply ship or tug or repair ship of any kind?"

"Yes, sir."

"And without a medical officer?" went on the commandant.

"Yes, sir."

"Well, my God, all I've got to say is that this trip has got the voyage of the 'Oregon' beaten to a frazzle."

CHAPTER XII

THE GERMAN SUBMARINE

SINCE the German fleet was taken over by the British Admiralty some interesting things have been learned about the U-boats—things many of which unfortunately are not available for publication. We know now that the type of craft which had proved successful at the outbreak of the war, a boat of about 900 tons displacement and equipped with twin Diesels of 1000 horsepower each, was standardized and used throughout the war for high seas work. Other larger subs were built, but this class seems to have been the most important.

We are indebted to *Motor Ship and Motor Boat* of London for some interesting facts about German submarines. It appears that very early in the war the German Admiralty concluded that a number of small coastal submarines were needed on the Belgian coast and because of the fact that the North Sea was in control of the British it was necessary that these be so constructed that they could be transported by rail to the Belgian bases. Seventeen craft were ordered and were ready for delivery in May, 1915, the average time of construction being four months. They were of the "U. B. 1" type, with a length of 92 feet, 10 feet 3 inches beam and 127 tons displacement. A single Diesel of but 60 horsepower gave a surface speed of $6\frac{1}{2}$ knots and a 120-horsepower electric motor drove them $5\frac{1}{2}$ knots submerged.

These boats proved too small, too slow and too unreliable even for the work for which they were intended and in the spring of 1917 a new class known as the "U. B. 2" type was started. These boats were 118 feet in length, displaced 324 tons (surface) and were driven by a pair of 140 horsepower Diesel motors giving a surface speed of 9 knots. They had a cruising radius of 6500 sea miles. Thirty boats of this type were built, averaging six to ten months in production, and many of them were shipped in parts to Pola where they were erected for use in the Mediterranean.

Apparently these "U. B. 2" boats were found successful but they proved too limited in size and speed for work in such places as off the



Photograph by courtesy of Z. J. Crawford.

A Chaser takes charge of a couple of captured submarines. Note the size of the deck guns.

west coast of Ireland, and so still another class, known as the "U. B. 3" was undertaken. They were intended to be suitable for practically the same work as the very large sea-going type, except the longest passages, and their advantage over the big boats was that they were cheaper, quicker to build and a greater number could be constructed at the same time. In all 202 boats of this type were ordered, of which 89 were finished before the Armistice and the fact that the average time of construction was from 12 to 18 months would indicate that the difficulties of manufacture in Germany were just as great as we believed them to be.

The "U. B. 3" boats were 182 feet in length, of 516 tons surface displacement and were equipped with two Diesel motors of 550 horsepower each, which gave them a surface speed of $13\frac{1}{2}$ knots. Their 380 horsepower electric motors drove them at about $7\frac{1}{2}$ knots when submerged. They were capable of submerging to a depth of 245 feet and could reach a depth of 30 feet in 40 seconds.

The profile and plans of the "U. B. 3" type which are shown herewith give a good idea of these remarkably successful vessels. It will

be seen from the section that they were of the double hull type, the water tanks being external to the inner or pressure hull. They might be called submersibles rather than submarines, for the reason that their reserve buoyancy was 26.2 per cent, giving an under-water displacement of 730 tons. When traveling on the surface they stood well out and with their raking bow and conning-tower had much the same appearance as the submarine chasers, a fact that was a constant source of danger to the latter craft.

THERE'S MANY A SLIP

Terrible in its destructive power as a depth bomb proved, it was not always infallible even when dropped in the immediate vicinity of a submarine. The fact is that in spite of the preconceived idea of the submarine as a vulnerable fish, it actually could stand a terrible lot of punishment. Time and again it was proved that after a bombardment which had left a submarine supposedly *hors de combat* it either continued on its way rejoicing or else managed to limp into its home base, and for this reason the Admiralty and our own Staff repeatedly warned the patrol vessels to make absolutely sure of their work for nothing but positive proof of a sinking would be credited.

There has been much criticism of this strict policy but on the whole it was the only possible one. Several instances taken from one of Admiral Sims' letters to vessels operating in European waters will serve to show that even when a contact was established beyond doubt, there was many a slip 'twixt the sub and the ship. Here are some typical cases.

A "P" boat sighted the conning-tower of a submarine which immediately disappeared at about 500 yards distance. Ship was headed to pass just ahead of where submarine dived and telegraph put to full speed. Just before the position was reached three depth charges were dropped. When they had detonated a fourth was released. Immediately afterwards a broken periscope was observed by all on board, and course was headed to ram. When over the position, two hand depth charges were released and helm was put hard over. The submarine was then observed to break surface, evidently on her side, as no conning-tower was seen. Course was shaped to ram but the sub-



Photograph by courtesy of Licut. Bewick S. Casothorn, R.N.V.R.

One of the mysterious "Q boats." This apparently harmless schooner with what appears to be a deck load of lumber, is in reality a decoy with heavy guns which may be brought into play at an instant's notice. The commander of one of these vessels received the Victoria Cross for his brilliant work against German subs.

marine dived just before the spot was reached. Helm was again put hard over and the submarine again broke surface on her side and disappeared.

After the explosion of the first four depth charges several of the crew state they saw a grey object resembling the bow or stern of a submarine rise about 8 feet out of the water and immediately disappear.

"Submarine continued operating."

A destroyer sighted a submarine, conning-tower awash, in the act of submerging on starboard bow, bearing N. W. by W. distant 170 yards, steering approximately S. E. by S. and speed about 4 knots. Engines were put to full speed and ship steadied on submarine with the intention of ramming, but submarine was seen to be diving so rapidly that the destroyer decided to attack with depth charges. The first charge exploded when submarine was judged to be under the engine room, and three more dropped at short intervals, all set to 50 feet. The helm was then put hard astarboard and a large dark object re-

sembling one-half of the submarine was clearly visible to the N. of the smoke left by the explosion of the first two charges. This object was only visible for 30 seconds, and when seen was at an angle of 45° with sea level. When the smoke had cleared away thick oil and air bubbles were observed, and a buoy was dropped on position. Oil and air bubbles continued to rise at intervals for about 6 hours. The destroyer patrolled vicinity at slow speed for 3 hours, but nothing further was seen.

“Submarine continued operating.”

A submarine was sighted coming to surface bearing N. E., approximately 8 miles. A hydrophone flotilla chased and opened fire at extreme range firing 22 rounds, all of which fell short. The submarine dived. Flotilla proceeded to hunt with hydrophones and at 6.00 P. M. opened fire with stick bomb-throwers, bearing of submarine being ahead but not accurate enough for depth-charge bombardment. A total of 29 stick-bombs were fired by division. The supposed position of submarine was bombarded with depth charges, and large quantities of oil rose to surface. Division continued to hunt with hydrophone till morning of the following day, when submarine was sighted on surface about 10,000 yards distant. Ship opened fire and gave chase, gradually closing the range till submarine was distant 5,000 yards. Enemy had returned the fire and again opened rapid fire, but all shots went over. When one of the pursuing vessels had closed to 3,500 yards she claims to have scored at least five direct hits, and submarine appeared to be in serious difficulties. After the next two shots she appeared to turn over on her beam ends and sink.

The pursuer then proceeded at full speed to the spot where she had disappeared and dropped 5 depth charges. A little later Hydrophone Division arrived on the spot and listened, but could hear nothing.

“Submarine was not destroyed.”

There are many such cases on record and I have cited these typical ones merely to show that potting a sub was not the trivial thing that newspaper reports might lead one to believe. Every vessel that wears the gold star deserves her decoration.

With thousands of square miles of sea to patrol the chance of getting a contact with one of the few score submarines operating at any one time was not a great one, even with the best of equipment. Dur-

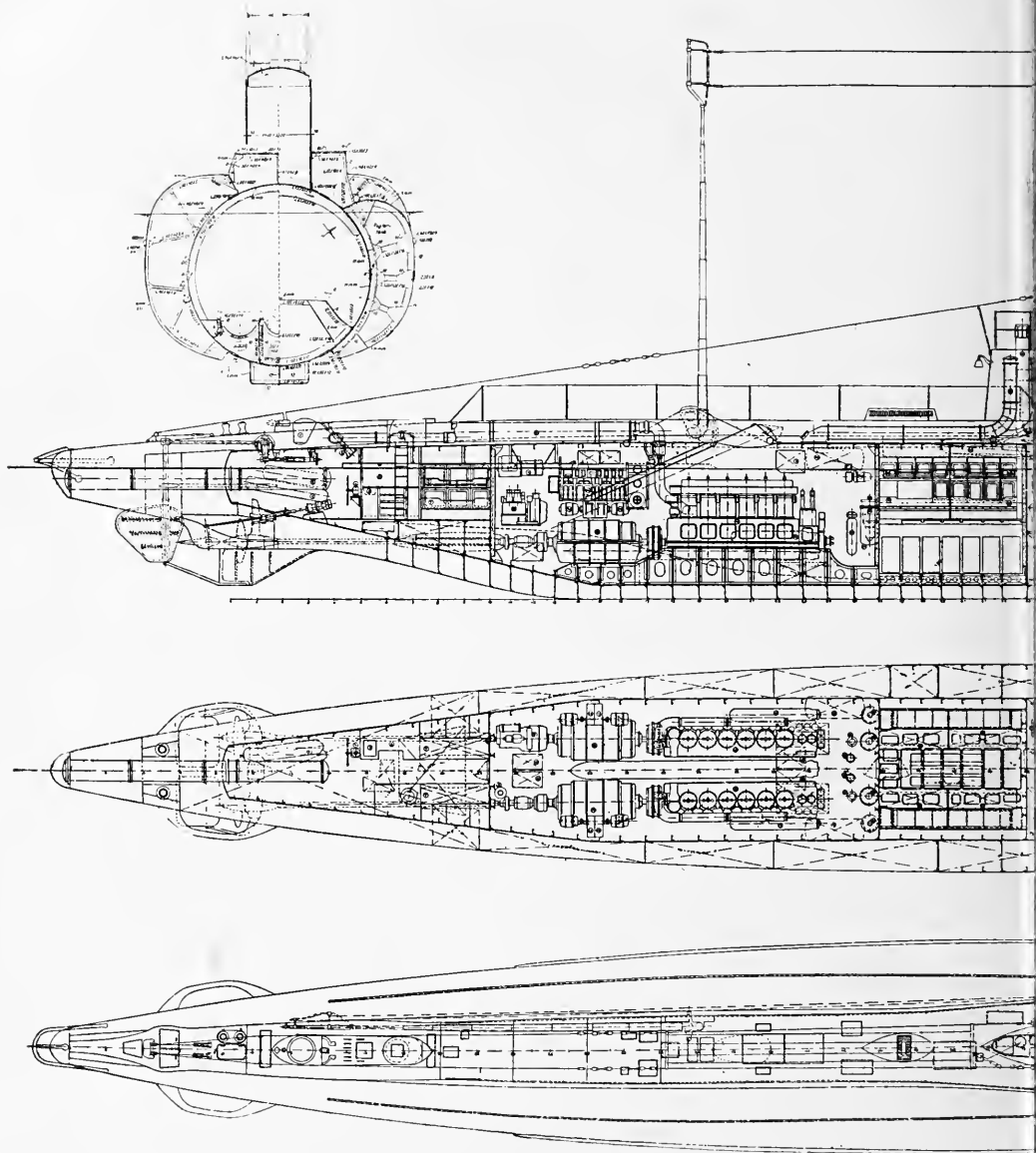

A German submarine of the U. B. 3 type.
The length of these vessels was 182 feet, their displacement on the surface 516 tons and they were
these boats were exc

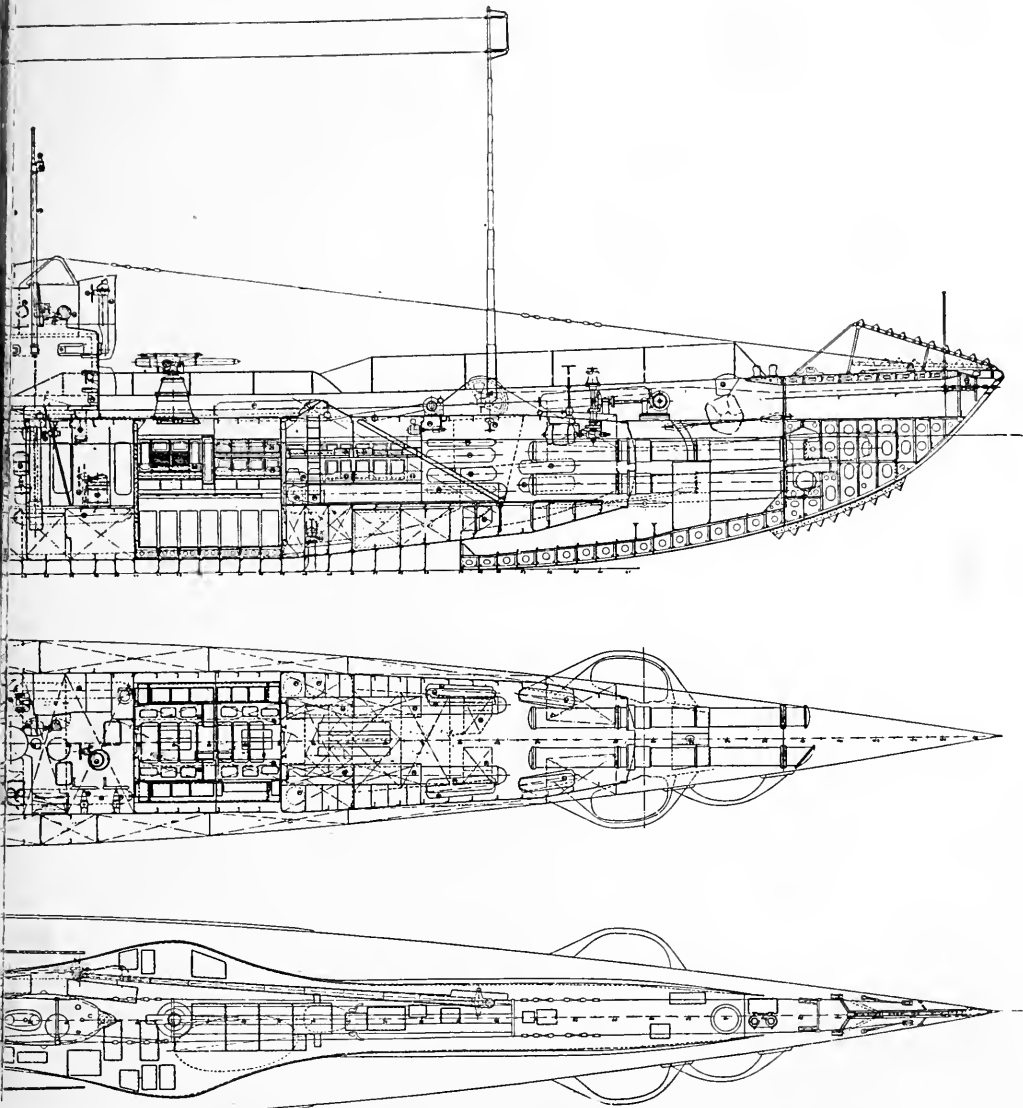

Reproduced from Motor Ship and Motor Boat.

propelled by twin Diesels of 550 h. p. each. In all 202 of this class were built. Although not large, they were very successful.

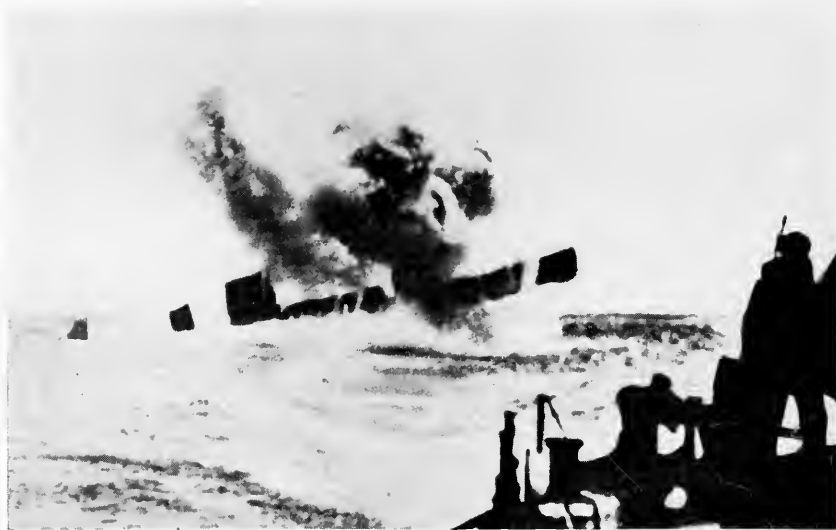

Photograph by Underwood & Underwood.

A kill—a remarkable photograph taken as the submarine was blown clear of the water by the explosion of a depth bomb.

ing the months of May, June and July, 1918, anti-submarine forces in European waters made but 78 attacks on what were supposed to be enemy subs. In 45 cases only, was there any evidence that a submarine was operating in the vicinity and in but one lonely case was there any conclusive proof of a kill. That case, by the way, was one of our Submarine Chasers operating in the Straits of Otranto.

CONCERNING SILENT RUNNING AND OTHER TRICKS

The fact that many a sub was able to continue his work after a bombardment with depth bombs that had left him supposedly dead, was due not only to the sturdy character of the construction of these boats but to many clever stunts not generally appreciated. For instance, in order to elude pursuing vessels equipped with hydrophones, it was of the utmost importance to be able to shut down all machinery and lie quietly until the danger had passed. To do this it would seem necessary to remain in water sufficiently shallow to allow the sub to lie on the bottom—say not deeper than twenty to thirty

fathoms—but this was not the case. Much as it seems at variance to the laws of hydraulics, submarines are able to balance, that is remain idly at a constant depth, without manipulation of the ballast tanks. We know that when a body sinks beneath the surface it keeps on sinking, due to the fact that water is practically incompressible and is supposed to weigh no more at the bottom than it does at the surface, but there may be some stratification due to aeration or difference of temperature which would help to explain the phenomenon.

Balancing or, when in shoal enough water, lying on the bottom was considered by the submarine commanders to be the best practice when in the neighborhood of patrol craft, unless there was some indication that the presence of the submarine was suspected. If the periscope had been sighted or sub had been heard on the hydrophones, the practice of the various commanders differed and was governed largely by circumstances. In this connection let's see what the survivors of several captured submarines say.

The captain of the "U. B. 52" stated that when attacked it was his policy to keep at periscope depth and allow the depth bombs to explode beneath him. He said that by running at 60 revolutions a minute on one motor (electric) only his boat could not be heard by the listeners. Survivors of the "U. B. 72" said that for "silent running" they used both motors at 100 revolutions.

Prisoners from the "U. 110" when questioned in regard to their practice in avoiding patrol craft, said that when surrounded by such boats, equipped with listening devices, they dived to a depth of from 60 to 100 feet and gave the order for "silent running." The port motor was run at a speed of 100 revolutions and the starboard at 80; the forward hydroplane was put in a central position and not moved again; the after hydroplane was left in power but only worked when necessary; the periscope was housed; the gyro compass was left running, but it was forbidden to use the pumps and toilets. After proceeding in this way for an hour, the boat rose to a depth of about 36 feet and an observation taken with the periscope. If the patrol was still in the neighborhood, she dived and repeated the operation.

It was learned from survivors of the "U. C. 55" that the listening devices with which the German submarines were equipped could detect sounds up to a distance of ten miles, but that they were reliable only

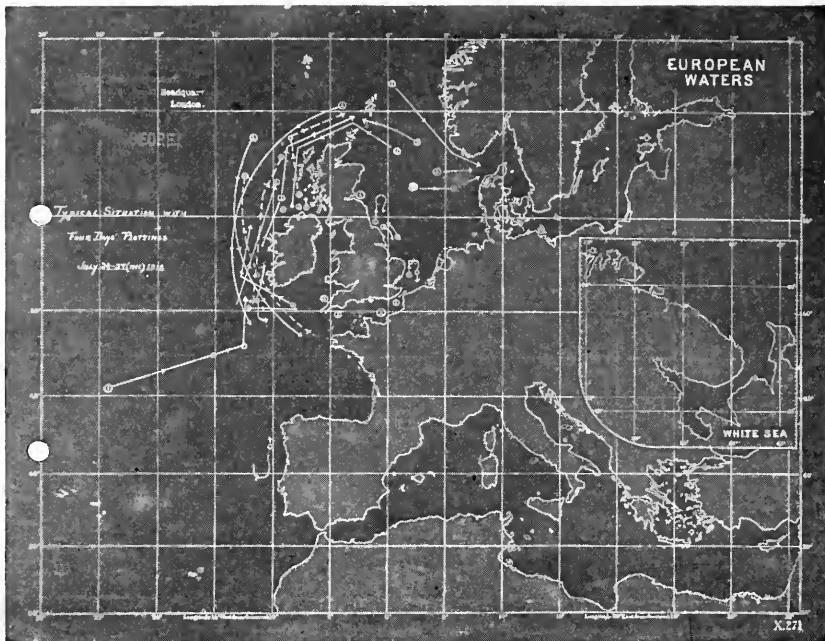

A reproduction of one of the charts issued daily to the chaser bases. The circles represent the position of the submarines as determined each night by cross radio bearings and the lines show their courses.

for distances up to three miles. It was comparatively easy, they said, to distinguish as many as three vessels at one time as each produced a different note, but that if there were more than three vessels, the sound became blurred and unreliable. When pursued by patrol boats with hydrophones, it was the practice of the "U. C. 55" to steer a zig-zag course, stopping occasionally to listen in.

RADIO DIRECTION FINDER

An invention which did a great deal toward getting the upper hand of the submarine during the later months of the war, but which, I believe, has not yet become generally known, is the radio direction finder. This device, which is now a part of the regular equipment of our destroyers and was used on the trans-Atlantic fliers, was employed by the British for spotting the subs operating in the vicinity of



Another chart showing the areas in which submarines were known to be operating, and the number of submarines in each area.

the British Isles. It is an attachment used with the radio receiving apparatus by which the exact bearing of the source of the wireless waves may be determined.

Now the German submarine, in truly methodical German fashion, was wont to come to the surface every night and shoot his report over to Wilhelmshaven by wireless, so that the Herr officers at the German Admiralty might move little colored pins from place to place over a chart neatly checkered with tiny numbered squares. Such communication, of course, was in code, but the call letters of each boat remained the same, and, thanks to the Intelligence Service, these numbers were known for practically every sub.

These messages were picked up by the wireless stations along the British coast, but until the last year or so of the war it was impossible to tell from what direction they came. Then the directional apparatus was perfected, and by getting simultaneous bearings from several dif-

ferent stations, the submarine was spotted at the intersection of these bearings just as accurately as with the directional hydrophones previously described, and after several positions had been obtained for the same sub, night after night, it was fairly easy to anticipate her destination.

Every night the positions thus obtained were plotted and every morning these charts, reproductions of which are shown herewith, were distributed to the Chasers and the M. L.'s at the British bases at Plymouth and Queenstown, and with the aid of these charts the hunt could be conducted with a much greater chance of success.

While going to press, Admiral Sims, in his admirable series of articles appearing in "World's Work," pays a glowing tribute to the submarine chasers. He says that the chasers furnished the eyes to a navy which was blind to the submarine before their advent, and that as an offensive weapon against the submarine the submarine chasers proved themselves invaluable.

CHAPTER XIII

THE MOTOR AND ITS MAKERS

SOMEONE has said that the World War was a war of the motor and when we remember the parts played by the aeroplane, the tank, the motor truck, the submarine and the motor boat, we must agree that there is more than an element of truth in the statement. We are concerned here only with the motor boat and in the foregoing pages we have gained some idea of the work performed by the Submarine Chasers and the M. L.'s, without which it is doubtful whether the submarine could have been overcome. There were other types of motor boats, to be sure—but these were a mere handful when compared to the hundreds of Chasers and M. L.'s. Now that we know something of these boats and what they did, let us turn our attention to the engine with which this vast mosquito fleet was powered, and the organization that produced it.

The Standard Motor Construction Company was organized in 1900, taking over at that time the manufacture of the Standard Marine Engine, which for many years had been built by the late Carl C. Riotte, its inventor and designer. Those familiar with internal combustion engine patent office records know how often the name of this pioneer appears in connection with the fundamental steps in the development of the marine engine. Many of Mr. Riotte's ideas have attained a success far greater than he could have dreamed. When in 1902 he worked out the first six-cylinder, balanced, direct-reversing engine, little did he know that his handiwork was destined to play so large a part in the greatest war of all time.

This engine did away entirely with the reverse gear, coupled as it was directly to the propeller shaft, and with its perfect balance, it permitted the quickest possible action. It was the first six-cylinder unit and the excellence of the type, in which Mr. Riotte had such faith back in the days when many of his ideas were considered

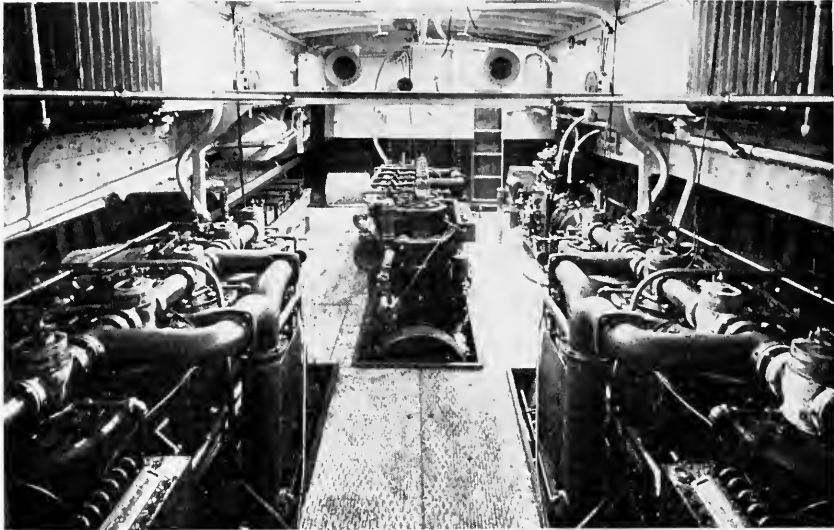

Engine room of a sub-chaser showing the three Standard propelling engines and the Standard auxiliary set.

radical, has since been endorsed by the automobile, the aeroplane and the Diesel ship.

It was the air starting and reversing feature of the Standard engine which, more than any other thing, made for the success of the Chasers. The manipulation of a small hand lever was sufficient to start the huge motors in either direction. To reverse the direction of rotation the cams were shifted by means of another small lever and the air applied just as in starting previously, although this was seldom necessary because of the fact that in almost every case the motors reverse on the spark alone.

And then there was the vacuum-controlled vaporizer which was designed to regulate automatically the mixture of gasoline and air at all engine speeds by means of a shutter which swings over the sprayer nozzles, uncovering just the right number for any given condition of running. The external circulating water system, the make-and-break ignition, the easy accessibility of the parts and their sturdy design also were points to which may be attributed the success of the engines in the hands of boys, many of whom, it



Part of the erecting floor at the Standard shops.

may truthfully be said, hadn't even a speaking acquaintance with a flivver before the war.

The pioneer work of this able mind brought a wonderful success and reputation to the Standard organization, although at a great expense and consequent sacrifice of profit. In the long run, however, it was found that industrially and economically the Company had built on a sound basis. The factories in Jersey City, New Jersey, gradually were built up to be the largest in the marine gasoline engine industry by as efficient, loyal and capable men as ever were brought together—men who believed fully in the product and its ultimate success, men loyal not only in the office and draughting room but right down the line to the least skilled mechanic, and all proud to be known as members of the organization, and conscious of its prestige.

Backed with this product and this spirit, the company carried on through the years of general depression prior to the war, with an ever increasing following. A limited amount of naval work had been accomplished during the Russo-Japanese War, and some

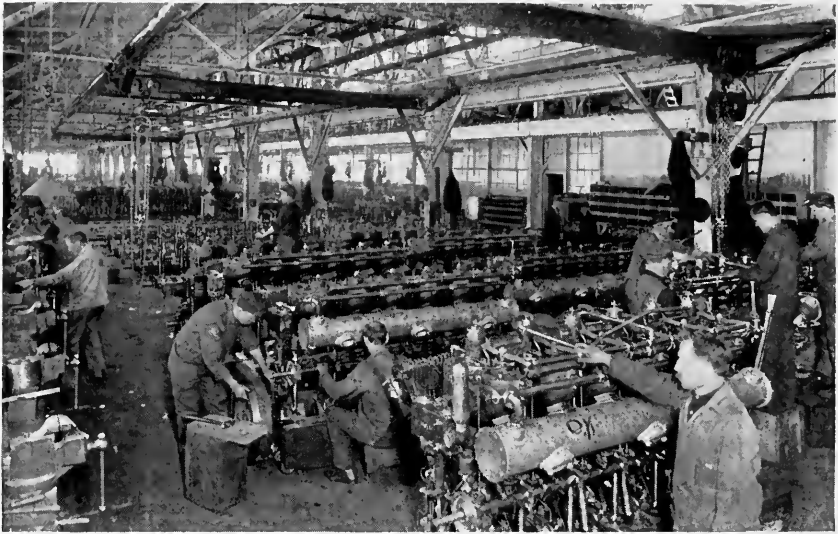

Assembling Chaser engines at the Standard Shops.

scout patrol boats had been equipped with Standard engines prior to the World War, but these were mere incidents to a normal production such as existed up to the early part of 1915.

Then came the epoch-making contract for Standard engines for the British M. L.'s, making it necessary for the company to enlarge its plant and expand its organization to the very limit. Working two shifts of eleven hours each, nine hours straight time and two hours overtime at "time and a half", the spirit of cooperation and the desire to beat the Hun were in every man.

Noon-day meetings were held in the factory, and through their shop association the men were brought to appreciate the importance of the work they were doing. There was no limit on production. Every effort was made on every man's part to earn and produce to the utmost. In the manufacturing, every piece was covered by a bonus or piece work system.

The company pursued the intelligent method of having many parts manufactured by a number of outside firms who were idle at that time. Those parts were built not only to sample but to drawings and specifications; and jigs, gauges, etc., were furnished.



Jacket water being cooled for engines aggregating over 4000 H. P. running on the testing stand continuously day and night.

This gave the absolute interchangeability of parts which, in later months, was so warmly appreciated by the Allied Navies.

At the time of our entrance into the war, the officials of the Standard Motor Construction Company were sent for by the Secretary of the Navy and were informed that the company's cooperation in checking the submarine menace was desired. The record already made by the Standard Engine in European waters was known to the Department, and the Standard Company was called upon to furnish propelling machinery for every Submarine Chaser that could be built by the combined boat builders of the country. The company met this rate of production and furthermore, met the requirements of the Navy at a far lower cost per horsepower than was expected by the government officials.

The Standard Motor Construction Company completed its contract with the Navy Department within twelve months and immediately was commissioned to execute another order for fifty boats as well as more repeat orders from the British, French and Italian Governments. Although the Italian and French Govern-

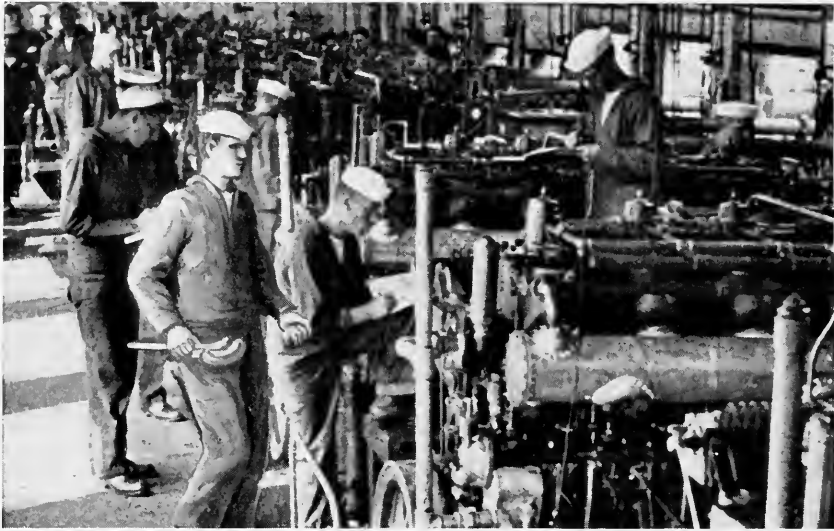

Every engine when completed underwent a test for fuel economy and horse power of 3 hours. One set of propelling machinery in every 20 underwent a 24 hour non stop test. This insured a Standard of efficiency, without delaying the work.

ments eventually commenced building their own hulls, they continued to purchase Standard engines. The result was some 750,000 horsepower in gasoline motors contributed to the navies of the world, consisting of three thousand main engines identical in design and one thousand two hundred auxiliary sets. Due to the absolute interchangeability this meant that spare parts could be stocked at all the different bases, easily accessible to any of the thirteen hundred boats in any one of the Allied Navies.

A thing which contributed largely to the successful operation of the motors day in and day out was the system of supplying spare parts, not only to the boats themselves but to the bases or mother ships from which the Chasers operated. With each engine that left the shop there was included a set of spare parts, which was sufficient to enable a boat to carry on independently and eliminate the delays incident to the inevitable governmental red tape. The engine room crew were thus able to make minor repairs instead of running an engine with a part that needed attention while waiting for an

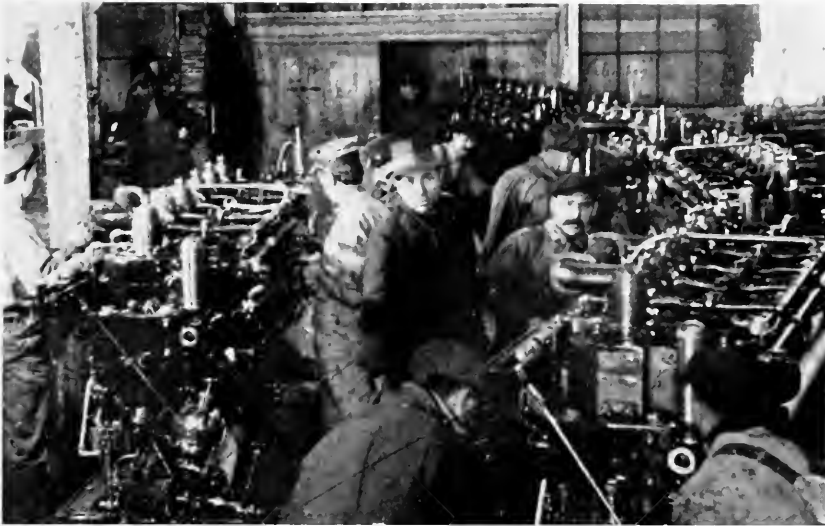

The finished Standard Engines were moved into the shipping department in a continuous line.

official requisition to be passed from department to department in wearying progression. The system enabled new crews to remedy their own mistakes until such time as they had gained sufficient experience to make frequent replacements unnecessary.

For each thirty engines "ten boat spares" were sent to the bases and mother ships including larger parts that might be broken through serious accident, such as collision or shell fire.

But what were the conditions in the factory during the accomplishment of all this work of production and supply? Many people have asked: "How could you turn out this tremendous horsepower without having strikes, delays, accidents, etc., such as interfered so much with other work?"

To all this the Company has answered, "the loyalty of our men."

Although the organization increased from three hundred to twelve hundred men the spirit and tradition of the shop, its system of production, etc., were rapidly absorbed by the newcomers. The internal organization of the shop employes gave ample opportunity



CARL C. RIOTTE

for fair adjustment and fair dealing which ensured a continuance of friendly relations, and consequently, a pride in the work.

This spirit of loyalty, furthermore, acted far better than any espionage system that could have been devised, in preventing any activity on the part of German incendiaries or obstructionists. The destruction due to German sympathizers experienced in other plants was all but nil.

The work was so organized that the new men were absorbed as specialists under the supervision of older men as instructors and leaders. The work passed through in such large quantities that one man made one part continuously according to the balance of production. This was true not only in the manufacture of parts but in the systematizing of all the work even to assembling the engines on the floor, moving the engines to the test house, testing the engines, delivering to the shipping room, inspecting and shipment.

An idea of what was accomplished by this thorough systematization may be gleaned from the fact that forty tons of propelling machinery were shipped every day and that an excess of forty tons

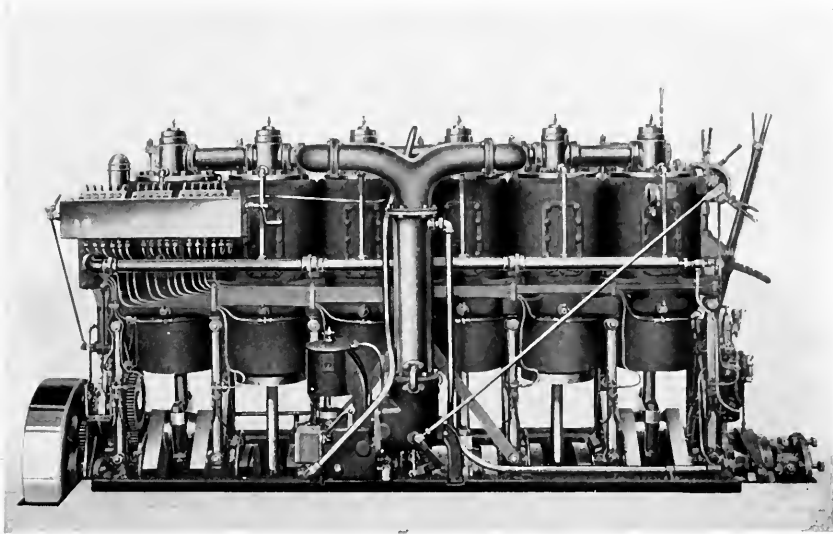

The 220 H. P. air starting and air reversing Standard Engine.

in raw materials and finished parts were brought into the factory every day.

Of course this required a large corps of shipping and receiving men who were in two separate departments. The main receiving room was on a side track at one end of the factory and the shipping room on a side track at the other end, while at both ends large motor trucks were continually busy carting materials in and finished motors away from the factory.

When production reached its maximum, there were 18 complete sets of submarine chaser machinery built, shipped, installed and tested in one week. This meant 54 main propelling engines, 18 auxiliary engines, 54 propeller shafts and all piping and fittings complete.

The yards where the work of installation was done were situated along the Atlantic and Pacific coasts as well as on the shores of the Great Lakes and the Gulf of Mexico. By systematizing the work so that one group of men installed the motors, another the propellers and shafts, another the piping, and so on, this work, including the trials, was cut down to one week, and telegrams announcing successful trials began to come in at the rate of three and four a day.

But it would have been impossible to have attained this maximum production without the cooperation of the Bureau of Steam Engineering. Great credit is due Admiral Griffin and his able aid in charge of sub chaser machinery, Commander Joseph C. Fisher. Knowing definitely what they wanted, these men decided promptly the innumerable queries that poured in from the builders, with the result that the traditional delays in completing Government contracts, did not materialize.

And then, too, the intelligent inspection by Rear Admiral Little and his assistants, for both our own and the French Government, greatly facilitated the work, as did that of Engineer Commander Nibbs for the British and Major Galileo for the Italian Government.

Glorious as was the accomplishment of this tremendous task, the satisfaction of a job well done was enhanced by the recognition it drew forth from the governments involved. In addition to the testimony of the British, French and Italian officers, was the practical commendation of their governments in reordering Standard engines right up to the end of the war and even taking delivery in full of everything that was in the course of construction at the time—a striking proof of their appreciation.

The commendation of the Secretary of our own Navy, the Hon. Josephus Daniels, on opposite page, was a fitting climax and a most gratifying ending and rounding out of a war work in keeping with the tradition and success of the Standard organization.



"Victory," a super-sub chaser designed by Irwin Chase, built by the Elco Works and powered with twin Standards of 500 H. P. each.

IN REPLY ADDRESS
THE SECRETARY OF THE NAVY
AND REFER TO NO.

NAVY DEPARTMENT

WASHINGTON

October 22, 1918.

Dear Sir:

The Department desires to express its appreciation of the excellent showing made by your Company on the delivery of the fifty sets of propelling machinery for the 110 ft. submarine chasers recently delivered to the French Government. The records show that the last of these boats completed trials within eighteen days of the contract date of delivery of the boats.

Another undertaking which should be of special interest to you and your employees is the excellent showing made by submarine chasers in the recent Allied raid on the Austrian Naval Base at Durazzo, of which you have undoubtedly seen press reports. Please express to your organization the thanks of the Navy Department for the splendid spirit of co-operation which has made such results possible.

Very truly yours,

Jeppan Daniel

Secretary of the Navy.

Mr. Eugene A. Riotta, President,
Standard Motor Construction Co.,
Jersey City, N. J.

THE M. L.'s IN TABULAR FORM

(Number Built for Allied Nations, 720)

DIMENSIONS

Length over all	79 ft. 7 in.
Length on the water line.....	78 ft. 9 in.
Extreme beam over guards	12 ft. 5 in.
Beam on deck	12 ft. 1 in.
Draught to bottom of deadwood	3 ft. 1 in.
Full load displacement	78,000 lb.

CONSTRUCTION

- Planking; yellow pine, $1\frac{1}{8}$ in. thick.
- Frames; white oak, steam bent, $1\frac{3}{4}$ in. sided by $1\frac{3}{4}$ in. molded, spaced 12 in. center to center. Heavy frames at bulkheads, $2\frac{1}{4}$ in. by $2\frac{1}{4}$ in.
- Deck planking; Oregon pine in strips, $2\frac{5}{8}$ in. wide by $1\frac{1}{8}$ in. thick.
- Deck beams; white oak, sided $1\frac{3}{4}$ in., molded $2\frac{1}{2}$ in.
- Keel; white oak, sided 4 in.
- Keelson; yellow pine, 4 in. by 5 in.
- Floors; galvanized wrought iron, $1\frac{1}{2}$ in. wide, $\frac{3}{4}$ in. thick at center, tapered to $\frac{3}{8}$ in. at ends.
- Knees connecting frames to beams; wrought, 3 in. by $\frac{3}{8}$ in.
- Upper clamp; yellow pine, $1\frac{3}{4}$ in. by $4\frac{1}{2}$ in.
- Main clamp; yellow pine, $1\frac{1}{2}$ by $4\frac{1}{2}$ in.
- Main clamp; yellow pine, $1\frac{1}{2}$ by $5\frac{1}{2}$ in.
- Hogging clamp; yellow pine, $1\frac{1}{2}$ in. by $5\frac{1}{2}$ in.
- Side keelson; yellow pine, $1\frac{3}{4}$ in. by $6\frac{1}{2}$ in.
- Bilge stringer; yellow pine, $1\frac{1}{2}$ in. by $4\frac{1}{2}$ in.
- Bulkheads; six steel, about $\frac{1}{8}$ in. thick, located at frames Nos. 6, 26, 40, 47, 52 and 71. The bulkheads at the ends of the gasoline compartment were made gasoline tight by the use of a special paint composed of litharge, glycerine and shellac.

(Continued on page 172)

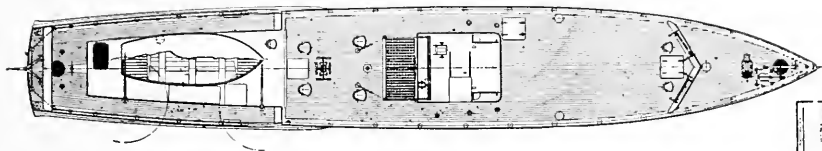
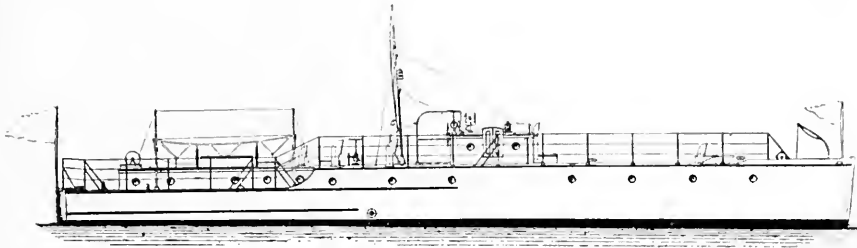

DECK PLAN



PLAN VIEW OF
CHART HOUSE

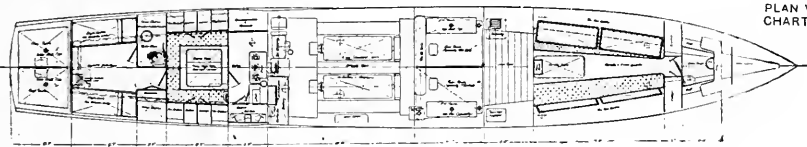

INTERIOR ARRANGEMENT

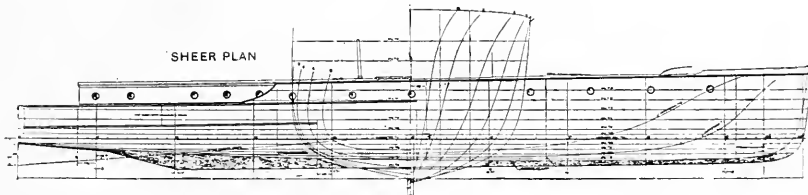

SHEER PLAN

BODY PLAN

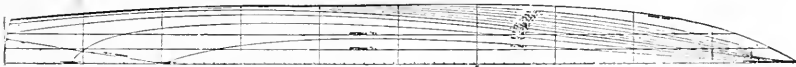

HALF-BREADTH PLAN

The design of the British M. L.'s.

It will be noticed from the outboard profile and arrangement plans that the difference in appearance between one of these boats and a modern express cruiser of about the same size and power is slight, except for the long fore deck of the M. L., which is kept clear of all obstructions to give a wide angle of fire to the short-caliber 13-pounder mounted just forward of the low chart house, over the midship fuel tanks. The reader may have noticed that it was found necessary later to build up a permanent shelter for the helmsman just aft of the trunk.

In form these boats are nothing more than big runabouts. In fact, if the scale were changed to give a length of 35 ft., they would have not only the proper proportions but about the correct displacement for a high-speed runabout of that size.

MACHINERY

The power plant consists of a twin screw installation of two 6-cylinder, 4-cycle air-starting and reversing motors having cylinders 10 in. bore by 11 in. stroke, built by the Standard Motor Construction Co., of Jersey City, N. J. These motors, which are rated by the builder at 220 hp. at 400 r.p.m., are directly connected to the three-bladed propellers, 42-in. diameter by 63-in. pitch.

An auxiliary set, also made by the Standard Motor Construction Co., includes an air compressor, a $4\frac{1}{2}$ -kw. generator and a bilge and fire pump. The total capacity of the tanks is 2100 gal., giving a radius of action of 750 nautical miles at 19 knots and 1000 nautical miles at 15 knots.

The maximum speed obtained on trial varied on the different boats from about $19\frac{1}{4}$ knots to almost 21 knots.

The 720 M. L.'s were built for the allied nations by the Elco Co., at Bayonne, N. J., Montreal and Quebec.

DETAILS OF THE 110-FOOT "S. C." CLASS

(Total Built for U. S. Navy and France, 450)

DIMENSIONS

Length over all	110 ft.
Length on the water line	105 ft.
Extreme beam over guards	15 ft. 4 $\frac{3}{4}$ in.
Beam on deck	14 ft. 8 $\frac{3}{4}$ in.
Draught to bottom of deadwood	5 ft 11 in.
Full load displacement	75 tons

CONSTRUCTION

Planking; yellow pine, 1 $\frac{3}{4}$ in. thick.

Frames; white oak, steam bent, sided 2 $\frac{1}{2}$ in., molded 3 in., spaced 12 in. center to center. Heavy frames at bulkheads and at points where special strength is needed, 4 in. sided by 3 in. molded.

Deck planking; Oregon pine laid straight fore and aft, 1 $\frac{5}{8}$ in., thick and 3 in. wide.

Keel; yellow pine, sided 7 in.

Keel batten; white oak, sided 9 in. by 8 in. molded.

Floors; white oak, on every frame, 2 in. thick. Heavy floors in engine space and under gun foundations 3 $\frac{1}{2}$ in. thick.

Upper clamp; yellow pine, 3 $\frac{3}{4}$ in. by 3 $\frac{1}{4}$ in.

Main clamp; yellow pine, 4 $\frac{3}{4}$ in. by 2 $\frac{3}{4}$ in.

Hogging clamp; yellow pine, 8 in. by 2 in.

Bulkheads; six steel, about 7 $\frac{1}{2}$ lb. per square foot on frames Nos. 10, 33, 37, 53, 74 and 78.

LINES

The line drawing shown is not an official plan, but is a close approximation to the form. The lines show a form which all experienced men will immediately accept as an excellent one for sea work. The water line forward is fuller than in the M. L.'s and the stern much

finer. All sections show a sharp rise of floor which becomes even sharper at the ends. At the stern there is a transom much like that of a dory in shape. The heavy weights of the machinery, fuel and armament are kept well in toward the center of the length so that the bow can rise easily and quickly to the sea. Owing to the fine lines of the after body there is a tendency for the boat to "squat" at top speed.

MACHINERY

The S. C.'s are driven by triple screws each directly connected to a 6-cylinder, 220-hp. air-starting and reversing motor built by the Standard Motor Construction Company. This is exactly the same motor used in the British M. L.'s and was already being produced in quantity when the chaser program was started. The original propellers were three-bladed, 36-in. diameter by 63-in. pitch, and were changed later to 39-in. diameter by 57½-in. pitch. The center engine can be uncoupled from its propeller shaft to allow the wheel to turn without dragging when the boat is cruising under the two wing screws.

The auxiliary machinery set is a duplicate of that in the M. L.'s previously described. Gasoline is carried in four large shaped tanks fitted on the compartment forward of the engine room under the floor of the officers' quarters. The total capacity is 2400 gal., which gives a radius of action of about 1000 nautical miles at a cruising speed of 12 knots. The maximum speed is between 16 and 17 knots. About 1½ to 1¾ knots more speed is obtained under all three engines than under the two wing engines alone.

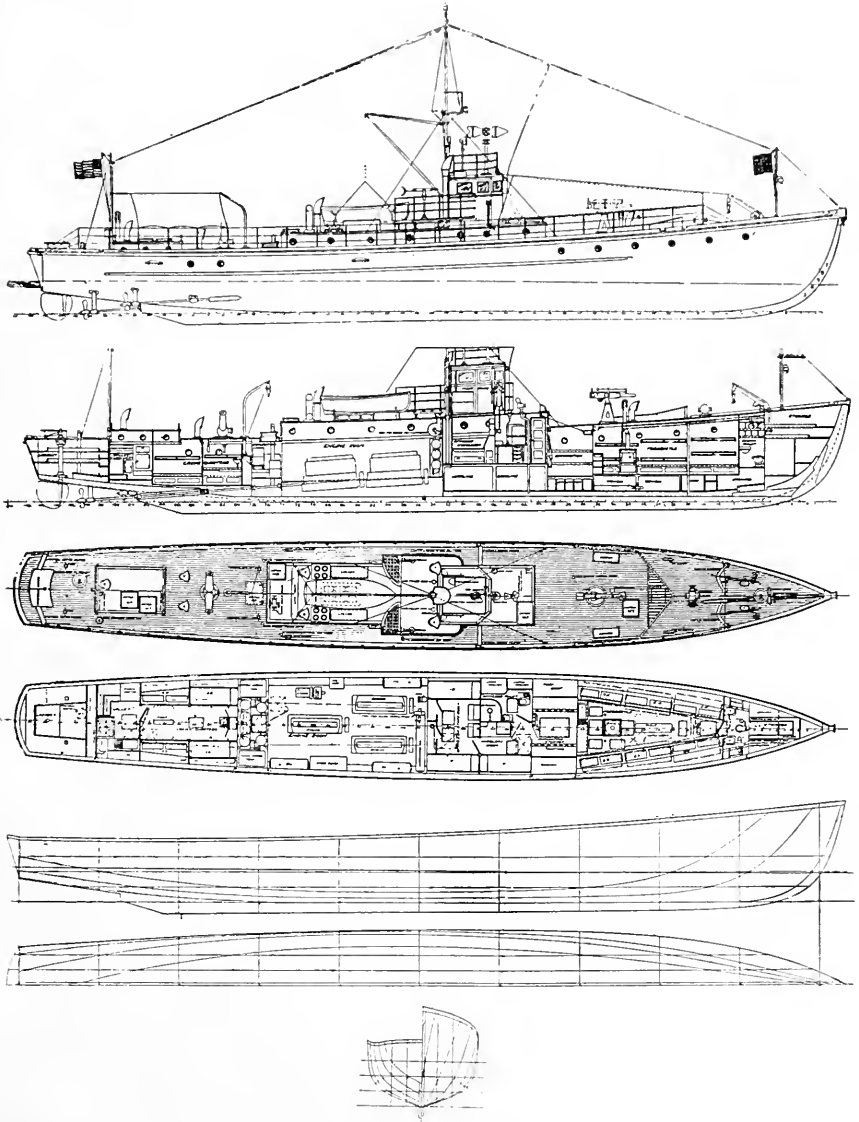

Lines, profile and arrangement plans of the 110-foot Submarine Chasers.

AMERICAN BUILDERS OF THE 110-FOOT CHASERS.

1-4	New Orleans Naval Station, New Orleans, La.	189-203	General Spbldg. & Aero Co., Washington, D. C.
5-64	New York Navy Yard, Brooklyn, N. Y.	204-208	Gibbs Gas Engine Co., Jacksonville, Fla.
65-74	Mathis Yacht Building Co., Camden, N. J.	209-213	Mathis Yacht Bldg. Co., Camden, N. J.
75-89	Hiltebrant Dry Dock Co., Kingston, N. Y.	214-217	Alexander McDonald, Mariners' Harbor, N. Y.
90-105	Elco Co., Bayonne, N. J.	218-222	Newcomb Life Boat Co., Hampton, Va.
106-113	Charleston Navy Yard, Charleston, N. C.	223-242	New York, Yacht, Launch & Engine Co., Morris Heights, N. Y.
114-115	New York Navy Yard, Brooklyn, N. Y.	243-247	Eastern Shipyard Co., Greenport, N. Y.
116-136	Norfolk Navy Yard, Norfolk, Va.	248-250	Chance Marine Const. Co., Annapolis, Md.
137-138	Hogdon Bros., East Boothbay, Me.	251-252	Camden Anchor - Rockland Machine Co., Camden, Me.
140-141	Hartman-Greiling Co., Green Bay, Wis.	253-272	Geo. Lawley & Son Corp., Neponset, Mass.
142-143	Rocky River Dry Dock Co., Rocky River, O.	273-287	Mare Island Navy Yard, Philadelphia, Pa.
144-146	Vinyard Shipbuilding Co., Milford, Del.	288-312	Puget Sound Ship Yard, Bremerton, Wash.
147-148	L. E. Fry & Co. (E. J. Wright), Clayton, N. Y.	313-317	Robert Jacob, City Island, N. Y.
149-150	Dubuque Boat & Boiler Wks., Dubuque, Iowa.	318-322	Luders Marine Const. Co., Stamford, Conn.
151-155	Gibbs Gas Engine Co., Jacksonville, Fla.	323-327	Kyle & Purdy, City Island, N. Y.
156-159	F. M. Blount, Pensacola, Fla.	328-329	Great Lake Boat Bldg. Corp., Milwaukee, Wis.
160-168	Howard E. Wheeler, Brooklyn, N. Y.	330	Burger Boat Co., Manitowoc, Wis.
169-178	Matthews Boat Co., Port Clinton, O.	331-332	Smith & Williams Co., Salisbury, Md.
179-188	International Shipbuilding & Marine Engine Co., Upper Nyack, N. Y.	333-336	Barrett Shipbuilding Co., Mobile, Ala.

337-338	L. E. Fry & Co., Clayton, N. Y.	407-408	Camden Anchor - Rockland Machine Co., Camden, Me.
339-346	American Car & Foundry Co., Wilmington, Del.	409	Chance Marine Const. Co., Annapolis, Md.
347-360	College Point Boat Corp., College Point, N. Y.	411-412	Clayton Ship & Boat Bldg. Corporation, Clayton, N. Y.
361-364	Elco Co., Bayonne, N. J.	413-418	College Point Boat Bldg. Corp., College Point, N. Y.
365-370	Gibbs Gas Engine Co., Jacksonville, Fla.	419-420	Great Lakes Boat Bldg. Corp., Milwaukee, Wis.
371-375	Hiltebrant Dry Dock Co., Kingston, N. Y.	421-425	Hiltebrant Dry Dock Co., Kingston, N. Y.
376-380	Kyle & Purdy, City Island, N. Y.	426-430	Mathis Yacht Bldg. Co., Camden, N. J.
381-385	Mathis Yacht Bldg. Co., Camden, N. J.	431-433	Matthews Boat Co., Port Clinton, O.
386-392	Matthews Boat Co., Port Clinton, O.	434-436	Alexander McDonald, Mariners' Harbor, N. Y.
393-402	New York Yacht, Launch & Engine Co., Morris Heights, N. Y.	437-438	Rocky River Dry Dock Co., Rocky River, O.
403-406	Rocky River Dry Dock Co., Rocky River, O.	439-441	Howard E. Wheeler, Brooklyn, N. Y.
		442-444	New Orleans Naval Station, New Orleans, La.

WHERE SUBMARINE CHASERS IN FOREIGN WATERS WERE STATIONED

1	Plymouth	125	Corfu	248	Corfu
34	Plymouth	126	Gibraltar	255	Corfu
35	Plymouth	127	Corfu	256	Corfu
36	Plymouth	128	Corfu	257	Plymouth
37	Plymouth	129	Corfu	251	Azores
38	Plymouth	130	Corfu	252	Plymouth
39	Plymouth	131	Corfu	253	Gibraltar
40	Plymouth	135	Azores	254	Plymouth
41	Plymouth	136	Gibraltar	258	Plymouth
44	Plymouth	137	Plymouth	259	Plymouth
45	Plymouth	143	Brest	260	Le Palteau
46	Plymouth	147	Corfu	262	Plymouth
47	Plymouth	148	Brest	264	Azores
48	Plymouth	151	Corfu	270	Gibraltar
62	Azores	164	Plymouth	271	Plymouth
63	Azores	165	Azores	272	Plymouth
64	Azores	177	Brest	277	Azores
72	Gibraltar	178	Plymouth	278	Azores
77	Corfu	179	Corfu	301	Azores
78	Corfu	180	Gibraltar	321	Harwich
79	Corfu	181	Plymouth	322	Brest
80	Corfu	182	Plymouth	323	Plymouth
81	Corfu	190	Gibraltar	324	Corfu
82	Corfu	191	Gibraltar	325	Plymouth
83	Plymouth	206	Plymouth	327	Corfu
84	Plymouth	207	Plymouth	329	Plymouth
85	Plymouth	208	Plymouth	330	Gibraltar
86	Plymouth	210	Gibraltar	331	Gibraltar
87	Plymouth	211	Azores	332	Gibraltar
90	Corfu	212	Gibraltar	337	Corfu
91	Plymouth	213	Azores	338	Corfu
93	Corfu	214	Gibraltar	340	Azores
94	Corfu	215	Corfu	341	Azores
95	Corfu	216	Corfu	342	Plymouth
96	Corfu	217	Corfu	343	Plymouth
97	Plymouth	220	Plymouth	344	Plymouth
98	Harwich	221	Plymouth	345	Plymouth
99	Le Palteau	222	Plymouth	346	Plymouth
100	St. Nazaire	223	Gibraltar	349	Corfu
101	Brest	224	Brest	351	Bordeaux
103	Brest	225	Corfu	352	Plymouth
110	Plymouth	226	Bordeaux	354	Plymouth
111	Plymouth	227	Corfu	356	Plymouth
124	Corfu	244	Corfu		

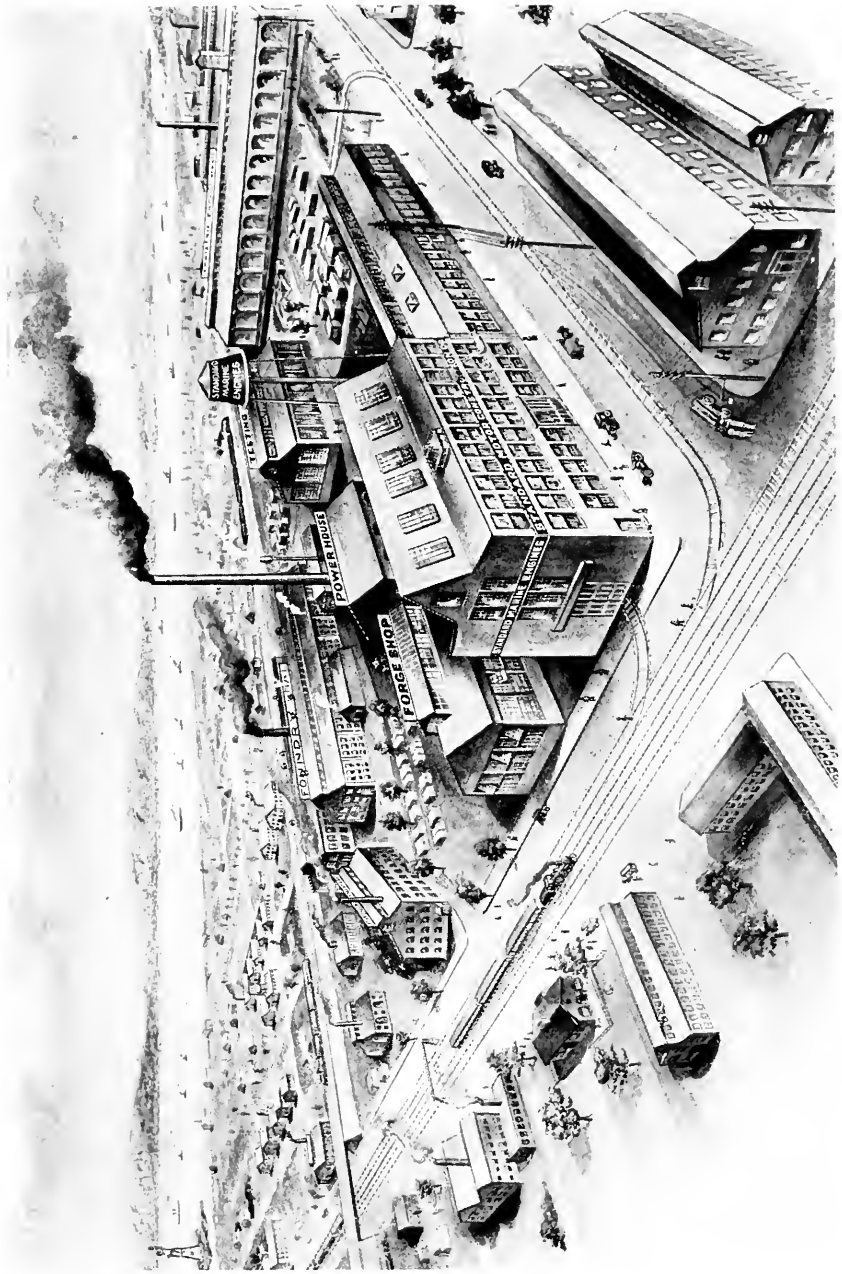

Plant of Standard Motor Construction Company, Jersey City, N. J., U. S. A.



