

COAL TAR  
DISTILLATION

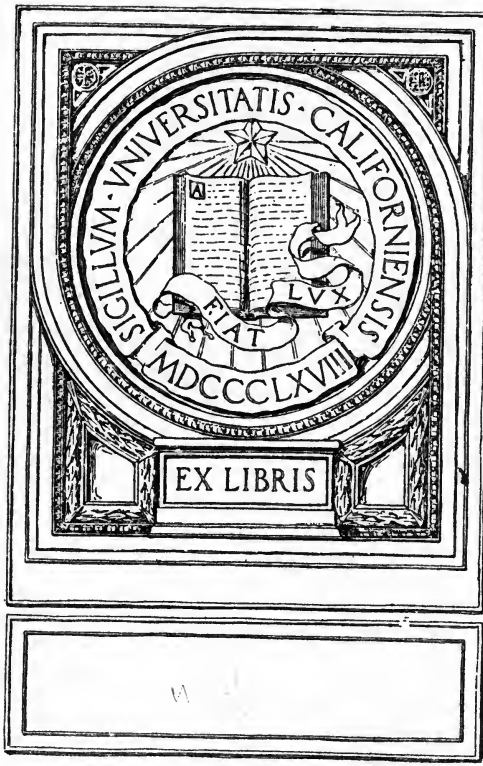

EX LIBRIS

M











# COAL TAR DISTILLATION



# COAL TAR DISTILLATION

AND

WORKING UP OF TAR PRODUCTS

BY

ARTHUR R. WARNES

CHEMICAL ENGINEER AND TECHNICAL CHEMIST,  
MEMBER OF SOCIETY OF CHEMICAL INDUSTRY, MEMBER OF FARADAY SOCIETY,  
ETC.

LONDON

JOHN ALLAN AND COMPANY

"THE GAS WORLD" OFFICES, 8 BOUVERIE STREET, E.C.

1913

TP953  
W28

THE  
LIBRARY  
OF THE  
CONGRESS

## P R E F A C E

CONSIDERING the importance of the coal tar industry at the present day, it is surprising how few practical text-books there are on this subject. I feel, therefore, that no apology is needed for offering to students, gasworks and tarworks managers and others interested in this industry, and in chemical technology, a short treatise dealing in a practical manner with the distillation of coal tar and the working up of its chief products.

In order that this book could be produced at a moderate price it has been necessary to deal with the plant and processes used in the working up of the chief products obtained by the distillation of coal tar in a more or less brief manner. Special attention has been given to the plant used for, and the process of distillation of tar, as this portion of the industry is the most important, there being many works in which tar is submitted to distillation, or a partial distillation, for special purposes, and the distillates sold to other distillers for working up.

As far as possible I have adhered to descriptions of plant and processes with which I have had a practical acquaintance, and I have drawn many of the illustrations in a diagrammatic form in order to render them more easily understood.

With reference to the figures relating to "change over" points, temperatures used, amounts of distillates obtained and so on, those given have been employed in actual practice at one time or another, but they must not be taken as guides, as coal tar and coal tar distillates, etc., are liable to variation.

My thanks are due to the firms of Messrs. Thos. Broadbent & Sons, Ltd., S. H. Johnson & Co., Ltd., and Robert Middleton, for their kindness in lending me electros with which to illustrate Chapter xiv. Also to Mr. W. R. Ball for the great assistance he has given me in reading over much of the manuscript. Thanks are also due to my wife for the assistance she has given me in the preparation of the index, and the correction of the proof sheets.

ARTHUR R. WARNES.

Hull, 1913.





# CONTENTS

## CHAPTER I

	PAGE
COAL TAR—ITS COMPOSITION—EFFECT OF NATURE OF RAW MATERIAL AND HEAT OF CARBONIZATION ON PHYSICAL PROPERTIES AND CHEMICAL COMPOSITION OF TAR—RESULTS OF PRACTICAL DISTILLATIONS. . . . .	1

## CHAPTER II

HOW TAR IS RECEIVED FROM GASWORKS—TAR TIPS—STORAGE OF TAR—CONSTRUCTION OF STORAGE TANKS—PUMPS . . . . .	4
---	---

## CHAPTER III

PLANT USED IN THE DISTILLATION OF TAR. . . . .	10
Tar stills—metals used in their construction—design—fittings—building of still—safety contrivances—swan-neck—steam pipes—charge block—dipping cock—manhole and lid—tail pipe and pitch cock—thermometer.	

## CHAPTER IV

PLANT USED IN THE DISTILLATION OF TAR ( <i>continued</i> ) . . . . .	25
Still foundations—settling—ashpits—fireplaces—curtain arch—flues—burners for gas firing—gas sewer—coal <i>v.</i> gas firing.	

## CHAPTER V

PLANT USED IN THE DISTILLATION OF TAR ( <i>continued</i> ) . . . . .	33
Preheaters—corrosion of preheater coils—advantage of preheaters—condensing coils—corrosion of condensing coils—condenser coil tanks—steam coils—collecting and dividing boxes—foul gas mains—methods of dealing with foul gases—methods of running distillates to receivers—cocks—types of receivers—steam valves—pitch coolers—French weir cooler—pitch gutters—pitch bays—emergency pumps.	

	PAGE
CHAPTER VI	
DISTILLATION OF COAL TAR . . . . .	48
<p>Charging preheater and still—commencing the distillation—crude naphtha and ammonia water stage—light oil stage—carbolic oil stage—creosote stage—anthracene oil or “green” oil stage—introduction of steam—Wells’ oil—method of testing used by stillmen—examination of safety valves, etc.—running off pitch—recharging still—discharging pitch and preparation of bay—still cleaning—dehydrated tar—tar for road treatment—tar for roofing felt.</p>	
CHAPTER VII	
PLANT FOR RECOVERING CRESYLIC AND CARBOLIC ACIDS FROM OILS . . . . .	59
<p>Sulphuric acid process—washers—storage tanks—springing tank—CO<sub>2</sub> process—carbonating boilers—phenolate tanks—pump and sump—reaction towers—divider tanks—receivers for tar acids—receivers for spent liquor—finishing tank—acid egg—storage tanks—CO<sub>2</sub> gas—CO<sub>2</sub> furnaces—purifying and washing towers—water separator—causticizing plant—causticizers—storage tanks—filters—pump—evaporators—cresylic acid—still charging tank—still—fractionating tower—condenser—“bottoms” receiver—pitch bay—cresylic and carbolic receivers—air blowing tank.</p>	
CHAPTER VIII	
THE RECOVERY OF CARBOLIC AND CRESYLIC ACIDS . . . . .	79
<p>Crude carbolic and cresylic acids—causticizing soda ash and “spent liquor”—washing oils for tar acids—interchange process—recovery of tar acids from phenolate—sulphuric acid process—CO<sub>2</sub> process—distillation of “sprung” cresylic acid—air-blowing distilled cresylic acid.</p>	
CHAPTER IX	
PLANT FOR THE RECOVERY OF BENZOLS, NAPHTHAS, ETC. . . . .	90
<p>Washing tanks—“blow-over” stills—“blow-over” still fractionating column—fractionating still and column—dephlegmator—condensing coil and tank—divider box—storage tanks.</p>	
CHAPTER X	
THE RECOVERY OF BENZOLS AND NAPHTHAS. FIRST DISTILLATIONS AND WASHINGS . . . . .	99
<p>Distillation of crude naphtha by steam or fire—distillation of light oil by fire—distillation of light oil fractions by steam or fire—distillation of light creosote by fire—washing crude benzol, crude solvent and crude heavy naphtha to remove tar acids and pyridine bases—a method of washing crude benzol—a method of washing crude solvent—a method of washing crude heavy solvent.</p>	

# CONTENTS

xi

## CHAPTER XI

PAGE

### THE RECTIFICATION OF BENZOLS AND NAPHTHAS . . . . . 107

Fractionation of washed crude benzol—preparation of 90's and 50—90's benzol—fractionation of washed crude solvent—preparation of 90 per cent. at 160°C. solvent naphtha—preparation of heavy naphtha—preparation of 75°F. flash naphtha—preparation of 85°F. flash naphtha—preparation of commercial 90 per cent. at 120°C. toluol—preparation of commercially pure benzene, toluene and xylene.

## CHAPTER XII

### PLANT FOR THE WORKING UP OF PYRIDINE FROM PYRIDINE-ACID . 113

Pyridine acid tanks—egg—neutralized pyridine acid still—condensing coil and tank—pyridine water receiver and drying tank—caustic soda tanks—lime slurry tank—pyridine rectifying still—fractionating column—condensing coil and tank—still “bottoms” tank.

## CHAPTER XIII

### THE RECOVERY AND RECTIFICATION OF PYRIDINE BASES . . . 119

Diluting and distillation of pyridine acid—recovery of crude pyridine bases from pyridine water—drying crude pyridine bases—rectifying dried crude pyridine bases—preparation of 90 per cent. at 140°C. pyridine bases and also heavy bases.

## CHAPTER XIV

### PLANT FOR THE MANUFACTURE OF CRUDE NAPHTHALENE AND ANTHRACENE . . . . . 126

“Salting-out” tanks—recrystallizing tanks—hydraulic presses—centrifugal machine—anthracene oil still—crystallizing tanks—hydraulic press—filter press—grinding machinery—washing tank.

## CHAPTER XV

### THE MANUFACTURE OF CRUDE NAPHTHALENE AND ANTHRACENE . 132

“Salting-out” the oils—recrystallizing the naphthalene salts—“drained” naphthalene—“whizzed” naphthalene—“pressed” naphthalene—distillation of anthracene oil—“salting-out” the oil—filtering the “salted-out” oil—pressing and washing crude anthracene.

## CHAPTER XVI

### PITCH AND PITCH “GETTING” . . . . . 136

Soft pitch—medium hard and hard pitch—depth to run pitch in bay—cooling of pitch—protection of pitch “getters” eyes—“getting” or digging pitch—tools—pitch cancer.

	PAGE
CHAPTER XVII	
CREOSOTE. . . . .	139
<p>Variation in specific gravity, distilling range, etc.—Wells' oil—fuel oil—sheep dip creosote—creosote for the manufacture of greases—creosote for the benzol recovery process—creosote for timber preservation—requirements of several specifications—storage of creosote.</p>	
CHAPTER XVIII	
TARWORKS' TESTS . . . . .	143
<p>Examination of tar—pyridine tests—pitch tests—examination of creosote oil—benzol testing—valuation of crude naphtha—naphtha testing—valuation of light oil—cresylic acid tests—testing meta-cresol by the long or short cresylite test—carbolic acid tests—anthracene tests—examination of caustic liquors, pent liquors and lime mud—testing coke furnace gases—examination of coke.</p>	
APPENDIX . . . . .	171
INDEX . . . . .	177

## CHAPTER I

### COAL TAR—ITS COMPOSITION—EFFECT OF NATURE OF RAW MATERIAL AND HEAT OF CARBONIZATION ON PHYSICAL PROPERTIES AND CHEMICAL COMPOSITION OF TAR—RESULTS OF PRACTICAL DISTILLATIONS

COAL tar is such a familiar material that it is unnecessary to give a description of its appearance. It is a very complex mixture of chemical compounds, chiefly of the aromatic series. The manner in which it is prepared and the nature of the raw material (coal) influence to a wide extent its chemical composition and physical properties. Dealing first with its chief physical constant, specific gravity, this varies between 1.090 and 1.215, according to the temperature of carbonization or kind of retort employed. The lower gravity tars are generally produced when low carbonization temperatures are used, or if the coal is carbonized in chamber or vertical retorts. High heats in horizontal retorts produce tar of high specific gravity. Viscosity is affected in a similar manner. Reference to Table I will illustrate these statements.

TABLE I

	<sup>1</sup> High Heat Tar. Hori- zontal Retorts. Temp. approx. 1100°C.	<sup>1</sup> Low Heat Tar. Hori- zontal Retorts. Temp. approx. 800°C.	<sup>2</sup> Vertical Retort Tar.	<sup>3</sup> Chamber Retort Tar.
Specific gravity at 60° F.	1.207	1.000	1.12	1.18

The absolute chemical composition of coal tar is far from settled, and even at the present day comparatively little is known about it. When tar is submitted to destructive distillation upwards of 190 definite chemical compounds can be separated

<sup>1</sup> Lewis T. Wright, *Jour. of Gas Lighting*, vol. lii, p. 169.

<sup>2</sup> *Proc. Inst. Gas Engineers*, 1908, p. 130.

<sup>3</sup> *Gas World*, Feb. 26, 1910, p. 262.

from the distillates and the pitch. Whether they all exist in the tar before it is destructively distilled is not certain. That light products which distil at comparatively low temperatures, such as carbon disulphide, benzene, toluene, xylene, phenol, and also some naphthalene, do exist as such in coal tar is an established fact, but whether the same is the case with all of the higher molecular weight compounds is doubtful. It is probable that some of them are formed by the decomposition of lower molecular weight compounds, and also by condensation.

It has been proved in practice that the nature of the raw material, and the temperature of carbonization affect the chemical composition, and, therefore, the quality of the tar. Dealing with the first condition, very shaley coal, or cannel coal, produce tars which yield on distillation products containing a large quantity of bodies of a paraffinoid nature. As paraffins are undesirable substances to certain users of coal tar distillates, the occurrence of these bodies will, of course, lower the market value, a matter of importance to the tar distiller. Practical working has shown that North Country coal yields a tar which on distillation gives a fairly low percentage of light oils, and a rather high yield of creosote, naphthalene and anthracene, while tar produced from Midland and Yorkshire coals yield on distillation rather more light oils and less creosote, naphthalene and anthracene; that is if comparative methods of carbonization are employed.

With reference to the effect of the temperature of carbonization on the constitution of tars, it is found that those produced at low temperatures yield on distillation, in addition to phenols of the carbolic acid series, phenols of a different series rather less acid in behaviour and probably of the creosol and guaiacol type. Also, there is a smaller yield of naphthalene and of the benzene hydrocarbons, and a large percentage of hydrocarbons of the paraffin and olefine series. Instead of most of the nitrogen occurring in the form of pyridine bases it appears in the form of aniline and its homologues. The amount of "free carbon" is also small. On the other hand, high temperature tars, *i.e.*, those produced at high heats of carbonization of coal, yield on distillation only traces of paraffinoid hydrocarbons, the predominating hydrocarbons being those of the benzene, naphthalene and anthracene series. The nitrogen occurs principally in the form of pyridine bases, and the phenols consist chiefly of carbolic acid and its homologues. The percentage of "free carbon" is generally high. In the writer's opinion the high percentage of "free carbon" is not due so much to the high heats employed as to the shape of the retort, and the amount of free space. This is borne out by the comparatively low "free carbon" content of tars from heavily charged retorts, and the very low "free carbon" content of vertical retort tar. In lightly charged retorts, in

which there occurs a good deal of free space, part of the gas and probably some of the tar is "cracked" into lighter materials and "free carbon," and this latter substance to a very large extent is carried up the ascension pipes and arrested by the tar in the hydraulic main.

The average results of some practical distillations made by the writer, using Yorkshire, Northern and Midland tars, are given in Tables II and III.

TABLE II

	Yorkshire Tar.	Northern Tar.
Ammoniacal liquor . . . . .	1.8 gallons per ton tar	11.5 per cent.
Crude naphtha . . . . .	10.5 " " "	0.9 "
Light oil . . . . .	12.3 " " "	3.0 "
Creosote . . . . .	53.5 " " "	15.6 "
Anthracene oil . . . . .	6.0 " " "	10.4 "
Pitch . . . . .	11.5 cwts. " "	57.5 "

TABLE III

	Midland Tar.
Ammoniacal liquor . . . . .	4.50 gallons per ton tar
Crude naphtha . . . . .	4.36 " " "
Light oil . . . . .	18.20 " " "
Middle oil . . . . .	9.20 " " "
Creosote and anthracene oil . . . . .	31.80 " " "
Pitch . . . . .	12.90 cwts. " "

## CHAPTER II

### HOW TAR IS RECEIVED FROM GASWORKS—TAR TIPS—STORAGE OF TAR—CONSTRUCTION OF STORAGE TANKS—PUMPS

TAR is delivered to the distillers from the gasworks in railway tank wagons, lighters or keels, tar carts, and, less frequently, the distillery is connected direct to the source of supply by a pipe-line. Examples of the latter kind are to be found in London and Birmingham. Consideration will not be given to the construction of the tank wagons and the other vehicles of transport, beyond stating that cylindrical tank wagons are the best to use for tar carriage, but a few words on the methods of emptying them on their arrival at the distillery is necessary.

It is necessary to provide a tar-tip into which these vehicles can be emptied prior to running or pumping the tar to storage tanks. It should be mentioned that in some cases the tar is tipped direct into an underground tar storage tank, or tar well. The tar-tip for railway tank wagons is most conveniently constructed between the railway metals at a suitable part of the works siding, and, of course, the position should be one which will allow the wagon to pass over a weighbridge first. A hole of sufficient size should be dug between the metals, and the bottom well puddled with clay. A covered wrought-iron tank, well coated with a bituminous iron protective solution on the outside, and provided with a 14-inch diameter hole and cover, is lowered into the hole, the sides and top well puddled, and the earth filled in on the top to the sleeper level. The tank may be built of brindled or Staffordshire blue bricks set in cement, or of reinforced concrete, and in both cases the hole should be well puddled first.

In the writer's opinion a wrought-iron tank is the easiest to put in and the most suitable for this particular work. The tank capacity should be at least that of a large railway tank wagon; and the writer would add in this connexion that he has used with economy, and to great advantage, the tank portions of old railway tank wagons after they have been overhauled. It is, of course, necessary to provide an outlet for the tar and connect up to a pump. In the case of old railway tank wagons the discharge outlet can be conveniently used, or, if desired, this can be closed,



and an outlet cut at the bottom of one of the sides of the tank. In the cold weather tar gets very thick. It is an advantage to use tank wagons provided with a steam coil and to see that a steam main and suitable connexions are rigged up near the tip. Warming up the tar will expedite the process of emptying considerably.

The tip for a tar cart can be constructed in a similar manner, but, of course, not between railway metals. It should hold rather more than the volume contained in the cart (approximately 270 gallons), and as to its position, it is advisable to place it as near the emptying pump as possible.

To empty keels and lighters it is necessary to run a pipe line to the canal or river side, and fit suitable flange connexions at the end, to which a flexible suction pipe may be attached. The flexible portion may be of wire-bound leather or flexible steel tubing, the latter is the better; and the internal diameter of this and the pipe line should not be less than 4 inches—6 inches is better.

There are works in existence which pump the tar as received direct into the stills, but this is a plan much to be deprecated, and, of course, in large works one which could not be adopted. The chief reasons why tar should be stored are (*a*) to allow much of the entangled liquor (ammoniacal water) to separate, and thus reduce the period of distillation, and (*b*) to keep a sufficient stock in the works to enable the same to be run during the "low make" season at the various gasworks from which the supply is drawn. It must be obvious that storage tanks should be of large capacity, and there are tanks now built to hold as much as 1,000,000 gallons. They are built above and below ground, and in the latter case are often known as wells.

Storage tanks erected above ground are, if built of wrought-iron or mild steel, cylindrical in form, or if constructed of reinforced concrete, cubical or rectangular solid in shape. Those built below ground are generally constructed of brick or reinforced concrete, and may be cylindrical, rectangular solid, or cubical in shape—the two latter kinds being the general rule.

As these tanks are required to hold a very considerable weight of material, often upwards of 3,500 tons, it is necessary that a site be chosen where the strata is firm, and that a good foundation be put in. If the nature of the strata is not known, it is advisable to make one or two borings at the chosen site. In the case of underground tanks these borings should be carried to a depth greater than that of the depth of the tank and its foundation, for it is quite possible that the ground for some 15 feet or 20 feet below the surface may be quite firm, and then a few feet beyond this running sand or slippery clay may occur. In cases of this nature if it is not possible to put the storage tank

in another position, special precautions must be taken when building the foundation. Should the tank be constructed of brick, concrete or reinforced concrete, and the foundation be built on unsuitable strata, no precaution being taken for this state of affairs, an unequal settling may take place and produce cracking, the results of which would, of course, be serious. If the tank be built of iron and subjected to the same unsuitable conditions, the straining produced by unequal settling would bring about leaking at the seams. On firm ground the concrete foundation need not be more than 18 inches thick, and in cases where spongy ground has to be built upon, it is advisable to reinforce the concrete with small section angle, tee, or aitch iron, arranged in lattice form. This makes a kind of concrete raft, which will practically do away with all risk of unequal settling.

It is very advisable to build the sides of concrete tanks on the reinforced principle. They may be built on the Monier system, in which expanded metal or wire network formed of iron wire arranged so that the thickest are placed longitudinally and the thinnest transversely, or on the Hennebique system, in which round iron bars are employed; in both cases, of course, the metal work is surrounded by concrete. The sides of the tank may vary between 9 inches and 18 inches in thickness, according to whether the tank is below or above ground level, or to the size of that tank. One of the best mixings of concrete to use is 4 : 2 : 1 (G. E. Davis recommends 7 : 3 : 1), and it is very necessary that the materials be thoroughly mixed, that an excess or insufficiency of water is avoided, and that the aggregate is free from clay or loam. The wet concrete should be thoroughly punned, best with a pointed rammer, and the moulding boards should not be removed until the concrete is thoroughly set. It is absolutely essential that no tar (or creosote) be put into a concrete tank until it is quite set, and a period of several months should be allowed to elapse before putting the tank into use. If a concrete tank is constructed properly it will withstand a liquid pressure of  $8\frac{1}{2}$  lbs. per square inch without leaking. The inside of the tank should be rendered with neat cement. It is advisable to puddle round the sides of concrete tanks that are built below ground before filling in the earth. The top of the tank may be constructed of reinforced concrete, wood, or iron plates.

If it is desired to build the tank of bricks, those of a non-absorbent type, such as brindled or Stafford blues, must be employed. The bricks should be set in cement, and the joints should not be too thick, about  $\frac{3}{16}$  inch. Before the tank is put into commission the cement joints must be thoroughly set. As the walls are being built up, good puddle should be well rammed round the outer side to a thickness of at least 12 inches. The thickness of the wall should be between 14 inches and 18

inches, and it is advisable to render the inside of the tank with about  $\frac{1}{8}$  inch of neat cement. The top of the tank may be built of similar materials to those used for concrete tanks. Iron tanks are sometimes placed below ground. If this is done, it is essential that every care be taken in the riveting and caulking of the seams. Also a good thick coat of pure bitumen paint, free from sedimentary matter, should be applied to the underside of the bottom and the outsides of the tank. Properly made clay puddle should be rammed round the sides and the tank may be covered in with a wooden or iron roof.

Reinforced concrete and iron tanks are the two kinds usually built above ground, and as the method of the construction of the former is the same as for those placed below ground, no further description is needed. It is desirable, however, to consider briefly the construction of iron tanks. These tanks may be built to contain as much as 1,000,000 gallons, but a very usual size is between 250,000 to 400,000 gallons. As these tanks are erected in the open air, and, therefore, exposed to all conditions of weather, corrosion troubles will rapidly set in if they are not properly covered on the outside and underside of bottoms with a pure bitumen paint free from sediment. The under side of the bottoms should be covered during erection, and the outside after completion. It is absolutely essential that good sound work be put into the tanks during their erection, as from the time of completion they are generally full, or partly full, of tar, this condition making it exceedingly difficult, if not impossible in many cases, to carry out repairs without first emptying—a very awkward state of affairs to crop up, say, at a busy time.

In all cases the seams should be double riveted and thoroughly caulked. Care should be taken that the rivets are not too short. They should be of sufficient length to allow the riveter to snap the tail of the rivet properly. The height of a finished snap-head should be about three-quarters the diameter of the shank. Mild steel rivets of a good quality should be used; poor quality steel rivets are apt to fracture. Rivet holes should be drilled for preference; in punching holes there is a great risk of an unseen fracture occurring between one hole and another, a condition which may lead up to a serious leak when the tank is put into commission.

The sheets of mild steel of which storage tanks are built should be, for preference, pressed into shape, and their thickness should vary, being greater for those plates which are to form the bottom ring, than for those it is intended to use for the top and intermediate rings. The bottom plates need not be quite so thick as those of the bottom ring. As an example of the thickness of the various plates used in building a tank, the following will prove useful.

The tank is required to hold approximately 300,000 gallons of

tar, and in this case the diameter may be 55 feet and the depth 20 feet. A tank of this depth would be built up of four rings, each being 5 feet in width. The thickness of the plates composing the bottom ring should be  $\frac{5}{16}$  inch, the plates of the next ring  $\frac{9}{32}$  inch, the next  $\frac{1}{4}$  inch, and the plates of the top ring  $\frac{7}{32}$  inch. A thickness of  $\frac{1}{4}$  inch is quite sufficient for the bottom plates. The bottom angle ring should be built of  $2\frac{1}{2}$  inches by  $2\frac{1}{2}$  inches by  $\frac{3}{8}$  inch section angle steel, and the top angle ring of 2 inches by 2 inches by  $1\frac{1}{4}$  inch section angle steel. Double riveted joints, with the rivets having a pitch of 2 inches, are used throughout.

Many tanks are not covered, but if a cover is desired, it can be built of mild steel sheets of  $\frac{1}{8}$  inch thickness, with the exception of the crown plate and the outer circle of plates, which should be of  $\frac{3}{16}$  inch. The cover is generally supported by a middle stanchion, on the top of which are riveted radial arms reaching to the circumference of the tank. Two hatches about 3 feet square, provided with *light* cast-iron covers, should be put in the cover on the outer circle plates, and provision will also have to be made for the entry of the tar inlet pipe, and an outlet for air and foul gas. This outlet pipe should be connected to a small purifier box to retain sulphuretted hydrogen, etc.

If the storage tanks are not covered, it is usual to keep about 18 inches of water on the top of the tar to prevent a nuisance. It is necessary, however, to remove the water several times during the year. The tar inlet pipe should be so constructed that it reaches about two-thirds the way down the tank. This will avoid agitation of the top liquor and splashing during pumping, when the tank contains a considerable amount of tar. Of course this precaution need not be taken if the tanks are covered. The inlet pipe should be of wrought-iron and of a diameter of either 4 or 6 inches. The centre line of the outlet pipe for removing the tar should be about 9 inches from the bottom of the tank. This pipe is best made of cast iron about 6 inches in length and of a diameter of 6 inches. It is carefully riveted to the tank and fixed by means of a flange to a best quality cast-iron plug-cock.

It is a great advantage to provide storage tanks with 2-inch wrought-iron steam coils. They should be put in in the form of a grid-iron and supported on rollers. A good method of putting the inlet and exhaust of these coils through the tank side is shown in Fig. I. The advantage of a steam coil is felt during the winter months, when tar, if it is cold, becomes very difficult to pump, owing to its increased viscosity.

As it is an exceedingly difficult matter to dip a tar tank in order to find accurately the amount of tar and weak ammoniacal liquor it contains, it is advisable, in order to check the dips, to insert a series of  $\frac{1}{2}$ -inch pet cocks up the side of the tank at a

pitch of 3 inches, commencing about 1 foot from the bottom of the tank, and finishing about 6 inches from the top.

Some care should be exercised in choosing tar pumps. They must be strong, of cast-iron throughout to minimize corrosion, and fitted with either piston or mitre valves. For delivery into storage tanks, the charging of stills or preheaters, or general transport of tar from fairly long distances, pumps having a 6-inch delivery should be installed. There are several suitable types

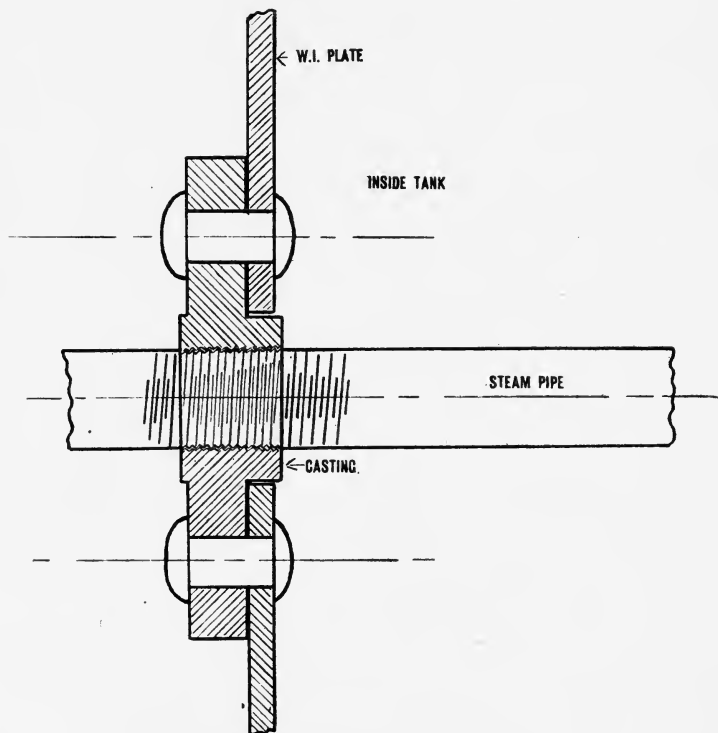

FIG. 1.—A method of inserting Steam Pipe into Storage Tanks.

of pump on the market. Of them may be mentioned three of which the writer has had experience; these are, the Worthington, Tangye, and Evans' Cornish. Each of these three makes satisfactory results in working, but the writer has no doubt that other makes would prove as suitable. It must be remembered that the pump end must have cast-iron rams or plungers, or ring packed buckets; leather or canvas packed buckets are not suitable.

## CHAPTER III

### PLANT USED IN THE DISTILLATION OF TAR

Tar stills—metals used in their construction—design—fittings—building of still—safety contrivances—swan-neck—steam pipes—charge block—dipping cock—manhole and lid—tail pipe and pitch cock—thermometer.

IN a tar distillery the pieces of plant subjected to the greatest wear and tear are tar stills, and very careful consideration should be given to the design and construction of these pieces of apparatus. The portions of a still above the pitch level at the finish of the operation are more or less severely corroded by ammonium chloride and to a lesser extent by ammonium sulphide.<sup>1</sup> The corrosion is much more severe if the still dome, manhole and charge pipe inlet are wrongly designed, or not properly lagged. The other part of a still which often gives much cause for anxiety is the bottom, which, if not properly built, or protected, or if the fireplace is wrongly constructed, may "come down" in a few weeks after being put into use.<sup>2</sup>

In the construction of tar stills, wrought-iron, mild steel, or sometimes cast-iron, is used. To employ cast-iron is, in the opinion of the writer, a great mistake. Although it is now possible to make very large castings, in which blowholes are practically absent, freedom from this weakness does not render the metal suitable, as there are other faults. For instance, the thickness of a cast-iron still is much greater than that of one constructed of wrought-iron or mild steel, the average of the sides and top being  $1\frac{1}{2}$  inches, while the bottom varies between 2 and  $2\frac{1}{2}$  inches, the latter thickness occurring at the junction of the run-off pipe (see Fig. 2). This greater thickness of metal not only means a much heavier weight to support on the brick seatings, but a greater fuel consumption. Assisting the thickness of metal in bringing about the latter drawback is the somewhat

<sup>1</sup> See "Corrosion of Industrial Iron Work," by A. R. Warnes and W. S. Davey, *Journal of Society of Chemical Industry*, June 15, 1910. *The Gas World*, April 23, 1910, p. 528, and May 7, 1910, p. 599.

<sup>2</sup> See "Coal Tar Distillation," by A. R. Warnes. *Trans. Midland Junior Gas Association* for 1910, pp. 15-29, or *The Gas World*, October 15, 1910, p. 462.

## PLANT USED IN THE DISTILLATION OF TAR 11

poorer heat conductivity of cast-iron as compared with wrought-iron. Then the uneven thickness of the bottom, at the place just mentioned, combined with the comparatively poor expansive properties and low tensile strength, opens up the risk of cracking.

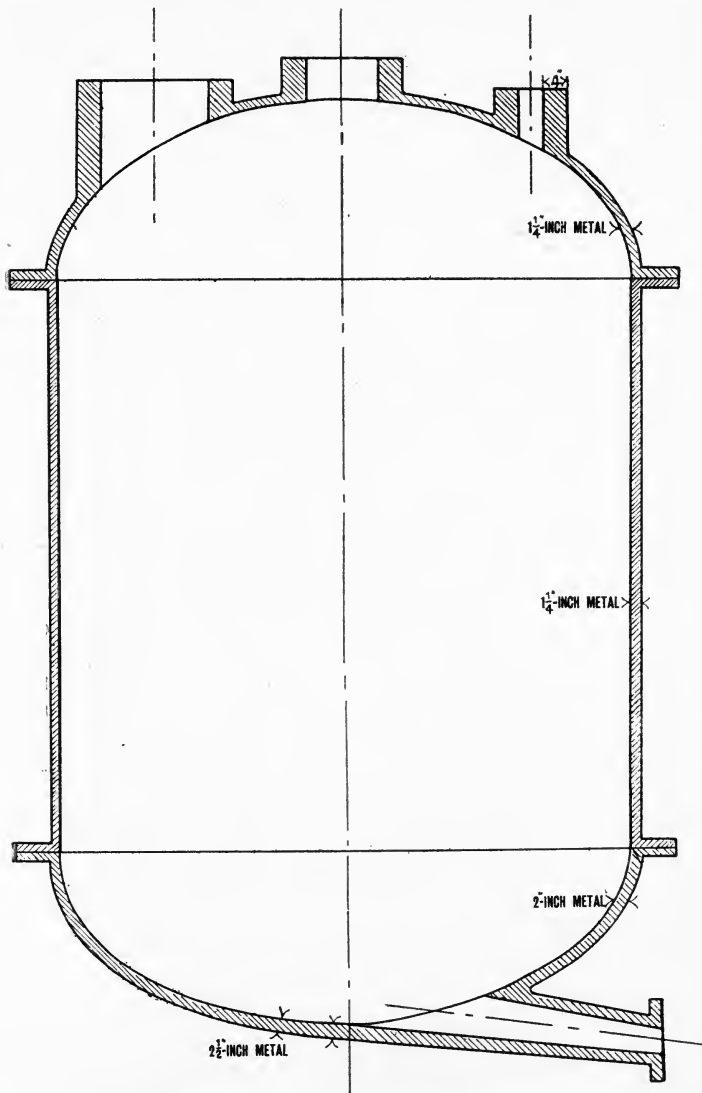

FIG. 2.—Diagram of Cast-iron Tar Still (not to be recommended).

The writer has experienced this trouble, which is of a very serious nature. In this connexion it should be pointed out that it is practically impossible to repair satisfactorily a cracked cast-iron bottom, and therefore it has to be scrapped—no small matter, as it means the removal of much brickwork before the damaged bottom can be got away and a new one put in its place. Then there is the rebuilding of the brickwork after the repair is finished. It will be noticed on inspecting the diagram (Fig. 2) that flanged joints are used in the building up of the still. This is a most unsuitable kind of joint for a vessel that is subjected to such high temperatures as a tar still. The chief difficulty is to keep the joint tight, even when the faces are perfectly trued up. The risk of a leaky bottom joint is increased somewhat, owing to the fact that the thickness of the metal of the bottom is greater than that of the sides, thus producing a certain amount of unequal expansion and contraction.

Both mild steel and wrought-iron enter largely into the construction of tar stills, but there is a diversity of opinion as to which is the better metal to use. It seems, however, that mild steel is in greater favour. Whichever metal is chosen, it is very necessary to see that the best quality is obtained. In the case of wrought-iron, there is always the risk of laminations or blisters occurring, even in the best qualities, and the thicker the plates, the more liable they are to this defect. The writer has frequently seen plates, which to all outward appearances seemed perfect, open out very badly on shaping, owing to lamination defects. Fracture is frequently caused by laminations or blisters, and corrosion is materially assisted. Owing to the fact that wrought-iron is brought into contact with fettling materials in the course of its manufacture, it is not homogeneous in structure. This state is one which also assists corrosion. Some prefer wrought-iron because of its fibrous structure, but this condition must not be considered as an absolute indication of strength. In cases in which shaping has to be done across the grain, there exists the risk of cracking.

Mild steel is, in the writer's opinion, the better metal to use. It requires, however, rather more care in working the plates. Well made mild sheet is perfectly homogeneous in structure, owing to the fact that in the process of manufacture the whole mass is in the state of fusion. There is a greater freedom from impurities, and the tendency to corrode locally is reduced on this account. Mild steel is rather more ductile than wrought-iron, and, therefore, is more amenable to the treatment received in the process of cambering, flanging, etc.

Much care should be used in the process of shaping steel plates, and where possible this should be done by hydraulic pressure. When this cannot be done, and of course it is not



possible in the case of repairs carried out in a tar distillery, much care should be used in the heating of the plates, and in particular in the shaping of them. The plates should be first heated to redness, and then beaten into shape with wooden mallets, using cast-iron templet blocks. Metal hammers should not be employed under any circumstances. Research into the causes of corrosion has proved that hammering iron or steel renders it more liable to attack. This is brought about by the production of local strain, and when metal hammers are used, this condition is set up to a greater extent than when the plates are shaped with wooden mallets.

All rivet holes should be drilled, not punched, thus avoiding the risk of cracking between one hole and another, and also the setting up of local corrosion when the still is in use. A research undertaken by T. Thickens showed that corrosion took place to a greater extent around punched rivet holes than around those which had been drilled, owing to the local shearing strain set up by the punch. The writer has been able to confirm this worker's results. It is also policy to use rivets of the same metal as the plates. The rivets should be of ample length, to allow a good snap-head to be formed, and the seams must be properly caulked. Machine riveting gives better results than those obtained by hand, and is also more economical. It should be employed whenever possible. With reference to the diameter of the rivets, and the pitch of the rivet holes, these dimensions should vary according to the thickness of the plate used. A good thickness to employ, at least for the shell, and the one generally adopted (sometimes throughout), is  $\frac{1}{2}$  inch. The pitch of the rivet holes and diameter of the rivets should be 2 inches and  $\frac{7}{8}$  inch for wrought-iron, and 2 inches and  $1\frac{5}{8}$  inch for mild steel. The centre of the rivet hole to the edge of the plate should be  $1\frac{5}{16}$  inch for wrought-iron and  $1\frac{3}{8}$  inch for mild steel. As the top, or dome, of the still is subjected to the action of corrosive vapours to a greater extent than the shell, and with some tars very much more so, it is advisable to construct this portion of the still of slightly thicker plates than those used for the shell. A useful thickness is  $\frac{9}{16}$  inch; the pitch of the rivet holes and the diameter of the rivet should be  $2\frac{1}{8}$  inches and 1 inch respectively for mild steel, which metal the writer strongly recommends for the dome and shell of the still. The centre of the rivet hole to the edge of plate should be  $1\frac{7}{16}$  inch.

It is difficult to say definitely whether wrought-iron or mild steel is the best kind of metal to use for constructing the still bottom. The writer has had a case in which two still bottoms, one of mild steel, one of wrought-iron, and each put into commission at the same time, have "come down" within a week of each other, necessitating the replacing of the greater part of the bottom of

both stills. The conditions in this case were certainly very drastic, the tar being of a very bad quality, and the still bottoms not protected in any way by brickwork. The writer's experience has caused him to come to the conclusion that, on the whole, wrought-iron is the better metal to use. Careful observation has shown that wrought-iron bottoms, properly treated and protected by brickwork when necessary, last longer than those constructed of mild steel. An investigation commenced by the writer, part of which is not yet completed, seems to show that metal of fibrous structure is the best kind to use for the construction of still bottoms. In all cases where a still bottom has "come down," cracked, or become badly burned, the metal removed from the damaged parts has been highly crystalline in structure, and very brittle, even when fibrous metal (wrought-iron) has been used. Experiments have shown that this crystalline state takes some time to form in the case of wrought-iron; mild steel is already of a crystalline nature. It also appears that the crystalline state is brought about mainly by the iron taking up carbon. It is quite well known to metallurgists that the greater the carbon content of the metal, the more brittle it becomes. Brittleness is a source of weakness in a still bottom in many ways, and the writer has known cases in which still bottoms have been cracked, and even pieces knocked out during the process of still cleaning. A good thickness of wrought-iron plate to use for still bottoms is  $\frac{5}{8}$  inch, and for this thickness rivets of 1 inch diameter are necessary. The pitch of the rivet holes should be  $2\frac{1}{4}$  inches, and  $1\frac{1}{2}$  inches allowed from the centre of the rivet hole to the edge of the plate.

Tar stills are built in various sizes, the chief being, 10, 15, 20 and 30 tons working capacity. The 15-ton size is used very largely in this country, a great point in its favour being that its contents can be worked off in between 14 and 15 hours. Although tar stills of various shapes have been tried from time to time, none of these shapes has proved so satisfactory in use as that known as the pot or vertical still, and it is this type of still that will now be described. The pot still is divided into three chief parts, namely: the shell, which is a vertical cylinder, the diameter of which is a little less than the height; the top or dome, which, in a properly designed still, should have very little rise in it; and the bottom, which is concave from the outside and pitched high. The still is provided with the following fittings: A safety valve, or similar contrivance; a swan-neck for conducting away the vapours; a steam-pipe inlet block, and a steam pipe inside connected to a perforated coil or criss-cross arrangement; a charge block, for connecting up to the charging pipe; a dipping cock; a manlid stool and lid; and a tail pipe, with cock for running off the pitch. A thermometer pipe is sometimes fitted

either into the dome or the top of the swan-neck. The separate parts of the still and the several fittings will now be dealt with *seriatim*.

The shell of the still is built up of wrought-iron or, better, mild steel plates, riveted, and of thicknesses already described. For a 12-ton still the diameter of the shell may be 9 feet and the height 8 feet 6 inches; for a 15-ton still diameter 9 feet 6 inches and height 8 feet. The dome, or top, of the still is constructed of sketch plates and a dome plate (see Fig. 3), riveted and of thicknesses previously described. The number of segments or sketch plates varies according to the size of the still or the ideas of the

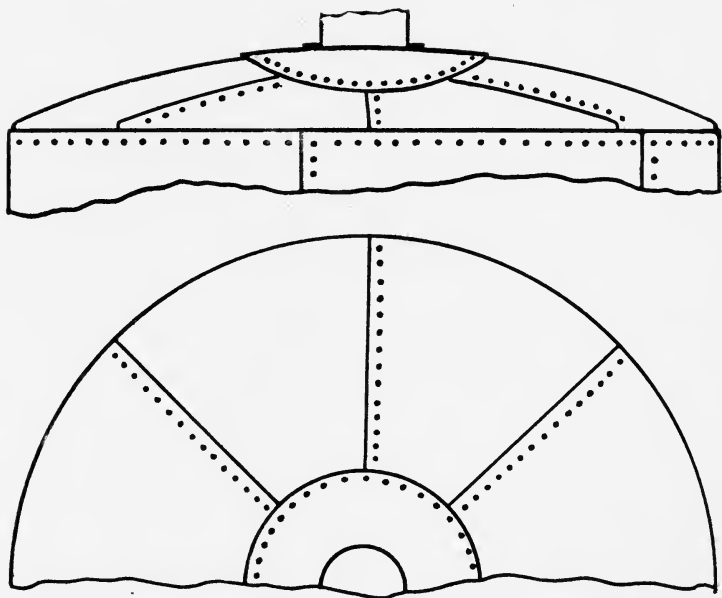

FIG. 3.—Diagram showing a Method of Arranging Sketch Plates on Still Dome.

designer. In a 12 or 15-ton still this number may be eight. The rise should not be more than 15 inches for a 12 or 15-ton still. A large number of stills have been and are at present constructed with high pitched domes; this is a mistake. It does not add to the efficient working of the still, nor is it necessary from the point of view of strength, and it materially assists in the process of corrosion. As pointed out by the writer in a paper read before the Society of Chemical Industry,<sup>1</sup> corrosion of tar stills is brought about by aqueous vapours containing ammonium chloride in the

<sup>1</sup> *Journal Society Chemical Industry*, June 15, 1910, No. 11, vol. xxix.

dissociated state, and proceeds most rapidly at those points where condensation takes place, and where the condensed vapours are able to trickle down the plates. A high-pitched dome provides all these bad points; it is more difficult to lag properly, it exposes a greater surface to the cold atmosphere, especially of winter

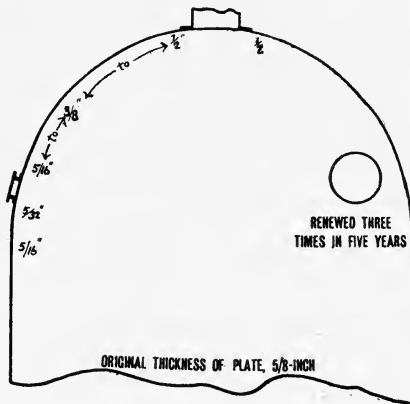

FIG. 4.—Diagrammatic Illustration showing Extent of Corrosion which can take place on a High-pitched Dome.

(most tar stills are in the open), and the manhole is in a position which further assists in the condensation and temporary retention of the condensed vapours, which eventually trickle down the plate on the underside of the hole. Cases have come under the writer's notice in which the plate under the manhole has been

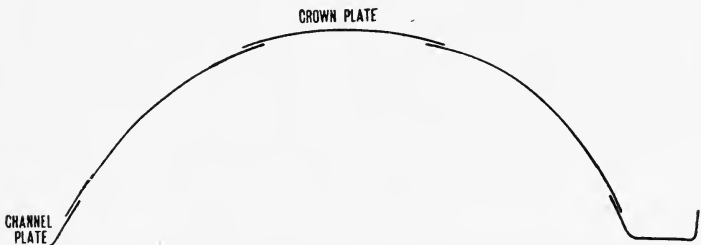

FIG. 5.—A Method of Arranging Plates for Still Bottom (Diagrammatic).

corroded through three times in five years, and in all cases of high-pitched domes he has noticed a large amount of grooving on the inside. Fig. 4 illustrates diagrammatically the extent of corrosion which can take place on a high-pitched dome.

The still bottom should be constructed of wrought-iron plates,

of a thickness already described. These plates should be well riveted and caulked. Sometimes still bottoms are constructed in one piece, but this is not a good plan; it makes repairs more costly and the bottom is not so strong. The most satisfactory way is to construct the bottom of a number of segments, or sketch

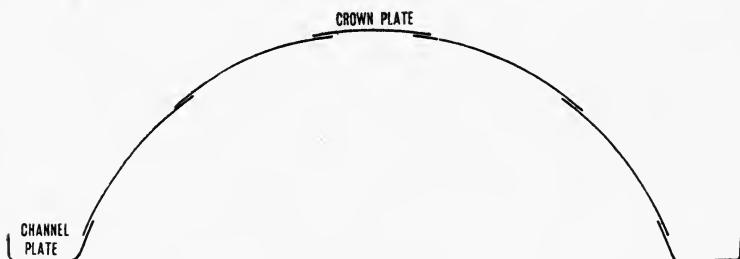

FIG. 6.—A Method of Arranging Plates for Still Bottom (Diagrammatic).

plates, united at the crown by a circular plate known as the crown-plate. The number of segments may vary between 8 and 12. Methods of arranging sketch plates and crown plate are shown diagrammatically in Figs. 5 and 6. The diameter of the crown plate varies between 2 feet 6 inches and 3 feet. It is advisable that the rise of a still bottom should be as great as possible. For a 12 or 15-ton still the rise should be 2 feet 9 inches, and for a 30-ton still 3 feet 6 inches. The bottom is joined up to the shell in two ways: (a) by angle iron, and (b) by means of what are known as channel plates. The latter method is the better, and Figs. 7 and 8 show diagrammatically the two methods. Important

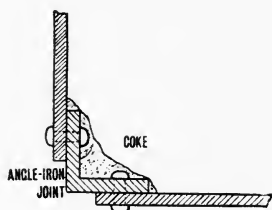

FIG. 7.—A Method of Joining Bottom of Still to Shell.

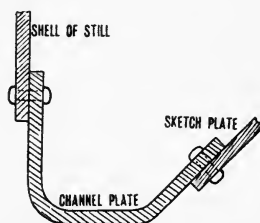

FIG. 8.—Another Method of Joining Bottom of Still to Shell.

points to bear in mind when constructing still bottoms are the necessity of securing as complete a draining off of the pitch as possible, and to introduce no joints which increase the tendency of the pitch to lodge and ultimately coke. Joints which make the work of still cleaning difficult should also be avoided. The

angle-iron joint possesses the defects just mentioned, the close proximity of the rivets acting as a nucleus for deposits which eventually coke (see Fig. 7). If channel plates are used, however, the risk of these troubles occurring is much minimized. One of the best types of channel plate to use is shown in Fig. 8. It is not advisable to make butt joints when connecting up the channel plates; lap joints are the best.

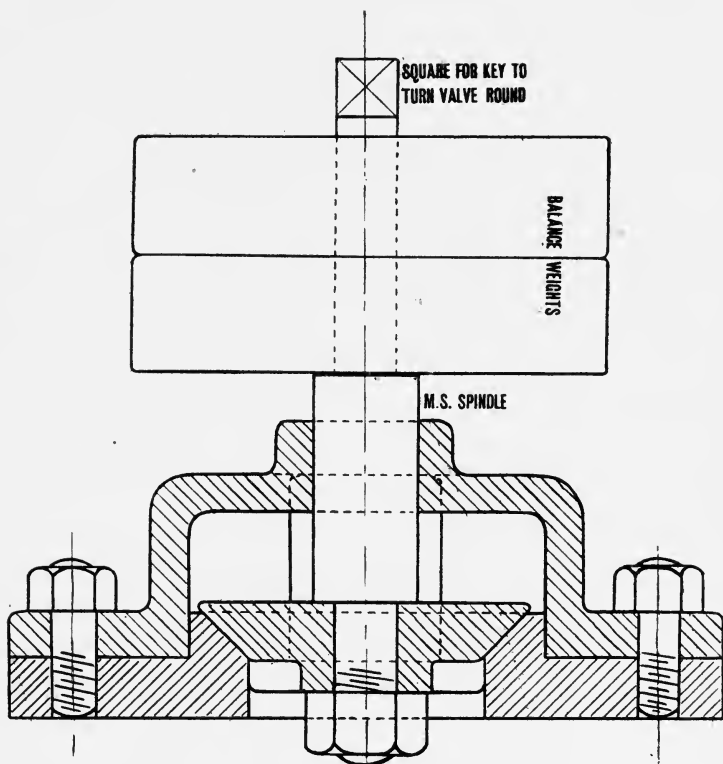

FIG. 9.—A type of Tar Still Safety Valve.

The advantages of building a concave bottom to a still are, (a) a large heating surface is secured, (b) the metal can contract and expand with comparative ease, thus minimizing strain, (c) the stiffness of the bottom is increased; (d) the draining off of the pitch is materially assisted.

When a tar still is working normally, there should be very little pressure inside, but should a stoppage occur in any portion of the condensing worm, a serious pressure may be set up. In order to

give warning that a stoppage has occurred, and at the same time relieve abnormal pressure, a safety valve, or a similar contrivance, must be fitted to the still. Safety valves of the dead-weight type are the best to use. The valve should be designed with as shallow a casting as possible on the vapour side of the seat in order to avoid a stoppage by solidified anthracene or naphthalene salts. A type of valve designed by H. Astbury and the writer, which in practice has given excellent results, is shown in Fig. 9.

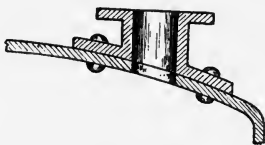

FIG. 10.—Safety Valve Stool.

The safety valve stool should be cast as shallow as possible, and riveted on to the still dome (see Fig. 10). The seat should not be too narrow, and the valve should be weighed to blow off at pressure of 6 lbs. to the square inch. Another contrivance often known as the S pipe is illustrated in Fig. 11. This device is nothing more than a water seal, the two limbs of the U bend being filled with ordinary water. The length of each limb should be 3 feet 9 inches and the internal diameter of the tube  $\frac{3}{4}$  or 1 inch. There is a much greater risk of this safety contrivance becoming clogged than with the safety valve just described; the clogging, of course, taking place in the upright tube. The S tube may be fitted to the top of the swan-neck, or on the still dome.

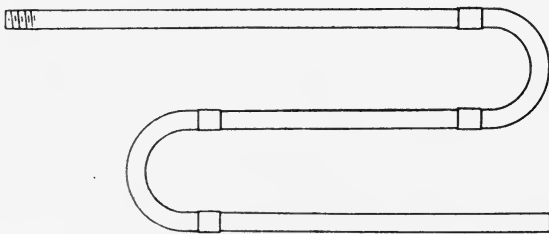

FIG. 11.—S Pipe Safety Contrivance: used instead of a Safety Valve.

The swan-neck should be made of cast-iron, and is bolted on to a swan-neck stool (see Fig. 12). Cast-iron is used because it is easier to manufacture a fitting of this shape in that metal, and it also resists to a far greater extent than wrought-iron or mild steel the corrosive action of some of the tar distillates. The internal diameter of the stool should be 12 inches, and the swan-neck tapers from 12 inches down to 4 inches. A flange must be cast on the narrow end for the purpose of attaching it to the condensing coil.

For the purpose of reducing the temperature towards the end

of the tar distilling operation, and to keep the still contents in a state of agitation, in order to prevent as far as possible the coking

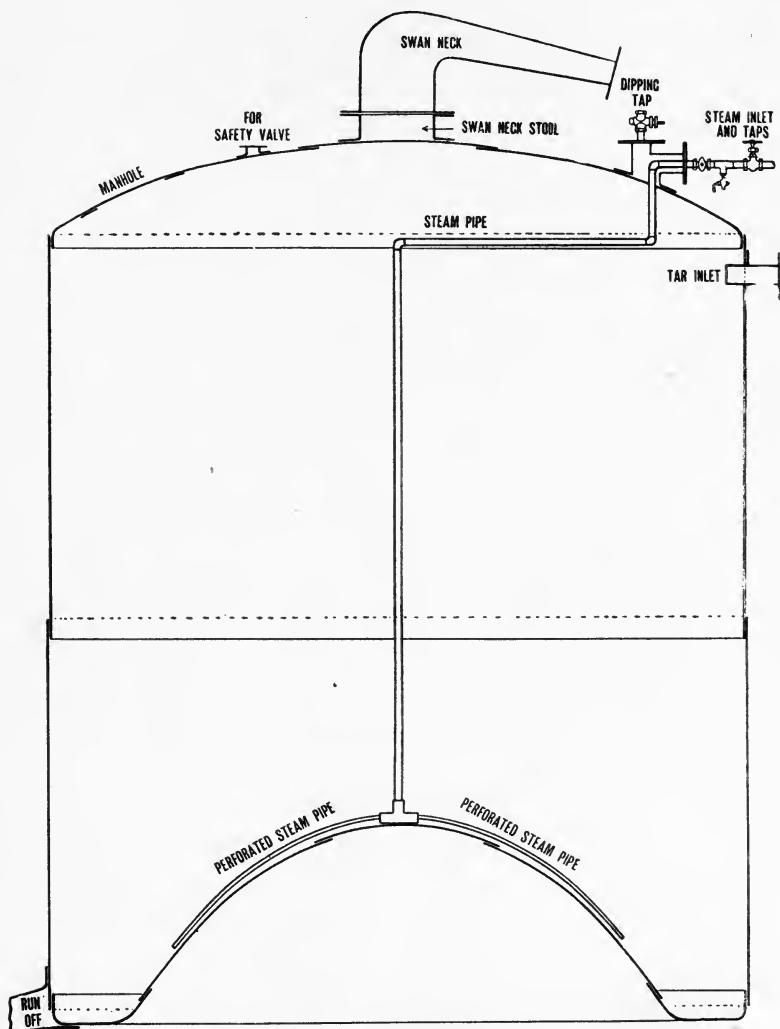

FIG. 12.—Diagrammatic Illustration of Tar Still.

of the pitch on the bottom plates, it is necessary to provide the still with open steam coils. At the point where steam enters the still, it is necessary to fit a steam-pipe inlet-block, which is



made of cast-iron, and of a design shown in Fig. 12. It is just as well to provide two valves on the steam main in order to reduce the risk of a leakage of condensed steam into the still, should one valve become defective (see Fig. 12). It is not a bad plan to introduce a small pet-cock between the two valves, through which any condensed water may be blown before the steam is admitted

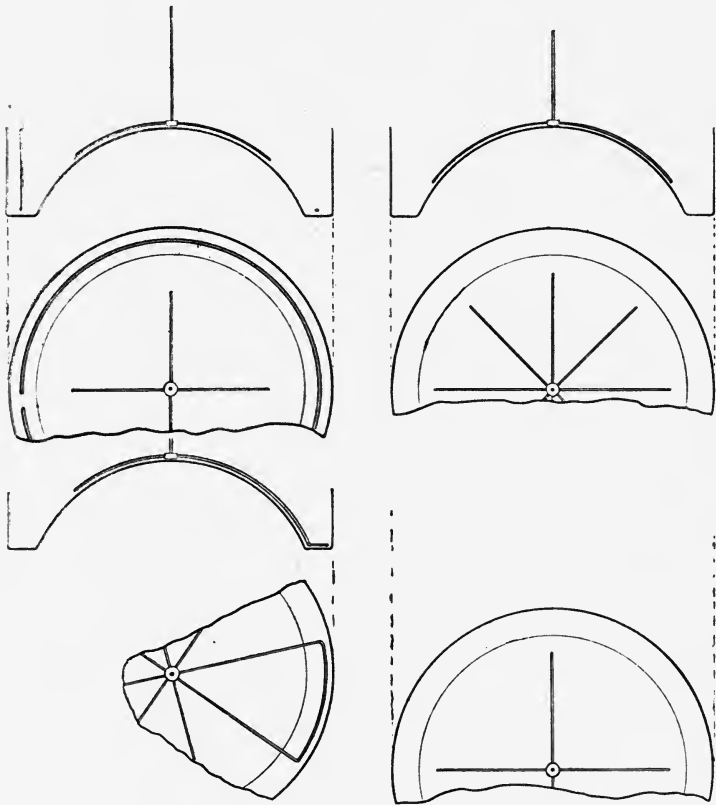

FIG. 13.

into the still. Fig. 12 illustrates this. The steam inlet pipe may be of 1 inch or  $1\frac{1}{4}$  inch internal diameter. This pipe is connected inside the still to one of a similar diameter, and of such a length that it reaches the crown plate of the still bottom. Here it is coupled up to a 4-, 6-, or 8-way piece. Into the outlets of these fittings, pieces of perforated pipe, bent to conform to the shape of the still bottom, are fitted. The internal diameter of these pipes

should be about  $\frac{1}{2}$  inch, and the holes should be drilled in such a position that the steam, as it emerges, impinges upon the plates of the still bottom. The pitch of the holes should be 6 inches, and they should be drilled on each side alternately, an occasional one

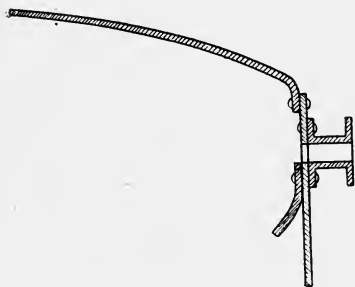

FIG. 14.—Diagram showing Method of Fitting a Protection Plate under Charge Block.

being placed right underneath. The end of each steam pipe should, of course, be closed by a plug or cap. As regards the lengths of the perforated pipes, these often have to be determined by a working experience with the still into which they are put. It is often found that coking will take place to a greater extent on one part of a still bottom than another, and sometimes even in the trough or channel, and when this occurs it is necessary to arrange that jets of steam play upon these parts. Several methods of arranging these pipes are shown diagrammatically in Fig. 13. To couple up the charge pipe to the still, a casting often termed a charge block is provided. This fitting is riveted on to the still, either just below the point from which the still top or dome springs, or just above that point on the dome itself. Of the two positions the latter is the better, in any case so far as minimizing corrosion is concerned. In the writer's experience, with inlets fitted to the still side, there has always been serious corrosion. This can be minimized by fitting a protection plate on the inside of the still under the inlet (see Fig. 14). A good type of charge block and two methods of fitting it to the still are shown in Fig. 15.

In order to prevent overcharging, the still should be fitted with a dipping cock or an overflow tap. The latter is preferred by some, and if it is desired to fit it to the still, it should be placed at the full-charge level. An arrangement for carrying away any tar which may overflow should, of course, be provided. If the still is charged from a preheater, or a blow-boiler which contains an exact still charge, then an overflow tap is not necessary. It is contended by some that a dipping tap is also un-

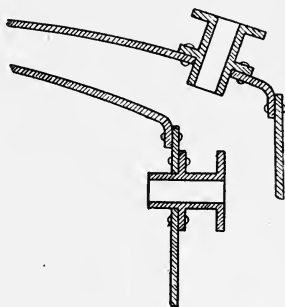

FIG. 15.—Diagram showing Methods of Fitting Charge Blocks to Still.

necessary, but, particularly in the case of stills charged by preheaters, it is advisable to use this fitting, as there is a possible chance of the charge pipe, between the preheater and the still, becoming stopped, and the use of the dipping tap provides a ready means by which the stillman can find out that the still is charged and also approximately check the volume of tar in the still. The dipping tap may be an ordinary 1-inch cast-iron plug-cock and it is advisable to rivet it to the still by means of a flange. A combined steam inlet and dipping tap block is shown in Fig. 12. The dipping rod can be made of narrow flat bar iron. For an overflow cock some prefer to use a 1-inch brass or gun-metal bib-cock, but as these metals are so easily corroded by  $H_2S$ ,  $NH_4Cl$ , etc., it is, in the writer's opinion, best to use cast-iron gland cocks for this purpose.

In order that men may enter the still for cleaning purposes, conducting repairs, and making inspections, it is necessary to provide the still with a manhole and a lid to close the same. As there is an element of danger to the workman while inside the still, it is advisable to make the manhole rather larger than the regulation size employed by boilermakers. The reason

for this is that should a man become "gassed" and have to be hauled out of the still at the end of a rope, great difficulty would be experienced in dragging that man through a regulation size manhole, and in cases like this rapidity of action is of the utmost importance. Oval manholes of 18 inches by 12 inches could be used with advantage.

It is a common practice to construct manholes as shown in Fig. 16. This is an expensive and also unsatisfactory design. Owing to the large amount of surface exposed to the cooling influence of the atmosphere, excessive condensation takes place in the casting, and the condensed vapours trickle down the side of the still. This brings about excessive corrosion. There are cases which have come under the writer's notice of still plates having an original thickness of  $\frac{5}{8}$  inch being corroded through in eighteen months. The best type of manhole and lid to employ is shown in Fig. 17. This design enables the stillman to cover the manlid completely with lagging, for instance a silicate cotton mat, after he has drawn the manlid tight. There are no projecting surfaces, and even if lagging is not used, the risk of condensation is very much less than if the type shown in Fig. 16 is adopted.

The tail-pipe or run-off pipe should be constructed of wrought-

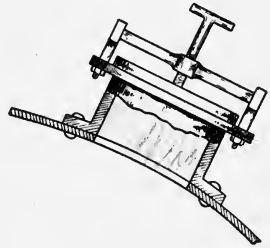

FIG. 16.—Manhole and Lid, Wrong Type.

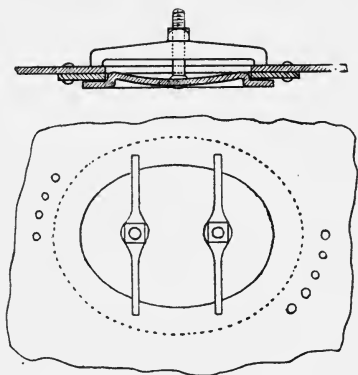

FIG. 17.—Draw-up Manlid, Correct Type.

iron or mild steel, and should be riveted to the still casing and channel plate. One example of how this is done is shown in Fig. 12. The portion attached to the still must be carefully flanged, and the rivet holes drilled, *not punched*. It may be 4 inches or 6 inches in diameter, and not less than 18 inches long, and should be provided with a flange, welded on, in order to connect it with the run-off cock. The run-off tap may be of the main cock or Butterfield type (Fig. 18), and the plug should have a

full-way. Cast-iron gland cocks should not be used. It is advisable to place an expansion joint between the cock and the pipe which connects it to the pitch cooler.

In this country thermometers are not often used with tar stills, but should it be desired, it is advisable to enclose the thermometer in a case or tube. The tube may be constructed of wrought-iron, welded at the bottom, and a few holes drilled at that point. The top portion should be provided with a flange, by means of which it is riveted to the still dome. It should be placed as near the swan-neck stool as possible. The thermometer is of course provided with a collar, so that it can be screwed into the tube and thus prevent the escape of vapours.

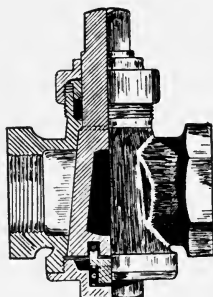

FIG. 18.—Butterfield Cock.

## CHAPTER IV

### PLANT USED IN THE DISTILLATION OF TAR (*continued*)

Still foundations—settling—ashpits—fireplaces—settings—curtain arch—flues—burners for gas firing—gas sewer—coal *v.* gas firing.

It is important that tar still foundations should be good solid ones. Before erecting a single tar still, or a battery of them, careful consideration must be given to the choice of a site. If not already known, the state of the ground should be examined, and if it is found to consist of soft gravel, moving sand, or soft wet clay, then the position should be rejected ; compact gravel or hard, dry clay are the best to build upon. On good solid ground of this description a foundation made of properly prepared concrete, and of a thickness between 6 inches and 9 inches, will be found quite suitable. It should be borne in mind that in cases of foundation building it is as well to err on the side of safety, and should there be any doubts as to the state of the natural foundation, a thicker concrete foundation, or one made of reinforced concrete, should be put in. Every endeavour should be made to avoid excessive settling of a tar still, for if this takes place, many difficulties will subsequently arise. The making of a satisfactory joint between the swan-neck and the condenser coil will not be possible, the incomplete draining away of the pitch from the still, and serious cracking of the flues, are some of the troubles which will be brought about.

To a very large extent the efficient working of a tar still depends upon the care used in the designing and building of the flues and the setting of that still. Bad designing and careless building will result in one, several, or all of the following troubles : (a) An excessive consumption of fuel ; (b) a prolonged operation resulting in extra labour, expense, etc. ; (c) boiling over at the commencement of the operation ; (d) burning of the still casing ; (e) increased corrosion, owing to unequal heating producing strain, or to severe heating of plates not covered with liquid ; (f) bringing down or burning out of the still bottom. As much attention should be paid to fuel economy in connexion with tar stills as with steam boilers. It is quite possible in a large works

to burn per annum 600 tons of coal over and above the normal quantity, should the flues be improperly built. This is indeed no small item.

The flues and the fireplace should be constructed of the very best firebrick and fireclay; easily fused firebrick will cause no end of trouble if used. Those bricks having a melting point of about 3,000° Fahr. are the best to employ. For outside work, a non-absorbent brick must be used, and brindled or Staffordshire blue bricks prove very satisfactory in this case. The object of using this type of brick is to prevent the absorption of moisture during the rainy weather, for if this takes place, serious cracking of the brickwork will inevitably follow. In a battery of stills the spaces between the outside of the flues and the straight edge of the outer wall (see Fig. 19) should never be filled in with grouted broken brick or concrete, but should be built in properly

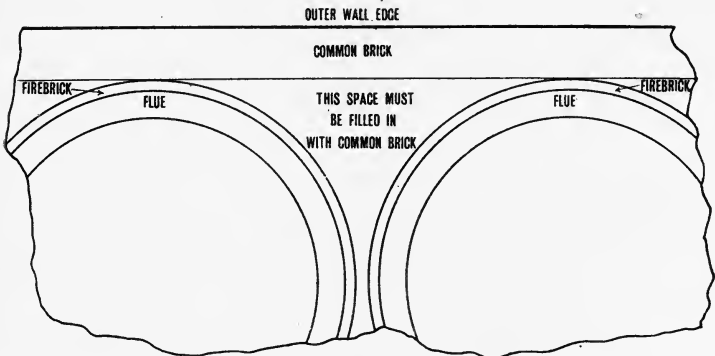

FIG. 19.

with common brick set in ordinary mortar. The mortar should not be laid too thickly between the bricks, either for the inside or outside work; a thickness of  $\frac{3}{16}$  inch is ample. This remark applies also to the fireclay used in setting the firebricks. The writer recommends pointing the outside work with neat cement, and covering that at the top with cement rendering roughed with a little sand. The object of roughing is to minimize the risk of the stillman and his assistants slipping when walking on the still top. It is advisable to build the top brickwork with a slight fall towards the edge and put in an overhanging coping of round or bull-nose bricks (see Fig. 20).

The thickness of the ordinary brickwork outside the flue should be at least 18 inches. In the case of a single still, this brickwork may be built round the flues, forming a cylinder. It is necessary to strengthen the brickwork by encircling the same

with straps or bands made of flat bar iron. The brickwork of a battery of two or more stills will remain in excellent condition, and not develop serious cracks, etc., if strengthened by means of buckstaves and tie-bars.

The structure from the concrete foundation to the under portion of the floor of the combustion chamber is built of ordinary brick. It is necessary, however, to build the floor of the combustion chamber with firebrick. This kind of brick is also used to build the still seating, and, of course, the flues. In the lower portion of the structure, an opening is left for the ashpit, the floor of which should be, for preference, on a level with the ground. Some tar distillers prefer to build the ashpit below ground, but

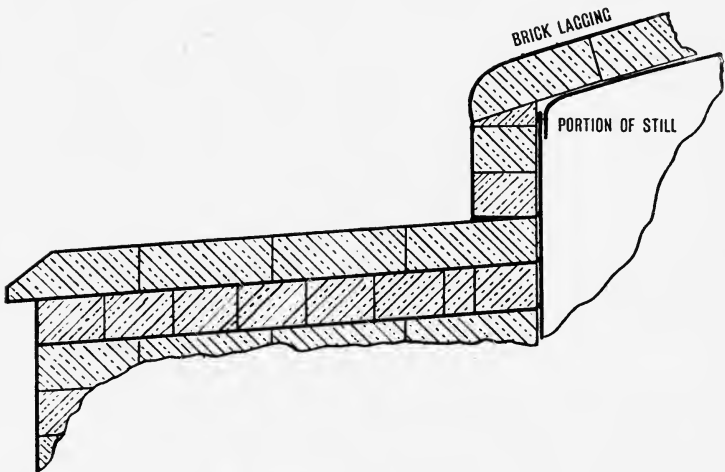

FIG. 20.—Brickwork of Still Top with Coping.

in the writer's opinion this method is not so safe as the former should the still bottom spring a leak, and the ignited tar commence to run rapidly into the ashpit. It is much easier to put out a fire with sand in the case of an ashpit built on the floor level, than one built below ground. The firebars are of that pattern employed for burning small coal (slack or smudge), and are supported on bearing bars and provided with a dead plate, as usual. A cast-iron door frame is built in and arched over during the building of the front portion of the external brickwork.

The still is supported on an annular ring of firebrick, built several courses high, and sprung from the floor of the combustion chamber (see Fig. 21). At a point opposite the fire door position, openings are left for the purpose of allowing the passage of flame

and hot gases to the flues. The portions of the channel plate of the still over these openings in the annular ring must be very carefully protected by building small brick arches under them (see Fig. 23), otherwise the metal will soon suffer severely. With reference to the size of these openings, they will vary according to the dimensions of the still, one 9 inches from the base to the top of the arch rise by 1 foot 6 inches wide will prove large enough for most purposes. In between the top of the arch rise and the channel plate of the still at least 12 inches of firebrick should be built. It is advisable in most cases to protect the bottom of the still with a firebrick arch, known technically as a curtain arch.

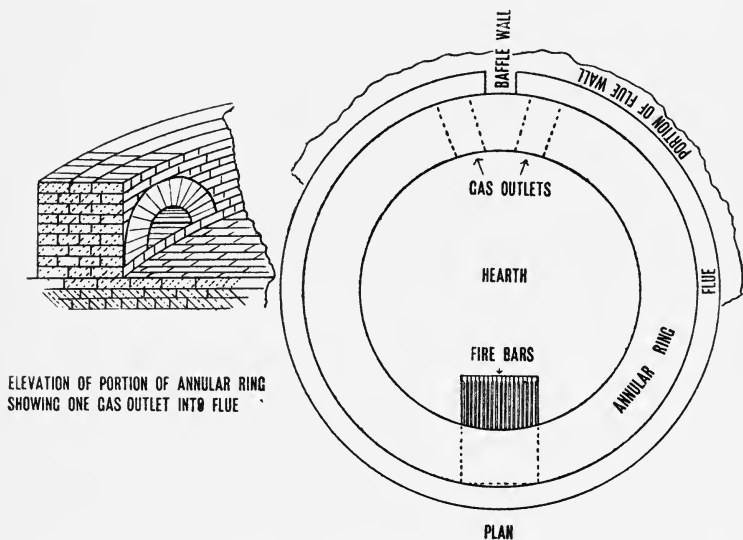

FIG. 21.—Annular Ring (Still Seat) Outlets to Flues.

This arch is sprung from the annular ring just referred to (see Fig. 23), and is of course built of the best quality of firebrick. The arch should be built in such a fashion that it provides approximately  $4\frac{1}{2}$  inches of brickwork against the still bottom. Some tar distillers prefer to leave a small air space between the firebrick and the still bottom; the writer can recommend this method in cases of bad tar.

Of the several types of flue, that known as the wheel flue is the best. This kind of flue is built single or double, according to the size of the still: a single flue being used for small stills up to 15 tons, and double flues for the larger sizes. In the case of double flues two openings must be built in the still seat instead of one, in



order to split the hot gases and send them in opposite directions round the bottom of the flue. These openings need not be quite so large as that of the hot gas exit of a single wheel flue. Immediately above the arch over the firebars a 9-inch mid-feather or baffle wall is built to the total height of the two flues. On each side of this mid-feather an opening is made in the lower flue cover, in order to allow the hot gases to pass into the upper flue, the mid-feather causing the gases to flow in two directions towards the back of the still where they come to the downtakes, which in turn lead to the main flue. A damper is always fitted in the downtake to regulate the combustion of the fuel. The top flue is covered in by overstepping several courses of firebrick, or using firebrick flue

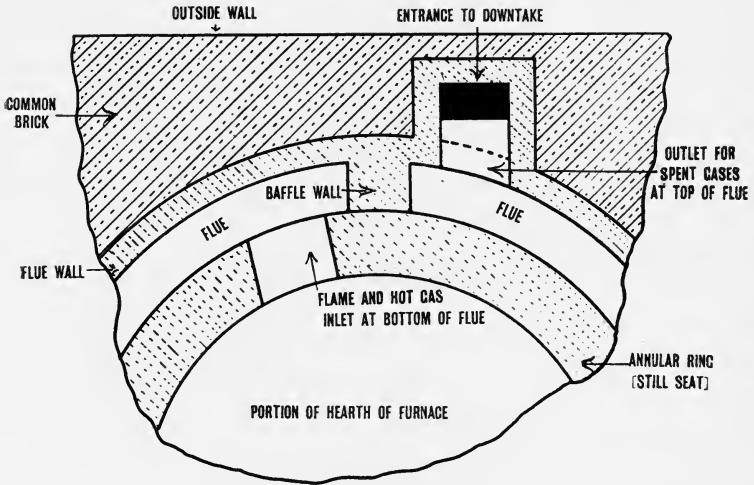

FIG. 22.—Diagrammatic Representation of Gas Inlet and Outlet in Single Wheel Flue (plan).

covers, *i.e.*, slabs of firebrick known as burrs. Tar still flues are generally built 9 inches or 12 inches wide, and of a depth varying with the size of still.

A single wheel flue requires the mid-feather or baffle wall to be built in between the gas inlet to the flues and the downtake, this causing the hot gases to completely encircle the still (see Fig. 22). The width of the flue may be the same as that of the double wheel flue, and it is covered in in a similar manner. Whether double or single wheel flues are built, it is advisable to protect the bottom portion of the still shell with a few courses of firebrick when very bad tar has to be worked. In order that this may be done it is necessary to recess the outer bottom portion of

the flue. Fig. 23 illustrates the manner in which this is carried out.

In building the flue, it should be remembered that the still shell will expand and contract throughout each operation. There is on this account always a certain amount of difficulty in keeping the various parts of the flue tight. In the case of the mid-feathers or baffle walls this may be overcome almost completely by riveting a piece of angle iron to the still, and building the firebrick on both sides of the projecting portion, as shown in Fig. 24. As regards the top cover of the flue, there is less difficulty here,

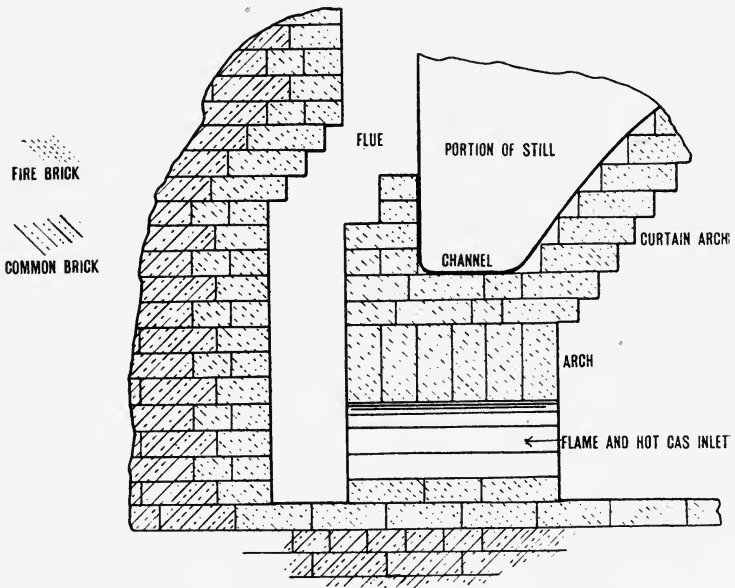

FIG. 23.—Diagram showing one Method of Protecting Bottom of Still Shell, also Channel Plate and Bottom.

owing to the number of courses of brick built above it, and the manner in which the top of the still is covered. (See Fig. 25.)

If it is desired to employ gas for firing, careful attention must be given to the design and building of the gas and air inlets, passages and burner. Ignition of the gas should not take place until it has reached the combustion chamber, and the air and gas should mix just before they enter that place. The volume of air is controlled by valves, slides, or dampers, and the gas is admitted to the burner passage from the gas sewer by a mushroom valve, controlled by a spindle and wheel. Both the gas and air

passages are built of firebrick throughout, and, of course, will run parallel to each other. Water-air gas is generally forced into the gas sewer from the producer, and is therefore hot when it reaches the gas burner. The air is warmed a little during its passage to the burner end by the hot bricks with which it comes in contact. Two methods of building a producer gas burner are shown in Fig. 26. The ordinary firegrate is not dispensed with: it is useful in case the gas supply fails, and sometimes as an auxiliary. If desired, a Terbeck burner may be employed instead of using the burners just described. Fig. 27 will give a general idea of this apparatus.

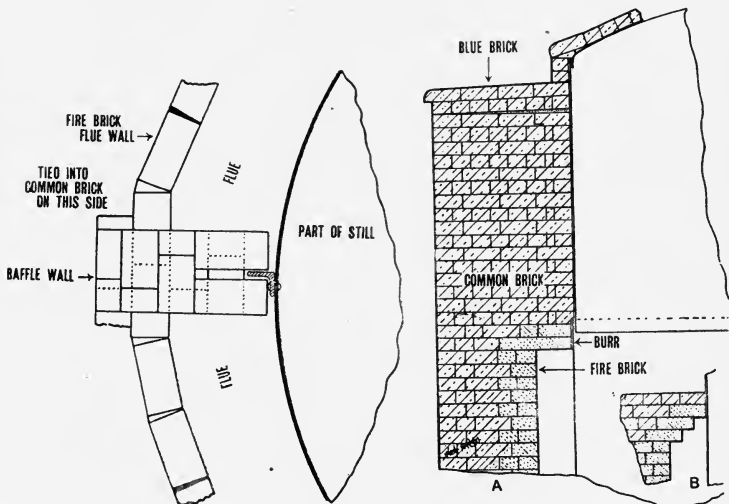

FIG. 24.—Diagram showing a Method of Keeping Flue Light at Baffle Wall.

FIG. 25.—Two Methods of Covering in Flues: A, with Firebrick Burr; B, by Corbelling.

The gas sewer is built below ground, along the whole range of stills. Careful brick setting is necessary in order to avoid leakage of gas. The outside brickwork should be of best blue brick, and the joints made of cement mortar, and not too thick. The lining is built of firebrick, properly tied into the outer wall. The sewer is covered in with a semi-circular arch of firebrick internally, and blue brick externally. It is advisable to provide the sewer with several inspection holes about 18 inches by 2 feet 6 inches in size, covered with cast-iron lids.

Several advantages are secured by the use of producer gas for firing tar stills, among which may be mentioned: (a) The operation of distillation may be controlled somewhat easier; (b) the risk of prosecution for making black smoke is obviated;

(c) fewer men are required to work a battery of stills. A little more coal is burned per ton of tar if producer gas is the fuel

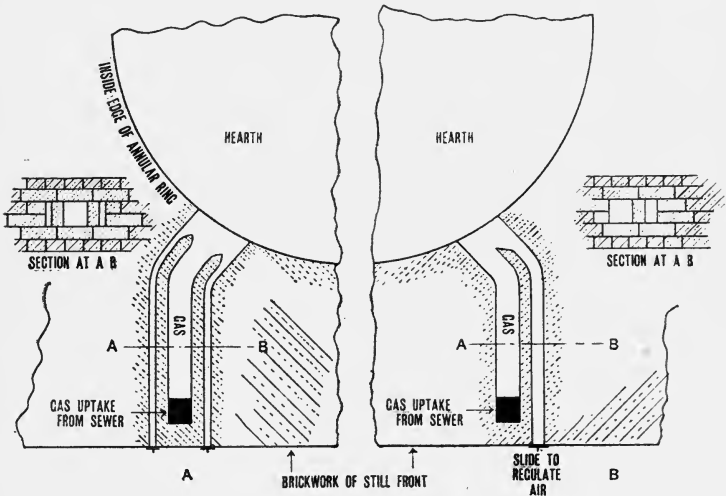

FIG. 26.—Diagrams A and B, showing, in Plan, two Methods of Building a Producer Gas Burner of Brick.

employed, but the cost of this is not so great as that for extra labour if the furnaces are coal fired.

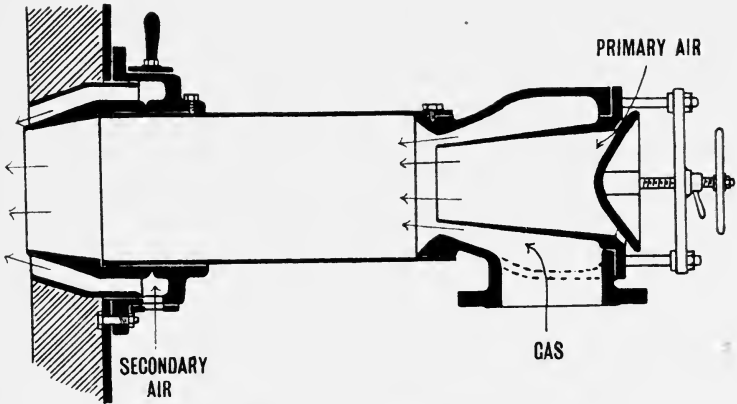

FIG. 27.—Mixing Tube of Terbeck Gas-fired Furnace.

## CHAPTER V

### PLANT USED IN THE DISTILLATION OF TAR (*continued*)

Preheaters—corrosion of preheater coils—advantage of preheaters—condensing coils—corrosion of condensing coils—condenser coil tanks—steam coils—collecting and dividing boxes—foul gas mains—methods of dealing with foul gases—methods of running distillates to receivers—cocks—types of receivers—steam valves—pitch coolers—French weir cooler—pitch gutters—pitch bays—emergency pumps.

A PREHEATER (see Fig. 28) is very similar in shape to a tar still, the only difference being that the bottom is flat. The top is built dome shape. It is constructed of wrought-iron or mild steel plates, and of a size to hold a little more than a still charge. As wear and tear are not very great, plates of moderate thickness are used in its construction; mild steel plates of  $\frac{1}{4}$  inch or  $\frac{5}{16}$  inch are quite thick enough. The mountings consist of: (a) A cast-iron charge pipe block or stool with a 6-inch or 8-inch hole, to which the charge pipe is connected; (b) a small cast-iron swan-neck fitted on to a cast-iron stool, for connecting to the vapour pipe, which in its turn is fixed to a common main leading to a condensing worm. The swan-neck may be 4 inches bore at the inlet, tapering to 2 inches at the outlet. In the writer's opinion 2-inch or 2½-inch wrought-iron steam pipe, extra thick quality, suitably bent and connected to a flange, serves this purpose quite as well; (c) a 1½-inch cast-iron gland cock fitted near the top of the preheater, through which a dipping rod may be inserted in order that the workman can find out when the vessel is charged correctly; (d) a wrought-iron screwed flange of 2-inch bore, to which is fitted a 2-inch wrought-iron overflow pipe. This pipe is connected to a common main leading to a special tar tank. The overflow outlet is placed in such a position that at the finish of a distilling operation a correct still charge of hot tar remains in the preheater; (e) a wrought-iron pipe of 3-inch bore, which is known as the discharge pipe and to which is connected a 3-inch cast-iron gland cock. This pipe is placed on the side of the preheater at the bottom; (f) a manhole of 18 inches by 12 inches with draw up lid; (g) two extra deep, screwed wrought-iron flanges of 3-inch bore, one placed so that its centre is about

3 feet 6 inches from the bottom and on the same side as the discharge pipe stool, and the other on the opposite side as near the bottom as possible. These are for admittance and egress of a condenser coil, which is fixed inside the preheater. Special

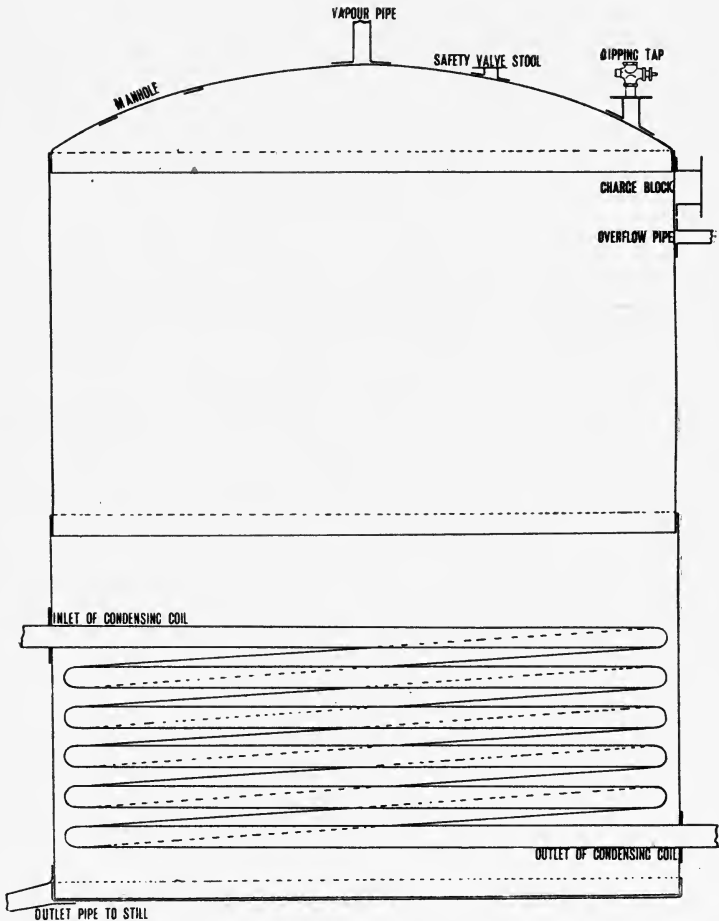

FIG. 28.—Preheater, Diagrammatic Figure.

cast-iron fittings—as shown in Fig. 29—may be employed instead of the wrought-iron flanges. They will last longer and it is easier to make repairs of the coil; (*h*) a safety valve or other suitable contrivance.

The condenser coil is made of 3-inch wrought-iron steampipe,

but it should be of extra thick quality, viz.,  $\frac{5}{16}$  inch, in order to reduce the repair bill. The coil suffers severely from internal corrosion, especially the top lap, and in the writer's experience wrought-iron steam tube of ordinary thickness ( $\frac{3}{16}$  inch) has corroded through on the top lap in less than six months, against 18 months if  $\frac{5}{16}$ -inch tube is used. The length of the coil may be approximately 160 feet, arranged in say 6 laps. Investigation made by the writer and others indicate that the corrosion of preheater coils is due chiefly to dissociated ammonium chloride and ammonium sulphide, the temperature at the top lap being particularly favourable to chemical action. The preheater is erected in an elevated position, so that the condensing coil may be attached to the swan-neck of the still, and the hot tar be discharged into the still by force of gravity.

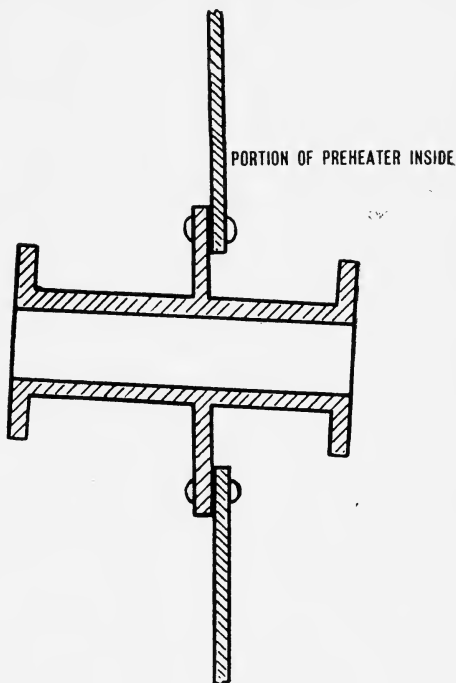

FIG. 29.

It should be properly lagged with insulating material.

Several advantages are secured by the employment of preheaters, the chief of these being: (a) There is a saving of fuel owing to the fact that hot tar is charged into the still; the tar absorbing part of the heat from the distillates passing through the preheater coil, which otherwise would be lost; (b) the time of the distilling operation is reduced, as: (1) some of the entangled ammonia water is driven off, (2) a portion of the crude naphtha is distilled off, and (3) less time is taken to bring the still "round" (*i.e.* commence the distillation), owing to the tar being hot when charged into the still; (c) more tar can be worked in a given period, because it is not necessary for the tar still to cool down to any great extent before charging again, as would be the case if cold tar had to be dealt with.

Connected to the outlet of the preheater coil, or, if a preheater

is not used, direct to the swan-neck, is the inlet end of the condensing coil. This piece of apparatus consists of laps of pipe, each lap being circular, square or rectangular in plan. The circular type is the most general. A coil can be made of cast-iron or wrought-iron; the latter metal is preferable, as the thickness of a cast-iron coil hinders somewhat the cooling or warming of the distillates, as the case may require. Another disadvantage in connexion with cast-iron coils is the presence of a large number of flange joints, which introduces frequent trouble in the nature of leaking. Wrought-iron coils are manufactured of considerable length in one piece, and a coil of this kind will do away with the chances of the distillates leaking out, or the water surrounding the coil leaking in, as is so liable to occur in the case of flange joints. The bore of condenser coils may vary between 2 inches and 4 inches, and the length between 130 feet and 300 feet, according to the size of the still. A distance of not less than  $3\frac{1}{2}$  inches should be allowed between each lap. As an example, for a 20-ton still provided with a preheater, about 130 feet of 3-inch wrought-iron pipe is sufficient. In order that the coil may be cleaned, it is advisable to arrange for a  $\frac{3}{4}$ -inch steam inlet, so that steam can be blown in after each operation. This provision will also assist in loosening a stoppage, should this occur. The steam inlet may be placed at the top of the coil before it enters the condenser tank.

The condenser coil is corroded from the top downwards, but not to such a great extent as the coil in the preheater. The corrosion also takes place from the outside, as well as the inside, especially at the top lap at the "wind and water" line. On an average the top lap, if made of wrought-iron tube of  $\frac{3}{16}$  inch in thickness, will last three years. It is possible to cut out the top lap when it is corroded through and join on to it a new lap; but if this is done, care must be taken to make a thoroughly good joint. The writer can recommend wrought-iron tube of  $\frac{5}{16}$ -inch thickness for the construction of a condenser coil.

The condenser tank will vary in shape and size according to the type and dimensions of the coil it is intended to put into it, or whether the tank is to contain more than one coil. Generally the shape is cylindrical and of a size to contain one coil. Wrought-iron plate of  $\frac{1}{4}$ -inch or  $\frac{3}{8}$ -inch thickness, or cast-iron sections, may be used to build the tank, but of the two wrought-iron is better. In arranging for the size, due allowance should be made for water space between the outer edge of the coil and the tank side; 6 inches is a good margin. The bottom lap of the coil should not rest on the tank, but should have a clearance of between 4 inches and 6 inches. A  $1\frac{1}{2}$ -inch drain cock should be placed in the centre of the bottom of the tank, by which to run off the water in case the tank or coil requires repairing, or when the tank and outside of



the coil require cleaning. A hole must be cut in the tank bottom, through which to put the coil end. A good cold water supply should be run to the tank, and the inlet pipe must extend to within 3 inches from the bottom of the same. About 2 inches from the top of the tank the water overflow pipe is inserted. The water inlet and overflow pipe may be of  $1\frac{1}{2}$ -inch or 2-inch internal bore. It is necessary to place a perforated steam coil of one turn on the bottom of the tank. A 1-inch steam pipe is large enough. This is used to assist in raising the temperature of the condenser water at one period of the distilling operation, and also to aid in the removal of an obstruction of any creosote salts in the coil, should the same occur.

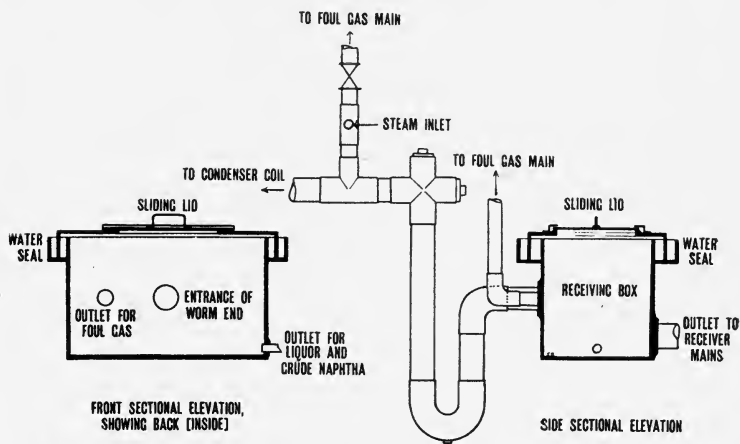

FIG. 30.—Receiving Box and Connexions.

The worm or coil end, after it leaves the condenser tank, is shaped in the form of a U in order to form a seal. One leg of the seal is connected to a small cast-iron tank known as a receiving or collecting box (see Fig. 30). This box should be covered with a cast-iron lid and water-sealed. In the lid a perfectly fitting slide door is fitted (see Fig. 30), in order that the workman may inspect the distillates as they flow from the worm end, and also collect samples of them for testing purposes. The bearing parts of the slide and its frame should be kept thoroughly greased. Two outlets are made in the sides of the box, through which the distillates are run, and one outlet is provided for making a connexion with the foul gas main. One of the distillate outlets is connected up to a piece of apparatus known as a dividing box, in which ammonia water is separated from crude naphtha, and the other to a pipe which is coupled up to the several receiver mains. Collecting boxes vary a little in size and shape, but for

most purposes 2 feet 6 inches by 1 foot 6 inches by 1 foot 6 inches deep is quite large enough.

The dividing box is made of cast-iron, is cylindrical in shape, about 1 foot 9 inches in depth and 1 foot 3 inches in diameter. It is provided with a water-sealed cast-iron lid, in which is made a 6-inch inspection hole, covered with a lid, the bearing parts of which must be kept greased. There are two outlets, one which leads to a small piece of apparatus known as a water box, really a water-sealed inspection chamber on the ammonia water main, and the other is connected up to the main which leads to the crude naphtha receiver. Each outlet is made of a sufficient size to insert a 1-inch wrought-iron pipe at about 4 inches from the top of the

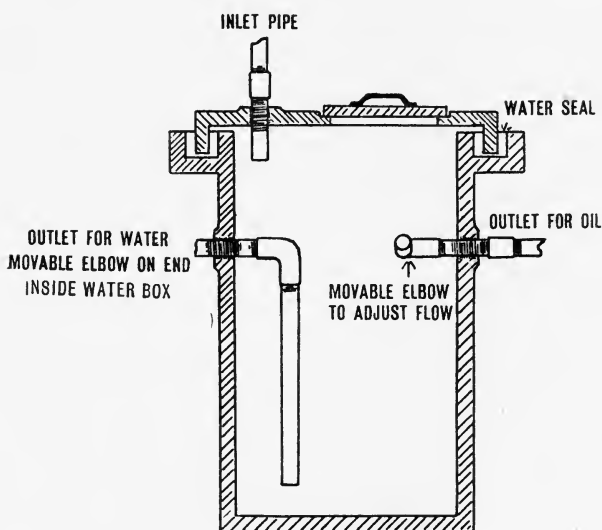

FIG. 31.—Dividing Box.

box. The centres of the two holes are on the same level, and the outlet pipe which conducts the crude naphtha away just enters the cylinder, and on to it is fitted a movable elbow to regulate the flow somewhat, while that which deals with the ammonia water bends down inside the box and reaches to within  $1\frac{1}{2}$  inches of the bottom (see Fig. 31). The inlet pipe from the collecting box is of 1-inch wrought-iron pipe, and is inserted in the cover of the dividing box. A wrought-iron connector should be placed in this pipe in order to facilitate removal if it becomes necessary to uncover the box.

The water box or inspection chamber (see Fig. 32) is a small cast-iron vessel about 8 inches by 8 inches by 8 inches deep,

internal dimensions. It is provided with a cast-iron lid, water-sealed, and one 1-inch inlet hole at the side near the top, and another 1-inch outlet hole at the bottom on the opposite side. Through the inlet hole is inserted the ammonia water pipe coming from the dividing box, and on to the end of the pipe is fitted a

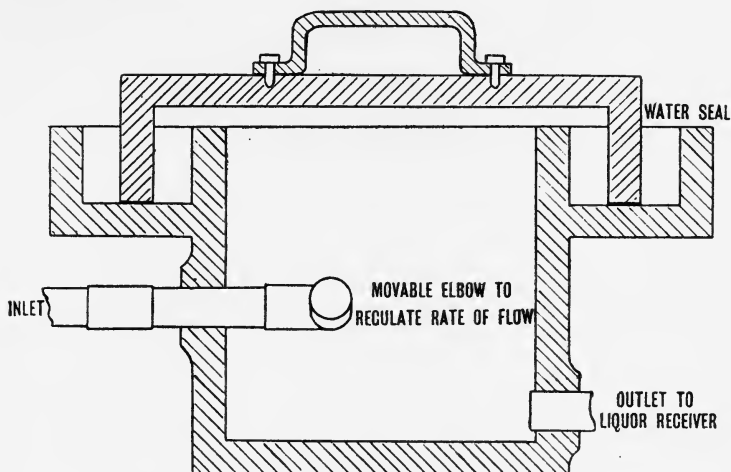

FIG. 32.—Water Box.

movable elbow to enable the workman to regulate the flow of the liquor. To the outlet is fitted a 1-inch wrought-iron pipe, which leads to the common liquor main running to the ammonia water receiver.

In order to comply with the Alkali Act, it is necessary to prevent the discharge into the atmosphere of all offensive or noxious gases, such as are given off from tar distillates, especially at the worm end, and to render these gases innocuous in some suitable manner. The plant used in tar works for this purpose varies somewhat according to the ideas of the management. In all cases it is necessary to provide foul-gas mains, to conduct away the gases and fumes from (a) the worm ends and collecting boxes; (b) the receivers; and (c) the pitch coolers. Lengths of 2½-inch or 3-inch wrought-iron pipe are fitted in close proximity to the various pieces of apparatus just mentioned, forming common mains, and the worm ends, collecting boxes, etc., are connected to these mains by means of T pieces. One end of the common main is connected up to a steam pipe, so that steam may be blown through frequently for cleansing purposes, and the other end to an exhaust pump or steam ejector, either of which draws away the foul gases, and delivers them to the boiler furnace to be burned,

or to a special apparatus for treatment with a view to recovering sulphur, etc. In all cases in which it is intended to burn the gases it is advisable to draw them through a water seal of a design somewhat similar to a wash bottle (see Fig. 33). This precaution

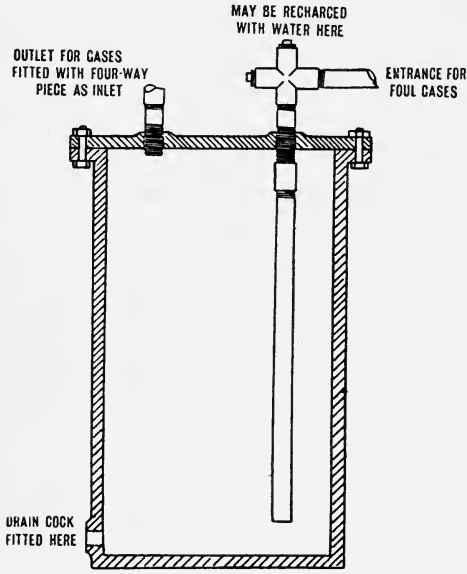

FIG. 33.—Seal Pot for Foul Gas Main.

will minimize the risk of a “flash back” taking place throughout the whole system. It must be remembered, however, that if the ejector is not carefully attended to, the risk of a “flash back” taking place and producing an explosion in the seal pot is great. The seal pot should be kept filled with water to three parts of its depth, and in the cover a hinged lid is fitted, and always kept unfastened; the bearing parts being well greased with heavy lubricating oil, to

make a more or less tight joint. The writer’s experience of this method of dealing with foul gases has been a satisfactory one. A good plan, in order to see whether the exhausting apparatus is working efficiently, is to fit one or two manometers into the main in suitable positions.

Owing to the corrosive action of the foul gases, the wear and tear on the cones of the ejector is very considerable. The writer strongly recommends the use of malleable iron cones in the place of gun-metal, which is often used, and the figures given in Table V, the average of several experiments, will support that recommendation.

TABLE V

	Gun-metal.	Malleable Iron.
Diverging cones lasted . . .	6 months	13 months
Converging cones lasted . . .	8 „	24 „

Some distillers prefer to deal with the foul gases by passing them through an oxide purifier, more or less similar to a gasworks plant but on a smaller scale. The oxide is revived as usual, and eventually sold for the manufacture of sulphuric acid.

A method of purifying foul gases by scrubbing with water and then passing through absorbing towers containing hydrate of iron in suspension in water, was devised by J. Craven and W. H. Coleman, and published by them in the *Journal of the Society of Chemical Industry*, vol. xx, page 200. This method is certainly a very safe one, and by it any ammonia, light hydrocarbons and sulphur in the gases are recovered.

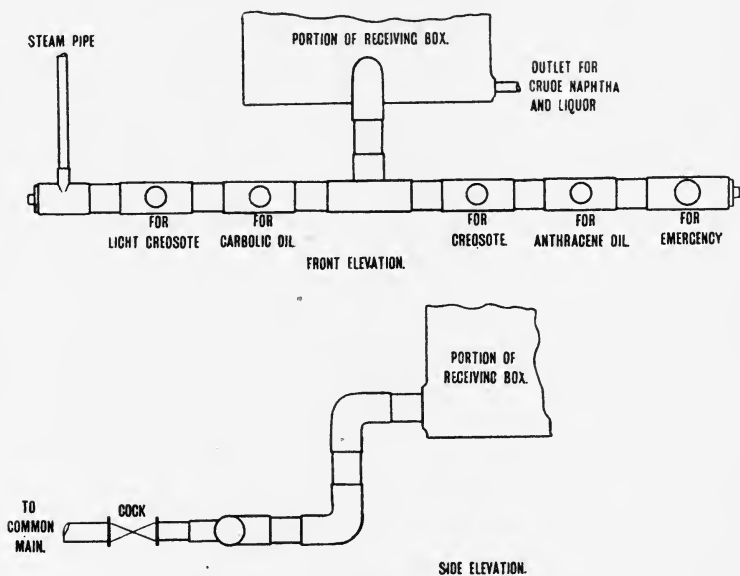

FIG. 34.—One Method of Connecting Common Mains to Receiving Box.

The various distillates from a battery of tar stills are led from the collecting or separating boxes to common mains, the latter being connected up to the receivers. Each of these common mains should be provided with a 1-inch steam inlet at one end for the purpose of introducing steam for cleaning after each operation, and to assist in removing obstructions should these occur. Endeavour should be made to keep the cocks which control the flow of the various distillates from the collecting box to the common mains as near one another as possible, and they should be suitably marked; it saves time and prevents mistakes. A method of doing this is shown in Fig. 34.

The internal diameter of the common mains will vary according to the number of stills feeding them at one time; from 2 inches to 3 inches is generally found suitable. Connexions between the collecting boxes and common mains may be of  $1\frac{1}{2}$  inches to 2 inches internal diameter.

Good cocks should be put into all these mains, and also all the pumping mains about a tar distillery. Those made of cast-iron are the best to use, and the most satisfactory type is that known as the Butterfield cock. Generally cast-iron gland cocks are employed, but unless the glands and packing are carefully and periodically attended to, leakage of a more or less serious character may take place. A cock of the Butterfield type (see Fig. 18), if properly put in, requires very little attention, and it will not leak even in a main through which hot creosotes and steam are continually passing. The writer has in his experience known gland cocks to require attention every two or three days, and the packing seeing to about every month, whereas a Butterfield cock put in the same main required no attention or packing for a period of one year and nine months. No leaking took place from the latter cock, but from the former serious leaking often occurred.

It is of course necessary to provide a receiving tank for each fraction taken off the tar. The number will, therefore, vary according to the manner in which the tar is worked up, or the nature of the tar distilled. Generally there are seven receivers provided, one for overflow tar and one for each of the following distillates: ammoniacal liquor, crude naphtha, light oil, light creosote, heavy creosote and anthracene oil. Flat-ended boiler tanks (*i.e.* old steam boilers from which the tubes have been drawn and the ends blanked) make very suitable receivers. They must, of course, be in first-class condition, free from all poor seams or thin plates. It is not possible to give any definite figure as regards size, as this must necessarily vary according to the quantity of tar worked per day and the amount of storage room. For a works distilling say 100 tons of tar per day, receivers of an average capacity of 8,000 gallons will be found quite suitable. Some works use specially made tanks of a size just sufficient to hold a little more than one of the various fractions worked off a single charge of tar. This, it is contended, enables the manager and workmen to check in a more efficient manner the yield of the several fractions from the tar.

All but the crude naphtha and ammonia receiver should be provided with a closed steam coil. One turn of 1-inch steam pipe covering the whole bottom of the receiver will be found sufficient, provided an efficient steam trap is connected with the exhaust end. Each receiver must have a manhole, which, with all the other openings should be properly covered, to prevent loss by evaporation in the case of the light distillates, and in all cases

escape of foul gases. It is desired by some to connect all the receivers to a foul gas main, but this is not absolutely necessary if all the openings are kept well covered. The contents of the receivers are removed to storage or washing tanks by : (a) Pumps, or (b) compressed air. In the latter case it is necessary to supply an air inlet, and also an exit pipe, which must reach to within about half an inch of the bottom of the lowest portion of the receiver. It is much better to put in a small dish plate at the bottom, as shown in Fig. 35. Arrangements must be made to seal the receiver completely ; if this is not done removal by com-

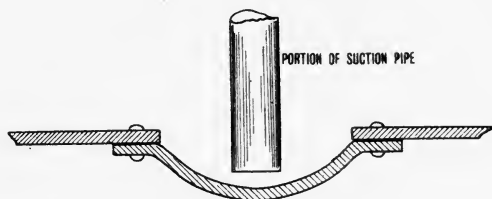

FIG. 35.—Dish Plate at Bottom of Receiver.

pressed air becomes an impossibility. For the compressed air pipe 1-inch steam tube is quite suitable, and for the delivery or exit pipe, 2-inch steam tube is the best size to employ.

If it is desired to remove the receiver contents by the aid of a pump, then a 2-inch suction pipe should be put in. This can be arranged so that it will reach to the bottom, or be lifted to any point in the receiver. It is a general plan to connect the suction pipe of all the receivers to a common pumping main and pump, cleaning the two latter by blowing steam through after the pumping operation is finished. Although not absolutely necessary, it is a good plan to connect each receiver to a special emergency main and pump ; it sometimes comes in handy when working difficulties arise.

It will not be out of place here to consider briefly the subject of steam valves, in particular those used round about the tar stills, condensers, collecting boxes, receivers, foul gas mains, etc. The valve in general use is made of gun-metal, and is of course quite suitable for all positions where sulphuretted hydrogen, ammonium sulphide or ammonia vapours are not in evidence. If these vapours come in contact with the gun-metal shell of the valve, very rapid corrosion will take place, and a fracture eventually occurs. Cast iron or cast steel stop valves do not corrode anything like so rapidly, and are, therefore, much more suitable. It is advisable to lag the valves, and also all the steampipes, with a non-conducting composition.

Owing to the high temperature at which it is necessary to run the pitch from the still, it is absolutely essential to cool the same in some manner or other. If this is not done, there is a great risk of spontaneous combustion of the hot vapours taking place, and a firing of the pitch; and even if the temperature of the pitch is too low for this to occur, acrid vapours are given off in great volumes, which will cause a nuisance in the neighbourhood of the distillery. Coolers made of wrought-iron or mild steel, cylindrical or square in shape, are most frequently employed. The former shape is, of course, the most suitable, as it withstands much better the great strain brought about by running the very hot pitch into the cool receiver. A cooler is provided with a manhole of not less than 18 inches by 12 inches or 18 inches in diameter; a manlid stool, and cast-iron lid; an inlet pipe stool, to couple up to a 4-inch or 6-inch pipe, according to the diameter of the still tail pipe; an outlet valve of the "treacle" or gate type of about 6 inches, or of the lever plug type and not less than 4 inches; and a 2-inch outlet for connecting up to a foul gas main. The manlid is left loose in order to act as a kind of safety valve. It may be sealed by embedding into a lime-putty, or covering the bearing surfaces with a layer of thick grease. Old cylindrical steam boilers, from which the tubes have been drawn, and the ends blanked, answer admirably as pitch coolers, provided the plates are thick enough, and the riveted seams are in good condition. The plates of the cylinder should be of not less than  $\frac{3}{8}$  inch and the ends  $\frac{1}{2}$  inch in thickness, or better still a thickness of  $\frac{1}{2}$  inch throughout. Each cooler should be raised a little below the ground level, say 1 foot 6 inches to 2 feet, to allow inspection for leakage to be made, and also enable the air to circulate all round it. It may be supported on brick or concrete cradles. A fall towards the outlet of about  $\frac{1}{2}$  inch to the foot should be allowed.

Pitch coolers are sometimes built in the form of brick chambers, but as it is not a general practice this form will not be considered.

In a works dealing with large quantities of pitch, a pitch cooler built on the plan known as the "French weir" will give excellent results. There are two chambers in this cooler (see Fig. 36), that marked R in the figure being the one into which the hot pitch is run from the still and in which part cooling takes place. In the other chamber, marked C, the cooling is completed. When a fresh charge of pitch is run into R it pushes the cooled pitch contained in C through the outlet O into the pitch bay.

In order to convey the pitch from the coolers to suitable positions in the pitch bay, where the final cooling prior to "getting" or digging takes place, a gutter is often built under the outlets of the coolers. The gutter should be provided with several outlets closed with gate or sluice valves, in order to direct the pitch into one portion of the bay to cool and solidify, while



“getting” is going on in another portion. As regards the arrangement of this gutter, this will of course have to be made to suit the position of the coolers, and varies in different works. Concrete may be used to construct the gutter, the surface being rendered with a mixture of cement and sand. It is far better to line the gutter throughout with brindled tiles or smooth bricks

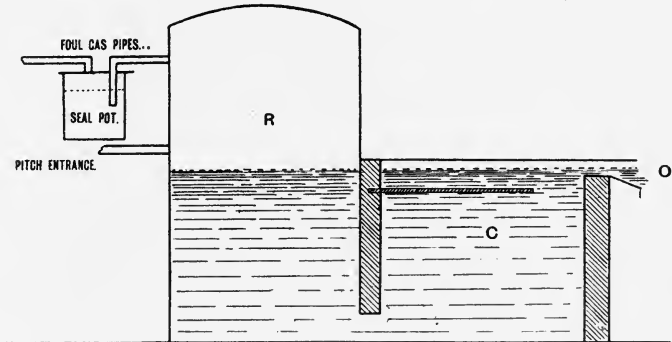

FIG. 36.—French Weir for Pitch Cooling.

set in cement, as by doing this the removal of cold pitch during cleaning is facilitated. A depth of 2 feet 6 inches to 3 feet is ample, and it should be level from one end to the other. The sides of the gutter may be 14 inches or 18 inches thick, not less than the former. It should be so arranged that the gate valves can be operated by the workman in safety from a position opposite to that which the pitch runs into the bay. A method designed by the writer is shown diagrammatically in Fig. 37. The gate may be raised and lowered by means of a rack and pinion or worm and wheel gear. In some works gutters are not used, but one is cut in the cold pitch on the bay in any desired direction. This is not a good plan.

The pitch bay is situated in close proximity to the coolers, at a lower level to them and the gutter. It should not be too deep, but of wide area, the dimensions varying according to local conditions, and the amount of tar worked up. A depth of 2 feet 6 inches below the gutter outlets is a good average; pitch of a greater thickness than 2 feet is more difficult and expensive to “get.” The floor and sides of the bay are concrete or brick lined. As regards the floor, the latter lining placed on a concrete bed proves the most suitable. The bricks should be smooth faced and of the best Staffordshire blue brick type. They should be set closely in good cement, and the whole floor should be level. It is advisable to divide the bay into several sections, say three

or four, by building 14-inch walls across it. If it is wished to avoid the expense of doing this, temporary partitions can be put up with wooden planks and loose pitch, or by leaving a wall of hard pitch from a previous "getting," but these methods are of doubtful value, as the partitions sometimes give way at most inconvenient times. The object of dividing the bay into sections is to allow one batch of pitch to cool, while another is in the process of "getting."

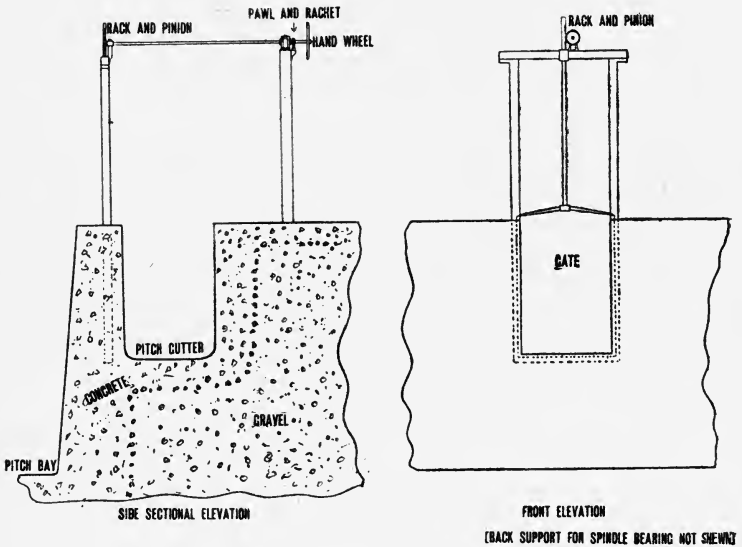

FIG. 37.—Pitch Gutter Outlet, showing Gate Valve.

It is as well to endeavour to arrange for a private railway siding to run alongside the pitch bay, and it is of great advantage if that siding is at such a level that the top of the railway trucks are practically in line with the floor of the bay. This will enable the pitchmen to wheelbarrow the pitch direct into the trucks and save the cost of a crane, skeps and a crane driver.

There are times when a tar still springs a leak, and it then becomes necessary to empty that still with all speed. In order to do this a permanent 3-inch wrought-iron main should be run along the back of the battery of stills, and a branch from this main fixed in a suitable position, so that after the connexion between the tail or run-off pipe of the still and the cooler is taken apart, immediate connexion with this branch can be made. One end of the main should be closed with a plug, and the other end con-

nected to a special pump kept especially for emergencies of this nature. The same pump can be used, if desired, as an auxiliary to the creosote pumps, but should always be so connected that it can be put into use on the tar emergency main immediately it is required. If the tar well is below ground, a pump is not absolutely necessary, as the still being above ground level, the tar would run by force of gravitation into the emergency main and thence to the well. However, speed is a matter of importance at times, and then a connexion to a pump would prove of benefit, even when the tar well is below ground.

## CHAPTER VI

### DISTILLATION OF COAL TAR

Charging preheater and still—commencing the distillation—crude naphtha and ammonia water stage—light oil stage—carbolic oil stage—creosote stage—anthracene oil or “green oil” stage—introduction of steam—Wells’ oil—method of testing used by stillmen—examination of safety valves, etc.—running off pitch—recharging still—discharging pitch and preparation of bay—still cleaning—dehydrated tar—tar for road treatment—tar for roofing felt.

THE object of distilling coal tar is to increase its usefulness, and, therefore, its commercial value. Broadly considered, the process of distillation is the same in all works. It differs only in certain details, such as (*a*) the method of testing for the “cut” or “change-over point” for each fraction, (*b*) the number of fractions a certain tar will yield, or it is desired to collect, (*c*) the wish to manufacture special products from the fractions, (*d*) the quality of pitch required, and (*e*) whether it is required to make special preparations from partly distilled tar, and so on.

By far the largest portion of the tar which passes through a tar distillery is worked for benzols, naphtha, creosotes, naphthalene, anthracene, carbolic and cresylic acids, pyridine and pitch, and the distilling of a charge of tar for the various fractions from which these products are obtained, and for pitch, will receive attention before dealing with special preparations. It will be assumed that a preheater is connected to the tar still, and that both are empty.

A charge of tar is pumped into the preheater from the storage tank or well. It is desirable to work well settled tar, as some of the entangled ammonia water will have separated to the top, and in consequence less time will be occupied in distilling off this material. While charging the preheater, the manlid of the still should be placed into position, the joint being made of lime putty: a mixture of slaked lime and water of the consistence of butter. The condensing worms, mains to the receivers, and safety devices, should be inspected to see if clear of obstruction, *i.e.*, not choked up with naphthalene or anthracene salts. A 15 to 20-ton preheater may be charged through a 6-inch main in between 30 to 45 minutes.

The preheater being properly charged, the supply is cut off,

and the tar turned into the still. As soon as the preheater is empty, *the discharge cock is shut off*, and a fire or the producer gas ignited. A further charge of tar is pumped into the preheater at the same time by the stillman's mate. Until the swan-neck becomes hot, the heating up of the tar may be pushed, but immediately that sign becomes evident, considerable care must be exercised in order to avoid "priming" or boiling over of the tar. At that point, then, the fire is slackened a little, and the worm-end watched for the first drops of the distillate. The distillation is now proceeded with, with caution, and it may become necessary to slacken the fire a little more at this stage. Sufficient heat must, of course, be supplied to keep the distillate flowing gently from the worm-end into the collecting box. Should "priming" unfortunately occur, damping the fire, or shutting off the gas, and playing or pouring cold water on the still top will soon stop it. It is not a bad plan to run a 1-inch emergency water main across the battery of stills, and place in it several cocks and short lengths of hose. The tar which comes over should be turned into the overflow tar receiver, the openings from the collecting box to the dividing box being promptly shut.

This portion of the distilling operation is known as the crude naphtha stage, and the fraction consists of ammonia water and crude naphtha. During the whole time the fraction is passing the water in the condenser tank must be kept running, and the supply should be cold. The distillate drops from the worm-end into the collecting box and then passes into the divider, where the ammonia water sinks to the bottom, and is removed by the waterpipe to the inspection box, then *via* the liquor main to the receiver. The crude naphtha flows through the outlet near the top of the divider into the main, which conducts it to the receiving tank. For a while the amount of water in the distillate exceeds that of the oil, but as time goes on the amount of the former decreases—the latter, of course, increasing. At this stage the temperature may be increased a little, but it is yet necessary to continue careful firing. The flow of the liquor and naphtha into the receiver mains is regulated by raising or lowering the elbows, the one inside the inspection box, and the other inside the divider, as explained in pages 38 and 39 respectively. As the amount of water in the distillate decreases, so *with care* may the temperature be raised, but not unduly rapidly. Towards the finish of this fraction the small quantity of water still coming over will change in colour from a greenish yellow to a blood red. From now the stillman should collect occasional samples at the worm-end, allow the oil to separate, and take its specific gravity. When this reaches a figure prearranged by the works manager, the outlet to the divider is closed, and the cock on the light oil receiver main opened. This point is known in tar works ter-

minology as the "change over" "cut," or "turn over," point. The specific gravity at the "turn over" point may vary between 0.950 and 0.965. Some stillmen "cut" the distillate when water ceases to come, but this method often results in a crude naphtha, containing rather more heavy material than is desirable. The length of time required to work off this distillate will vary according to the state of the tar and the volume of the charge. With normal tar and a 15 to 20-ton charge, 6-12 hours may be taken as average times, and with reference to the yield of the distillate, this may vary between 3 and 6½ gallons per ton of tar. During the working off of this fraction the pull on the foul gas mains should be slight, otherwise there will be a loss of light products if a recovery plant is not attached to the mains.

The strength of the ammonia water from the fraction is generally between 2 and 3½ per cent. of total  $\text{NH}_3$ , and this product is worked up at the tar distillery, or else sold to a firm of ammonia distillers. In order to avoid loss of ammonia, the receiver should be kept well sealed, and the liquor removed and dealt with as quickly as possible. Crude naphtha varies somewhat as regards specific gravity, but it usually ranges between 0.905 and 0.920. From it are obtained chiefly benzols and a little light naphtha. Full details on the working up of this material are given in Chapters IX, X, XI.

Soon after the "change over" to the light oil fraction, the distillate will begin to run from the worm-end in a moderately thick stream, and practically free from water. The temperature is gradually increased, in order to keep the distillate running at an even rate. At times, when partly through this fraction, some water comes over with the oil. It is not usually necessary, however, to slacken the firing, and the beginner should not be alarmed if this occurs. As the process continues, the amount of naphthalene salts in the distillate increases, and it is necessary to keep this material from crystallizing out and choking up the condensing coil. To avoid this, the flow of water through the condensing tank is stopped very shortly after the "cut" is made. The water in the tank then becomes gradually hot by absorbing heat from the distillate as it passes through the worm. Should the tar contain a large quantity of naphthalene "salts," making this fraction extremely "salty," it is advisable to bring the temperature of the water up more rapidly by introducing a little open steam into the tank. Generally the water is allowed to get hot when the specific gravity of the distillate stands at between 0.970 and 0.990 at 60° Fahr. The "change over" point from light oil to light creosote varies according to the nature of the tar, or if it is desired to make a distillate for a special purpose. On this account then, the stillman may "cut" the distillate when the oil running from the worm-end reaches a specific

gravity between 1.010 and 1.030 at 60° Fahr. The length of time taken to work off this distillate will vary, of course, according to the volume of the charge, and the nature of the tar; for a charge of 15 to 20 tons, 2½ to 8 hours may be taken as average figures. Yield per ton of tar is also chiefly affected by the nature of the tar, and may vary between 12 to 25 gallons. As a little more foul gas is given off during the working of this fraction, and its constituents are not so volatile as those of crude naphtha, it is advisable to slightly increase the pull on the foul gas main. The specific gravity of light oil may vary between 0.960 and 1.009 at 60° Fahr.

As the distillation proceeds, the oil running from the worm-end begins to appear more or less yellow in colour, and the smell of sulphuretted hydrogen, and other foul gases, gets a little stronger. A greater pull is put on the foul gas main, and more heat is applied to the tar. The temperature of the water in the condenser tank is kept elevated, as the distillate will still contain a fairly large quantity of naphthalene "salts." Frequently towards the end of this fraction, the oil will show a tendency to rapidly set solid on cooling, due to a predominance of naphthalene "salts." This fraction is known as light creosote, middle oil, or carbolic oil, and, as the last name indicates, is one from which carbolic acid and its homologues are obtained. It is not the only one, however, as some tar acids are recovered from both the crude naphtha and light oil fractions. It is advisable to "cut" earlier for this fraction if the tar contains a large quantity of naphthalene. The point at which the distillate is "cut" to make this fraction varies between fairly wide limits, viz., when the specific gravity at the worm-end stands between 1.035 and 1.055 at 60° Fahr. and sometimes a little higher. According to various conditions, the yield per ton of tar may be between 8 and 13 gallons, and the specific gravity will range between 1.030 to 1.045. The length of time taken to work off this fraction, say from a 15 to 20-ton batch, falls between 1½ to 3½ hours.

The distillate gets much yellower, the odour stronger, and the tendency to set solid on cooling sometimes decreases as the process continues. More pull is necessary on the foul gas mains, and heavier firing is required to keep the distillate flowing from the worm-end in a thick, continuous stream. It is advisable to keep the water in the condenser tank hot, in spite of the general tendency shown by this fraction to remain liquid at more or less normal temperatures; sometimes it does not. To obtain what is known as the creosote or heavy creosote fraction, the distillate is "changed over" when the specific gravity at the worm-end is about 1.070 at 60° Fahr. It is difficult to give definite figures for the yield of this fraction, and the length of time it takes to work off; they vary very much according to kind of tar worked,

what is desired of the fraction, and so on. As a rough guide the yield may be taken as ranging between 28 and 35 gallons per ton of tar, and the time to work the fraction off a 15 to 20-ton batch between 5 and 7 hours. The specific gravity may be within the limits of 1.050 and 1.065.

A stage in the process has now been reached in which the distillate has a very strong odour of sulphides, is of a greenish-yellow colour, and as it flows from the worm-end in a thick stream, appears viscid. This fraction contains anthracene "salts" and is liable to bring about an obstruction in the condensing worm, unless the temperature of the condenser water is high. It is advisable to keep the water at about boiling point. After this fraction has been running for a short time, the fire is slackened and steam is introduced into the still. The introduction of steam helps to lengthen the life of the still bottom by reducing the tendency of the pitch to coke. It also reduces the time required for the distillation, and, if carefully managed, increases the yield of oil. Passage of steam into the still is continued until the finish of the distillation, which point is determined according to the quality of the pitch required. It is not possible to give a definite point at which to introduce the steam; it will vary according to the quality of tar worked, and has to be found by experience. Roughly the introduction stage lies between the points at which the specific gravity of the distillate at the worm-end tests 1.070 and 1.090 at 60° Fahr. Care must be taken to use perfectly dry steam; wet steam, especially if inordinately wet, is liable to bring about a boil over. A convenient pressure to employ is 70 lbs. to the square inch. The steam valve must be opened gradually; steam must not be admitted into the still suddenly. It is advisable to let the fire die out, or shut off the gas, as the case may be, shortly before the finishing point is reached, the hot brickwork and the steam being sufficient to continue the distillation to the end. A still will continue to work for about half an hour to an hour after the fires are drawn, and if the precaution just mentioned is not taken, there is a risk of making the pitch too hard. According to the kind of tar being worked, or the quality of pitch required, the finishing point may vary between a specific gravity of 1.080 and 1.130 at 60° Fahr. The yield of this fraction, known as anthracene oil or "green" oil, given approximately as a guide, may be between 3 and 18 gallons per ton of tar, and the specific gravity may range from 1.070 to 1.100 at 60° Fahr.

When it is not desired to recover the anthracene, the heavy creosote and anthracene oil fractions are sometimes not separated, but worked as one fraction. There are certain qualities of coal tar which yield so little anthracene oil that it is not worth while attempting to make a fraction. If it is desired to prepare a



suitable creosote oil for burning in Wells or "Lucigen" lamps, then the heavy creosote distillate is "cut" at about 1.053 specific gravity at 60° Fahr., and a fraction collected between this point and 1.075 specific gravity at the same temperature. A good burning creosote must be absolutely free from insoluble matter and suspended naphthalene "salts." It should commence to distil at about 200° C. and approximately 60 per cent. distil over by the time 260° C. is reached. The specific gravity may vary between 1.065 and 1.070 at 60° Fahr.

In order that the stillman may test the distillate as it leaves the worm-end, he is provided with a No. 1 Twaddell hydrometer, a Fahrenheit thermometer with the scale inside (floating thermometers similar to those used in dairies are very suitable for the purpose) and some test jars. Tinned-iron test cans will prove more economical than glass test jars, which are easily broken. It is a good plan to arrange that the stillman has the "cut" or "change over" points given him at so many degrees Twaddell at 100° Fahr. This facilitates matters, and minimizes the risk of over-running the points, as the time taken for cooling the sample is less than if a lower temperature were used; and it saves the man making a calculation in cases in which the distillate sets solid above 60° Fahr.

If safety valves are fitted to the stills, each of them should be examined and the valve given a twist on its seat to keep in working order. This operation must be conducted while the stills are being charged, or before they commence to work. Syphon or U pipes, if used in the stead of safety valves, must be cleaned out and filled again with water before the distilling operation commences. A good method of cleaning these pieces of apparatus is to blow steam through them from a jet, which may be fixed in a convenient place on the top of the battery of stills. All the receiver mains should be blown out with steam, immediately after the distillate has finished running through them, or at the latest soon after the distillation has ended. It is very advisable to clean out the foul gas mains at least once a week, by blowing through them with open steam.

The residue in the still (pitch) is allowed to remain for a varying period before running into the cooler. This is necessary in order to minimize the risk of damage to the still and its brickwork settings owing to the great heat stored up in them, to put less strain upon the cooler should this be of metal, and to reduce the danger of the pitch taking fire to a minimum. How long a period should elapse before "runing off" the pitch will depend upon circumstances. For instance, whether the coolers are built of iron plate, or of brick, or constructed on the French weir system. The quantity of pitch in the still is another factor in the case. As a good average time  $2\frac{1}{2}$  hours may be taken; but the writer

is acquainted with some cases in which  $1\frac{1}{2}$  hours is the full time allowed, and with others in which 6 or 7 hours is allowed to elapse before the running off operation is carried out.

If the cooler is of the iron cylinder type, it must be prepared each time before running the pitch into it. Should it be fitted with a plug valve, the plug and seat must be cleaned and white-washed. The plug must then be placed carefully on its seat, not jammed down too tight. Also the manhole should be covered properly with its lid, which may be lightly luted with lime putty. It is not necessary or advisable to fasten the lid down. If it is left unfastened, it will act as a kind of safety valve. Sometimes the coolers are whitewashed on the inside, but this need not be done if they are arranged so that they drain well. Water must not be allowed to gain access to the cooler, as it may bring about trouble when hot pitch comes in contact with it. For this reason see that the manlid is kept on during wet weather. Before releasing the pitch into the cooler, put a pull on the foul gas main. In the hot weather it is a good plan to keep the outside of the cooler limewashed if exposed to the sun's rays; it will retard the absorption of heat, and so not hinder the cooling.

When discharging the pitch from the still, the cock on the tail pipe should be opened very gradually. If the pitch does not run owing to its having set in the exposed portion of the tail pipe, and this sometimes occurs in very cold weather, then warm the pipe by placing under it a little tow soaked in creosote and igniting the same. This must be done carefully. A sufficient time must be allowed for the still to thoroughly drain. To completely drain the still pays, as it reduces the amount of pitch coke formed at each distillation, increases the number of times a still may be worked before cleaning, and minimizes the amount of wear on the still bottom. It is not necessary, nor is it advisable, to remove the manlid of the still before discharging the pitch; nor need any of the connexions be taken apart. The foul gas main connected to the coolers should be kept at work for between one and two hours after the pitch has been discharged into them.

After the still has been discharged, it must be allowed to stand empty for a period, the length of which will depend upon the size of the still, and whether the same is provided with a preheater or not. If there is no preheater, the flue dampers must be opened, in order to allow a current of air to pass round the still and cool it. After the elapse of between  $1\frac{1}{2}$  and 2 hours the still can then be charged with cold tar. It is not advisable to shorten the time as this will introduce the risk of an explosion, and also bring about an undue strain on the rivets and seams, producing leaks. In cases in which a preheater is provided there is no need to draw the dampers, and the still may be charged again about half an hour after the pitch has been run off. The

tar in the preheater being hot the danger of starting the seams, or of explosion, is avoided. Whether cold or hot tar is run into the still it is as well to commence the operation slowly, and increase the speed of flow, say after about 5 or 10 minutes has elapsed. Before commencing the next distilling operation, it is as well to dip the still to check the amount of the charge.

The pitch is allowed to remain a number of hours in the cooler before it is discharged on to the bay. It is not possible to give a definite time, as the size of the cooler, requirements of local bye-laws, state of the weather and other conditions will affect this. In any case, it is not advisable to run the pitch on to the bay too hot; some of the volatile matter is lost thereby, and the acrid vapours are given off in such dense clouds that it creates a nuisance. A good temperature at which to release the pitch is 260° Fahr. When there are several coolers to discharge, it is best to release one of them at a time. Arrangements should be made to run the pitch on one portion of the bay only, by this method allowing a previous running to cool while another section is being dug. The pitch must not be run too thick; 12 to 18 inches is an ample depth. Much above this thickness will take an excessive time to cool, and is not dug so easily.

Before running off the pitch the bay must be prepared to receive the same. It is necessary to lime or chalk-wash the bottom and the sides if these are of brick or concrete. Sand must not be used; the buyers do not appreciate it. The very thinnest wash of lime or chalk-milk is all that is necessary. Every endeavour must be made to keep water off the bay, at least just previous to the discharging operation and while that is going on. The effect of water on hot pitch is to fill it with vapour cells, or in other words to make it cellular. This appearance is not sought after by buyers. There is of course the difficulty of coping with wet weather, and the best plan to adopt on a wet day is to lime-wash the bay a few minutes before discharging the pitch, and then run it on to the bay as quickly as possible. If the pitch is run to the bay *via* a gutter, see that the gutter is limewashed and cleaned out after each operation.

After a still has been worked a number of times, varying according to the state of the tar, the care with which the still was set, and the amount of draining after each operation, it must be cleaned. A good average is seven times; often a still is cleaned after working four times, and cases occur in which a still is not cleaned until it has worked eighteen times. The money and time spent in *frequent* still cleaning cannot be considered as wasted. It brings about a saving in fuel and increases the life of the still bottom, both to a considerable degree. In the cleaning operation, the mixture of partly coked pitch and free carbon must be cleaned or scaled off the still bottom and sides very thoroughly,

taking care to remove any which may adhere to rivet heads or find lodgment in seams. The formation of this scale is due partly to the heat retained in the brickwork surrounding the still coking the thin layer of pitch left in the still at the end of the "running off" operation, and partly to "free carbon" which deposits and adheres to the bottom during the first and intermediate portions of the operation. For the scaling of stills, the following tools are in general use: Short or miners' picks, straight and cross-pane 4-lb. hammers, and chipping chisels.

It is very necessary that certain precautions be taken to prevent accidents to workmen during the cleaning process. The still should be completely isolated from adjoining plant by disconnecting the swan-neck from the condenser worm, and the tail pipe from the pitch cooler. If there is not a small connecting pipe which can be removed completely, then a blank flange should be placed between the disconnected joint. The manlid must be removed shortly after the pitch has been run off, and it is as well to drive out the foul air by blowing steam into the still. Sufficient time must be allowed for the still to cool before an entry is attempted. The length of time will vary according to the size of the still, the time of the year, and whether the still is one of a battery or the only one. It is best found by experience, but as a guide, 30 to 48 hours are general in tar-distilling practice. A responsible person should inspect the still before a workman is allowed to enter. The workman who enters the still must have a belt fastened round his body, with a rope attached. This belt is best made of stout webbing, and provided with two wash-leather pads on the spots which come under the armpits. In order that the wearer may be drawn up head-foremost in a case of "gassing," the belt must be worn well up to the armpits. Two men should be on duty outside the still, having charge of the free end of the rope and keeping watch on the workman inside for any signs of "gassing." The ladder which is used to descend into the still is provided with two straight hooks at the top, which fit over the manhole edge, and thus prevent slipping.

Prepared and dehydrated tars are used for many purposes, the chief of which is for road treatment. Among the minor uses may be mentioned its employment in the manufacture of roofing felt, electric arc lamp carbons, and the linings of converters used in the basic Bessemer process. Most of the specifications to which these prepared tars are made are the private property of interested firms.

Dehydrated tar is made without difficulty by distilling off carefully all the water (entangled ammoniacal liquor) and with it, of course, the crude naphtha, from a charge of coal tar. After these products have distilled off, the fire is drawn, dampers opened, and the still allowed to rest for a few hours, when the

dehydrated tar may be pumped into a storage tank, railway tank wagons, or filled into barrels. The connexion between the still and the cooler must, of course, be broken, and the tail pipe of the still fitted up to a main connected to a pump ; and also by-passed to a barrel filling stand-pipe. Sometimes tar which has been kept in stock for a considerable time is called dehydrated tar, but in the strict sense this is not a correct term, as this kind of tar will contain a certain percentage of entangled water, in spite of long standing.

As already mentioned, by far the greater quantity of prepared tar is used for road treatment, and therefore chief consideration will be given to it in this connexion. A batch of prepared tar, suitable for road treatment, may be manufactured as follows. Twenty tons of gas tar are charged into a still, and the ammoniacal water, crude naphtha, light oil and middle oil, distilled off, as described on pages 49-51. When the distillate at the worm-end reaches a specific gravity of 1.045 at 60° Fahr. the fires are drawn, or the gas shut off, and the dampers opened. The contents of the still are allowed to stand at rest until the temperature reaches about 250° Fahr. and then 2,300 gallons of heavy creosote of a specific gravity between 1.050 and 1.065, and free from "salts" and water are added. Thorough agitation of the mixture is necessary. The creosote is added by pumping it through the tail pipe of the still, and agitation is brought about by blowing a gentle current of air into the still through the same pipe. A far better plan, and one which will not hold the still up while the half finished material is cooling, is to provide a cylindrical boiler tank of suitable size, as a mixing tank, and run or pump the material from the still into this. It should, of course, be allowed to rest for an hour or two in the still before running off. The mixing tank can be fitted with a mechanical agitator, or the agitation be carried out by blowing air into the material through a perforated pipe. After a thorough mixing, the prepared tar may be pumped into railway tanks or filled into barrels for despatch, or else to a storage tank. As it is often required that the prepared tar be filled into tar spraying machines hot, it is a good plan to place the storage tank in an elevated position, and provide the same with a closed steam coil. By this means it can be run into the spraying machine by force of gravity, and hot. The specific gravity of prepared tars may vary between 1.16 and 1.125 at 60° Fahr.

During the last few years there has been a considerable amount of discussion on the subject of tar preparations for road treatment, and the Road Board issued in April, 1911, a set of general directions and specifications relating to the tar treatment of roads. The chief items in the tar specifications of interest to tar distillers are those which relate to: (a) the source of the tar ; (b) the specific

gravity; (c) freedom from water; (d) fractionation; (e) amount of phenols; (f) free carbon content. Briefly, the specific gravity must be high, the amount of water and phenols soluble in water low, and the free carbon must not be higher than 20 to 21 per cent. If the reader desires further particulars he is referred to the literature on the subject, among which are the publications mentioned in the foot-notes.<sup>1</sup>

A tar for the manufacture of roofing felt may be prepared by distilling a charge of coal tar until the distillate at the worm-end tests 1.050 at 60° Fahr. The distillate which comes over before this point is reached is separated into the usual fractions as already described. The residue is allowed to cool to about 240° Fahr. either in the still or in a suitable mixing tank, and then mixed with creosote of a specific gravity 1.045 at 60° Fahr., in the proportion of 1,750 gallons for very 15 tons of tar distilled.

<sup>1</sup> *General Directions and Specifications relating to the Tar Treatment of Roads, Road Board, Waterlow & Sons, Ltd.*

"Improvements of Highways to meet Modern Condition of Traffic," by T. W. Smith, *Proc. Inst. C.E.* Series 1910-11.

"Up-to-date Roads," by R. O. Wynne Roberts. *Trans. Socy. Engrs.*, May, 1910, vol. 1, No. 5.

"Investigations on Coal Tar and some of its Products," A. R. Warnes and W. B. Southerton. *Trans. Midland Junior Gas Association*, 1912.

## CHAPTER VII

### PLANT FOR RECOVERING CRESYLIC AND CARBOLIC ACIDS FROM OILS

Sulphuric acid process—washers—storage tanks—springing tank—CO<sub>2</sub> process—carbonating boilers—phenolate tanks—pump and sump—reaction towers—divider tanks—receivers for tar acids—receivers for spent liquor—finishing tank—acid egg—storage tanks—CO<sub>2</sub> gas—CO<sub>2</sub> furnaces—purifying and washing towers—water separator—causticizing plant—causticizers—storage tanks—filters—pump—evaporators—cresylic acid—still charging tank—still—fractionating tower—condenser—“bottoms” receiver—pitch bay—cresylic and carbolic receivers—air blowing tank.

THERE are two methods in general use for the recovering of phenols from tar distillates: (a) The sulphuric acid process, in which moderately dilute sulphuric acid is used to decompose the solution of phenolates—known technically as “carbolate” and “cresylate”—and the resulting sodium sulphate run to the drain, the phenols only being recovered; and (b) the CO<sub>2</sub> process, in which carbonic acid gas is employed to decompose the “carbolate” or “cresylate,” the resulting sodium carbonate being converted into caustic soda by causticization, and used for extracting a further quantity of tar acids. The latter process is sometimes known as the “continuous process,” and is much more economical to work than the former, although the initial outlay for plant is somewhat greater.

Washing tanks, generally known as washers, are required for both processes. These tanks may have a total capacity of 3,500 to 4,500 gallons, and in shape are generally cylindrical; sometimes round-bottomed trough-shaped tanks are used. The cylindrical washers are placed in a horizontal or vertical position. If in the former position, the washer should be tilted a little towards the outlet, but if in the latter, it should be provided with a dish or shallow cone-shaped bottom. A cone-shaped bottom will give the best results as regards draining. Horizontal washers are provided with a shaft on which are fitted agitating arms, and the journals of which pass through stuffing boxes let in each end of the washer. Good second-hand boilers, from which the tubes have been drawn, and the ends blanked, make excellent washers. Vertical washers may be fitted with an archimedean

screw agitator, or wing agitators, on a horizontal or vertical shaft. If an agitator of the latter type is used in the vertical position it is advisable to fit several fixed arms on the side of the apparatus. It is policy to cover the vertical and also the horizontal trough-shaped washers, and a manhole and lid must be provided. A useful piece of apparatus to use in connexion with the washer is an oil separator. This is similar in pattern to the divider box described on page 38, Fig. 31, but it is often made a little larger. It is useful to separate any oil from the final runnings and drainings of "carbolate" or "cresylate"; a matter of some importance. Any oil which may come with the ammoniacal liquor which it is sometimes necessary to draw off before commencing a wash, may be recovered if this apparatus is used.

With the exception of "carbolate" and "cresylate" storage tanks, which may be of any shape and size to suit circumstances, a "springing" tank is the only other piece of plant required in the sulphuric acid process. The "springing tank" may be constructed of wrought-iron plate, but even if care is used in conducting the process, some corrosion of the plates, and, if mechanical agitators are fitted to the tank, of the agitators, will take place. Lead-lined iron or wooden vessels are more suitable for this part of the process. It is now possible to obtain iron vessels homogeneously coated with lead, covered, and provided with an agitator. A vessel of this kind is very suitable for the "springing" of carbolate. Covered tanks provided with mechanical agitators are safer to use than uncovered tanks, the contents of which are agitated by hand. Wooden agitators are usually employed for hand agitation. The shape of a "springing" tank may be cylindrical, or like a round-bottomed trough. Cylindrical tanks may be placed horizontally or vertically. If in the latter position, and this is really the best, a dished or cone bottom should be fitted to the tank. This will allow of a better draining of the tank from the sodium sulphate liquor which separates after "springing." The cock fitted to the bottom of the tank to run off the contents should be made of acid-resisting metal, such as regulus metal, for preference. Some people prefer to skim the tar acids off the surface of the sulphate liquor, but this is not so cleanly as running the lot off from a bottom cock. The capacity of a "springing" tank may vary between 1,000 and 2,000 gallons; sometimes even greater, but a good average figure may be taken as 1,500 gallons.

For working the  $\text{CO}_2$  process more plant of a somewhat complicated nature is required than that just described for the sulphuric acid process. In addition to the washing tanks, the following are necessary: Two "carbolate" or "cresylate" boilers, a pump and suction sump, a reaction tower, two dividing tanks, a receiving tank for the tar acids, a receiver for the spent



liquor (impure carbonate of soda solution), one finishing tank, one acid egg, one furnace for generating  $\text{CO}_2$ , a dust separating apparatus and tower for purifying and washing the  $\text{CO}_2$ , and the necessary pipe lines and arrangement for removing the water which sometimes separates from the gas. The gas may be drawn through the apparatus by the employment of a steam jet. According to the requirements of the Alkali Act, the spent gas must be purified before passing to the atmosphere. This can be done by putting it through one or other of the well-known purifiers, and then allowing to escape say into the chimney stack, or it may be passed over the steam boiler fires, after travelling through a seal pot, as described when dealing with foul gas mains, pages 39-40, Fig. 33.

Instead of employing a reaction tower, some distillers prefer to put in what are known as carbonating boilers. The number of these boilers required will vary according to the volume of "carbolate" to be dealt with. It is advisable to put in at least four. No divider boxes, receivers, or pump and sump, are necessary if carbonating boilers are used. Of course a pump for removing the spent liquor is required in both cases. The  $\text{CO}_2$  is forced through the "carbolate" or "cresylate" *via* perforated coils, by means of a compression pump, and the acids which separate are either removed from the boilers by means of skimmer pipes, or the contents of the boilers are run into tanks with open tops, and after standing for a sufficient time, the acids are removed by skimmer pipes.

Dealing with the  $\text{CO}_2$  process, in which a reaction or carbonating tower is used, the pieces of plant named on page 60 will be described in the order given.

The "carbolate" or "cresylate" tanks are constructed of wrought-iron plates. Old second-hand cylindrical boilers, with the tubes drawn and the end blanked, make excellent tanks for this purpose. A hole is cut in the top to admit a  $1\frac{1}{2}$  or 2-inch inlet pipe, two smaller holes are cut, one for the admission of a 1-inch steam pipe, to which is connected a double-lap closed steam coil, and the other to allow the exit of the exhaust pipe of this coil. Both these holes should be at the top of the boiler-tank also. The manhole and cover are allowed to remain; a manhole is sometimes useful for cleaning or inspection purposes. At one end of the boiler tank a  $1\frac{1}{2}$ -inch hole is cut, the centre of which should be  $3\frac{3}{4}$  inches from the bottom of the tank, and a  $1\frac{1}{2}$ -inch pipe is fitted by means of a flange. This pipe is to conduct the phenolates to the pump sump. A cast-iron gland cock is fitted near the end of the pipe to regulate the flow into the sump, and it is a good plan to fit a further cock a few inches from the tank as a safeguard in case of accident. It is a good plan to arrange for a steam connexion into this pipe in order to assist in removing

any obstructions which may occur, and provision for the insertion of an open steam end into the tank is an advantage. At the opposite end of the boiler-tank a small mud-hole 6 inches by 4 inches should be cut. The lower edge of the hole must be as near the bottom as possible. A casting should be riveted on to carry the mud-hole cover. Both tank-boilers may rest on 14-inch to 18-inch brick cradles, just a few inches above the ground level. The capacity of these tanks will vary, of course, according to the quantity of tar acids it is desired to make per day.

The pump may be of any good make, and the delivery vary between 1 inch to  $1\frac{1}{2}$  inches according to circumstances. It is erected a few inches from the ground level, in close proximity to the sump. A cast-iron vessel, about 2 feet deep and 1 foot in diameter, makes a suitable sump; a wrought-iron steam boiler dome will answer admirably. The sump is situated so that the top rises about 3 inches from the ground level, and if out-of-doors, a wooden cover should be provided to keep rain out. A few inches of puddle should be put in the hole before placing the sump into position.

There are two chief types of reaction or carbonating tower: the packed and the plate. The latter kind of tower is built up of cast-iron sections, while the former is constructed of wrought-iron plates. One of the best designs of plate tower is illustrated in Fig. 38. Naturally the size of the tower will vary according to the quantity of phenolate it is desired to decompose per diem. It may be approximately 15 feet high and 2 feet in diameter, the sections being  $8\frac{1}{2}$  inches deep over all. The number of dispersers in each section will vary according to its diameter. In a section of 2 feet diameter 8 may be put in, the inlets to the dispersers being  $1\frac{1}{2}$  inches internal diameter and the diameter of the disperser hoods 4 inches. Each hood should have 12 by  $\frac{1}{2}$ -inch openings in the circle. Only one internal drainpipe of  $1\frac{1}{2}$ -inch bore is necessary for each section. This pipe should be arranged to allow a seal of  $1\frac{3}{4}$  inches of liquid on each plate. It is an advantage to provide an inlet for a steampipe so that the tower may be steamed out occasionally. The positions of the gas inlet and outlet, and also of the outlet for the spent liquor and tar acids, are shown in Fig. 38.

A packed reaction or carbonating tower is filled with foundry coke, earthenware balls, tiles, or one of the numerous patent tower packings. To pack a tower for this kind of work with coke is in the writer's opinion a mistake; the coke soon becomes clogged and the available reaction surface is thereby much reduced. Often it clogs into hard masses, leaving fairly large holes here and there, called "rat holes" up which the gas travels, coming in contact with only the outside portions of moderately

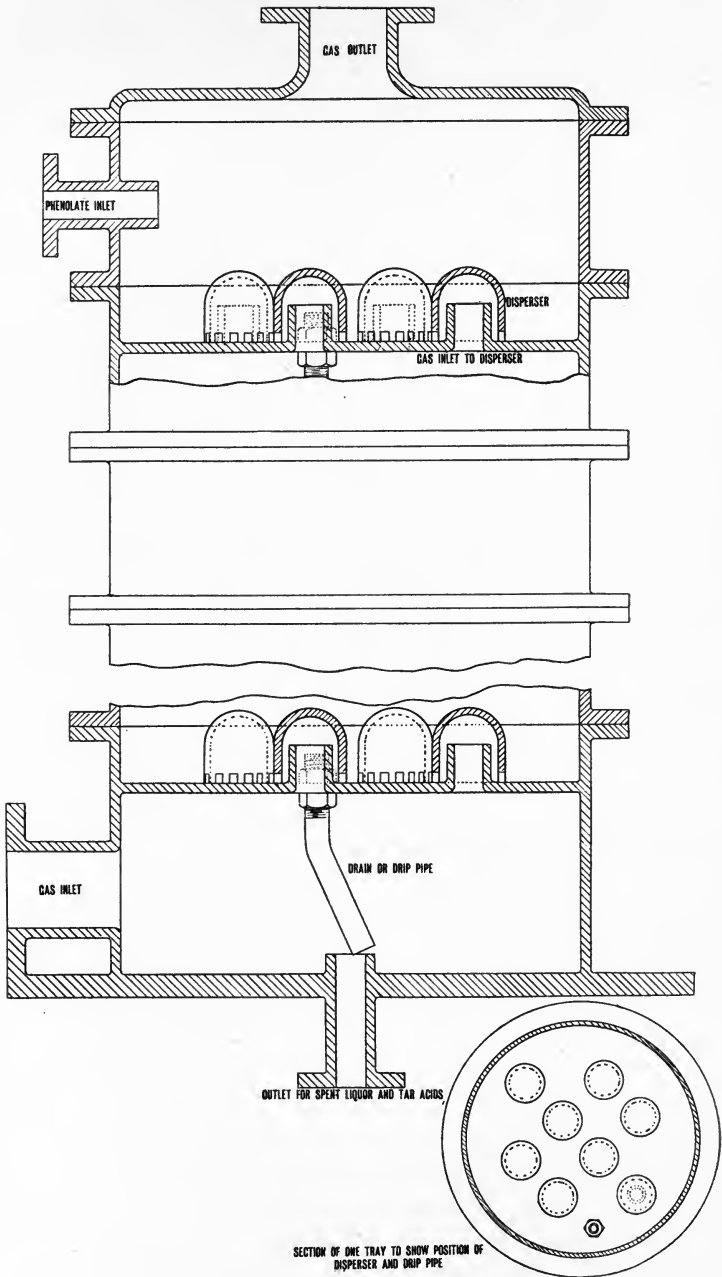

FIG. 38.—Carbonating or Reaction Tower—Plate Type.

thick streams of liquid flowing in the opposite direction. Earthenware balls alone, or with small granite chips, in the writer's hands, have given excellent results. In choosing a packing for a reaction tower of this kind, due regard should be given to the question of reaction surface; the greater this is the more rapid will be the decomposition. Three-inch earthenware balls with  $\frac{1}{2}$ -inch hole give approximately 14.5 square feet of reaction surface per cubic foot of tower space; 2-inch balls with  $\frac{1}{2}$ -inch hole, 23.3 square feet; and 1-inch balls with no hole, 37.3 square feet. Small granite chips, about 1 inch by  $\frac{1}{2}$  inch by  $\frac{1}{2}$  inch approximately, will give a very considerable reaction surface; about 100 square feet per cubic foot of tower space may be taken as a guide. A tower to deal with 2,500 gallons of phenolate solution, containing 20 per cent. of tar acids, per 24 hours would require to be about 13 feet high, and 4 feet in diameter if packed with 1-inch balls with no hole, or if 2-inch balls with  $\frac{1}{2}$ -inch hole are used, the height of the tower may be 22 feet and the diameter 4 feet. If packed with 3-inch balls with  $\frac{1}{2}$ -inch hole, a height of 27 feet and a diameter of 4 feet 6 inches would be necessary, or if say 4 feet of small granite chips and 18 feet of 3-inch balls were used as packing, then the height of the tower could be reduced to 25 feet, the diameter remaining the same. These figures are given as a guide, and may of course be varied according to requirements. The wrought-iron plates of which the tower is constructed need not be thicker than  $\frac{3}{8}$ -inch;  $\frac{1}{4}$ -inch plates are often used. If balls and granite chips are used together, two perforated plates are required, one as a false bottom, and the other to rest on the top of the balls to support the granite chips. If balls are used alone, then one plate for the false bottom is all that is necessary. The plate

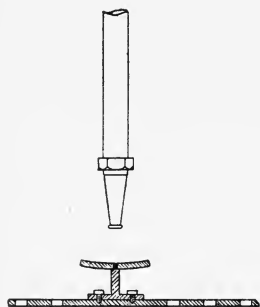

FIG. 39.—Gurney's Jet arranged for Carbonating Tower.

for the false bottom should be  $\frac{3}{4}$  inch to 1 inch thick with  $\frac{1}{2}$ -inch holes at 1-inch pitch, and supported on cross-bars, but the top plate need not be more than  $\frac{1}{4}$  inch thick, the holes being of the same diameter and at the same pitch. Cast-iron is the best metal to use. In the top or cover plate of the tower, a 4-inch hole should be cut for the gas outlet pipe, a hole for a manhole of the usual size, and one for the phenolate delivery pipe, which latter leads to a spray arrangement. A 4-inch gas inlet is made with the centre at least 5 inches from the bottom of the tower, also an inlet for a 1-inch steam pipe to admit steam for steaming out the tower occasionally, and in the bottom plate an outlet, about  $1\frac{1}{2}$

inches, is provided for the pipe which conducts the mixture of spent liquor and tar acids to the divider tank. The spray arrangement may be of the Gurney type (see Fig. 39), or built up of a 6-way piece connected to the delivery pipe inside the tower, and into which are screwed 6 lengths of  $\frac{1}{2}$ -inch wrought-iron pipe, about 12 inches long, and perforated with  $\frac{1}{4}$ -inch holes on the under side at a pitch of approximately 3 inches. Details of the method of packing this type of tower, and the arrangement of the pipes, are shown in Fig. 40.

The divider tanks are made of wrought-iron and much larger than those used in the tar distilling plant. They are generally constructed square in plan, and the depth nearly twice that of one side. An average size is 2 feet 3 inches by 2 feet 3 inches by 4 feet deep,  $\frac{1}{4}$ -inch wrought-iron plate being used, and an angle rim placed outside. The seams must be thoroughly well caulked. One divider tank is set about 9 inches higher than the other, and the outlet to the tar acid receiver is connected to a movable syphon pipe. The

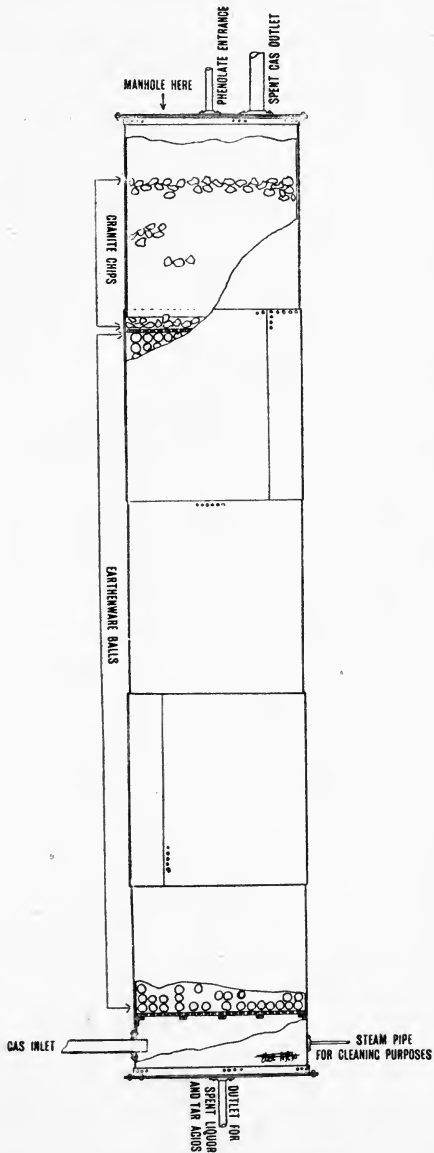

FIG. 40.—A Cylindrical Carbonating Tower, Packed Type.  
F

lower tank is really a catch tank, which retains any tar acids escaping from the divider. Reference to Fig. 41 will give the method of fixing and other details.

A wrought-iron riveted tank, square, rectangular or cylindrical in shape, may be used for the tar acid receiver. It should be placed near the divider tanks, and, if in the open air, covered in, a lid being provided in the cover in order to make inspections. The outlet pipe is with advantage connected with a movable skimmer pipe, as generally on standing some spent liquor separates from the tar acids and settles to the bottom. In order to facilitate

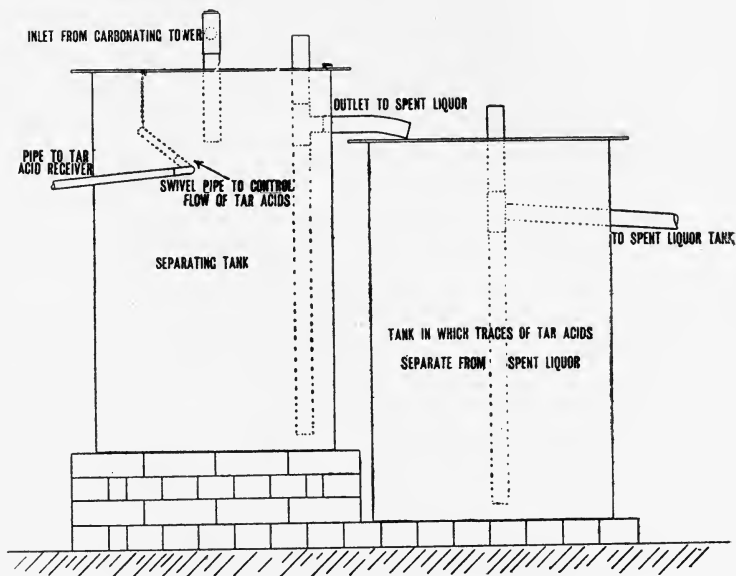

FIG. 41.—Divider Tanks, CO<sub>2</sub> Tar Acid Recovery Process.

this separation, and thus save some sulphuric acid, a closed steam coil may be placed at the bottom of the tank and fed with exhaust steam. The tar acids should be kept at a temperature not exceeding 75° Fahr. As regards the size of the tank, this will of course vary according to the volume of tar acids it is desired to deal with per day. The tank may be erected on the ground level, or raised several inches, according to circumstances.

The receiver for spent liquor should be of wrought-iron, and a good quality second-hand steam boiler, with the tubes drawn and the ends blanked, answers admirably. It should be placed partly or wholly below the ground level, according to circum-

stances. The hole must be lined with well-made puddle before putting the tank in. A manhole with tight cover, a dipping pipe which also makes an air vent, and holes for inlet pipe and suction pipe, are required. The dipping pipe should reach about 9 to 12 inches above the ground level, and need only be  $\frac{3}{4}$ -inch internal diameter, the inlet pipe hole  $1\frac{1}{2}$  inches, and the suction pipe 2 inches. If the tank is only partly below ground, the dipping pipe is not necessary, a  $\frac{3}{4}$ -inch hole will suffice.

A lead-lined tank must be put in for the purpose of carrying out the finishing operation. The tank may be rectangular or square in plan, and built of well creosoted timber, lined on the inside with stout "chemical" lead. Five or seven pound lead is quite thick enough. There is no need to provide for any openings in this tank, as the finished acids can be most conveniently removed to the acid egg by means of an ever-ready syphon (Fig. 42). The tank should be placed as near to the acid receivers as possible and on the ground level.

The acid egg may be constructed of cast-iron, wrought-iron or lead. Of the three metals, lead is the least likely to suffer from corrosion, but to construct a large egg, say of a capacity of 150–200 gallons, is an expensive matter. Cast-iron is liable to fracture, and in the writer's opinion a wrought-iron egg will give excellent results and suffer very little corrosion if properly managed. There is no difficulty in making a wrought-iron egg of large size, and it is cheap. If the ends are well dished, there is no need to put in a central stay, which is of course

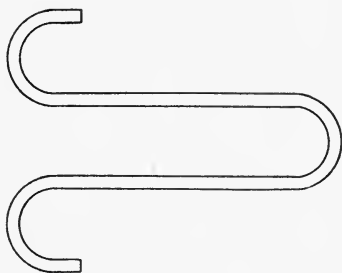

FIG. 42.—Ever-ready Syphon.

necessary if the egg is made with flat ends. The egg should be provided with a pressure gauge, a safety valve, a 6-inch circular hole, with strengthening ring and draw-up manlid, a 1-inch air inlet, the pipe just entering, a  $1\frac{1}{2}$ -inch or 2-inch outlet pipe, which should reach to within  $1\frac{1}{2}$  inches from the bottom of the egg, and a 1-inch drain cock. For the position of the various fittings, reference to Fig. 43 should be made. The egg should be placed below ground immediately under the finishing tank, and a brick-lined sump should be made under the drain cock as shown in Fig. 43. When setting the egg, a fall of 4 inches in 10 feet towards the drain cock should be allowed. As already mentioned, the tar acids are transferred from the finishing tank to the acid egg by an ever-ready syphon; this piece of apparatus is illustrated in Fig. 42.

The tar acids may be stored in wrought-iron tanks of any convenient shape and size, they should be covered in and a manhole and lid provided. A  $1\frac{1}{2}$ -inch drain cock of cast-iron should be fitted on the bottom of the tank, and the cock to be used for emptying purposes must be fitted on the side with its centre line 4 inches from the bottom of the tank. It should be a 2-inch cast-iron gland cock. Storage tanks may be supported on brick or concrete piers, at a convenient height for filling barrels. Arrangements should be made for connecting the emptying cock with mains for filling railway tanks or tank boats. Also for connecting

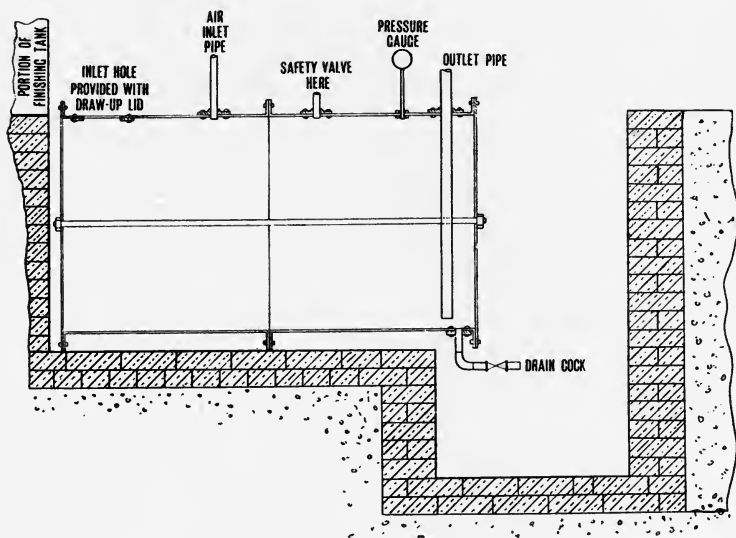

FIG. 43.—Egg for use on Carbolic Plant, etc.

up to a steam supply in order that an open steam end may be inserted into the tank to steam it out when it requires cleaning.

In the  $\text{CO}_2$  process, one of the most important pieces of apparatus is that from which the supply of carbonic acid gas is drawn. Sometimes the waste gases from the flues of a steam boiler, under which coke is burnt, are used, after purifying, for this purpose. This method cannot be recommended. The same may be said of the method of using waste gases from an ammonia distilling apparatus. Undoubtedly the best plan is to employ a special furnace, built just the right size to supply the plant with sufficient purified gas, when it is working under full pressure.

There are several patent  $\text{CO}_2$  furnaces put on the market



by various makers, but it may be preferred to build one's own furnace. Three chief designs of furnace exist: the flat or dead hearth; the firegrate, in which the coke is burnt on firebars; and the water-bosh or water-sealed furnace. In the first type of furnace, the fuel is fed to the fire at the top, and in burning it rests on the firebrick bottom of the furnace. A cast-iron door about 18 inches by 10 inches is put in on a level with the bottom of the furnace, on the front of which is an air grid to regulate the admission of air, and through which the clinker is withdrawn. The gas is taken off from the top of the furnace. With this type of furnace, trouble often arises with the air regulation, the fire burns very uneven, and during the cleaning or clinkering process much unburnt coke is withdrawn with the clinker, and the uniformity of the gas is upset for an inordinate length of time. The clinker is often considerable. In the second type of furnace the air regulation is under better control, especially if the ash-pit is closed by a door, on the face of which air grids are fitted. The fire burns much more even, but unless the bars are water-cooled they are rapidly burned away; even when they are cooled with water, a good deal of trouble is experienced in this direction, and during the removal of the clinker much excess of cold air is admitted to the furnace.

The last type of furnace is, in the writer's opinion, the best. Two furnaces which he designed, and which varied somewhat in detail, both yielded excellent results. They gave very little trouble as regards clinker, and no trouble due to excessive air admission and its resulting uneven quality of gas during cleaning. The fuel is fed in from the top *via* a hopper and bell valve, and the poking down carried out through poking holes. Ashes, with very little clinker, are removed through the water seal or bosh. The gas is drawn off through a firebrick-lined flue in the side of the furnace near the top. This flue bends round in such a fashion that the position of the exit is at the furnace top, and there it is connected with a cast-iron gas-pipe. Air inlets are provided at each of the four sides of the furnace, and they are made so that the quantity of air can be regulated by slides running in frames built in the brickwork. The furnace is lined with best ganister brick; when working properly, the temperature of the furnace is so great as to fuse most, if not all, qualities of firebrick. A staging, supported on brackets, is fitted round the top of the furnace; this is for the man to work upon. The furnace top is also covered with a cast-iron plate. It is advisable to strengthen the furnace with light backstaves and tie-rods. Fig. 44 will show the shape and many details associated with this type of furnace.

As the gas leaves the furnace it carries with it a fair amount of dust, and also impurities such as sulphur dioxide and sulphuretted hydrogen, together with some moisture. These it is necessary

to separate as far as possible before the gas enters the reaction tower, or if carbonators are used, these vessels. The dust must be separated first, and then the gaseous impurities, and finally

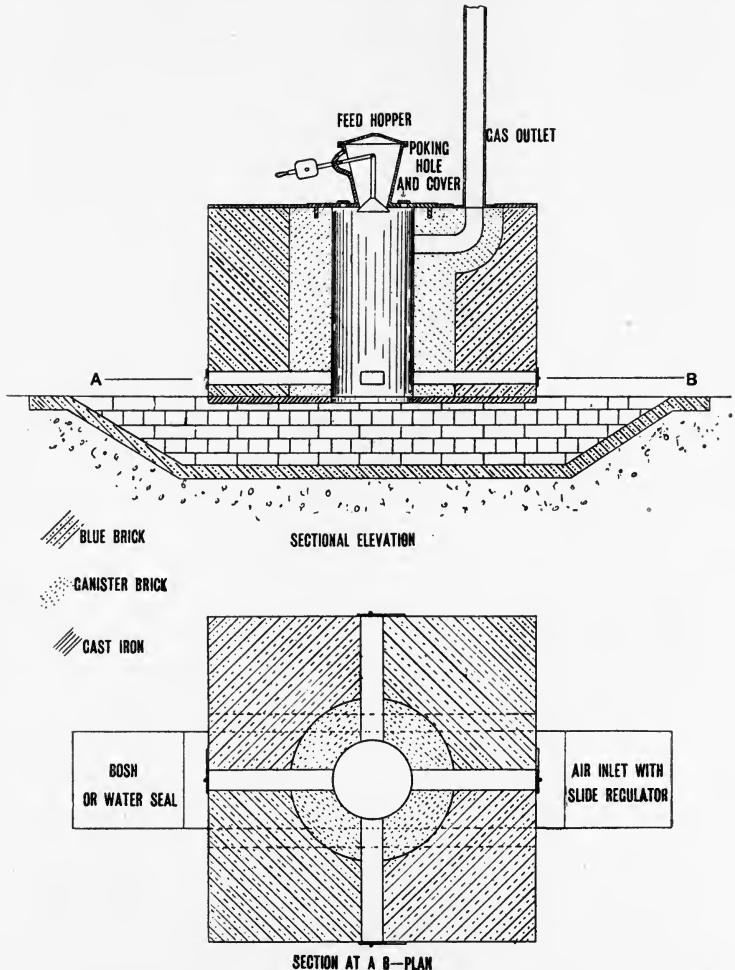

FIG. 44.—One Type of Furnace for Generation of CO<sub>2</sub>.

as much of the moisture as possible. A dust separator may be built in the bottom portion of the washing and purifying tower, or erected as a separate piece of apparatus. It should be of cast-iron. A simple and yet efficacious piece of apparatus for

carrying out the dust separating operation is shown in Fig. 45, and Fig. 46 shows one built in the bottom of a purifying tower.

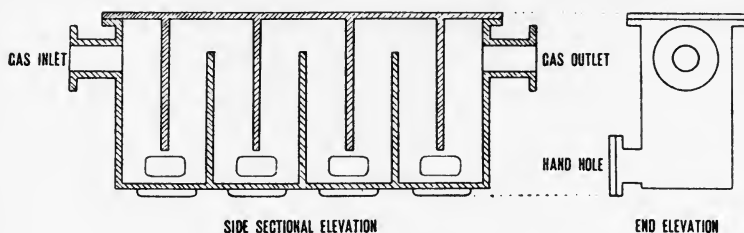

FIG. 45.—Dust Separator.

If the dust separator is erected as a separate piece of apparatus, it must be placed between the furnace and purifying tower.

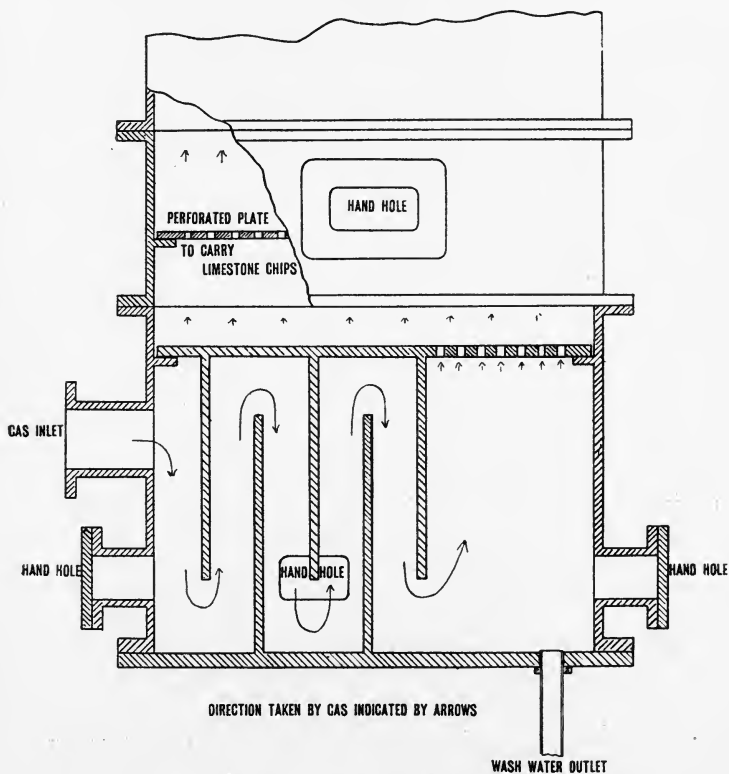

FIG. 46.—Purifying Tower with Dust Separator built in bottom.

The purifying or washing tower (Fig. 47), is best constructed of cast-iron sections, square or round in plan. If round, each section should be about 3 feet in diameter, and if square, about 2 feet 6 inches by 2 feet 6 inches. In either case, each section should be 12 inches deep.

Each section carries a grid, supported on a ridge cast on the section (see Fig. 47). The grids may be of wood or mild steel; the writer is inclined towards the use of mild steel, as in his experience the amount of corrosion is exceedingly small. Wooden grids eventually become soft and rotten. Mild steel grids should be of  $\frac{1}{2}$ -inch plate drilled with  $\frac{7}{16}$ -inch holes at 1-inch pitch. Each grid should be covered with a layer of limestone chips about  $1\frac{1}{2}$ -inch size, to a depth between 5 and 6 inches. A hand hole is made in each section, the lower portion of which must be on a level with the top of the grid or tray. The number of sections in the tower will vary according to the quantity of gas passing through it per day. For a plant burning 800 lbs. of coke per 24 hours, a tower of 8 sections 2 feet 6 inches square will prove quite suitable.

The bottom section has no grid, but should have a hand hole, and into this section the gas enters by a 4-inch cast-iron pipe, the centre line of which is 6 inches from the bottom of

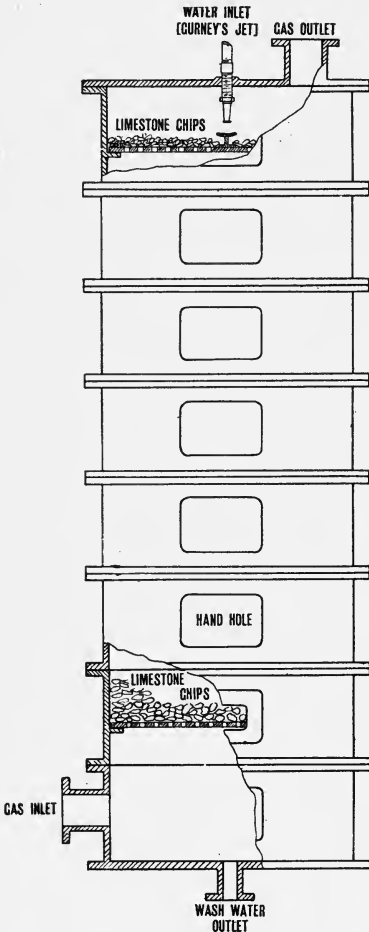

FIG. 47.—Diagram illustrating a Type of Purifying Tower without Dust Separator.

the section. A 1-inch or  $1\frac{1}{2}$ -inch exit for wash water is provided for in the bottom of the section. To the top section is fitted a 4-inch cast-iron gas outlet pipe, and also a 1-inch water inlet. The water is distributed over the top grid by means of a

Gurney's jet (Fig. 39). In order that the gas pipes conducting the purified gas from the washing tower can be cleared of any obstruction which may occur—and obstructions have occurred occasionally in the writer's experience—they are fitted with four-way pieces arranged as shown in Fig. 48, the removal of the blank flanges making it easy to shift the obstruction.

To remove the water which condenses out of the gas (especially in the cold weather) and settles in the lowest portion of the gas main, the following simple plan devised by the writer may be used. The gas-pipe is allowed a gentle fall until it reaches to within about 14 feet from the point of entry into the carbonating tower, or first carbonating boiler. A flat U bend is made in the pipe, and in the lower end of this, about the middle, and underneath the pipe, a  $\frac{3}{4}$ -inch hole is drilled. Into this hole is inserted a cork, into which is fitted a piece of  $\frac{1}{4}$ -inch bore glass tube, bent as shown in Fig. 48. The depth of the U is made so that it just allows the water in it to resist the pull on the plant without being

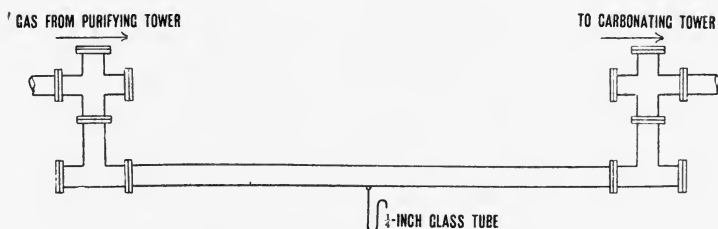

FIG. 48.—U Bend to separate Water from Gas.

drawn out of the tube. Immediately any water collects in the gas pipe, it is automatically removed by the glass U tube without the seal being broken and the admission of air.

In the  $\text{CO}_2$  process, the spent liquor, which is really an impure solution of carbonate of soda, is converted into caustic soda by causticizing with lime. The pieces of plant required for carrying out this process are: two or three causticizers, two caustic soda tanks, a filter, a pump and an evaporator. These pieces of plant will be described briefly in the order given.

The causticizing tanks are cylindrical and built of wrought-iron or mild steel plates. They may be horizontal or vertical; the latter is the best type to use. Each tank is fitted with a mechanical agitator, an open and closed steam coil, a skimmer pipe, a grid or basket made of bar iron, at the top if of the vertical type, and a gate or treacle valve having a 6-inch opening on the bottom. Causticizers will vary in size according to the volume of caustic soda required per diem. They should be

erected above ground, best on rolled steel joists and stanchions, and above the filter. A water supply should be arranged for over each causticizer.

It is advisable to put in two caustic soda tanks, one for strong caustic soda from the causticizers, and the other for weak caustic soda or "weaks"—the washings of the lime mud from the causticizers and the filter. These tanks may be square or rectangular in shape, according to circumstances, and constructed of mild steel plates, the seams being thoroughly caulked. A suction pipe which can be raised and lowered should be fitted to each tank. They should be erected on the floor level, as close to the causticizers as possible.

The filter is situated immediately under the causticizers, and should be of such a size that it will hold the lime mud from all the causticizers at the same time. It is constructed of mild steel plates, and it is best built rectangular in plan. The seams should be thoroughly well caulked, and on one side as near the bottom as possible a 2-inch suction pipe should be fitted. Two sets of perforated plates are required: one to form the base of the filter bed, and the other to cover the top. These plates are of mild steel,  $\frac{1}{4}$  inch thick, and drilled with  $\frac{1}{2}$ -inch holes at a pitch of 2 inches. The bottom set of plates are laid on Staffordshire blue bricks at a height of 6 inches, arranged in rows 18 inches apart, on the bottom of the filter. An excellent filter bed is made by using graded granite chips, and a top layer of coke breeze, upon which the other set of perforated plates are placed. The thickness of each layer of granite chips and the approximate sizes, are as follows: On the bed plates a layer of  $1\frac{1}{2}$ -inch to 2-inch chips 4 inches deep is placed; then a 3-inch layer of  $1\frac{1}{2}$ -inch to 1-inch chips; then a 3-inch layer of  $\frac{1}{2}$ -inch to  $\frac{3}{4}$ -inch; and then a 3-inch layer of  $\frac{1}{4}$ -inch and  $\frac{1}{8}$ -inch chips, above which a 2-inch layer of coke breeze is placed.

Any good pump of the ram type may be connected up to the outlet at the bottom of the filter. The pump should have a 2-inch suction, and the glands on the water end should be packed carefully with "ammonia" packing. This packing is the least attacked by the weak caustic liquor. The pump not only assists in the filtering operation, but pumps the weak caustic liquors, washings, and filtrate, into the evaporator. A connexion with the "weaks" tank to the pump suction is made by a by-pass.

If considerable quantities of weak caustic liquor have to be concentrated, then it would be advisable to put in a vacuum evaporator and its appurtenances, using exhaust steam as the heating medium. However, this is seldom necessary in a tar distillery. The usual method is to cover the bottom of a tank of suitable size with a series of coils of 2-inch or 3-inch steam-pipe. A reliable type of steam trap should be fitted on the exhaust end

of the coils. To get the best results, the "weaks" should be allowed to stand as long as possible, in order to deposit any lime mud suspended in it. This mud will, if it gets into the evaporator, coat the coils and thus hinder the rate of evaporation. In any case it is as well to occasionally clean the steam coils by scraping them, and then washing down. The evaporator should be erected on rolled steel joists and stanchions for preference, and at a height above the ground level which will permit of the concentrated caustic liquor running into the storage tank by force of gravity. Fig. 49 illustrates diagrammatically one method of arranging a causticizing plant.

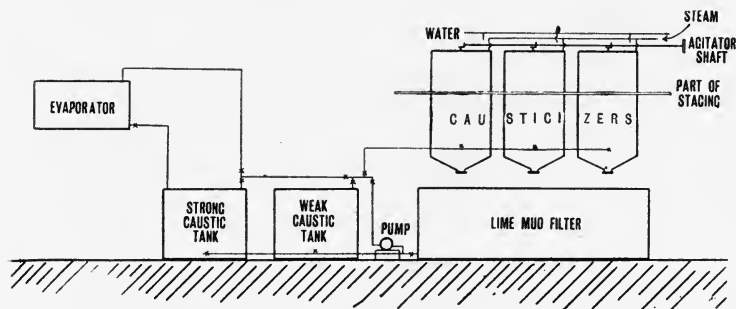

FIG. 49.—Diagram showing one method of arranging Causticizing Plant.

If it is desired to manufacture 95-97 per cent. cresylic acid, then it is necessary to submit the crude, as it comes from the carbonating tower, to a process of distillation and air blowing. The pieces of plant required to carry out the manufacture of this kind of cresylic acid are as follows: A still charging tank, a mild steel still with a fractionating column, a condenser coil and tank, collecting box, water separator, bottoms receiver, pitch bay, cresylic and carbolic receivers, acid egg and blowing boiler, and foul gas mains.

It is very convenient to erect the undistilled crude cresylic storage tank at a higher level than the still top and in close proximity thereto. By doing so the still can be charged by force of gravity, and only one passage through the acid egg is necessary; two would be required if the storage tank is placed at a low level. The tank may be of any convenient shape, constructed of mild steel plate, covered in and provided with manhole and lid. An inlet pipe and dipping hole are put into the top, and the outlet pipe for charging the still is placed on the side, its centre line being 4 inches from the bottom. A very convenient diameter for the charge and inlet pipe is 2 inches. It is advisable to put a 1-inch drain cock in the bottom of the tank,

through which any sodium sulphate liquor which separates may be drained away. The separation of the liquor may be expedited by keeping the acid at a temperature of about 70° Fahr. by means of a small steam coil. Every endeavour should be made to keep this liquor out of the still.

A cresylic still is constructed of mild steel plates throughout, and of a similar shape to a tar still. The fittings, such as man-hole and lid, charge inlet, swan-neck, safety-valve, tail pipe, etc., are also similar to tar still fittings, and the same may be said of the settings, fireplace, flues, etc. The reader is therefore referred to the details given under tar stills in Chapters III. and IV.

As a certain amount of carbolic acid is present in the crude cresylic, and the value of the former is generally greater than that of the latter, it is advisable to separate these by means of a fractionating column. This piece of apparatus is made of cast-iron and built up of sections of approximately 2 feet in diameter and 9 inches in depth. The size varies somewhat according to the type of column, and the height of the same, to a large extent, according to the degree of perfection it is desired to conduct the fractionations. A good average number of sections used in a column is fifteen, and this includes the top and bottom sections. One of the best types of fractionating column is described and illustrated on pages 95-96. The tower is supported on steel stanchions and joists on a convenient portion of the brickwork at the still top. A return pipe is fitted into the underneath portion of the bottom section of the tower, and inserted into the still top, a U bend being made in the pipe to act as a seal. The bottom section is also connected to the swan-neck of the still, and an arrangement is made for by-passing the tower, so that during the water and cresylic stages, the vapours can be conducted direct to the condensing worm. These various details are illustrated diagrammatically in Fig. 50. It is a good plan to arrange that all the sections can be drained after each operation.

The condenser coil and tank are similar to those used with tar stills (see page 36) and so is the collecting box (see page 37). For the separation of the water and tar acids as they run into the collecting box, this piece of apparatus is connected to a separator of the same kind as that described on page 38, but it is arranged for the water to be removed from the top of the separator and the tar acids from the bottom.

After a certain portion of the contents of the still have been worked off, the residue is allowed to cool a little and then run into a tank, known as a bottoms receiver, to be worked up with the "bottoms" from other operations when a sufficient quantity has accumulated. A horizontal boiler tank makes an excellent receiver. It is set below the still run off or tail pipe, and is connected up to the same. Connexion is also made with a pump, or



it is arranged that the receiver can be tightly closed and then emptied by air pressure. In this case it is connected to an air compressor, and an outlet tube is fitted so that it reaches to within about 2 inches from the bottom. As the "bottoms" becomes viscous, it is advisable to put in a closed steam coil of one lap, built of 1-inch wrought-iron pipe, in order to warm them up prior

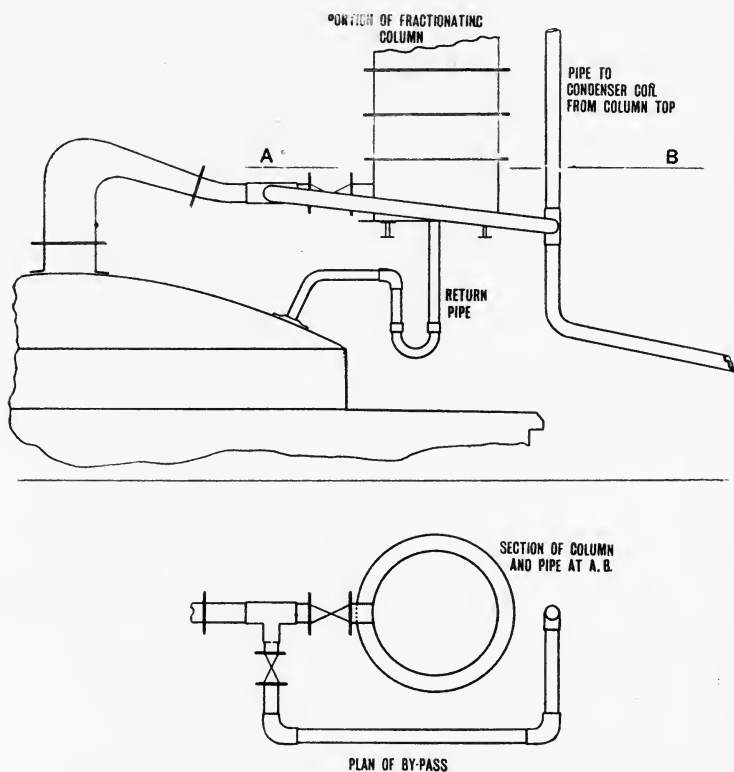

FIG. 50.—Diagram illustrating a method of Attaching Fractionating Column to a Cresylic Still and arranging a By-pass.

to charging them into the still. The receiver should have a man-hole and lid of the usual size.

The "bottoms" are finally worked to pitch, and the pitch is either run off and mixed with a big batch of pitch from the tar stills, or else run into a special bay. If a special bay is desired, it is constructed in a similar manner to the large bays described on page 45, but is of course much smaller. A 4-inch pipe is connected to the tail pipe of the still for running off the pitch,

and by means of a reducing T piece, and the necessary cocks, the "bottoms" pipe, which is 2 inches in diameter, is connected to the pitch pipe.

Receivers for the cresylic and carbolic acid may be constructed of mild steel, and square, rectangular or cylindrical in shape. If the latter, they may be horizontal or vertical, and it is a good plan to arrange so that the contents can be transported by air pressure to storage or mixing tanks, in the case of carbolic, and to an air blowing boiler for purification in the case of cresylic. Square or rectangular tanks are not suitable, if desired to remove their contents by air pressure, and so will have to be connected up to a pump or egg.

Cresylic acid from the still generally contains sulphuretted hydrogen and other sulphur compounds in sufficient quantity to render it foul in smell. It is necessary to sweeten the acid before dispatching to customers, and this process is carried out in a large cylindrical boiler tank, placed in a horizontal position. Along the bottom of this tank is fitted a perforated coil of 1-inch wrought-iron tubing, through which air is passed during the operation. The top of the tank is connected to a 2-inch foul gas main, which, in its turn, is connected with a purifier or a seal pot and ejector. In the latter case the gas is burned underneath the steam boilers, and the ejector may be employed to draw air through the cresylic acid in the tank by leaving an open end on the upright length of the coil, just a little above the point at which it enters the boiler. The foul gas may of course be drawn through the purifier by an ejector and the same method of air-blowing the cresylic employed. If an ejector is not used, it is necessary to connect the perforated air coil to an air compressor. It is as well to provide this tank with a manhole and lid of the usual dimensions. An inlet pipe is also required, and so is an outlet pipe, with cast-iron cock, through which barrels are filled. A by-pass should be connected to the outlet, so that when it is desired to load the acid into a railway tank wagon, it can be run into an egg, and then filled into the wagon by means of air pressure. A suitable kind of egg has already been described on page 68.

## CHAPTER VIII

### THE RECOVERY OF CARBOLIC AND CRESYLIC ACIDS

Crude carbolic and cresylic acids—causticizing soda ash and "spent liquor"—washing oils for tar acids—interchange process—recovery of tar acids from phenolate—sulphuric acid process—CO<sub>2</sub> process—distillation of "sprung" cresylic acid—air-blowing distilled cresylic acid.

CRUDE carbolic and cresylic acids are a source of considerable income to the tar distiller, and in all well regulated works every care is exercised to recover the maximum amount of each from the tar distillates in which they exist. These two articles consist of mixture of phenols, chiefly of the monohydric series, of which phenol or carbolic acid (C<sub>6</sub>H<sub>5</sub>·OH) is the first. The next in the series are the three isomeric cresols (C<sub>6</sub>H<sub>4</sub>CH<sub>3</sub>·OH). Owing to the presence of the C<sub>6</sub>H<sub>5</sub> radicle the ·OH group (hydroxyl) possesses slight acid properties (its basic character being somewhat modified), and on this account reacts with the caustic alkalis, forming salts known as phenolates. One of them which is of importance to the tar distiller is known as sodium phenate, and is formed by interaction with caustic soda (NaOH). It is represented by the formula C<sub>6</sub>H<sub>5</sub>ONa, and the reaction is indicated by the following equation—

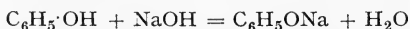

In the process of recovering tar acids from the distillates which contain them, a solution of caustic soda is used, the strength of which varies somewhat according to the kind of acid to be extracted, or the process employed. The caustic soda is sometimes made at the tar works and concentrated by evaporation, and in those works employing the CO<sub>2</sub> process, the manufacture of caustic soda (causticizing of the spent liquors) is an everyday occurrence. On this account a description of the process of causticizing soda ash and spent liquors will be given, before dealing with the recovery processes.

The best quality of soda ash (sodium carbonate) to use is that known as 58 per cent. alkali. This contains on an average 98.75 per cent. of actual sodium carbonate (Na<sub>2</sub>CO<sub>3</sub>). In the process of converting this material into caustic soda (technically, causticiz-

ing) quicklime of a high grade is employed ; the best lime for the purpose is white Buxton lime. Theoretically the reaction which takes place is shown in the following equation—

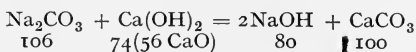

In practice it is necessary to use between 10 and 15 per cent. of lime above the theoretical quantity. The reaction is a reversible one, and, to obtain the best results, the soda-ash solution must be as dilute as possible. Using an ash solution of 20–22° Tw. (1.10–1.11 sp. gr.), the amount of sodium carbonate causticized will be between 95 and 97 per cent. Some prefer to add slaked lime to the ash solution, but in the writer's opinion it is far better to employ quicklime and make use of the heat generated during its hydration to assist in the causticizing of the sodium carbonate.

The process is carried out as follows: Water is run into the causticizer until it reaches within a few inches of the bottom of the lime grid. Open steam is turned on as soon as the coil is well covered and steam is allowed to pass during the remainder of the time of charging, and until the water practically reaches its boiling point. The desired amount of soda ash is added to the water, commencing as soon as signs of ebullition appear, care being taken not to add more ash than is necessary to give a specific gravity of 1.11 (22° Tw.) at 60° Fahr. It is an easy matter to calculate this amount for any size of causticizer, once and for all, from the figures obtained by carrying out a small experiment in the chemical laboratory. The ash solution should cover the bottom bars of the grid about one inch, and while at a temperature of about 198° Fahr. the lumps of caustic lime should be thrown into the grid, a few shovelfuls at a time, until the calculated quantity has been added. Let each lot of lime "break down" and wash out of the grid before adding a further quantity. Keep the agitator running slowly all the time. For a causticizer containing about 1,200 gallons the operation should take about 15 to 20 minutes. As soon as all the lime is in, shut off the open steam, put on the closed steam, and increase the speed of the mechanical agitator a little. After about 1½ hours it is as well to remove a sample and test it to see how the causticization is progressing. It generally takes about 1½ to 2 hours after the lime is all in to complete the operation. This time may be shortened a little if a large excess of lime is used, for instance 110 lbs. of lime to every 100 lbs. of soda ash used.

When the causticization is complete, the contents of the causticizers are allowed to remain at rest for about 3 hours, and then the clear caustic soda removed by a skimmer pipe to the storage tank ; as much as possible of the caustic soda solution should be run off. To the mud is now added some cold water, the volume

depending upon the quantity of mud ; if 10 cwts. of soda ash have been causticized, then about 250 gallons of water will be sufficient. Open steam is turned on and the agitator started, and both the passage of steam and the agitation are continued until the contents of the tank begin to boil. One hour is allowed for settling, and then the clear liquor is run direct to the evaporator, any milky liquor being passed through the filter first. A further 250 gallons of cold water are added to the mud, and well mixed in by mechanical agitation only, after which about one hour is allowed for settling, the clear liquor is skimmed off for evaporation, and the soft mud then run on to the filter. The liquid which filters through is evaporated down, and then added to the strong caustic soda with the other concentrated washings. By this method of washing it is possible to reduce the content of actual caustic soda (NaOH) to 0.5 per cent. If it is desired to dry the mud further, it may be transferred from the filter to a special centrifugal machine.

Before causticizing the "spent liquor," which is separated from the tar acids at the divider tanks, it is necessary to bring it up to a standard strength by adding soda ash. The quantity of ash it is necessary to add is found by submitting a sample of the spent liquor to analysis. A good standard to work to is 10 grams of ash per 100 c.c.'s. The amount of ash required to bring the "spent liquor" up to strength being added, causticization and the washing of the lime mud are carried out in a similar manner to that just described. With reference to the amount of lime to be added, the writer has obtained the best results by using 6 to 6½ cwts. of best Buxton lime for every 10 cwts. of actual soda ash in solution in the "spent liquor." It is not possible to gauge the strength of the "spent liquor" by means of a hydrometer, as it contains impurities which affect the specific gravity. Caustic soda for washing out cresylic acid is often made a little stronger, and this necessitates reinforcing the causticized "spent liquor" by the addition of some strong caustic soda solution, or by evaporation : this latter operation naturally raising the content of caustic soda by reducing the quantity of water. Unfortunately evaporation increases the percentage of impurities, and if this gets large the reaction between the tar acids contained in an oil and the caustic soda in the liquor is somewhat retarded.

Crude carbollic and cresylic acids are extracted from crude naphtha, light oil, carbollic oil or light creosote. The methods of dealing with these distillates before extracting the tar acids varies more or less in different works. Sometimes the oils are submitted to distillation first, separating into two or three fractions ; at other times a portion of the tar acids is washed out of the oils, after which they are distilled and the distillates washed for tar acids. Circumstances determine which process is carried out and

also the number of fractions made, and their cut points. Whichever process is used the tar acids are washed out with caustic soda lye, and recovered by either the  $\text{CO}_2$  or sulphuric acid method.

Before the oils are washed with the caustic soda lye they should be allowed to settle in the washer for a short time in order to settle out any entangled ammonia water. This material will not only dilute the lye, but as it generally contains ammonium sulphide a reaction will take place, resulting in the formation of sodium sulphide and ammonium hydrate; the former compound is incapable of combining with tar acids, and thus reduces the active strength of the lye. During the settling out process, any oil which separates naphthalene ("salts out") must be kept warm by means of a closed steam coil. It is also necessary to wash the oil at an elevated temperature. This temperature must not be too high and if the caustic lye is used hot the same precaution must be taken. If the oil or lye is too hot the amount of tar acids extracted is not so great as when warm or cold. Also, if the process of interchange is being carried out and the carbolate or oil is too hot there is a tendency for the carbolate to give some of its tar acids up to the oil. A good "average" temperature to use when washing is  $85^\circ$  Fahr. It should be borne in mind that the caustic soda lye must not be too strong.

The method of interchange is employed in both the  $\text{CO}_2$  and sulphuric acid processes. It consists in adding a phenolate containing a little carbolic and much cresylic acid, or all cresylic acid, to an oil rich in carbolic acid, when the carbolic acid in the oil displaces the cresylic acid in combination with the soda in the phenolate, the cresylic acid going into solution in the oil; interchange takes place.

If the tar acids are to be recovered by the sulphuric acid process, the fresh, or "clean," caustic soda lye used for the purpose of washing an oil, is moderately strong, varying in specific gravity from 1.150 to 1.225 at  $60^\circ$  Fahr. The specific gravity of "clean" lye used in the  $\text{CO}_2$  process varies between 1.110 and 1.140, but that from "spent liquor" generally has a much higher specific gravity (at times 1.150), due to impurities in solution. Sometimes "clean" lye is used to wash a fresh oil. With reference to the amount of caustic lye required to wash a fresh oil, this will vary according to whether it is desired to take out the whole of the tar acids or only a portion. By testing the oil for its content of tar acids, and using the equation given on page 79, or by adding measured volumes of lye to a known quantity of oil until no further decrease in bulk takes place, the chemist can determine approximately how much lye to use.

In following through an interchange process, using moderately strong lye at the finish, it will be assumed that the phenolate, with which it is desired to wash the fresh oil, stands at a specific gravity

of 1.110 and contains 21 per cent. of tar acids possessing a crystallizing point of 60° Fahr.

It is not possible to give detailed figures with reference to the amount of phenolate to be put on an oil; this will vary according to the quantity of oil it is required to wash, and also the kind of oil. The amount must, therefore, be determined by experiment in the chemical laboratory. After the oil has been washed with the phenolate containing 21 per cent. of tar acids, it is allowed to settle for a short time, say about half an hour; the phenolate is then run off to a storage tank, tested and retained for further use. The oil is then washed with another phenolate containing say tar acids of a crystallizing point of about 58° Fahr. With a good oil the crystallizing point of the tar acids in this phenolate will be probably raised to about 60° Fahr. A further settling of the oil and phenolate is allowed to take place and the phenolate removed to a storage tank, or if desired into the tank containing the phenolate which has in solution the higher crystallizing acids. The oil may now be washed with another phenolate containing tar acids possessing a crystallizing point of say 45° or 50° Fahr. These acids will probably be increased to say 50° to 55° Fahr. A settling is allowed, as already described, and the phenolate removed. Sometimes the oil is now washed with a strong solution of caustic soda, the specific gravity of which may be 1.175 at 60° Fahr. The resulting phenolate is, as a rule, used on a fresh oil. Should the oil be particularly rich in crystallizable acids, a further wash with phenolate may be given before using caustic soda lye; and in this connexion it should be urged that tests be made in the chemical laboratory throughout the whole operation of washing.

In all these washes care must be taken not to agitate too vigorously or too long, as there is a possibility, if this is done, of forming undesirable emulsions which may take several hours to separate. Some of the lighter tar distillates, such as crude naphtha, once run light oil, and sometimes even virgin light oil are washed entirely free of phenolic bodies, and there are cases when even a light creosote is served in the same way. At times, however, virgin light oil and light creosote are only partially washed for tar acids and then submitted to a distillation. It is sometimes preferred to distil the light oil and light creosote previous to washing for tar acids. Which of these various methods is used will depend entirely upon the circumstances existing in the works. It should be remembered that an oil containing a fair amount of naphthalene will deposit that substance in the washer very freely after the tar acids have been washed out.

It appears that tar acids assist in keeping naphthalene in solution. It is necessary then, in cases of this description, to keep the oils at a temperature above that at which the naphthalene contained therein will crystallize out. As the majority of tar dis-

tillers manufacture crude carbolic and cresylic acids, it is necessary to run those phenolates which contain tar acids which do not crystallize at say about 35° Fahr. into special tanks to be worked up for cresylic acid. Only those phenolates which contain crystallizable tar acids are used for the manufacture of crude carbolic. The last wash off the light oils, and generally all the washes but the first off light creosotes, are used for the manufacture of cresylic acid.

The next process is to recover the tar acids from the phenolate, and the method used is the same whether the phenolate contains crystallizable acids or cresylic acid.

Dealing with the sulphuric acid springing process, which generally follows the interchange process just described, the phenolate is run into a suitable tank and diluted with water until its specific gravity reaches 1.08 at 60° Fahr. It is then allowed to rest for an hour or two, in order to allow any oil, which may be held in suspension in the phenolate, to rise to the surface. This oil is skimmed off, as should it get mixed up with the crystallizable acids, it will reduce the crystallizing point, or, on the other hand, should the acids be non-crystallizable (cresylic acid), it will probably bring down their value by increasing the amount of impurity in the finished product.

After the oil is skimmed off, sulphuric acid of about 146° Tw. (B.O.V.) is added carefully, with thorough stirring. The amount of acid necessary to "spring" the tar acids should not be exceeded, and can be found by occasionally testing the contents of the "springing" tank with the blue litmus paper. When the contents are just acid to litmus, after a thorough agitation, the same are allowed to rest for from six to eight hours. The tar acids are then separated from the sodium sulphate liquor underneath by first of all removing the latter through a bottom drain cock, care being taken that no tar acid escapes during the operation. The sulphate liquor is run to the sewer. When tar acids begin to show, it is as well to allow a further settling of about ten minutes or so, or to run a few gallons through a separator. The tar acids may then be conducted to a storage tank, and tested for strength, prior to filling into packages for despatch.

With reference to the strength of the sulphuric acid used, the writer prefers to dilute the B.O.V. to about 110° Tw. and to keep the phenolate at a specific gravity of 1.10 at 60° Fahr. If too strong an acid is used to "spring" the phenolate, there is a risk of the sodium sulphate crystallizing out in the "springing" tank during the settling period, and if this takes place, it will make it very awkward when the time comes to carry out the separating operation. Strong acid is also liable to act upon the phenols forming sulphonic acids: these bodies being undesirable in either crude carbolic or cresylic, as they split up during the refining



operation when the material is distilled. The tar acids should be allowed to rest in the storage tanks some two or three days, in order to settle out any entangled sulphate of soda liquor. This is necessary in the case of both carbolic acid and cresylic acid.

It is desirable to clear the storage tanks occasionally of the soda sulphate liquor and sometimes crystals which settle at the bottom. Should crystals form, it is as well to steam the tanks out by inserting a temporary 1-inch steam main into the tank.

Carbolic acid is sold in various qualities, such as 40's, 45's, 50's, 60's, etc., and it is possible by a process of mixing to build up any desired quality, either from the phenolates or the "sprung" carbolic acid. A very simple calculation will give the approximate volume required. The mode of calculation as used on "sprung" acid is shown in the following example: Suppose in one storage tank there are 200 gallons of 55's carbolic, and in another tank a quantity of 45's acid. It is required to convert the 55's into 50's carbolic; then

$$\begin{array}{r} 200 \times 55 + x \ 45 = 50 (200 + x) \\ x (45 - 50) = 200 (50 - 55) \\ -x \ 5 = -1,000 \\ x = 1,000 \end{array}$$

5 = 200 gallons of 45's acid are required.

In the  $\text{CO}_2$  process the oils are washed with a caustic soda of a strength sufficient to absorb, in the case of carbolic acid, an amount which, when the phenolate is tested, will correspond to about 15 per cent. of the phenolate, and in the case of cresylic acid about 20 per cent. The caustic soda as obtained from the causticizers, if the process is carried out properly (see page 80), will be of sufficient strength to yield a phenolate containing 15 per cent. approximately of tar acids, and, as already mentioned on page 81, if the lye is to be used for the recovery of cresylic acid, it must be reinforced with a little strong caustic soda made with the 77 per cent. solid caustic soda or with the electrolytic liquid. The interchange method may be used in the  $\text{CO}_2$  process of recovery, but a little more care is necessary in carrying out the same.

Before washing the oils, it is absolutely essential to allow any ammonia water to settle out first. This is necessary, as it not only reduces the percentage of active agent, viz., caustic soda in the lye by dilution, but also by combination with the sulphur which exists in the ammonia water as ammonium sulphide, sodium sulphide being formed. It appears, from the results of a number of experiments made by the writer and others, that part of this sodium sulphide is converted into sodium sulphate during the progress of the phenolate, through the plant.

In the process under consideration, the phenolate is "sprung," or decomposed, by carbon dioxide ( $\text{CO}_2$ ) which is contained in the

gas prepared in one of the furnaces mentioned in Chapter VII, page 68. The phenolate passes down the "springing" or reaction tower, over the packing or plates, and the gas containing the  $\text{CO}_2$  entering the bottom of the tower and travelling in an upward direction, comes into contact with the finely divided phenolate and decomposes it. No phenolate should be passed through the tower weaker than 15 per cent. of tar acids, and the rate of pumping to the top of the tower should be between  $1\frac{1}{2}$  to  $2\frac{1}{4}$  gallons per minute. This speed will vary according to the type of tower used and the richness of the gas passing up that tower. It is advisable to use a gas containing not less than 19 per cent. of  $\text{CO}_2$ , by volume. Cases frequently occur, however, where it is not possible to obtain a gas containing more than 15 to 17 per cent. of  $\text{CO}_2$ , and in these cases it is necessary to reduce the speed of the pumping to somewhere in the neighbourhood of  $1\frac{3}{4}$  gallons of phenolate per minute. It is very advisable to test the spent liquor as it runs from the separator, to find the percentage of tar acid it contains. The maximum amount allowable for a plant working perfectly is 0.5 per cent., and should this amount be exceeded, then it is time to look round the plant to see whether the gas is poor in  $\text{CO}_2$  owing to the furnace wanting re-charging, or the charge burning hollow, or due to leaks in the gas main, or whether the speed of the phenolate is above that which it should be. It should be pointed out that care must be taken to prevent oil getting into the reaction tower with the phenolate, and time should be allowed for this to settle up in the phenolate boilers. In order to keep the reaction tower in good working order, it should be steamed out at intervals of about eight weeks.

With reference to the manipulation of the  $\text{CO}_2$  furnace, it is advisable to charge this piece of apparatus about every four hours, or even more frequently with some types of furnace, and in all cases see that hollow places do not occur, but that the contents of the furnace are kept compact. This of course can be done by regular inspection, and, if a defect is found, using the poker intelligently.

The tar acids and spent liquor leave the reaction tower at the bottom and are conducted to the two dividers (see Chapter VII, page 66), and here the tar acids are separated from the spent liquor, the latter running to storage boilers, and the former to settling receivers. The tar acids are allowed to stand in these receivers for several hours, to settle out entangled spent liquor, and then run into the finishing tank in measured quantities, for treatment with a small amount of sulphuric acid. It is necessary to use this acid, owing to the fact that a complete decomposition of the phenolate does not take place in the reaction tower. The acid should be added carefully, with thorough agitation, until the mixture changes a blue litmus paper red. In this operation the

acid not only decomposes the remaining phenolate, but assists in the removal of some of the water. It is advisable to use a B.O.V. of about  $140^{\circ}$  Tw. in this operation.

After the acid has been added, it is as well to carry out a laboratory test for the crystallizing point, if crude carbolic is the quality under treatment, and in any case for the percentage of water. Should the latter be above 15 per cent. it will be necessary to add a little more acid to the contents of the finishing tank in order that it may be reduced. When the desired result is obtained, the acids are best removed to a storage tank by syphoning over into a blow-boiler and transmitting by compressed air.

With reference to the finishing of cresylic acid, it is necessary to remove as much water as possible before transferring to the storage tank or the still charge tank. The reason for this is that water is a difficult material to contend with during the process of distillation. If care be used, a large quantity of the entangled water may be removed by the use of acid in the finishing tank.

After the carbolic acid has been allowed to remain in the storage tank for a short time, it is ready for despatch, and is either barrelled direct from the tank or else pumped (or better still, transmitted by compressed air) into railway tanks or tank boats. Of course it is necessary that a careful test be made in the chemical laboratory to determine the crystallizing point and other constants of the acid before it is dispatched, and it is also advisable to keep two large samples, say of a pint each, in case a dispute arises between the buyer and the seller.

It is policy before submitting the cresylic acid to distillation to allow a further period of time for settling, to enable any entangled acid liquor to settle out, which, should it get into the still, would injure the same, and also spoil the pitch. Furthermore, the distilled cresylic acid would not be improved by the sulphurous acid set free during the distillation. When the cresylic has settled sufficiently long, it is charged into the still, the fire lighted, or if producer gas is employed this is turned on and ignited. The heat may be increased rapidly until such time as the dome of the still begins to get hot, when it is advisable to slacken the temperature of the furnace, and work carefully until water and acid appear at the worm end. The rate of distillation must be carefully judged, in order to avoid any risk of a boil-over. A mixture of water and acid come over first and they are separated after leaving the collecting box in the separator described on page 76. If the cresylic acid has been carefully prepared, there will be very little oil in the first runnings. These first runnings consist to a large extent of poor carbolic acid, but in cases where the still is provided with a good fractionating column, it is possible to obtain a fair percentage of a moderately good carbolic acid. When a

fractionating column is used, it is essential that no distillate be passed into the column until water discontinues. Immediately this takes place, then the by-pass is thrown out of gear and the vapours conducted into the fractionating column. The point at which the distillate is changed over from carbolic acid to cresylic acid must be determined for each particular charge of acid as it undergoes the course of distillation, and the chemist should receive samples occasionally. A usual method is to catch the carbolic fraction into barrels, and then change over to the cresylic receiving tank, cutting out the fractionating column at the same time by means of the by-pass. Some prefer to work each still charge to pitch, but this is a dangerous proceeding as a rule, the risk of burning the plates of the still being very great. It is far better to work several charges up to a determined point, running off the bottoms each time into a bottoms storage tank, and when sufficient has accumulated, to make up a still charge and submit to a re-distillation. If the bottoms are particularly rich in cresylic, it may be necessary to run off again into a bottoms tank, and so proceed until they become very viscid, when the final distillation is made with the object of working to pitch. The method of procedure must be determined by the chemist, or manager of the works, for his particular quality of cresylic acid. Care must be taken in working to pitch that the distillation is not carried too far. To over-run the point when pitch is formed will produce either pitch coke or an intermediate product which may be termed spongy pitch; the latter material is dangerous, as it is exceedingly liable to spontaneous combustion immediately the still manlid is removed, and it is also difficult to remove from the still. Pitch coke, on the other hand, is not liable to spontaneous combustion, but it has to be chipped out of the still, and during its formation the plates may become badly burned. Cresylic pitch is not of much value alone, and is generally mixed with the large quantities of coal tar pitch in the bays.

A 1,500 gallon charge of well settled cresylic acid, if worked to bottoms and not pitch, will take about 24 hours to finish. The total yield of crude carbolic acid, possessing a crystallizing point of about 46° Fahr., will approximate 9 per cent., that of 98 per cent. quality cresylic 60 per cent., water 8 per cent., and bottoms 23 per cent. A mixture of bottoms, when distilled, will yield approximately 80 per cent. of cresylic acid, the balance being pitch and loss.

The cresylic acid as obtained from the still is not ready for sale. Distilled cresylic acid contains  $H_2S$  and other sulphur compounds, which give to it a very unpleasant odour, and it is necessary to remove these objectionable compounds before placing the acid upon the market. To remove these compounds the acid is air blown in a special tank which has been described on page 78.

The acid is transferred from the receiving tank, either by a pump or compressed air, to the air-blowing tank. Air is now passed into the acid by means of an air compressor, or else drawn through the acid by a steam ejector. The foul air must be dealt with according to the Alkali Act and therefore should be "burned" or passed through purifiers, and not allowed to escape into the atmosphere. As regards the length of time required to free the acid from sulphur compounds, nothing definite can be given, but as a guide to the learner, an average figure of three days may be taken. It is necessary for the chemist of the works to rig up a testing apparatus, and submit samples occasionally to a very simple test, as described on page 164.

Cresylic acid is usually sold on the basis of 95 to 98 per cent. of tar acids, and it is necessary for the chemist to test the same for this content. The impurities will, of course, consist chiefly of (a) oil, (b) naphthalene, and (c) water.

With reference to a quality of cresylic acid termed "water white," this is not produced in the majority of tar distilleries, and will therefore not be dealt with in this book. The same remarks apply to the manufacture of carbolic acid crystals.

## CHAPTER IX

### PLANT FOR THE RECOVERY OF BENZOLS, NAPHTHAS, ETC.

Washing tanks—"blow-over" stills—"blow-over" still fractionating column—fractionating still and column—dephlegmator—condensing coil and tank—divider box—storage tanks.

THE plant necessary for the production of benzols and naphthas is complicated, and the designs used by distillers are numerous. It would not be possible to describe them all in this book, and therefore a general description of suitable plant will be given.

It is necessary before the light oils are worked up into what are termed "once run" products that they should be washed free from tar acids and pyridine. Washers for the recovery of tar acids are described on page 60 and will not need a second description here. With reference to the removal of pyridine, this is carried out in tanks made entirely of cast-iron, cast-iron lined with lead, or wrought-iron; mild steel is frequently used in place of the latter. These tanks must be provided with an agitator, and the necessary gearing to manipulate the same. The agitator may be of the archimedean screw type or of the paddle type. In the latter case horizontal paddles should be used in preference to vertical ones. The writer considers the archimedean screw type of agitator the very best kind to employ. A vertical washing tank should be covered in at the top, and should be made with a cone or dish-shaped bottom. An outlet for running off the pyridine acid and acid tar should be placed at the apex of the cone, or the lowest portion of the dish bottom, and connected up to lead piping, which, in its turn, is connected to an acid-resisting metal valve (regulus metal). The position of the washer may be such that it is not necessary to use lead piping at all, but to simply connect the valve direct to the bottom. Paddle agitators have the shaft running through stuffing boxes, and care must be taken that these are of a good type.

Wood is the best material to use to cover in the top of a vertical washer, but cast-iron, wrought-iron and mild steel are sometimes employed. Let in through the cover of the washer is a charge pipe, an inlet for the acid supply pipe, and also for the water

pipe. There is also an inspection hole with a wooden cover. With reference to the water-pipe, the writer prefers to water wash the contents through the inspection hole, using a piece of flexible hose. By this means the sides of the washing tank can be washed down with water before any agitation is carried out. The advantage of this will be discussed in the next chapter. A few inches above the bottom of the washer, an outlet pipe is attached, through which the washed oils are passed into storage tanks or to the stills. The size of a washer will depend entirely upon the volume of oil dealt with in the works.

Some tar distillers prefer horizontal washers, but in the writer's opinion these are not nearly so satisfactory as the type just described. It is not so easy to run off the acid tar and pyridine acid from a horizontal washer, or to wash the sides down thoroughly. Furthermore the draining of the pyridine acid and acid tar cannot be carried out so completely. It is absolutely essential to erect the washing tanks in an elevated position, and the best results are obtained if the height is such that the washed oils can be run by force of gravity into the storage tanks or still.

There are many works in which one washer is used for both the acid and the soda washes. This is not advisable, as there is a great risk during the soda wash of spoiling the oil. It is far better to erect two washers of the same size and constructed on the same plan, and use one for the acid and first water washes, and the other for the soda and final water washes. The acid tar and pyridine acid are run away, the latter into a receiving tank, which is also often used as a storage tank. The former, which is often almost solid, is run into open ended tubs or other suitable receptacle for treatment before disposal. When a lot of pyridine acid has to be dealt with and it is desired to work it up for pyridine, it is advisable to put in storage tanks—lead-lined wooden tanks are most suitable—the size of which will of course depend upon the volume which has to be passed through them. Fuller details of these tanks will be given in the chapter dealing with the plant for working pyridine acid for pyridine.

Broadly, there are two kinds of still used in the process of recovering benzols and naphthas from tar oils. These are known in tarworks terminology as "blow-over" stills and rectifying stills. The former type may be subdivided into fire-heated and steam-heated. In the case of light oil, and often with crude naphtha, the "blow-over" still is fire-heated, and in many cases it is not provided with a fractionating column, although it is a decided advantage to fit such a piece of apparatus to the still. Another type of "blow-over" still is steam-heated, and in most cases this kind is used immediately before working the oils through a rectifying still. Steam-heated "blow-over" stills and rectifying stills are always provided with fractionating columns.

Fire-heated "blow-over" stills are built similar in shape to a tar still and are constructed of  $\frac{1}{2}$ -inch mild steel plates. The bottom is built concave, with a rise of approximately 2 feet 6 inches from the horizontal. To the bottom is riveted a channel plate, and this channel plate is also riveted to the shell of the still. It is advantageous to construct the bottom of the still of sketch plates or segments, and connect these to a circular crown plate on top. The dome of the still is built with a rise, the height of which will vary according to whether the dome is to carry a fractionating column or the fractionating column is to be supported upon joists. In the former case a rise of about 3 feet is necessary for a 9-foot diameter still, but in the latter, a rise of about 12 inches for the same diameter is all that is necessary. The still should be provided with a tail pipe and run-off tap, a safety valve, a trial or overflow tap, and an inlet stool, to which is connected the charge pipe. A manhole and lid must also be provided. If the fractionating column is not supported on the dome of the still, it is necessary to provide a cast-iron swan-neck and connexions, in order to conduct the vapours from the still to the fractionating column.

With reference to the fractionating column, this may be constructed either of cast-iron in the form of segments, or of mild steel, and is cylindrical in shape. Its diameter will vary a little, but average diameters may be taken as 2 feet 6 inches and 3 feet. In the case of cast-iron columns, each segment will have a perforated plate fitted into it, or cast on it and then drilled. Mild steel columns are fitted with a series of brackets from top to bottom, on which are supported the perforated plates (see Fig. 51). These plates should be roughly about 9 inches apart, and are perforated with  $\frac{1}{4}$ -inch holes at a pitch of 1 inch. There is also one hole having a diameter of 4 inches drilled in each plate. The plates are  $\frac{1}{4}$ -inch thick, and in the case of a mild steel column, its thickness may be  $\frac{3}{8}$ -inch. If the still is exposed to the weather, a mild steel column is the best to use, as it is less liable to crack owing to atmospheric conditions, such as rain falling on the column during the time that it is working. Better results are obtained if the column is surrounded by a draught screen, built say of corrugated iron sheet. At the top of the column a cast-iron vapour outlet is fitted, and this is connected in turn to the vapour pipe.

With reference to the setting of this type of still, the method given under the setting of tar stills on pages 25-32 will give the most suitable results.

Steam-heated blow-over stills (Fig. 51) are constructed of mild steel plate of a thickness varying between  $\frac{3}{8}$ -inch and  $\frac{1}{2}$  inch; sometimes  $\frac{3}{8}$ -inch plates are used for the shell and  $\frac{1}{2}$  inch for the ends in the case of horizontal stills. The best types of steam-heated blow-over stills are of the horizontal pattern. With reference to the



size of this type of still this will vary considerably according to the amount of naphtha that is to be dealt with, but a good average is 9 feet in length and 7 feet 6 inches in diameter. The still is fitted with a casting, to which the run-off pipe is connected ; also an inlet pipe stool ; a 1-inch to 1 $\frac{3}{4}$ -inch open steampipe inlet, to

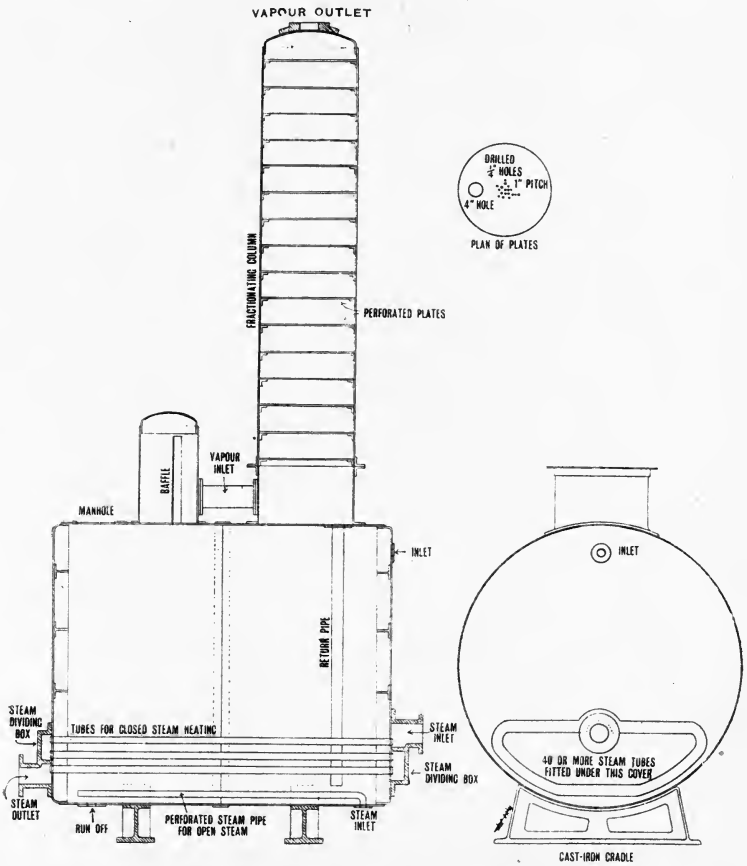

FIG. 51.—Diagram illustrating a Type of Steam-heated Blow-over Still with Fractionating Column.

which is connected a perforated steam pipe ; steam chests ; a series of 1 $\frac{1}{2}$  inches to 2 inches wrought-iron tubes for closed steam —these tubes being covered at each end by the steam chest covers ; a manhole of the usual size, provided with a draw-up manlid ; safety valve ; and also a gauge of the glass tube or else of the

refraction type, in order to indicate the level of the liquid in the still. Sometimes this kind of still supports the fractionating column; in this case a vapour dome, fitted with a baffle, is usually placed near the fractionating column and connected to the same with a piece of cast-iron pipe. Fig. 51 illustrates one way of doing this. The fractionating column should be light and preferably made of wrought-iron or mild steel of about  $\frac{3}{8}$  inch thick; in fact the same type of fractionating column as that already described for fire-heated blow-over stills may be used. The number of plates contained within the fractionating column may be between 16 and 20.

If it is desired to do away with the vapour dome and baffle, a swan-neck made of cast-iron may be used in its stead to carry the vapours into the fractionating column (see Fig. 52). The bottom of the column is connected to a wrought-iron return pipe of about 4-inch diameter, which extends almost to the bottom of the still. If a cast-iron column is used, it is advisable to support the same on stanchions and joists, but it may be connected either with a swan-neck or vapour dome and baffle to the still, as desired. It is necessary to support this type of still on cradles. These may be of cast-iron or built of brick or concrete; the writer prefers cast-iron, as in his experience these have given the most satisfactory results.

Fractionating stills are generally of a horizontal type, constructed of  $\frac{3}{8}$ -inch to  $\frac{1}{2}$ -inch mild steel plates, and provided with fittings of a similar kind to those described for steam-heated blow-over stills. (See Fig. 52.)

With reference to the fractionating column, there are a number of types, and it will not be possible to describe every one of them in this book. If it is desired to produce ordinary naphthas and benzols, a fractionating column containing about 20 plates, and having the last six segments water-cooled, will prove quite suitable, but, on the other hand, if it is required to produce benzol, toluol and xylol, 95 per cent. distilling over within between  $3^{\circ}$  and  $1^{\circ}$ , it is necessary to connect the fractionating column with a piece of apparatus known as a dephlegmator. This piece of apparatus, together with condensers, will be described later.

A great deal more care must be taken in choosing a fractionating column for a rectifying still. The ordinary perforated plate is not likely to give such good results as those plates which are fitted with special dispersing arrangements. What is desired in a fractionating column is to bring the hot vapours, which consist of a mixture of light and heavy compounds, in contact with liquid material, in order to remove from the vapours by a kind of washing the heavier substances from the lighter. This can only be secured if each plate is arranged to carry a certain depth of liquid during the process of fractionation. With the ordinary perforated plate

it is more difficult to secure this state of affairs than it is with plates provided with an arrangement which will keep a constant

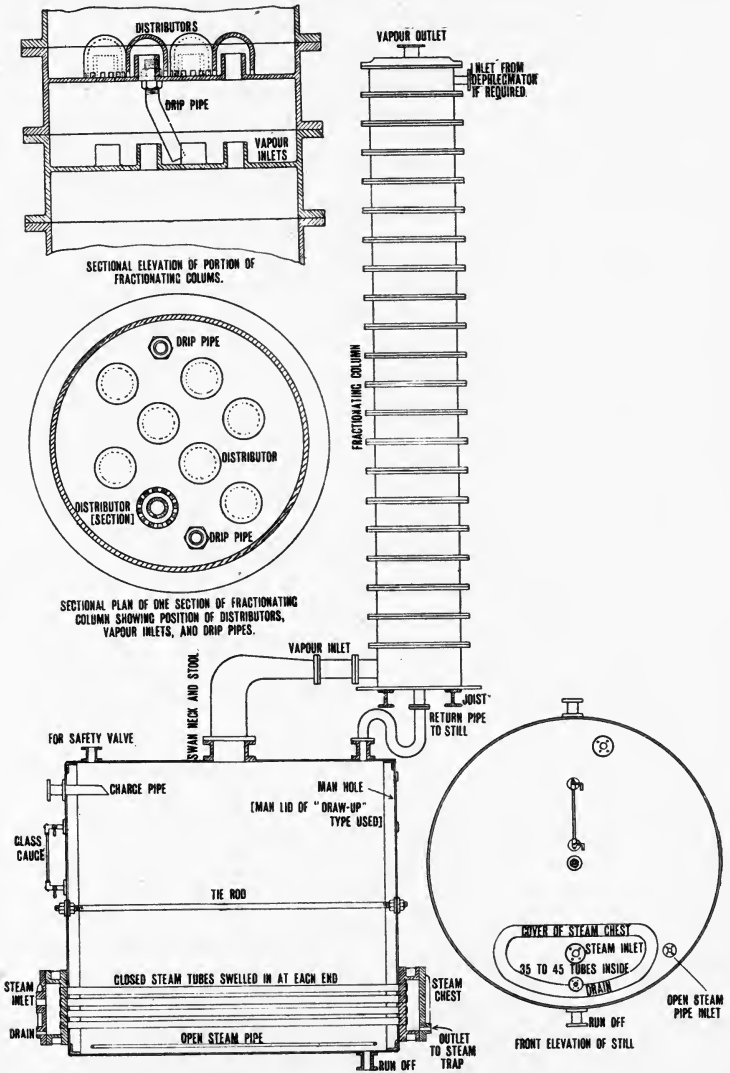

FIG. 52.—Fractionating Still and Column.

level of liquid, and allow the vapours, as they rise, to pass in a finely divided state through that liquid.

One of the best types of fractionating column which the writer knows of is shown diagrammatically in Fig. 52. This column, like most of the columns used for fractionating stills, is built up of cast-iron segments. The number of these segments may vary, of course, according to the degree of fractionation desired. If a dephlegmator is used, a column constructed of between 16 and 20 segments will prove quite suitable, but if it is desired to do without a dephlegmator, it is advisable to build the column of between 25 and 30 segments. The diameter of each segment may vary between 2 feet and 2 feet 6 inches, and the over-all depth between  $8\frac{1}{2}$  and 12 inches. The plate is cast on to the body of the segment, and the top of that plate is about 3 inches from the top of the segment. Each plate is provided with eight or more inlets, which conduct the vapours from the lower half of the segment. Over each of these inlets a cast-iron hood or disperser is placed; this disperser is beehive in shape, and has twelve openings  $\frac{1}{2}$  inch by  $\frac{1}{2}$  inch, as shown in Fig. 52. There are also provided two overflow outlets, to which are connected overflow pipes. The method of arrangement will be seen on referring to Fig. 52. The bottom segment of the column is, of course, provided with a vapour inlet of 4 inches in diameter, and this is connected with a swan-neck to the still. There is also cast on this segment a 2-inch connexion to which the return pipe is fitted. The return pipe is passed into the still, and should reach almost to the bottom. The top section of the column has a vapour outlet stool cast on to it, which may be 2 inches in diameter; to this is connected the vapour pipe which will lead either to the condenser coil or to the dephlegmator. If the column is not connected to a dephlegmator, it is very advisable to water-jacket the top six or eight sections. Should the column be connected to a dephlegmator, it is necessary to provide the top section with an inlet hole, to which is fitted the return pipe from the dephlegmator (see Fig. 52). This return pipe is made in the form of a U with one limb longer than the other, in order to provide a seal of liquid to prevent the vapours from entering the bottom portion of the dephlegmator.

Dephlegmators vary a little in construction, some being cylindrical, and others square or rectangular in shape. All of these types will give excellent results, but only the cylindrical shape will be described. It consists of a mild steel cylinder, its diameter, as a rule, varying between 2 feet and 2 feet 6 inches and its length between 7 feet and 8 feet. Inside the cylinder about 1 foot 6 inches from each end are riveted two plates, into which are fitted a large number of copper tubes of similar diameter (between  $\frac{3}{4}$  and 1 inch). Through these tubes a flow of water is maintained, and the vapours from the fractionating column pass round the tubes, the heavier vapours being cooled and returning to the fractionating column *via* the U shape return pipe just

described (see Fig. 53). The dephlegmator is therefore provided with a vapour inlet at the top, which enters just underneath the top tube plate, and a vapour outlet near the bottom, just above the bottom tube plate. A return pipe is also fitted near the bottom, just above the tube plate. Water is introduced through the inlet fitted to the bottom of the dephlegmator, and leaves by the outlet at the top.

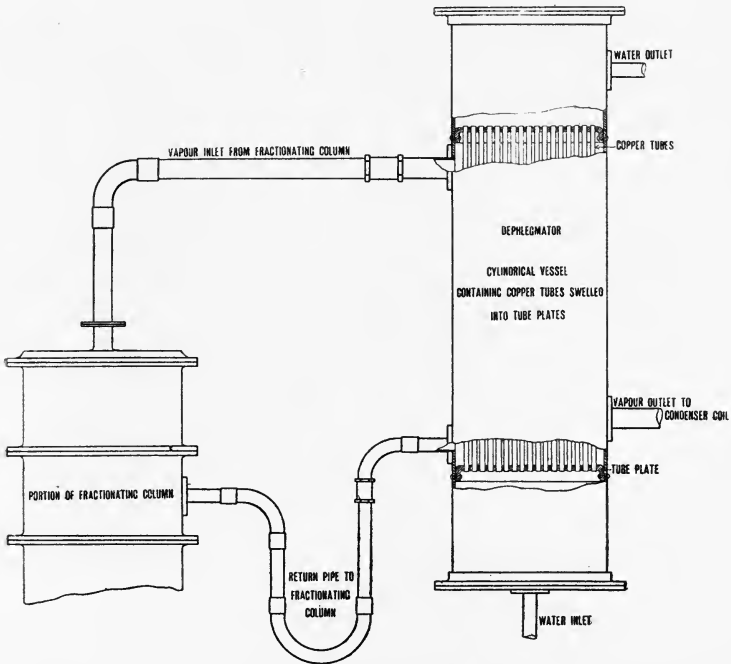

FIG. 53.—Diagram showing a Type of Dephlegmator and a Method of Connecting to the Fractionating Column.

After the vapours leave the dephlegmator, or when this is not used, the fractionating column, they are conducted to a condenser. This condenser may be constructed of wrought-iron tubing, arranged in a number of laps, placed in a cylindrical tank, or, especially in cases where a dephlegmator is used, of a cylindrical vessel, inside of which are riveted top and bottom plates drilled with holes into which a number of tubes are fitted, very similar in fashion to the arrangements just described under dephlegmators. If it is desired to fit up a condenser coil of the usual type, it is advisable to have that coil made in one length of wrought-iron

pipe. The diameter may vary a little, but one of 2-inch diameter will generally prove quite suitable. The total length of the tube will vary, of course, according to the condition of the water supply and the rate at which it is required to work the still. With a still working at an average speed of about 70 gallons per hour, 180 feet of 2-inch wrought-iron pipe will be quite sufficient. The over-all diameter of each coil may be 4 feet 6 inches to 5 feet, and the distance between each lap should not be less than 4 inches. At least 4 inches should be allowed between the outside of the coil and the inside of the condenser tank, and the top lap of the coil should be covered with about 6 inches of water when the coil is working.

The condenser tank is cylindrical in shape and fitted with water inlet and outlet pipes, drain cock, etc., as described on page 36. Connected to the condenser is a divider box, and this is of exactly the same pattern as that described on page 38 (Fig. 31). The outlet from the divider box, however, is connected up to several 1-inch pipes by means of T pieces, in order to conduct the various fractions to their respective storage tanks.

Storage tanks may be square, rectangular, or cylindrical, according to convenience. In all cases they should be covered in and provided with a run-off tap, and also drain cock, through which any water which may settle out can be removed.

## CHAPTER X

### THE RECOVERY OF BENZOLS AND NAPHTHAS—FIRST DISTILLATIONS AND WASHINGS

Distillation of crude naphtha by steam or fire—distillation of light oil by fire—distillation of light oil fractions by steam or fire—distillation of light creosote by fire—washing crude benzol, crude solvent and crude heavy naphtha to remove tar acids and pyridine bases—a method of washing crude benzol—a method of washing crude solvent—a method of washing crude heavy solvent.

THE various qualities of benzols and naphthas are obtained from crude naphtha, light oil, and often from light creosote. It is necessary to wash these oils, or certain fractions obtained from them, free from tar acids and pyridine before the process of rectification can be carried out. In the case of the heavier oils, and very frequently with crude naphtha, a first distillation by fire is carried out as will be described below.

Dealing with crude naphtha, this distillate contains chiefly benzene and its higher homologues, and on treatment and rectification yields principally 90's benzol and 50-90's benzol. Crude naphtha as pumped over from the receivers will contain approximately between 4 and 6 per cent. of tar acids, and a varying quantity of pyridine bases. The tar acids are removed as already described in Chapter VII. Pyridine bases are not removed until just before the rectification process.

It is preferred by some to submit the crude naphtha to a distillation before washing out the tar acids. Others prefer to wash out the tar acids before distilling, and it depends on the circumstances existing in the works whether this is done or not. In any case, after the tar acids have been removed it is advisable to allow an hour or two for settling, in order that any entangled phenolate may settle out. The extracted naphtha is then submitted to a distillation. This may be conducted in a fire still, fitted with a fractionating column, or a steam-heated still, to which a similar apparatus is connected. Two fractions may be collected: the first being run into what is termed the crude benzol receiver, and the second into a receiver for crude solvent. The end of the first fraction is generally found by submitting a portion of the distil-

late as it runs from the worm end to a rapid distillation in a retort in the laboratory. As soon as the test sample shows the first drop at about  $110^{\circ}$  C. the distillate is changed over into the crude solvent tank. The end of the second fraction is determined when the specific gravity of the distillate taken from the worm end indicates approximately .965 to .970 at  $60^{\circ}$  Fahr. On to the residue in the still, other material is often placed, or it is removed and kept for working up with heavier distillates at some other time. The methods of obtaining the change-over points just given are not always used, and it is sometimes necessary to vary these according to requirements which may obtain in the works.

The steam still in which this naphtha may be fractionated must be provided with an open steam coil, as it is necessary to assist the distillation with open steam after a certain point is reached. Generally open steam is introduced into the still when the distillate at the worm end, on testing in the laboratory, commences to distil at about  $95^{\circ}$  C. If, however, high pressure steam is supplied to the closed steam tubes, the open steam may be introduced at a later period. Care should be taken when first passing the steam into the still not to open the valve too wide. If this is done it will generally cause the still to prime, or, in other words, fill the fractionating column with the heavier material from the still. This, of course, is a serious matter, and will, if it occurs, generally spoil the operation. The valve should be opened very gently at first, say about one quarter of a turn, and then the passage of steam gradually increased until the still works evenly. When open steam is introduced, it is necessary to pass the distillate, as it comes from the worm end, through a divider box, in order to separate the condensed steam from the oil. The closed steam is not discontinued during the passage of open steam, but it may be regulated according to the rate of distillation desired. With reference to washing the distillates for pyridine, this will be dealt with after considering the first distillations of light oil and light creosote.

In dealing with the light oil fraction, if this is found to yield a high crystallizing crude phenol, it is often washed once or twice with soda lye, to remove the best portion of the tar acids before submitting to fire distillation. Some distillers even in this case prefer to submit the oil to a fire distillation before washing for tar acids.

It is absolutely essential, however, to distil the light oil by fire before dealing with the same to obtain naphthas. This oil, when distilled in the fire still, which should in all cases be fitted with a fractionating column containing at least 15 plates, may be separated into two fractions and a residue, or one fraction and a residue. The quality of the oil will determine which of these methods is the best to adopt. If the light oil is divided into two



fractions, then the change over point from the first to the second fraction is generally determined when approximately 25 per cent. has come over. With a large number of oils this point is also indicated when the distillate at the worm end shows a specific gravity of about .925 to .928 at 60° Fahr. This fraction may be termed "once run light oil A." The second fraction—"once run light oil B"—is complete when the distillate at the worm end shows a specific gravity between .990 and 1.000 at 60° Fahr. The residue remaining in the still is run to creosote, or to special storage tanks, to await the recovery of the naphthalene. Should it be necessary to remove from the light oil one fraction only, then that fraction is complete when the specific gravity of the oil at the worm end is about .980 to .990 at 60° Fahr. In this case also the residue is dealt with as just mentioned.

For the convenience of the still attendant, his "change over" points, and finishing points, are often given him to read at 100° Fahr. For example, if it is desired to finish the distillation at a specific gravity, of 1.000 at 60° Fahr. then the still attendant should stop collecting when his distillate reaches .980 at 100° Fahr. Open steam is not used during the distillation of light oil by fire.

It is advisable not to work too many charges through the light oil still before submitting the same to a cleaning process; ten times may be taken as a good average.

The distillate or distillates obtained from the light oil as just described are now washed free from tar acids, and then submitted to a further distillation, either in a fire-heated or steam-heated still, provided with a fractionating column. In this operation the "once run light oil A" distillate may be separated into one fraction and residue, or two fractions and residue. If only one fraction has been distilled off the light oil, this may be separated into one, two or three distillates and residue.

In the case of the "once run light oil A," if this is separated into one fraction, the whole of it is run into the crude solvent receiver, and the point at which the distillation is stopped is indicated when the specific gravity at the worm end reaches about .960 to .980 at 60° Fahr. When two fractions are made, the first one is mixed with the crude benzol, and the second run to crude solvent. The change-over point from the first to the second fraction is determined in a similar manner to that given under the working of crude naphtha on page 99, and the end of the second fraction is found as just mentioned above. Considering a case in which only one fraction has been distilled off the light oil, should it be desired to separate this into three fractions, then the end of the first fraction is determined as already described. The second fraction is stopped when the specific gravity reaches .940 at 60° Fahr. at the worm end, and the third fraction, which is termed

crude heavy naphtha, is finished when the specific gravity of the distillate collected at the worm end reaches between .960 and .980 at 60° Fahr.

The "once run light oil B" distillate, if separated into one fraction, is worked until a specific gravity of about .970 at 60° Fahr. is reached. This distillate is run into the crude solvent tank. If, however, it is desired to collect two fractions, then the end of the first is determined when the specific gravity at the worm end reaches about .930 at 60° Fahr. and the end of the second when a test of the distillate collected as it runs from the coil shows .960 at 60° Fahr. The former is run to the crude solvent and the latter to the crude heavy naphtha receiver.

The residue in all cases is run to creosote, or else reserved for the recovery of naphthalene. If it is desired to carry out the distillation just described in a steam-heated still, open steam is introduced shortly after the distillate appears, and the supply continued until the end of the operation: closed steam of course being employed throughout the entire distillation.

The light creosotes from some tars are not rich enough in light oils to warrant a treatment for the recovery of these, but in some cases it is found that sufficient of the benzene homologues may exist in the creosote to warrant a distillation for the purpose of recovering a fraction from which these materials may be obtained. When this is the case the light creosote is submitted to a distillation in a fire-heated still, provided with a fractionating column and a fraction collected, the amount of which will vary considerably, and the finishing point of which will have to be determined by the chemist on the works. After washing this fraction free from tar acids, it is necessary to submit it to a further distillation in a fire-heated still, separating into one or two fractions as is found advisable. The first fraction may be run to the crude solvent and the second to the crude heavy solvent receiver.

The crude benzol, crude solvent and crude heavy naphtha must be submitted to a washing process to remove pyridine bases and impurities. The former substances are of value to the tar distiller and in almost every case are recovered and refined. Before commencing a wash, it is advisable to examine the oil, whichever quality it may be, for tar acids, and if any exist they should be washed out. In all cases before washing it is advisable to allow the oils to rest for a time to settle out entangled water. Pyridine is the first of a series of organic substances corresponding to the general formula  $C_nH_{2n-5n}$ , and is represented by the chemical formula  $C_5H_5N$ . It possesses basic properties and combines easily with mineral acids according to the following equations—



Sulphuric acid is used in all cases to remove the pyridine bases, and the quality usually employed is ordinary B.O.V. of about  $146^{\circ}$  Tw. In one part of the operation it is used as supplied, and in another part is diluted. After the pyridine bases are removed, a stronger acid known as D.O.V. of a specific gravity of approximately  $167^{\circ}$  Tw. is employed. It is then necessary to wash the oils with water, then with caustic soda lye, and finally again with water.

In all cases two washers should be employed, one in which to conduct the acid washes, and the other the caustic soda and the final water washes. If the acid and soda washes are conducted in one washer, there is a great risk of some of the resinous matter produced by the action of the acid, adhering to the sides of the washer, suffering decomposition by the caustic soda and then being dissolved by the oil. Distillates from the rectifying still off oils to which this has happened will possess a peculiar unpleasant odour and will rapidly go off colour.

Dealing first with crude benzol, one method of washing this material is as follows: A quantity of B.O.V. at  $146^{\circ}$  Tw. amounting to between  $1\frac{1}{2}$  to 2 per cent. is slowly added to the charge of oil in the washer, while the same is under vigorous agitation. The period of agitation may be between 20 minutes to  $\frac{1}{2}$  an hour. After this time has elapsed the contents of the washer are allowed to rest for about half an hour, and the greater part of the substance which settles out, known as pyridine acid, is run off into the pyridine-acid tank. After a further settling of about half an hour, any more pyridine acid which has separated should be run off, and then about  $\frac{1}{2}$  to 1 per cent. of D.O.V. slowly added to the oil with agitation. The time occupied in agitating in this case may vary from 20 minutes to  $\frac{3}{4}$  hour, but care must be taken that the oil does not become too hot. After the agitation it is allowed to settle for about 10 minutes, and as much of the substance (known as acid-tar) as has separated, removed. The resinification of hydrocarbons brought about by the action of D.O.V. is sometimes considerable, and the acid-tar formed often very rapidly solidifies to a "livery" mass, which will not flow, and which has a tendency to adhere to the bottom and sides of the washer. It is policy, therefore, to lose no time, but to remove as much as possible before this state sets up. Further settlings of 10 minutes are given, and any more acid-tar which separates is run off. When the whole of the acid-tar has been removed—it should be noted that this material must not be run to the pyridine acid tank—the sides of the washer should be carefully washed down with a spray of cold or warm water. This will settle to the bottom, and is removed *via* the catch tank—in which is separated and retained any oil which may escape from the washer—to a neutralizing tank, and from that to the drains. After this preliminary wash, the oil is

washed with water until the washings are practically free from acid. It is a good plan not to agitate the oil with water when giving the first wash, but to spray water on to the surface of the oil and let it fall through it to the bottom of the washer. When the washing is completed, the oil is pumped, or run by force of gravity, into the second washer and treated with about  $\frac{1}{4}$  to  $\frac{3}{4}$  per cent. of caustic soda lye standing at  $40^{\circ}$  Tw. or thereabouts. The soda lye is allowed to separate out, and then run off, and after this the oil is washed with clean water until the wash waters react neutral to litmus. After a thorough settling, the washed oil may be run direct into the rectification still, or to a storage tank, to await treatment at a later date.

It is sometimes found advisable to wash the crude benzol with a little dilute B.O.V. before adding the D.O.V. This will ensure a complete removal of any pyridine bases. This dilute acid may be prepared by adding one part of B.O.V. to one part of water, and the amount added to the benzol may vary between  $\frac{3}{4}$  and 1 per cent. The total loss of crude benzol by washing varies considerably according to the quality of the oil; however, a good average may be taken as 3 per cent. Some of the crude benzols contain unsaturated paraffin hydrocarbons, and these, of course, are acted upon by the sulphuric acid used in the washing, and will naturally increase the amount of loss.

In the preparation of pure benzols from a crude benzol, it is often necessary to remove a substance known as thiophene, and also some of its homologues. Thiophene is represented by the chemical formula  $C_4H_4S$ . It has a boiling point of  $84^{\circ}$  C., a specific gravity of 1.07, is colourless, and possesses an odour similar to that of benzene. Concentrated sulphuric acid dissolves thiophene, and if the solution is treated with a trace of isatin, a dark blue colour is produced. As thiophene so closely approaches benzene with reference to its boiling point, it is practically impossible to separate it by distillation. It is therefore necessary to remove it by chemical washing with concentrated sulphuric acid. In order to do this economically, it is wise to submit the crude benzol to a washing, as just described, and then carefully fractionate the same and afterwards re-wash the fraction, which represents the once rectified benzol, with a number of small quantities of D.O.V. It is essential of course to submit the once rectified benzol—after it has undergone several strong acid washes—to a test for thiophene in the chemical laboratory, and when this test gives a satisfactory result, the material may be washed with water and caustic soda, and finally with water as previously described.

With reference to the washing of crude solvent, the process is essentially the same as that already described for crude benzol. It is necessary, however, to use a rather larger quantity of acid, as there is generally a higher percentage of pyridine bases contained

in this material, and in order to produce rectified naphthas of good colour. So that the finished products shall be perfectly free from pyridine and able to pass the Weber test for that substance, it is advisable to use some dilute acid, prior to adding the strong acid (D.O.V.) used in the final acid wash. The following is a good method of washing a crude solvent. For the first wash add about 1 per cent. of B.O.V. at  $146^{\circ}$  Tw. and agitate vigorously for between 20 minutes and  $\frac{1}{2}$  an hour. After the period of agitation, allow to settle to precipitate the pyridine acid, which is run off to the storage tank for further treatment. The second wash of about  $1\frac{1}{2}$  per cent. of B.O.V. is now given, the time of agitation being about the same. After the removal of the pyridine acid, the naphtha is submitted to a third wash with dilute B.O.V. This dilute of B.O.V. may be prepared by taking one part of acid and one part of water, and the amount used should be about  $1\frac{1}{2}$  per cent. Thorough agitation is necessary, and the time should not be less than half an hour. This weak acid wash will completely remove all the pyridine. The contents of the washer should be allowed to settle, and the weak pyridine acid which precipitates, run off to the pyridine acid storage tank. At this point it is advisable to submit a sample of the naphtha in the washer to the Weber test. (See Chapter XVIII, page 161.) If it passes this test, a fourth wash of D.O.V. is given. The quantity of this acid, as a rule, need not exceed more than between  $\frac{3}{4}$  and 1 per cent. It is sometimes necessary, however, to use rather more, but circumstances will have to decide this. The time occupied in agitating should not be prolonged; usually about 25 minutes is ample. After this the contents of the washer should be allowed to rest to deposit acid-tar, and it is just as well to run this material off at intervals of about 10 minutes. If it is allowed to remain too long in the washer, there is a risk of its becoming so thick that it will not run through the outlet. The acid-tar should not be run to the pyridine acid storage tank, but to a separate receptacle.

At least  $1\frac{1}{2}$  hours should be allowed for settling before the water washing is commenced, and it is advisable to thoroughly wash down the sides of the washer, and also spray the water on the surface of the naphtha, allowing it to fall through the same by force of gravity, before any water is agitated with the oil; the water which separates during this process is removed before agitation with clean water is commenced. Further water washes are now given with agitation, which must not be too vigorous. When the wash water comes away from the naphtha practically neutral, a short time for settling is allowed, and the drainings removed. The naphtha is then pumped, or allowed to run by force of gravity, into a second washer for treatment with caustic soda lye of about  $35^{\circ}$  to  $40^{\circ}$  Tw. A large amount is not necessary, the

quantity usually varying between  $\frac{1}{4}$  to  $\frac{1}{2}$  per cent. After about 20 minutes' agitation, the contents of the washer should be allowed to settle thoroughly, the lye wash removed, and the naphtha then submitted to water washes as already described. It is necessary that clean water be used, and the last wash water should come away from the naphtha quite neutral to litmus. When this is the case, the washed crude solvent may be removed to a storage tank or direct to the rectification still.

Many of the crude solvents when washed with strong acid deposit an excess of acid-tar, often of a very resinous nature. A good method of avoiding this is to submit the crude naphtha to a second distillation before washing with acid, *i.e.*, distilling the crude solvent in a steam-heated still, and collecting practically the whole of it in one fraction. This fraction, when washed in a similar fashion to that just described, appears to give a very little acid-tar in the final acid wash. There is also a great improvement as regards the odour of the rectified material. The total loss of crude solvent varies to a much greater extent than that of crude benzol; it may be between 5 and 13 per cent.

In washing crude heavy solvent, a good deal of discretion is necessary. This class of material will contain varying quantities of naphthalene, and in the washing, especially with D.O.V., some of this material becomes sulphonated and is lost; in fact, if not carefully conducted, the loss may amount to as much as 25 per cent. It is generally necessary to use some D.O.V. if a rectified heavy naphtha which will keep its colour when exposed to the light is desired. The method of washing is exactly the same as has already been described, and the average amount of B.O.V. used at  $146^{\circ}$  Tw. is  $2\frac{1}{4}$  per cent.; of dilute B.O.V. (1 : 1)  $\frac{1}{2}$  per cent.; and of D.O.V.  $1\frac{1}{2}$  per cent. It is advisable to divide the quantity of B.O.V. so that three washes may be given with it, and the D.O.V. two. Water washes should be thorough, and it is absolutely necessary to secure neutrality after the acid and soda washes.

## CHAPTER XI

### THE RECTIFICATION OF BENZOLS AND NAPHTHAS

Fractionation of washed crude benzol—preparation of 90's and 50-90's benzol—fractionation of washed crude solvent—preparation of 90 per cent. at 160° C. solvent naphtha—preparation of heavy naphtha—preparation of 75° F. flash naphtha—preparation of 85° F. flash naphtha—preparation of commercial 90 per cent. at 120° C. toluol—preparation of commercially pure benzene, toluene and xylene.

THE chief products obtained by the rectification of crude benzol are 90's benzol and 50-90's benzol, and by a second rectification commercially pure benzol, which will yield about 95 per cent. within  $\frac{1}{2}$  to  $\frac{3}{4}$  of a degree. Crude solvent naphtha on rectification will yield a large number of products, many of which are specially made to the specification of buyers. There are several grades of solvent naphtha, the chief of which is known as 90 per cent. at 160° C. Some of the other grades obtained are solvent naphtha yielding 95 per cent. at 165° C. or 90 per cent. at 190° C., and also those possessing flash points of 75° and 85° Fahr. (Abel's close test). Commercial toluol is also obtained from this crude solvent, and by a second rectification, commercially pure toluol and commercially pure xylol. Crude heavy naphtha will yield various grades of heavy naphtha, the quality, specific gravity, flash point and distillation of which will vary according to the requirements of the buyer.

It will not be possible to give full particulars as to how all the products that may be obtained from these materials are prepared, but brief consideration will be given to the method of producing some of the chief.

Dealing with crude benzol with the object of making 90's benzol. A charge of washed crude benzol is placed into the rectifying still, and closed steam turned on. When the contents of the still become heated throughout, it is advisable to slacken the steam a little, and watch the worm end carefully. As soon as liquid appears at this point, the steam should be regulated to a degree which will allow of the distillates running continuously and not too fast from the worm end. The material which comes over first from the washed crude benzol is termed "fronts," and con-

tains a considerable quantity of carbon disulphide ( $\text{CS}_2$ ). This must not under any circumstances be mixed with the 90's benzol fraction which follows the "fronts," but allowed to run into a separate receiver for further treatment. When the distillate at the worm end reaches a specific gravity of .890 to .898 at  $60^\circ$  Fahr. the tap on the "fore-runnings" or "fronts" main is closed, and that on the 90's benzol main opened, in order that the condensate may run into the 90's benzol tank. Distillation is now proceeded with until a sample collected from the worm end, and submitted to a test in the chemical laboratory, does not begin to distil until  $100^\circ$  C. is reached. It is of course necessary to make tests in the laboratory from time to time in order to guide the stillman. When the point just mentioned is reached, the flow of the distillate is cut off from the benzol tank and allowed to run into another receiver. When the distillate collected at the worm end is tested in the laboratory, and does not commence to boil until  $130^\circ$  C. is reached, the distillation is generally stopped, and the residue either run to a storage tank to await treatment with further bottoms, or on to it is charged some washed crude solvent.

If it is desired to produce 50's-90's benzol, then the 90's benzol fraction is cut a little earlier (about the point when a sample from the worm end on testing shows no distillate until a temperature of  $95^\circ$  C. is reached) and a fraction collected from this point until one is reached at which the distillate, when tested in the laboratory, does not commence to boil until about  $120^\circ$  C. is reached. This fraction is run to a special 50's-90's tank to be dealt with later. Sometimes this quality of benzol is made by adding to the fraction collected some lighter material. At times, however, the fraction itself will yield benzol answering to the tests required, *i.e.*, 50 per cent. at  $100^\circ$  C. and 90 per cent. at  $120^\circ$  C. The residue in the still is removed to a storage tank to await treatment with other bottoms, or else washed crude solvent is charged on to it.

With reference to the methods of making 90 per cent. toluol and also commercially pure benzene, toluene and xylene, a brief description will be given a little further on.

The washed crude solvent is charged into an empty rectification still or else on to the residue from a distillation of crude benzol. Distillation is commenced by the use of closed steam, and the first fraction is collected until a sample taken from the worm end and tested in the laboratory begins to boil at about  $100^\circ$  C. This fraction is generally run into the crude benzol storage tank for working up with another batch. For some classes of benzol, however, this fraction may be run into the 90's benzol receiver. It is necessary to introduce open steam shortly after the distillation commences, but it is not advisable to do this until absolutely essential, and when it is, it must not be turned on too rapidly.



If it is desired to make 90 per cent. at  $160^{\circ}\text{C}$ . solvent naphtha, the end of the next fraction is determined when a sample tested at the worm end shows a specific gravity of about .895 at  $60^{\circ}\text{Fahr}$ ., or if submitted to a distillation test in the laboratory does not begin to boil until  $160^{\circ}\text{C}$ . is reached. It is advisable when working for this, and even other qualities of naphtha, to occasionally test the material in the receiver after a thorough stirring up. For instance, in the case of solvent naphtha, to find what percentage is given off at  $160^{\circ}\text{C}$ .; in fact some stillmen prefer to have their tank tested, as the collection of this fraction comes to a close, for the percentage of distillate yielded at  $160^{\circ}\text{C}$ ., rather than making tests at the worm end. It is necessary of course to discontinue running the distillate into the solvent naphtha tank as soon as the contents of that tank yield 90 per cent. at  $160^{\circ}\text{C}$ . when tested in a retort.

After the solvent naphtha fraction has finished coming over, the distillate is turned into another receiver. This fraction yields what is known as heavy naphtha, and the quality of this naphtha will vary according to how far the distillation is carried, or whether one or more fractions are collected. If it is desired to make a very heavy naphtha, giving about 60 per cent. at  $190^{\circ}\text{C}$ ., then the distillation is finished when a sample at the worm end shows a specific gravity of .980 to .990 at  $60^{\circ}\text{Fahr}$ . Other qualities of heavy naphthas may be prepared by stopping the collection of the distillate at an earlier point. The residue left in the still is either run to creosote or else to a special tank to be worked for naphthalene.

If it is desired to manufacture from the crude solvent fraction a naphtha possessing a flash of  $75^{\circ}\text{Fahr}$ . (Abel's closed test), and giving 90 per cent. at  $160^{\circ}\text{C}$ ., then the following method is adopted. The distillation is commenced and the lighter portion is turned into the crude benzol tank, as already described, and then a further fraction is collected until a test of the material, taken from the worm end, shows no distillate until 130 to  $133^{\circ}\text{C}$ . is reached. This fraction is run into a special tank for re-distillation, or into the solvent naphtha tank, according to conditions obtaining in the works. The distillation is continued from this point until a sample collected from the worm end does not begin to distil until about  $152^{\circ}\text{C}$ . is reached. This fraction will give a  $75^{\circ}$  flash naphtha with a distillation test as already mentioned. The remaining material in the still may be worked for heavy naphthas.

Should it be required to manufacture a solvent naphtha yielding 90 per cent. at  $165^{\circ}\text{C}$ . and possessing a flash point of  $85^{\circ}\text{Fahr}$ ., then the crude solvent is worked first of all for the lighter fraction, as mentioned above, and then a second fraction is taken off, the end of which is determined when the distillate at the worm end,

on testing in the laboratory, does not begin to distil until between 140 and 142° Cent. Between this point and that at which the distillate at the worm end when tested yields 45 per cent. at 165° C. the desired fraction is obtained. The residue in the still is worked for heavy naphthas as previously described.

In making these two qualities of solvent naphtha, a great deal will depend upon the rate of distillation, construction of fractionating column, etc. The slower the rate of distillation the larger the quantity of special material obtained from the charge. It is a very good plan to collect the fraction in say 50 or 80-gallon drums, as this will avoid the risk of spoiling the whole. A sample may be taken from each drum, bulked and tested, and then if necessary the contents of certain drums may be cut out before bulking.

Commercial toluol yielding 90 per cent. at 120° C. is obtained as a rule from crude benzol. This fraction is collected between the point at which a sample of the distillate, when tested, yields nothing until 100° C. is reached, and a further sample when tested does not commence to distil until 120° C. is attained. This point will vary a little according to the quality of the crude benzol.

In the manufacture of commercially pure benzene, toluene and xylene, the method of procedure has to be varied somewhat, it being necessary first of all to distil the crude benzol into two or three fractions, and then re-distil these fractions. In the first distillation the crude benzol is separated into a "fronts" fraction in the manner already described, and then a first fraction is collected until a test of the distillate leaving at the worm end yields nothing until 95° C. is reached. The second fraction is collected between this point and that at which a sample of the distillate collected from the worm end and tested does not begin to distil until 120° C. is reached. A third fraction may be collected, or the residue run to a tank for distillation with other bottoms. The first fraction is submitted to a further distillation in a still provided with a dephlegmator. It should be added here that if desired the crude benzol need not be washed before the first distillation, but the washing be carried out on this fraction and the second fraction obtained in the manner already mentioned. In washing like this, less resinous material is obtained and generally a better quality of product is secured. During the distillation of the first fraction for commercially pure benzene, it is necessary to keep the water in the dephlegmator at a temperature of about 60° Fahr. It is often essential to separate a little forerunnings, "changing over" when a sample collected at the worm end and tested does not commence to boil until 80° C. is reached. The process is continued, and the distillate, and also the contents of the receiver, are tested throughout the operation in order to keep the fraction as close as possible to the desired distilling range, viz.,

one which will yield 95 per cent. within about three quarters of a degree. The finishing point is generally determined when a sample of the distillate collected as it leaves the worm end and tested, does not drop until  $81.5^{\circ}\text{C}$ . is reached. Another quality of commercially pure benzene which drops at  $79.5^{\circ}\text{C}$ . and distils all over under  $1^{\circ}$  is prepared by collecting a fraction between the points at which a sample collected at the worm end and tested drops at  $79^{\circ}\text{C}$ ., and another sample when tested drops at about  $80.5^{\circ}\text{C}$ . Some manufacturers prefer to collect the distillate in 50 or 80-gallon drums and then test the drums and make a suitable mixing. This is a very satisfactory method. Commercially pure benzene should commence to boil at  $80.5^{\circ}\text{C}$ . and yield 95 per cent. at about  $81.3^{\circ}\text{C}$ .

The second fraction obtained from the crude benzol is worked up together with any residue from the first fraction for commercially pure toluene. Water is allowed to run through the dephlegmator until a sample collected at the worm end and submitted to a distillation shows nothing until about  $109^{\circ}\text{C}$ . is reached. At this point the distillate is "changed over" and the fraction just obtained may be worked up with other material for commercially pure benzene. The water supply is now shut off from the dephlegmator, and that contained in the apparatus allowed to get hot. Care should be taken of course to control the steam supply to the still, in order that the distillate does not flow too quickly. The distillation is continued until a sample collected at the worm end and tested does not begin to boil until a temperature of  $110.5^{\circ}\text{C}$ . is reached. Another method of working for the commercially pure toluene fraction is to commence collecting when a sample taken from the worm end and tested commences to distil at  $109^{\circ}\text{C}$ . (or  $110^{\circ}\text{C}$ . or  $111^{\circ}\text{C}$ .), and then work the still very carefully until the distillate as it leaves the worm end ceases to yield 95 per cent. within 0.8 of a degree from the chosen collecting point. The distillate may be collected into one tank and frequently tested, or better in drums which are dealt with as described under commercially pure benzol. Commercially pure toluene may also be manufactured from 90 per cent. toluol by a similar method to that just described. It should commence to boil at  $111^{\circ}\text{C}$ . and yield 95 per cent. at about  $111.8^{\circ}\text{C}$ . Some buyers demand a grade which drops at  $109^{\circ}\text{C}$ . and yields 95 per cent. at  $110^{\circ}\text{C}$ ., others one which drops at  $109.8^{\circ}\text{C}$ . and yields 95 per cent. at  $110.8^{\circ}\text{C}$ .

Commercially pure xylene is obtained from the residue left from the distillation of pure benzene and pure toluene. These bottoms are worked up in a still provided with a dephlegmator, but almost all the water in the dephlegmator is removed so that the remainder will be converted into steam. The fraction collected for pure xylene comes over between the point at which a sample collected at the worm end and tested in the laboratory does

not distil until a temperature of about  $136.5^{\circ}$  C. is reached, and that at which a further sample when tested shows no distillate below about  $139^{\circ}$  C. These points will vary a little according to the grade required. This product is a mixture of ortho-, meta-, and para-xylenes, and varies a little in test. A frequent requirement is, boiling point  $136.5^{\circ}$  C. 95 per cent. off at  $139.5^{\circ}$  C., and another, boiling point  $136^{\circ}$  C. 90 per cent. off at  $139.5^{\circ}$  C. and 95 per cent. off at  $140.5^{\circ}$  C.

In making these pure products, great care is necessary as regards the speed at which the still is worked. The steam supply must be so regulated that priming does not take place. The water which is passing through the dephlegmator must be kept at a constant temperature. It is necessary that the material should be thoroughly washed with acid, etc., before placing in the still. The best results are obtained if the still is provided with high pressure closed steam, so as to reduce the employment of open steam to a minimum.

## CHAPTER XII

### PLANT FOR THE WORKING UP OF PYRIDINE FROM PYRIDINE ACID

Pyridine acid tanks—egg—neutralized pyridine acid still—condensing coil and tank—pyridine water receiver and drying tank—caustic soda tanks—lime slurry tank—pyridine rectifying still—fractionating column—condensing coil and tank—still “bottoms” tank.

THE plant required for the working up of pyridine acid for pyridine will be dealt with under two heads, viz.: (a) That required for the manufacture of crude pyridine, and (b) that for the manufacture of rectified pyridine. Dealing with the plant for the manufacture of crude pyridine. There are several methods in vogue, and one of these is to manufacture the crude pyridine during the process of making ammonium sulphate. This process requires a plant similar to that used for the manufacture of the latter material, as far as the still, liming apparatus, saturator or cracker box, etc., is concerned. The cracker box is charged with diluted and clarified pyridine acid of a strength of about 50° Tw. instead of diluted B.O.V. A connexion is fitted to the cracker box to conduct away the aqueous pyridine vapours that distil off owing to the heat of chemical reaction between the ammonia and the sulphuric acid, which is in loose combination with the pyridine bases. These vapours are conducted to a suitable condensing coil, and from there to a pyridine water-tank, and the poisonous non-condensable gases are conducted away for treatment by one of the approved methods. The weak pyridine water is allowed to rest, any oil which separates skimmed off, and it is then distilled until about one-third of its volume has been collected. From this point the plant and process resembles that which will be described in this and the following chapter.

For the working up of pyridine acid by a more general process than that just described, the following pieces of apparatus are required: Lead-lined wooden tanks for the dilution of the pyridine acid; a large egg; a still constructed of wrought-iron or mild steel, and provided with suitable fittings; a condenser coil and tank; a pyridine water receiving tank; a pyridine springing and drying tank; one or more caustic soda tanks; a lime mud tank, and suitable staging, tackle, etc.

The lead-lined tanks, or tanks for dealing with the pyridine acid, may be of any suitable shape. If convenience will allow, they should be fairly deep in order to render easier the skimming off of the resinous matter which comes to the top during the process. They may be erected on the ground level, and provided with a connexion near the bottom for running off the clear pyridine acid into the egg. The size of these tanks will of course vary according to the volume of pyridine acid it is required to work.

The egg may be constructed of wrought-iron or mild steel, and if desired, lead-lined. In the writer's experience a mild steel egg has proved quite suitable and very little corrosion seems to take place provided the same is well drained and steamed out after each operation. The size of the egg will vary a little, according to the bulk of material it has to deal with; but a good average capacity is 400 gallons. This piece of apparatus should be provided with a pressure gauge; safety valve; a 1-inch air inlet; a 1-inch steam inlet; a 2-inch outlet-pipe, which dips into a small dish made in the lower part of the egg and almost touches the bottom; a 2-inch pyridine acid inlet; and at the bottom on one end a 1-inch drainpipe and valve.

In order that the diluted pyridine acid may run into the egg by force of gravity, this piece of apparatus should be erected just below ground level. It is advisable to dig a sump deep enough to allow for a three gallon bucket to be placed below the drainpipe. The hole into which the egg is placed, and also the sump, should be brick-lined, and just sufficient space allowed in order that the sides of the apparatus may be inspected; about 4 inches clearance is sufficient. It is advisable to keep this piece of apparatus just off the bottom, supporting it at intervals on non-absorbent bricks, which have been treated with an iron protective compound. It is a good plan to coat the whole of the outside of the egg with a bituminous iron protective paint to prevent rusting.

For the distillation of dilute and neutralized pyridine acid, a still (Fig. 54) constructed of wrought-iron or mild steel plates, about  $\frac{1}{2}$  inch thick, is quite suitable. The bottom of the still should be dished, or better, of the shape of an inverted cone. At the bottom of the dish or the apex of the cone a 12-inch treacle valve or gate valve should be fitted. It will be found that a still with a cone-shaped bottom will discharge the lime mud easier than any other shape. The dome of the still is constructed with a slight rise. On the centre of the dome is fitted a cast-iron swan-neck stool and swan-neck. If desired, however, a 3-inch wrought-iron pipe may be used instead of the swan-neck and swan-neck stool for the purpose of conducting the vapours to the condensing coil. A manhole 18 inches by 12 inches and a draw-up lid should be arranged for on the dome of the still. The charge-pipe will enter the dome of the still and should project a little on the inside;

close to the point of entry should be fitted a cast-iron gland cock. A steam pipe also enters the dome and runs almost to the bottom, where it is connected to an open steam coil. This coil will have to be arranged according to the shape of the bottom; it is advisable to place it as near the bottom as possible, and also, if it can be managed, to arrange for two laps. The diameter of this coil and the steam pipe supplying it will vary of course according to the size of the still. As a precaution a small safety valve of suitable type may be fitted to the still dome, or to the swan-neck. In order to wash away any lime slurry which may lodge on the bottom, particularly near the steam coil, it is as well to provide a 1-inch or 1½-inch water supply, to which may be connected a piece of flexible hose. After the still has been discharged and is cool, water may be played by means of the hose through the man-hole, and by this means the still can be thoroughly washed out after each operation. It is not possible to give any figures as regards the size of the still; this will vary naturally according to the volume of pyridine acid to be worked up at any given time.

Connected to the vapour pipe of the still is a condenser coil, composed of a number of laps of wrought-iron pipe, circular in plan. This coil will vary in diameter according to the size of the still to which it is fitted. For instance, a still of a total capacity of about 1,500 gallons would require a condensing coil of 3 inches in diameter and about 150 feet long. The distance between each lap should not be less than 4 inches in order to allow a free circulation of water, and the distance between the edge of the condenser coil tank and the outside edge of the coil should be about 9 inches. A cylindrical wrought-iron tank constructed of ¼-inch plates is

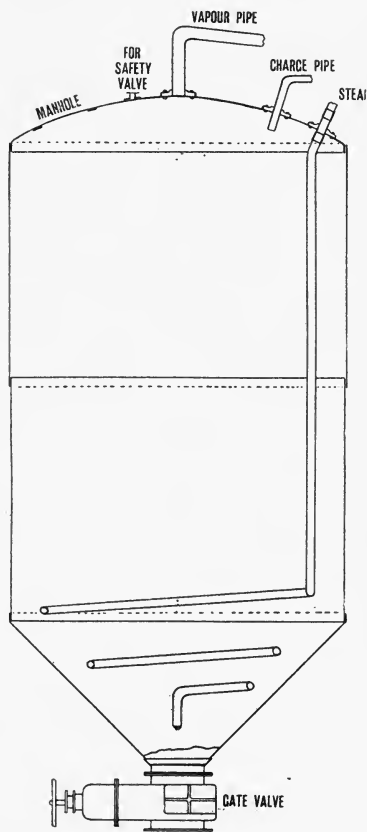

FIG. 54.—Still for the Distillation of Neutralized Pyridine Acid.

used to contain the coil. This tank is provided at the top with a water outlet and a water supply pipe, which should reach to within about 2 inches of the bottom. The end of the condenser coil may be put either through the bottom or the side of the tank, and is connected up to a delivery direct into the pyridine water receiver. It is as well to place at the bottom of the condenser tank a 1-inch drain tap, in order that the water may be removed if the tank or the coil require repairing.

For the collection of the pyridine water that runs from the condenser coil, a square, cylindrical or rectangular tank may be used according to convenience. This tank may be constructed of wrought-iron or mild steel plates, and should be covered in at the top with a wooden cover, which can be easily removed. It should be provided with a 2-inch run-off tap. In many cases it is convenient to use this receiver for the purpose of separating the pyridine from the water and then drying it. If it is not convenient to do this, then a further tank will be required. This tank will of course have to be connected to the receiver and provided with two 2-inch run off taps, one for the removal of spent soda and the other for dried pyridine, and also an inlet pipe to convey caustic soda to the contents of the tank during the drying operation. It may be constructed of mild steel plates, or of wood, lead-lined.

In the process of drying pyridine, strong caustic soda is required, and it is necessary to provide a tank for holding this. A further tank will be required, into which the dilute caustic soda may be run after the operation. If solid caustic soda is used to prepare the strong solution, then the strong lye tank must be provided with a grid, the bottom of which must be just covered with water when the tank is say three parts full. This grid is required to support the split drum of solid caustic soda. The process of dissolving will go on mechanically, especially if a small open steam coil is placed in the tank and the water warmed. Some manufacturers prefer to use liquid caustic soda of 90° Tw., and if this material be employed, then it is not necessary to place a grid in the strong lye tank, as this quality of soda may be run out of the drums into the tank. In order to transport the strong caustic soda lye into the pyridine drying tank, an egg or blow boiler is required (some prefer to use a pump, but this plan cannot be recommended). If convenient, the weak pyridine acid egg may be employed for this purpose. If this method is not convenient, then a rather smaller egg may be put in.

A tank is required into which the lime slurry from the pyridine still may be run after the completion of an operation. This tank should be placed immediately underneath the still, and should of course be of sufficient size to easily contain the whole discharge. As this slurry is generally very wet, and a certain amount of water is dropped on to it during the washing down of the still, it is a good



plan to build into the tank a filter bed, similar to that described in the manufacture of caustic soda (Chapter VII, page 74). This will materially assist in the separating of the water from the slurry. The slurry is dealt with in a very similar fashion to the lime-mud from the causticizers, and should it be necessary, owing to circumstances, to produce a very stiff mud before removing from the works, then a centrifugal machine may be required to deal finally with the material.

With reference to the position of the various pieces of plant described, it is necessary that the still be erected of sufficient height to allow the condenser coil and tank, and also the pyridine water and drying tanks, being placed above ground level. The pyridine drying tank should be of such a height from the floor, that drums,

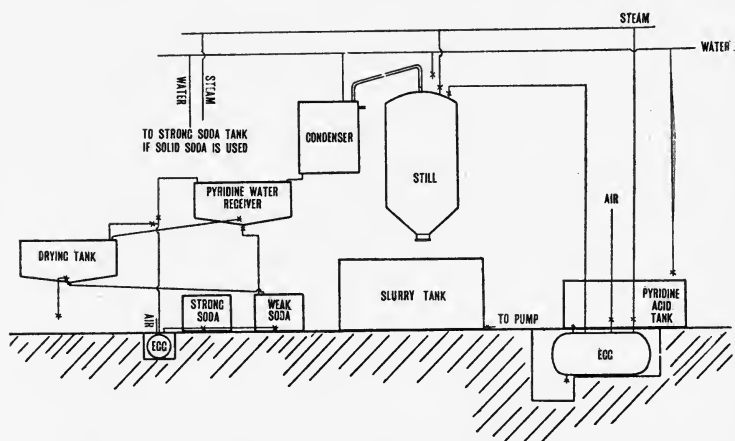

FIG. 55.—Diagrammatic Illustration of one method of arranging a Recovery Plant for Crude Pyridine.

carboys or barrels may be filled from it by force of gravity through the run-off tap. The lime slurry tank may be placed on the ground level, or a little above the same, according to convenience. The caustic soda tanks should be on the ground level, and the egg, if one is put in for dealing with the caustic soda, should be placed in close proximity to the tanks and just below ground level. Over the caustic soda tanks and the pyridine drying tank a runway should be placed, on to which a chain block and pulley is fitted for the purpose of hauling up caustic soda drums, etc. Necessary staging, made of wood, may be erected round the tanks for the convenience of the workmen attending the process. Fig. 55 shows diagrammatically one method of arranging the plant.

For the rectification of crude dried pyridine, the following are

the chief pieces of plant required: A wrought-iron or mild steel still with fittings; fractionating tower; condenser coil and condenser tank; receiver or receivers (some prefer working into small drums or carboys), and one or more bottoms tanks.

The still may be constructed of  $\frac{1}{2}$ -inch plates. The bottom should be concave and connected to a channel plate in a similar manner to that described under tar stills. A suitable run-off or tail pipe is fitted to the still for the discharge of bottoms. The dome of the still should have a slight rise, and in the centre of the same a swan-neck stool and swan-neck should be fitted. A charge-pipe should be connected to the still at the top, and it should also be provided with a manhole and draw-up manlid. It is advisable to fit a safety valve to the still. The still settings, flues, fireplace, etc., should be built in a similar fashion to that described under tar stills, but it must be borne in mind that the top of the flue should be just below the level of the liquid left in the still at the finish of the operation, otherwise there is a risk of the still plates getting burnt.

Connected with the swan-neck is a small fractionating tower or column. This tower may be cylindrical in shape and built of wrought-iron. Inside the column a series of perforated plates are fitted, and the number of these plates need not be large, say between 10 to 15. One constructed on a similar plan to that shown in Fig. 51 will prove quite suitable. The column is provided at the bottom with a U return pipe, which is led into the still, and at the top with a vapour pipe which is connected to the condenser coil.

With reference to the condenser coil, this is best constructed of lead. It should be properly stayed inside the condenser tank, which is constructed of wrought-iron. The usual water supply and outlet arrangements and drain tap are fitted to the tank. The end of the coil is connected to a small observation tank, which may be constructed of wood and lead lined, and provided with an outlet, which may lead to receivers, or through which the distillate can be run into carboys or drums.

Tanks for the storage of still bottoms may be constructed of wrought-iron or mild steel plates, and built of any suitable shape. They should of course be covered, and provided with a manhole and lid, charge-pipe, discharge-pipe, and air outlet. The latter is necessary to let out the air when running in the bottoms. These tanks may be placed in any suitable position near the still, according to convenience.

## CHAPTER XIII

### THE RECOVERY AND RECTIFICATION OF PYRIDINE BASES

Diluting and distillation of pyridine acid—recovery of crude pyridine bases from pyridine water—drying crude pyridine bases—rectifying dried crude pyridine bases—preparation of 90 per cent. at 140° C. pyridine bases and also heavy bases.

THE pyridine acid as it is run off from the bottom of the washing tanks, contains, in addition to pyridine bases, oily and resinous substances. It is necessary to separate these substances before the pyridine can be recovered. This is done by adding clean water, with thorough stirring, and the amount added is, as a rule, about the same bulk as that of the pyridine acid. Some prefer to work to a specific gravity, and if this is done, the same will vary between 40 and 45° Tw. It should be borne in mind that unless sufficient water is added, some of the oil and resinous matter may be retained in the pyridine acid, and if this does happen, the whole batch of crude pyridine may be spoilt. It is far better to slightly over, than under, dilute the pyridine acid. A point worth bearing in mind is that sometimes the first wash water (after the acid washes) from the benzol and naphtha, may contain some pyridine bases, and therefore this water may be used with advantage to dilute the pyridine acid.

After the addition of the water, and a thorough stirring, the contents of the tank are allowed to rest for some hours. It is advisable, if it can possibly be managed, to allow the contents of the tank to rest overnight; the longer the period of rest, the more complete the separation of oily and resinous matters. When these substances have completely separated, they are skimmed off the subnatant clarified pyridine acid. Should the mass be heavy and resinous in nature, it is usually burnt at the steam boilers. If, however, it is oily and will flow, it may be mixed with creosote oil, or if it appears to be composed to a large extent of unaltered benzene hydrocarbons, then it may be mixed with crude oils. If it is mixed with creosote or crude oils, care must of course be taken that no acid liquor is removed with it.

It is wise to submit a sample of pyridine acid to a test in the laboratory to see whether it is saturated with pyridine bases.

If it is not, it may be used as a first wash on a fresh oil, after it has been diluted a little, and the oily and resinous matter skimmed off. By this means a further quantity of pyridine bases will be taken up and generally a complete saturation obtained, at the same time very little oily or resinous matter is picked up. Pyridine acid of this nature must, however, be put through the same process of dilution as that already described before the working up for the recovery of bases.

The clarified pyridine acid is run from the bottom of the diluting or treatment tank into the acid-egg. In the meantime the still is charged with a quantity of quicklime. The quicklime is slaked while in the still, and the mass thoroughly boiled up with open steam, the manlid of course being closed prior to the boiling operation. When the lime-milk is thoroughly heated, the pyridine acid in the egg may be blown into the still. The pyridine acid should not, under any circumstances, be introduced into the still first, as owing to its more or less acid nature, it is apt to act upon the metal, and also as the reaction with lime commences at once, the addition of this material last will make the operation obnoxious and may result in some loss. It will generally be found that the distillation commences almost as soon as the contents of the egg have been discharged into the still, and on this account care must be taken when introducing open steam into the still, otherwise there is a risk of blowing over some of the contents into the coil and receiving tank. It must of course be remembered that the water flow through the condenser tank should be started before charging the pyridine acid on to the lime-milk. Immediately the acid-egg is discharged it is advisable to open the drain cock and thoroughly drain, and then cleanse by blowing open steam into the egg for a short time.

The rate of distillation is controlled so that the distillate (which consists for some considerable part of the operation of a solution of pyridine bases in water) flows from the worm end in a stream about the thickness of three fingers placed together. This distillate should leave the condenser coil at the beginning perfectly clear; not cloudy. There are times when a slight cloudiness appears, which clears up in say about ten minutes. If, however, the cloudiness persists for any considerable length of time, then it is an indication that an excess of oily matter has got into the still with the pyridine acid. In a case like this, there is nothing to do but finish the distillation and recover the pyridine, as will be described shortly, dissolve the same in dilute acid, and allow the oil to separate and then skim off, after which the clarified pyridine acid will have to be submitted to another distillation. Towards the end of the distillation, it will be noticed that the distillate leaves the worm end cloudy. This cloudiness is not due to oily material, but to heavy pyridine bases which are not soluble in

water. These bases are worth recovering, but are not so valuable as the soluble ones, and the distillation is continued for some little time after the appearance of the cloudiness which indicates their presence. The best method of obtaining the point at which the distillation should be discontinued is to examine by a rough test a sample of the distillate as it leaves the worm end for the percentage of pyridine bases. This test is carried out as follows. Two hundred c.c.'s of the distillate are run into a separating funnel and "sprung" with about 80 c.c.'s of 90° Tw. caustic soda. After a short rest the under-lye is removed and a further quantity of 90° Tw. caustic soda (about 50 c.c.'s) added. The lot is well shaken, allowed to rest, the under-lye removed and the bases run into a graduated measure.

If it is desired to recover all the heavy bases possible, then the distillation should cease when about  $\frac{1}{2}$  per cent. is present in the distillate, otherwise the operation is brought to a close when 1 per cent. of bases are present in the distillate as it runs from the worm end. The length of time which a still may run between 1 and  $\frac{1}{2}$  per cent. is sometimes considerable, and it may cost in many cases more for steam, etc., than the heavy bases which are recovered are worth. In addition to this, there is such a large volume of water distilling into the pyridine water tank that a very considerable amount of soda will be required to throw the whole of the pyridine bases up, and this will result in a very weak recovered caustic lye, which may require concentration before it can be used in the works for any other purpose. With further reference to this point, some distillers prefer to collect heavier bases in a separate tank and spring them separately with soda. Throughout the whole operation the distillate should leave the worm end at a temperature below 75° Fahr.

It is advisable to discharge the contents of the still through the gate valve at the bottom into the tank underneath very shortly after the operation of distillation is finished. If this is not done, there is a tendency for the lime residue (this consists chiefly of a mixture of calcium sulphate and unreacted-upon lime) to settle on to the still bottom and sides into a dense mass which is difficult to remove. As soon as possible after the discharge of the lime mud, the manhole should be opened, and the sides and bottom of the still washed down with cold water. The mud, after draining by filtration or any other method found suitable in the works, is either taken to a "tip," or got rid of in any other suitable manner.

With reference to the quantity of lime required for a distillation of clarified pyridine acid, this will vary somewhat according to the amount of sulphates of the bases present. It is as well to submit a small quantity to an examination in the chemical laboratory for the amount of sulphuric acid, and then

calculate the quantity of lime required for neutralization. A slight excess over this quantity is generally added. As a guide 500 gallons of clarified pyridine acid, at a strength of about 40° Tw., will require 1,600 lbs. of Buxton lime. The writer, however, strongly advises a laboratory test to be made each time, rather than working by rule of thumb.

The weak pyridine water in the receiver will contain a varying quantity of pyridine bases. Average amounts range between 35 and 40 per cent. This pyridine is recovered in most works by the addition of caustic soda of moderately high specific gravity. Pyridine bases are not soluble to any appreciable extent in solutions of caustic soda above 30° Tw. It is therefore necessary to use a strength of caustic soda sufficiently high to yield an under-lye of a strength not less than 30° Tw. or 1.15 specific gravity at 60° Fahr. A good strength to use for the separation or springing of the pyridine bases from the water is between 45 to 50° Tw. While adding the caustic soda lye, the contents of the tank should be thoroughly agitated, and when this operation is finished, a period of resting of say one or two hours should be allowed. The weak under-lye may then be run off into a storage tank for further use, say for the recovery of cresylic acid or phenols, or it may be concentrated or reinforced with solid caustic soda to raise its strength. The pyridine which has separated will yet contain water, and it is necessary on this account to dry the same.

The pyridine bases are considered as sufficiently "dry" when they contain not more than 4 per cent. of water. The drying process may require several treatments with strong caustic soda, but in all cases the last operation should be conducted with a caustic soda lye of a strength of not less than 90° Tw. In the writer's opinion caustic soda for use in the drying operations should not be weaker than 60° Tw. for a commencement. It is not possible to give any definite figures in connexion with the volume required to dry pyridine bases, but these quantities can be found quite easily by carrying out rough laboratory tests on a given quantity of the bases. If 50 c.c.'s are taken in a 100 c.c. test mixer, and small quantities of caustic soda of the strength it is desired to use are added, shaking after each addition and allowing to settle until a point is reached where a further addition of the caustic lye shows no further shrinkage of the pyridine bases, then from the amount of caustic soda required to reach this point, the volume necessary to dry the bases contained in the treatment tank can be obtained by a simple calculation.

In a works where the CO<sub>2</sub> process for the recovery of phenols is in use, the pyridine may be conveniently sprung or separated from the water by the use of soda ash (58 per cent. alkali). It must be remembered, however, that the separated pyridine

cannot be dried with this material. The under-lye of soda ash solution can be used for reinforcing the spent liquor (impure carbonate of soda solution) obtained from the reaction tower before the same is causticized. (See Chapter VIII, page 81.)

This under-lye may also be causticized after diluting to a strength of about 23° Tw. and then used in the CO<sub>2</sub> process or else concentrated and used on the pyridine plant. The soda ash should be added in the dry state, and after each addition of say a couple of hundred pounds, the tank contents should be very thoroughly agitated. It is necessary to continue this agitation until the whole of the ash has dissolved, after which the contents are allowed to rest to enable the "sprung" pyridine to rise to the surface. The under-lye of soda ash solution is run off and any drainings removed before the addition of caustic soda for the purpose of drying.

With reference to the quantity of soda ash required to "spring" pyridine bases from weak pyridine water, the following figures may serve as a guide. To every 100 gallons of pyridine water, about 170 lbs. of 58 per cent. soda ash is added. The under-lye after the separation of the pyridine bases will test about 40° Tw. If soda ash is used for "springing," the drying operation is carried out in the manner already described.

The "springing" and drying operation may be carried out in the receiving tank, but it is advisable, especially in cases in which a large volume of pyridine acid is to be worked up, to carry out this series of operations in another tank. This will relieve the receiver, and a further distilling operation may be carried on within an hour or so of the finish of the previous one.

The dried pyridine may be run into a storage tank to await the process of rectification, or if this process is not carried out at the works, then it is generally filled into barrels, or better still iron drums, ready for dispatch. It is necessary of course to sell this material on a test, and the method of carrying this out will be found on page 149, Chapter XVIII.

In the process of rectifying crude dried pyridine, it is a good policy to collect the fractions into small receivers or packages, so that each may be tested at the end of the operation, and a suitable mixing made to obtain a rectified pyridine, which will answer any test required by the buyer. The two chief types of rectified pyridine are: one which will give not less than 90 per cent. at 140° C. when distilled in 100 c.c. Wurtz flask, and the other which yields 50 per cent. up to 140 and 90 per cent. up to 160° C. There are other tests which these rectified pyridines are required to answer, and they will be described fully in Chapter XVIII.

Having charged the still with a quantity of crude dried pyridine, the fire is lighted, and the temperature of the still con-

tents raised fairly rapidly at first, but as soon as the dome begins to get hot the firing is carefully regulated until the distillate appears at the worm end. Priming into the fractionating column must be avoided.

The distillate is now collected until a sample taken from the worm end and tested does not commence to distil until  $140^{\circ}$  C. is reached. This fraction may be collected in a single receiver and reserved for 90 per cent. at  $140^{\circ}$  C. pyridine. If this is done it is advisable to frequently test the contents of the receiver for the percentage at  $140^{\circ}$  C., after a thorough mixing, when the change-over point is near at hand. The distillation is continued from the point just mentioned until a sample collected at the worm end and tested does not yield anything at  $160^{\circ}$  C. This fraction is known as heavy refined pyridine.

Another plan may be used for collecting the first fraction from the distillation of crude pyridine. It is to run the distillate into 40-50 gallon drums and cut for the first fraction, when a sample taken from the drum into which the distillate is "working" and tested yields about 70 per cent. at  $140^{\circ}$  C. The second fraction is collected between this point and that at which a sample of the distillate when tested yields nothing at  $160^{\circ}$  C.

After the second fraction has been collected, distillation is discontinued, and the residue run to the bottoms tank, after an interval of an hour or so in order to allow it to cool down somewhat. The second fraction is refractionated in the same, or a similar still, in order to obtain some more pyridine bases suitable for mixing with the first fraction. It is advisable to split this fraction on redistillation into two portions, cutting the first fraction when a sample from the worm end begins to distil at  $140^{\circ}$  C. and the second fraction when a sample tested from the worm end yields nothing at  $160^{\circ}$  C. The residue in the still is run to the bottoms tank. It is a good plan to collect these two fractions in carboys or small drums, as it renders it more convenient when carrying out the mixing process.

With reference to this process, it is not easy to describe in detail the method of carrying it out. It requires a few months' experience in order to correctly decide how many gallons of bases giving one test should be added to bases of another test to produce the desired result. It is a good plan to test the contents of the carboys obtained from the refractionation of the second fraction from the first distillation, and also the contents of the drums, which comprise the first fraction from the first distillation. Having obtained these distillation tests, experience will teach whether the contents of one or more carboys from the redistillation of the second fraction should be mixed with the first fraction, or whether any of the first fraction should be removed before the mixing is carried out. If it is found that the contents of any of



the carboys or drums contain oil, or an excess of water, then they should be rejected for re-working. It is often possible to use pyridine bases containing a fair quantity of water, as the greater part of the distillate is generally free from this substance. If a little oil be present it is generally quite safe to employ for mixing, but it must be used with caution. In the finished pyridine, according to most specifications, water should not exceed 7 per cent., and when tested according to usual specifications, should show no signs of oil. The methods of testing pyridine bases, both crude and rectified, will be described in Chapter XVIII.

With reference to the bottoms, these are sometimes re-fractionated, and may yield 2 per cent. or 3 per cent. below  $140^{\circ}\text{C}$ . This of course is useful for mixing purposes. The distillation may now be carried on up to a point where a sample collected from the worm end and tested yields nothing at about  $180^{\circ}\text{C}$ ., and this distillate can be sold as heavy bases. Sometimes the bottoms are sold under the same term without redistillation.

With reference to cleaning the still, it is policy to carry out this operation after every second distillation, when working dried, crude pyridine, and after every distillation when working bottoms or heavy bases.

## CHAPTER XIV

### PLANT FOR THE MANUFACTURE OF CRUDE NAPHTHALENE AND ANTHRACENE

Salting-out tanks—recrystallizing tanks—hydraulic presses—centrifugal machine—anthracene oil still—crystallizing tanks—hydraulic press—filter press—grinding machinery—washing tank.

CRUDE naphthalene and anthracene are not prepared in all tar distilleries, and this remark applies especially to the latter product. It is thought advisable, however, to deal with the subject briefly in this and the next chapter. Crude naphthalene is placed on the market chiefly in three qualities, viz.: drained, pressed and "whizzed"; and the pieces of plant necessary for the production of these qualities are as follows: Salting-out tanks or boilers, recrystallizing tanks, hydraulic presses, centrifugal machines, together with the necessary steam piping, bags, staging, etc.

The salting out tanks or boilers may be of any convenient shape. Usually they are second-hand steam boilers with the tubes drawn and the ends blanked, or else second-hand egg-ended steam boilers. The size of these tanks or boilers varies generally between 4,000 to 10,000 gallons. Each tank should be provided with a 2-inch inlet pipe; one 2-inch outlet pipe with tap placed at the bottom for the purpose of draining, the outlet being closed inside by means of a lead-lined plug with a long handle, to prevent it getting salted up (this pipe may be connected to a pump if desired, or else arranged to lead the liquid oil into storage tanks by force of gravity); a suitable closed steam coil, built up of  $1\frac{1}{2}$ -inch steampipe; a manhole of the usual size and provided with a loose cover; and also a 2-inch outlet pipe and tap, which may be placed at the bottom of the tank for the removal of the melted salts. Some prefer to put in a by-pass on the draining pipe, and use this for the removal of the melted salts. Others prefer to insert through the top of the boiler a suction pipe reaching to the bottom for the same purpose. Neither of these plans is good. The outlet pipe for the melted salts is connected up to a steam pump, and a pipe line is arranged from the

delivery side of the pump, so that the liquid may be delivered into the recrystallizing tanks. Reducing T's should be placed on the suction and delivery mains, and connected up to a 1-inch steam pipe, so that steam may be blown through the pipes after the pumping operation, in order to thoroughly clean them and prevent them becoming salted up or choked. The number of salting-out tanks or boilers required will vary of course according to the quantity of salty oil it is desired to deal with per day.

Tanks for recrystallizing the melted salts should be shallow. A general size is 8 feet wide, 14 feet long and 2 feet deep. The tanks may be placed on the ground level, or better a foot or two above the same, as this will allow air to circulate round them. They are provided with one or more 2-inch outlet pipes and taps, by which to drain away the mother liquor or oil which separates into underground tanks or boilers. The outlet holes should be closed by means of lead-lined plugs with a handle to facilitate their removal. These tanks must of course be under cover, and it is an advantage to arrange that the room in which these tanks are placed can be suitably cooled, or else the tanks themselves may be artificially chilled during hot weather. It may be added that many works do not trouble about chilling at all, but recover just so much salts as will crystallize out at the temperature existing during the time of working.

The salts from the recrystallizing tank are removed by manual labour, and either pressed in hydraulic presses or dealt with in a centrifugal machine. Suitable types of hydraulic press are shown in Figs. 56 and 57. The head, bottom and table of these presses are of the best cast-iron, machined where necessary. Close-grained cast-iron is used for the ram, and it is polished the full length to fit the cylinder, which is constructed of best cast steel and supplied with a steel gland. The columns are made of mild steel and fitted with steel nuts. Division plates of mild steel are



FIG. 56.—Hydraulic Press.

supplied loose or as part of the press, as shown in Fig. 57. Centrifugal machines are specially made for this purpose by several firms, and an excellent type is illustrated in Fig. 58. This machine is electrically driven and suspended on three pillars so arranged that the vibration is absorbed and the necessity for a massive foundation done away with. It is self-contained, the electric motor being built on to the centre spindle. The

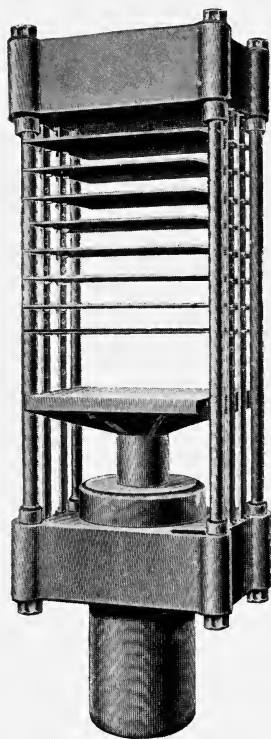

FIG. 57.—Hydraulic Press.

electric motor is fitted with an automatic starting gear, which makes the machine fool-proof, and the starting up quite automatic. An outlet is provided in the revolving basket through which the "whizzed" material can be discharged down the discharge shoot and on to a small truck or barrow, or into a sack placed underneath. Steam-driven machines are sometimes employed instead of electrically-driven ones. It is of course necessary to provide an underground tank into which the oil pressed out during the application of hydraulic pressure, or separated by centrifugal force in the "whizzing" operation, can be run.

The methods of working up crude anthracene vary: some prefer to re-distil the green oil, others to simply allow the same to cool and separate out the crude anthracene. If it is desired to distil the oil before treatment, then it is necessary to put in a still of wrought-iron or mild steel, somewhat similar to a tar still in shape, and provided with similar fittings, such as charge pipe, outlet pipe, swan-neck and stool, safety valve, manhole and lid, etc. The still

bottom should not be built with very much rise, the crown plate having a rise of between 12 inches and 18 inches. The concave portion of the bottom is connected to channel plates, as already described under tar stills, and the dome of the still should have a rise of between 12 inches to 14 inches, according to the size of the still. It is of course necessary to connect the still to a condenser coil, which latter piece of apparatus will require the usual condenser tank, fitted in all respects as described under tar or light oil stills. The number of receivers will vary according

to the desire to separate the distillate into one, two or three fractions. Whether the green oil or anthracene oil is distilled or not, the remainder of the plant is practically the same. It consists chiefly of shallow crystallizing tanks, about the same size as those used for the recrystallization of the naphthalene, a filter press or presses, washing tanks, one or more hydraulic presses, and an edge runner or other suitable mill for grinding the washed and re-pressed anthracene. The crystallizing tanks

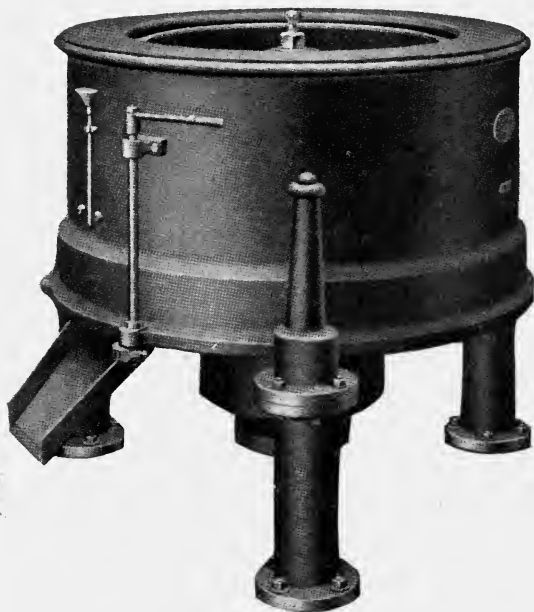

FIG. 58.—Centrifugal Machine.

are fitted up with 2-inch pipes and taps at the bottom for the purpose of draining. They should of course be under cover, and sometimes the chamber in which they are erected is artificially cooled during the summer months. As a matter of fact the arrangement of these tanks and their fittings is very similar to that already described under naphthalene recrystallizing tanks.

There are several suitable makes of filter press and hydraulic press. Two types of the latter are shown in Figs. 56 and 57, and described on page 127. If it is desired to press the crude anthracene at an elevated temperature, then a horizontal or vertical

hydraulic hot press must be installed. In the best types of hot press each division plate is connected to a flexible steam pipe and so constructed that steam may circulate in its interior. An excellent type of filter press is illustrated in Fig. 59. For dealing with anthracene this piece of apparatus is usually made with very deep chambers and of the flush plate and distance frame type. The plates may be either circular or square in shape, and are fitted with plain bib outlets for the filtrate. With reference to the feed inlet, this can be arranged (*a*) through a passage in one corner of each plate having a port to each distance frame, and (*b*) by a central hole through the plates. In order to secure the

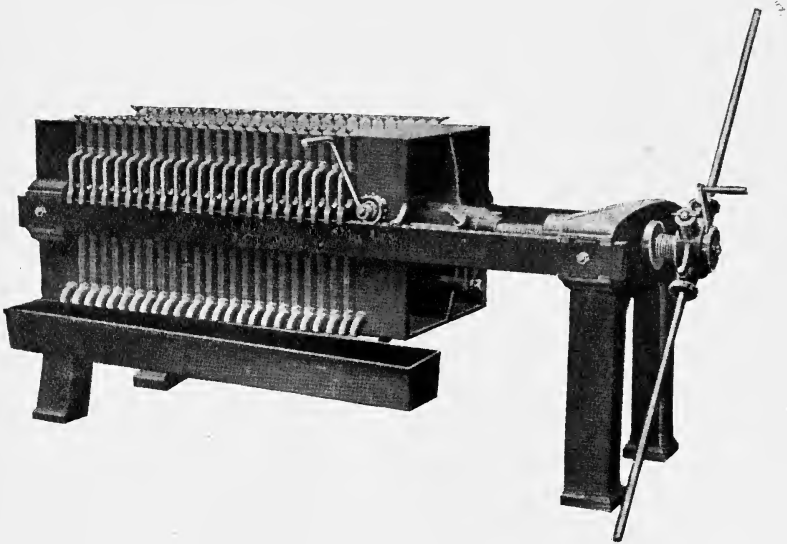

FIG. 59.—Filter Press.

maximum amount of area of cloth available for effective filtration careful attention must be given to the construction of the plates. The plates of the press illustrated have their faces studded with small, truncated, square pyramids, and this in the writer's opinion forms the most efficient support for the filter cloths.

With reference to grinding machinery, one of the many types of edge runner may be used, or a Carr's disintegrator, or other suitable type.

Tanks for washing the anthracene are constructed of wrought-iron or mild steel and provided with paddle or Archimedean screw agitators. They may be erected in a vertical or horizontal position, and should in either case be covered in. The washer

should be fitted with a closed steam coil in order to warm up the charge, a charge-pipe for introducing the washing material, a manhole about 18 inches by 12 inches through which the pressed anthracene may be dropped, and an outlet pipe to remove the contents to the filter press.

## CHAPTER XV

### THE MANUFACTURE OF CRUDE NAPHTHALENE AND ANTHRACENE

Salting-out the oils—recrystallizing the naphthalene salts—“drained” naphthalene—“whizzed” naphthalene—“pressed” naphthalene—distillation of anthracene oil—“salting-out” the oil—filtering the “salted-out” oil—pressing and washing crude anthracene.

IN the manufacture of crude naphthalene, washed light creosote, and also the bottoms from the benzol, naphtha and light oil stills are employed. It is necessary to see that the distillates, such as light creosote, are quite free from tarry matter if they are intended for this purpose. These oils are pumped into the crystallizing boilers and allowed to remain for several days in order to crystallize out the naphthalene or “salts.” The period of time which the contents of these boilers are allowed to rest will vary according to the time of the year and average out between 3 to 5 days. When the “salting-out” is completed, the oil which has separated is drained away through the drainpipes into storage tanks. This oil is tested for its specific gravity, and if found to be low, is mixed with liquid heavier creosotes, or strained green oil, and placed upon the market as liquid creosote. The crude naphthalene remaining in the boilers is melted up by the aid of closed steam, and when the whole of it is in the liquid state, and at a temperature well above the crystallizing point, it is pumped from the boilers into the recrystallizing tanks. Immediately the pumping operation is finished, steam should be blown through the suction and delivery mains, in order to clear them of any liquid salts which may remain and which will, if not removed, solidify in the pipes and cause no end of trouble.

The liquid crude naphthalene in the recrystallizing tanks is allowed to cool down and recrystallize out from the oil which has been carried over from the “salting-out” boilers. After a period varying from two to four days, the drain taps are opened to allow any oil which has separated to run off. This oil is removed to storage boilers or tanks, and allowed to rest for several days, after which it is mixed off with other liquid oils and disposed of as liquid creosote. It may be added that any “salts” which is deposited in these boilers is melted up from time to time and



pumped into the recrystallizing tanks. After the crude naphthalene has thoroughly drained, it may be placed into barrels or other suitable packages and disposed of as drained naphthalene.

If, however, it is desired to prepare from the drained naphthalene a quality known as "whizzed" naphthalene, it is removed from the recrystallizing tanks and charged into centrifugal machines. Care must be taken to level the salts in the cage of the machine, otherwise there is a great risk of wobbling, which may lead to an accident when the machine is set in motion. The cage should not be overcharged, and should not be started up too suddenly. With a good centrifugal, it is possible to "whiz" four to six charges per hour, the size of the charge of course varying according to the dimensions of the centrifugal. Should the centrifugal be self-discharging, then the "whizzed" crude naphthalene may be released from the bottom into a special receiving pan, or direct into sacks. The oil as it flows from the machine is conducted into the liquid creosote storage tanks or boilers.

Pressed naphthalene is prepared by taking the recrystallized crude from the recrystallizing tanks and placing them into press bags. These bags are made of various materials, sometimes even ordinary sacking being used. The size of a bag when filled will vary according to the dimensions of the press, but an average may be taken as 9 inches wide, 18 inches long and 3 inches thick. Care must be taken to keep the thickness of the filled bags as even as possible, otherwise there is a risk of rupturing the press table during the process of pressing. When charging, the press table is run down to the floor of the press. It is then covered with bags, arranged so that there is a space of about 2 inches between each. When the table is full, a wrought-iron plate about  $\frac{1}{4}$  inch thick is placed upon the top of them, and this is covered with bags in a similar manner to the table. This operation is carried out until the press is charged. It is important that care be taken to arrange the plates and the bags on them so that they just cover one another, and do not project on any side. Any unevenness vertically will produce what is known as "shunting," *i.e.*, the middle will bulge out on one side or the other. This will not only produce some half pressed material, but there is a very great risk of the press table fracturing. In some types of hydraulic press the plates are suspended from the press-head by steel links, and when the press is run down this results in the plates being of sufficient distance apart to charge with filled bags. If a press of this kind is used, it is necessary to place the bags on each plate so that they cover those on the plate immediately underneath.

When the operation of charging is completed, hydraulic pressure is applied, and the press gently run up. The pressure is

then slowly increased until it indicates between  $1\frac{1}{2}$  to 2 tons to the square inch. After an interval of about one hour, the hydraulic pressure is released and the press discharged. On opening the bags and removing the pressed cakes, should any wet edges be noticed, these are cut off and re-pressed with another batch. The cakes of pressed naphthalene are now charged into a disintegrating machine, and when thoroughly broken up, placed into packages for dispatch.

In the preparation of crude anthracene, if it is desired to redistil the anthracene oil as obtained direct from coal tar, then a quantity of this is charged into a still, and the fraction which comes over between the point at which the distillate tests  $14^{\circ}$  Tw. at  $60^{\circ}$  Fahr. and that at which it tests  $26^{\circ}$  Tw. at  $60^{\circ}$  Fahr., or when it shows what is termed "grease," collected for this purpose. These figures are only approximate, and have to be varied according to the nature of the oil under treatment. It is rather difficult to explain what is meant by "grease." The distiller, by experience, is enabled to tell from the appearance of the distillate, if a small portion is allowed to cool on a piece of iron or glass plate, when anthracene approximately ceases and higher solid bodies appear. The presence of anthracene in the oil is generally shown by a curdy or gritty appearance when the oil is chilled, and "grease" when the oil on cooling sets to a buttery-like mess. The anthracene fraction is pumped into the crystallizing tanks situated in the press house, and there allowed to cool in order to separate out the crude anthracene.

Should it be desired not to redistil the anthracene oil fraction as obtained from the tar stills, this is pumped from the receiver into the crystallizing tanks, and is submitted to the same process as the redistilled "green oil" fraction. The length of time which the contents of the crystallizing tanks have to rest in order to complete crystallization will vary according to the time of the year, unless the chamber or the tanks are artificially cooled. From two to five days may be taken as averages throughout the year.

After the separation of the crude anthracene has taken place, the contents of the tanks are pumped through filter presses, or else into bag filters, which are prepared by tying special bagging over flanges fitted into the pumping main, and then fastening up the bottoms with cord, the lot being suspended over a tank to catch the drainings; or else into an ordinary filter tank across which is suspended a filter bed made of filter cloth or bagging, and supported by wicker or basket ware. At the present day the filter press is generally used as it deals with the material most expeditiously. In pumping through a filter press, the pressure must be raised gradually and kept as long as possible at a low point. When the press is full and oil ceases to run from the press

plates the press is opened and the cakes of filtered anthracene are removed. The filtrate, whichever way obtained, is known in the trade as strained or dead oil. These cakes may be submitted to pressure in a hydraulic press, and then ground up and washed, or else washed first, and after a further filtering pressed by hydraulic pressure, according to the quality of crude anthracene it is desired to produce. If it is required to press first, the cakes are broken up and charged into bags and then into the press, and then submitted to hydraulic pressure in a similar manner to that described under naphthalene. Sometimes the crude anthracene from the filter is passed through a centrifugal machine before submitting to hydraulic pressure. The filtered material is filled into bags and these are packed into the cage of the centrifugal, or if a suitable gauze is fitted to the cage, the crude anthracene may be charged into it direct. Often hydraulic pressure is applied at an elevated temperature. This is carried out by employing a steam-heated hydraulic press.

After the pressing operation is completed, the cakes are removed from the bags, ground up under an edge-runner or in a disintegrator, charged into the washer and washed with "salted out" (liquid) light creosote or a moderately heavy naphtha free from naphthalene. The quantity of liquid used to wash say one ton of pressed anthracene is about 500 to 600 gallons. When the washer is charged, the contents are heated up by the aid of closed steam and thoroughly well agitated. While washing a temperature of about 80° C. is maintained. The period of agitation varies according to individual ideas, but averages about three hours. After the washing operation, the contents of the washer are allowed to cool down to about 20° C. and then pumped through a filter press, the press cakes removed, either hydraulically pressed, ground up and spread out to dry in a drying room, or else roughly broken up as removed from the filter press and dried. The more complete the separation of the washing liquid from the crude anthracene, the purer the product, so if circumstances allow, it is far better to hydraulically press after the filter pressing operation, than to dry after removing from the filter press. A point worth bearing in mind is that the same kind of oil should be used for the washing of all batches of anthracene, should it be desired to produce the same quality of this material.

## CHAPTER XVI

### PITCH AND PITCH "GETTING"

Soft pitch—medium hard and hard pitch—depth to run pitch in bay—cooling of pitch—protection of pitch-getters' eyes—"getting" or digging pitch—tools—pitch cancer.

THERE are three chief grades of pitch, viz.: soft, medium and hard. These grades are distinguished from one another by what is known as their "twisting" or softening point. This point will vary somewhat according to the method used to obtain it; for soft pitch the average is about  $110^{\circ}$  Fahr., for medium pitch  $140^{\circ}$  Fahr., and for hard pitch  $210^{\circ}$  Fahr. At the present day a very large amount of pitch is purchased on the amount of volatile matter which it contains. The methods of conducting these tests will be fully described in Chapter XVIII.

With reference to soft pitch, this is not made in very large quantities, and when it is, it is generally filled into barrels, when sufficiently cool, instead of running on to a bay. It is a matter of impossibility to dig or "get" this pitch during the summer months. By far the largest quantity of pitch made is of the medium hard quality. This or hard pitch is run from the pitch coolers on to the bay, which is prepared as described in Chapter VI, page 55. It is advisable not to run the pitch to too great a depth, the best thickness being between 15 inches to 18 inches. This depth of pitch will cool rapidly and is dug with a minimum of labour by the pitch-getters. With reference to the length of time that the pitch must remain on the bay before it can be "got," this will vary naturally according to the temperature of the atmosphere and the situation of the pitch bay. Under favourable conditions 24 to 36 hours is all that is necessary, but there are times when two to four days must elapse before pitch can be worked.

During the summer months it is advisable to get the pitch at night, or in the early hours of the morning, rather than during the hottest part of the day; and in order to keep the pitch cool, especially that portion which cannot be worked immediately, the surface should be covered with a thin layer of lime-wash. This

will prevent the absorption of the sun's rays during the daytime. If it is necessary for the men to work pitch which has been lime-washed on the surface during the daytime, especially while the sun is shining upon it, the portion on which they are working should be washed with water and a hard brush to remove the lime-wash, as otherwise the glare will injure the men's eyes.

It is a general practice among pitch-getters, in order to protect the eyes, to wear a piece of black crêpe over them. This is not an efficient method of protecting these organs, as sometimes rather large particles of pitch will fly up from the bed, and will easily damage the eye in spite of the crêpe. Goggles made of fine copper wire gauze of between 30 to 40 meshes to the inch are much more suitable for this purpose, as the gauze will offer a considerable amount of resistance to flying pieces of pitch. It should be added that the workmen do not care about wearing goggles, and in many cases will not even wear crêpe. However, the management should insist upon this means of protection as a precaution against claims under the Workmen's Compensation Act. A good plan in order to prevent excessive rising of dust is to wet the pitch at the point where it is being dug, and often the workmen will carry this precaution out without being told.

Pitch is "got" by driving metal wedges into the layer on the bay with sledge-hammers weighing about 10 to 14 lbs. This breaks off large pieces, which are further broken down by the aid of pickaxes. The pitch is then shovelled into barrows or iron skeps, according to the situation of the bed or the manner adopted by the management for loading trucks or carts. Sometimes the pitch bay is so situated that carts can be backed into it, and loaded direct by throwing the pitch into the same with a shovel. If the bay is below the ground level, then it is necessary either to wheel the pitch in barrows up barrow-runs, or else to raise it in skeps by the means of a crane. Should the pitch bay be above the level of the railway trucks, then it is quite a simple matter to wheel the pitch in barrows from the point where it is being "got" and tip the same into the trucks at the end of the run.

With reference to wedges, these must be made of good steel, about 2 feet 6 inches long and  $1\frac{1}{2}$  inches by  $1\frac{1}{2}$  inches in section; "set temper" steel is a very suitable grade to use. New wedges should be tough but not brittle, as the tendency seems to be for the steel to become very brittle in time owing to repeated hammering and the presence of fine pitch dust, which settles upon the head of the wedge. Brittle wedges are dangerous, as particles fly off and often cause accidents by cutting the "getters" about the body. The same remark applies to the hammers. Sledge-hammers having two faces are the best type to use, and the average workman prefers one of about 10 lbs. in weight.

For many years it has been known that certain men engaged

in the handling of pitch (and also anthracene) develop warty growths. These growths often ulcerate, and at times render it necessary to remove, by surgical treatment, the affected part. A year or two back a special inquiry was made at the instigation of the Home Office into this question, and it was discovered that these ulcerated warty growths occasionally become the seat of what is termed by medical men epitheliomatous cancer. This form of cancer is considered to be the least malignant, and if removed is not usually followed by a recurrence. Draft regulations were drawn up, and in the course of time objections were raised against these. Among the draft regulations, it was suggested that bathing and washing on the factory premises should be carried out. It was required that the workman should take a bath at the works at least every alternate weekday, and wash before leaving the works for meals, or at the end of the day, when a bath is not taken. One of the chief objections raised against this regulation was that of washing and bathing, the workmen stating that the application of water to the skin after pitch-getting caused them a considerable amount of pain. Owing to this and other objections a Home Office inquiry was made to consider the same, and an interesting pamphlet was published dealing with the results of the inquiry.<sup>1</sup>

It appears that pitch dust also causes severe inflammation of the conjunctival membrane and cornea of the eye, and in some cases may result in the formation of epitheliomatous cancer on these membranes. In any case there is great danger of septic inflammation being set up owing to bacteria getting into the ulceration, and the possible chance of the loss of sight. The wearing of goggles or crêpe will not prevent the fine pitch dust from getting into the eyes, and on this account it is advisable to wet the pitch somewhat at the point of working, as already stated, in order to prevent as far as possible the rising of dust during the "getting" operation.

In the pamphlet just mentioned it does not state what is the actual cause of the irritation, although it seems to point to the fact that the cause is due to one or more chemical substances contained in the pitch (or crude anthracene). The writer made some experiments some time ago and was able to isolate small quantities of acridene from coal tar pitch, and on making a few experiments with this material, found that it set up considerable irritation, particularly when applied to mucus membrane and especially when wetted. Possibly acridene is one of the hurtful substances, but it rests with the medical men carrying out the inquiry to settle such a matter as this.

<sup>1</sup> *The Problem of the Gas Works Pitch Industries and Cancer.* John Murray, Albemarle Street, London, W. Price 6d.

## CHAPTER XVII

### CREOSOTE

Variation in specific gravity, distilling range, etc.—Wells' oil—fuel oil—sheep dip creosote—creosote for the manufacture of greases—creosote for the benzol recovery process—creosote for timber preservation—requirements of several specifications—storage of creosote.

THE term creosote is used very broadly in the commercial world, and under it are often included oil-gas tar creosote, wood-tar creosote, coke-oven creosote, blast furnace oil creosote, and several others. In this chapter it is intended to deal with coal tar creosote only.

Coal tar creosote as put on the market varies within fairly wide limits as regards specific gravity, content of phenols and naphthalene and distilling range. The gravity may vary between 1.000 and 1.070. Occasionally samples are met with a little lower in gravity, and sometimes higher. With reference to the percentage of tar acids, creosotes are sold containing but a mere trace up to about 25 per cent., and with regard to the percentage of naphthalene, this varies very considerably, some creosotes containing 30 per cent. and even more, others but mere traces. Some idea of the variation in distilling range will be obtained by referring to Table VI.

TABLE VI

From drop to 200° C.	From drop to 250° C.	From drop to 300° C.	Residue.
per cent. 0 to 16	per cent. 25 to 75	per cent. 63 to 85	per cent. 5 to 35

Creosotes as obtained direct from coal tar by distillation differ somewhat according to the quality of the tar, and more often than not are put through a special treatment, *i.e.*, removing a certain portion of the tar acids or naphthalene, or submitting to a redistillation, before placing on the market. More frequently, owing to the fact that most buyers require creosote to

answer their own specification, blends of various grades have to be made. A creosote required for burning, say in a Wells lamp, must be quite free from dirt and naphthalene. As a matter of fact it should not deposit "salts" (or naphthalene) at a temperature of 40° Fahr. after exposure to that temperature for six hours. The average specific gravity for creosote for this purpose is 1.050–1.060 at 60° Fahr., and it should not contain more than 2 per cent. of water when tested by distillation. A similar quality of creosote is often used for furnace work and is known as fuel oil. If burned with care excellent results may be obtained and smoke troubles need not be feared. The calorific power of fuel oil varies more or less between 16,200 and 17,500 British thermal units.

Creosote intended for the manufacture of sheep dips and disinfectant fluids should not be too heavy in specific gravity. A good average is 1.020 at 60° Fahr. It should contain very little, if any, naphthalene salts and a certain percentage of tar acids. The quantity of these bodies will vary, of course, according to the requirements of the buyer. Some require 3 per cent., others 5, 10, 15 or 20 per cent. Redistilled creosote is the most suitable for sheep dip manufacture.

Sometimes creosote is used in the manufacture of cheap lubricating greases for colliery trucks and bogies. The oil for this purpose must be of the heavy type, and the one most frequently used is that known as strained oil or "dead" oil. This oil has been referred to already in Chapter XV, page 135, and is obtained during the manufacture of crude anthracene. The specific gravity varies somewhat; an oil testing 1.060 at 60° Fahr. is frequently used. These greases are prepared by adding rosin oil and slaked lime to the green oil. Usually the composition varies between 86 to 88 per cent. of heavy oil, 4 to 7 per cent. of rosin oil, 4½ to 6½ per cent. of slaked lime, the remainder being water. In the brick industry creosote sometimes finds application under the name of brick oil. For this purpose it should possess a specific gravity between 1.060 and 1.070, and be quite free from "salts."

Creosote for use in the benzol recovery process must contain no naphthalene salts, not more than 3 per cent. of water, and when distilled in a retort should not begin to distil below 200° C. and yield 70 per cent. between this point and 280° C.

By far the largest quantity of creosote is used for the preservation of timber, particularly railway sleepers, and it may be added here that the United States of America are the largest consumers of this material. Large quantities are of course supplied to the British and continental railway companies by manufacturers in this country, in addition to exporting very considerable quantities to the States. All this creosote is sold



according to specification, each buyer having his own. This will of course necessitate in many cases careful mixing of several grades of oil, and even the removal of a certain amount of tar acids and sometimes the whole of the naphthalene. In other cases it is often necessary to add naphthalene before the creosote will answer the requirements of a certain specification. In order to give some idea of the various requirements of specifications, several are given in Table VII.

TABLE VII

	Specific Gravity.	Water.	Phenols.	Naphthalene.	To be liquid at	Distillation.	Apparatus.
<i>a</i>	1.050-1.060 at 15.5° C.	3 per cent.	10 per cent.	30 per cent. at 15.5° C.	38° C.	Residue above 315° C. 25 per cent.	Retort
<i>b</i>	1.040 at 27° C.	2 per cent.	8 per cent.	Not stated	32° C.	Below 315° C. Not more than 75 per cent.	Wurtz flask
<i>c</i>	1.040-1.050 at 15.5° C.	3 per cent.	4-12 per cent.	Not less than 20 per cent. at 15.5° C.	Not stated	Not stated	—
<i>d</i>	1.090 at 20° C.	2 per cent.	Not stated	Not stated	25° C.	Below 315° C. Not more than 60 per cent.	Not stated
<i>e</i>	1.030 at 15.5° C.	3 per cent.	Do.	Do.	32° C.	Above 260° C. 25 per cent.	Do.
<i>f</i>	Not stated	3 per cent.	Do.	Do.	15.5° C.	No distillate below 200° C. Not more than 70 per cent. at 280° C.	Do.
<i>g</i>	1.000-1.030 at 15.5° C.	2 per cent.	18 per cent. min.	Nil	0° C.	Not less than 50 per cent. at 265° C. Not less than 80 per cent. at 315° C.	Do.

For storage of creosote second-hand boilers may be used. Very frequently large tanks built of iron plates or reinforced concrete, as described in Chapter II, are provided for this purpose and it is policy to cover them. A closed steam coil, or coils, should always be placed in the tanks, the diameter of the tubing varying between 1 inch and 2 inches according to the size of the storage tank. At convenient points in the suction and delivery mains to and from the storage tanks a 1-inch steam inlet should

be fitted. This will enable the pump man to clear the mains with open steam after pumping: a most necessary proceeding when "salty" creosote has been passed through the mains.

With reference to the methods of testing. Unfortunately at the present day there are no standards, and to a large extent each chemist uses his own method for the determination of one or more constants. Some of the tests in use are given in Chapter XVIII.

## CHAPTER XVIII

### TARWORKS' TESTS

Examination of tar—pyridine tests—pitch tests—examination of creosote oil—benzol testing—valuation of crude naphtha—naphtha testing—valuation of light oil—cresylic acid tests—testing metacresol by the long or short cresylite test—carbolic acid tests—anthracene tests—examination of caustic liquors, spent liquors and lime mud—testing coke furnace gases—examination of coke.

#### EXAMINATION OF TAR

*Water.*—A quick method of determining this substance in tar is as follows: One hundred grammes of tar are weighed into an 8-oz. tubulated retort with a long beak, and 20 to 28 c.c.'s of benzol added. The lot is mixed together carefully, and the retort is then suspended on a retort stand. A small flame, preferably that obtained with a Rose burner, is placed under it, and the water and benzol which comes over collected in a measure placed under the beak of the retort. The speed of the distillation must be regulated so that the whole of the distillate is condensed. With this method, the water comes over between from  $\frac{3}{4}$  of an hour to an hour, without frothing.

Another method which gives excellent and rapid results, but which requires a little more apparatus, is carried out as follows: Into the tubulure of an 8-oz. retort is fitted a funnel sufficiently large to hold 150 grammes of tar. The stem of the funnel is shortened and the bore closed by heating in a flame to produce an orifice of about  $\frac{3}{32}$  inch in diameter. On the end of a length of glass rod a small piece of india-rubber tubing is placed, and this is inserted into the stem of the funnel, as shown in Fig. 60. A 100 c.c. measure is required to collect the distillate. The retort must have a long beak, or, better, should be connected to a 12-inch Liebig condenser. Into the retort is placed about 50 c.c.'s of heavy naphtha, free from naphthalene, and 100 grammes of tar are weighed into the funnel. The naphtha is now brought to a boil, and immediately the same commences to distil the tar is allowed to run into it through the small orifice in the funnel stem. It will be found that in a few minutes after the tar has left the funnel the whole of the water contained therein has

distilled over. With care this operation requires from between 20 minutes to half an hour. S. R. Church recommends the following method: Measure 50 c.c.'s of coal tar naphtha, or light oil (which must be free from water), in a 250 c.c. measuring cylinder. Two hundred c.c.'s of tar are then added and the lot mixed. Transfer the contents of the cylinder to a small copper still, and wash out the cylinder with 50 to 75 c.c.'s more of naphtha, adding the washings to the contents of the still. The still is connected up to a tube condenser having a water jacket  $15\frac{1}{2}$  inches long. Heat is then applied by means of a ring burner and distillation carried on until the thermometer indicates a temperature of  $205^{\circ}$  C. The distillate is collected in a separatory funnel,

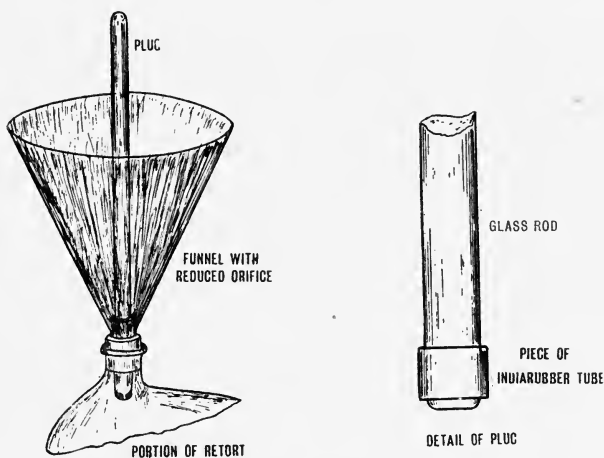

FIG. 60.—Funnel and Plug used in determining Water in Tar.

to which 15 to 20 c.c.'s of benzol have been previously added. The addition of the benzol effects a clean separation of the water from the oil. The water is run off into a measure and the volume read.

*Specific Gravity.*—Frequently the specific gravity of tar is taken by means of a Twaddell hydrometer. In carrying out the test with this instrument, the tar should be brought to  $60^{\circ}$  Fahr. ( $15.5^{\circ}$  C.), and when this temperature is obtained, the hydrometer carefully placed in the centre of the tar, which is contained in a specific gravity jar, and plenty of time allowed for the hydrometer to sink.

Church recommends the following method for taking the specific gravity of tar: Between 300 to 400 c.c.'s of tar are dried

in the same apparatus as used for the water determination but without the addition of naphtha. The distillation is carried on until a temperature of  $170^{\circ}$  C. is reached. Any oil which has distilled over is carefully separated from the water and returned to the tar in the still and thoroughly mixed in after cooling. The specific gravity is carried out on this dehydrated tar in a specific gravity bottle of the Hubbard type, whose water capacity at  $15.5^{\circ}$  C. ( $60^{\circ}$  Fahr.) has been determined by experiment. Ten grammes of tar are introduced at a temperature of 40 to  $50^{\circ}$  C. into the weighing bottle, and the weight taken after cooling. Freshly boiled distilled water is then added, and the bottle kept in a bath at  $15.5^{\circ}$  C. until no further contraction takes place. The water is then adjusted to the mark, and the bottle removed from the bath and weighed. Weight of tar divided by the weight of the water displaced will give the specific gravity.

Another method of taking the specific gravity is to place about 200 c.c.'s of tar in a large covered beaker and immerse the same in warm water, the temperature of which must not exceed  $50^{\circ}$  C. This will cause entangled ammoniacal liquor to collect on the top of the tar, when it is removed either by decantation or absorbing it with blotting-paper. A portion of the dehydrated tar is then placed into a specific gravity bottle (Regnault type) and the determination taken at a temperature of  $15.5^{\circ}$  C.

Lunge estimates the specific gravity of tar by employing a weighing bottle of the shape illustrated in Fig. 61. This bottle is provided with a rill 2 mm.'s wide. The specific gravity is taken as follows: The weighing bottle is first weighed empty, and then again after filling it with water at  $15.5^{\circ}$  C. The bottle is then dried, dehydrated tar poured into it until it is about two-thirds full, and the bottle, without its stopper, is then placed into hot water for about an hour, in order to disperse air bubbles. The weighing bottle and contents are then allowed to cool to a temperature of  $15.5^{\circ}$  C. and weighed. The bottle is now filled with distilled water, the stopper inserted, and any water which issues from the rill is removed, and the whole allowed to stand in a vessel containing water of a temperature of  $15.5^{\circ}$  C. for about an hour, after which the weight is again determined. The specific gravity is found by the following calculation:  $a$  equals the weight of the empty bottle;  $b$  equals the weight of the bottle filled with water;  $c$  equals the weight of the bottle plus the tar;  $d$  equals the weight of the bottle, tar and water;  $s$  equals specific gravity.

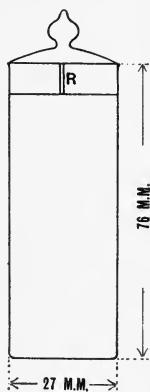

FIG. 61.—Specific Gravity Bottle for Tar Testing.

$$s = \frac{c - a}{b + c - (a + d)}$$

*Free Carbon.*—The methods of determining this material are fairly numerous, but the one which in the writer's opinion gives the best result is that devised by Hooper. This method unfortunately takes a considerable time to carry out, and on this account the writer modified the same, and by doing so reduced the time to about one-quarter of that which is required to carry out Hooper's test. The degree of accuracy is in favour of Hooper's test, but in the case of the writer's method, the amount of error is not a very serious one, and where time is an important matter it may be used. Hooper's test is carried out as follows: Ten grammes of tar are weighed into an extraction-thimble, which is then closed with a cotton wool plug and placed into a Soxhlet apparatus. The thimble and plug are previously extracted with the solvents used in the process, dried and weighed. The tar is then extracted with (a) 90's benzol, (b) 90 per cent. at 140° C. pyridine bases, and (c) unmineralized methylated spirit, extracting 50 times with each solvent. The thimble is then removed, dried in a steam-oven, and weighed when cold.

The following is the writer's method of determining free carbon in tar: An extraction-thimble, plug of cotton wool, and lid of filter paper are extracted, first with 98 per cent. cresylic acid, and then with 90's benzol, until extractions are colourless. The lot are then dried and tared. Ten grammes of tar are weighed into the thimble, the plug inserted, and the filter-paper cap placed over and held in position with a piece of thin platinum wire. The prepared thimble is then placed in a Soxhlet apparatus and allowed to soak in 90's benzol for a quarter of an hour, after which four extractions with 90's benzol are made. Extraction with 98 per cent. cresylic acid is then commenced, and continued until it runs away colourless, after which 90's benzol is passed through the apparatus until it shows no colour. The thimble is then removed from the Soxhlet tube, dried in a steam-oven and weighed when cold.

S. R. Church has adopted a very compact and simple extraction apparatus, for use in the estimation of free carbon in tar, which in the writer's hands has given excellent results. It is illustrated in Fig. 62.

*Sulphur.*—It is sometimes desirable to estimate this substance in coal tar, and a good test is recommended by A. Renfred Myhill. A full description of the method is given in *The Gas World* for 1st February, 1913, and briefly it consists of igniting in a special manner a weighed quantity of tar with anhydrous sodium carbonate in a nickel crucible. After the fusion the mass is lixiviated with distilled water. Any sodium sulphite in solution is oxidized

with bromine water and the total sulphate determined by the usual method with the barium chloride and the result calculated to sulphur.

*Ash.*—This may be carried out by igniting carefully 5 or 10 grammes of tar in a large open porcelain or platinum crucible. Every precaution must be taken at the beginning of the operation to avoid frothing over, especially if the tar contains an excess of entangled liquor. Dehydrated tar may be used for the estimation if desired.

*Testing Tar for Yield of Products.*—

Sometimes it is desired to determine in the laboratory the yield of products which may be obtained from a certain sample of coal tar. Laboratory tests for determining the yield of crude naphtha, light oil, creosotes, pitch, etc., are not very satisfactory, and will not give more than an approximate idea of what may be expected in the works. It is far better to erect in the works an experimental still which will deal with say 5 cwts. or even a ton, or better to work through a charge of say 15 or 20

tons of the tar. There are occasions, of course, when this cannot be done, and then at least two gallons of tar should be distilled in the laboratory. This may be carried out in a specially made copper retort, using a high-pressure gas burner to supply the heat, and surrounding the retort with fire-bricks.

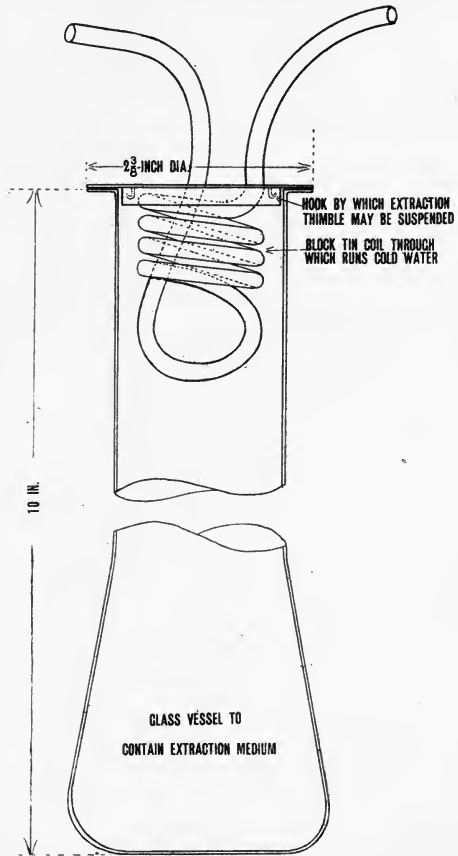

FIG. 62.—Apparatus adopted by Church for the Determination of "Free Carbon" in Tar.

## PYRIDINE

The specification issued by the German Federal Council for testing rectified pyridine bases is as follows:—

*Water.*—This must be under 10 per cent. (it is often required that the water be not over 7 per cent.). The determination is carried out as follows:—Into a special burette (see Fig. 63), 25 c.c.'s of 80° Tw. caustic soda, which must be perfectly clear, are carefully run, and if necessary after standing a short time



FIG. 63.—Burette for Testing Pyridine for Water.

adjusted. On to the top of the soda 25 c.c.'s of the pyridine bases to be tested are placed, a cork inserted into the neck of the burette and the contents gently shaken, after which they are allowed to stand for a short time to separate. The increase in the volume of caustic soda indicates water.

*Distillation.*—Not less than 90 per cent. should distil over up to a temperature of 140° C. when 100 c.c.'s of the bases are distilled in a Wurtz distillation flask, the bulb of the thermometer being opposite the outlet tube.

*Colour.*—This must not be darker than a solution of 2 c.c.'s of N/10 iodine solution in one litre of distilled water.

*Solubility.*—The sample must be completely miscible in water to a clear solution. When 20 c.c.'s of the bases are mixed with 40 c.c.'s of water there should be no separation of oily drops.

*Ammonia.*—This must be absent.

The bases are required to answer the following test: Ten c.c.'s of a 1 per cent. (by volume) solution of bases must give a white precipitate with 5 c.c.'s of Nessler's solution.

*Cadmium Chloride Test.*—Ten c.c.'s of 1 per cent. (by volume) solution of the pyridine bases when mixed with 5 c.c.'s of 5 per cent. aqueous solution of anhydrous cadmium chloride and shaken vigorously should, almost immediately, yield a distinctly crystalline precipitate.

*Titration Test.*—To 1 c.c. of the bases dissolved in 10 c.c.'s of distilled water, N/1H<sub>2</sub>SO<sub>4</sub> is added from a burette until a drop of the mixture gives a distinct blue colour or border on congo paper. At least 10 c.c.'s of acid must be required. The congo paper is prepared by soaking filter paper in a one per thousand solution of congo red, and allowing to dry at ordinary temperature. The paper should be prepared just before the titration is carried out.



In the new specification for pyridine bases the distillation requirements vary from those just given, thus: Up to 140° C. the bases should yield 50 per cent. and up to 160° C. 90 per cent. The titration test is carried out in the same manner, but 1 c.c. of the bases dissolved in 10 c.c.'s of water should require at least 9.5 c.c.'s of N/1 H<sub>2</sub>SO<sub>4</sub>.

*Test for Oil in Crude Pyridine.*—About 250 c.c.'s of the sample are dried with 80° Tw. caustic soda. Of this dried pyridine bases 100 c.c.'s are taken and distilled in a Wurtz flask until 10 c.c.'s have come over. To this volume 90 c.c.'s of distilled water are added and the lot shaken. If the solution becomes turbid oil is indicated. In this case a further 10 c.c.'s are distilled over into another measure and 90 c.c.'s of distilled water added. After mixing, should the solution become turbid, then the batch is rejected as unsuitable, and requiring further treatment.

#### *Valuation Test of Crude Pyridine*

*Water.*—This is carried out in the manner described under German specification for rectified bases (page 148).

*Distillation.*—Two hundred and fifty c.c.'s of the sample are dried by shaking with three separate quantities of 80° to 90° Tw. caustic soda, the volume in each case being about 100 c.c.'s. The dried pyridine is measured, and then placed into a 300 c.c. round-bottomed distilling flask, to which is fitted a le Bel Henninger fractionating head. This head should be provided with three bulbs, and have an overall length of about 20 inches, the distance between the bottom of the head and the outlet of the delivery tube being approximately 13 inches. The fractions are collected as follows: From drop to 140° C. (refined pyridine); from 140 to 160° C. (heavy refined pyridine); from 160 to 180° C. (heavy bases). The refined pyridine fraction is tested for (a) water; (b) oiliness; and (c) percentage of distillate at 140° C. Methods of carrying out these tests have already been described.

#### *Estimation of Pyridine in Naphthas, etc.*

*Rough method.*—Into a 100 c.c. stoppered test mixer 50 c.c.'s of dilute sulphuric acid (1:2) are placed. On to this are run 50 c.c.'s of the oil to be tested, the stopper inserted, and the contents well shaken and allowed to settle. The decrease in the volume of the oil or the increase in that of the acid indicates the amount of pyridine contained in the 50 c.c.'s of oil.

*A more Accurate Method.*—Take 500 c.c.'s of the naphtha, place in a separating funnel and wash with 20 per cent. of diluted B.O.V. (1 acid 2 water) in two lots of 40 c.c.'s and one of 20 c.c.'s. Carefully separate the acid extracts, bulk, place in a steam distillation apparatus, make alkaline with 40° Tw. caustic soda, and then

steam distil until about one-third of the original bulk in the distilling flask has been collected. Place this distillate in a separating funnel and add 90° Tw. caustic soda until no more oil separates, allow to rest, carefully run off the supernatant alkaline liquor, dry the pyridine bases with a little 90° Tw. caustic soda, separate most of the alkali and then run the remainder with the bases into a narrow measuring tube, rinse out the funnel with a little 90° Tw. caustic soda into the tube, allow to rest, and read off volume of pyridine bases.

### PITCH TESTS

The usual tests applied to pitch are: (a) Determination of twisting point, (b) ash, and (c) volatile matter. Occasionally it is required to estimate the specific gravity, and the free carbon.

*Specific Gravity.*—This is estimated by the usual displacement method.

*Free Carbon.*—The method used for estimating this substance is the same as that employed in the case of coal tar. Of course it is advisable to grind the pitch to a powder, should the same be hard enough.

*Twisting Point.*—There are various ways in which this is carried out, and unfortunately this is the cause of many disputes. In the writer's opinion it is far better to rely upon a satisfactory method of estimating the volatile matter in pitch than any method of determining the twist. One method of determining the twist is that of Kohler, which is as follows: Pieces of pitch  $\frac{3}{16}$  inch in thickness are placed in water at 60° C., and after this has cooled to 55° C., the pitch should be easily twisted without breaking. Pitches which answer this test are considered suitable for the manufacture of briquettes.

Another method is to take a 1-oz. sample of the pitch, soften it in warm water, and shape it between the fingers until a rod of approximately  $\frac{1}{2}$  inch in diameter is formed. This is allowed to harden again, and after an interval of about an hour, when immersed in water at 60° C., it should easily twist. A pitch which answers this test may be employed in the manufacture of briquettes.

Another method which is used to determine the twisting point of pitch for the manufacture of patent fuels is to immerse a piece of pitch 4 inches long and  $\frac{3}{4}$  inch in diameter in water at a temperature of 60° C. for two minutes. After the expiration of this time it should bend without breaking.

A method which is used to determine the twisting point of any quality of pitch is to take a sample of the pitch, heat it (in water) sufficiently to make it pliable to the fingers, and then

form a rod about 2 inches long and  $\frac{1}{2}$  inch in diameter. This rod is allowed to harden, and then suspended on a piece of string so that it hangs inside a beaker containing cold water. A thermometer is also suspended inside the beaker, the bulb of which should touch the rod of pitch. The beaker is placed on a wire gauze, and heated with a Rose flame at such a rate that the water increases in temperature  $2^{\circ}$  Fahr. per minute. It is necessary that the water be stirred very frequently to ensure an even temperature, and the pitch occasionally lifted out and an attempt made to twist the same. When it is possible to twist the sample two or three times with only a slight effort the twisting point is found.

*Volatile Matter in Pitch.*—There are several methods of determining this, and unfortunately there is no standard one. The writer made a considerable number of experiments, some little time ago, on the subject of the determination of volatile matter in pitch, and published many of the results in a paper read by him before the Midland Junior Gas Engineering Association.<sup>1</sup> The method which seemed to give the best results is as follows: A porcelain crucible 4 c.m. in diameter and  $2\frac{1}{2}$  c.m. deep, containing 2 grammes of ground pitch, is placed in a Leune furnace (such as is supplied with a Meker burner), with the lid on; the top portion of the furnace being removed. A No. 2 size Meker burner is used. The heating is extended over a period of ten minutes; and the flame kept at full blast the whole time. The furnace cover is put on after the first five minutes has elapsed. The crucible, without the lid, is then allowed to cool in a desiccator and weighed, the loss being the volatile matter.

*Ash in Pitch.*—This may be determined by igniting the residue left after the determination of the volatile matter, or igniting a freshly weighed-up portion. The method of estimation is quite simple and does not need any description.

### CREOSOTE OIL

Much has been written on the testing of coal tar creosote, but up to the present it seems that none of the methods published have been accepted as standard ones. The usual tests to which creosote is submitted are: Specific gravity; and the estimating of the percentage of water, phenols and naphthalene, and also a distillation test in order to determine the distilling range. Occasionally the percentage of free carbon and pyridine bases are estimated. Other tests which are sometimes applied are the

<sup>1</sup> "Investigations of Coal Tar and some of its Products." *Transactions of the Junior Gas Associations*, volume 2, page 105. *The Gas World*, March 2, 1912, p. 284.

solubility of the sample in benzol, the solubility in dimethyl sulphate, flash point, and coefficient of expansion.

*Specific Gravity.*—This is determined in a fairly accurate way by the use of a hydrometer, making a correction for temperature, or, better still, cooling a sample down to a prearranged temperature. It is not always possible to take the gravity of a creosote at  $15.5^{\circ}$  C., as sometimes at this temperature the material is solid or semi-solid. When the oil is liquid at  $15.5^{\circ}$  C. then it is as well that the gravity be taken at that temperature, but should the oil be solid, then it is necessary, of course, to estimate the gravity at a higher one. Sage recommends taking the specific gravity of salty creosotes at a uniform temperature of  $60^{\circ}$  C. Butterfield suggests that the gravity of salty creosotes should be determined at the temperature at which the oil is fully liquid. Often specifications state at which temperature the gravity should be taken, but seldom do they mention the method by which the determination is to be made. If it is desired to obtain a more accurate test, then the picnometer or Regnault gravity bottle should be used. Some chemists recommend the employment of a Westphal balance.

*Percentage of Water.*—This is determined by distilling a measured quantity of the creosote in a retort until no more water is given off. The quantity of oil taken is generally 100 c.c.'s, and the beak of the retort into which it is placed should be long and preferably surrounded by a piece of wet blotting-paper, arranged so that it is possible to occasionally re-moisten during the distilling operation. In any case care must be taken that the distillation is not conducted too rapidly, or else some of the water will not be condensed and escape as steam. Oil, of course, distils over with the water and sometimes does not separate well in the graduated cylinder in which it is collected. In order, therefore, to bring about a clean separation it is advisable to introduce into the cylinder about 10 c.c.'s of 90's benzol or solvent naphtha. This will hold in solution any naphthalene which may distil over, should the creosote be a very salty one, and in all cases will result in a clear reading being obtained. It is possible, of course, to estimate the percentage of water in a creosote at the same time as the test is being made for distilling range, and reference will be made to this when dealing with the fractionation of a creosote.

*Phenols.*—There are several methods of estimating phenolic bodies in creosote. In many laboratories it is determined by taking a measured quantity, generally 100 c.c.'s, of the creosote, and placing the same in a separating funnel, and then washing it with two or three successive quantities of caustic soda solution of about  $40^{\circ}$  Tw. The volumes of soda used are approximately 20 or 25 c.c.'s for each operation. The soda washings are mixed and acidified with dilute sulphuric acid (1:3) and the phenols which are thrown up separated and measured. Of course, should

the oil be very salty, it is necessary to heat the same to a temperature at which it will remain liquid, and also to heat the soda a little before adding it. In cases of this kind the temperature at which the oil is measured should be noted and the tar acids separated should be measured at the same temperature. On the other hand the creosote may be weighed and the tar acids which are separated weighed also. Should the creosote be liquid at normal temperature, then a rough method for determining the tar acids is the following: Fifty c.c.'s of 40 Tw. caustic soda are placed in a 100 c.c. graduated and stoppered test mixer. On the top of this are run 50 c.c.'s of the creosote, both materials of course being put into the cylinder at the same temperature. The contents of the mixer are agitated and then allowed to stand to separate. The increase in volume of the soda, or the decrease in volume of the creosote will give, when multiplied by two, the percentage of tar acids.

Another method of estimating the phenols is to distil 100 c.c.'s of the creosote in a retort, and collect all that will come over up to  $315^{\circ}$  C. The distillate is heated if necessary and agitated in a separating funnel with three successive quantities of 25 c.c.'s each of caustic soda solution of a strength of 40° Tw. These soda extracts are carefully separated and mixed together, placed in a clean separating funnel and shaken out with a small quantity of ether in order to remove any entangled hydrocarbon bodies. This extracted soda solution is carefully separated from the ether and heated on the water-bath in order to drive off any ether which has remained in solution. It is then cooled and rendered just acid with dilute sulphuric acid, made by mixing one part of the acid with three of water. The acidification is conveniently conducted in separating funnel, and after allowing a period of rest for separation, the greater part of the acid sodium sulphate solution may be run off and the remainder, together with the phenols, run into a graduated cylinder, and the volume of the phenols read off. These phenols will of course contain a certain amount of dissolved water.

Church recommends distilling 100 c.c.'s. of the creosote, measured at limpid point, in a Jena Wurtz flask. The flask is connected to an air condenser tube, which is kept warm by a Bunsen flame during the operation, to prevent the distillate from solidifying. The operation is continued until 95 per cent. of the creosote has been collected into a specially graduated separating funnel. The contents of the separating funnel are warmed to  $60^{\circ}$  C. in water and the volume read off. Fifty c.c.'s of a 10 per cent. solution of caustic soda are now added, and the mixture shaken well and allowed to settle. The clear soda solution is carefully removed, the oil warmed again to  $60^{\circ}$  C. and the shrinkage noted. Another 30 c.c.'s of caustic soda solution

are added, shaken, separated, etc., and any further shrinkage noted: This operation is repeated until no further shrinkage takes place, and the total shrinkage of the oil is taken as the percentage of tar acids present in the original sample.

*Naphthalene.*—There are several methods of estimating this material in creosote, and it is very difficult to say which of these methods gives the most accurate results. A rough method of estimating this material is the following: Twenty-five grammes of the creosote are weighed in a beaker to the second decimal place, and kept at a temperature of between  $50^{\circ}$  and  $60^{\circ}$  Fahr. for twelve hours, then at  $60^{\circ}$  Fahr. for two hours, with constant stirring. The contents of the beaker are then carefully but rapidly transferred to a large filter paper supported in a funnel, which in its turn is supported in a water jacket, the water of which is kept at a temperature of  $60^{\circ}$  Fahr. Draining is allowed to take place until the mass becomes fairly solid on the filter paper, when the filter paper and the contents are removed from the funnel, the top of the paper folded over and the lot placed between the folds of blotting-paper and pressed under a copying press. The latter portion of this operation must be conducted very rapidly, in order to avoid any serious rise in temperature. After the pressing, the naphthalene is very carefully scraped off the filter paper into a tared dish and weighed.

Sage recommends that the naphthalene should be estimated in the fractions of creosote distilling below  $270^{\circ}$  C. and not in the entire oil, by filtering the cooled distillate through filter cloth and pressing between bibulous paper. Mann estimates naphthalene by determining the "latent heat point" in a special apparatus. This method is fully described in the original paper by this worker.<sup>1</sup>

The apparatus used in Mann's method is illustrated in Fig. 64, and the test is made as follows: A portion of the sample, about 50 c.c.'s, is distilled from a small retort until incipient decomposition of the residue is observed, and the collected distillate is warmed, until wholly fluid, and then well mixed. The small tube A is removed from the apparatus and filled about two-thirds with the distillate. This is gradually cooled, stirring all the time with a thermometer calibrated in  $0.2^{\circ}$  C. until

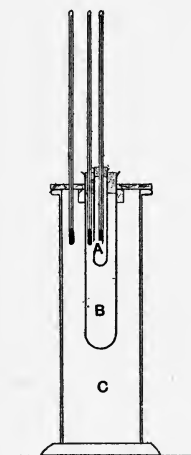

FIG. 64.—Apparatus used in Mann's method of estimating Naphthalene in Creosote.

it becomes opaque owing to the formation of crystals, and the temperature at which the opaqueness appears is noted. The

<sup>1</sup> "Notes on the Testing of Coal Tar Creosote," J. C. Mann, *J.S.C.I.*, June 30, 1910, p. 732.

water in the water-jacket C and the air-bath B (see Fig. 64) are then brought to a temperature two or three degrees lower than the opacity point temperature just obtained. The distillate in A is then re-melted and again cooled carefully to opacity point, when the tube is placed into B. Then the thermometer in A is adjusted, so that it is quite central and the bottom of its bulb about 2 c.m.'s from the bottom of the tube. The temperature will be noticed to slightly rise and then remain constant for about half a minute, after which it commences to fall. The maximum temperature reached is taken as the "latent heat point." In the original paper a curve is shown, the ordinates of which give the "latent heat point" in degrees centigrade and the abscissæ percentage of naphthalene. From this curve and the latent heat point obtained, the percentage of naphthalene in any sample may be found. It is advisable for each worker to plot his own curve in the first instance, but the following figures may be useful to those who do not wish to carry out the experimental work necessary to construct a curve.

Actual Percentage of Naphthalene.	"Latent Heat Point."
20	30° C.
25	34° C.
30	40° C.
35	45.5° C.
40	49.8° C.
45	52° C.

Church recommends the following method: The extracted oil from the tar acid estimation (see page 153, Church's method) is placed in a copper beaker and kept at a temperature of 15.5° C. for fifteen minutes. The mass is then filtered on a perforated funnel connected to a suction pump and sucked dry, and the naphthalene in the filter then pressed between blotting-paper in a letterpress to remove all oil, and weighed. The percentage of this material is figured on the weights of original oil as given by the specific gravity at the limpid point. Church estimates the limpid point by taking 5 c.c.'s of the creosote in a test tube at 60° C. cooling, and stirring with a thermometer until the first crystals begin to form (limpid point). Cooling in water should be carried out if necessary.

*Distilling Range.*—A very usual practice for obtaining the distilling range of a creosote in this country is to distil 100 c.c.'s of the oil in an 8-oz. tubulated retort, no condenser being connected to the same. The position of the thermometer varies according to individual ideas or the requirements of specifications.

Some recent workers have adopted the use of a Wurtz distilling flask connected to an air-cooled condenser. In the writer's opinion the Wurtz flask method is certainly the best. The tarwork's chemist will find that specifications require the use of either a retort or flask, the size of which may vary. The position of the bulb of the thermometer is sometimes not stated, at others in the case of a retort it is required to be in the liquid at the commencement of the distillation, or else above the liquid, and in the case of a distilling flask, just above the surface of the liquid at the commencement of the distillation, immediately opposite the outlet tube, just below the outlet tube, and just above the outlet tube. The rate of distillation is sometimes mentioned and at others it is not. As a matter of fact there is at the present moment a great need for the adoption of a standard method of obtaining the distilling range of a creosote.

Sage recommends the use of an 8-oz. retort, the upper part of the bulb of which is covered with a tin can packed with asbestos. With reference to the position of the bulb of the thermometer, this he recommends to be in the liquid at the commencement of the distillation and not more than  $\frac{1}{2}$  inch from the bottom of the retort. With reference to the points at which fractions should be collected, he gives the following:—

- (a) Distillate up to 210° C.
- (b) „ between 210 to 235° C.
- (c) „ „ 235 „ 270° C.
- (d) „ „ 270 „ 315° C.
- (e) Residue not distilling at 315° C.

With reference to these points it should be borne in mind that usually specifications detail the points at which the fractions must be taken.

Church favours the method given in the *American Railway Engineering and Maintenance of Way Association Bulletin*, No. 65. In this method a retort is used connected to an air-cooled condenser, the maximum distance from the centre of the bulb of the retort and the end of the condenser being 24 inches. The thermometer, which is a standard one, is inserted in the retort in such a fashion that the lower end of the bulb is  $\frac{1}{2}$  inch from the surface of the oil at the commencement of the distillation. The retort is covered with an asbestos paper cover and supported on a piece of wire gauze. It is heated with a Bunsen burner surrounded by a chimney. The distillates are collected in weighed bottles, and all the fractions determined by weight, this necessitating of course the weighing into the retort of 100 grammes of the oil. When any measurable quantity of water is present in the oil, the distillation should be stopped at the point it ceases to come over, the oil is then separated from the water and returned to the retort, when the distillation should be recommenced.



Reports are made on the following fractions:—

0	to	170°	C.
170	„	200°	C.
200	„	210°	C.
210	„	235°	C.
235	„	270°	C.
270	„	315°	C.
315	„	335°	C.

*Estimation of Free Carbon.*—This comes under the head of insolubility in benzol and is determined at the same time as a solubility in benzol test. Sage recommends the following method for creosote containing no water. One hundred grammes of the creosote should be filtered whilst hot through a tared filter paper, and the filter paper afterwards washed with benzol in a Soxhlet extraction tube until the benzol runs away clear. The filter is then dried and weighed. He considers that in no case should more than 0.25 per cent. of insoluble matter be passed without comment. Should the creosote contain more than a trace of water this may be driven off first in the usual fashion, separated from the oil which comes over, the oil added to the material in the retort, and the whole, while warm, passed through a tared filter paper as just described.

*Pyridine Bases.*—These may be estimated in the creosote by shaking out say 100 c.c.'s in a separating funnel with dilute sulphuric acid (1 : 2), using three lots of about 25 c.c.'s each. The acid extractions are bulked, washed with a little ether, separated, the ether which remains in solution in the acid extract driven off on the water-bath, and the pyridine bases then thrown up by adding to the acid extract caustic soda of about 40° Tw. strength. The bases are separated and dried by treatment with 90° Tw. caustic soda and then their volume read off. Occasionally the bases are not extracted from the oil as received, but 100 c.c.'s are distilled in the retort up to 315° C. and the bases determined in the distillate.

*The Dimethyl Sulphate Test.*—Dimethyl sulphate will not dissolve, to any appreciable extent, paraffin or olefine hydrocarbons, but dissolves benzene and its homologues. On account of this fact, this compound has been used to determine approximately the amount of mineral oil or paraffinoid bodies in creosote. Dr. Sommer recommends the following method: Four c.c.'s of the distillate are put in a 10 c.c. graduated cylinder, provided with a stopper, and 6 c.c.'s of dimethyl sulphate added, after which the contents are shaken thoroughly for one minute. If the distillate is not entirely soluble, a separation will take place within a few minutes, and the line of separation being clear, can be easily read.

*Flash Point.*—As creosote flashes at a fairly high temperature,

it is not possible to use the Abel test apparatus and obtain satisfactory results. The best apparatus to use for determining the flash point of creosote is that known as the Pensky-Marten. This apparatus consists of an oil cup with cover, to which is fitted a stirrer and thermometer. The bath is heated by a spirit lamp or Bunsen burner, and the slow and regular heating of the oil is ensured by the jacket of air which surrounds the cup.

Sometimes it is necessary to obtain the open flash of creosote. This is determined by taking about 100 c.c.'s in a porcelain basin and heating it carefully with a Rose burner, stirring all the while with a thermometer. The rate of heating should be about one degree per minute, and at every degree a lighted taper should be passed near the surface of the oil. The temperature is read off immediately a flash is noticed.

*Coefficient of Expansion.*—The method of determining this constant is not in any way difficult. Sage recommends the following: One hundred c.c.'s of the creosote should be measured into a flask marked at 100 c.c.'s on the neck and graduated in one-tenths of a c.c. up to 106 c.c.'s. The volume should be first adjusted to 100 c.c.'s at 40° C., and the flask then warmed in a water-bath to 80° C., and the volume at that temperature measured and recorded. The factor most commonly employed is an expansion of 1 per cent. for a rise of every 22½° Fahr., but this is not true for all creosotes or for high temperatures as well as low ones. Sage has plotted curves obtained when heating samples from 20° C. to 80° C., and the range falls within very narrow limits, his results showing that the increase in volume is 1 per cent. for each 13.3° C., or approximately one degree for every 24° Fahr.

## BENZOL

*Specific Gravity.*—This is determined with an ordinary specific gravity hydrometer after cooling the benzol to 15.5° C. Some chemists take the gravity at the temperature of the laboratory and correct the same by adding .001 to the specific gravity reading for every 2° Fahr. above 60° or subtracting the same figure for every 2° Fahr. below 60°. This method is not to be recommended, as the factor is not accurate for all temperatures. The best method of estimating the specific gravity of this material is to use the Regnault specific gravity bottle.

*Distillation.*—For making rough works' tests, such as determining the percentage given off from a sample obtained from the worm end of the benzol still, an 8-oz. retort is used, connected to a Liebig condenser and supplied with a benzol testing thermometer, which is graduated from 70° to 130° C. in one-fifths of a degree. The length of the Liebig condenser is about 30 inches

and the condenser tube about 1 inch wide. The thermometer is fixed so that the bottom of the bulb is about  $\frac{3}{8}$  inch from the bottom of the retort. A Rose burner is used to heat the contents of the retort, and the distillation should proceed at the rate of about two drops per second. It should be added that benzol is tested before delivery for its percentage at  $100^{\circ}$  C. or  $120^{\circ}$  C., according to quality, in the same apparatus.

*Pyridine in Benzol.*—Badly made benzols may contain pyridine bases, and it is advisable to test for these if the sample is suspected. The test may be carried out as follows: One hundred c.c.'s of benzol are agitated with four parts of a 10 per cent. solution of sulphuric acid in a separatory funnel. After a thorough shaking, the contents of the funnel are allowed to rest and the acid solution run off from the bottom into a distilling flask and then made alkaline with caustic soda. The flask is connected up to a Liebig condenser and a steam generating apparatus, and the contents submitted to steam distillation until about one-third of the volume in the distilling flask has come over. When the distillate is cold  $90^{\circ}$  Tw. caustic soda is added, the bases which rise to the surface, if sufficient, are carefully separated and measured.

*Total Sulphur in Benzol.*—The following method, if carefully conducted, will give very satisfactory results. It is a modification of a test published by Irwin. Into a 2-oz. spirit lamp, provided with the usual unplaited wick, which is kept very short on the burning side, are placed 2 c.c.'s of benzol, which should be measured in from a burette at  $60^{\circ}$  Fahr. On the top of the benzol are poured 20 c.c.'s of 90 per cent. alcohol B.P., and the lot carefully mixed. The spirit lamp is placed under the trumpet stand of the Gas Examiners' or Referees' sulphur test apparatus, the burner portion projecting through the centre hole where in the ordinary course the gas burner should be. The Gas Examiners' apparatus is prepared in the same fashion as when determining the sulphur in a sample of coal gas; that is, a little powdered ammonium carbonate is sprinkled over the top layer of glass marbles in the condenser, and a few small lamps placed round the burner top. The lamp is lit immediately it is placed under the trumpet and allowed to burn at such a rate that it will take about  $1\frac{3}{4}$  hours to consume the contents. Immediately the lamp goes out it is removed, and a further 5 c.c.'s of alcohol placed in it, and this burnt under the apparatus until the lamp goes out, the time taken being about 20 minutes. The flame should be almost colourless at the end of the process. The whole of the apparatus is washed down with distilled water in the usual fashion into a beaker, and the sulphur estimated in the usual way and if desired calculated to  $CS_2$ . There are other ways of estimating  $CS_2$  in benzol, such as the phenylhydrazine test, and the copper xanthate

method. The reader is referred to *Allen's Commercial Analysis* and other authorities on analytical matters for these tests.

*Estimation of Fatty Hydrocarbons.*—This test is sometimes applied to benzol, especially when it is intended for the manufacture of nitro-compounds. Lunge gives the following process: One hundred grammes of benzol are nitrated with 125 grammes of sulphuric acid, specific gravity 1.84, and 125 grammes of nitric acid of a specific gravity of 1.5, at a temperature not exceeding 30° C. The crude nitro-benzol is separated from the acid liquid in a separating funnel, neutralized with caustic soda, and distilled by means of steam until a sample of the distillate sinks in water. The distilled oil is separated from water and placed in a 50 c.c. stoppered and graduated cylinder, and to this 15 to 40 c.c.'s of the mixed sulphuric and nitric acids, made as before described, are gradually added with occasional shaking until the volume of the oil ceases to diminish. Any unchanged benzene and toluene are dissolved in the acid mixture, and the fatty hydrocarbons being unacted upon will float on the top and their volume may be read off. This volume is calculated as amounting to 60 per cent. of the fatty hydrocarbons actually present, and the test is only made if there is reason to expect a somewhat large proportion of these substances.

#### VALUATION OF CRUDE NAPHTHA FOR YIELD OF BENZOL, ETC.

Crude naphtha and crude benzol are examined for the yield of light products in the chemical laboratory by the following method: Five hundred c.c.'s. of the oil are placed into a distilling flask, fitted with a 5-bulb Glinzky or le Bel Henninger distillation head. The delivery tube of this latter piece of apparatus is connected up to a Liebig condenser. Distillation is commenced and the amount of distillate which comes over below 200° C. is collected and the percentage read off. This distillate is then washed, first with about 60 c.c.'s of 60° Tw. caustic soda, using a separating funnel. The alkaline liquor which separates is carefully removed, and the shrinkage in the oil carefully measured. The oil is then washed once or twice with water, care being taken of course to prevent loss of oil when separating the water, and then agitated with B.O.V. of about 140° Tw., two washes of 2½ per cent. being given. The acid liquor which separates is carefully removed, and the oil then given one or two water washes, after which it is washed with 50 c.c.'s of 20° Tw. caustic soda and then with one wash of water. It is then allowed to rest to separate the last traces of water, and the shrinkage of oil carefully measured. The entire quantity of the washed oil is now placed into a distilling flask fitted with a Glinzky or le Bel

Henninger head, as just described, and the following fractions are collected :—

Drop to 100° C.	equals	90's benzol.
100 „ 120° C.	„	50's-90's benzol.
120 „ 160° C.	„	solvent naphtha.
160 „ 190° C.	„	heavy solvent.

The bottoms are also measured. It should be added that the volumes of these fractions will give only an approximate idea of what is obtained in the works, but at the same time forms a useful guide when buying say crude benzol or crude naphtha.

In the case of crude naphtha the percentage at 120° C. is often determined by using a retort and condenser as just described under benzol tests, and of course the specific gravity is always taken. It is advisable to test the crude naphtha for tar acids and basic bodies by the methods already given.

### NAPHTHAS

*Distillation.*—The various qualities of naphtha are tested in a similar apparatus to that used for benzol, whether it is required to control the working of the naphtha still or the quality of the products to be offered for sale. A special thermometer is used, graduated from 90° to 200° C. in half degrees, and this is placed in the retort in a similar position to that occupied by the benzol thermometer. The drop point and the percentage at 160°, 170° or 200° is read off according to the quality of the naphtha.

*Specific Gravity.*—This is taken by a hydrometer or in the Regnault specific gravity bottle.

*Flash Point.*—This is determined in the Abel test apparatus, in a similar fashion to that used for the determination of the flash point of petroleum.

*Pyridine Bases and Tar Acids.*—It is advisable to examine solvent naphthas for pyridine bases and also for tar acids. The latter substances are estimated as already described (see page 152), and the former (unless suspected to be present in more than traces, when the test described under benzol is used) by the following method, which is known as the Weber test for pyridine : Shake out 100 c.c.'s of solvent naphtha with 100 c.c.'s of distilled water in a separating funnel. Take about 15 c.c.'s of the water extract and add to it 1 c.c. of a 10 per cent. solution of copper sulphate. Bring the mixture to boiling point. It is required that no turbidity occurs. According to Weber, if the mixture remains clear the solvent naphtha is free from pyridine, or the amount it contains does not reach more than one part in 1,500 parts of solvent naphtha. A very faint turbidity after standing 30 minutes will be equivalent to approximately .06 per cent., and a pronounced bluish white turbidity to .01 per cent. If the quantity of pyridine exceeds 0.1 per cent. a copious pre-

precipitate results, and should 0.3 per cent. be present a dense precipitate is at once produced. If the solvent naphtha be required for rubber works, this test often has to be used, and also the following: Twenty-five c.c.'s of R.O.V. and 75 c.c.'s of the solvent naphtha are placed in a stoppered and graduated test mixer. The mixture is well agitated and allowed to rest. The R.O.V. should not increase in bulk more than 4 c.c.'s, making a total of 29 c.c.'s, and the colour should not be more than a deep orange.

Another test often used for pyridine is to extract 50 c.c.'s of the solvent naphtha with 50 c.c.'s of B.O.V. in a separating funnel, allow to rest, separate the acid extract, neutralize with fairly concentrated caustic soda, say 60° Tw. and see whether pyridine can be detected by the sense of smell.

#### VALUATION OF LIGHT OIL, ETC.

There are several methods of testing light oil in order to obtain an idea of the yield of light products which may be expected in the works. One of the methods is the following: Five hundred c.c.'s of the light oil are placed in a distillation flask fitted to a 5-bulb Glinzky or le Bel Henninger distillation head and Liebig condenser. The flask is heated with a Bunsen burner, and all the distillate which comes over below 200° C. collected, and the percentage read off. This distillate is washed first with about 60 c.c.'s of 60° Tw. caustic soda, and then once with about the same volume of clean water, after which the loss, due to the alkaline wash, is carefully measured and the percentage noted. It is now washed with 5 per cent. of B.O.V. in two 2½ per cent. quantities, and then three times with about 60 c.c.'s of water, after which an alkaline wash is given, using about 50 c.c.'s of 20° Tw. caustic soda, and finally a wash with 50 c.c.'s of clean water. The loss in volume of oil is carefully measured, and the washed distillate is then placed in a distillation flask and distilled up a fractionating head, using one or other of the types just mentioned, and the following fractions collected:—

1. Drop to 100° C. equals 90's benzol.
2. 100° „ 120° C. „ toluol.
3. 120° „ 160° C. „ solvent naphtha.
4. 160° „ 185° C. „ medium heavy naphtha.
5. 185° „ 200° C. „ heavy naphtha.

The results are calculated on the original oil and tabulated as follows:—

Distillate above 200° C.	. . . . .	per cent.
Loss by soda and water washing	. . . . .	„
Loss by acid, soda and water washing	. . . . .	„
90's benzol	. . . . .	„
Toluol	. . . . .	„
Solvent naphtha	. . . . .	„
Medium heavy naphtha	. . . . .	„
Heavy naphtha	. . . . .	„

*Specific Gravity.*—This is taken by one of the methods already described.

*Tar Acids and Pyridine Bases.*—The processes for estimating these substances have been described already.

#### CRESYLIC ACID

*Specific Gravity.*—This constant is determined either by a hydrometer or specific gravity bottle.

*Water.*—This material is usually estimated by distilling carefully 100 c.c.'s of the sample in an 8-oz. retort until all the water and 10 c.c.'s of oil have been collected in a measure. A little benzol is then added to the contents of the measure with shaking, and the mixture allowed to stand in order to enable the water to separate, when a clear reading may be obtained.

*Distillation.*—This test should be conducted in a Wurtz or distillation flask connected to an air condenser. The percentage of distillate is read off, as a rule, at the following points: 194° C., 196° C., 198° C., 200° C.; 202° C., and 204° C.

*Naphthalene and Neutral Oils.*—This is not an easy test to carry out, and at the best is only approximately accurate. Twenty grammes of the sample are taken and placed in a separating funnel. The beaker in which the 20 grammes were weighed is rinsed out with 100 c.c.'s of 15 per cent. caustic soda and the rinsings added to the cresylic acid in the funnel. The lot is well shaken, and when the acids have dissolved 100 c.c.'s of distilled water are added with thorough agitation. If a clear solution results, then naphthalene and neutral oils may be considered absent, but in the case of marked turbidity, the mixture is extracted with light petroleum ether, which is dry at 75° C., the extract carefully separated, run into a weighed beaker or flask, the ether cautiously evaporated off on a water-bath and the residue weighed.

In cases in which the cresylic acid contains a fairly large quantity of oil and naphthalene, the following rough test may be used: Into a 100 c.c. stoppered test mixer 40 c.c.'s of 60° Tw. caustic soda are placed, and on the top of this 40 c.c.'s of cresylic acid are carefully poured. The two substances are thoroughly mixed and then allowed to cool down to 60° Fahr., after which 5 c.c.'s of benzol are added and the lot shaken up. The contents of the test mixer are now allowed to stand in order that the benzol may separate together with any oil and naphthalene which it has dissolved; the increase in volume of benzol may be taken as oil. The writer does not altogether approve of this test.

*Tar Acids in Cresylic.*—If it is desired to estimate these, the following method may be used. One hundred c.c.'s of the sample measured at 60° Fahr. are placed into a separating funnel and about 100 c.c.'s of 60° Tw. caustic soda added to the same, and

the lot well shaken until the cresylic has dissolved. The solution is then extracted with light petroleum ether, the ether extracted carefully separated, and the cresylate of soda filtered through a little glass wool into a large beaker. It is brought up to the boil and kept at this point for about two minutes, after which it is allowed to cool down. It is then placed in a separating funnel, the beaker being rinsed out with a little water and the tar acids thrown up by the addition of dilute B.O.V. A sufficient length of time is given for the tar acids to properly separate, when the subnatant sulphate of soda liquor is separated, and the tar acids run into a measure and the volume read off.

*Sulphuretted Hydrogen and Sulphur Compounds.*—During the manufacture of cresols it is necessary to test the same for sulphur compounds, and it is also advisable to examine samples which are being purchased for the same substances. The method

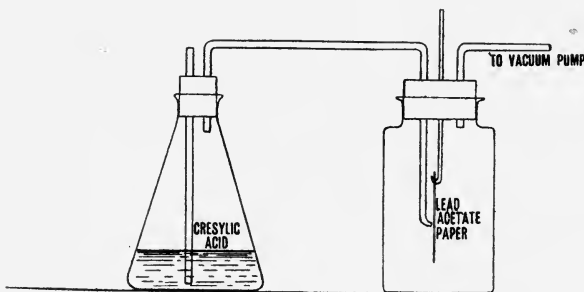

FIG. 65.—Apparatus used in Testing Cresylic Acid for Sulphur.

generally used is to place about 50 c.c.'s of the cresols in a flask fitted with an air inlet and outlet tubes, the inlet tube dipping into the cresols. The outlet tube is connected to another flask, which in its turn is fitted to a filter pump. In this flask a piece of lead acetate paper is suspended in such a position that it hangs over the air inlet tube. Air is aspirated through the cresols by means of the filter pump, and during its passage through the second flask it comes in contact with the acetate paper, and should sulphur compounds be present, this will turn brown or black. A good sample of cresylic will not blacken an acetate paper after 15 minutes. Fig. 65 illustrates the arrangement of the flasks, etc.

#### META-CRESOL—CRESYLITE TEST

There is a special grade of cresylic acid manufactured, which contains a considerable quantity of meta-cresol. This material is used for the manufacture of tri-nitro-meta-cresol. There are



two methods of testing this substance, one of which is known as the short test and the other as the long test. They are carried out as follows :—

*Short Test.*—Ten grammes of the cresols are placed in an Erlenmeyer flask and 15 c.c.'s of 66° Bé. sulphuric acid are added. The lot is well agitated, and then heated for one hour in a steam-oven. After this the sulphonated mixture is poured into a 1-litre flask and thoroughly cooled under a water-tap. Into the Erlenmeyer flask in which the cresols were sulphonated 90 c.c.'s of 40° Bé. nitric acid are placed and thoroughly shaken until the sulphonated material adhering to the flask sides is rinsed off with the acid. It is then cooled a little and transferred rapidly to the contents of the litre flask. The lot is now vigorously shaken and in a few minutes reaction will take place. The mixture is now allowed to stand until the reaction is finished, when it is emptied into a large porcelain basin containing 40 c.c.'s. of cold water. The flask is rinsed out with another 40 c.c.'s. of cold water and the rinsings added to the contents of the basin, after which the lot is allowed to remain until crystalline. It is then filtered through an ordinary filter paper, dried in a steam-oven at 95 to 100° C. and weighed, the result multiplied by 10 equals the cresylite test.

*Long Test.*—A retort of a capacity of 1 litre is fitted with a cylindrical dropping funnel, provided with a stop cock, holding about 50 c.c.'s. The retort is placed in a spherical sand bath, about 14 c.m.'s in diameter. The operation must be conducted in a fume cupboard. Into the retort 50 grammes of nitric acid of 40° Bé. strength are placed and gently warmed to a temperature of 80° C. In the meantime 50 grammes of the sample of cresol are mixed with 125 grammes of sulphuric acid and allowed to stand for an hour. After this time has elapsed the contents of the flask are run into a dropping funnel and the flask inverted over the same in order that it may thoroughly drain. The sulphonated cresol is allowed to drop into the nitric acid at such a rate that the whole of the contents of the dropping funnel will take between 1½ to 2 hours to run into the acid. The temperature must be kept at 80° C. the whole of the time and regular ebullition maintained. Red vapours are given off, and should these vapours whiten towards the finish, the test must be repeated with a larger quantity of nitric acid. The nitric acid should not be in great excess as the tri-nitro-meta-cresol is appreciably soluble in mother liquor charged with nitric acid. Immediately the whole of the sulphonated cresol has dropped into the nitric acid, the gas flame is removed and twenty minutes allowed to lapse, after which the contents of the retort are poured into a large porcelain basin containing 400 c.c.'s of cold water. The mixture is then left to cool for 24 hours, and the crystals which form are carefully

separated from the mother liquor by decanting the latter into a filter funnel provided with a perforated filter disc and covered with round filter paper. The mass of crystals in the basin is melted in 200 c.c.'s of water, allowed to cool, the mother liquor removed as just mentioned, the crystals broken up, allowed to drain, dried at 50° C., weighed, and multiplied by two.

### CARBOLIC ACID

*Specific Gravity.*—This constant is determined by a hydrometer or specific gravity bottle.

*Water.*—This is generally determined during the carrying out of the crystallizing test.

*Solubility.*—The sample is required to answer the following: Fifty c.c.'s of the crude carbolic acid must be completely soluble in 100 c.c.'s of caustic soda of a specific gravity of 1.10.

*Crystallizing Point.*—There are one or two methods of carrying this out, but that generally used for the buying and selling of crude carbolic acid is the following; and it is known in the trade as Lowe's method: Into an 8-oz. tubulated retort, having a neck about 15 inches long, 100 c.c.'s of the crude acid to be tested are placed. No condenser is connected to the beak of the retort, and the distillation is so regulated that no vapours are given off, and the operation occupies about two hours. Clean, dry, graduated cylinders must be used for the collection of the distillates. Into the first receiver 10 c.c.'s of oil and all the water (which latter shall not exceed 15 c.c.'s) are collected. The next 62½ c.c.'s are collected in the second receiver, well mixed, and cooled slowly to near the expected crystallizing point. A small quantity of pure crystals is then added, and the cooling continued—stirring all the time. When the distillate is crystalline throughout, the thermometer (a Fahrenheit graduated in one-tenths of a degree) is read; and the figure indicated is taken as the crystallizing point of the crude acid. It is often necessary to employ a cooling solution, and when this is the case, care must be taken that the temperature of this solution is not more than 2° Fahr. below that at which the sample is expected to crystallize.

With low crystallizing acids—*e.g.* 50's and 45's, etc.—the determination of the point at which the first crystals appear is, unfortunately, rather a tedious process, and with the object of rendering the same easier and quicker, the writer and his assistant<sup>1</sup> made numerous experiments with a modified method, with very encouraging results. Up to the collection of the 62½ c.c.'s of acid in the second receiver, the process is identical with Lowe's.

<sup>1</sup> "Investigations on Coal Tar and some of its Products." *English Junior Gas Associations' Joint Proceedings*, 1911-12. Sec. M., pp. 105-125. "The Gas World," March 2, 1912, p. 284.

The modification consists in just half filling a test tube 5 inches long by  $\frac{5}{8}$  inch in diameter with the well mixed distillate, cooling while stirring until the contents of the tube are crystalline throughout—adding a small crystal of pure acid, if necessary—removing from the cooling mixture, and stirring slowly, in a temperature of about 60° Fahr. until all crystals disappear. This point is called the liquefying point; and if 2.5 is deducted from the figure obtained, the crystallizing point of the acid is found. This figure was arrived at by taking the average of fifty experiments, the highest difference being 3.0 and the lowest 2.2.

A handy method for use in the works when making mixings is the following, and this method may be termed a short test: One hundred c.c.'s of the crude carbolic are distilled in an 8-oz. retort until all the water and 10 c.c.'s of the oil has come over. A further 20 c.c.'s of the tar acids are now collected in a perfectly dry cylinder, the crystallizing point determined, as already explained under Lowe's test, and from the figure obtained 8 is deducted, when the result will indicate approximately the actual crystallizing point. Another short test is the following: Into a three-bulb Ladenburg flask of 150 c.c.'s capacity, 80 c.c.'s of crude carbolic are placed. The flask is connected to a 12-inch Liebig condenser, the jacket of which is filled with water, but no flow is maintained. All the water is distilled off, and 8 c.c.'s of the oil. Then into another perfectly dry receiver 50 c.c.'s of the tar acids are distilled and the crystallizing point taken. If the figure 1 is deducted from the result, the crystallizing point obtained by the long test is found approximately.

*Tar Acids in Phenolate.*—In order to control the working of the carbolic (and also the cresylic) plant, it is necessary to determine the amount of tar acids in the phenolate. This can be done rapidly by the following method: One hundred c.c.'s of the phenolate are placed in a separating funnel and dilute B.O.V. (1:2) is added until the mixture is strongly acid to litmus paper. The lot is allowed to stand for a few minutes in order that the tar acids may separate completely, after which the sodium sulphate liquor is removed carefully and the volume of the tar acids measured.

#### ANTHRACENE TESTS

Crude and refined anthracenes are tested for the percentage of actual anthracene by what is known as Luck's test. The following materials are required: *Chromic acid solution.*—This is made by dissolving 150 grammes of chromic acid ( $\text{CrO}_3$ ) and 100 c.c.'s of glacial acetic acid in 100 c.c.'s of distilled water.

*Fuming Sulphuric Acid Mixture.*—This is prepared by mixing equal parts of pure sulphuric acid of a specific gravity of 1.84 and Nordhausen sulphuric acid of a specific gravity of 1.92.

The test is carried out as follows: One gramme of the sample is placed in a 1-litre boiling flask, and to it is added 45 c.c.'s of glacial acetic acid. The flask is connected to an air-cooled reflux condenser, and then placed on a sand-bath and the contents boiled until the anthracene is dissolved. In the meantime 23 c.c.'s of the chromic acid mixture are placed in a dropping funnel, the stem of which is inserted into the top of the reflux condenser. As soon as the anthracene is dissolved in the acetic acid, the chromic acid mixture is allowed to drop into the solution at such a rate that it will take two hours for the whole of it to run out of the dropping funnel. After all the chromic acid solution is in, the mixture is boiled for a further two hours and then allowed to stand for twelve hours. It is then diluted to 500 c.c.'s with distilled water and allowed to remain at rest for one hour, after which it is filtered through a hardened filter paper and washed with (a) 200 c.c.'s of cold water, (b) 300 c.c.'s of boiling water, (c) 300 c.c.'s of  $2\frac{1}{2}^{\circ}$  Tw. caustic soda, and (d) 300 c.c.'s of boiling water. The precipitate is now washed into a tared porcelain basin, dried on a water-bath, and finally in a steam-oven, and then weighed. The weight obtained gives a figure which when multiplied by 85.6 is recorded as the common test. To the material in the basin is now added ten times its weight of the fuming sulphuric acid mixture, after which it is heated on a water-bath until the whole mass has crystallized. This will take between 10 to 15 minutes. It is then stood in a damp place overnight, and the following morning diluted with 200 c.c.'s of cold water, after which it is filtered through a hardened filter paper and washed with boiling water, soda, and boiling water, as before. The precipitate of quinone is then washed into a tared porcelain basin, dried in a steam-oven and weighed. After weighing, the basin and its contents are gently heated in order to volatilize the quinone, and when cold the dish and ash are re-weighed. The difference between the first and the second weighings gives the weight of anthraquinone, and this multiplied by 85.6 will give the percentage of actual anthracene in the sample.

*Material Insoluble in Benzol (Sand, Dirt, etc.).*—Five grammes of anthracene are transferred to a previously weighed extraction thimble, placed in a Soxhlet extraction apparatus and extracted with benzol in the usual way until the benzol leaves the apparatus colourless. The thimble is then removed, freed from benzol in a steam-oven, cooled, and weighed. The increase in weight of the thimble indicates insoluble matter. It is necessary of course to cover the extraction thimble with a piece of filter paper, the edges of which may be bound with platinum wire, or else use a plug of cotton wool.

*Parc fin in Anthracene.*—This may be estimated as follows: Ten grammes of the sample are weighed into a large beaker and to it

are added 108 c.c.'s of concentrated sulphuric acid. The mixture is heated on the water-bath until all the anthracene is dissolved, when it is cooled and poured into 400 c.c.'s of cold water contained in a 1,000 c.c. separating funnel. The mixture is allowed to cool and then extracted twice with light petroleum ether (dry at 75° C.). The petroleum ether extracts are bulked and washed in a separating funnel, first with half its bulk of 5° Tw. caustic soda, and then four times with one-eighth of its bulk of cold concentrated sulphuric acid, and after this, with cold water until free from acid. It is then allowed to settle, any water which separates removed, and then transferred to a tared flask, the ether distilled off and the residue weighed.

#### EXAMINATION OF CAUSTIC LIQUORS, SPENT LIQUORS, AND LIME MUD, IN CONNEXION WITH THE CO<sub>2</sub> PROCESS FOR MANUFACTURING TAR ACIDS

*Spent Liquors.*—It is essential that the causticized spent liquors be kept up to a standard strength as regards the percentage of actual caustic soda, and owing to the fact that impurities, sometimes to a moderately large extent, are always present in these liquors, it is not possible to control the strength with any degree of accuracy by the use of a hydrometer. It is necessary, therefore, to titrate the spent liquor with a standard acid solution for the amount of alkali present (calculated to sodium carbonate Na<sub>2</sub>CO<sub>3</sub>), and then add an amount of soda ash to the bulk of spent liquor in the causticizers to bring up the strength to the normal. The best results seem to be obtained by causticizing spent liquor which contains 10 grammes of Na<sub>2</sub>CO<sub>3</sub> per 100 c.c.'s. The writer advises tarworks' chemists who have control of a CO<sub>2</sub> plant for tar acid recovery to work out a table for themselves, showing the amount of soda ash required for each causticizer as indicated from the results obtained from his analysis, allowing of course for the impurities in the soda ash used. For instance, presuming the spent liquor on analysis showed 9.8 grammes of sodium carbonate per 100 c.c.'s, then the material in the causticizer would require approximately 2.8 lbs. of soda ash (58 per cent. alkali) for every 100 gallons. The titration is carried out in the usual manner, but the liquor, as it is generally very dark, must be well diluted and an indicator such as lacmoid or cochineal should be used.

*Estimation of Caustic Soda in Lime Mud.*—This may be rapidly estimated with a fair degree of accuracy by the following method: Twenty grammes of the mud are weighed in a 250 c.c. beaker and 100 c.c.'s of hot water poured on top of it. A gentle stream of carbonic acid is passed into the mixture for about ten minutes, after which it is boiled, filtered and the precipitate

washed, the filtrate and washings being run into a 200 c.c. measuring flask. The contents of this flask are allowed to cool to 60° Fahr. and then made up to 200 c.c.'s with distilled water and well mixed. An aliquot portion (say 25 c.c.'s) is then removed by means of a pipette and titrated in the usual fashion, calculating to NaOH.

*Estimation of Actual Caustic Soda in a Dark-coloured Causticized Spent Liquor.*—As the causticized spent liquor is always very dark in colour, it is not possible to estimate the amount of caustic soda in the presence of carbonate by the method of double titration, which is used in the case of commercial caustic sodas. The following method gives very satisfactory results: Fifty c.c.'s of the dark-coloured liquor (free from lime precipitate) is brought up to a temperature of 100° C. Barium chloride solution at a temperature of 95° to 100° C., is now added until no more precipitate forms. The lot is filtered while hot into a 250 c.c. measuring flask, the precipitate and filter paper washed with a little boiling water, and when cold the filtrate and washings are made up to the mark with distilled water, an aliquot portion taken and titrated for caustic soda in the usual fashion.

#### TESTING THE COKE FURNACE GASES FOR USE IN THE CO<sub>2</sub> TAR ACID PROCESS

It is advisable that frequent tests of the gases be made as they leave the coke furnace, in order to control the efficient working of the CO<sub>2</sub> tar acid plant. The most convenient apparatus to use for this purpose is the Orsat. The manipulation of this apparatus is so simple that an intelligent works plant man may be taught how to use the same satisfactorily in a very short time. It is advisable to estimate the carbon dioxide, oxygen and carbon monoxide in each examination.

*Coke.*—It is recommended to examine deliveries of coke for the amount of ash before purchasing. The estimation of this material is very simple, one or two grammes of the coke being burnt off in a platinum dish, after the removal of the water in an air oven, and the resulting ash weighed.

## APPENDIX

THE following is a copy of a form issued by the Home Office, which should be mounted and hung in a prominent position in all tar distilleries.

FORM 939.

*September, 1910.*

FACTORY AND WORKSHOP ACT, 1901.

### TAR DISTILLING.

The following directions are approved by the Home Office and are applicable to factories in which is carried on the distillation of tar for the production of naphtha, light oil, creosote oil, and pitch.

#### *Fencing.*

1. All uncovered tar reservoirs, wells and tanks, unless constructed so as to be at least three feet in height above the ground or platform, should be securely fenced, with either a brick wall or double rails, to the height of three feet.

#### *Cleaning.*

2. During the process of cleaning, every tar still should be completely isolated from adjoining tar stills either by disconnecting the pipe leading from the swan-neck to the condenser worm, or by disconnecting the waste gaspipe fixed to the worm end or receiver. Blank flanges should be inserted between the disconnections. In addition, the pit discharge pipe or cock at the bottom of the still should be disconnected.

#### *Ventilation.*

3. Every tar still should be ventilated and allowed to cool before persons are allowed to enter.

#### *Inspection.*

4. Every tar still should be inspected by the Foreman or other responsible person before any workman is allowed to enter.

5. The inspecting Foreman on first entering any tar still or tank, and all persons employed in tar stills or tanks in which there are no cross stays or obstructions likely to cause entanglement, should be provided with a belt securely fastened round the body, with a rope attached, the free end being left with two men outside whose sole duty should be to watch and draw out any person appearing to be affected by gas. The belt and rope should be adjusted and worn in such a manner that the wearer can be drawn up head foremost and through the manhole and not across it.

*Remedy for Gassing.*

6. A bottle of compressed oxygen, with mouthpiece, should be kept at all times ready for use ; and printed instructions as to the use of this bottle, and the method to be employed for resuscitation by means of artificial respiration, should be kept constantly affixed. A draft of such instructions is appended.

*Respirators.*

7. A supply of suitable chemical respirators properly charged and in good condition should be kept ready for use in case of emergency arising from sulphuretted hydrogen or certain poisonous gases. (Granules of carbon saturated with a solution of caustic soda readily absorb sulphuretted hydrogen and may be used for charging respirators.)

*Lights.*

8. The use of naked lights should be strictly prohibited in any portion of the works where gas of an inflammable nature is liable to be given off.

*Safety Valve.*

9. Each still should be provided with a proper safety valve, which should at all times be kept in efficient working condition.

B. A. WHITELEGGE,

*Chief Inspector of Factories.*

HOME OFFICE,

*December, 1909.*

GASSING.

SYMPTOMS.—The first symptoms are giddiness, weakness in the legs, and palpitation of the heart. If a man feels these he should at once move into fresh warm air, when he will quickly recover if slightly affected. He should avoid exposure to cold. He should not walk home too soon after recovery ; any exertion is harmful.

FIRST AID.—Remove the patient into fresh warm air. Send for the oxygen apparatus. Send for a doctor. Begin artificial



breathing at once if the patient is insensible and continue it for at least half an hour, or until natural breathing returns. Give oxygen\* at the same time and continue it after natural breathing returns.

**ARTIFICIAL BREATHING (Schäfer Method).**—Place the patient face downwards as shown in the diagrams.



DIAGRAM 1.



DIAGRAM 2.

Kneel at the side of the patient and place your hands flat in the small of his back with thumbs nearly touching, and the fingers spread out on each side of the body over the lowest ribs (see Diagram 1).

Then promote artificial breathing by leaning forward over the patient and, without violence, produce a firm, steady, downward pressure (see Diagram 2). Next release all pressure by swinging your body backwards without lifting your hands from the patient (see Diagram 1).

Repeat this pressure and relaxation of pressure without any marked pause between the movements, *about 15 times a minute*, until breathing is established.

**\*USE OF OXYGEN CYLINDER.**—Open the valve gradually by tapping the lever key (which must first be extended to its full length) with the wrist, until the oxygen flows in a gentle stream from the mouthpiece into the patient's mouth. The lips should not be closed round the mouthpiece. The nostrils should be closed during breathing in, and opened during breathing out.

If the teeth are set, close the lips and one nostril. Let the conical end of the mouthpiece slightly enter the other nostril during breathing in, and remove it for breathing out.

The following particulars relating to sulphuretted hydrogen ( $\text{SH}_2$ ), and carbon monoxide ( $\text{CO}$ ), published by "Mentor" in *The Gas World* of November 21, 1908, will prove useful to those interested in tar distillation:—

#### *Symptoms of Poisoning by Carbon Monoxide*

Usually the first thing noticed by a person who is moving about and has inhaled the gas is a tendency to palpitation, dizziness or faintness and shortness of breath after exertion, following which there is a general weakening of the muscular, mental and sensory faculties. The patient is usually drowsy. When the

blood has become about 50 per cent. saturated it is hardly possible for one to stand upright or walk, and with higher degrees of saturation the mental and muscular enfeeblement becomes more and more pronounced. One noteworthy point in connexion with carbon monoxide poisoning is that very little actual distress results from the inhalation of the gas. After paralysis of the limbs, the senses gradually become more and more benumbed, as they would be by the administration of a gentle anæsthetic. With less than 1 per cent. of CO in the air, death is very gradual and peaceful, and with more than 1 or 2 per cent., loss of consciousness is usually followed by convulsions, and death rapidly ensues.

*Symptoms Produced by Poisoning from SH<sub>2</sub>*

The symptoms produced by SH<sub>2</sub> poisoning are due to two causes: (1) its direct irritant action on the eyes and air passages, and (2) its intensely poisonous action, when absorbed, on the brain, heart, etc. Exposure to an atmosphere containing 0.01 to 0.02 per cent. soon produces inflammation of the eyes, and headache. Pain in the eyes often comes some time after the exposure, and with great severity, and may recur at intervals for several days. With 0.05 of SH<sub>2</sub>, giddiness and other alarming symptoms show themselves, as well as great irritation of the eyes, nose, etc.

*Tables showing the Poisonous Effects of Varying Percentages of CO and SH<sub>2</sub> on Human Beings*

CARBON MONOXIDE

Percentage of Gas Present.				Effect on Human Beings.
Pure CO.	Coal Gas containing 7 per cent. CO.	Carburetted Water Gas, 30 per cent. CO.	Pure Carburetted Water Gas containing 32 per cent. CO.	
0.05	0.7	0.17	0.1	After half an hour to two hours, giddiness on exertion.
0.1	1.4	0.30	0.2	Do., do., inability to walk.
0.2	2.8	0.66	0.4	Do., do., loss of consciousness, and perhaps final death.
0.4	5.6	1.3	0.8	Do., do., probable death.
1.0	14.0	3.3	2.0	After a few minutes, loss of consciousness, followed before long by death.

## SULPHURETTED HYDROGEN

Percentage of SH <sub>2</sub> Present.	Effect on Human Beings.
0.001	Strong smell of rotten eggs.
0.02	After a few minutes, irritation of the nose, throat and eyes, accompanied by coughing.
0.05	Much irritation of the eyes and throat, giddiness and headache.
0.07	Death after several hours' exposure.
0.2	Death in about one and a half minutes.

*The use of Oxygen in Cases of Gassing, How it is Administered, and How Long it should be Given*

Oxygen is a valuable aid to recovery in cases of poisoning from carbon monoxide. It should therefore always be kept ready on a gasworks. The oxygen is compressed and stored in strong steel cylinders, usually holding 20 cubic feet. The cylinder should be provided with a piece of india-rubber tubing at the end of which is a metal mouthpiece. The valve on the cylinder should be opened to the extent necessary to allow sufficient oxygen to issue to allow of its being inhaled "neat," or without much admixture with air. The mouthpiece is then placed loosely in the mouth, so that inhalation may proceed without distending the lungs. If the person is unconscious, the nostrils should be closed, by pinching them with the fingers, during the process of inhaling, and left free during the act of expiration. The time during which oxygen is administered should be at least ten minutes.

# The Gas World.

**The Largest Circulation of any gas paper  
in the World.**

Every Saturday, price 4d. ; post free 4½d.

SUBSCRIPTION, PREPAID.

United Kingdom . . . 17s. 6d. per annum.

Colonial and Foreign 2ls.     "     "

A thin paper edition is printed for Foreign and Colonial subscribers.

"THE GAS WORLD" YEAR BOOK is sent free to all annual subscribers.

JOHN ALLAN & Co., "The Gas World" Offices,  
8, Bouverie Street, London, E.C.

## INDEX

- Acid egg (carbolic and cresylic plant),  
   67, 68  
 Acid tar, 103, 105, 106  
 Agitators, mechanical, 59, 60, 90.  
   wooden, 60  
 Airblowing crude cresylic acid, 78, 88  
   pressure to transport cresylic acid, 89  
   to transport carbolic acid, 87  
 Alkali Act requirements as regards foul  
   gases, 39  
 Ammonia, examination of pyridine for,  
   148  
 Ammoniacal liquor, 50  
   receiver, 42  
 Ammonium chloride, cause of corro-  
   sion of stills, 10, 15  
   sulphide, cause of corrosion of stills, 10  
 Annular ring or tar still seat, 27, 28  
 Anthracene, crude, recovery of, 134  
   pressing of, 135  
   washing of, 135  
   oil, 52  
     distillation of, 134  
     filtering of salted out, 134, 135  
     salting out, 134  
     specific gravity of, 52  
     still for, 128  
   plant for manufacture of crude, 126  
   test for percentage of refined anthra-  
     cene in, 168  
   for insoluble in benzol, 168  
   for paraffin in, 168  
   for sand, dirt, etc., in, 168  
   tests, 167  
 Anthraquinone, 168  
 Ash pit, 27  
   determination of, in tar, 147  
   in pitch, 158  
  
 Bases in coal tar, 2  
 Bay, coal tar pitch, 45, 46  
   construction of, 45, 46  
   cresylic pitch, 77  
   depth to run pitch on, 55, 136  
   preparation of pitch, 55  
 Benzene, preparation of commercially  
   pure, 110  
   in tar, 2  
 Benzol, plant for recovery of, 90-98  
  
 Benzol, determination of pyridine in, 159  
   of total sulphur in, 159  
   distillation tests, 158  
   estimation of fatty hydrocarbons in,  
     160  
   fractionation of washed crude, 107, 108  
   method of washing crude, 102-104  
   preparation of 90's, 107, 108  
     of 50's-90's, 108  
   recovery of, 99  
   rectification of, 107, 108  
   stills, 91-94  
   testing for specific gravity, 158  
   washers, 90, 91  
 Blow-boiler, 67, 68  
 Blowing boiler or tank (cresylic plant),  
   78  
 Blow-over stills, steam heated, 91, 92  
   fire heated, 91, 92  
   fractionating column for, 92  
 Boiler, carbonating, 61  
   blow, 67, 68  
 Bottoms of stills, 13, 16, 17  
   cresylic, 88  
   pyridine, 124, 125  
 Bricks, fire, 26  
   brindled, 26  
   common, 26  
   Staffordshire blue, 26  
 Brick storage tanks, 6  
 Butterfield cocks, 24, 42  
  
 Cadmium chloride test, pyridine bases,  
   148  
 Cancer, pitch, 138  
 Cannel coal, tar from, 2  
 Carbolate (phenolate), tar acids in, 86  
   boilers or tanks, 60, 61  
   pump for, 62  
   springing tank, 60  
   springing with CO<sub>2</sub>, 85, 86  
   with sulphuric acid, 82, 84  
 Carbolic acid, 79  
   CO<sub>2</sub> process for recovering, 59, 85, 86  
   continuous process for recovering,  
     85, 86  
   crude, qualities of, 85  
   crystallizing point test, 166, 167  
   determination of water in, 166

- Carbolic acid—  
 receivers, 66, 78  
 solubility test, 166  
 sulphuric acid process for recovering,  
 59, 82, 84  
 testing for specific gravity, 166  
 tests, 166
- Carbolic oil, specific gravity of, 51
- Carbon, free, in tar, 2
- Carbonating boilers, 61 [64, 65  
 towers, packed and plate types, 62, 63,
- Carriage of coal tar, 4
- Carts for carriage of tar, 5
- Cast iron tar stills, 10
- Caustic liquors, examination of, 169
- Caustic soda evaporator, 74, 75  
 lye, 80, 82  
 tanks, 74, 116
- Causticizers, 73
- Causticizing plant, 73, 74, 75  
 soda ash, 79, 80  
 spent liquors, 81
- Centrifugal machines, 129
- Chamber retort tar, specific gravity of, 1
- Change over point crude naphtha to  
 light oil, 50  
 heavy creosote to anthracene oil, 51  
 light creosote to heavy creosote, 51  
 light oil to light creosote, 50  
 points, method used by stillmen to  
 determine, 53
- Channel plates of tar still, 17, 28
- Charge block of tar still, 22
- Charge pipe of tar still, 22  
 of preheater, 33
- Charging preheater, 48  
 tar still, 49
- Chemical composition of tar, 1, 2
- Cleaning of tar stills, 55, 56  
 precautions to be taken when, 56, 171
- CO<sub>2</sub> gas furnace, 68, 69, 70  
 gas, testing of, 170  
 manipulation of, 86
- Coal tar, chemical composition of, 1, 2  
 effect of heat of carbonization on, 2  
 of nature of raw material on  
 physical properties of, 1  
 of raw material on chemical com-  
 position of, 2  
 how received from gasworks, 4  
 physical properties of, 1  
 results of practical distillations of, 3  
 storage of, 5  
 tips, 4, 5
- Coal versus gas firing of tar stills, 31-32
- Cock, dipping for tar stills, 22
- Cocks, Butterfield type, 24, 42  
 gland, 42
- Coil, preheater, 34, 35  
 corrosion of, 36  
 end or worm end, 37
- Coke, testing of, 170  
 furnace, 68, 69, 70  
 gases, testing of, 170
- Collecting box, 37
- Colour, requirement for pyridine, 148
- Combustion chamber of tar still fur-  
 nace, 27
- Common bricks, 26
- Compressed air for transporting distil-  
 lates, 43
- Concrete foundations, 6, 25  
 storage tanks, 6, 7
- Concrete, reinforced, Monier system, 6  
 Hennebique system, 6
- Condenser tanks, 36, 76, 97, 98, 115,  
 116, 118  
 drain cock for, 36  
 steam pipes and coils for, 37  
 coil and tank for cresylic plant, 76  
 for benzol and naphtha plant, 97, 98  
 for crude pyridine rectification  
 plant, 118  
 for pyridine recovery plant, 115, 116
- Condensers, 36, 76, 97, 98, 115, 116, 118
- Condensing worms, 36, 76, 97, 98, 115,  
 116, 118  
 coils, shape of, 36, 115  
 corrosion of, 36  
 metals used in construction of, 36  
 118
- Construction of tar stills, 10-24  
 of fireplace, 26, 27  
 of flues, 26, 28, 29, 30  
 of storage tanks for tar, 5-8  
 for creosote, 141  
 of tar still bottoms, 16-18
- Continuous process for manufacture of  
 carbolic acid, 85, 86  
 cresylic acid, 85, 86
- Cooler, pitch, French weir, 44, 45
- Coolers, pitch, 44, 45  
 construction, 44
- Corrosion of condenser coils, 36  
 of still plates, 10, 15  
 due to ammonium chloride, 10, 15  
 sulphide, 10
- Creosote for Wells' oil, 53, 140
- Creosote, heavy, 51  
 receiver for, 42  
 light, 51  
 distillation of by fire, 102  
 of fractions from by fire, 102  
 receiver for, 42
- Creosote oil, 139  
 for benzol recovery process, 140  
 for lighting purposes, 140  
 for manufacture of greases, 140  
 for sheep dips, 140  
 for timber preservation, 140, 141
- Creosote oil for fuel, 140  
 calorific value of, 140  
 determination of specific gravity, 152  
 of coefficient of expansion of, 158  
 of flash point of, 157  
 of "free carbon" in, 157  
 of naphthalene in, 154, 155  
 of phenols in, 152, 153  
 (Mann's method), 154  
 of pyridine bases in, 157  
 of water in, 152  
 dimethyl sulphate test, 157

- Creosote oil—  
 distilling range, 155, 156  
 for brick industry, 140  
 naphthalene in, determination of, 154, 155  
 requirements of various specifications, 114  
 specific gravity of, 51, 52  
 storage of, 141  
 tar acids in, extraction of, 81  
 variation of properties of, 139
- Cresylate (phenolate), springing of, 84, 85, 86  
 pump for, 62  
 tanks or boilers, 60, 61
- Cresylic acid, 79  
 air blowing of distilled, 88, 89  
 CO<sub>2</sub> process for recovery of, 59, 85, 86  
 distillation of crude, 87  
 distillation test of, 163  
 meta-cresol test, 164-165  
 receivers, 66, 78  
 still for, 76  
 sulphuric acid process for recovery of, 59, 82, 84  
 test for naphthalene and neutral oil in, 163  
 test for sulphur compounds, 164  
 test for sulphuretted hydrogen in, 164  
 test for tar acids in, 163  
 test for water in, 163  
 testing for specific gravity, 163  
 tests, 163
- Cresylite tests, 164  
 test, short, 165  
 long, 165
- Crown plates of still bottoms, 16, 17
- Crude anthracene, 134  
 drying of, 135  
 plant for the manufacture of, 126  
 pressing of, 135  
 washing of, 135
- Crude benzol, 101-104  
 fractionation of washed, 107, 108  
 rectification of, 107, 108  
 washing of, 102-104
- Crude heavy solvent, washing of, 102, 106
- Crude naphtha, 49  
 distillation by steam, 100  
 by fire, 99  
 receiver for, 42  
 specific gravity of, 50  
 valuation test for, 160
- Crude pyridine bases, 123  
 drying of, 122, 123  
 recovery of, from pyridine water, 122, 123  
 rectifying dried, 123-125
- Crude solvent naphtha, 100-102  
 fractionation of washed, 108, 109  
 rectification of, 108, 109  
 removal of tar acids from, 102  
 washing of, 102, 104, 105
- Crystallizing point of carbolic acid, 85  
 determination of, 166
- Curtain arch, 28
- "Cut" points, 50, 51, 52, 53  
 method used by stillmen to determine, 53
- Dehydration of coal tar, 56, 57
- Dephlegmators for rectifying stills, 96, 97
- Dipping tap for tar still, 20, 22  
 for preheater, 33, 34  
 cock for preheater, 33, 34  
 for tar still, 20, 22  
 rod, 23
- Discharge pipe of preheater, 33, 34
- Discharging of pitch, 54, 55
- Distillates, methods of running to receivers, 41
- Distillation of coal tar, 48-58  
 ammonia water stage in, 49  
 anthracene oil or "green" oil stage in, 52  
 carbolic oil stage in, 51  
 creosote oil stage in, 51  
 crude naphtha stage in, 49  
 light oil stage in, 50  
 of benzol, 107-108, 110  
 of cresylic acid, 87  
 of crude naphtha by fire, 99  
 by steam, 99, 100  
 of light oil by fire, 100  
 creosote by fire, 102  
 fractions by fire, 102  
 fractions by fire, 101  
 by steam, 101  
 of naphtha, 108, 109
- Distilling range of creosote oil, determination of, 155, 156
- Divider tanks: carbolic or cresylic plant, 65, 66
- Dividing box: tar distilling plant, 38  
 benzol and naphtha plant, 98  
 cresylic distilling plant, 76
- Drain cock for condenser tank, 36
- Drying tank for pyridine, 116
- Dust separator, 70, 71  
 separating from CO<sub>2</sub> furnace gases, 69-71
- Egg, carbolic acid, 67, 68  
 caustic soda, 116, 117  
 pyridine acid, 114, 117
- Ejectors for foul gas main, 39, 40  
 corrosion of cones of, 40
- Emptying of tank wagons, 4  
 of keels and lighters, 5
- Estimation of caustic soda in caustic liquor, 170
- Evaporator for caustic soda, 74, 75
- Examination of caustic liquors, 169  
 of coke, 170  
 of creosote, 151  
 of lime mud, 169  
 of spent liquors, 169  
 of tar, 143
- Expansion, coefficient of, of creosote, 158
- Factory and Workshop Act regulations, 171

- Filtering "salted out" oil, crude anthracene recovery process, 134-135
- Filter-press, 130  
 tank for causticizing plant, 74
- Finishing tank (carbolic or cresylic plant), 67
- Finishing the "springing" of tar acids, CO<sub>2</sub> process, 86
- Fire-bars, 27  
 bricks, 26  
 clay, 26  
 door of tar still, 27  
 places, construction of, 27
- Firing, coal *v.* gas, 31-32
- Flash point of creosote, determination of, 157  
 of naphthas, determination of, 161
- Flue, single wheel, 29  
 construction of, 25, 26, 28, 29, 30  
 double wheel, 28
- Flues of tar still, 25, 26, 28, 29, 30
- Foul gases 39, 40, 41  
 gas main, 39  
 ejectors for, 39, 40  
 seal pot for, 40  
 gases, methods of dealing with, 39-41  
 Craven and Colman's method of dealing with, 41  
 oxide purifier for dealing with, 41
- Foundations, concrete, 6, 25  
 settling of, 25  
 of tar stills, 25
- Fractionating column for cresylic still, 76, 77  
 for blow over stills, 92, 93  
 for rectifying stills, 94, 95, 96  
 columns, 92, 94, 95, 96, 118  
 stills, 94  
 towers, 92, 94, 95, 96, 118
- Fractionation of crude cresylic, 87  
 of washed crude benzol 107, 108  
 of washed crude solvent, 108, 109
- Fractions collected when tar is distilled, 48-53
- Free carbon in creosote, determination of, 157  
 in pitch, determination of, 150  
 in tar, 2  
 determination of, 146
- Fuel, economy of, 25, 35
- Fuel oil, 140  
 calorific value of, 140
- Furnace for making CO<sub>2</sub>, 68, 69, 70  
 manipulation of, 86
- Furnace gases; CO<sub>2</sub> process, 86
- Gases from coke furnace, 86  
 per cent. of CO<sub>2</sub> in, 86  
 testing of, 170
- Gas firing, 30-32  
 burners for, 30-32  
 main, 39  
 foul, 39, 40, 41  
 sewer, 31  
*v.* coal for firing tar stills, 31, 32
- Gassing, use of oxygen in cases of, 173, 175
- Getting pitch, 136, 137  
 protection of workmen, 137  
 tools for, 137
- Gland cocks, 42
- Greases, lubricating, 140  
 creosote for manufacture of, 140  
 formulae for, 140
- Grinding machinery, for crude anthracene recovery plant, 130
- Gurney jet, 64, 65, 73
- Gutter, pitch, 44, 45  
 construction of, 44, 45  
 gates for, 44, 46
- Heavy bases, 121, 124, 125
- Heavy creosote, 51  
 receiver, 42  
 specific gravity of, 52
- Heavy naphtha, preparation of, 109  
 crude, 102, 106  
 crude, method of washing, 106  
 solvent naphtha, 109
- Heavy oils, 51, 52
- Hennebique system of making reinforced concrete, 6
- High heat tar, 1, 2
- Home Office, regulations for tar distilleries, 171-173
- Horizontal retort tar, specific gravity of, 1  
 high heat specific gravity of, 1  
 low heat specific gravity of, 1
- Hydraulic presses, 127-130  
 steam heated, 130
- Hydrocarbons, estimation of, in benzol, 160
- Inspection chamber, 38, 39
- Interchange process in recovery of tar acids, 82, 83, 85
- Iron, wrought, for stills, 10, 12, 13-16  
 cast, for stills, 10  
 carbon in, 14
- Lagging of steam valves, 43  
 of tar still domes, 16, 23
- Light creosote, 51  
 distillation of, 102  
 of fractions from, 102  
 receiver, 42  
 specific gravity, 51
- Light oil, 50, 81, 100  
 distillation of, by fire, 100  
 distillation of fractions from, by steam or fire, 101  
 estimation of tar acids in, 163  
 of pyridine bases in, 163  
 receiver, 42  
 specific gravity of, 51  
 still, 91  
 valuation of, 162
- Lime, 80
- Lime mud, examination of, 169  
 putty, 48  
 slurry, 80, 81, 121  
 filter, 71, 116, 117
- Low heat tar, 1, 2



- Machine, centrifugal, 129  
 grinding, 130
- Mains to distillate receivers, 41, 42
- Manhole lids, 23, 24, 33  
 lid stool, 23
- Manholes, 23, 24, 33
- Measuring tar in storage tanks, 8
- Mechanical agitators, 59, 60, 90
- Meta-cresol, long test of, 165  
 short test of, 165
- Metals used in construction of condenser coils, 36, 118
- Metals used in construction of tar stills, 10-16
- Middle oil, 51
- Mid feathers, 29, 30
- Midland tar, 2, 3
- Mild steel for tar stills, 10, 12, 13-15
- Monier system of reinforced concrete, 6
- Naphtha, 109, 110  
 crude, 49  
 distillation by fire, 99  
 by steam, 100  
 determination of flash point, 161  
 distillation of, 108-109  
 distillation test of, 161  
 estimation of pyridine in, 149, 161  
 of tar acids in, 161  
 estimation of specific gravity, 161  
 heavy, 109  
 plant for recovery of, 90-98  
 preparation of 90 per cent. at 160° C.  
 solvent, 109  
 of 75°F. flash solvent, 109  
 of 85°F. flash solvent, 109  
 recovery of, 99-106  
 rectification of, 108-109  
 stills, 91-94  
 testing of, 161  
 valuation of crude, 160  
 washers, 90-91
- Naphthalene, 2, 132  
 drained, 133  
 plant for recovery of crude, 126-128  
 pressed, 133, 134  
 recrystallizing crude, 132  
 "salts," 50, 51, 132  
 test for, in creosote, 154, 155  
 in cresylic acid, 163  
 "whizzed," 133
- Neutral oils, determination of, in cresylic acid, 163
- Nitrogen in tar, 2
- Northern tar, 2, 3
- Oil, anthracene, 52  
 distillation of, 134  
 salting out, 135  
 creosote, 139  
 fuel, 140  
 Wells', 53, 140
- Oils, salting out, 132-134
- Olefines, 2
- Overflow cock, 22  
 pipe of preheater, 33
- Oxide purifier for dealing with foul gases, 41
- Oxygen, use of, in cases of gassing, 173, 175
- Paraffin bodies in coal tar, 2
- Pet cocks on tar storage tanks, 8
- Phenolate, sodium, 79  
 springing of, 82, 84-86
- Phenols, recovery of, 79-89
- Pitch, 53-55, 136-138  
 bay for coal tar pitch, 45, 46  
 construction of, 45, 46  
 for cresylic pitch, 77  
 preparation of, 55  
 cancer, 138  
 cock on tar stills, 24  
 cooler, French weir, 44, 45  
 coolers, 44, 45  
 coolers, construction of, 44  
 cooling, 54, 55, 136  
 depth to run to in bay, 55, 136  
 determination of specific gravity of, 150  
 of ash in, 15  
 of "free carbon" in, 150  
 of twisting point of, 136, 150  
 of volatile matter in, 151  
 discharging of, 55  
 getters, protection of, 137  
 getting, 136, 137  
 getting tools, 137  
 gutter, 44, 45  
 construction of, 44, 45  
 gates for outlets, 44, 46  
 hard, 136  
 medium, 136  
 running off of, 53, 54, 55  
 soft, 136  
 tests, 150
- Pitch of rivet holes, 8, 13  
 of still dome, 15, 16
- Plant for the recovery of benzol, 90-98  
 of crude anthracene, 126-131  
 of crude carbolic, 59-78  
 of crude cresylic, 59-78  
 of crude naphthalene, 126-131  
 of naphtha, 90-98  
 of pyridine bases, 113-118  
 causticizing soda ash, 73, 74, 75  
 spent liquors, 73, 74, 75  
 tar distilling, 10-47
- Plates, channel, 17, 28  
 corrosion of still, 10, 15  
 crown, 16, 17  
 lamination defects of wrought iron, 12  
 protection of still, 28-30  
 sketch, 15, 17  
 steel, for still construction, 10, 12, 13-15  
 wrought iron, for still construction, 10, 12, 13-15
- Poisoning by carbon monoxide, symptoms of, 173-174  
 by sulphuretted hydrogen, symptoms of, 174

- Poisonous effects of varying percentages of CO and SH<sub>2</sub> in human beings, 174, 175
- Preheater, 33, 34  
 advantage of, 35  
 charge pipe, 33  
 charging of, 48  
 coil, 34, 35  
   corrosion of, 36  
 construction of, 33, 34  
 dipping tap or cock, 33, 34  
 discharge pipe, 33, 34  
 inlet and outlet fittings for coil for, 33, 34, 35  
 manhole and lid, 33, 34  
 overflow pipe, 33, 34  
 swan neck, 33
- Prepared tar, 56, 57, 58
- Preserving timber, creosote for, 140, 141
- Presses, filter, 130  
 hydraulic, 127-130
- Pressing rough or crude anthracene, 135  
 crude naphthalene, 133
- Producer gas, 30, 31  
 sewer, 31
- Pump for carbolate or cresylate: CO<sub>2</sub>  
 process, 62  
 for causticizing plant, 74
- Pumps emergency, 46, 47  
 for tar, 9
- Purifiers, oxide, 41
- Purifying gases from CO<sub>2</sub> furnace, 72  
 tower, 72
- Pyridine, 2, 102, 119-125  
 acid, 103, 105, 119  
   dilution of, 119  
   egg, 114  
   neutralized, distillation of, 120-121  
   neutralizing, 120  
   plant for working up of, 113-118  
   still for neutralized, 114, 115  
   tanks, 113, 114
- bases, 2, 102, 119-125  
 drying of crude, 122, 123  
 drying tank for, 116  
 estimation of, in naphtha, 149, 161  
 heavy, 121, 124, 125  
 in benzol, 159  
 in creosote, 157  
 rectification of, 123-125  
 rectifying still for, 118  
   still, cleaning of, 125
- bottoms, storage tank for, 118  
 refractionation of, 124-125
- cadmium chloride test, 148  
 determination of water in, 148  
 distillation test of, 148  
 distillation test of crude, 149
- German Federal Council specification, 148
- limit of colour in commercial, 148  
 preparation of 90 per cent. at 140°C., 124
- recovery, 119-125  
 plant, condenser coil and tank for, 115, 116
- Pyridine—  
 solubility of, in water, 148  
 test for ammonia in, 148  
 test for oil in crude, 149  
 tests, 148  
 titration test, 148  
 valuation test of crude, 149  
 water, 122-123  
   receivers, 116  
   recovery of crude bases from, 122, 123  
     of crude bases from, by soda ash, 123
- Railway tank wagons for tar carriage, 4
- Reaction towers, packed and plate types, 62-65
- Receivers for ammoniacal liquor, 42  
 for anthracene oil, 42  
 for benzol, 98  
 for bottoms: cresylic plant, 76  
 for carbolic acid, 66, 78  
 for coal tar distillates, 42, 43  
 for cresylic acid, 66, 78  
 for crude naphtha, 42  
 for heavy creosote, 42  
 for light creosote, 42  
 for light oil, 42  
 for naphtha, 98  
 for overflow tar, 42  
 for pyridine water, 116  
 for spent liquors, 66  
 for tar acids, 66, 78  
 mains to, 41, 42  
 pipe lines to, 41, 42  
 steam coils for, 42
- Receiving box, 37, 41  
 tanks, types of, 42, 43
- Recovery of benzols, 99-106  
 of naphthas, 99-106  
 of pyridine bases, 119-125  
   from pyridine water, 122, 123  
 of tar acids, 79-89
- Rectification of benzols and naphthas, 107-112  
 of crude benzol, 107-108  
 of crude dried pyridine, 123-125
- Rectification stills, 97
- Reinforced concrete, Hennebique system, 6  
 Monier system, 6  
 tanks, 6, 7
- Ring, annular; or tar still seat, 27-28
- Rivet holes, making of, in plates for tar stills, 13
- Riveting still plates, 13  
 storage tank plates, 7, 8
- Road Board, specifications for road treatment, 57, 58
- Roofing felt, tar for preparation of, 58
- Running off tar stills, 53, 54  
 pitch, 53-55
- Run off cocks, 24
- Safety contrivance, S pipe, 19  
 valves for tar stills, 18, 19  
 examination of, 53

- Salted out oil, filtering of, 134  
 Salting out oils, 135  
   tanks for (anthracene and naphthalene plant), 126  
 Seal pot on foul gas main, 40  
 Separation of ammoniacal liquor from crude naphtha, 49  
   of dust from CO<sub>2</sub> furnace gases, 69-71  
   of water from CO<sub>2</sub> furnace gases, 73  
   from crude naphtha, 49  
   from tar, 48  
 Separator, dust, 70, 71  
   water, in CO<sub>2</sub> carbolic and cresylic process, 73  
 Sewer, for producer gas, 31  
 Sheep dip, creosote for, 140  
 Sketch plates, 15, 17  
 Soda-ash, causticizing of, 79, 80  
 Solubility of carbolic acid, examination for, 166  
   of pyridine, examination for, 168  
 Solvent naphtha, 109  
   heavy, 109  
   90 per cent. at 160°C., 109  
   90 per cent. at 165°C., 109  
   60 per cent. at 190°C., 109  
   75°F. flash, 109  
   85°F. flash, 109  
   manufacture of, 108-110  
 Specific gravity of anthracene oil, 52  
   of benzol, determination of, 158  
   of carbolic oil, 51  
   of chamber retort tar, 1  
   of creosote, determination of, 152  
   of cresylic acid, determination of, 163  
   of crude naphtha, 50  
   of heavy creosote, 52  
   of high heat tar, 1  
   of light creosote, 51  
   of light oil, 51  
   of low heat tar, 1  
   of naphtha, determination of, 161  
   of pitch, determination of, 150  
   of tar, 1  
   determination of, 144, 145  
   of vertical retort tar, 1  
 Specifications for creosote, 141  
   for pyridine, 148, 149  
 Spent liquor receivers, 66  
   causticizing, 81  
 Spent liquors, examination of, 169  
 Springing tanks, 60  
 Steam coils in storage tanks, 8  
   in tar stills, arrangement of, 20-22  
   for condenser tanks, 37  
 Steam distillation, 52, 99-102, 107-112, 120  
 Steam, introduction of, into tar stills, 52  
 Steel, mild, for tar stills, 10, 12, 13-15  
 Steel plates for stills, shaping of, 12-13  
 Still, tar, 10-24  
   ashpit for, 27  
   bottom, 13, 16, 17  
   charge inlet for, 24  
   charging, 49  
   cleaning, 55, 56  
   Still, tar, construction of, 10-24  
   corrosion of, 10, 15  
   design of, 10-18  
   dipping tap for, 20, 22  
   discharging or running off, 53, 54, 55  
   dome, 15, 16  
   double wheel flue for, 28  
   fireplace for, 27  
   flues for, 25, 26, 28-30  
   foundations for, 25  
   foundations, settling of, 25  
   gas *v.* coal for firing, 31-32  
   lagging of dome of, 16, 23  
   manhole and lid for, 23, 24  
   plates for, 10, 12, 13-15  
   protection of bottom of, 28-30  
   of channel plates of, 28-30  
   of shell of, 29, 30  
   run off pipe for, 24  
   safety valve for, 18, 19  
   shell, 15  
   single wheel flue for, 29  
   sizes of, 14  
   steam coils for, 20, 21  
   steam inlet for, 20-21  
   swan neck for, 19  
   swan neck stool for, 19  
   tar, gas burners for firing, 30-32  
   working of, 48-53  
   Still for anthracene oil, 128  
   for cresylic acid, 76  
   for light oil, 91  
   for neutralized pyridine acid, 114, 115  
   for rectifying pyridine bases, 118  
   cleaning of, 125  
   tank for charging cresylic into, 75  
 Stills, blow-over steam heated, 91, 92  
   fire heated, 91-92  
   for crude naphtha, 91-92  
   for light oil, 91-92  
   for redistilled light oil, 91-92  
 Stool for man lid, 23  
   for safety valve, 19  
   for swan neck, 19  
 Storage tank for pyridine bottoms, 118  
 Storage tanks, construction of, 5, 6, 7, 8  
   benzol and naphtha plant, 98  
   brick, 6  
   for carbolic and cresylic acids, 68  
   for creosote, 141  
   for tar, 5-8  
   foundations for, 5  
   reinforced concrete, 6  
   site for, 5  
   wrought iron, 7  
 Sulphuretted hydrogen in cresylic acid, 88  
 Sulphur, determination of, in tar, 146  
   in benzol, 159  
   compounds, determination of, in cresylic, 164  
 Sulphuric acid process of recovering tar acids from phenolates, 59, 82, 84  
 Sump for pump suction end; CO<sub>2</sub> tar acid recovery plant, 62  
 Swan neck of preheater, 33  
   of tar still, 19

- Tail pipe of cresylic still, 76  
of tar still, 24
- Tank, finishing (carbolic and cresylic plant), 67
- Tank for charging cresylic still, 75
- Tanks, causticizing, 73
- divider (cresylic and carbolic plant), 65, 66
- for air blowing, 67, 68, 78
- for caustic soda, 74, 116
- for condenser coils, 36, 76, 97, 98, 115, 116, 118
- for cresylate and carbolate, 60, 61
- for drying pyridine, 116
- for lime slurry, 71, 116, 117
- for pyridine acid, 113, 114
- for recrystallizing (naphthalene recovery process), 127
- for salting out (naphthalene recovery process), 126
- (anthracene recovery process), 129
- for springing, 60
- for washing, 59, 60, 90, 91
- reinforced concrete, 6
- wrought iron, 7
- storage, for benzol and naphtha plant, 98
- for coal tar, 5, 6, 7, 8
- for creosote, 141
- for tar acids, 68
- Tank wagons, 4
- emptying of, 4
- tip for, 4
- Tap, dipping, for tar still, 22
- Tar acids, 79
- CO<sub>2</sub> process for recovery of, from phenolate, 59, 85, 86
- in creosote, determination of, 152-153
- in crude naphtha, 99
- in light oil, determination of, 163
- in naphtha, determination of, 161
- in phenolate, determination of, 167
- receivers for, 66, 78
- storage tanks for, 68
- sulphuric acid process for recovery of, from phenolate, 59, 82, 84
- washers used in recovery of, 59, 60
- Tar, its composition, 1, 2
- effect of nature of raw material on chemical composition of, 2
- of nature of raw material on physical properties of, 1
- of temperature of carbonization on composition of, 2
- of temperature of carbonization on physical properties of, 1
- carts, 5
- chamber retort, specific gravity of, 1
- dehydrated, 56, 57
- determination of water in, 143
- of ash in, 147
- of free carbon in; Hooper's method, 146
- of free carbon in; Warnes's method, 146
- of free carbon in; Church's apparatus, 146, 147
- of specific gravity of, 144
- Tar, determination of specific gravity of, Church's method, 144
- of specific gravity of, Lunge's method, 145
- of sulphur in, 146
- distillation of, 48-53
- ammonia water stage in, 49
- anthracene oil stage in, 52
- crude naphtha stage in, 49
- heavy creosote stage in, 51
- introduction of steam during, 52
- light creosote stage in, 51
- light oil stage in, 50
- middle oil or carbolic oil stage in, 51
- distilling; Factory and Workshop Act regulations, 171-173
- emptying keels and lighters of, 5
- examination of, 143
- for road treatment, 57, 58
- for roofing felt, 58
- from cannel coal, 2
- from shaley coal, 2
- horizontal retort, high heat, specific gravity of, 1
- low heat, specific gravity of, 1
- how delivered to distillery, 4
- measuring of, in storage tanks, 8
- Midland, 2, 3
- Northern, 2, 3
- prepared, 56, 57, 58
- pumps, 9
- railway tank wagons, 4
- specific gravity of, 1
- stills, 10-24
- cast iron, 10
- cleaning of, 55, 56
- construction of, 10-24
- corrosion of, 10, 15
- metals used in construction of, 10-16
- wrought iron and mild steel, 10, 12, 13-16
- testing for yield of products, 147
- tips for railway tank wagons, 4
- for carts, 5
- vertical retort, specific gravity of, 1
- wells or storage tanks, 5, 6, 7, 8
- brick, 6
- coils for, 8
- foundations for, 5
- iron, 7
- reinforced concrete, 6
- sites for, 5
- Yorkshire, 2, 3
- Tar still, annular ring or seat for, 27, 28
- bottom of, 16-18
- burners for gas firing, 30-32
- charging of, 49
- dipping cock for, 22
- discharging pitch from, 53, 54, 55
- dome of, 15, 16
- double wheel flue for, 28
- flues, construction of, 25, 26, 28, 29, 30
- foundations for, 25
- foundations, settling of, 25
- high pitched dome, faults of, 16
- manhole and lid for, 23, 24
- "priming" of, during working, 49

- Tar still, run-off pipe for, 24  
 safety valve for, 18-19  
 shell of, 15  
 single wheel flue for, 62  
 steam coils for, 20-22  
   arrangement in, 20-22  
 swan neck of, 19  
 tail pipe for, 24  
 thermometer for, 24  
 stills, gas firing of, 30-32  
   making rivet holes in plates for, 13  
   shaping of plates for, 12, 13  
   various sizes of, 14
- Testing coal tar, 143
- Thermometer for tar still, 24
- Thickness of plates used for still construction, 13
- Timber, creosote for the preservation of, 140, 141
- Tip, tar, for railway tank wagons, 4  
 for carts, 5
- Toluene, preparation of commercially pure, 110-111
- Toluol, preparation of 90 per cent. at 120°C., 110
- Tower, carbonating, 62, 63, 64, 65  
 packed type, 63-65  
 plate type, 62, 63  
 fractionating, 92, 94, 95, 96, 118  
 purifying, 72  
 reaction, 62, 63, 64, 65  
 packed type, 62, 64, 65  
 plate type, 62, 63  
 washing, 72
- Treatment of roads: Roads Board specifications, 57
- Twisting point of pitch, determination of, 150
- Valuation of crude naphtha, 160  
 of crude pyridine, 149  
 of light oil, 162
- Valve, safety, 18, 19
- Valves, steam, lagging of, 43  
 bronze, 43  
 cast steel, 43  
 cast iron, 43  
 gate, 114, 115
- Vertical retorts, tar from, 1, 2
- Volatile matter in pitch, determination of, 151
- Washing, benzol, 102, 103, 104  
 crude naphtha, 99  
 heavy solvent, 106  
 solvent, 104-106  
 tanks for removing tar acids from oils, 59, 60  
 tanks for washing crude anthracene, 130
- Washing out tar acids from oils, 81-84  
 light creosote fractions for tar acids, 81  
 light oil fractions for tar acids, 81
- Washing tanks, benzol and naphtha plant, 90-91
- Washing tower, for washing gases from CO<sub>2</sub> furnace, 72
- Water, ammoniacal, separating from tar, 48  
 determination of, in crude pyridine, 149  
 in carbolic acid, 166  
 in creosote oil, 152  
 in cresylic acid, 163  
 in pyridine bases, 148  
 in tar, 143  
 separating from CO<sub>2</sub> furnace gases, 73  
 separation of, from crude naphtha, 49  
 from crude pyridine bases, 122-123  
 from crude pyridine bases by soda ash, 123  
 separator (carbolic and cresylic CO<sub>2</sub> process), 73
- Water box, 38, 39
- Well, tar, construction of, 5, 6, 7, 8  
 foundations for, 5  
 site for, 5
- Wells' oil, 53, 140
- Wheel flue, single, for tar still, 29  
 double, for tar still, 28
- Working of tar stills, 48-53
- Worm end, 37
- Wrought iron for tar stills, 10, 12, 13-16
- Xylenes, preparation of commercially pure, 111-112
- Yields of various distillates from tar, 3  
 Yorkshire tar, 2, 3



# LEEDS & BRADFORD BOILER CO., Ltd. STANNINGLEY.

Contractors to the War Office, the India Office, the Admiralty, the Crown Agents for the Colonies, &c.

## COMPLETE TAR DISTILLING PLANTS



## HIGH-CLASS TAR STILLS

Tops and Bottoms pressed to shape by Special Hydraulic Machinery; Rivet Holes drilled in position, and all rivetting where practicable done by Hydraulic Machinery, which together ensure the highest possible class of Tar Still made.

### NEW STILL BOTTOMS.

BENZOL STILLS, WASHERS, AIR RECEIVERS, CONDENSING TANKS, SEPARATORS, DISTILLATE TANKS, STORAGE TANKS, PANS, WROUGHT AND CAST PIPING, COILS, &c.

Enquiries solicited for all kinds of Rivetted Steel Plate Work.

Telegrams: "BOILERS, STANNINGLEY."

Code: ABC 5th Edition.

# CARL STILL RECKLINGHAUSEN

Designer and Erector

or

Complete Coke Oven Installations,

Condensing, Benzol, Lighting Gas  
and Ammonia Plants, etc.

## TAR DISTILLATION PLANTS.

Over 20 Tar Distillation Plants  
with more than 60 Stills at work.

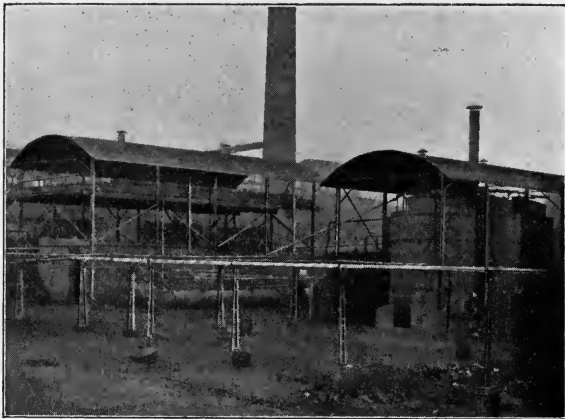

Tar Distillation Plant at "Centrum" Colliery,  
near Bochum, Westphalia.

Representatives:

**BAGLEY, MILLS & CO., Ltd.**  
92, Victoria Street, Westminster, London, S.W.



# **R. & J. DEMPSTER, Ltd.**

One of the oldest  
Manufacturers in  
England for all  
—— types of ——

**BY-PRODUCT,**  
**TAR & BENZOL PLANTS,**  
**SULPHATE APPARATUS,**  
**DE-HYDRATING PLANTS,**

**&c.**

A scientific and experienced Staff is employed to design and construct Plant for Research work.

## **R. & J. DEMPSTER, Ltd.**

GAS PLANT WORKS,

### **MANCHESTER**

# Books for Gas Managers and Students

---

## **THE DISTRIBUTION OF GAS**

Third Edition, Revised and Enlarged by WALTER HOLE

Demy 8vo. With illustrations. Price 15s. net.

## **THE CARBONIZATION OF COAL**

By Prof. VIVIAN B. LEWES, F.C.I., F.C.S., Etc.

Demy 8vo. With illustrations. Price 7s. 6d. net.

## **ESTIMATES AND VALUATIONS: A Handbook of Data and Prices for Gas Engineers**

By JESSE F. SCOTT, Assoc.M.Inst.C.E.

Demy 8vo. With Tables. Price 10s. 6d. net.

## **DISTRIBUTION BY STEEL**

By HENRY WOODALL and B. R. PARKINSON

Contains full instructions for Mainlaying with Steel Tubes. Tables of Quantities, Pressures, etc., for reference. A Chapter on Main Testing for Leakage. Notes on Corrosion. High-pressure Distribution, etc. Price 6s. net.

## **THE CONSTRUCTION AND MANAGEMENT OF SMALL GASWORKS**

By NORTON H. HUMPHRYS, Assoc.M. Inst.C.E., F.C.S.

With a section on Costs and Capacity of Works, by J. H. BREARLY. Crown 8vo. With Illustrations. Price 7s. 6d. net.

## **MODERN RETORT SETTINGS: Their Construction and Working**

By T. BROOKE

Demy 8vo. With illustrations. Price 7s. 6d. net.

## **THE MANUFACTURE OF SULPHATE OF AMMONIA**

By GASCOIGNE T. CALVERT

Demy 8vo. With about 100 Illustrations. Price 7s. 6d. net.

## **SELF-INSTRUCTION FOR STUDENTS IN GAS ENGINEERING**

By "MENTOR"

With Numerous Illustrations. 2 vols., crown 8vo. Price 3s. 6d. net each.

The student is presented with a large amount of information, gathered in the field of practical work, much of which is not to be obtained in the ordinary text-books, and covers, to a considerable extent, the syllabus in Gas Engineering of the City and Guilds of London Institute.

**ELEMENTARY** (Ordinary Grade), 4th Edition.

**ADVANCED** (Honours Grade), 3rd Edition.

## **SELF-INSTRUCTION FOR STUDENTS IN GAS SUPPLY**

By "MENTOR"

With Numerous Illustrations. 2 vols., crown 8vo. Price 3s. 6d. net each.

The object of these little books is to assist students who are contemplating entering for the Examinations in the subject of Gas Supply.

**ELEMENTARY** (Ordinary Grade), 2nd Edition.

**ADVANCED** (Honours Grade).

---

JOHN ALLAN & Co., "The Gas World" Offices, 8 Bouverie Street, London, E.C.

# THE CARBONIZATION OF COAL.

## A Scientific Review of the Formation, Composition and Destructive Distillation of Coal for Gas, Coke and By-Products.

By VIVIAN BYAM LEWES, F.I.C., F.C.S., ETC.

Professor of Chemistry, Royal Naval College, Greenwich, Chief Superintending Gas Examiner to the Corporation of the City of London, Vice-President of the Institution of Naval Architects, etc., etc.

Demy 8vo. 360 pages. With 30 Illustrations. Price 7s. 6d. net.

"The Times" says:—"Will be hailed with satisfaction by all those who are interested in carbonizing work and who desire to possess the most recent information on this important subject."

"The Colliery Guardian" says:—"There was a need for this book. . . . In his treatment of the subject of modern methods of carbonization, Professor Lewes is as successful as when dealing with the abstract question of the composition of coal."

"The Chemical Trade Journal" says:—"This book satisfies a long-felt want. . . . The ten chapters deal systematically with the subject. . . . Other chapters go well into the subject of classification and distribution of coal, various forms of retorts used in gas manufacture (which are illustrated by good plates), coke ovens and their developments. . . . There is also very good descriptive matter regarding the conditions existing in the destructive distillation of coal, manufacture of coke, and the utilization of residuals for the manufacture of ammonium sulphate and other products."

"The Journal of Gas Lighting" says:—"It will be readily admitted that there is no one more competent than the author to deal with the subject."

# THE MANUFACTURE OF SULPHATE OF AMMONIA.

By GASCOIGNE T. CALVERT.

(Late Works Manager of the Nchells Chemical Works, Birmingham.)

Demy 8vo. With about 100 Illustrations. Price 7s. 6d. net.

A book for the use of practical men. Contains full working details as to the Manufacture of Sulphate of Ammonia. Designed to meet the requirements of large or small makers of Sulphate.

### SYNOPSIS OF CHAPTERS.

Sulphate of Ammonia: Its Composition and Analysis.

The Raw Materials: Ammoniacal Liquor, Sulphuric Acid and Lime.

Plant required for the Manufacture of Sulphate of Ammonia:

General Description—Supply of Ammoniacal Liquor—Tachometer—Superheaters—Stills—Liming Apparatus—Waste Liquor Valves—Cooling Arrangements, etc.—Saturators—Drying, Storing, etc.—The Waste Gases, etc.

Starting, Working and Stopping the Plant.

Alkali, etc., Works Regulation Act, 1906.

Sulphate of Ammonia Manufacture for Small Gasworks.

"The Chemical Trade Journal" says:—"Much in advance of the ordinary text-book or treatise on technical chemistry. . . . The book deals concisely but adequately with the composition and analysis of sulphate, raw materials, the plant, and the control and working of a still."

"The Colliery Guardian" says:—"This book should be particularly welcome to colliery owners and managers. The author is well qualified to deal with this subject, and has done so in a clear and attractive style. . . . In the description of starting, working and stopping the plant, the author is particularly happy, and the practical information given in this chapter is of much value. . . . Mr. Calvert has given us a thorough, reliable work, which, in the scope he has taken, can be confidently recommended to those interested."

JOHN ALLEN & Co., "The Gas World" Offices, 8, Bouverie Street, London, E.C.

THE  
**GLOVER-WEST**  
system of  
Continuous Carbonization  
in  
**VERTICAL RETORTS**



**WEST'S GAS IMPROVEMENT COMPANY**  
LTD.

*Engineers*

**MILES PLATTING**  
**MANCHESTER**

**WINSTANLEY & CO.**



**MURDOCH WORKS**

KINGS NORTON

**GASWORKS CONTRACTORS**

Retort Houses equipped complete. Repairing  
of every Description. Retort Settings.  
Structural Work. Steel Roofs, etc.

*Enquiries for Estimates invited.*

# **BLAGDEN, WAUGH & Co.**

Coronation House  
4 Lloyd's Avenue, London, E.C.

Telegraphic Address: "PHENOLATE, FEN, LONDON."

Telephone No.: Avenue 1577 (3 lines).

---

## **BUYERS**

OF ALL

### **Tar, Ammonia & Benzole**

Products in large quantities  
Crude or Refined.

**CONTINUOUS DISTILLATION**  
OF  
**COAL TAR**

---

**Hird's Patent Process**

**LOW WORKING COST.**

**AUTOMATIC AND SIMPLE**  
to operate.

**Distillates and Pitch discharged**  
continuously and simultaneously  
after initial adjustment.

**No skilled supervision required.**

Particulars from the

SOLE MAKERS:

**W. C. HOLMES & Co., Ltd.**

**GAS AND CHEMICAL ENGINEERS.**

WORKS AND HEAD OFFICES:

**HUDDERSFIELD**

---

*Telegrams : Holmes, Huddersfield.*

*Telephone 1573.*

# Alder & Mackay

(ESTABLISHED 1850)

## Gas Meter Manufacturers and Gas Lighting Engineers

Patentees and Sole Makers of the  
"A. & M." **AUTOMATIC CONTROLLER**  
for Lighting and Extinguishing Street Lamps

*THE MOST SUCCESSFUL APPARATUS OF  
—THE KIND ON THE MARKET—*

LIST OF SOME OF THE TOWNS WHERE THEY HAVE BEEN ADOPTED  
AND FITTED

Newcastle-upon-Tyne.  
Darlington.  
Beverley.  
Tipton.  
Windsor.  
Ipswich.  
Swansea.  
Nuneaton.  
Market Harborough.  
Harpenden.  
Hinckley.  
Hereford.  
Stockport.  
Stoke-upon-Trent.  
Stretford.

Padiham.  
Oswaldtwistle.  
Brodsworth.  
Kippax.  
Broughty Ferry.  
North Berwick.  
Stonehaven.  
Bridge of Allan.  
Bonnyrigg.  
Tillicoultry.  
Cupar-Fife.  
Cowdenbeath.  
Kelty.  
Cardenden.  
Tayport.

Rutherglen.  
Peebles.  
Campbeltown.  
Belfast.  
Lurgan.  
Ballymena.  
Dunedin, N.Z.  
Invercargill, N.Z.  
Nelson, N.Z.  
Masterton, N.Z.  
Blenheim, N.Z.  
Hawera, N.Z.  
Hamilton, N.Z.  
Rueil, France.  
Etc., etc.

Automatic Lighting means higher efficiency, lower  
maintenance charges, and great economy

*Full Particulars on Application.*

### NEW GRANGE WORKS :

**STEWART TERRACE, EDINBURGH**

**Ventnor Street Works : BRADFORD**

London Office: 13 VICTORIA STREET, WESTMINSTER, S.W.  
Birmingham Office: CENTRAL HOUSE, NEW STREET.

Also at SYDNEY, N.S.W., and WELLINGTON, N.Z.



ESTABLISHED 1849.

Telegraphic Address :  
Cortin, Newcastle-on-Tyne.

Telephone :  
551 Central.

# J. CORTIN Ltd.

CHEMICAL PLANT  
MANUFACTURERS

**MUSHROOM BRASS WORKS**  
**ST. LAWRENCE ROAD,**  
**NEWCASTLE-ON-TYNE**

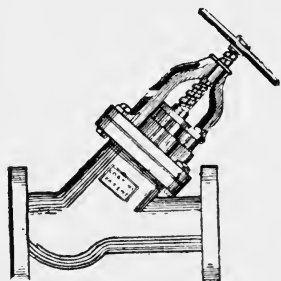

FULL BORE ACID VALVE.

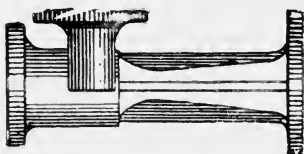

ACID ELEVATOR.

Sole Makers of

CORTIN'S ACID VALVES,  
PUMPS, ELEVATORS,  
TAPS, PLUGS AND SEATS,  
SILENT HEATERS, Etc.

**LEAD BURNING APPARATUS, Etc., for Chemical Manufacturers**

CHEMICAL LEAD BURNING A SPECIALITY

# NAPHTHALENE STOPPAGES



## THE USE OF “GAZINE”

*(Registered in England and Abroad)*

is the most effective and simple means of dissolving  
and preventing Naphthalene Deposits in  
Gas Mains and Services



MANUFACTURED AND SUPPLIED BY

### C. BOURNE

WEST MOOR CHEMICAL WORKS

**KILLINGWORTH**

**NEAR NEWCASTLE-ON-TYNE**

OR THROUGH HIS AGENTS

### F. J. NICOL & CO.

**PILGRIM HOUSE, NEWCASTLE-ON-TYNE.**

Telegrams { “Doric, Newcastle-on-Tyne.”  
“Bourne, Forest Hall.” } Nat. Telephone : 2497.

# DAVIS BROS.

Chemical Engineers,

LONDON . . . .  
265 Strand, W.C.

MANCHESTER  
66 Deansgate. .

DAVIS BROS. were among the first to adapt the Column Still to the recovery of Ammonia from Gas Works Liquor, and have been makers of Continuous Ammonia Stills and Sulphate Plants since 1885.

SPECIALITIES—

TAR DISTILLATION PLANT

SULPHATE OF AMMONIA PLANT

AMMONIA STILLS . . . . .

ANHYDROUS AMMONIA PLANT .

AMMONIA LIQUOR PLANT . . .

MURIATE OF AMMONIA PLANT

SULPHURIC ACID PLANT

ACID DEARSENICATION . . . .

. . . (with Waste Saturator Gases)

Telephones:

13692 Central London  
3060 Central Manchester

Telegrams:

“Trepex London”  
“Expert Manchester”

ESTABLISHED 1793.

Telegrams :  
"NEWTON, SHEFFIELD."

Telephone 2200  
(Two Lines).

# NEWTON, CHAMBERS

& Co., Ltd.,

**THORNCLIFFE IRONWORKS,  
near SHEFFIELD.**



**GASHOLDERS :**  
Standard Guided or Spiral.



**SCRUBBERS.**



**PURIFIERS.**

BRANCH OFFICES :

LONDON : Brook House,  
10-12, Walbrook, E.C.

MANCHESTER : Grosvenor Buildings,  
Deansgate.

LIVERPOOL : 50A, Lord Street, W.

SHEFFIELD : Moorhead.

# **THE CHEMICAL ENGINEERING CO.**

AND

# **WILTON'S PATENT FURNACE CO.**

**HENDON, LONDON, N.W.**

**ARE MAKERS, AND ERECT THE FOLLOWING:**

Complete Tar Distillation Plants with recovery of Refined Products.

Tar Stills and Fractionating Plants, Washing, etc., for the manufacture of Benzol, 90 %, 50-90 %, Toluol, Solvent Naphtha, Carbolic Acid, Naphthaline (pure), Anthracine, Pyridine, Wash Oil, Creosote, Wizzed Salts, Pitch, etc.

Tar Dehydration and Refining Plants for producing Thin Tar for Road Spraying.

Medium and Thick Tar for Grouting, Macadam, Road Metalling, etc.

Black Varnish.

Apparatus for the manufacture of Motor Spirit and Naphtha from the Light Oil produced in dehydrating tar.

Apparatus for the manufacture of Sulphate or other ammonia products from the liquor removed from the tar in dehydrating.

---

**WORKS AND OFFICES :**

**HENDON, LONDON, N.W.**

# SULPHATE OF AMMONIA SATURATORS

---

OVER 465 SATURATORS DELIVERED DURING THE LAST FEW YEARS

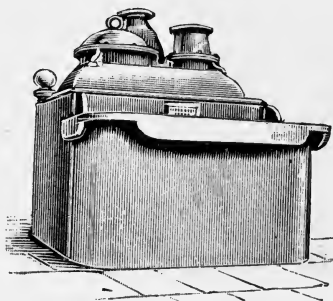

**JOSEPH TAYLOR & Co.,** Central Plumbing Works,  
**BOLTON.**

Telegraphic Address  
"SATURATORS, BOLTON."

Works Telephone No.  
848 BOLTON.

Residence  
119 BOLTON.

# FILTER PRESSES.

(Dehne's.) OLDEST AND LARGEST MAKERS IN THE WORLD.

NEARLY  
20,000  
SUPPLIED

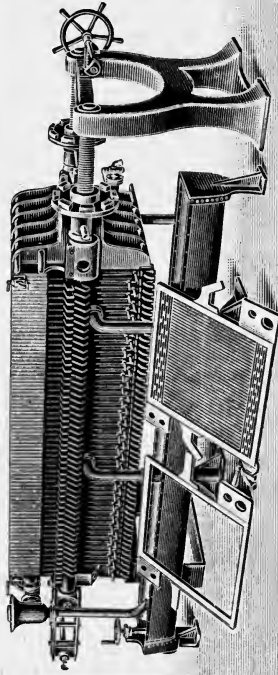

All communications from  
the United Kingdom and  
the Colonies to be addressed  
to our LONDON OFFICE.—

**C. HARZER & CO**  
FINSBURY PAVEMENT HOUSE  
FINSBURY PAVEMENT.  
LONDON, ENGLAND

# **SIMON-CARVES**

## **DIRECT RECOVERY PROCESS**

FOR

## **GASWORKS**

Simple in Design. Low Working Cost.  
No Noxious Effluent. Perfectly White Salt.

---

**Plants at Work and in Construction.**

---

**COKE OVENS FOR GASWORKS**

---

**Sulphuric Acid Plants**

WITH LATEST IMPROVEMENTS

---

**COAL WASHING PLANTS**

(BAUM SYSTEM)

---

**SIMON-CARVES Ltd., MANCHESTER**







TP953

W28

**304330**

*Warner*

UNIVERSITY OF CALIFORNIA LIBRARY

